

Tarasola®

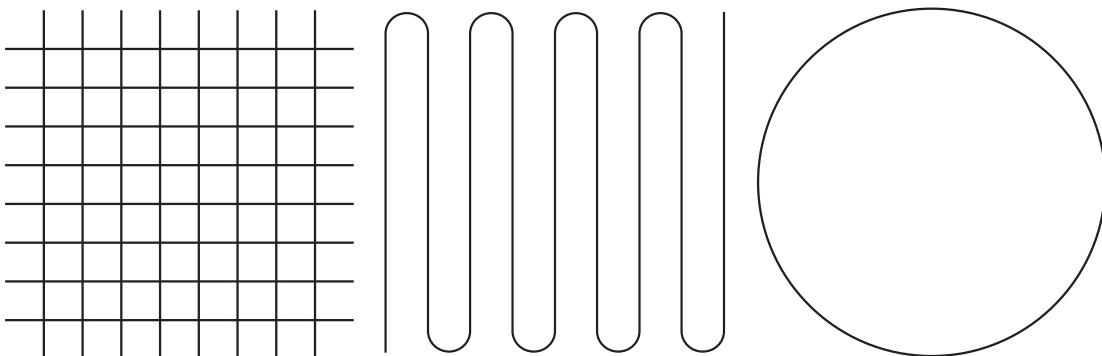

Tarasola Carport Tarasola Fix

DE EN







Inhaltsverzeichnis

Table of contents

- 02 **Produktbeschreibung** | Product description
- 04 **Bildergalerie** | Photo gallery
- 20 **Haupteigenschaften** | Key features
- 21 **Querschnitten** | Cross-sections
- 22 **Moduls und Maximale Abmessung** | Models and maximum dimensions
- 25 **JUICEBOX PRO AUTOLADESTATION**
| Car Charging Station Juicebox Pro
- 26 **Photovoltaikanlage** | Photovoltaic panels
- 28 **Seitliche Ausstattung** | Side development
- 29 **Zubehör** | Accessories
- 30 **Farbpalette** | Colour range
- 32 **Zertifikate** | Certificates
- 32 **Auszeichnungen** | Awards

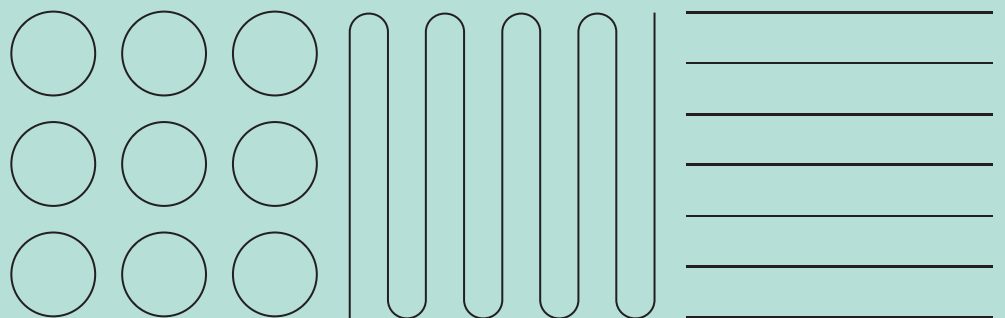

Produktbeschreibung

Product description

DE

Tarasola Carport ist ein modernes Garagenvordach. Es ist ein solides, festes Dach, das das Auto vor Witterung, also vor Sonne, Regen, Wind und Schnee schützt. Eine ästhetische Form ohne sichtbare Verbindungen und eine große Farbauswahl, die es Ihnen ermöglicht, Carport an jede Umgebung anzupassen.

Tarasola Carport = Tarasola Fix

Die Carport-Konstruktion kann erfolgreich als eine Terrassenüberdachung dienen. Dank dieser modernen Innovation können Sie die Terrassenüberdachung optional mit einem schönen Dachunterstoff und sogar mit einer LED-Streifen-Beleuchtung und einem Infrarot - Heizstrahler ausstatten.

Wenn Sie sich selbst, Ihre Gartenmöbel und weitere Ausstattung vor schlechten Witterungsbedingungen schützen möchten, lohnt es sich, Shutters, ZIP-SCREENS oder Verglasungen zu wählen. Sie erhalten einen funktionalen Raum zum Zeitverbringen zu jeder Tageszeit oder Jahreszeit.

EN

The Tarasola Carport is a modern parking space. It is a solid, fixed roofing that protects your car from the sun, rain, wind and snow. The minimalist form, aesthetically pleasing finish, with no visible fixings and a choice of colours allows the Carport to fit into any environment.

Tarasola Carport = Tarasola Fix

The carport structure can be successfully used as a standard terrace roofing. In this option, we recommend adding a lower roof in the form of an aesthetically pleasing fabric and equipping the structure with LED lighting and infrared heaters. If you want to cover yourself, your furniture and accessories, it is worth choosing side Shutters, ZIP blinds or glazing. You will gain a functional space to spend time at any time of the day or even year.

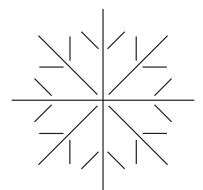
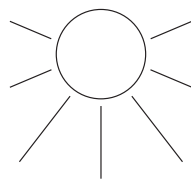
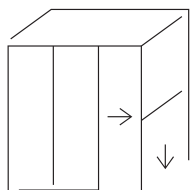

Carport mit Photovoltaikanlage

Carport with photovoltaic panels

Ein festes Dach bietet Ihnen die Möglichkeit, Photovoltaik-Module zu installieren und den daraus entstandenen Strom zum Betreiben von Haushaltsgeräten oder zum Aufladen eines Elektroautos zu nutzen.

The fixed roof will provide the opportunity for the installation of photovoltaic panels and the use of the resulting electricity to power household appliances or to charge an electric car.



Dach mit Photovoltaikanlage

Roof with photovoltaic panels



Dach ohne Photovoltaikanlage

Roof without photovoltaic panels

Unterer Stoff (Option)

Bottom roof - fabric (option)

Optional können Sie einen Unterstoff bestellen, der das von unten sichtbare Blech abdeckt. Die Unterseite des Daches besteht dann aus ästhetischem Stoff mit Balken, in denen LED-Strip Beleuchtung montiert werden kann.

As an additional option, a bottom roof can be ordered to cover the exposed roof sheet visible from below. The underside of the roof is then made of an aesthetically elegant fabric with beams in which LED Strip lights can be fitted.



Unterer Stoffdach

Bottom roof with the fabric



Dach ohne Stoff

Bottom roof without the fabric

Bildergalerie

Photo
gallery

Tarasola
Carport

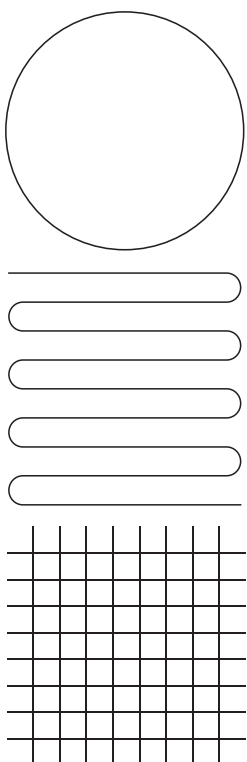





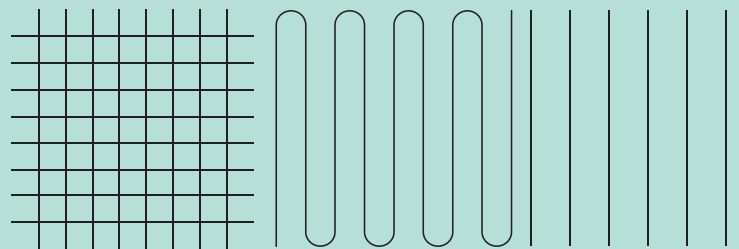
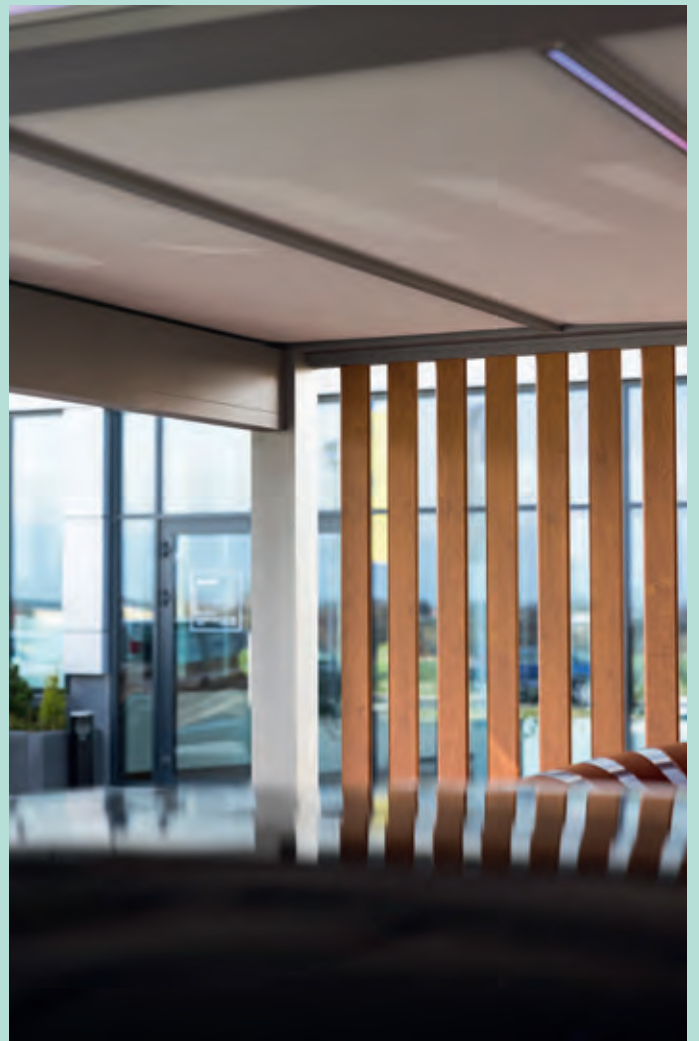











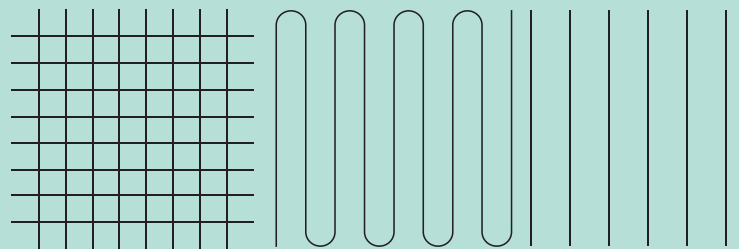



Tarasola Fix



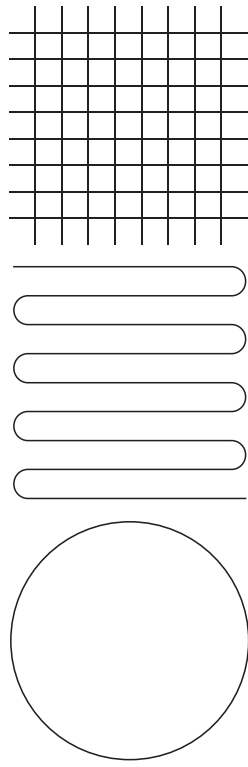







Haupteigenschaften

Key features



DE

Konstruktion aus pulverlackiertem extrudiertem **Aluminium**, Dach aus dem **Trapezblech**

Entwässerungssystem im Standard

Möglichkeit der Ausstattung des Carports mit der **Photovoltaikanlage** auf dem Dach

Modulare Anschlussmöglichkeit

Maximale Windlast **120 km/h**

Schneelast widerstandsfähig **72-300 kg/m²**

EN

Aluminum construction, **trapezoidal sheet metal** roof

Integrated, **water drainage system**

Possibility of mounting **photovoltaic panels** to the roof

Option of **modular** connection

Maximum wind resistance **120 km/h**

Resistance to snow load **72-300 kg/m²**

Querschnitten | Cross-sections

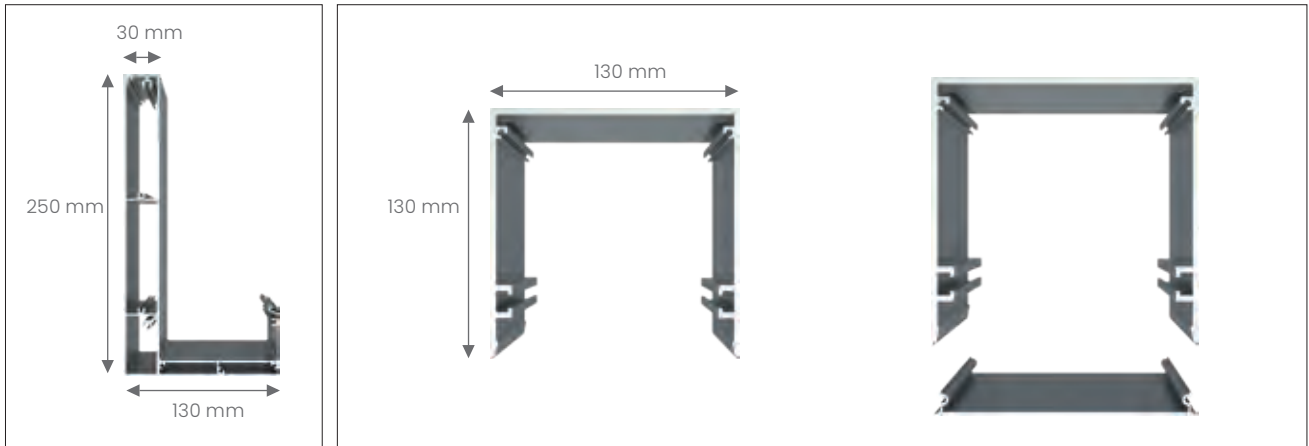

Durschnitt des Konstruktionsprofils

Construction profile

Pfosten mit Blindleiste

Openable supporting profile

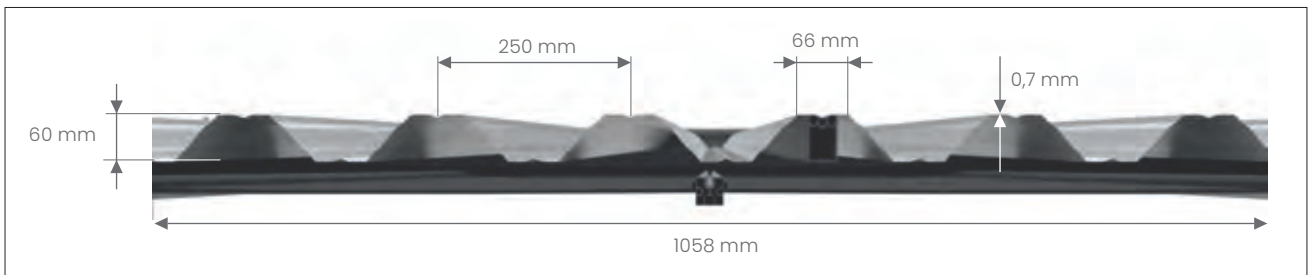

Querschnitt des Trapezbleches T60P (mm) | Cross-section through trapezoidal sheet T60P (mm)

Entwässerungssystem

Water drainage system



Moduls und maximale Abmessung

Models and maximum dimensions

Einzelcarport | One-station Carport



PAVILON	GARDENA	TENDE
<p>mit versetzten Pfosten With gate</p>	<p>mit versetzten Pfosten With gate</p>	

Doppelcarport | Two-stations Carport



PAVILON

GARDENA

TENDE



mit versetzten Pfosten | With gate



mit versetzten Pfosten | With gate



Einzelcarport Modularität | One-station Modular Carport



PAVILON	GARDENA	TENDE

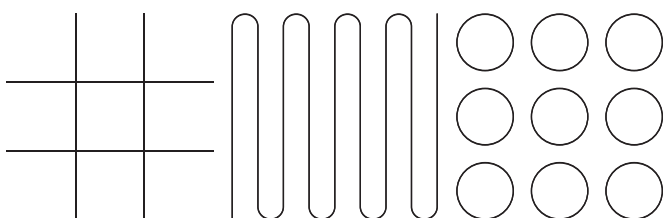

JUICEBOX PRO AUTOLADESTATION

Car Charging Station JUICEBOX PRO



DE

JuiceBox Pro Erhältlich in 22 kW, 32 A, 3-phasig fazowa. Die verfügt über eine Funktion Demand Limitation Pro für die Aufladung mit maximal verfügbarer Leistung, ohne die Leistung zu überschreiten.

EN

JuiceBox Pro Available in 22 kW, 32A, and 3-phase power level. It has a Demand Limitation Pro feature that allows charging at the maximum available power without exceeding it.

Photovoltaikanlage

Photovoltaic panels



DE

Tarasola Carport ist ein maßgefertigtes Dach. Photovoltaik-Module, die ihre festen Abmessungen haben, setzen bestimmte Rahmen, aber das Trapezblechdach unter ihnen ermöglicht es Ihnen, die Größe des Daches an die Bedürfnisse des Investors anzupassen. Abhängig von der gewählten Dimension der Konstruktion werden geeignete PV-Modulenpakete ausgewählt.

EN

Tarasola Carport is a tailor-made roof. The photovoltaic panels, which have their own fixed dimensions, define a specific framework, but the trapezoidal sheet metal roof underneath makes it possible to adapt the size of the Carport to the investor's needs. Depending on the chosen dimensions of the structure, the appropriate panel packages are selected.

Beispielhafte Pakete | Set of examples

PAKET 1 | PACKAGE 1

Einzelcarport | One-station Carport

Breite Width	400 cm
Auskragung Projection	590 cm
Photovoltaikmodul Panels	10 Stück pcs. TIGER NEO (TYP N 54HL4-B 400-420 W)
Gesamtleistung Total output	4200 W

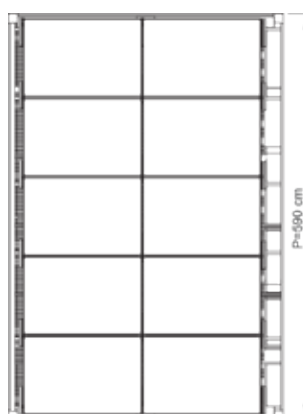
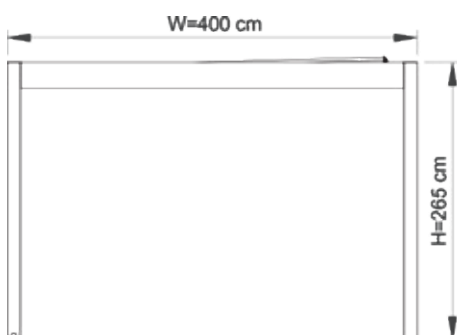

PAKET 2 | PACKAGE 2

Doppelcarport | Two-stations Carport

Breite Width	530-600 cm
Auskragung Projection	540-590 cm
Photovoltaikmodul Panels	12 Stück pcs. TIGER NEO (TYP N 54HL4-B 400-420 W)
Gesamtleistung Total output	5040 W

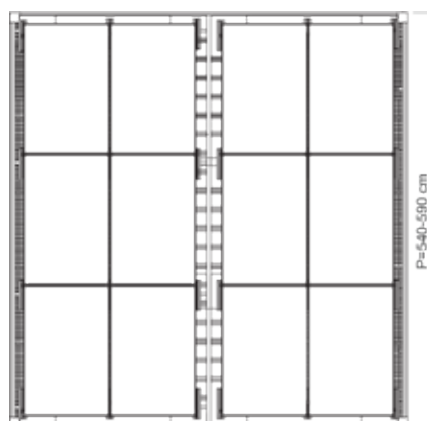
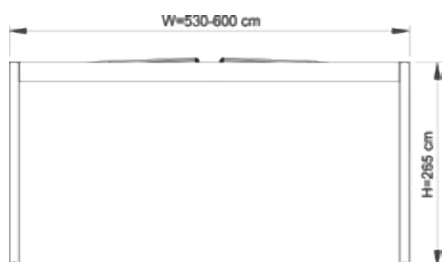

Seitliche Ausstattung

Side development



Zubehör

Accessories

LED Beleuchtung

LED Lighting

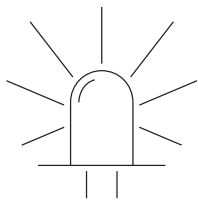

Unterer Stoffdach | Bottom roof with the fabric

LED Spot



LED Strip



Dach ohne Stoff | Bottom roof without the fabric

LED Strip



Heizstrahler

Infrared heater

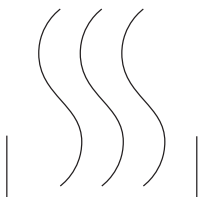

Farbpalette | Colour Range

Konstruktion | Construction

STANDARD



9010 ST

Creme-Weiß

Colour Creamwhite



9007 ST

Grau Aluminium

Grey Aluminium

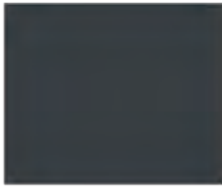

7016 ST

Anthrazit-Metallic

Anthracite Metallic

SONSTIGE FARBEN | ADDITIONAL



Beliebige RAL

Any RAL



Holzähnlicher Lack

Wood-like varnish

Blech | Trapezoidal sheet

STANDARD



9010

Creme-Weiß

Colour Creamwhite



9007

Grau Aluminium

Grey Aluminium



7016

Anthrazit-Metallic

Anthracite Metallic



8004

Braun

Brown

SONSTIGE FARBEN | ADDITIONAL



Beliebige RAL











Any RAL



Holzähnlicher Lack

Wood-like varnish

Opatex – Unterer Stoffdach | Opatex Fabric – bottom roof

 <p>Wei/Wei White/White</p>	 <p>Anthrazit/Creme Anthracite/Cream</p>
 <p>Grau/Hellgrau Light grey</p>	 <p>Graubraun/Creme Taupe/Cream</p>
 <p>Creme/Creme Cream/Cream</p>	 <p>Grn/Creme Green/Cream</p>
 <p>Grau/Creme Grey/Cream</p>	 <p>Anthrazit/Anthrazit Anthracite/Anthracite</p>
 <p>Bordeauxrot/Creme Bordeaux/Cream</p>	 <p>Schwarz/Schwarz Black/Black</p>

SONSTIGE STOFFE | ADDITIONAL



Veozip | Serge 600 / Copaco / Aeroflex | Soltis W 96 | Serge 600 SOLAR



Zertifikate | Certificates

Design von Aluminiumkonstruktionen	Design of aluminium structures	EUROCODE 9: EN 1999
Trapezblech	Trapezoidal sheet metal	PN-EN 14782:2008
Außenbeschattung. Betriebs- und Sicherheitsanforderungen.	External blinds. Performance requirements including safety	PN-EN 13561 + A1/2010
Verordnung zur Festlegung harmonisierter Bedingungen für die Vermarktung von Bauprodukten	Regulation of the construction products	CPR 305/2011
LED-Module für Allgemeinbeleuchtung: Sicherheitsanforderungen	LED lighting	EN 62031 :2008
Pulverbeschichtung	Powder-coating	QUALICOAT
Maximale Windbeständigkeit	Maximum wind resistance	120 km/h
Schneelastwiderstandsfähigkeit	Snow resistance	72-300 kg/m2

Auszeichnungen | Awards

 <p>2011-2021 KONSUMENTENFÜHRER DER DEKADE</p> <hr/> <p>Consumer Leader of the Decade</p>	 <p>2020 INNOWATORY WPROST INNOVATION IN DER DESIGN - KATEGORIE</p> <hr/> <p>Innovation in the DESIGN category</p>	 <p>2020 GESCHÄFTSGAZELLE</p> <hr/> <p>Business Gazelles</p>
--	---	---

Kontakt

Contact

DE +49 (0)171 752 96 35 export@tarasola.com

EN +48 607 189 400 export@tarasola.com

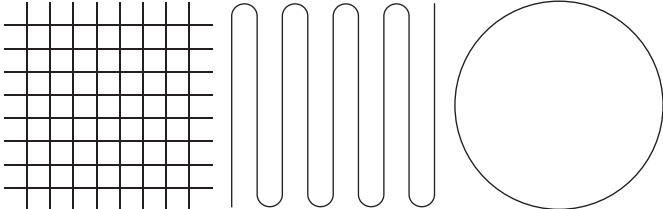

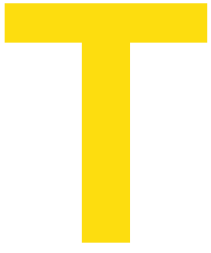

Tarasola.com

