

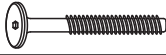









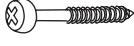
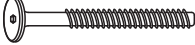



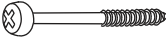

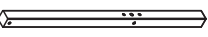

ASSEMBLY INSTRUCTIONS

Pine Shaker Bed Queen

Avoid using sharp objects such as a knife to cut open packing as you may accidentally damage the item.

PARTS LIST

| ITEM | DESCRIPTION | SKETCH | QUANTITY |
|------|---------------------------|--|----------|
| HW1 | Screw : 1/4x80mm |  | 8x |
| HW2 | Dowel : 10x40mm |  | 16x |
| HW3 | Screw : 4,0x30mm |  | 12x |
| HW4 | Screw : 7,0x80mm |  | 8x |
| HW5 | Screw : 7,0x60mm |  | 5x |
| HW6 | Allen Key |  | 1x |
| HW7 | Elliptical Nut : 1/4x25mm |  | 8x |
| HW8 | Dowel : 8x30mm |  | 54x |
| HW9 | Screw : 4,0x45mm |  | 8x |
| A | Upper Grid Crossbar |  | 2x |
| B | Lower Grid Crossbar |  | 2x |
| C | Large Grid |  | 12x |
| D | Small Grid |  | 12x |
| E | Large Left Foot |  | 1x |
| F | Large Right Foot |  | 1x |
| G | Small Left Foot |  | 1x |
| H | Small Right Foot |  | 1x |
| I | Side Rails |  | 2x |
| J | Top Bar |  | 2x |
| K | Slat |  | 2x |
| L | Central Foot Support |  | 1x |
| M | Center Foot |  | 3x |

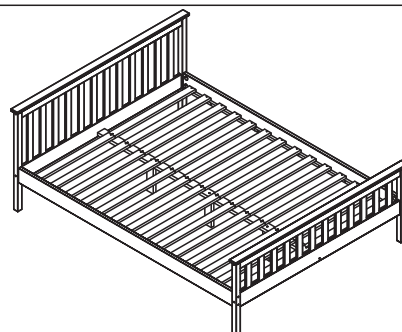

ASSEMBLY INSTRUCTIONS

Do not fully tighten bolts until assembly is complete.

Step 1

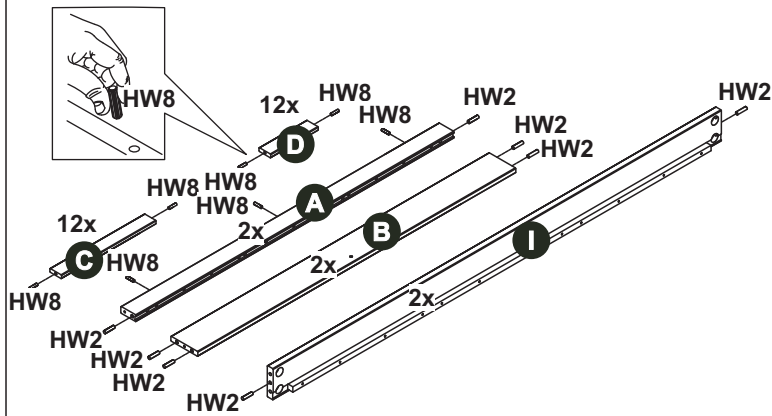

Step 1: Insert the dowels in parts A, B, C, D and I

Step 2

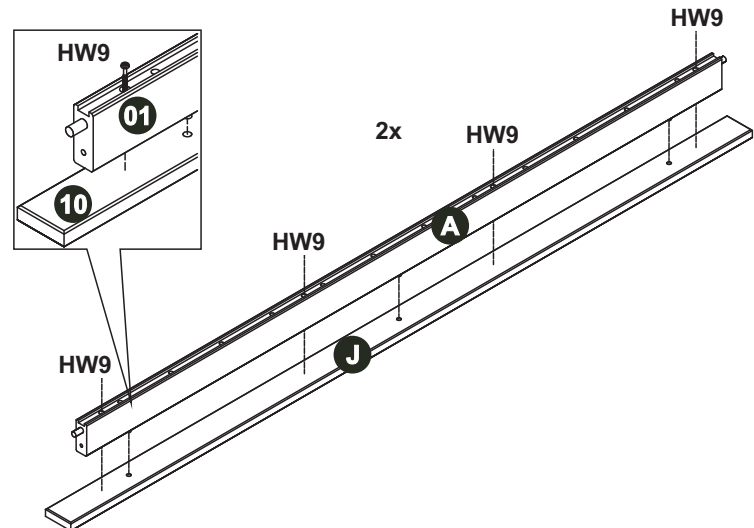

Step 2: Join part A and J with HW9 screw

Step 3

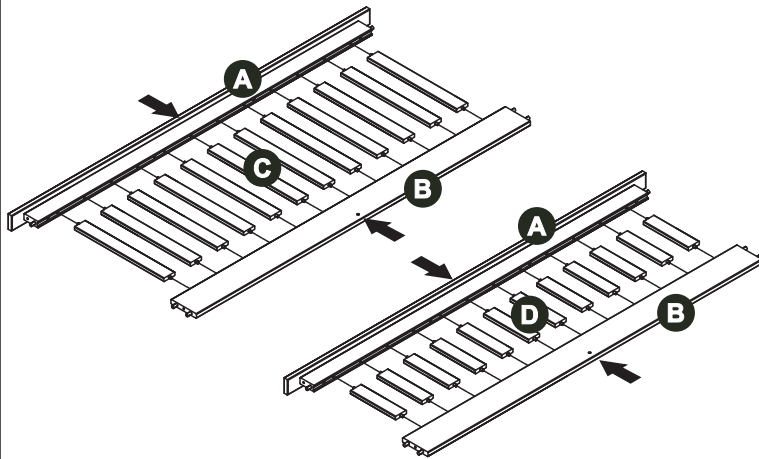

Step 3: Fit parts A and B, on the grid C and D

Step 4

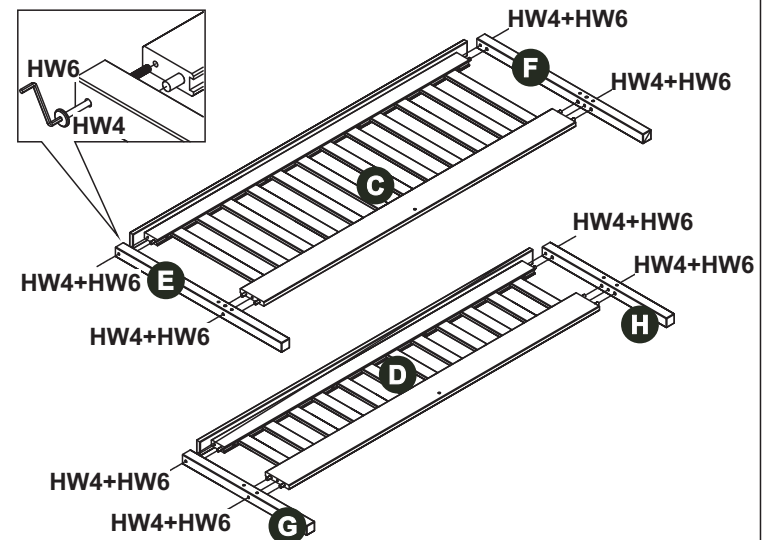

Step 4: Join grid C with feet E + F with HW4 screw and HW6 key
Join grid D with feet G + H with HW4 screw and HW6 key

Step 5

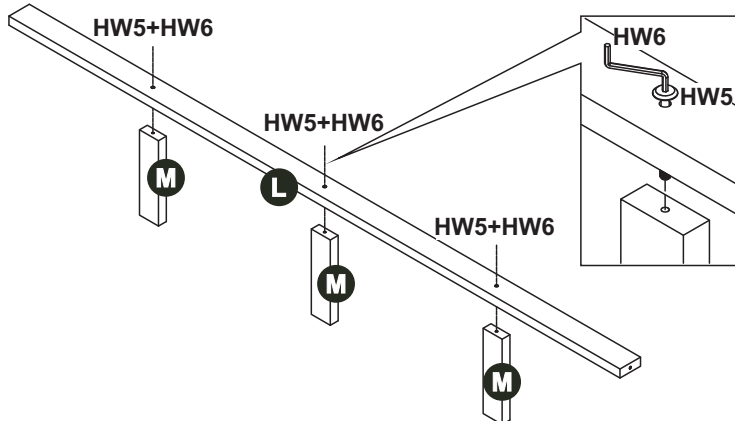

Step 5: Join piece L + M with screw HW5 and key HW6

Step 6

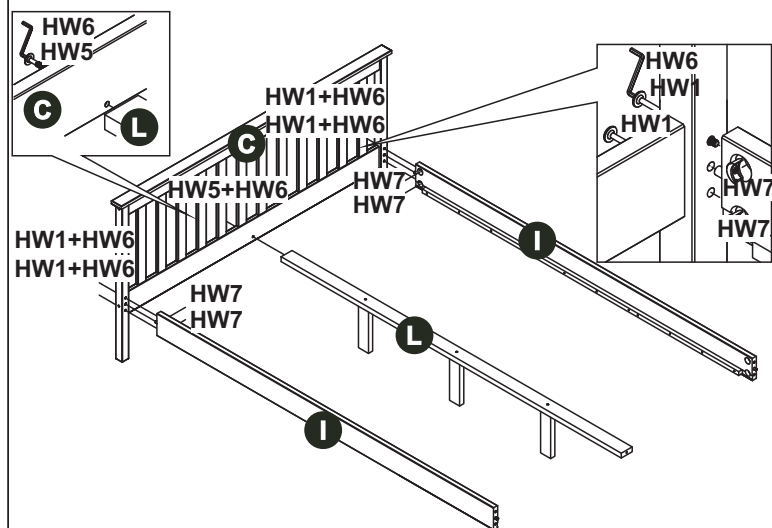

Step 6: Join the mounted grid C with the bars I, use screw HW1 with key HW6 and nut HW7
Fix the support L with screw HW5 and key HW6

