

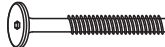









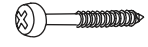

ASSEMBLY INSTRUCTIONS

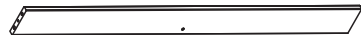
Pine Basic Platform Bed Full

Avoid using sharp objects such as a knife to cut open packing as you may accidentally damage the item.

PARTS LIST

ITEM	DESCRIPTION	SKETCH	QUANTITY
HW1	Screw : 1/4x70mm		8x
HW2	Dowel : 10x40mm		12x
HW3	Screw : 4,0x30mm		12x
HW4	Screw : 7,0x90mm		4x
HW5	Screw : 7,0x60mm		5x
HW6	Allen Key		1x
HW7	Elliptical Nut : 1/4x25mm		8x
A	Headboard Lower Crossbar		2x
B	Side Rails		2x
C	Left Foot		2x
D	Right Foot		2x
E	Slat		2x
F	Center Support Bar		1x
G	Center Support Legs		3x

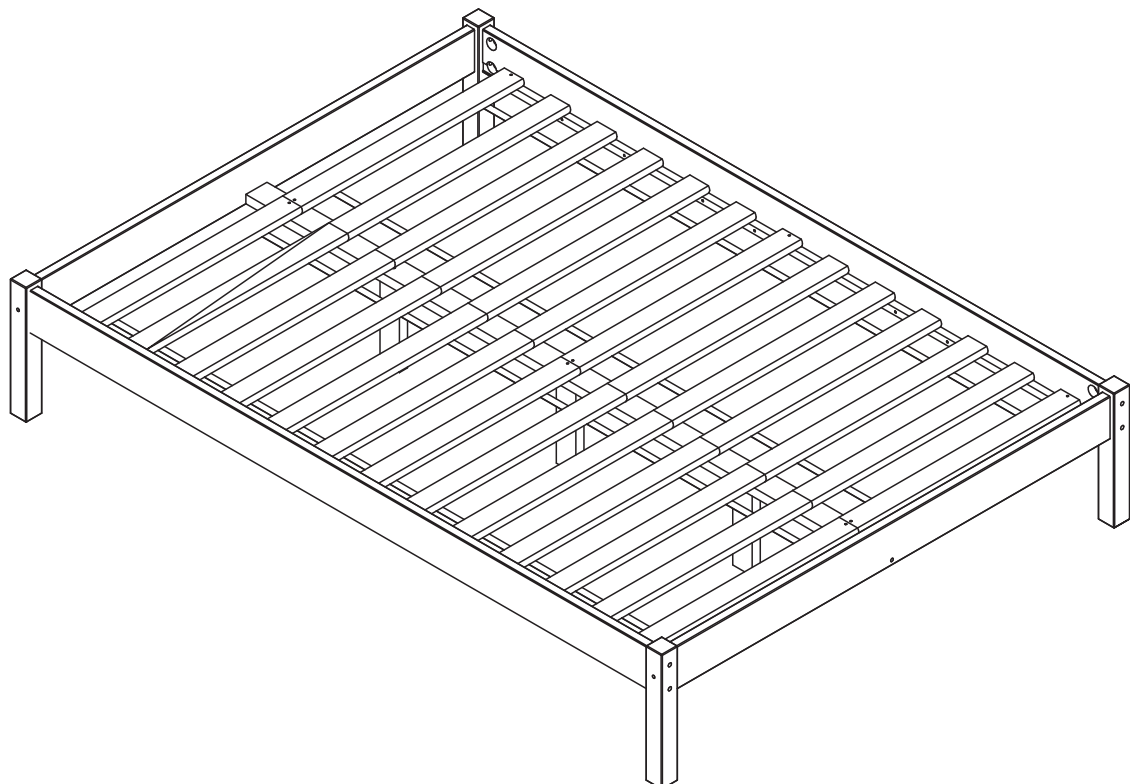

ASSEMBLY INSTRUCTIONS

Do not fully tighten bolts until assembly is complete.

Step 1

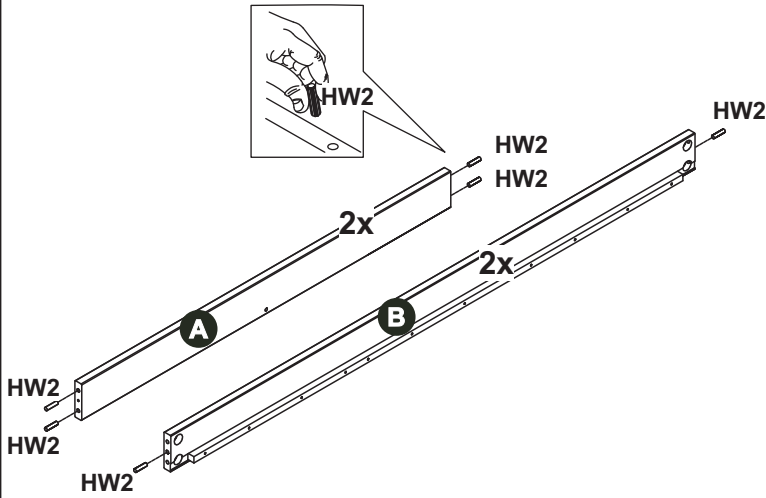

Step 1: Insert the dowels HW2 in parts A and B

Step 2

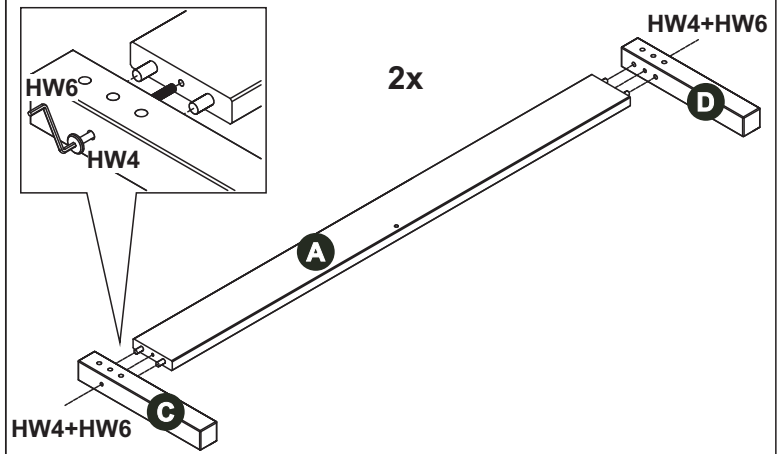

Step 2: Join crosspiece A with feet C + D with HW4 screw and HW6 spanner

Step 3

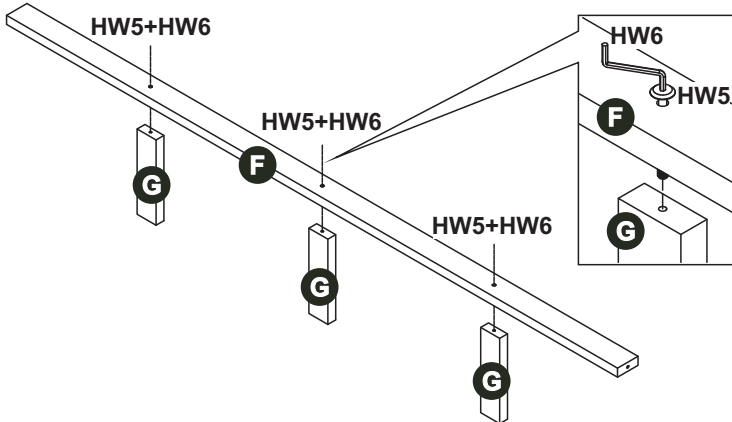

Step 3: Join piece F + G with screw HW5 and key HW6

Step 4

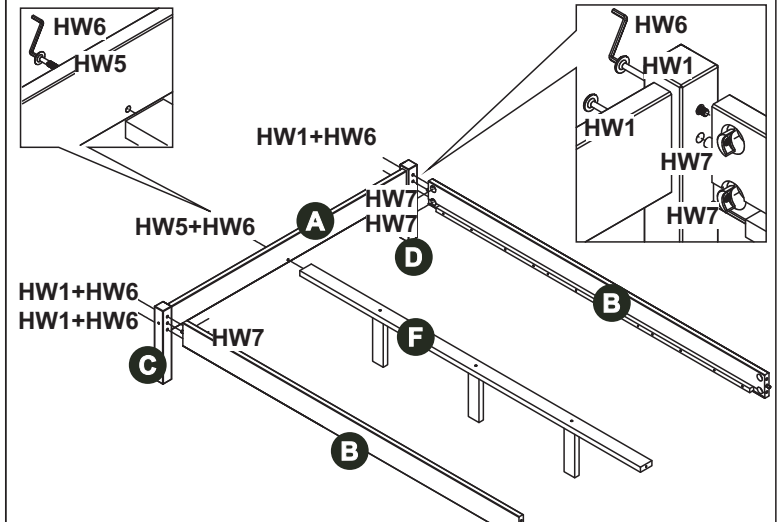

Step 4: Join mounted headboard A with B, use screw HW1 with HW6 wrench and HW7 nut
Fix the support F with screw HW5 and key HW6

Step 5

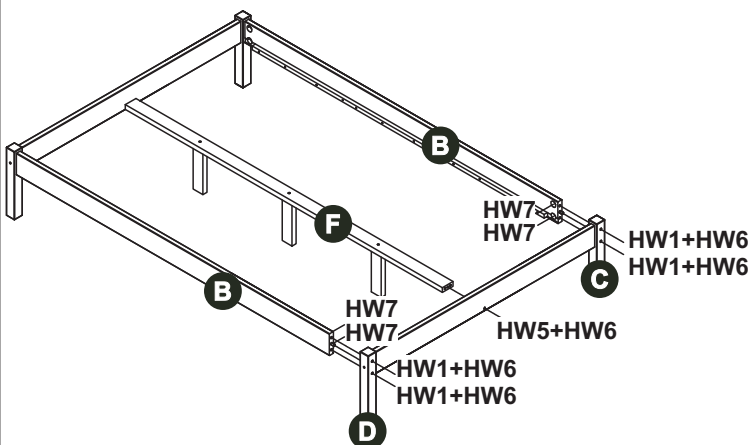

Step 5: Join mounted headboard A with B, use screw HW1 with HW6 wrench and HW7 nut
Fix the support F with screw HW5 and key HW6

Step 6

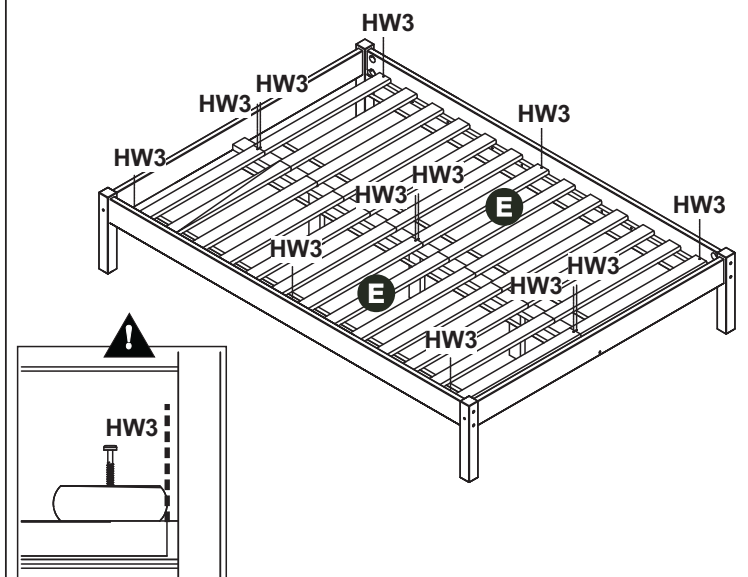

Step 6: Fit the platforms E and fix with screws HW3

CLEANING INSTRUCTIONS: Clean with Soft cloth, brush, or lightly vacuum.

ADULT ASSEMBLY REQUIRED

If you are missing any parts or have any questions regarding assembly, do not return this item to the retailers store. Please call our toll-free, customer service number and have this assembly manual open to the parts list ready to provide the model name, number and part name or number.



Customer Service

1-877-864-5752

8:30 AM PST - 4:00 PM PST (Monday-Friday)

Website: www.dwellhom.com

Missing Parts: parts@dwellhom.com

Warranty Information: www.dwellhom.com/warranty