

## SP6494C: 6W Peak Power Amplifier, 2.1-2.2 GHz

### General Description

The SP6494C is a high efficiency 6 W peak power amplifier suitable for application in FDD and TDD small cell base stations as well as general purpose amplification. It operates over a frequency range of 2.1 GHz to 2.2 GHz. The RF input and output ports are internally matched to 50  $\Omega$  for the full frequency range. This device incorporates a device enable pin with turn on/off times of less than 1  $\mu$ s.

The power amplifier has high gain and peak power which linearizes well in DPD systems giving better than 50 dBc ACLR for 20 MHz modulation bandwidth.

This amplifier uses a Doherty architecture to improve back-off efficiency required by modern communications standards which employ high peak-to-average signals. A functional diagram of the SP6494C is shown in Figure 1. The RF input does not require a DC block provided the input connection is at 0 V DC. The RF output has an internal DC block.

### Applications

- 5G Small Cell applications
- MIMO Systems
- 3GPP bands n1, n65, n66
- Driver amplifier
- General purpose wireless

### Features

- Frequency 2.1 GHz to 2.2 GHz
- High Peak Envelope Power 37.5 dBm
- High Efficiency 31 %
- High Small Signal Gain 37 dB
- Instantaneous Bandwidths up to 60 MHz
- Single Supply Domain +5 V
- Enable/shutdown pin
- Package: 5x5 mm

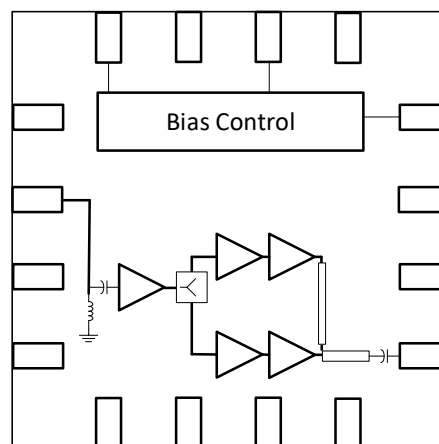

Figure 1 Functional Diagram

**Table of Contents**

General Description .....1

Applications.....1

Features .....1

Table of Contents .....2

List of Tables .....2

List of Figures .....3

1 Pin Configuration .....4

1.1 Pin Configuration Diagram .....4

1.2 Pin Description.....4

2 Electrical Specifications .....5

3 Typical Performance Characteristics .....7

4 Example Application Diagram ..... 11

4.1 Power-Up / Down Sequence .....12

5 Package Information ..... 13

6 Ordering Information..... 15

Contact Information ..... 17

Trademarks..... 17

**List of Tables**

Table 1 Pin Description.....4

Table 2 Absolute Maximum Ratings .....5

Table 3 Handling Precautions.....5

Table 4 Device Thermal Resistance .....5

Table 5 Recommended Operating Conditions .....5

Table 6 Electrical Characteristics. ....6

Table 7 Device Truth Table .....6

Table 8 Bill of Materials ..... 11

Table 9 Ordering Information..... 15

Table 10 Tape and Reel Dimensions ..... 16

List of Figures

Figure 1 Functional Diagram .....1

Figure 2 SP6494C Pin Diagram (Top View).....4

Figure 3 Input Return Loss over Temperature .....7

Figure 4 Small Signal Gain over Temperature .....7

Figure 5 Reverse Isolation over Temperature .....7

Figure 6 Output Return Loss over Temperature.....7

Figure 7 Large Signal Gain vs Output Power over Temperature .....7

Figure 8 Wideband Small Signal Gain over Temperature.....7

Figure 9 Efficiency vs Output Power over Temperature.....8

Figure 10 Operating Current vs Output Power over Temperature .....8

Figure 11 ACLR (Raw) Frequency over Temperature (20 MHz 8.5 dB PAPR Pout 29.0 dBm) .....8

Figure 12 ACLR (Raw) Frequency over Temperature (2\*20 MHz 8.5 dB PAPR Pout 29.0 dBm).....8

Figure 13 ACLR for 20 MHz 8.5 dB PAPR with and without DPD over power and temperature .....8

Figure 14 ACLR for 2x20 MHz 8.5 dB PAPR with and without DPD over power and temperature .....8

Figure 15 Input Return Loss over Voltage .....9

Figure 16 Small Signal Gain over Voltage.....9

Figure 17 Reverse Isolation over Voltage .....9

Figure 18 Output Return Loss over Voltage .....9

Figure 19 Large Signal Gain vs Output Power over Voltage.....9

Figure 20 Efficiency vs Output Power over Voltage ..... 10

Figure 21 Operating Current vs Output Power over Voltage..... 10

Figure 22 ACLR (Raw) Frequency over Voltage (20 MHz 8.5 dB PAPR Pout ave. 29.0 dBm)..... 10

Figure 23 ACLR (Raw)Frequency over Voltage (2\*20 MHz 8.5 dB PAPR Pout ave. 29.0 dBm) ..... 10

Figure 24 Wideband Small Signal Gain over Voltage ..... 10

Figure 25 Schematic Diagram ..... 11

Figure 26 Package Dimensions..... 13

Figure 27 Solder Stencil and PCB Footprint Metallisation ..... 14

Figure 28 Part Markings ..... 15

## 1 Pin Configuration

### 1.1 Pin Configuration Diagram

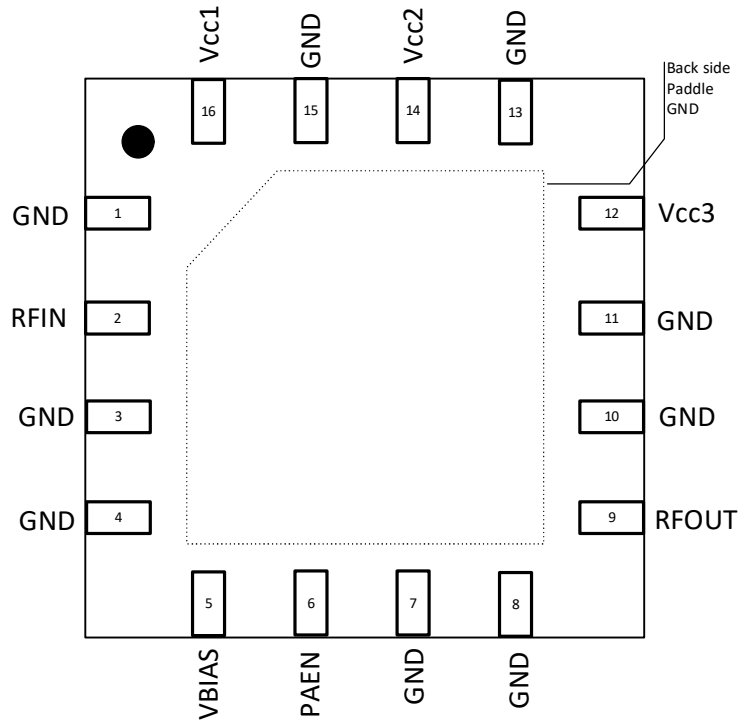

Figure 2 SP6494C Pin Diagram (Top View)

### 1.2 Pin Description

Table 1 Pin Description

Pin No	Pin Name	Description
1	GND	Ground connection
2	RF In	RF Input – Matched to 50 $\Omega$
3	GND	Ground connection
4	GND	Ground connection
5	Vbias	Supply for bias circuit
6	PAEN	Controls operation between active and low power states
7	GND	Ground connection
8	GND	Ground connection
9	RF Out	RF Output – matched to 50 $\Omega$
10	GND	Ground connection
11	GND	Ground connection
12	Vcc3	Supply for 3 <sup>rd</sup> stage
13	GND	Ground connection
14	Vcc2	Supply for 2 <sup>nd</sup> stage
15	GND	Ground connection
16	Vcc1	Supply for 1 <sup>st</sup> stage
Backside Paddle	GND	This is the ground connection and should be soldered directly to ground, ensuring low inductance and low thermal resistance

## 2 Electrical Specifications

**Table 2 Absolute Maximum Ratings**

Parameter	Min	Max	Units
Supply Voltage		5.5	V
Control Pin Input Voltage		2.8	V
Peak RF Input Power (LTE 20 MHz modulated 8.5dB PAPR signal)		5	dBm
Maximum Junction Temperature		150	°C
Storage Temperature	-55	125	°C

Table 2 Absolute Maximum Ratings notes:

- Exceeding absolute maximum ratings may cause permanent damage. Operation should only occur within the limits specified. Operating between the maximum operating range Table 5 and the absolute maximum for extended periods may reduce the reliability of the device.
- Not recommended for pulsed CW operation

**Table 3 Handling Precautions**

Observe standard procedures as with other ESD-sensitive devices when handling the product. The product includes ESD protection circuitry, but precautions should be taken not to exceed the ratings specified in this table.

Parameter	Level	Test Standard
ESD voltage HBM, All Pins	1kV	JS-001-2017
ESD voltage CDM, All pins	1kV	JS-002-2018
Moisture Sensitivity Level	3	J-STD-020E

**Table 4 Device Thermal Resistance**

Parameter	$\theta_{jc}$	Unit
Junction to case bottom	21.3	°C/W

**Table 5 Recommended Operating Conditions**

Parameter	Sym	Min	Typ	Max	Units
Supply Voltage (V <sub>CC1,2,3</sub> , V <sub>BIAS</sub> )	V <sub>cc1</sub> , V <sub>cc2</sub> , V <sub>cc3</sub> , V <sub>bias</sub>	4.75	5	5.25	V
Control Input (PA Enable) High	V <sub>ctrl</sub>	1.7	2	2.5	V
Control Input (PA Enable) Low	V <sub>ctrl</sub>	0		0.7	V
RF Input Power, average (LTE)	Pin			-7	dBm
Operating Temperature Range (T <sub>CASE</sub> )	T <sub>case</sub>	-40	25	85	°C

**Table 6 Electrical Characteristics.**
**Operating conditions:**
**T<sub>case</sub> = 25 °C, V<sub>cc</sub> = V<sub>bias</sub> = 5 V, Z<sub>in</sub> = Z<sub>out</sub> = 50 Ω, F<sub>c</sub> = 2140 MHz unless otherwise stated**

Parameter	Conditions	Symbol	Min	Typ	Max	Units
Frequency		f	2110		2170	MHz
Small Signal Gain	P <sub>IN</sub> = -35 dBm	S21	36.5	37.9		dB
Input Return Loss	P <sub>IN</sub> = -25 dBm	S11		10.0		dB
Output Return Loss	P <sub>IN</sub> = -25 dBm	S22		10.5		dB
Reverse Isolation	P <sub>IN</sub> = -25 dBm	S12		70		dB
Gain @ 29 dBm	P <sub>OUT</sub> = 29 dBm	S21@29 dBm	37.5	39		dB
ACLR (RAW)	LTE 20 MHz, 8.5 dB PAPR, +29.0 dBm av. Power	ACLR		-29.2		dBc
Output Power at 3 dB compression	CW, ref to small signal gain; P <sub>IN</sub> = -30 dBm	P3dB	36.5	37.5		dBm
2nd Harmonic	CW, P <sub>OUT</sub> = 29 dBm	2fo		-56		dBc
3rd Harmonic	CW, P <sub>OUT</sub> = 29 dBm	3fo		-65		dBc
Power-added Efficiency	P <sub>OUT</sub> =29 dBm (CW)	PAE	27.5	31.3		%
PA Enable Current Draw		I <sub>PAEN</sub>		260		uA
Quiescent Current	No RF signal	I <sub>CCQ</sub>		114	128	mA

**Table 7 Device Truth Table**

Control Input (PA Enable) State	Device State
High	Amplifier On
Low	Amplifier Off

### 3 Typical Performance Characteristics

Operating conditions:  $T_{case} = 25\text{ }^{\circ}\text{C}$ ,  $V_{cc} = V_{bias} = 5\text{ V}$ ,  $Z_{in} = Z_{out} = 50\text{ }\Omega$ ,  $F_c = 2.14\text{ GHz}$  unless otherwise stated.

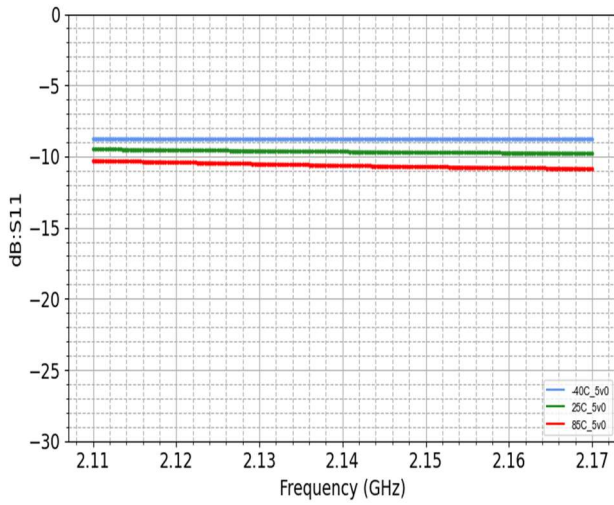

Figure 3 Input Return Loss over Temperature

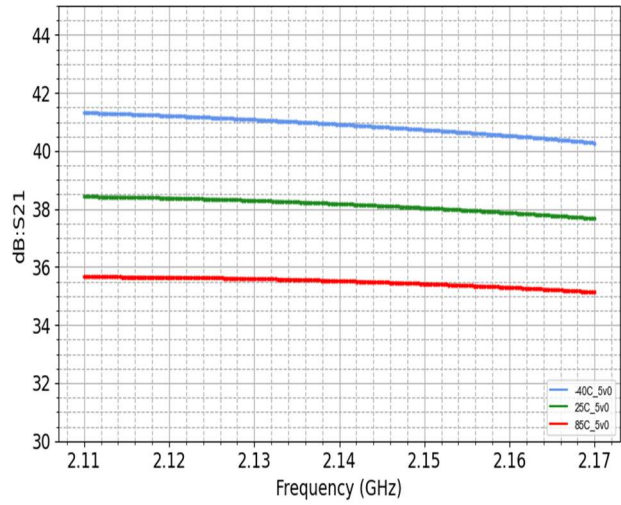

Figure 4 Small Signal Gain over Temperature

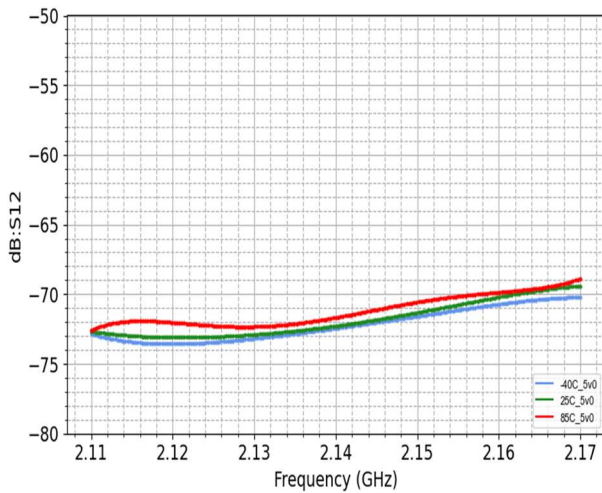

Figure 5 Reverse Isolation over Temperature

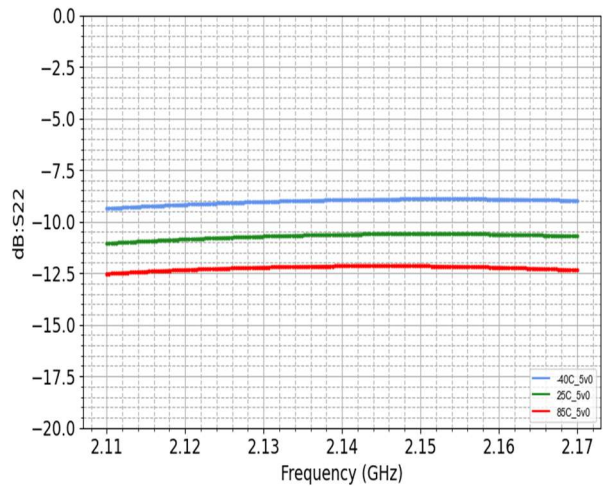

Figure 6 Output Return Loss over Temperature

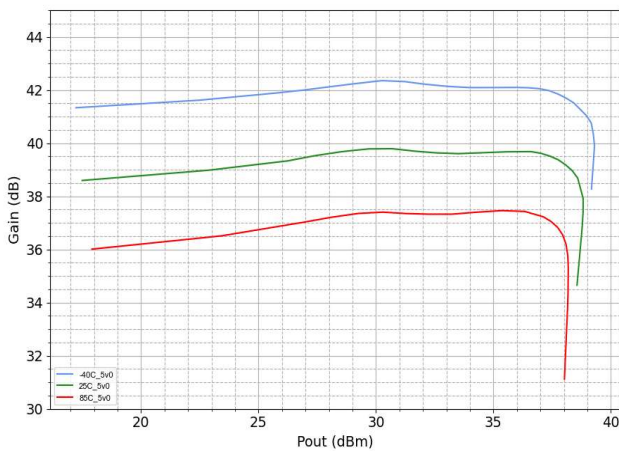

Figure 7 Large Signal Gain vs Output Power over Temperature

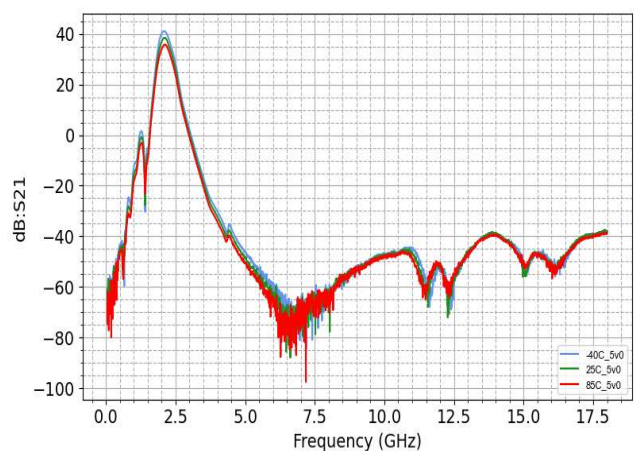

Figure 8 Wideband Small Signal Gain over Temperature

Operating conditions: Tcase = 25 °C, Vcc = Vbias = 5 V, Zin = Zout = 50 Ω, Fc = 2.14 GHz unless otherwise stated.

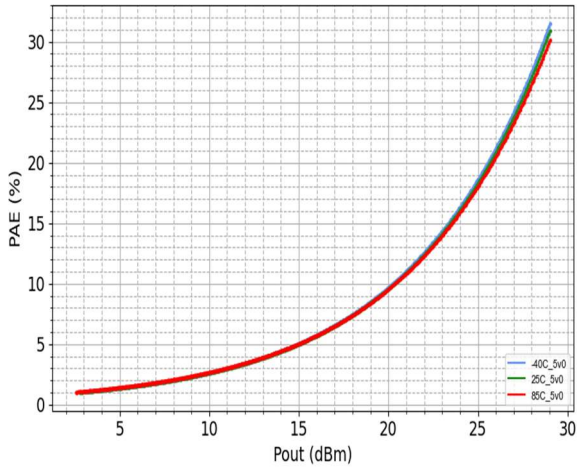

Figure 9 Efficiency vs Output Power over Temperature

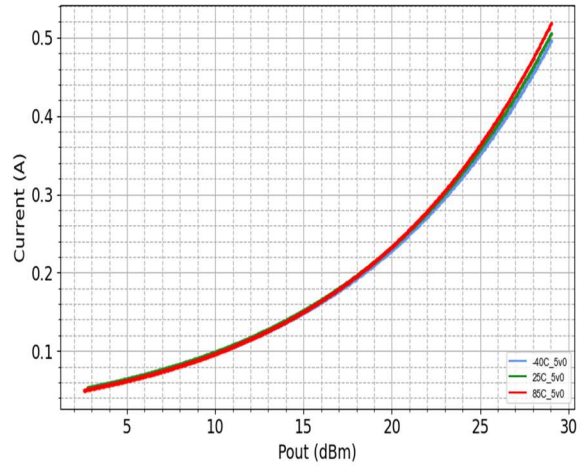

Figure 10 Operating Current vs Output Power over Temperature

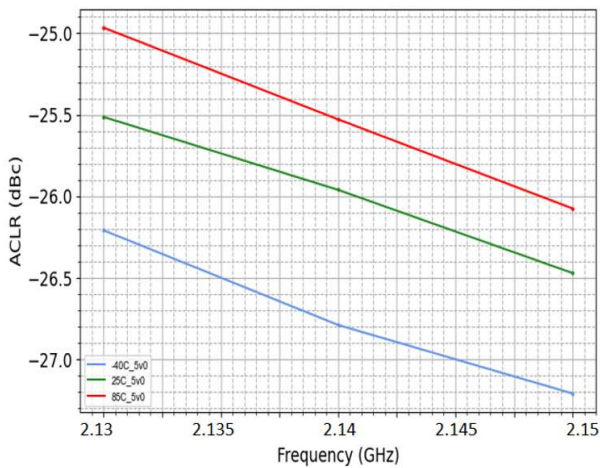

Figure 11 ACLR (Raw) Frequency over Temperature (20 MHz 8.5 dB PAPR Pout 29.0 dBm)

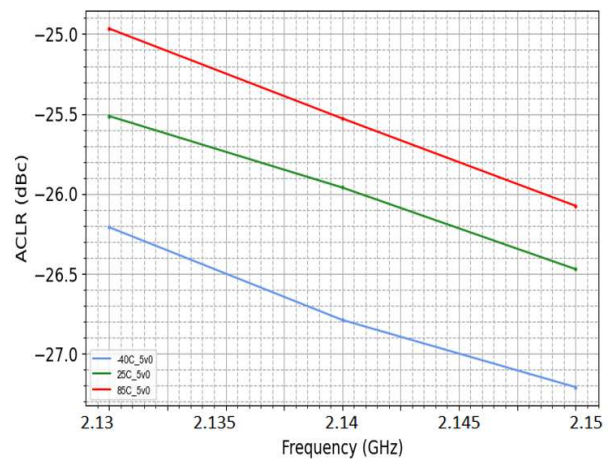

Figure 12 ACLR (Raw) Frequency over Temperature (2\*20 MHz 8.5 dB PAPR Pout 29.0 dBm)

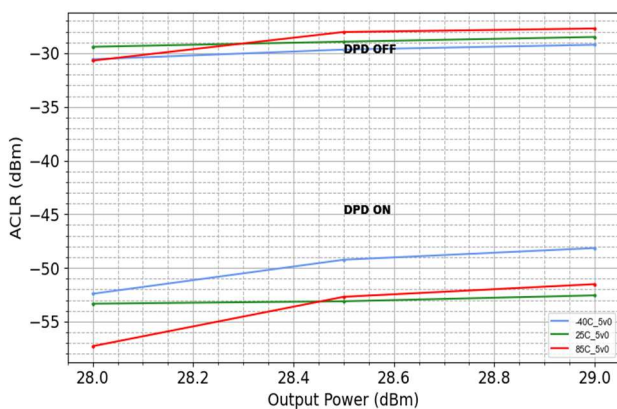

Figure 13 ACLR for 20 MHz 8.5 dB PAPR with and without DPD over power and temperature

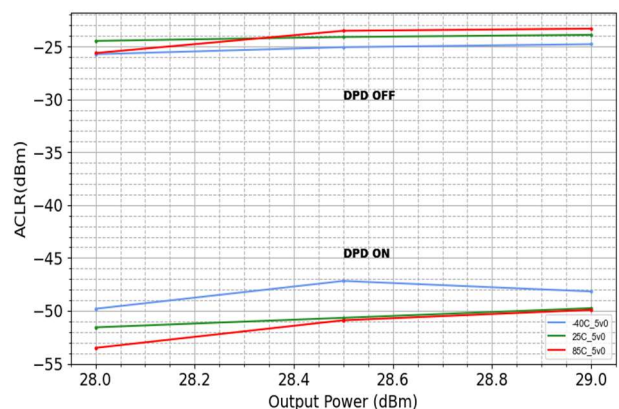

Figure 14 ACLR for 2x20 MHz 8.5 dB PAPR with and without DPD over power and temperature

Note: Figure 13 and Figure 14, DPD ON generated with commercially available GMP DPD from NI (NI VST with RFIC Tool), polynomial order 6.



Operating conditions: Tcase = 25 °C, Vcc = Vbias = 5 V, Zin = Zout = 50 Ω, Fc = 2.14 GHz unless otherwise stated.

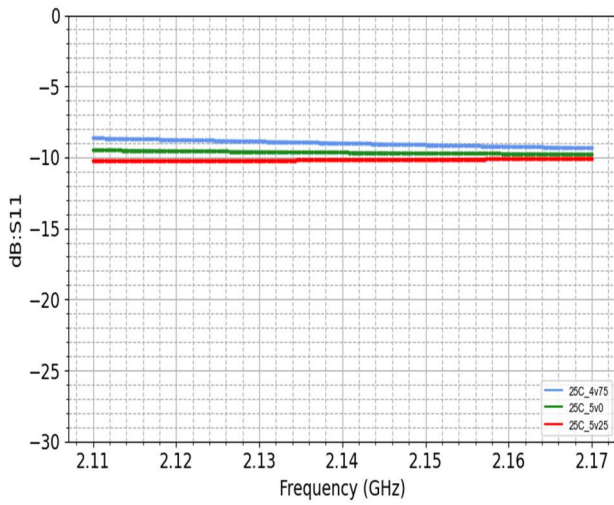

Figure 15 Input Return Loss over Voltage

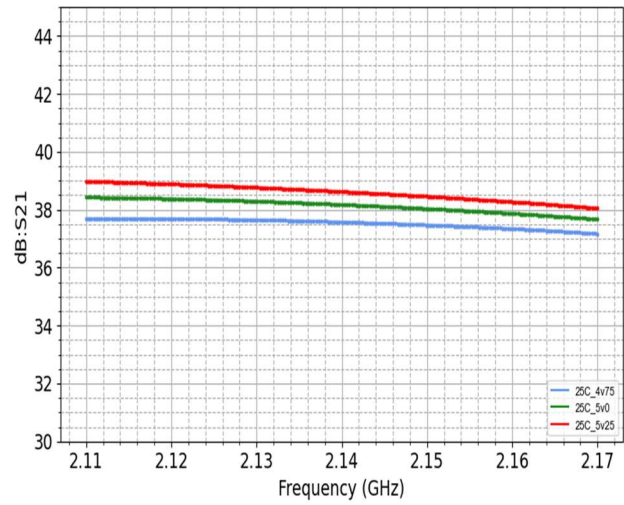

Figure 16 Small Signal Gain over Voltage

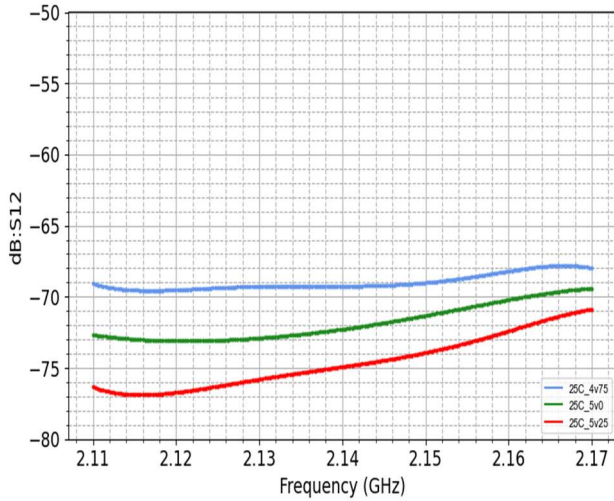

Figure 17 Reverse Isolation over Voltage

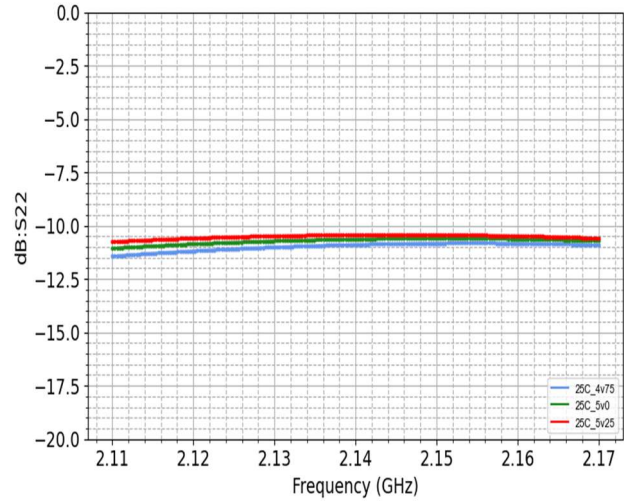

Figure 18 Output Return Loss over Voltage

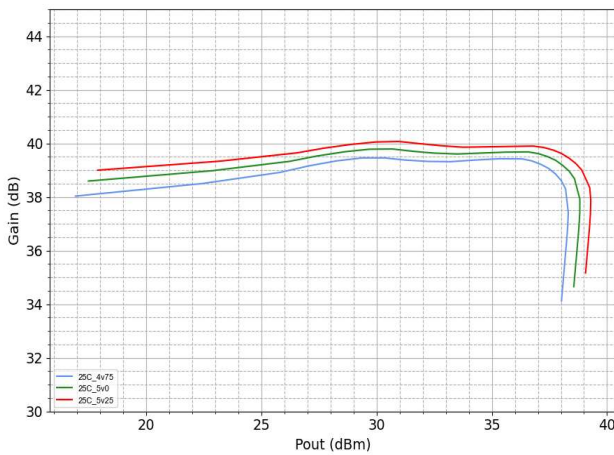

Figure 19 Large Signal Gain vs Output Power over Voltage

Operating conditions: Tcase = 25 °C, Vcc = Vbias = 5 V, Zin = Zout = 50 Ω, Fc = 2.14 GHz unless otherwise stated.

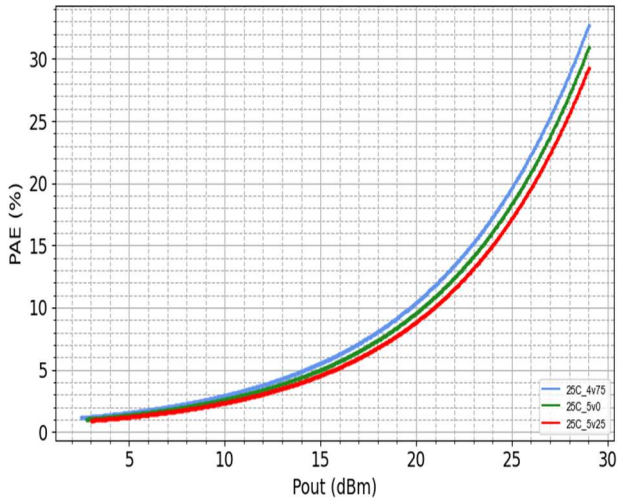

Figure 20 Efficiency vs Output Power over Voltage

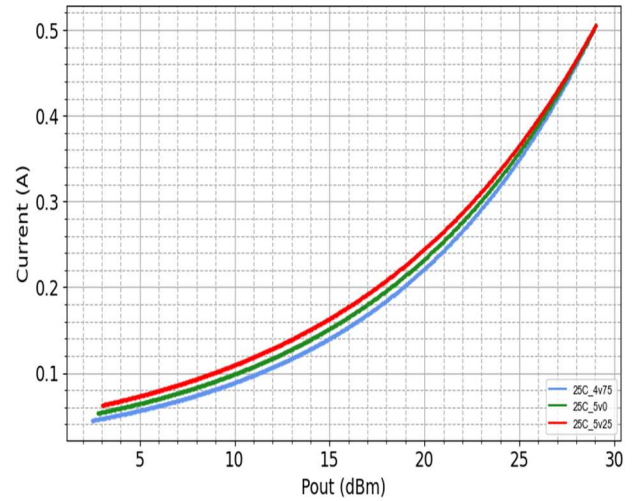

Figure 21 Operating Current vs Output Power over Voltage

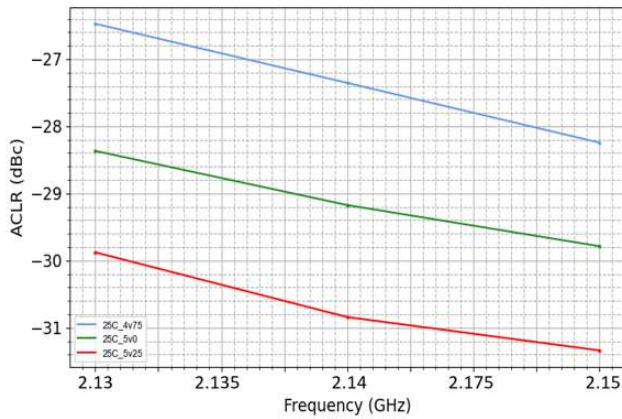

Figure 22 ACLR (Raw) Frequency over Voltage (20 MHz 8.5 dB PAPR Pout ave. 29.0 dBm)

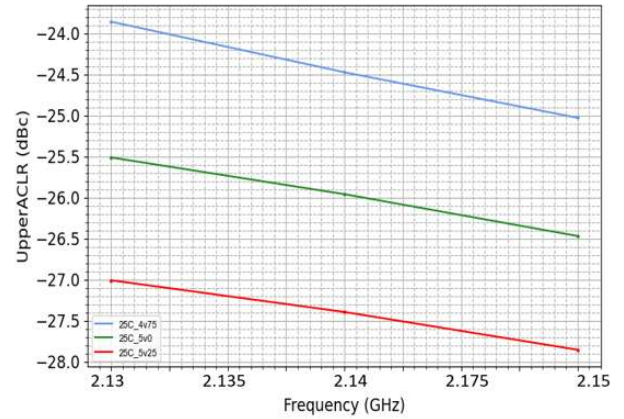

Figure 23 ACLR (Raw) Frequency over Voltage (2\*20 MHz 8.5 dB PAPR Pout ave. 29.0 dBm)

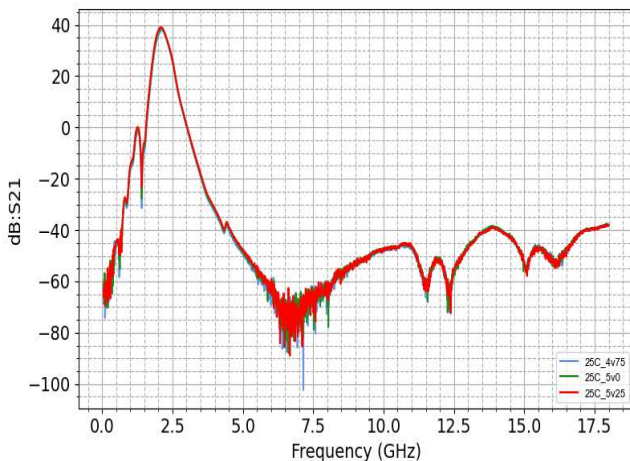

Figure 24 Wideband Small Signal Gain over Voltage

## 4 Example Application Diagram

For the Evaluation Board (EVB) details, including schematic, board stack-up and Gerber images please see the SP6494C Application Note.

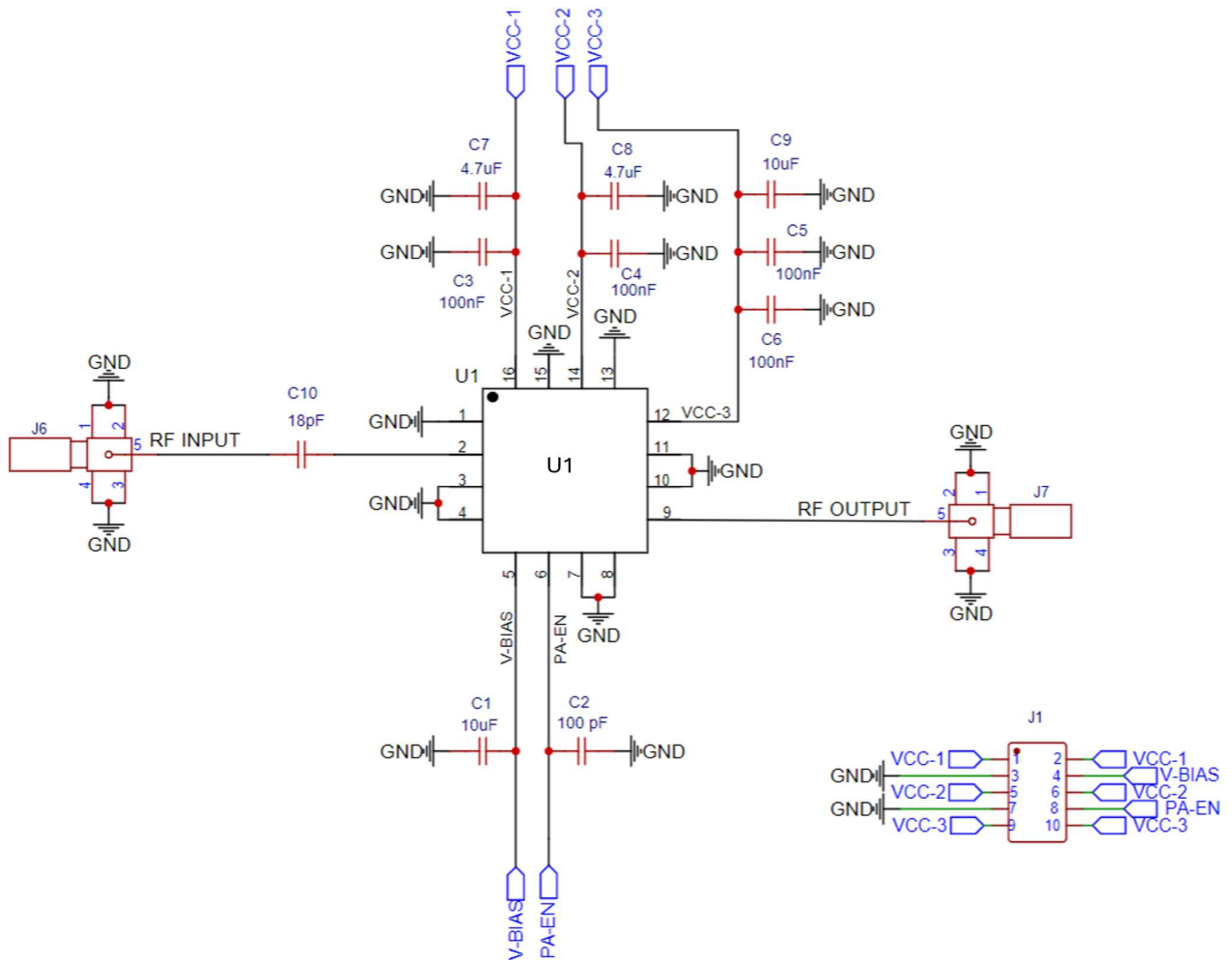

Figure 25 Schematic Diagram

Table 8 Bill of Materials

Component Reference	Value	Tolerance	Voltage	Manufacturer	Part Number
C1	10uF	+/-20%	10V	Samsung	CL05A106MP5NUNC
C2	100pF	+/-5%	50V	Murata	GCM1555C1H101JA16D
C3, C4, C5, C6	100nF	+/-10%	50V	Murata	GCM155R71H104KE02D
C7, C8	4.7uF	+/-10%	16V	Murata	GRM219C81C475KA73D
C9	10uF	+/-10%	16V	Murata	GRM21BC81C106KE15L
C10	18pF	+/-5%	50V	Murata	GJM1555C1H180JB01D
J1				Harwin	M20-8760546
J6, J7, J8, J9				Johnson/Cinch	142-0701-841
U1	Au649x			Spirit Semiconductor	SP6494C

## 4.1 Power-Up / Down Sequence

The device power-up sequence is as follows:

- 1) Terminate RF input and output with 50 Ohm
- 2) Connect DC ground
- 3) Ensure PA Enable is set to Low
- 4) Connect Vcc1, Vcc2, Vcc3 & Vbias to +5 V
- 5) Set PA Enable High to +2 V
- 6) Apply RF at PA Input at -30 dBm

The power-down sequence is the reverse of the power-up sequence.

It is important to ensure that ohmic losses in the power supply feed are accounted for and that the voltage at Vcc1,2,3 & Vbias are adjusted to 5.0 V at the operating condition.

## 5 Package Information

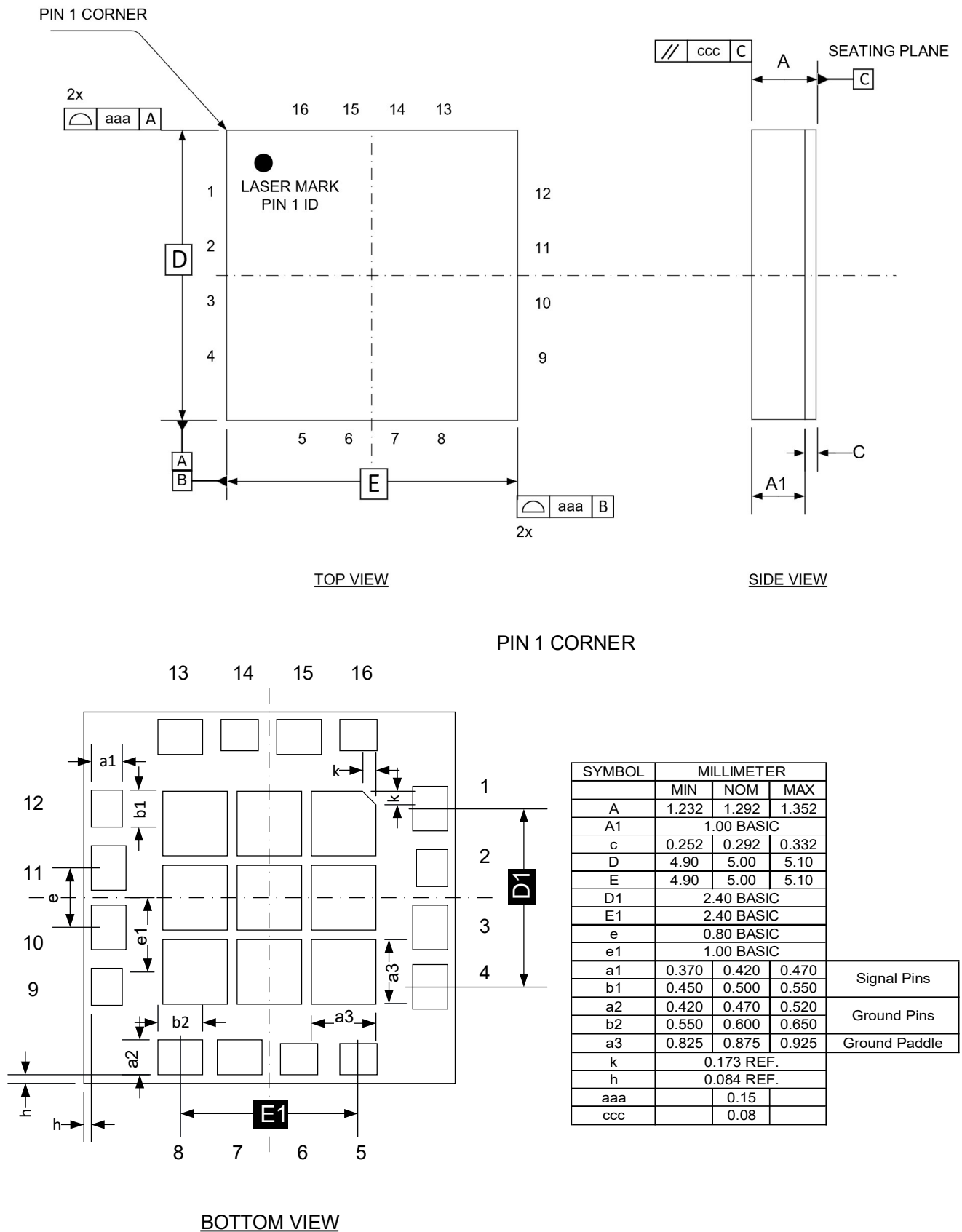
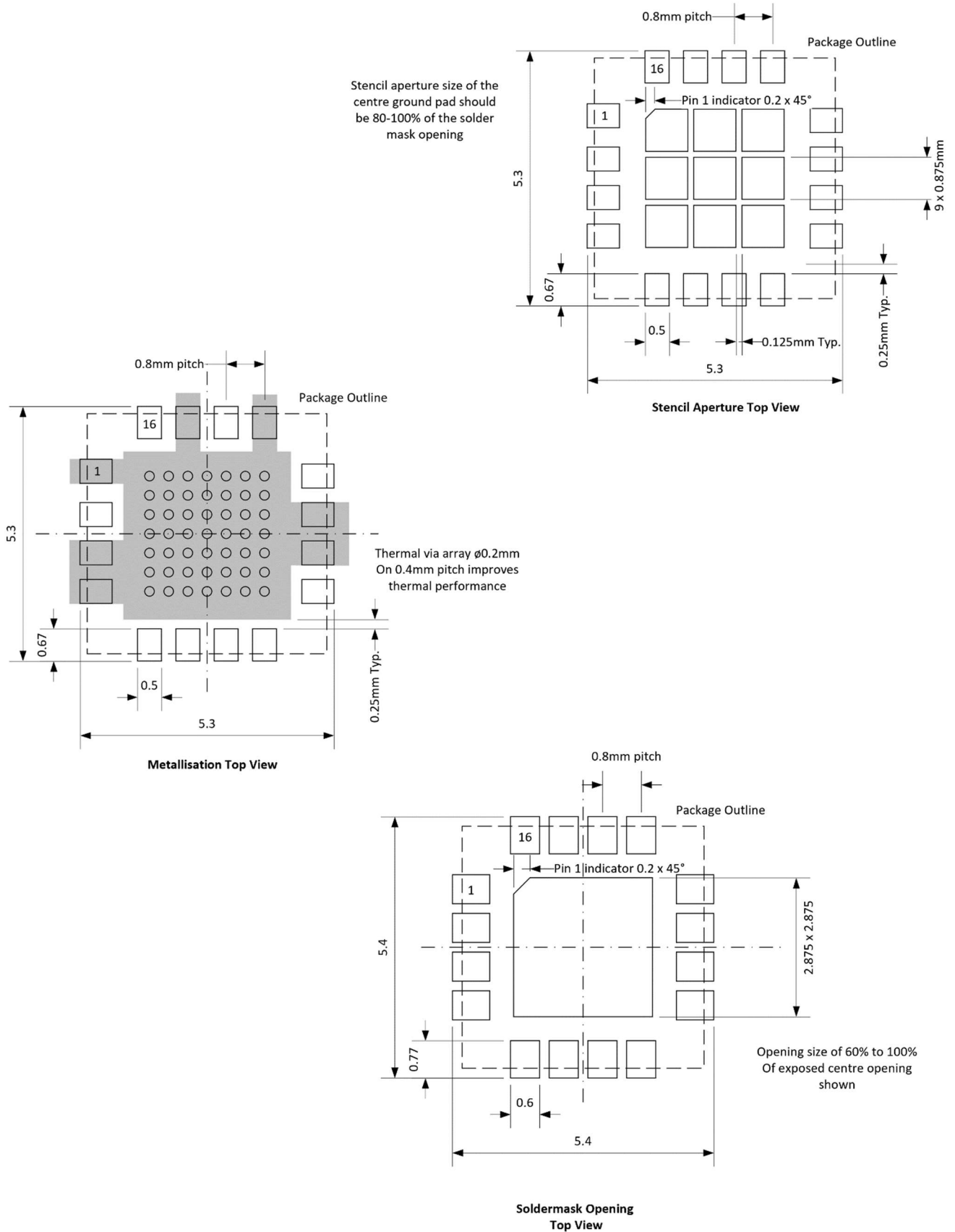

Figure 26 Package Dimensions



**Figure 27 Solder Stencil and PCB Footprint Metallisation**

## 6 Ordering Information

Table 9 Ordering Information

Ordering Part Number (OPN)	Marking	Package	Shipping Package	Temperature Range	MSL Level	Ecology
SP6494C-LMR	SP6494C	LGA 5x5	Tape and Reel	-	3	RoHS <sup>[1]</sup>

Notes:

1. This part is compliant with 2011/65/EU RoHS directive (Restrictions on the Use of Certain Hazardous Substances in Electrical and Electronic Equipment) as amended by Directive 2015/863/EU.

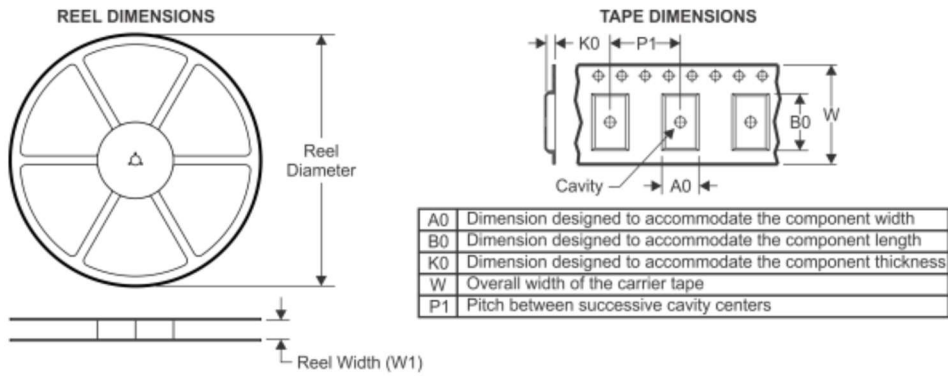
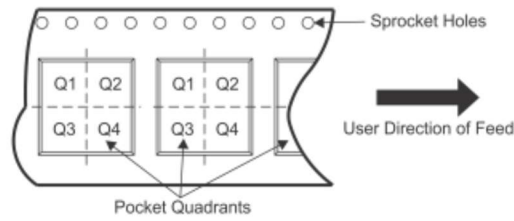

Figure 28 Part Markings

**TAPE AND REEL INFORMATION**

**QUADRANT ASSIGNMENTS FOR PIN 1 ORIENTATION IN TAPE**

**Table 10 Tape and Reel Dimensions**

Device	Package type	Pins	SPQ	Reel Diameter (mm)	Reel Width W1 (mm)	A0 (mm)	B0 (mm)	K0 (mm)	P1 (mm)	W (mm)	Pin1 Quadrant
SP6494C-LMR	LGA5x5	16	4000	330	12.4	5.35	5.35	1.5	8	12	Q1



## IMPORTANT NOTICE AND DISCLAIMER

SPIRIT SEMICONDUCTOR PROVIDES TECHNICAL SPECIFICATIONS AND RELIABILITY DATA (INCLUDING DATASHEETS), DESIGN RESOURCES (INCLUDING REFERENCE DESIGNS), APPLICATION OR OTHER DESIGN ADVICE, WEB TOOLS, SAFETY INFORMATION, AND OTHER RESOURCES “AS IS” AND WITH ALL FAULTS, AND DISCLAIMS ALL WARRANTIES, EXPRESS OR IMPLIED, INCLUDING, WITHOUT LIMITATION, ANY IMPLIED WARRANTIES OF MERCHANTABILITY, FITNESS FOR A PARTICULAR PURPOSE, OR NON-INFRINGEMENT OF THIRD PARTY INTELLECTUAL PROPERTY RIGHTS.

These resources are intended for developers skilled in the art designing with Spirit Semiconductor products. You are solely responsible for (1) selecting the appropriate products for your application, (2) designing, validating, and testing your application, and (3) ensuring your application meets applicable standards, and any other safety, security, or other requirements. These resources are subject to change without notice. Spirit Semiconductor grants you permission to use these resources only for development of an application that uses Spirit Semiconductor products. Other reproduction or use of these resources is strictly prohibited. No license is granted to any other Spirit Semiconductor intellectual property or to any third party intellectual property. Spirit Semiconductor disclaims responsibility for, and you will fully indemnify Spirit Semiconductor and its representatives against, any claims, damages, costs, losses, or liabilities arising out of your use of these resources. Spirit Semiconductor products are provided only subject to Spirit Semiconductor Terms and Conditions of Sale or other applicable terms agreed to in writing. No use of any Spirit Semiconductor resources expands or otherwise alters any applicable warranties or warranty disclaimers for these products.

### Contact Information

For more information visit  
[www.spiritsemiconductor.com](http://www.spiritsemiconductor.com)

For sales related information please send an email to [sales@spiritsemi.co.uk](mailto:sales@spiritsemi.co.uk)

### Trademarks

Spirit Semiconductor and Spirit Semiconductor Logo are trademarks of Semiconductor Limited. All referenced brands, product names, service names and trademarks are the property of their respective owners.