

FEATURES & BENEFITS

Created to the highest standard, Santa Fe Fauxwood shutters offer two ranges, Nevada & Hampton emulate the beauty of wood using hspvc. These meticulously crafted ranges are offered across our portfolio of shutter options: full-height, tier-on-tier, café style & track styles.



NEVADA

Santa Fe's Nevada, fauxwood shutters offer 4 blade sizes: 63mm, 76mm, 89mm & 114mm and are perfect solution for any room, especially areas of high moisture such as bathrooms and kitchens. The high quality PVC composition gives consumers the assurance that blades and frames will not warp, discolour or crack with the addition of a 10-year warranty. Santa Fe boasts a range of 9 colours.

HAMPTON

Santa Fe Hampton Shutters presents a range of fauxwood shutters handcrafted in the UK. Available in a wide choice of 18 colours, should you require your shutter be a specific tone, a custom colour service is also available.

Choose from 3 blade sizes; 63mm, 76mm & 89mm, these offer the perfect solution for any room, especially with high moisture content such as bathrooms and kitchens. The high quality PVC composition gives consumers the assurance that blades and frames will not warp, discolour or crack with the addition of a 10 year warranty. Hampton shutters offer an express lead time of 2 weeks*.

	FULL HEIGHT	TIER ON TIER	CAFE
NEVADA	✓	✓	✓
HAMPTON	✓	✓	✓

	BAY	TRACK	SHAPED
NEVADA	✓	✓	✓
HAMPTON	✓		

* Hampton Colours & custom colours will have a longer lead time of approx. 6-8 weeks.

SHUTTER STYLES

- **Full height**
Designed to dress the full-height of the window. A functional, yet stylish feature for any home. Also available with a mid-rail, enabling the shutter blades to be separated.
- **Café**
Ideal for rooms where total privacy is not required. Café style shutters are fitted to the lower section of the window.
- **Tier-on-tier**
Using two sets of shutters, each tier can be operated independently offering ultimate light control.
 - Tier on Tier shutters offer the optimal light and privacy control, however without the proper design tier on tier shutters will sag and perform improperly.
 - A horizontal T-post will eradicate the light gap and facilitate easier installation.
 - Tier on tier shutters must be designed so that the width of the panels are less than the height of the panels.
 - Tier on tier shutters must have a four sided frame.
 - There is a surcharge for tier on tier shutters.
- **Sliding Track**
The perfect solution for large windows, patio doors and room dividers. Shutter panels glide effortlessly across a discreet track system facilitating smooth operation. Available as bypass or bi-fold.
- **Shaped Shutters**
Santa Fe Shutters offers a wide range of shaped shutter options that can perfectly fit your window shape.

SHUTTER TERMS

- **Bi-fold**
Shutter panels where two panels are hinged together in order to fold up together.
- **Café frame**
A standard frame style where shutters cover the bottom half of the window and the top half are open. Café frames are available in 3-sided or 4-sided.
- **Divider rail**
A horizontal shutter panel component that separates a single panel into two or more sections that may be opened individually.
- **Tier on tier**
Shutter configuration where two panels or groups of panels are mounted separately so they can be opened independently from each other.
- **Frames**
Profiles used to frame the window opening, providing a mounting surface for the shutter panels. Frames can be mounted on the inside or outside of the window sill, depending on the frame style.
- **Inside mount**
For windows that are square, the frame is mounted or partially mounted inside the recessed portion of the window opening.
- **Louvre**
A solid profile that rotates for light and privacy control. Louvres are available in 63mm, 76mm, 89mm and 114mm widths. Hampton shutters are available in 63mm, 76mm and 89mm.
- **Mouse hole**
The rounded cut-out in the top shutter panel rail designed to fit the tilt rod. This hole allows complete closure of the louvres, providing a superior fit.
- **Outside mount**
A mounting method where the frame is mounted to the wall or outside casing of the window opening.
- **Rails: top & bottom**
The top and bottom horizontal framework of the shutter panel.
- **Reveal**
The distance between the innermost edge of an outside mount frame and the outside edge of the window opening.
- **Stile**
The vertical sides of the shutter panel.
- **Rabbet stile**
The vertical sides of the panels have a channel & groove which interconnects to the opposing stile giving optimum light control
- **Astragal stile**
The vertical sides of the shutter panel designed to cover the light-gap where two panels meet. A small lip offers superior light control.
- **T-posts & transom beams**
Profiles used for extra support within a frame system. T-posts are vertical supports and transom beams are horizontal supports.
- **Tilt rod**
The centre pole attached to the shutter panel louvres that rotates the louvres open or closed for light and privacy control.
- **Clear view**
The metal bracket on back of louvre (bracket side) giving you an unobstructed view through blades.

SHUTTER SPECIFICATION

	NEVADA	HAMPTON
Composition	Engineered PVC polyvinyl	Engineered PVC polyvinyl
Weight (m3)	600kg/m3	600kg/m3
Colour Option	9 Colours (Vivid white, Bright white, Silk white, White, Ecru, Phantom, Moonlit, Lunar & Armory)	Standard: 2 colours (Vivid white & Silk white) Hampton Colours: 16 spray painted colours, plus custom colour
Full Height	Yes	Yes
Tier on Tier	Additional Charge	Additional Charge
Café Style	Yes	Yes
Track Options	Yes	Yes
Special Shapes	Yes	No
Stile Profile	Butt, Rabbet and Astragal	Butt, Rabbet and Astragal
Louvre Width	63mm, 76mm, 89mm, 114mm	63mm, 76mm, 89mm
Stile Width	Standard: 50.8mm (beaded)	Standard: 50.8mm (beaded)
Stile Thickness	Beaded: 27mm	Beaded: 27mm
Divider Rail	1700mm (over 2400mm 2 mid rails required) (Panels over 1524mm high & 609mm wide require at least 1 mid rail)	1700mm
Divider Rail Widths	61mm	61mm
Rail Thickness	21mm	21mm
Minimum Panel Height	508mm	63mm - 391mm / 76mm - 420mm / 89mm - 440mm (excluding frames)
Maximum Panel Height	3000mm (panels over 1700mm require divider rail)	2500mm (panels over 1700mm require divider rail)
Tilt Rod	Centre, Clearview	Centre, Clearview
Panel Width (Min)	205mm all louvre sizes	210mm all louvre sizes
Single Panel Width (Max)	914mm	800mm
Max Panel Width per Hinged Shutter	2 panels @ 600mm	2 panels @ 600mm
Maximum width shutter without T-post	2057mm	2463mm
Maximum Width shutter with T-Posts	3500mm	3500mm
Tier on Tier with Horizontal T-post Minimum	1085mm (minimum height per panel 500mm)	966mm (minimum height per panel 500mm)
Tier on Tier with Horizontal T-post Maximum Height	3000mm	3000mm

Manufacturing Tolerance: +/- 2mm

SANTA FE NEVADA SHUTTERS

Solid

Shutters up to 1828mm high and single doors hinged.

Aluminium Reinforced

Shutters over 1829mm High and panels hinged together.

	HAMPTON SHUTTER WIDTH REFERENCE				
	Min Width	Max Width without T-post	Max Width with T-post	Min Height	Max Height
Full Height	266	2483	3500	447	1700
Full Height Mid-rail	266	2483	3500	-	2500
Cafe	266	2483	3500	422	1700
Tier on Tier	266	2483	3500	-	2500

OUR SHUTTER

FRONT VIEW OF LOUVRE SIZES

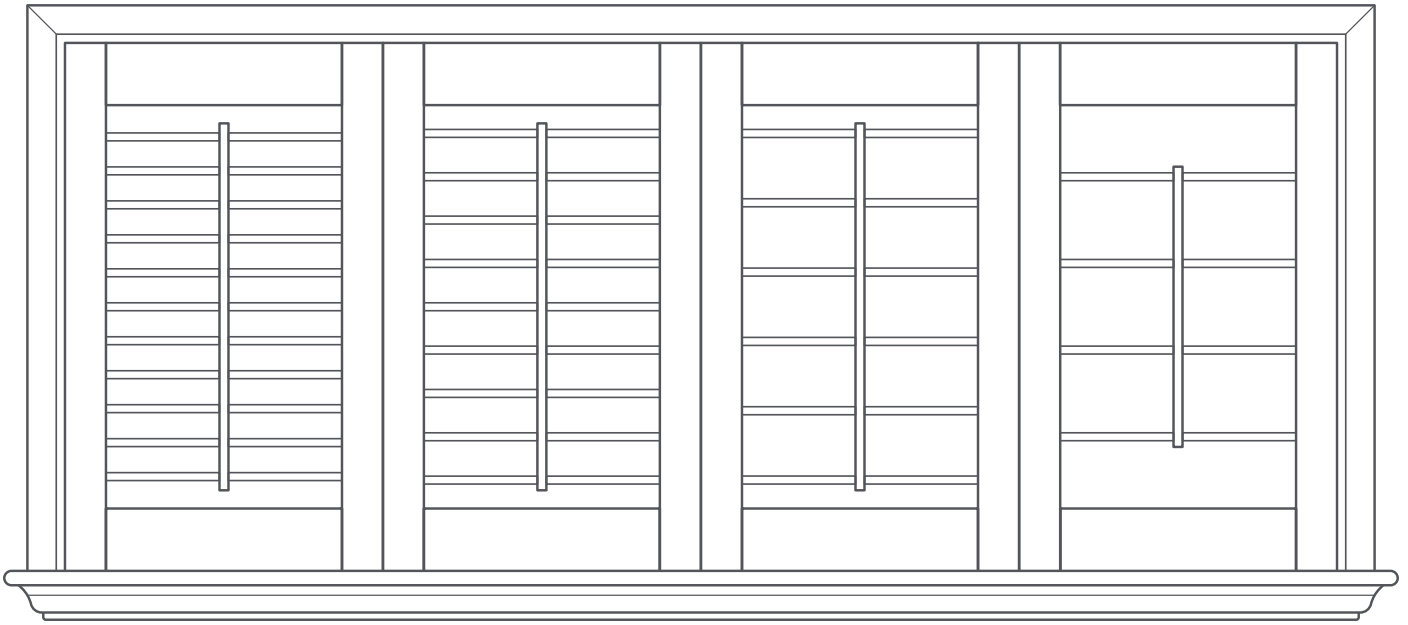

63MM

Nevada, Hampton

76MM

Nevada, Hampton

89MM

Nevada, Hampton

114MM

Nevada

AVAILABLE FITTING OPTIONS

- No Frame/ Panel only
Hinges only
- Hanging Strip (Not available in Hampton)
Standard, Adjustable
13mm (Mount Side by Side Only)
19mm (Mount Side by Side or Behind Panel)
- L Frames
- Z Frames (Inside Mount Only)
- Outside Mount Frames Only - Camber Deco

AVAILABLE LOUVRE SIZES

- 63mm
- 76mm
- 89mm
- 114mm (Not available in Hampton)

DIVIDER RAIL

- 61mm (Divider rail only)

TILT OPEN

- Centre
- Clearview

HAMPTON & NEVADA WARRANTY

WHAT IS COVERED IN THE WARRANTY

- Decora Blind Systems warrants to the original purchaser that each custom shutter product, properly installed and maintained in the window or door opening for which it was made, will be free from defects in materials and workmanship.
- There is a 10-year warranty for our Nevada and Hampton ranges.
- Any claims for incorrect or defective products must be brought to our attention within 10 days of receipt, and before shutters are altered in any manner or installation is attempted.
- If the product is found to be defective in material or workmanship under normal use, or products that do not meet our quality standards, Decora Blind Systems will, at its discretion, repair or replace any defective parts or components without charge, provided that the original purchaser ships the product to the designated repair facility.
- This warranty does not imply automatic replacement of any product from Decora Blind Systems.

WHAT IS NOT COVERED IN THE WARRANTY

- This warranty does not cover conditions or damages resulting from accidents, alterations, misuse, abuse, misapplication, fire, flood or other natural disasters, or failure to follow use, care of installation instructions.
- Decora Blind Systems will not be liable for any incurred costs, such as travel costs and time, nor for damages or loss to other property.

SANTA FE SHUTTER IMPERFECTIONS

- Santa Fe Shutters are manufactured to industry standards. Minor imperfections or blemishes not visible within 1 metre under natural lighting conditions are not considered defects.
- Nevada and Hampton which are PVC products will only be considered for repair, if there are any marks or any discolour visible from one metre from view.

HAMPTON & NEVADA ENERGY SAVING DATA

- Hampton and Nevada shutters have been tested for their thermal conduction properties. Tested in line with ASTM C518 - 2004 to determine the thermal transmission properties, by means of heat flow.
- Test results of 0.10035 certify minimal heat flow is conducted through the shutter, enhancing heat control within a room.





FAUXWOOD COMPONENTS

* All measurements in mm

LOUVRES - SOLID

*Dependant on shutter size
louvres may be reinforced for
stability

Hampton & Nevada



Hampton & Nevada

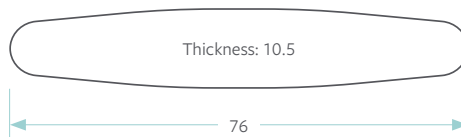

Hampton & Nevada



Nevada Only



STILE TYPES

* All measurements in mm

SOLID

50.8mm (Hampton & Nevada)



REINFORCED

50.8mm (Hampton & Nevada)

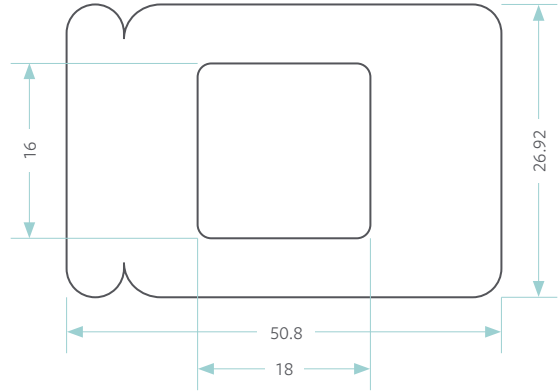

STANDARD RABBET STILE

50.8mm (Hampton & Nevada)



REINFORCED STANDARD RABBET STILE

50.8mm (Hampton & Nevada)

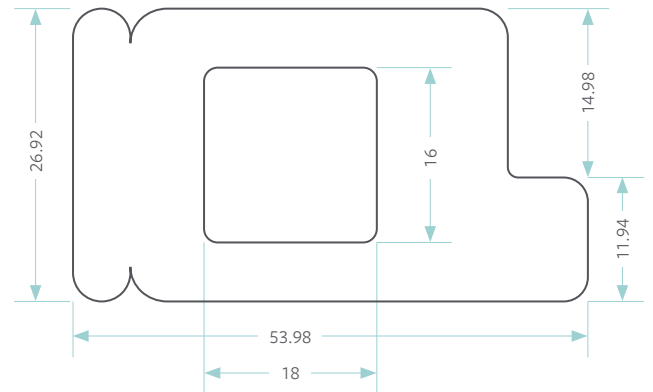

ASTRAGAL STILE

50.8mm (Hampton & Nevada)

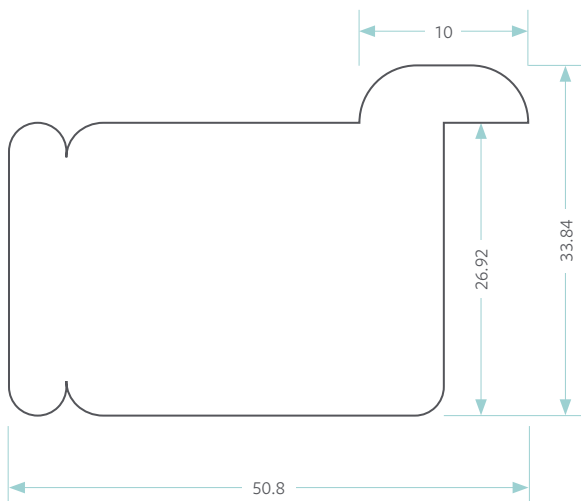

REINFORCED ASTRAGAL STILE

50.8mm (Hampton & Nevada)

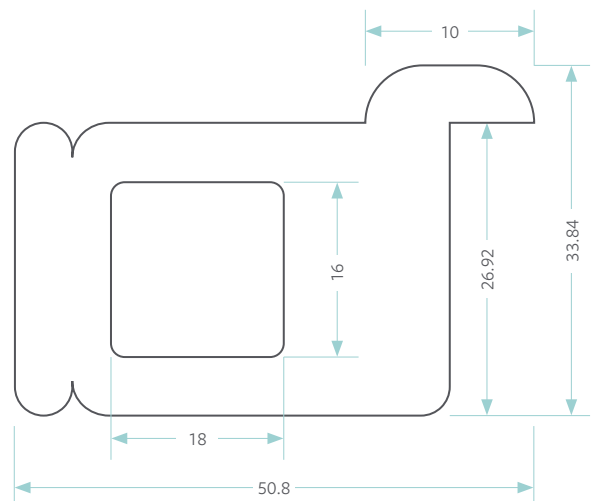



SHUTTER RAILS

(Hampton & Nevada)

* All measurements in mm

TOP/ BOTTOM RAIL

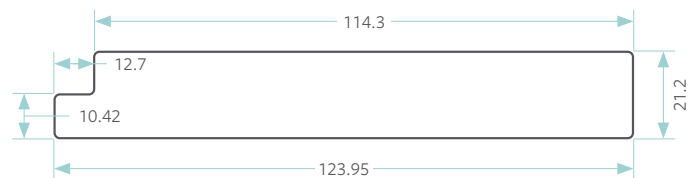

DIVIDER RAIL (61MM)

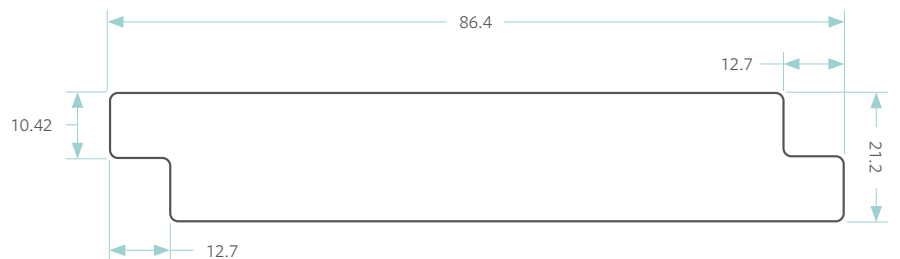

HANGING STRIP

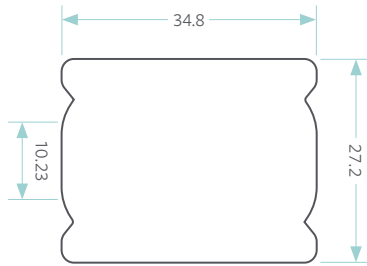

LIGHT BLOCK

(Hampton & Nevada)

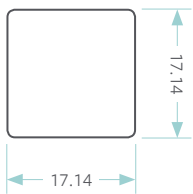

TILT ROD

(Hampton & Nevada)

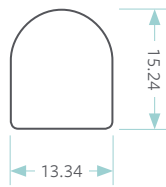

L FRAME CL10

(Hampton & Nevada)

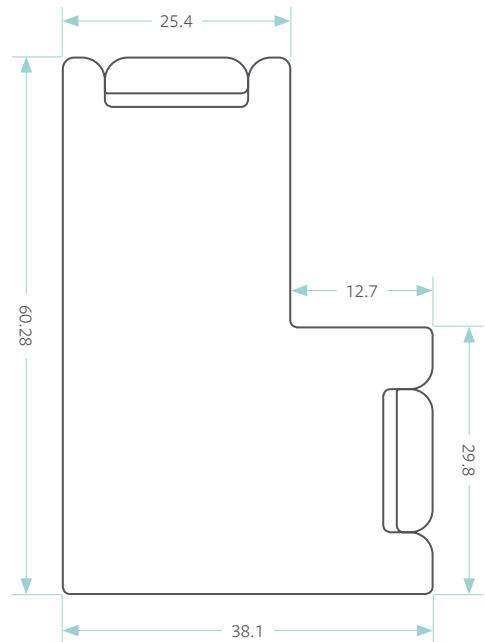

L FRAME SL10

(Nevada Only)

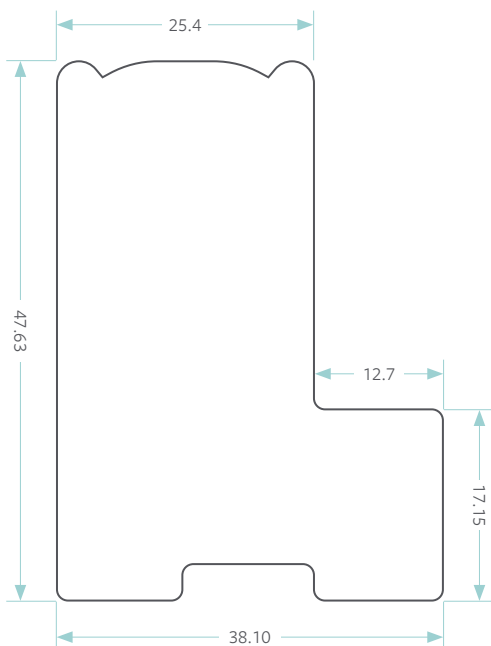

L FRAME FSL10

(Hampton & Nevada)

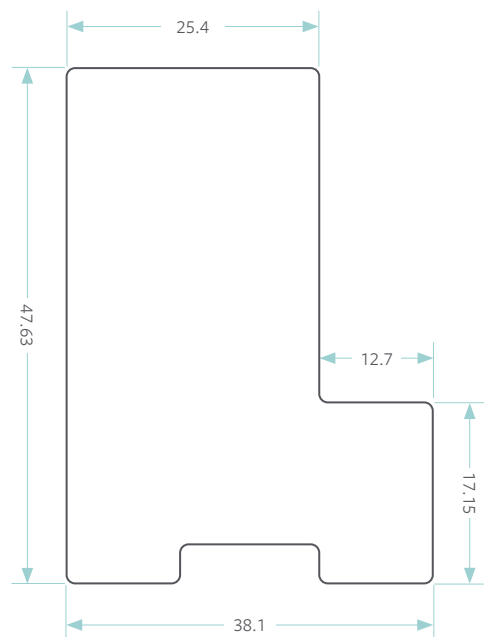

SHUTTER FRAMES

* All measurements in mm

ELEGANT Z FRAME (EZ30)

(Hampton & Nevada)

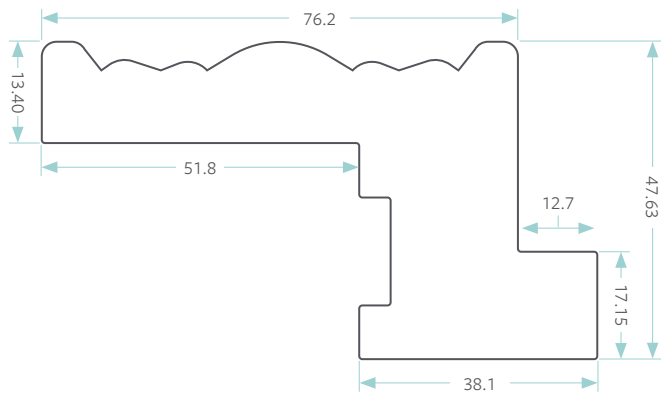

DELUXE Z FRAME (DZ25)

(Nevada Only)

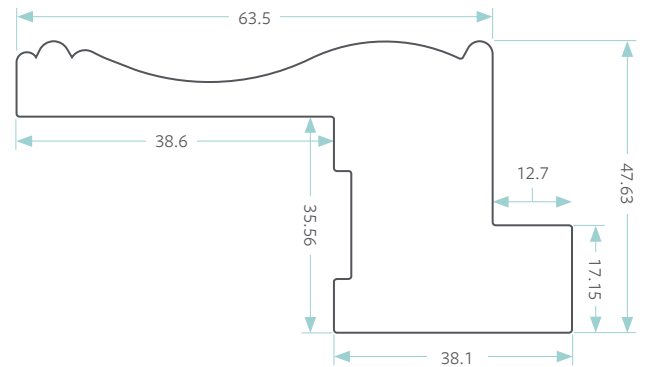

STANDARD Z FRAME (BZ17)

(Nevada Only)

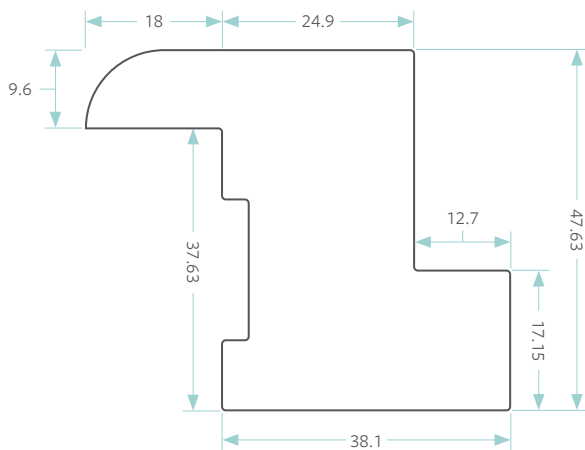

Z FRAME (CZ15)

(Hampton & Nevada)

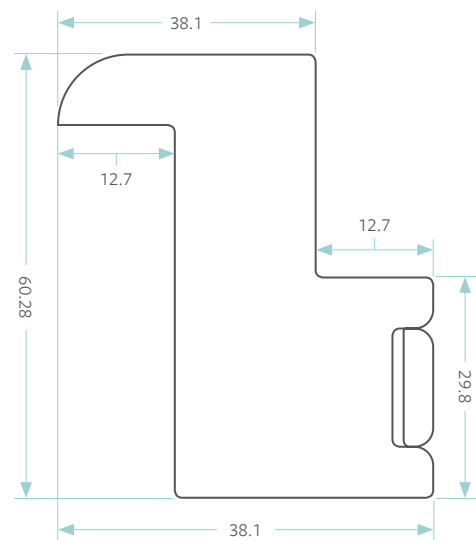

FLAT Z FRAME (FZ23)

(Hampton & Nevada)

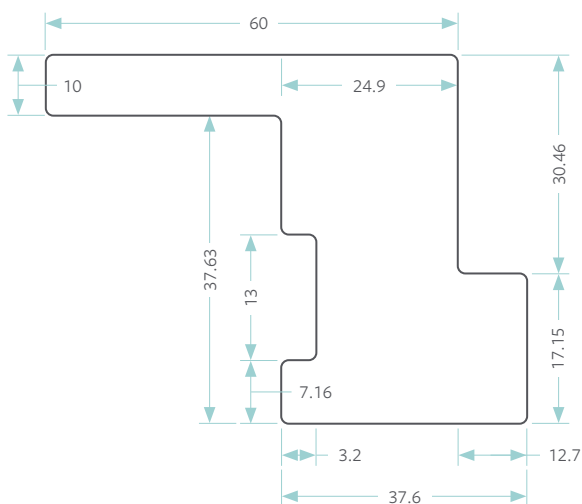

NEVADA & HAMPTON FRAME REFERENCE TABLE

FRAME	NEVADA	HAMPTON
SL10	✓	N/A
CL10	✓	✓
FSL10	✓	✓
CZ15	✓	✓
EZ30	✓	✓
DZ25	✓	N/A
BZ17	✓	N/A
FZ23	✓	✓
DF20	✓	✓
FLF88	✓	N/A

SHUTTER FRAMES

* All measurements in mm

SPECIAL RAIL - DECO FRAME DF20

69.85mm (Hampton & Nevada)

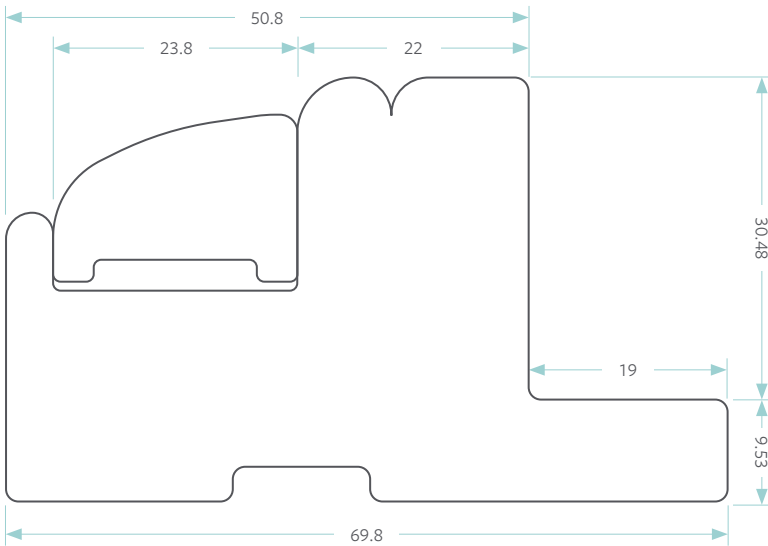

FRENCH DOOR L FRAME FLF88

22.225mm (Nevada Only)

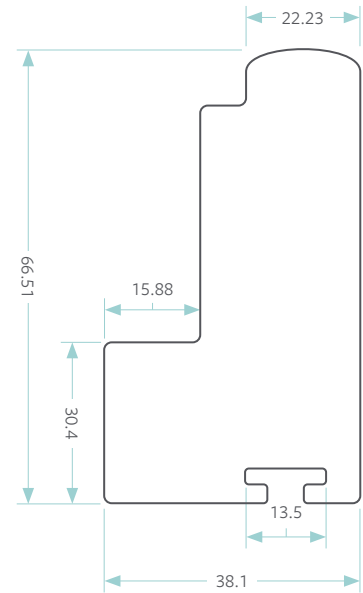

HOFFMAN KEYS

All frame mitres will be supplied pre-cut with a slot to accept a plastic Hoffman key. The Hoffman key will be attached to the end of the frame. This will allow for easy assembly of the frame prior to installation, and will hold the mitre together.

HINGES

Stainless Steel hinges and screws are 316-grade material; all other hinges and screws are mild steel with either a paint finish or electroplated finish. The quantity of hinges supplied will depend on the height of the shutter panel.

BATONS

Batons are available to order where recess/window frames is uneven.

One standard profile - 38 x 55mm. These can be made to bespoke sizes on request. Bespoke sizes will have at least 1 unpainted edge.

35 X 55MM BATON

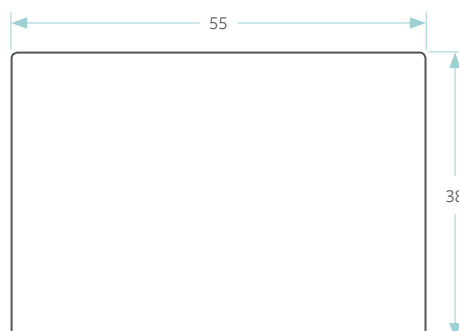

SHUTTER FRAMES

* All measurements in mm

T-POST (ST10)

25.40mm (Hampton & Nevada)

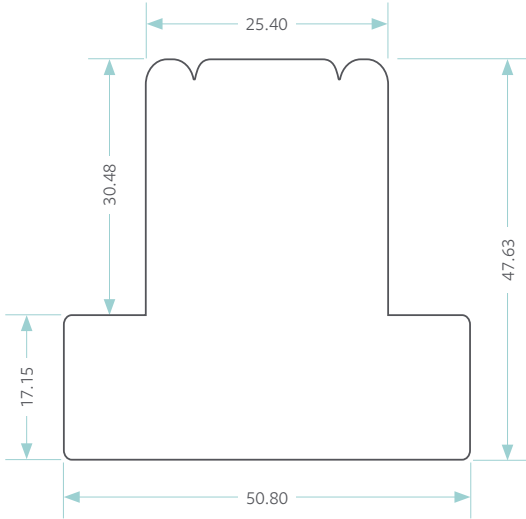

T-POST (ST20)

50.80mm (Nevada Only)

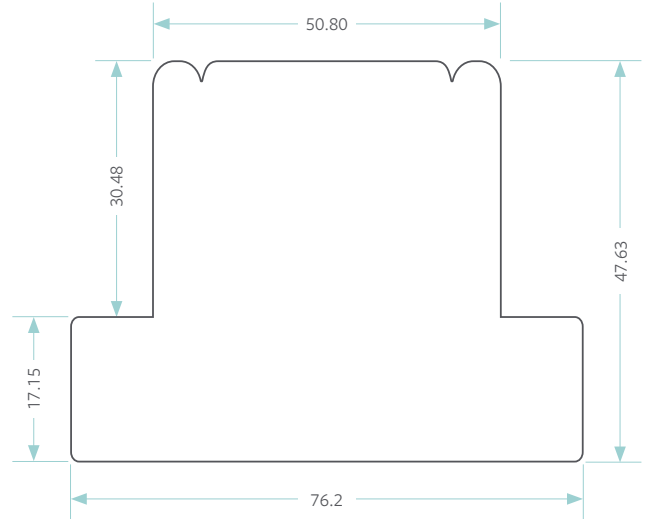

T-POST (FST10)

25mm (Hampton & Nevada)

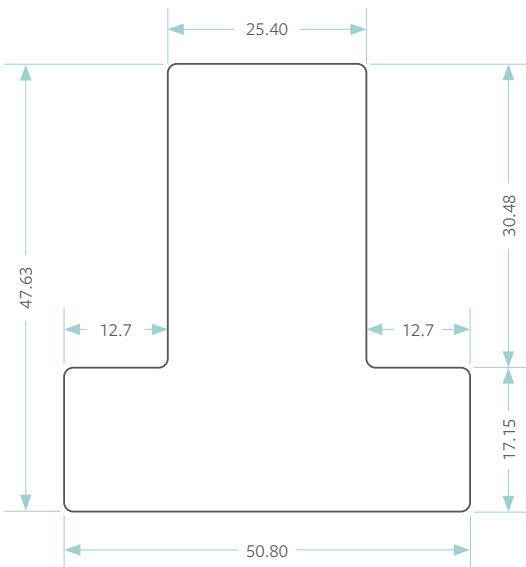

SHUTTER BAY POSTS

* All measurements in mm

135° CL10 BAY POST

(Nevada & Hampton)

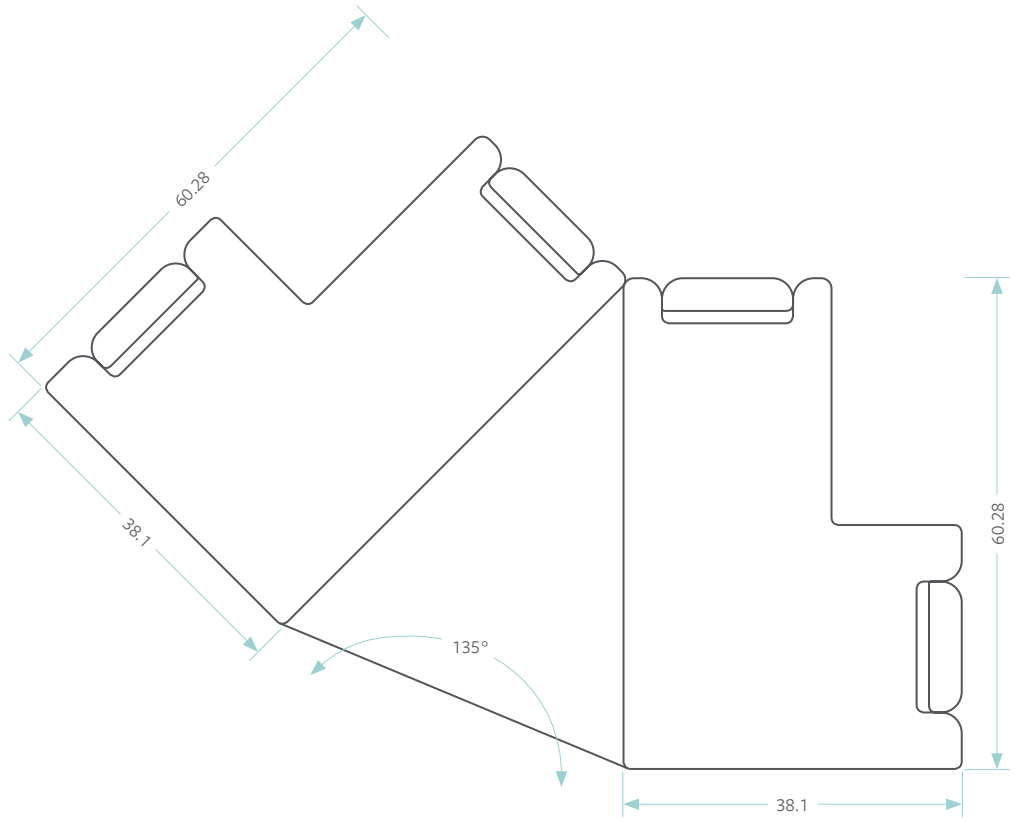

90° CL10 BAY POST

(Nevada & Hampton)

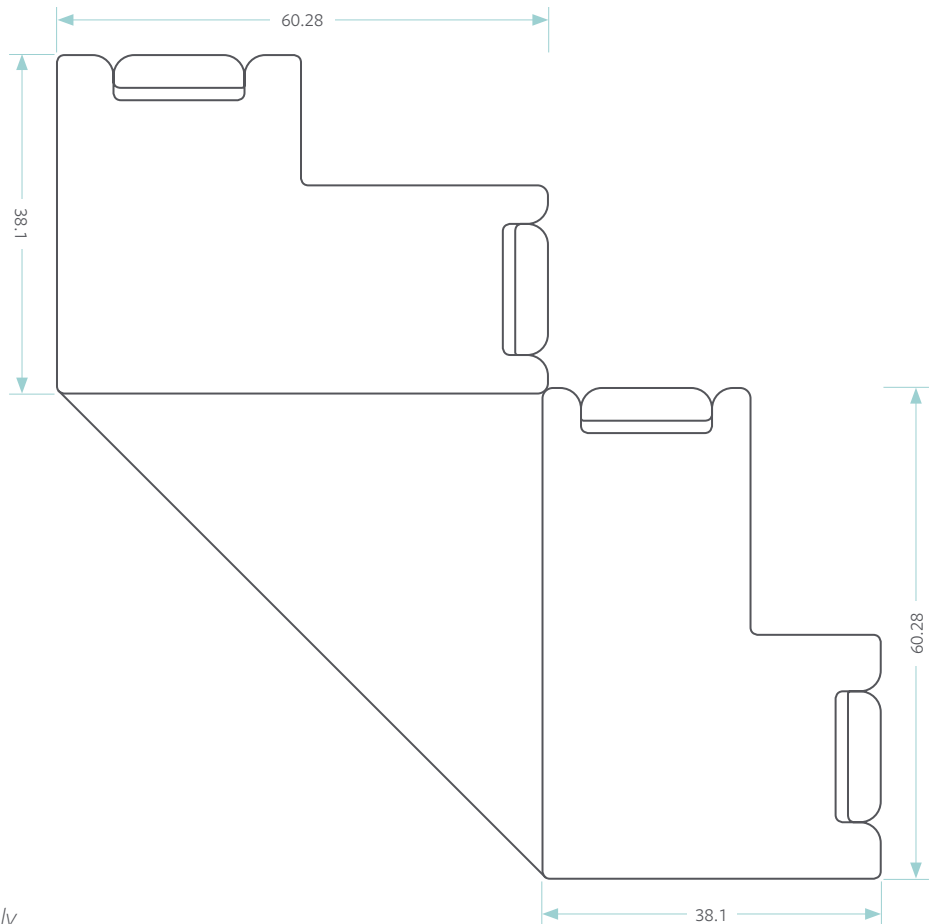

*Custom made angles available for Nevada only.

SHUTTER BAY POSTS

* All measurements in mm

135° SL10 BAY POST

(Nevada Only)

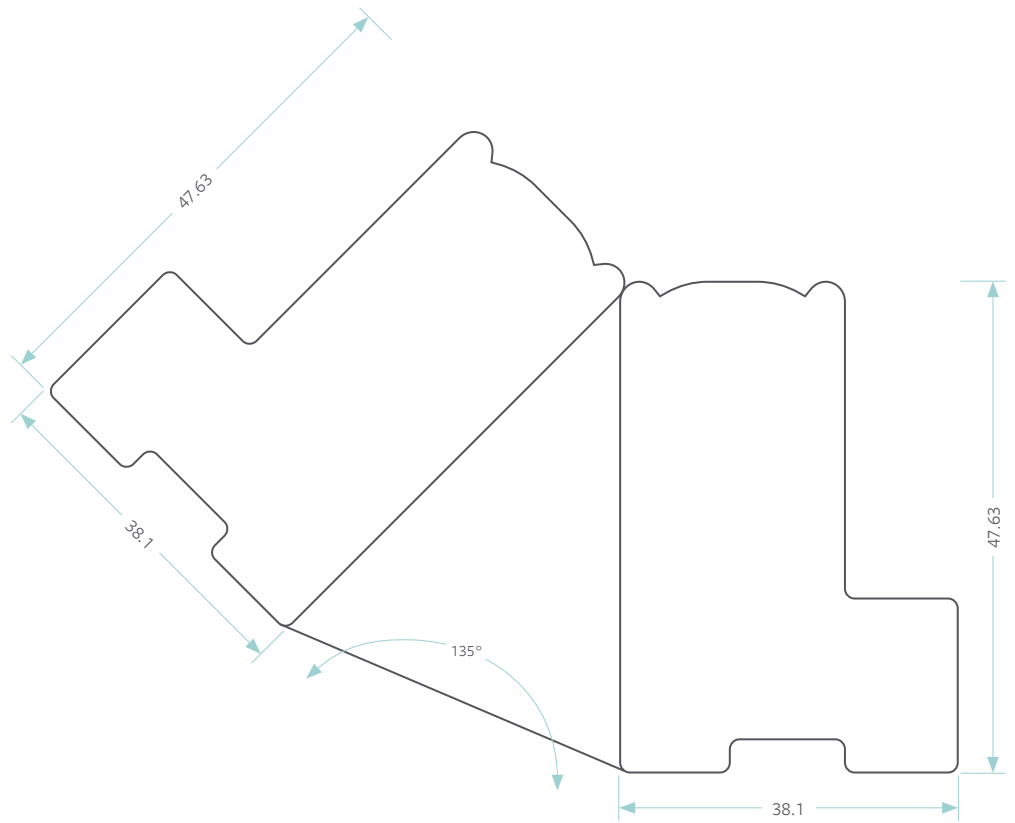

90° SL10 BAY POST

(Nevada Only)

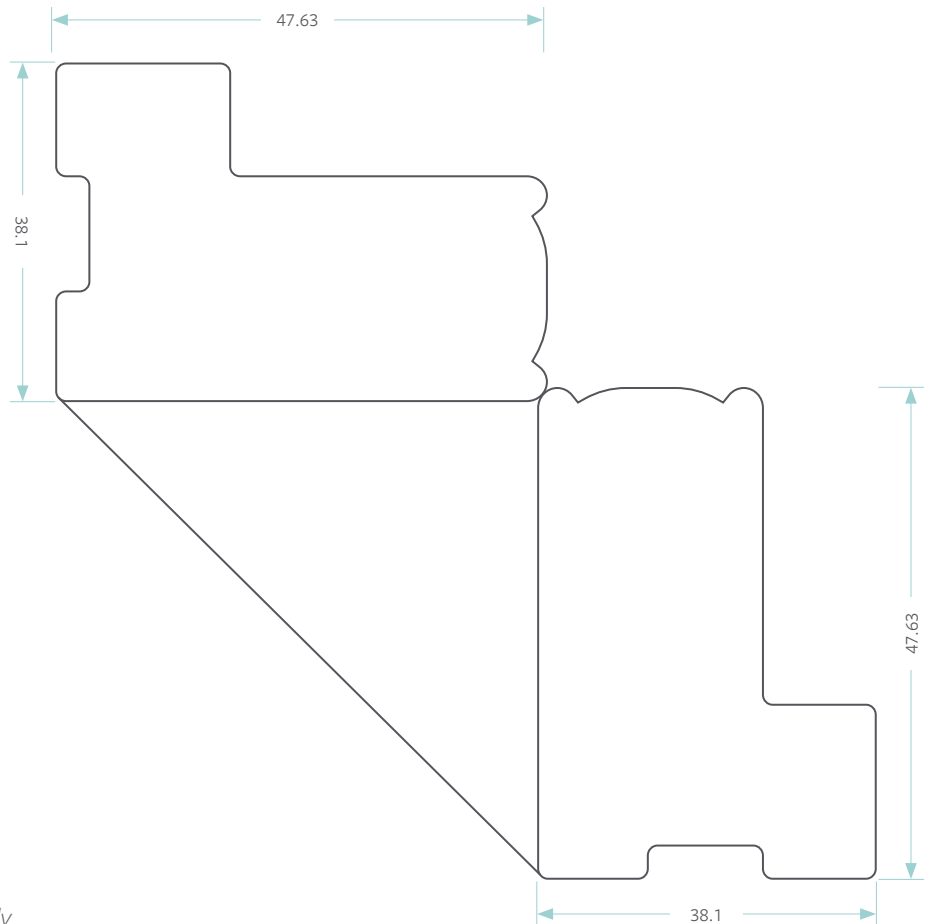

*Custom made angles available for Nevada only.

NON MORTICE HINGE

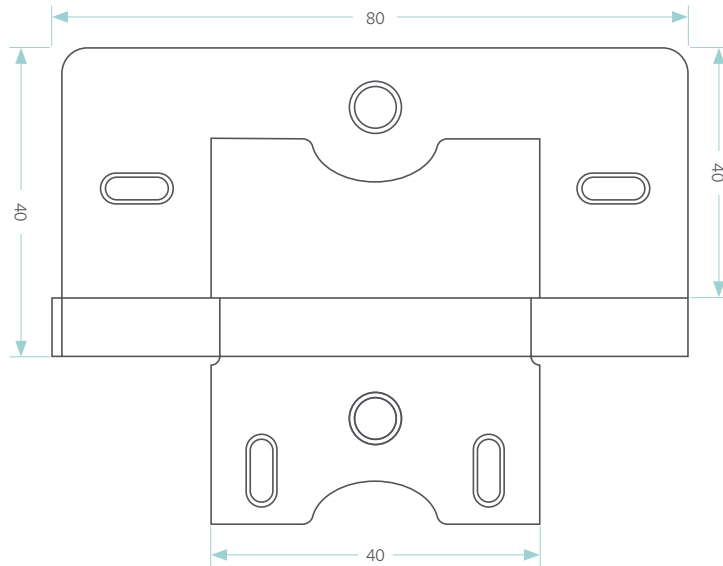

MAGNET & STRIKING PLATE

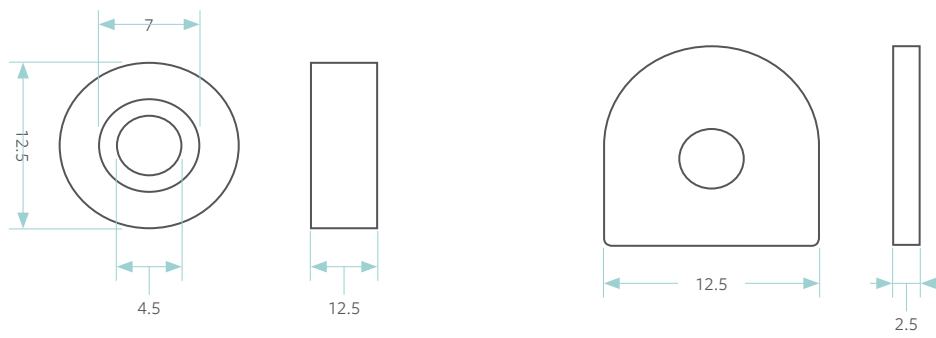

*Magnets are attached to the shutter panel. Striking plates are attached to the frame.

HARDWARE

HINGES COME IN 3 COLOURS

White, Cream & Stainless Steel

NEVADA - DEFAULT HINGE COLOURS

COLOUR	DEFAULT HINGE COLOUR	OTHER OPTIONS
Vivid White	White	Stainless Steel
Bright White	White	Stainless Steel
Silk White	White	Stainless Steel
White	White	Stainless Steel
Ecu	Cream	Stainless Steel
Phantom	Phantom	Stainless Steel
Moonlit	Moonlit	Stainless Steel
Lunar	Lunar	Stainless Steel
Armory	Armory	Stainless Steel

HAMPTON - DEFAULT HINGE COLOURS

COLOUR	DEFAULT HINGE COLOUR	OTHER OPTIONS
Vivid White	White	Stainless Steel
Silk White	White	Stainless Steel
Hampton Colours	Stainless Steel	N/A
Custom Colours	Stainless Steel	N/A

HINGE MINIMUM REQUIREMENTS

PANEL HEIGHT	HINGE QUANTITY
Up to 1117mm	2
1118mm to 1829mm	3
1830mm to 2438mm	4
Over 2438mm	5

STYLE PORTFOLIO (NEVADA ONLY)

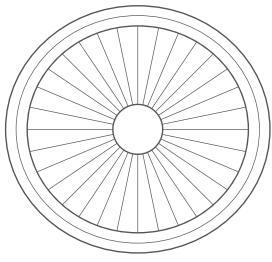

Circle Sunburst

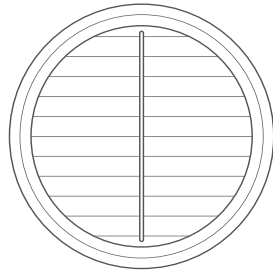

Circle with Horizontal Louvre

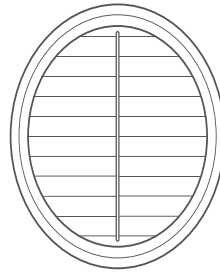

Oval with Horizontal Louvre

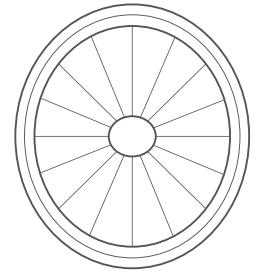

Oval Sunburst

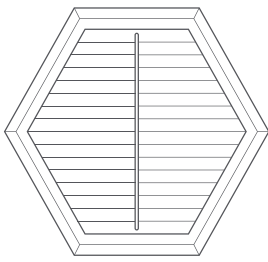

Octagon

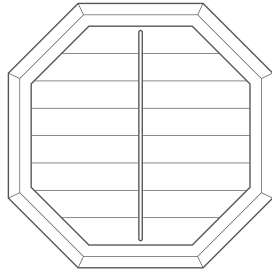

Hexagon Straight Top

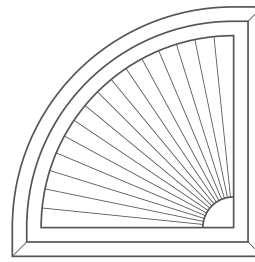

Left Quarter Round Sunburst

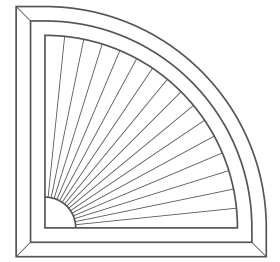

Right Quarter Round Sunburst

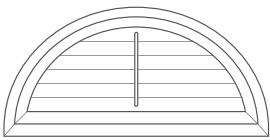

Sunburst with Horizontal Louvre

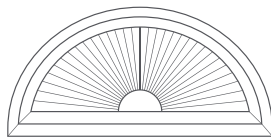

Half Round Sunburst

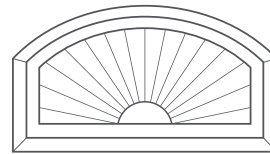

Elongated Eyebrow Sunburst

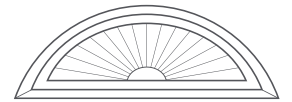

Eyebrow Sunburst

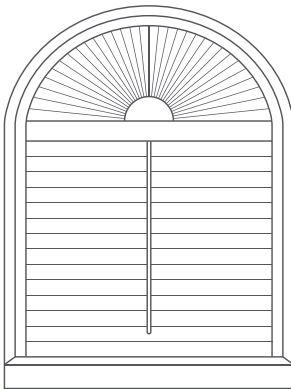

Sunburst Panel with Frame

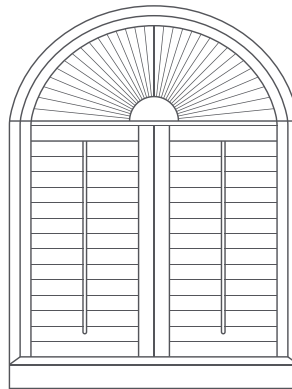

Sunburst at top with Divider Strip

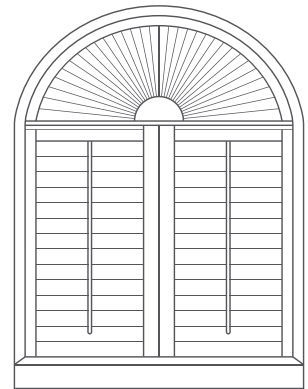

Sunburst at top with T - post

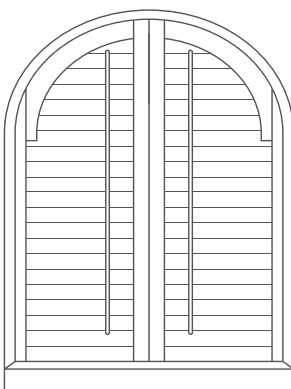

Multi Panel Arch

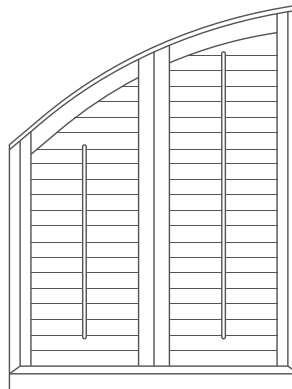

Eyebrow Arch

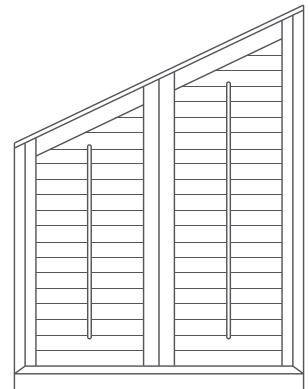

Racked

STYLE PORTFOLIO (NEVADA ONLY)

ARCH SHUTTER

(Note for Arch Shutters: The upper Arch part's height cannot be greater than half of width)

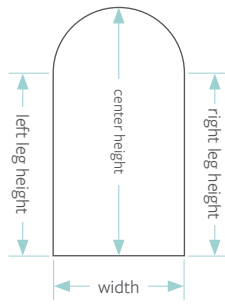

FULL ARCH

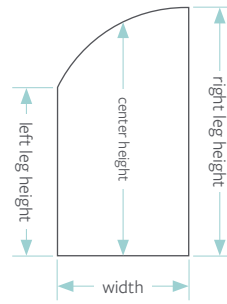

HALF ARCH LEFT

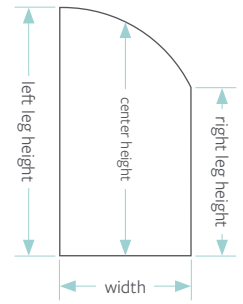

HALF ARCH RIGHT

RAKE SHUTTER

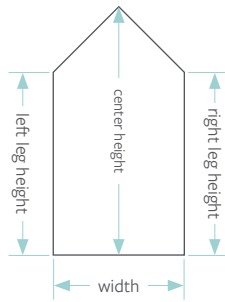

FULL RAKE

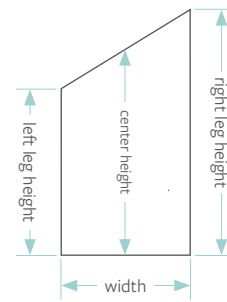

HALF RAKE LEFT

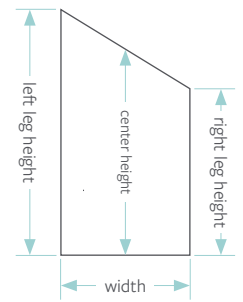

HALF RAKE RIGHT

SUNBURST

(Note for Sunburst: The Arch's height cannot be greater than half of width)

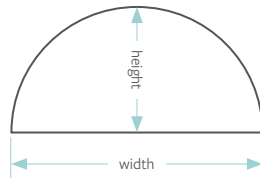

CIRCLE

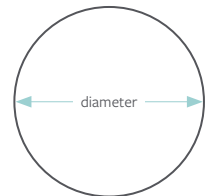

FRENCH DOOR

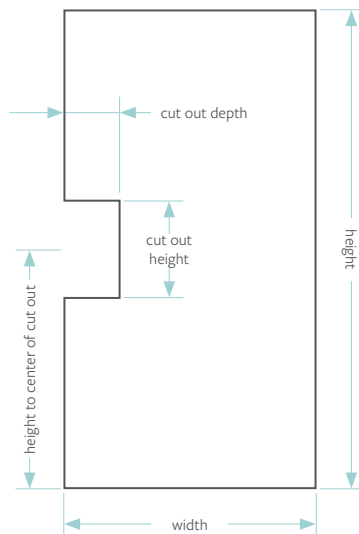

FRENCH DOOR (No Plate)

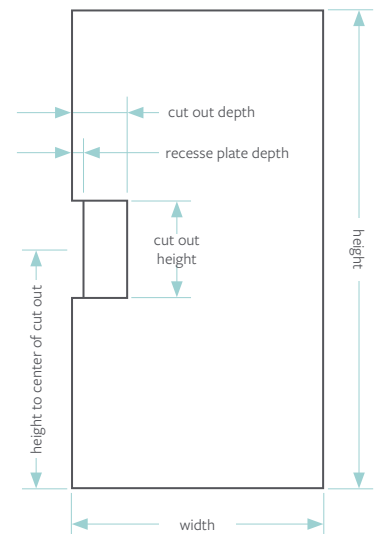

FRENCH DOOR

TERMS & CONDITIONS

1. Buyer/Seller

- 1.1 In these conditions “the Seller” means Santa Fe Shutters and “The Buyer” means the person, firm or company placing an order for goods or services, which are subject to these terms and conditions which are not variable except in writing signed by the Seller.
- 1.2 These conditions of sale together with the particulars contained in the order acceptance save where stated otherwise and any special conditions agreed by the Seller in writing constitute the entire contract between the Buyer and the Seller.
- 1.3 Periods of time referred to in these conditions of sale shall be of the essence.

2. Quotation

- 2.1 All quotations by the Seller represent an invitation to the Buyer to place an order and do not constitute a legal offer. The purchase order will be regarded as the offer and the Seller’s order acceptance will be regarded as binding. No alternative terms and conditions will be considered or accepted by the Seller.
- 2.2 All prices are quoted without commitment and are subject to alteration or withdrawal by the Seller without prior notice. Orders can be accepted on the condition that the prices charged are those ruling at the date of order unless the Seller specifically agrees in writing to engage a fixed price contract.

3. Delivery

- 3.1 Delivery times are estimates only and not of the essence. Whilst every effort is made to ensure due performance, the Seller cannot accept responsibility for damages or consequential loss or damage arising out of delay or failure to deliver by the specified date.
- 3.2 If a Buyer fails to take delivery of the goods or any part of them on the due date for any reason whatsoever the Seller will be entitled to charge for re-delivery and upon notice to the Buyer delivery will be deemed to have taken place and the Buyer will pay to the Seller all costs and expenses including storage and insurance charges. Any delay or failure to deliver by the Seller will not entitle the Buyer to refuse delivery or to repudiate the contract and the full price will be payable to the Seller without deduction.
- 3.3 Non delivery or damage pilferage in transit must be reported in writing to the Seller within 5 days of receipt of invoice or advice of despatch. Where goods are collected from the Seller by the Buyer or a third party nominated by the Buyer the risk in goods passes to the Buyer upon delivery to the Buyer or such third party. Thereupon liability of the Seller in the goods for loss or deduction, breakages, shortages or non delivery shall cease.
- 3.4 The address for delivery shall be the Buyer’s address as stated on the order unless otherwise stated between the parties in writing.
- 3.5 Once the goods are delivered and signed for either in good condition or unchecked, the Seller cannot accept responsibility for any damage to said property.

4. Retention of Title

- 4.1 The goods shall remain the property of the Seller until full payment has been received (each order being considered as whole).
- 4.2 The Buyers right to possession of the goods will cease at the earliest of the following date:
 - 4.2.1 On expiration of any agreed period of credit, or due date for payment of any invoice has passed.
 - 4.2.2 If being an individual he commits an act of bankruptcy or makes a proposal to his creditors or does anything which would entitle a petition for a bankruptcy order to be made, or the Seller believes on reasonable grounds that the same is likely to occur.
 - 4.2.3 If being a company it goes into liquidation or does anything or fails to do anything which would entitle a receiver to take possession of any assets or which would entitle any person to present a petition for winding up or to apply for an Administration order, or the Seller believes on reasonable grounds that the same is likely to occur.
The Seller will have the right if paragraphs 4.1 applies:
To repossess the goods
To use or sell all or any of the goods
To enter any premises of the Buyer, for the aforesaid purposes

7. Payment Terms

- 7.1 Payment terms apply. A deposit of 50% of the total cost must be paid to Santa Fe Shutters at the time of placing the order. This is non-refundable. The remainder of the payment must be made in full on final installation of the shutters.
- 7.2 Hampton shutter orders, for pro-forma customers, 100% payment must be paid at time of placing the order. This is non-refundable

TERMS & CONDITIONS

7.3 Credit facilities are available on request. Terms and conditions of the credit provider will apply.

8. Returns

8.1 Any defective good must be notified within 5 days of being delivered/installed. Good delivered and signed for in “perfect condition” cannot be returned.

9. Liability

- 9.1 All goods should be carefully inspected prior to installation. The Buyer must check that the shutters, the frames and ancillary fittings including operation method are in accordance with the purchase order both for colour and design prior to installation. The Seller cannot accept any responsibility in circumstances where the Buyer is not present at the delivery/ installation address.
- 9.2 The Buyer must check that shutters are to colour sample prior to installation. The Seller cannot guarantee precise colour matching against samples; most of our products are made from natural materials. Minor imperfections not readily apparent at a distance of 1200mm under ordinary light will not be accepted as defects. Colour matching of finishing products (e.g. paints and stains) cannot be guaranteed although every reasonable effort will be made to ensure the accuracy of the finished product.
- 9.3 The Seller cannot guarantee the goods against fading or darkening especially as a result of exposure to sunlight where fading or darkening may occur. Santa Fe Shutters are not guaranteed against extreme damp or variable conditions.
- 9.4 The Seller reserves the right to withdraw any products and colours at any time without prior notice and cannot be held responsible for any consequences, caused by the withdrawal of such products.
- 9.5 Under no circumstances, except in respect of death or personal injury caused by the Sellers negligence does the Seller accept liability for consequential loss, damage or costs or expenses, howsoever arising and any liability for any such consequential loss is hereby specifically excluded. Should a claim be made the Sellers liability is limited to the value of the order placed by the Buyer.
- 9.6 The Seller gives no warranty as to the fitness of the product supplied for any other purpose other than that of an internal window dressing as surveyed by the company; other installation and uses are the risk of the Buyer.
- 9.7 Tolerance levels of overall panel specifications are plus or minus 2mm, and the product will not be considered defective if falling within the size range. Warp on any component part, vertical or horizontal, shall not exceed 2mm per lineal metre and shall not be considered defective if within this tolerance.
- 9.8 Limitations. It is recommended that panels be ordered within our normal size range. For example, panels above 1220mm in height are ordered with a divider rail, and that panel widths do not exceed 660mm for Basswood shutters or 600mm for faux wood shutters. We may exceed the limitation at your request, but in doing so we cannot accept responsibility for any problems that result.
- 9.9 If the Buyer is not on site when property is surveyed or installed the shutters will be fitted in accordance to our standard practices unless agreed prior to confirmation. If the Buyer chooses to install against our recommendation then liability will be theirs.
- 9.10 Upon installation the Seller shall not be responsible for the moving or the relocation of any electrical wiring which may be obstructing any installation process. It is the responsibility of the Buyer to relocate any electrical wiring and leave a clear opening before installation can proceed.
- 9.11 The Seller shall order in accordance with the Buyer’s Order Acceptance. As soon as the Seller has placed the Buyer’s order, Order Acceptance shall become binding in the Buyer’s choice of product, design option, colour etc. Any alteration that the Buyer wishes to make will incur the re-ordering and therefore shall be at the expense of the buyer.
- 9.12 If installers are paid by the Buyer the Seller cannot except liability for any damage or defective installation.. The foregoing is in substitution for all other terms, express or implied relating to the quality or fitness for purpose, and all such terms are hereby excluded. This does not, however, affect the consumer’s statutory rights.