

# greenworks®

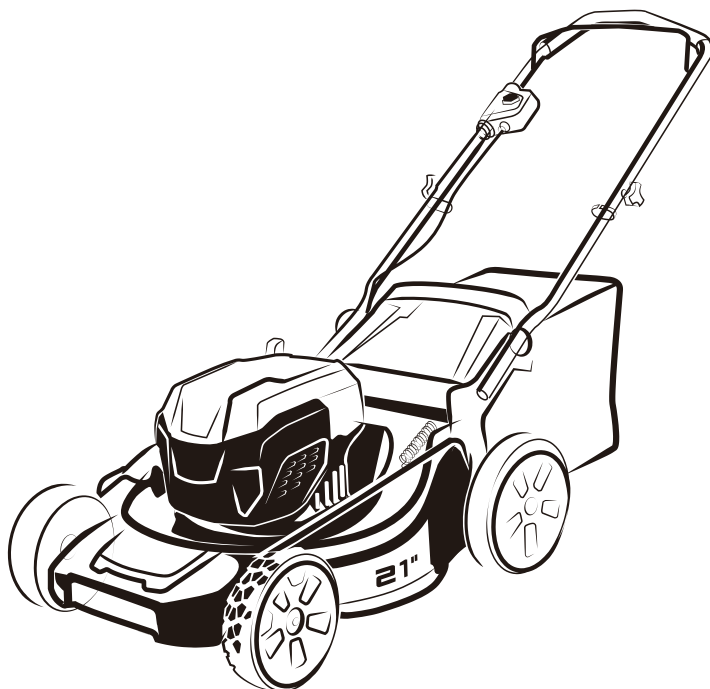

EN	MOWER	OPERATOR MANUAL
FR	TONDEUSE	MANUEL D'UTILISATION
ES	CORTACÉSPED	MANUAL DEL OPERADOR



**LME456**

<b>1</b>	<b>Description.....</b>	<b>4</b>	7.6	Install the side discharge chute.....	8
1.1	Purpose.....	4	7.7	Set the blade height.....	8
1.2	Overview.....	4	7.8	Install the battery pack.....	8
<b>2</b>	<b>Read all instructions.....</b>	<b>4</b>	7.9	Remove the battery pack.....	9
2.1	Children and Bystanders.....	4	<b>8</b>	<b>Operation.....</b>	<b>9</b>
2.2	General Operation.....	4	8.1	Start the machine.....	9
2.3	Slope Operation.....	5	8.2	Stop the machine.....	9
2.4	Service/Maintenance.....	5	8.3	Empty the grass catcher.....	9
<b>3</b>	<b>Symbols on the product.....</b>	<b>6</b>	8.4	Operate on slopes.....	9
<b>4</b>	<b>Risk levels.....</b>	<b>6</b>	8.5	Operation tips.....	9
<b>5</b>	<b>Environmentally safe battery disposal.....</b>	<b>7</b>	<b>9</b>	<b>Maintenance.....</b>	<b>10</b>
<b>6</b>	<b>Proposition 65.....</b>	<b>7</b>	9.1	General maintenance.....	10
<b>7</b>	<b>Installation.....</b>	<b>7</b>	9.2	Replace the blade.....	10
7.1	Unpack the machine.....	8	9.3	Store the machine.....	10
7.2	Unfold the lower handle.....	8	9.4	Stand the machine on end.....	10
7.3	Install the upper handle .....	8	<b>10</b>	<b>Troubleshooting.....</b>	<b>10</b>
7.4	Install the grass catcher.....	8	<b>11</b>	<b>Technical data.....</b>	<b>11</b>
7.5	Install the mulch plug.....	8	<b>12</b>	<b>Limited warranty.....</b>	<b>11</b>
			<b>13</b>	<b>Exploded view.....</b>	<b>13</b>

## 1 DESCRIPTION

### 1.1 PURPOSE

This machine is used for domestic lawn mowing. The cutting blade must be approximately parallel to the ground. All four wheels must touch the ground while you mow.

### 1.2 OVERVIEW

Figure 1-11.

- 1 Handle knob
- 2 Lower handle
- 3 Upper handle
- 4 Knob
- 5 Bolt
- 6 Grass catcher
- 7 Rear discharge door
- 8 Mulch plug
- 9 Side discharge chute
- 10 Side discharge door
- 11 Height adjustment lever
- 12 Battery door
- 13 Battery pack
- 14 Safety key
- 15 Battery release button
- 16 Start button
- 17 Bail switch
- 18 Storage switch

## 2 READ ALL INSTRUCTIONS

### ▲ DANGER

This machine was built to be operated according to the rules for safe operation included in this manual. As with any type of power equipment, carelessness or error on the part of the operator can result in serious injury. This machine is capable of amputating hands and feet and throwing objects. Failure to observe all safety instructions could result in serious injury or death.

### i NOTE

When using electric lawn mowers, basic safety precautions should always be followed to reduce the risk of fire, electric shock, and personal injury. These basic precautions include the following:

### 2.1 CHILDREN AND BYSTANDERS

Tragic accidents can occur if the operator is not alert to the presence of children or bystanders.

- Keep the area of operation clear of all persons, particularly small children, and pets.
- Use extreme care when approaching blind corners, doorways, shrubs, trees, or other objects that may obscure your vision of a child or bystander. Keep children, bystanders, helpers and pets at least 100 feet (30m) from the mower while it is in operation. Stop the machine if anyone enters the area.
- Never allow children under 14 years old to operate a power mower. Operators 14 years old and over should fully read and understand the operator's manual and safety rules. Only responsible individuals who are familiar with these rules of safe operation should be allowed to use this machine.

### 2.2 GENERAL OPERATION

- Read this operator's manual carefully in its entirety before assembling or operating this machine. Read, understand, and follow all instructions on the machine and in the manuals before operation. Familiarize yourself with the controls and proper use of this machine before operation. Save this manual for future and regular reference.
- Do not use the lawn mower for any job except that for which it is intended. Your lawn mower has been designed to perform only one job: cut grass.
- Don't force the lawn mower, it will do the job better and more safely at the rate for which it was designed.
- Don't overreach, keep proper footing and balance at all times. Many injuries occur as a result of the mower being pulled over the foot during a fall caused by slipping or tripping. A slip and fall can cause serious personal injury. If you feel you are losing your footing, release the control handle immediately and the blade will stop rotating within three seconds.
- Never pull the mower back toward you while you are walking. If you must back the mower away from a wall or obstruction, first look down and behind you to avoid tripping, and then follow these steps:
  - Step back from the mower in order to fully extend your arms.
  - Be sure that you are well balanced.
  - Pull the mower back slowly.
- Before and while moving backwards with the mower, look behind and down for small children and other people.
- Do not operate the mower while under the influence of alcohol or drugs. Stay alert and watch what you are doing at all times. Use common sense and do not operate the lawn mower when you are tired.
- Always wear safety glasses or safety goggles during operation and while performing an adjustment or repair to protect your eyes. Thrown objects that ricochet can cause serious injury to the eyes.

Always use a face or dust mask if the operation is dusty.

- Keep clear of the discharge opening at all times. Do not put hands or feet near rotating parts or under the cutting deck. Contact with the blade can amputate hands and feet.
- Plan your mowing pattern to avoid discharge of material toward roads, sidewalks, bystanders and the like. Also, avoid discharging material against walls or obstructions, which may cause discharged material to ricochet back toward the operator.
- To help avoid the blade or an injury from a thrown object, stay in the operator zone behind the handles.
- A missing or damaged discharge cover can cause blade contact or injuries from thrown objects.
- Objects struck by the lawn mower blade can cause severe injuries to persons. The lawn should always be carefully examined and cleared of all objects prior to each mowing.
- Stop the blade when crossing gravel drives, walks or roads.
- If lawn mower strikes a foreign object, follow these steps:
  - Release the bail switch to disengage the motor.
  - Remove the battery.
  - Inspect for damage.
  - Repair any damaged parts before restarting and operating the lawn mower.
- Dress properly, do not wear loose clothing or jewelry that can be caught in moving parts. Use of safety gloves and proper footwear is recommended when working outdoors. Wear sturdy, rough-soled work shoes and close-fitting slacks and shirts. Shirts and pants that cover the arms and legs and steel-toed shoes are recommended. Never operate this machine in bare feet, sandals, slippery or lightweight (e.g., canvas) shoes.
- Avoid dangerous environments, do not use the lawn mower in damp/wet locations or if it is raining.
- When not in use the mower should be stored in a dry and locked location. Always remove the battery from the mower before storing.
- Mow only in daylight or good artificial light. Walk, never run while operating.
- If the equipment should start to vibrate abnormally, immediately stop the motor, remove the battery and check for the cause. Vibration is generally a warning that the machine is not functioning properly.
- Before cleaning the machine, unclogging or removing the grass bag, mulching insert, or side discharge chute, turn the motor off and wait until the blade comes to a complete stop, then remove the battery pack. The cutting blade continues to rotate for a few seconds after the motor is shut off. Never perform these functions until you are sure the blade has stopped rotating.

- Keep cutting edges clean and sharp to ensure best performance.
- Periodically inspect safety devices and cords for damage. If damaged do not operate the unit until it has been repaired by an authorized service professional.
- Never operate the mower without the proper discharge cover, grass bag, mulching insert, side discharge chute, or other safety devices in place and working. Never operate the mower with damaged safety devices. Failure to do so can result in personal injury.
- Use only approved batteries and chargers. Non approved batteries and chargers may cause damage to the mower or injure the operator.
- Do not dispose of the battery in a fire. The cells could catch fire or explode. Check with local codes and waste management for proper disposal instructions.
- Do not open or mutilate the battery. Electrolytes contained within the battery are corrosive and may cause damage to eyes or skin if released. It may be toxic if swallowed.
- Exercise care in handling batteries to avoid shorting the battery with conducting materials such as rings, bracelets, keys, etc. The battery or conductor may overheat and cause burns if contact with said materials is made.

## 2.3 SLOPE OPERATION

Slopes are a major factor related to slip-and-fall accidents, which can result in severe injury. Operation on slopes requires extra caution. If you feel uneasy on a slope, do not mow it.

Do:

- Mow across the face of slopes; never mow up and down. Exercise extreme caution when changing direction on slopes.
- Watch for holes, ruts, rocks, hidden objects, or bumps which can cause you to slip or trip. Tall grass can hide obstacles.

Do not:

- Do not mow near drop-offs, ditches or embankments; you could lose your footing or balance.
- Do not mow slopes greater than 15 degrees, as shown on the slope gauge.
- Do not mow on wet grass. Unstable footing could cause slipping.

## 2.4 SERVICE/MAINTENANCE











- Keep all nuts, bolts, and screws tight in order to ensure the equipment is in safe working condition.

- Never remove or tamper with safety devices. Check their proper operation regularly. Never do anything to interfere with the intended function of a safety device or to reduce the protection provided by a safety device.
- Keep machine free of grass, leaves, or other debris build up. Allow machine to cool before storing.
- Never make any adjustments or repairs with the motor running.
- Always remove battery pack from mowers before adjusting, cleaning, or repairing.
- Check grass catcher components and the discharge guard frequently and replace with manufacturer's recommended parts, when necessary.
- Mower blades are sharp, and can cut. Wrap the blades or wear gloves, and use extra caution when servicing.
- Use identical replacement blades only.
- Maintain or replace safety and instruction labels, as necessary.
- If situations occur that are not covered in this manual, use care and good judgment or contact Customer Service for assistance.

### 3 SYMBOLS ON THE PRODUCT

Some of the following symbols may be used on this tool. Please study them and learn their meaning. Proper interpretation of these symbols will allow you to operate the tool better and safer.



Symbol	Name	Explanation
V	Volt	Voltage
A	Amperes	Current
Hz	Hertz	Frequency (cycles per second)
W	Watt	Power
min	Minutes	Time
/min	Per Minute	Revolutions, strokes, surface speed, orbits etc., per minute
~	Alternating Current	Type of current
— — —	Direct Current	Type or a characteristic of current
$n_0$	No Load Speed	Rational speed, at no load
	Safety Alert	Precautions that involve your safety.

Symbol	Name	Explanation
	Eye Protection	Always wear eye protection with side shields marked to comply with ANSI Z87.1 when operating this equipment.
	WARNING --- Wet Conditions	Do not expose the product to rain or moist conditions.
	Read Operator's Manual	To reduce the risk of injury, user must read and understand operator's manual before using this product.
	Maintain Safety Devices	Do not open or remove safety devices while the tool is running.
	Looking Behind While Backing	Look down and behind first to avoid tripping when pulling back.
 	DANGER --- Keep Hands and Feet Away	To reduce the risk of injury, keep hands and feet away from rotating parts. Do not operate unless discharge cover or grass bag is in its proper place. If damaged, replace immediately.
	DANGER --- Keep Bystanders Away	Do not mow when children or others are nearby.
	DANGER --- Thrown Debris	Remove objects that can be thrown by the blade in any direction. Wear safety glasses.
	DANGER --- Steep Slope Hazard	Use extra caution on slopes. do not mow slopes greater than 15 degrees.

### 4 RISK LEVELS

The following signal words and meanings are intended to explain the levels of risk associated with this product.

SYMBOL	SIGNAL	MEANING
	DANGER	Indicates an imminently hazardous situation, which, if not avoided, will result in death or serious injury.

SYM-BOL	SIGNAL	MEANING
	WARNING	Indicates a potentially hazardous situation, which, if not avoided, could result in death or serious injury.
	CAUTION	Indicates a potentially hazardous situation, which, if not avoided, may result in minor or moderate injury.
	CAUTION	(Without Safety Alert Symbol) Indicates a situation that may result in property damage.

## 5 ENVIRONMENTALLY SAFE BATTERY DISPOSAL



The toxic and corrosive materials below are in the batteries used in this machine: **Lithium-Ion, a toxic material.**

### ▲ WARNING

Discard all toxic materials in a specified manner to prevent contamination of the environment. Before discarding damaged or worn out Li-ion battery, contact your local waste disposal agency, or the local Environmental Protection Agency for information and specific instructions. Take the batteries to a local recycling and/or disposal center, certified for lithium-ion disposal.

### ▲ WARNING

If the battery pack cracks or breaks, with or without leaks, do not recharge it and do not use. Discard it and replace with a new battery pack. **DO NOT TRY TO REPAIR IT!** To prevent injury and risk of fire, explosion, or electric shock, and to avoid damage to the environment:

- Cover the terminals of the battery with heavy-duty adhesive tape.
- **DO NOT** try to remove or destroy any of the battery pack components.
- **DO NOT** try to open the battery pack.
- If a leak develops, the released electrolytes are corrosive and toxic. **DO NOT** get the solution in the eyes or on skin, and do not swallow it.
- **DO NOT** put these batteries in your regular household trash.
- **DO NOT** incinerate.
- **DO NOT** put them where they will become part of any waste landfill or municipal solid waste stream.
- Take them to a certified recycling or disposal center.

## 6 PROPOSITION 65

### ▲ WARNING

This product contains a chemical known to the state of California to cause cancer, birth defects or other reproductive harm. Some dust created by power sanding, sawing, grinding, drilling, and other construction activities contains chemicals known to cause cancer, birth defects or other reproductive harm. Some examples of these chemicals are:

- Lead from lead-based paints;
- Crystalline silica from bricks and cement and other masonry products;
- Arsenic and chromium from chemically treated lumber.

Your risk of exposure to these chemicals varies depending on how often you do this type of work. To reduce your exposure to these chemicals, work in a well-ventilated area, and work with approved safety equipment, such as dust masks that are specially designed to filter out microscopic particles.

**Save these instructions.**

## 7 INSTALLATION

### ▲ WARNING

Do not change or make accessories that are not recommended by the manufacturer.

**▲ WARNING**

Do not put in the battery pack until you assemble all the parts.

**7.1 UNPACK THE MACHINE****▲ WARNING**

Make sure that you correctly assemble the machine before use.

**▲ WARNING**

- If the parts have damage, do not use the machine.
- If you do not have all the parts, do not operate the machine.
- If the parts are damaged or missing, speak to the service center.

1. Open the package.
2. Read the documentation in the box.
3. Remove all the unassembled parts from the box.
4. Remove the machine from the box.
5. Discard the box and package in compliance with local regulations.

**7.2 UNFOLD THE LOWER HANDLE**

*Figure 2.*

1. Pull and turn the handle knobs 90°.
2. Unfold the lower handle.
3. Line up the handle knobs in one of the three positions on the brackets.
4. Turn the handle knobs 90° until they engage the holes in the brackets.

**i NOTE**

Make sure that the two handle knobs are in the same position.

**▲ WARNING**

Do not make damage to the cables when you fold or unfold the handle.

**7.3 INSTALL THE UPPER HANDLE**

*Figure 3.*

1. Align the holes in the upper handle and the lower handle.
2. Put the bolts through the holes.
3. Tighten the knobs onto the bolts.
4. Do the same operation on the other side.

**7.4 INSTALL THE GRASS CATCHER**

*Figure 4.*

1. Remove the mulch plug.
2. Remove the side discharge chute.
3. Open the rear discharge door and hold it.
4. Hold the the grass catcher by its handle and engage the hooks on the door rod.
5. Close the rear discharge door.

**7.5 INSTALL THE MULCH PLUG**

*Figure 5.*

1. Remove the grass catcher.
2. Open the rear discharge door and hold it.
3. Hold the mulch plug by its handle and fit it in the discharge chute.
4. Close the rear discharge door.

**7.6 INSTALL THE SIDE DISCHARGE CHUTE**

*Figure 6.*

**▲ CAUTION**

When you use the side discharge chute,

- do not install the grass catcher.
- keep the mulch plug installed.

1. Open the side discharge door and hold it.
2. Line up the recesses of the side discharge chute below the pivot.
3. Close the side discharge door.

**7.7 SET THE BLADE HEIGHT**

The machine can be set to different blade heights.

*Figure 7.*

1. Pull the height adjustment lever rearward to increase the blade height.
2. Pull the height adjustment lever forward to decrease the blade height.

**7.8 INSTALL THE BATTERY PACK**

*Figure 8.*

**▲ WARNING**

- If the battery pack or charger is damaged, replace the battery pack or the charger.
- Stop the machine and wait until the engine stops before you install or remove the battery pack.
- Read, know, and do the instructions in the battery and charger manual.

**i NOTE**

The machine has a battery storage compartment that helps store the battery pack.

1. Open the battery door.
2. Align the lift ribs on the battery pack with the grooves in the battery compartment.
3. Push the battery pack into the battery compartment until the battery pack locks into place.
4. When you hear a click, the battery pack is installed.
5. Close the battery door.

**i NOTE**

The engine starts only when you put in the safety key.

**7.9 REMOVE THE BATTERY PACK**

*Figure 8.*

1. Open the battery door.
2. Remove the safety key.
3. Push and hold the battery release button.
4. Remove the battery pack from the machine.

**8 OPERATION****▲ WARNING**

Wear eye protection during operation.

**8.1 START THE MACHINE**

*Figure 9.*

1. Put in the safety key.
2. Push and hold the start button.
3. While you hold the start button, pull the bail switch in the direction of the handle bar.
4. Release the start button to start the machine.

**Soft-Start**

This Li-ion machine has a "soft-start" feature.

When you start the machine, it goes to full speed after approximately 3 seconds.

**i NOTE**

If the machine does not start, remove the battery pack and examine the mower deck to make sure that:

- no grass catches on the blade.
- the blade can turn freely by hand.

**8.2 STOP THE MACHINE**

*Figure 9.*

1. Release the bail switch to stop the machine.

**▲ WARNING**

Wait until the blades fully stop before you start the machine again. Do not quickly turn the machine off and on.

**▲ WARNING**

Always remove the safety key and battery pack after you complete the work.

**8.3 EMPTY THE GRASS CATCHER**

1. Stop the machine.
2. Remove the safety key.
3. Remove the battery pack.
4. Open the rear discharge door and hold it.
5. Hold the grass catcher by its handle and unhook it from the door rod.
6. Close the rear discharge door.
7. Empty the grass catcher.

**8.4 OPERATE ON SLOPES****▲ WARNING**

Do not mow on the slopes with decline more than 15°. If you are not comfortable, do not mow on a slope.

**▲ WARNING**

Please keep a low self-propelled speed when you mow on a slope.

- Do not go up and down on a slope when you mow across the face of the slope. Be careful when you change the direction on a slope.
- Monitor the holes, ruts, rocks, and other hidden objects that can cause you to fall. Remove all obstacles such as rocks and tree limbs.
- Make sure that your footing is stable. If you are out of balance, release the bail switch immediately.
- Do not mow near drop-offs, ditches, or embankments.

**8.5 OPERATION TIPS**

- Do not try to override the operation of the start button or bail switch.
- Do not tilt the machine when you start it.
- Do not put hands or feet near or below the turning parts.
- Keep the discharge chute clean.
- Do not cut wet grass.
- Higher blade height is necessary for new or thick grass.



- Clean the bottom of the mower deck after each use. Remove grass clippings, leaves, dirt, and other debris.

## 9 MAINTENANCE

### ▲ WARNING

Remove the safety key and battery pack from the machine before maintenance.

### ▲ WARNING

Keep the engine and battery pack free from grass, leaves or too much grease.

### ▲ CAUTION

Use only approved replacement parts.

### ▲ CAUTION

Do not let brake fluids, gasoline, petroleum-based materials touch the plastic parts. Chemicals can cause damage to the plastic, and make the plastic unserviceable.

### ▲ CAUTION

Do not use strong solvents or detergents on the plastic housing or components.

### 9.1 GENERAL MAINTENANCE

- Before each use, examine the machine for damaged, missing, or loose parts such as screws, nuts, bolts and caps.
- Tighten correctly all the fasteners and caps.
- Clean the machine with a dry cloth. Do not use water.

### 9.2 REPLACE THE BLADE

### ▲ WARNING

Use only approved replacement blades.

### ▲ WARNING

Wear heavy gloves or wind cloth around the blade when you touch the blade.

1. Stop the machine.
2. Make sure that the blades fully stop.
3. Remove the safety key and battery pack.
4. Turn the machine to its side.
5. Use a piece of wood to prevent the movement of the blade.

6. Remove the mounting screw with a wrench or socket.
7. Remove the blade.
8. Install the new blade. Make sure that the arrows engage the holes in the blade.
9. Put in the mounting screw and tighten it.

### 9.3 STORE THE MACHINE

- Clean the machine before storage.
- Make sure the engine is not hot when you store the machine.
- Make sure that the machine does not have loose or damaged parts. If it is necessary, do these steps/instructions:
  - Replace the damaged parts.
  - Tighten the bolts.
  - Speak to a person of an approved service center.
- Store the machine in a dry area.
- Make sure that children cannot come near the machine.

### 9.4 STAND THE MACHINE ON END

*Figure 10.*

1. Remove the grass catcher.
2. Pull and turn the handle knobs 90°.
3. Fold down the handle.
4. Turn the handle knobs 90° to lock the handle into position.
5. Stand the machine on end and make sure that the brackets touch the floor.

#### Storage Switch

The machine has a storage switch that prevents its startup in the storage position.

It is necessary to remove the safety key and the battery pack to prevent accidental startup or unapproved use. The storage switch does not replace this function.

## 10 TROUBLESHOOTING

Problem	Possible cause	Solution
The handle is not in position.	The bolts are not engaged correctly.	Adjust the height of the handle and make sure that the knobs and bolts are aligned correctly.

Problem	Possible cause	Solution
The machine does not start.	The battery capacity is low.	Charge the battery pack.
	The bail switch is defective.	Replace the bail switch.
	The battery key is not put in.	Put in the battery key.
The machine cuts grass unevenly.	The lawn is rough.	Examine the mowing area.
	The blade height is not set correctly.	Move the wheels to a higher position.
The machine does not mulch correctly.	Wet grass clippings attach to the deck.	Wait until the grass dries before mowing.
	The mulch plug is missing.	Install the mulch plug.
The machine is hard to push.	The grass is too tall, or the blade height is too low.	Increase the blade height.
	The grass catcher and the blade drags in thick grass.	Empty the grass clippings from the grass catcher.
There is a high vibration in the machine.	The blade is unbalanced and worn.	Replace the blade.
	The engine shaft is bent.	<ol style="list-style-type: none"> <li>1. Stop the engine.</li> <li>2. Remove the safety key and battery pack.</li> <li>3. Disconnect the power source.</li> <li>4. Inspect for damage.</li> <li>5. Repair the machine before you start it again.</li> </ol>

Problem	Possible cause	Solution
The machine stops during mowing.	The blade height is too low.	Increase the blade height.
	The battery pack is out of power.	Charge the battery pack.
	The grass clippings attach to the deck or the blade.	Remove the battery pack and check the deck.
	Operation temperature of the machine is too high.	Cool the machine.

\* If you cannot find the solution to these problems, go to the service center.

## 11 TECHNICAL DATA

Voltage	48 V
No load speed	2800 RPM
Height adjustments	1 3/8 - 3 3/4" (3.5 - 9.5 cm)
Functions	3-in-1: Mulching & Rear Bagging & Side Discharge Capabilities
Weight (without battery pack)	27.88 kg (61.46 lbs.)
Battery model	BAM706 and other BAM series
Charger model	CAM803 and other CAM series

## 12 LIMITED WARRANTY



Greenworks® hereby warrants this product, to the original purchaser with proof of purchase, for a period of four (4) years against defects in materials, parts or workmanship. Greenworks®, at its own discretion will repair or replace any and all parts found to be defective, through normal use, free of charge to the customer. This warranty is valid only for units which have been used for personal use that have not been hired or rented for industrial/commercial use, and that have been maintained in accordance with the instructions in the owners' manual supplied with the product from new.

**ITEMS NOT COVERED BY WARRANTY:**

1. Any part that has become inoperative due to misuse, commercial use, abuse, neglect, accident, improper maintenance, or alteration; or
2. The unit, if it has not been operated and/or maintained in accordance with the owner's manual; or
3. Normal wear, except as noted below;
4. Routine maintenance items such as lubricants, blade sharpening;
5. Normal deterioration of the exterior finish due to use or exposure.

**HELPLINE:**

Warranty service is available by calling our toll-free helpline, at 1-833-493-5483.

**TRANSPORTATION CHARGES:**

Transportation charges for the movement of any power equipment unit or attachment are the responsibility of the purchaser. It is the purchaser's responsibility to pay transportation charges for any part submitted for replacement under this warranty unless such return is requested in writing by Greenworks®.

## 13 EXPLODED VIEW

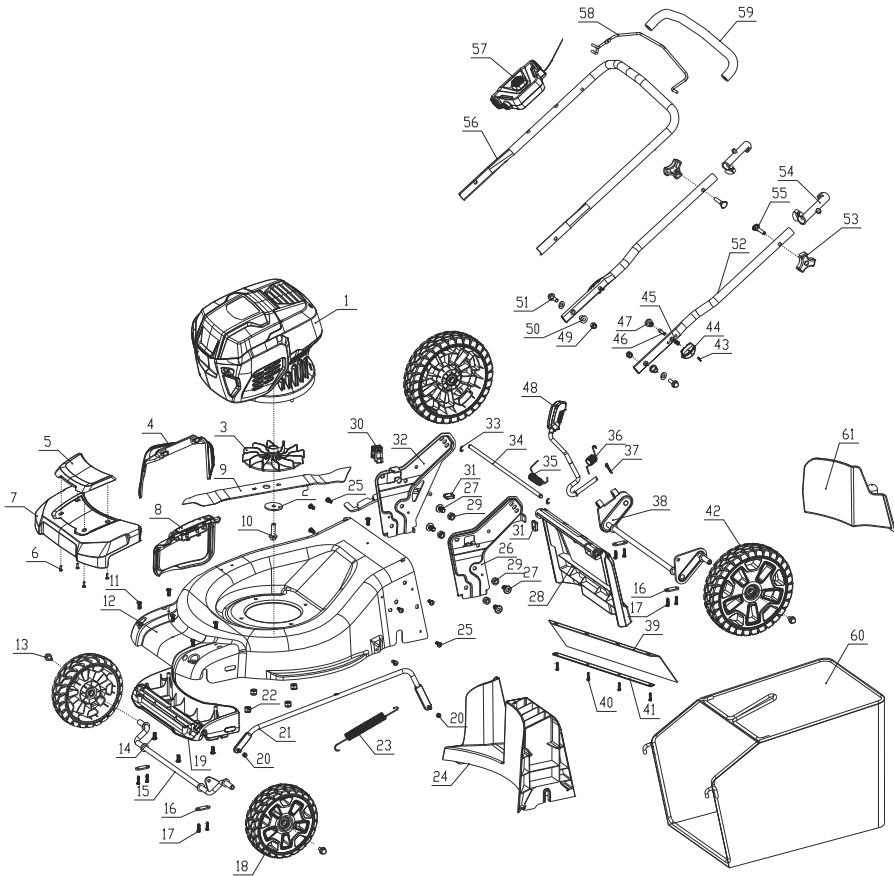

No.	Part No.	Qty	Description
1	311013459	1	Motor assembly
2	333021527	1	Pad
3	341191179-1	1	Fan
4	341241179C	1	Side discharge chute
5	341331179U	1	Bumper cover
6	32205836	4	Screw
7	341061179C	1	Bumper main body
8	311201546	1	Side discharge cover assembly
9	333041179	1	21" Blade
10	322011179AC	1	Bolt
11	3220951D	5	Screw

12	333011179	1	21" Deck
13	32202390A	4	Bolt
14	32204113D	4	Screw
15	311021179	1	Front wheel axle
16	33307470A	4	Axle press plate
17	32204113D	8	Screw
18	341281179A	2	8" Wheel assembly
19	341021179B	1	Front panel
20	3220343	2	Nut
21	333011546	1	Height adjustment link bar
22	32243563	4	Nut
23	332011179	1	Height adjustment tension spring
24	341011179B	1	Rear baffle
25	3220951D	7	Screw
26	333041519	1	Height adjustment bracket (left)
27	3221637	4	Bolt
28	341251179A	1	Rear cover
29	32910131	4	Nut
30	312011560	2	Mechanical vertical switch assembly
31	342031179	2	Rubber plug
32	333031560	1	Height adjustment bracket (right)
33	3290506	2	Clip washer
34	332021179	1	Rear cover axle
35	332111179	1	Torsional spring (rear cover)
36	33401222	1	Torsional spring
37	339031546	1	Cotter pin
38	311011179	1	Rear wheel axle
39	342011179	1	Rear shield
40	3220505D	4	Screw
41	332041179	1	Press board (rear shield)
42	341271179A	2	10" Wheel assembly
43	332061179	2	Pin
44	341151546	2	Knob
45	332051179	2	Spring
46	332071179C	2	Limit column
47	332081179C	2	Block
48	311063459	1	Height adjustment bar assembly
49	32201467	2	Nut
50	332101179C	2	Washer

51	322031179	2	Bolt
52	333121179A	2	Lower handle
53	341291179	2	Knob
54	341031555	2	Isolation sleeve
55	322041179	2	Stud
56	333111179C	1	Upper handle
57	311053459	1	Switch box assembly
58	333013455	1	Bail lever
59	342021179	1	Sponge
60	312011179Q	1	Grass catcher bag assembly
61	341351179B	1	Mulch plug

**Greenworks Tools**  
**PO Box 1238**  
**Mooresville, NC 28115**

