

INSTRUCTIONS FOR USE



PERFECTION



▲ WARNING

READ THIS MANUAL CAREFULLY BEFORE LOADING OR USING YOUR GLOCK PISTOL.

▲ WARNING

LIKE MOST MODERN HANDGUNS YOUR GLOCK PISTOL IS DESIGNED WITHOUT A CONVENTIONAL MANUAL SAFETY. THEREFORE YOU MUST CONSIDER IT TO BE LOADED AND READY TO FIRE UNTIL YOU HAVE REMOVED THE MAGAZINE AND VISUALLY AND PHYSICALLY (WITH YOUR FINGER) CONFIRMED THAT THE CHAMBER IS EMPTY.

GLOCK® SAFE ACTION® PISTOLS ALL MODELS

FIREARMS SAFETY RULES

Read this manual and the warnings contained in it before loading or using your GLOCK pistol. This manual explains the function and the handling of your GLOCK pistol and warns of the potential dangers, including death and serious personal injury, that can result from the unsafe use of your GLOCK pistol. This manual should always accompany your GLOCK pistol and be transferred with your GLOCK pistol if it is sold or loaned to another person.

We want you to enjoy shooting your GLOCK pistol, but we want you to enjoy it safely. Whether you are an experienced shooter or have never handled a firearm before, you must READ THIS ENTIRE MANUAL CAREFULLY before loading or firing your GLOCK pistol. This manual gives basic instructions on the proper handling and functioning of your GLOCK pistol. Your safety and the safety of others depends on you following the instructions and warnings in this manual and constant use of safe firearms practices. If you are unfamiliar with firearms, take a course in the safe handling of firearms run by a qualified firearms instructor, your local gun club, or a similar qualified organization.

This manual contains several safety warnings and instructions preceded with **▲ WARNING**, **▲ CAUTION** or **NOTICE**. These signal words are designed to draw your attention to important safety information. **▲ WARNING** indicates a hazardous situation which, if not avoided, could result in death or serious personal injury. **▲ CAUTION** indicates a hazardous situation, which, if not avoided, could result in moderate or minor personal injury. **NOTICE** addresses safety practices not related to personal injury.

The higher level of preparedness required of law enforcement and military personnel may override several of the following safety instructions. To provide safety while operating at a higher level of preparedness, proper initial combat oriented training and a reasonable amount of periodic training which stresses safe tactical procedures is recommended.

▲ WARNING Failure to follow the safety information and safety instructions in this manual could result in death, serious personal injury and/or property damage.

▲ WARNING Always seek a doctor's advice if you are taking medication to be sure that you are able to shoot and handle a firearm safely. Never drink alcoholic beverages or take drugs before or while shooting. Your vision and judgment could be seriously impaired, making your firearm handling unsafe.

▲ WARNING If your GLOCK pistol or any other firearm is carelessly or improperly handled, you could cause a negligent discharge, which could result in death, serious personal injury and/or property damage.

▲ WARNING Always handle your GLOCK pistol as if it is loaded so that you never fire negligently.

▲ WARNING Never point your GLOCK pistol at anything you do not intend to shoot.

▲ WARNING Never pull the trigger or put your finger on the trigger or in the trigger guard until you have made the decision to fire.

▲ WARNING Never take anyone's word that a firearm is unloaded; always check for yourself, with the firearm pointed in a safe direction and your finger off of the trigger and outside of the trigger guard.

▲ WARNING Always make sure your GLOCK pistol is unloaded and that the slide is locked open in the rearward position with the magazine taken out before handing it to another person.

▲ WARNING Never alter or modify your GLOCK pistol because this could cause it to malfunction and create a dangerous condition.

▲ WARNING Never carry your GLOCK pistol out of a suitable holster with a cartridge loaded in the chamber.

▲ WARNING To store your GLOCK pistol, first unload it as described in Chapter 8. Then, after checking to make sure that it is unloaded (magazine removed and chamber empty), place it in the included pistol case or another suitable locked container.

▲ WARNING Always store and transport your GLOCK pistol unloaded and locked in a suitable container, such as the included pistol case, out of the reach and sight of children or other unauthorized persons.

▲ WARNING Never store or transport ammunition in the same container as your GLOCK pistol.

⚠ CAUTION Most ammunition contains lead in the projectile and/or primer. Firing your GLOCK pistol in a poorly ventilated area can lead to exposure to lead. Always wash your hands after handling ammunition, firing your GLOCK pistol, and/or performing preventive maintenance on your GLOCK pistol to minimize your exposure to lead.

Before it left the factory, your GLOCK pistol was tested, carefully inspected, and packaged. GLOCK, cannot control what happens to the pistol after it leaves the factory, therefore, carefully examine your GLOCK pistol when you acquire it to ensure that it is unloaded and undamaged.

If you need another copy of this manual, do not understand any of the warnings and instructions in this manual, or if you have any problems operating your GLOCK pistol, contact the GLOCK entity for your region.

GLOCK Ges.m.b.H.

Gaston Glock-Platz 1
A-2232 Deutsch-Wagram
AUSTRIA
Tel: +43 (0) 2247 - 90300-0
Fax: +43 (0) 2247 - 90300-312
Web: www.glock.com

GLOCK Inc.

6000 Highlands Parkway
Smyrna, GA 30082
U.S.A.
Tel: +1 770 - 432 1202
Fax: +1 770 - 433 8719
Web: www.glock.com

GLOCK International S.A.

Edificio PH Obarrio 60, Local 15-B
Calle 60 Este 6B, Barrio Obarrio
Ciudad de Panamá, PANAMÁ
Tel: +507 3866 186
Web: www.glock.com

GLOCK Asia Pacific Limited

Unit 3, LG/F, OB1, 92 Siena Avenue
DB North Plaza, Discovery Bay
Lantau, N.T., HONG KONG
Tel: +852 2375 - 3858
Fax: +852 2654 - 7089
Web: www.glock.com

GLOCK Middle East F.Z.E.

Dubai Airport Free Zone, West Wing 3,
Office 501, P.O. Box 54260, Dubai
UNITED ARAB EMIRATES
Tel: +971 - 4 - 299 5779
Fax: +971 - 4 - 299 4442
Web: www.glock.com

TABLE OF CONTENTS

Chapter 1	MAIN FEATURES	6
Chapter 2	GLOCK PISTOL SET	9
Chapter 3	PISTOL NOMENCLATURE	10
Chapter 4	FUNCTIONING OF THE PISTOL	10
Chapter 5	LOADING	12
Chapter 6	FIRING	14
Chapter 7	CLEARING MALFUNCTIONS (JAMS)	17
Chapter 8	UNLOADING PROCEDURE AND SAFETY CHECK	19
Chapter 9	FIELD STRIPPING	21
Chapter 10	PREVENTIVE MAINTENANCE AND INSPECTION	25
Chapter 11	REASSEMBLY AND INSPECTION	33
Chapter 12	PISTOL CUSTOMIZING	36
Chapter 13	PISTOL CONFIGURATIONS	40
Chapter 14	PISTOL OPTIONS	43
Chapter 15	CABLE LOCK (USA and Canada only)	45
Chapter 16	COMPONENT PARTS	46
	EXPLODED DRAWING (GLOCK 17 Gen4)	47
	EXPLODED DRAWING (GLOCK 17 Gen5)	49
	EXPLODED DRAWING (GLOCK 42)	51
	TECHNICAL DATA	52
	YOUTH HANDGUN SAFETY ACT NOTICE	58
	STATE REQUIRED SAFETY WARNINGS	61

Note: The part numbers referenced in parenthesis throughout this manual correspond to the list of component parts and exploded drawing on pages 45-51.

The GLOCK Safe Action® self-loading pistol, with its no-compromise design, combines all the features demanded of the modern handgun of today – and of tomorrow:

- Extremely low overall weight
- High magazine capacity
- Outstanding performance combining advanced methods of manufacturing with top-quality materials.

GLOCK pistols have passed the most stringent military and industry tests and are known worldwide for their state-of-the-art technology, durability, reliability and accuracy.

The photographs and drawings in this manual reference the GLOCK 17 Gen4 pistol. Unless otherwise indicated, they are equally applicable to other models and previous versions of the GLOCK pistol.

FRAME: The frame (17) is made of polymer with hardened steel guides. It features an ideal grip angle and low weight. The slide stop lever (27) and the magazine catch (19) are easily operated with the shooting hand. GLOCK Gen4 and Gen5 pistols feature interchangeable backstraps (17a/b and 17c/d) to vary the circumference of the frame and an extended magazine catch that is reversible for right or left hand use. (Note: The part numbers referenced in parenthesis throughout this manual correspond to the list of component parts and exploded drawing on pages 45-51).

SAFE ACTION® TRIGGER SYSTEM: GLOCK's revolutionary Safe Action® trigger system provides a consistent trigger pull from the first to the last round. The three automatic independently operating mechanical safeties are built into the fire control system of the pistol. All three safeties disengage sequentially as the trigger is pulled and automatically reengage when the trigger is released. This safe, simple and fast system allows the user to concentrate fully on tactical tasks, particularly while under stress. It is safe if dropped and functional at temperatures from -40° to 122° Fahrenheit / -40° to 50° Celsius.

▲ WARNING If the trigger is in the forward position, your GLOCK pistol may be loaded.

1. Trigger Safety: The trigger safety is a lever incorporated into the trigger (26). When the trigger safety is in the forward position it blocks the trigger from moving rearward. The trigger safety and the trigger must be fully depressed at the same time to fire the pistol. If the trigger safety is not depressed, the trigger will not move rearward and allow the pistol to fire. The trigger safety is designed to protect against firing if the pistol is dropped or the trigger is subjected to lateral pressure.

2. Firing Pin Safety: The firing pin safety (8) mechanically blocks the firing pin (4) from moving forward in the ready-to-fire condition. As the trigger is pulled rearward the trigger bar pushes the firing pin safety up and frees the firing pin channel. If the user decides not to fire and releases the trigger, the firing pin safety automatically reengages.

3. Drop-Safety: The trigger bar rests on the safety ramp within the trigger mechanism housing. The trigger bar engages the rear portion of the firing pin (4) and prevents the firing pin from moving forward. As the trigger (26) is pulled rearward the trigger bar lowers down the safety ramp and allows the release of the firing pin. After firing, the trigger bar moves upward and reengages the firing pin.

⚠ WARNING Your GLOCK pistol does not have a conventional manual safety and it will fire if the trigger is pulled when there is a round in the chamber.

⚠ WARNING Although GLOCK pistols have several internal design features and mechanical safeties designed to prevent an unintentional discharge if the pistol is dropped or hit, the proper and safe function of your GLOCK pistol depends on it being used for its intended purposes and not being altered or modified. Like any other mechanical device, if your GLOCK pistol is subjected to unusual and extreme forces a part failure can occur. Therefore, safe firearm handling practices and the instructions and safety warnings in this manual must always be followed to minimize the risk of a negligent discharge.

⚠ WARNING In case any of your GLOCK pistol's safeties prove to be ineffective for any reason, the possibility of an unintentional discharge exists. If so, your GLOCK pistol should be immediately unloaded and not be used again until it has been examined by a GLOCK-Certified Armorer.

SLIDE: The advanced surface treatment of the slide (1) results in optimal hardness by considerably reducing wear and tear and makes it corrosion resistant,



even when operating in saltwater conditions. The matte black surface minimizes light reflection - an advantage in tactical circumstances.

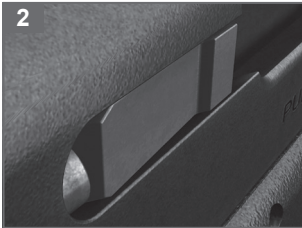

BARREL: The barrel (2) is mechanically locked and cold-hammer forged. It also has the same advanced surface treatment as the slide. The rounded (hexagonal or octagonal) interior profile offers numerous advantages over conventional barrel profiles, including elimination of corners/edges making them considerably easier to clean and maintaining uniform precision even after a high number of rounds have been fired.

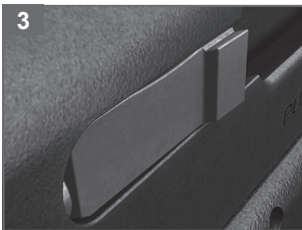

LOADED CHAMBER INDICATOR: The extractor (10) serves as a loaded chamber indicator (Picture 1) to comply with the laws of certain states and its position may visually and physically indicate whether there is a cartridge in the chamber of the pistol. When the chamber is unloaded the extractor is depressed (Picture 2) and when the chamber is loaded the extractor pivots out from the slide (Picture 3).

▲ WARNING Although your GLOCK pistol has a loaded chamber indicator, it is a mechanical device, which could fail. Never rely solely on a loaded chamber indicator or your memory to determine whether your GLOCK pistol is loaded or unloaded. Always remove the magazine, retract and lock the slide by pulling it fully to the rear and then visually and physically (with your finger) check to make sure there is not a cartridge in the chamber, as fully described in the Unloading Procedure and Safety Check, Chapter 8 (Pages 19-20).

- GLOCK Safe Action® Pistol including 1 magazine
- Magazine speed loader
- Spare magazine
(Gen4 and Gen5 pistols include 2 spare magazines, USA and Canada only)
- Cleaning set (rod with patch holder and brush)
- Instructions For Use manual
- Pistol case (for storage and transport)
- Backstrap set (Gen4 and Gen5 pistols only)
- Cable lock (USA and Canada only)
- The Basic Rules of Firearms Safety brochure (USA and Canada only)
- Customer Safety Awareness Form (USA and Canada only)





The following describes how the GLOCK semi-automatic Safe Action[®] pistol functions.

When the pistol is in the ready to fire condition – fully loaded with a round in the chamber and a loaded magazine inserted – the trigger is in the forward position with the trigger safety positively protruding from the trigger (26), the firing pin spring (6) is under partial tension, and the drop safety is engaged. The trigger safety prevents the trigger from being moved rearward and the firing pin safety (8) blocks the firing pin (4) from moving forward. (Note: The part numbers referenced in parenthesis throughout this manual correspond to the list of component parts and exploded drawing on pages 45-51).

When the trigger safety is disengaged by depressing it until it is even with the trigger, the trigger can be pulled rearward.

When the trigger slack is taken up to the first pressure point by pulling it rearward about 0.2 in. / 5mm, the trigger bar raises and disengages the firing pin safety and the firing pin is placed under additional tension.

When the trigger is pulled fully to the rear, the trigger bar separates from the end of the firing pin and drops down. This causes the firing pin to release and move forward under pressure to strike the primer of the cartridge in the chamber, thereby causing the pistol to fire.

The recoil impulse moves the slide (1) backward. After the slide has moved about 0.1 in. / 2.5mm to the rear, the locking action between the barrel (2) and the slide is released, and the barrel swings downward over the locking block (22) and is retained in this position.

The slide then continues to move fully rearward by itself, during the process of which the fired cartridge case is pulled out of the chamber of the barrel by the extractor (10), and is thrown out to the right by the ejector (23).

The ramp in the slide rails then separates the connector (24) from the trigger bar causing the trigger bar to be lifted by the trigger spring (25) and brought back into the path of the firing pin nose.

The recoil spring (3) then brings the slide forward. As the slide moves forward and the trigger is released, the following actions occur:

- the trigger bar is pushed onto the safety ramp by the firing pin;
- the firing pin safety is brought into engagement;
- the firing pin is put back under partial tension;
- the next cartridge is stripped from the magazine and placed into the chamber;
- the barrel is locked with the slide; and
- the trigger returns to the forward position with the trigger safety positively protruding from the trigger.

Each round is automatically loaded until the magazine is empty. After the last round in the magazine has been fired, the slide will remain locked open in the rearward position by the slide stop lever (27). (Note: If you are firing your GLOCK pistol without a magazine inserted, the slide will not remain locked open in the rearward position after firing).

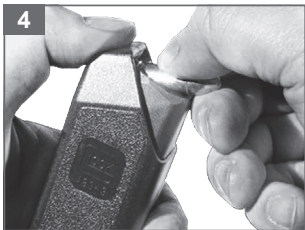

▲ WARNING Your GLOCK pistol does not have a conventional manual safety and it will fire if the trigger is pulled when there is a round in the chamber.



▲ WARNING Do not use reloaded, remanufactured, or handloaded ammunition because it may not meet applicable SAAMI, CIP or NATO standards and could cause death, serious personal injury, and/or property damage. Only use high quality commercially manufactured ammunition in the same caliber as your GLOCK pistol. (Note: Use of reloaded, remanufactured, or handloaded ammunition will void the warranty).



▲ WARNING Before firing your GLOCK pistol, run a clean patch through the barrel, from the chamber end, using the cleaning rod. Repeat this procedure until the patch comes out of the barrel with no gun oil or cleaner-lubricant-preserved because any obstruction in the barrel could prevent the pistol from firing properly and result in death or serious personal injury and/or damage to the pistol.



To load the magazine, press each cartridge into the magazine from the front - with the cartridge bottom first - against the force of the magazine spring (Pictures 4-5).



Insert the magazine into the magazine well until the magazine catch (19) locks into place (Picture 6). (Note: The part numbers referenced in parenthesis throughout this manual correspond to the list of component parts and exploded drawing on pages 45-51).

If the slide (1) is in the forward position, hold your GLOCK pistol with your firing hand and, while keeping your finger off of the trigger and outside of the

trigger guard, grasp the rear of the slide at the serrations with your other hand and pull the slide fully back (Picture 7) and then release it, allowing it to return to the fully forward position (Picture 8).

or

If the slide is locked in the rearward position, either press the slide stop lever (27) down to release the slide and return it to the fully forward position or grasp the rear of the slide at the serrations with your other hand and pull the slide fully back and then release it, allowing it to return to the fully forward position.

The pistol is now loaded and ready to be fired by pulling the trigger.

▲ WARNING Always be sure that the barrel of your GLOCK pistol is clear of obstructions before firing it. Remove any obstructions before firing your GLOCK pistol so that it will function safely and correctly. Any obstruction in the barrel could prevent the pistol from firing properly and result in death or serious personal injury and/or damage to the pistol.

▲ WARNING In case of a failure to fire, continue to hold your GLOCK pistol pointed towards the target for at least 30 seconds. If a hangfire (slow ignition) has occurred, the cartridge should fire within approximately 30 seconds. If the cartridge has not fired, remove the magazine, eject the cartridge from the chamber and examine its primer. If the firing pin indentation is light, off-center, or non-existent, stop using your GLOCK pistol and have it examined by the GLOCK entity for your region or a GLOCK-Certified Armorer. If the firing pin indentation on the primer appears normal (compared to similar previously fired cartridges) the cartridge may be defective. Separate the cartridge from other live ammunition and empty cases, reload your GLOCK pistol and resume firing. (Note: Dispose of misfired cartridges in accordance with the ammunition manufacturer's instructions).

▲ WARNING Never use your GLOCK pistol if it fails to function properly, and never force the slide closed on a jammed cartridge because it could cause the cartridge to explode.

▲ WARNING Never pull the trigger if the slide does not fully close to prevent a possible out of battery firing. If this happens, clear the pistol as described in Chapter 7, examine the round that was in the chamber, and check the chamber to ensure that there are no obstructions or debris in it.

▲ WARNING Always wear safety glasses and ear protection when firing your GLOCK pistol to protect your eyes and hearing.

▲ WARNING Always be sure that your backstop is adequate to stop and contain bullets before firing so that you do not hit anything outside of the shooting range area. A bullet could travel through or past your target as far as 2 miles (approximately 3km). If in doubt, do not shoot.

▲ WARNING Never shoot at a hard surface, such as a rock, or a liquid surface, such as water, because a bullet may ricochet and travel in any direction, striking you or someone else.

▲ WARNING Your GLOCK pistol does not have a conventional manual safety and it will fire if the trigger is pulled when there is a round in the chamber.

▲ WARNING Hot gasses and powder are forcefully expelled from the ports on top of the slide of GLOCK C (Compensated) model pistols when they are fired. Never place your hand on top of the slide and make certain that no part of your body is near or above the ports on the barrel when firing it.

▲ WARNING Always put a responsible and competent person in charge to maintain safety, discipline and control when a group is firing at a range, to reduce the likelihood of a negligent discharge.

▲ WARNING Always carry your GLOCK pistol unloaded with the slide locked open in the rearward position while on a range until preparing to fire. Always keep the pistol pointed towards the backstop when loading, firing and unloading it.

▲ CAUTION When ready to fire be sure that the area behind the slide is clear (check your thumb) and do not hold the pistol near your body, because the slide will move forcefully rearward when the pistol is fired. (Note: When firing with a two-hand grip, the thumb of the weak hand should be on the weak hand side of the pistol, never behind the slide).

▲ CAUTION Always keep yourself and others clear of the ejection port because spent cartridges are hot and are ejected with enough force to cause injury. Never touch the slide or barrel immediately after firing because they may be hot and could cause burns.

▲ CAUTION Except when the slide is locked in the fully rearward position and you are checking to ensure that the chamber is empty, never place your fingers in the ejection port because they could be injured by the movement of the slide.

▲ CAUTION Never fire your GLOCK pistol near an animal unless it is trained to accept that noise. An animal's startled reaction could injure it, or cause it to injure you or someone else.

9



When the pistol is loaded with a cartridge in the chamber, it can be fired by simply pulling the trigger (26) fully to the rear. (Note: The part numbers referenced in parenthesis throughout this manual correspond to the list of component parts and exploded drawing on pages 45-51).

After firing the last cartridge in the magazine, the slide (1) will remain locked open in the rearward position (Picture 9). (Note: If you are firing your GLOCK pistol without a magazine inserted, the slide will not remain locked open in the rearward position after firing).

▲ WARNING In case of a failure to fire, continue to hold your GLOCK pistol pointed towards the target for at least 30 seconds. If a hangfire (slow ignition) has occurred, the cartridge should fire within approximately 30 seconds. If the cartridge has not fired, remove the magazine, eject the cartridge from the chamber and examine its primer. If the firing pin indentation is light, off-center, or non-existent, stop using your GLOCK pistol and have it examined by the GLOCK entity for your region or a GLOCK-Certified Armorer. If the firing pin indentation on the primer appears normal (compared to similar previously fired cartridges) the cartridge may be defective. Separate the cartridge from other live ammunition and empty cases, reload your GLOCK pistol and resume firing. (Note: Dispose of misfired cartridges in accordance with the ammunition manufacturer's instructions).

▲ WARNING If an unfired cartridge hangs up, jams or binds while being chambered, do not attempt to force it into the chamber by pushing or striking the slide to attempt to close it because this could cause the cartridge to burst resulting in fragments of the cartridge flying out of the ejection port with sufficient force to cause death, serious personal injury and/or property damage.

▲ WARNING Always wear safety glasses when attempting to remove a jammed cartridge to protect your eyes.

All auto-loading pistols may occasionally experience a malfunction (jam) related to the feeding of ammunition. Most malfunctions are caused by improper ammunition, an improper grip on the pistol when shooting (limp wristing), improper lubrication, or a damaged magazine. To minimize the chance of malfunctions (jams), regularly perform preventive maintenance on your GLOCK pistol pursuant to the instructions in Chapter 10 of this manual. If you experience a malfunction (jam) while using a new brand, type, or lot of ammunition, try firing another type of ammunition to determine whether the ammunition was the source of the malfunction (jam).

▲ WARNING Do not use reloaded, remanufactured, or handloaded ammunition because it may not meet applicable SAAMI, CIP or NATO standards and could cause death, serious personal injury, and/or property damage. Only use high quality commercially manufactured ammunition in the same caliber as your GLOCK pistol. (Note: Use of reloaded, remanufactured, or handloaded ammunition will void the warranty).

If a cartridge becomes jammed while being chambered or extracted, follow the steps below to remove it.

While keeping the muzzle of your GLOCK pistol pointed in a safe direction (a safe direction is one in which no one can possibly be injured in the event of an unintentional discharge), remove the magazine if possible by pressing the magazine catch (19). (Note: The part numbers referenced in parenthesis throughout this manual correspond to the list of component parts and exploded drawing on pages 45-51).

While holding the grip with your firing hand, with your finger off of the trigger (26) and outside of the trigger guard, grasp the rear of the slide (1) at the serrations with your other hand and pull the slide fully back.

Lock the slide in the rearward (open) position by pushing up on the slide stop lever (27) and slowly releasing the slide from the fully rearward position until it locks in the open position.

If the above steps have not removed the jammed cartridge, carefully remove the jammed cartridge from the chamber using your fingers or a pointed wooden dowel.

▲ WARNING Do not use a metal tool to attempt to remove an unfired cartridge because it could ignite the primer and cause the cartridge to rupture resulting in fragments of the cartridge flying out of the ejection port with sufficient force to cause death, serious personal injury and/or property damage.

If you are unable to remove the jammed cartridge using the above steps, leave the slide locked in the rearward (open) position and contact the GLOCK entity for your region or a GLOCK-Certified Armorer.

▲ WARNING If the trigger is in the forward position, your GLOCK pistol may be loaded.

▲ WARNING Although your GLOCK pistol has a loaded chamber indicator, it is a mechanical device, which could fail. Never rely solely on a loaded chamber indicator or your memory to determine whether your GLOCK pistol is loaded or unloaded. Always remove the magazine, retract and lock the slide by pulling it fully to the rear and then visually and physically (with your finger) check to make sure there is not a cartridge in the chamber.

▲ WARNING It is possible that a cartridge may be in the chamber when a magazine is being removed from or inserted into your GLOCK pistol. A cartridge in the chamber will discharge when the trigger is pulled, whether or not a magazine is in your GLOCK pistol. Therefore, never leave your GLOCK pistol unattended, even when the magazine is removed. You must always verify that the chamber is empty before field stripping (disassembling into its major components) your GLOCK pistol for cleaning or any other reason.



To unload your GLOCK pistol, follow the instructions below. To ensure that your GLOCK pistol is unloaded, you **MUST** proceed in this order.

1. Remove the magazine by pressing the magazine catch (19) (Picture 10). (Note: The part numbers referenced in parenthesis throughout this manual correspond to the list of component parts and exploded drawing on pages 45-51).
2. While holding the grip with your firing hand, with your finger off of the trigger (26) and outside of the trigger guard, grasp the rear of the slide (1) at the

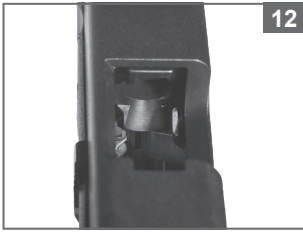

serrations with your other hand and pull the slide fully back to eject any cartridge that may be in the chamber (Picture 11).



3. Lock the slide in the rearward (open) position by pushing up on the slide stop lever (27) and slowly releasing the slide from the fully rearward position until it locks in the open position.



4. Once the slide is locked to the rear, both visually (Picture 12) and physically (with your finger) (Pictures 13-14) inspect both the chamber and the magazine well of the pistol to be sure that no ammunition remains in either place.



5. Release the slide to return it to the forward (closed) position by either pressing the slide stop lever down or grasping the rear of the slide at the serrations with your other hand and pulling the slide fully back and then releasing it.

6. With the muzzle of your GLOCK pistol pointed in a safe direction (a safe direction is one in which no one can possibly be injured in the event of an unintentional discharge), pull the trigger (Picture 15).

▲ WARNING If the trigger is in the forward position, your GLOCK pistol may be loaded.

▲ WARNING Unload all magazines and remove all live ammunition from the area before disassembling your GLOCK pistol to reduce the chance of a negligent discharge.

▲ WARNING Although your GLOCK pistol has a loaded chamber indicator, it is a mechanical device, which could fail. Never rely solely on a loaded chamber indicator or your memory to determine whether your GLOCK pistol is loaded or unloaded. Always retract the slide by grasping it at the serrations at the rear of the slide and pulling it fully to the rear and then visually and physically (with your finger) check to make sure there is not a cartridge in the chamber.

▲ WARNING It is possible that a cartridge may be in the chamber when a loaded magazine is being removed from or inserted into your GLOCK pistol. A cartridge in the chamber will discharge when the trigger is pulled, whether or not a magazine is in your GLOCK pistol. Therefore, never leave your GLOCK pistol unattended, even when the magazine is removed. You must always verify that the chamber is empty before field stripping (disassembling into its major components) your GLOCK pistol for cleaning or any other reason.

▲ WARNING Never alter or modify your GLOCK pistol because this could cause it to malfunction and create a dangerous condition.

▲ WARNING Always wear safety glasses when disassembling your GLOCK pistol to protect your eyes from components that are under pressure, such as springs.



To field strip (disassemble) your GLOCK pistol for cleaning, follow the instructions below. To ensure that your GLOCK pistol is unloaded, disassembly **MUST** be performed in this order.



1. Remove the magazine by pressing the magazine catch (19) (Picture 16). (Note: The part numbers referenced in parenthesis throughout this manual correspond to the list of component parts and exploded drawing on pages 45-51).



2. While holding the grip with your firing hand, with your finger off of the trigger (26) and outside of the trigger guard, grasp the rear of the slide (1) at the serrations with your other hand and pull the slide fully back to eject any cartridge that may be in the chamber (Picture 17).



3. Lock the slide in the rearward (open) position by pushing up on the slide stop lever (27) and slowly releasing the slide from the fully rearward position until it locks in the open position (Picture 18).



4. Once the slide is locked to the rear, both visually and physically (with your finger) inspect both the chamber and the magazine well of the pistol to be sure that no ammunition remains in either place (Picture 19).

5. Release the slide to return it to the forward (closed) position by either pressing the slide stop lever down or grasping the rear of the slide at the serrations with your other hand and pulling the slide fully back and then releasing it.

6. With the muzzle of your GLOCK pistol pointed in a safe direction (a safe direction is one in which



no one can possibly be injured in the event of an unintentional discharge), pull the trigger. (Note: The trigger must be in the rearmost position to remove the slide) (Picture 20).

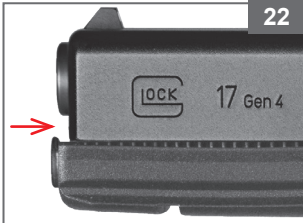

7. Hold your GLOCK pistol with your firing hand with your fingers across the top of the rear of the slide in front of the rear sight and your thumb on the rear of the frame (Picture 21).

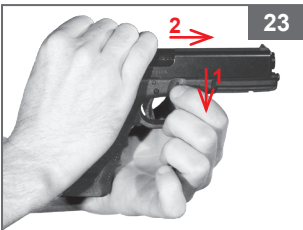

8. Using your fingers, retract the slide (1) about 1/8 in. / 3mm and hold it in this position (Picture 22). (Note: If you pull the slide too far to the rear, it will reset the pistol's trigger to the forward position. If this happens, pull the trigger again while keeping the muzzle of your GLOCK pistol pointed in a safe direction).

9. Using the thumb and index finger of your non-firing hand, pull the slide lock (21) down evenly on both sides (Picture 23).



10. While holding the slide lock down, push the slide forward and off of the frame (Picture 23).

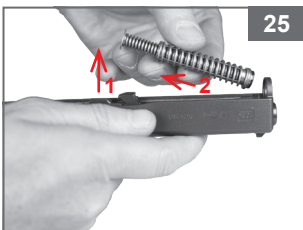

11. Press the recoil spring assembly (3) toward the front (muzzle end) of the slide while pulling it up to remove it from the slide (Pictures 24-25).

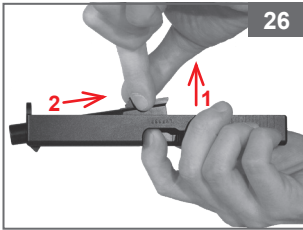

12. Holding the barrel by the barrel locking cams, lift it and push it toward the front of the slide and then pull it up and toward the rear to remove it from the slide (Picture 26).



▲ WARNING Never further disassemble your GLOCK pistol (Picture 27). Any further disassembly must be performed by a GLOCK-Certified Armorer. (Note: Any further disassembly will void the warranty unless performed by a GLOCK-Certified Armorer).

NOTICE When your GLOCK pistol is disassembled, never manually reset the trigger to its forward position and then pull it to the rear because this could damage the trigger safety.

NOTICE When your GLOCK pistol is disassembled, do not manually pull the firing pin (4) to the rear of the slide and allow it to snap forward because this could damage the firing pin and the firing pin safety (8).

▲ WARNING Always be sure that the barrel of your GLOCK pistol is clear of obstructions before firing it. Remove any obstructions before firing your GLOCK pistol so that it will function safely and correctly. Any obstruction in the barrel could prevent the pistol from firing properly and result in death or serious personal injury and/or damage to the pistol.

▲ WARNING It is possible that a cartridge may be in the chamber when a loaded magazine is being removed from or inserted into your GLOCK pistol. A cartridge in the chamber will discharge when the trigger is pulled, whether or not a magazine is in your GLOCK pistol. Therefore, never leave your GLOCK pistol unattended, even when the magazine is removed. You must always verify that the chamber is empty before field stripping (disassembling into its major components) your GLOCK pistol for cleaning or any other reason.

▲ WARNING Always wear safety glasses when cleaning your GLOCK pistol to protect your eyes from cleaning materials.

▲ WARNING Always make sure that no ammunition is located in the area where you clean your GLOCK pistol. Cleaner-lubricant-preservative can affect the primer and powder in ammunition and cause it to malfunction. This could result in a bullet being pushed into the barrel of your GLOCK pistol and getting stuck. Firing another round with a bullet stuck in the barrel could cause the barrel to burst and result in death or serious personal injury, in addition to damaging the pistol.

▲ WARNING Do not put cleaner-lubricant-preservative or gun oil inside the firing pin channel. Make sure that the magazine (inside and out) and breech

face are wiped dry before reassembling your GLOCK pistol. Leaving lubricant in these areas could cause contaminations of primers and failure to fire.

NOTICE As with any semi-automatic pistol, your GLOCK pistol should be field-stripped (disassembled into its major components) every time it is cleaned. Cleaning without field stripping, by merely locking the slide to the rear and inserting the cleaning rod from the muzzle, can cause dirt, oil and lubricant to build up inside the pistol causing malfunctions.

Like all mechanical devices, your GLOCK pistol must be properly maintained to ensure reliable functioning and long service life. Taking proper care of your pistol will also preserve its value. Although your GLOCK pistol is highly resistant to adverse conditions, you should follow a regularly scheduled maintenance program to ensure that it is properly cleaned and lubricated to prevent corrosion and to remove accumulated dirt and debris that can affect the action and operation of your pistol.

Your GLOCK pistol should be cleaned and lubricated as follows:

1. when brand new, before the first time it is fired, plus
2. after each time it is fired, plus
3. as required. This will be determined by your pistol's exposure to adverse conditions during storage or use such as rain, snow, perspiration, salt water, dirt, dust, lint, etc. Additionally, your pistol should be cleaned and inspected if it has been dropped or if any broken parts are suspected or malfunctions experienced, plus



4. at least once a year.

To clean your GLOCK pistol, first disassemble it into its five main components, the slide (1), barrel (2), recoil spring assembly (3), frame (17), and magazine, pursuant to the instructions in Chapter 9. Always use cleaning patches and brushes of the proper size for the caliber of your GLOCK pistol. (Note: The part numbers referenced in parenthesis throughout this manual correspond to the list of component parts and exploded drawing on pages 45-51).

BARREL: Clean the barrel as follows:

1. Wet a cleaning patch with cleaner-lubricant-preservative and run it through the barrel, from the chamber end, several times using a cleaning rod.
2. Wet a bristled cleaning brush with cleaner-lubricant-preservative and run it back and forth in the barrel, from the chamber end (Picture 28), using a cleaning rod to remove any fouling and burned powder.
3. Wet another cleaning patch with cleaner-lubricant-preservative and run it through the barrel once, from the chamber end, with the cleaning rod and examine it. If it is not clean, repeat steps 2 and 3 until the patch remains clean after being run through the barrel.
4. Run a clean patch through the barrel, from the chamber end, using the cleaning rod.
5. Lightly wet a clean patch with gun oil or cleaner-lubricant-preservative and run it through the barrel from the chamber end.

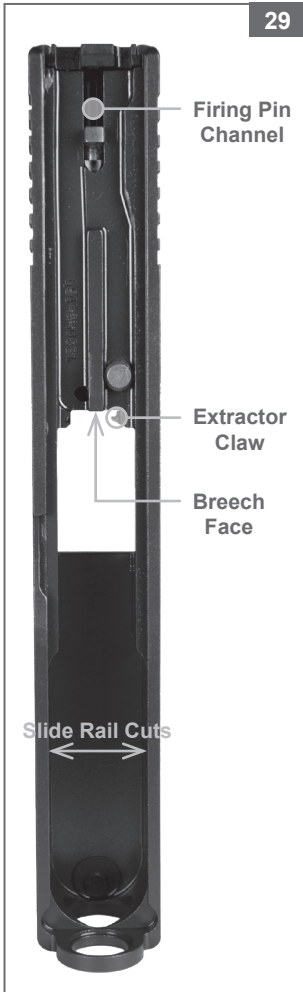

6. Before firing your GLOCK pistol, run a clean patch through the barrel, from the chamber end, using the cleaning rod. Repeat this procedure until the patch comes out of the barrel with no gun oil or cleaner-lubricant-preservative on it.

NOTICE If you will be storing your GLOCK pistol, do not perform step 6 until you are ready to use it.

7. Wet a nylon bristle brush with cleaner-lubricant-preservative and thoroughly brush the outside of the barrel to remove any dirt or residue.
8. Wipe the outside of the barrel dry with a clean patch and examine it. If it is not clean, repeat steps 7 and 8 until the patch remains clean.

SLIDE: (Note: The copper colored lubricant on portions of the slide of brand new GLOCK pistols is intended to help provide long-term lubrication and should not be removed). Clean the slide as follows:

1. Wet a nylon bristle brush with cleaner-lubricant-preservative and thoroughly brush the rail cuts in the slide where it meets the slide rails on the frame (Picture 29).
2. Wipe the rail cuts in the slide with a clean patch and examine it. If it is not clean, repeat steps 1 and 2 until the patch remains clean (except cooper colored long-term lubrication).
3. Wet a nylon bristle brush with cleaner-lubricant-preservative and, while holding the slide with the muzzle end facing down, brush the breech face and the area under the extractor claw (Picture 29).
4. While holding the slide with the muzzle end

facing down, wipe the breech face and the area under the extractor claw (10) (Picture 29) with a clean patch and examine it. If it is not clean, repeat steps three and four until the patch remains clean.

5. Check all other exposed areas of the slide for cleanliness. If any dirt or debris is found, remove it with cleaner-lubricant-preservative using a nylon bristle brush, patch, or a clean, soft cloth.
6. Wipe the exposed areas of the slide that you have cleaned in step 5 with a clean patch and examine it. If it is not clean, repeat steps 5 and 6 until the patch remains clean.

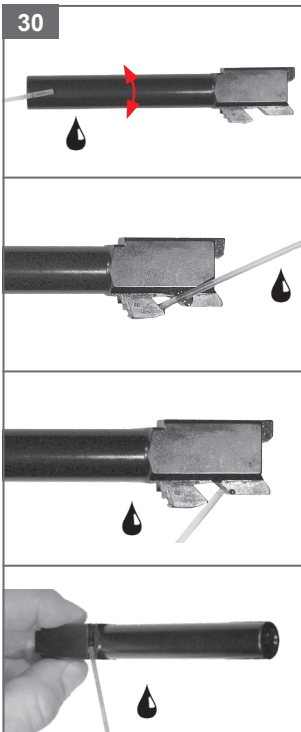

FRAME: Check the frame for cleanliness. If necessary, clean the frame as follows:

1. Wipe exposed parts of the frame with a clean, soft cloth that has been slightly dampened with cleaner-lubricant-preservative.
2. Wipe the exposed areas of the frame that you have cleaned in step 1 with a clean patch and examine it. If it is not clean, repeat steps 1 and 2 until the patch remains clean.

After you have cleaned your GLOCK pistol, lubricate it as follows:

1. Slightly dampen a clean patch with gun oil or cleaner-lubricant-preservative and wipe the outside of the barrel, including the barrel hood and lugs (Picture 30), the inside top of the slide in front of the ejection port where the barrel hood rubs against the slide, and the opening that the barrel slides through in front of the slide.

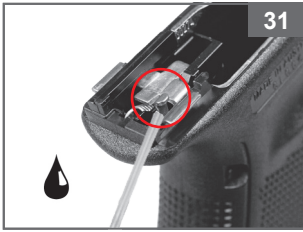

2. Place a drop of gun oil or cleaner-lubricant-preservative where the rear end of the trigger bar (26) touches the connector (24) at the right rear corner of the frame (Picture 31).

3. Spread one drop of gun oil or cleaner-lubricant-preservative along the entire length of each slide rail cut (Picture 32).

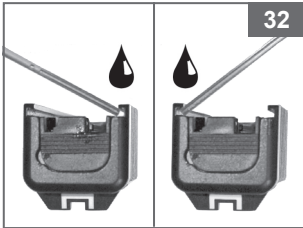

4. Slightly dampen a clean patch with gun oil or cleaner-lubricant-preservative and wipe the exterior surfaces of the slide.

⚠ CAUTION GLOCK pistols are designed to operate properly with only small amounts of lubrication. Do not over-lubricate your GLOCK pistol because too much lubricant can collect unburned powder and other debris and prevent your GLOCK pistol from functioning properly.

After you have finished cleaning and lubricating your GLOCK pistol, you should perform a limited (user-level) inspection to help confirm that it is functioning properly. If your pistol fails any of the following checks, contact the GLOCK entity for your region or a GLOCK-Certified Armorer. To inspect your GLOCK pistol, follow these steps before reassembling it:

1. **EXTERNAL INSPECTION:** Inspect the outside of your frame and slide for dirt, corrosion, or any visible damage. Pay special attention to the sights (15 & 16a), trigger and trigger safety (26), slide stop lever (27), magazine catch (19), and extractor (10).

2. **BARREL INSPECTION:** Inspect the barrel (2) for dirt, leading, bulges, cracks or obstructions.

▲ WARNING Do not use a cracked, bulged, or obstructed barrel. Contact the GLOCK entity for your region or a GLOCK-Certified Armorer for repair or replacement.

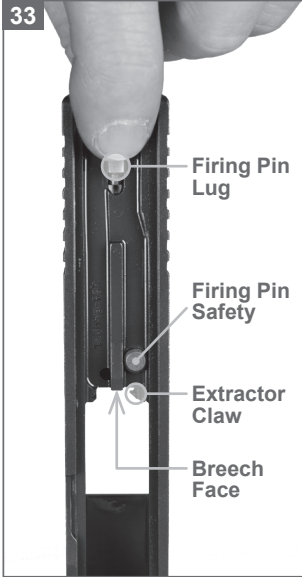

3. FIRING PIN SAFETY TEST: Hold the slide and pull the lug of the firing pin (4) (Picture 33), all the way to the rear of the slide and then ease it forward until it stops in contact with the firing pin safety (8).

NOTICE The firing pin is held in the forward position under spring pressure. Do not allow the firing pin to snap forward against the firing pin safety because this could cause damage to the firing pin and/or the firing pin safety.

Then press the lug of the firing pin (4) forward with your forefinger using moderate force (approximately 5-8 lbs. / 23 - 36 N). The firing pin must not move forward past the firing pin safety (8), and must not protrude from the breech face of the slide.

▲ WARNING If the firing pin safety fails to keep the firing pin from moving forward, **DO NOT LOAD OR FIRE YOUR GLOCK PISTOL**. Instead, have it inspected and repaired by the GLOCK entity for your region or a GLOCK-Certified Armorer.

4. FIRING PIN: Hold the slide with the muzzle end downward, and press the firing pin safety into the slide with your fingertip. The firing pin should move downward, and the tip of the firing pin should protrude from the breech face. (Note: On brand new pistols you may need to apply light downward pressure to the rear of the firing pin lug with your finger to assist the firing pin in moving downward).

5. **FIRING PIN CHANNEL:** Hold the firing pin safety depressed with your fingertip, and vigorously shake the slide from end to end. You should hear the firing pin moving freely in the firing pin channel.
6. **EXTRACTOR:** Look across the breech face to inspect the extractor for cleanliness and to be sure the extractor claw is not broken.

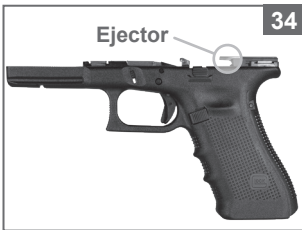

7. **EJECTOR:** Inspect the ejector (23) (in the frame of the pistol) to ensure that it is intact (not broken) (Picture 34).
8. **SLIDE STOP LEVER TEST:** Pull upward on the slide stop lever and release. The lever should snap down sharply into the frame. If the lever's return to the downward position is sluggish, or it remains in the upward position, contact the GLOCK entity for your region or a GLOCK-Certified Armorer.

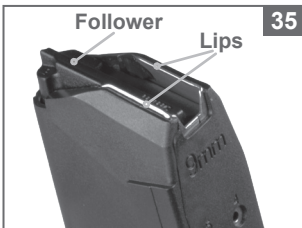

9. **MAGAZINE INSPECTION:** Inspect all magazines for dirt or visible damage, taking special care to look for spread or damaged feed lips or broken magazine followers (32) (Picture 35). Press down on the follower with your fingertip and release. The follower should spring fully upward, and should not stick inside the magazine tube.

36



▲ WARNING Always wear safety glasses when reassembling your GLOCK pistol to protect your eyes from springs.

To reassemble your GLOCK pistol, follow the instructions below.

37

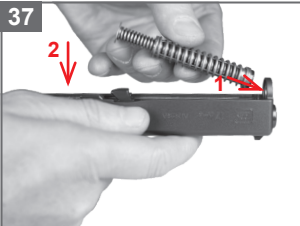

1. Holding the barrel (2) by the barrel locking cams, insert it into the slide (1) by pushing it down and in (Picture 36). (Note: The part numbers referenced in parenthesis throughout this manual correspond to the list of component parts and exploded drawing on pages 45-51).

38



2. Insert the recoil spring assembly (3) into the slide by placing the small end of the recoil spring assembly in the indentation in the front of the slide and pressing the other end of the recoil spring assembly towards the front of the slide to compress the spring and pushing down until the large end of the recoil spring assembly rests in the second (semi-circular) notch on the barrel locking cams (Pictures 37-39).

39

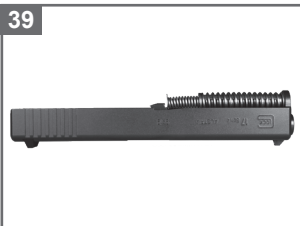

3. Holding the frame in your firing hand, with your finger off of the trigger and outside of the trigger guard, place the slide on top of the frame (17) in front of the slide rails and push the slide towards the back of the frame until the slide lock (21) snaps up to lock the slide into place (Picture 40).

40



After you have reassembled your GLOCK pistol, you should inspect it to ensure that it is working properly by performing the following steps:



1. **TRIGGER SAFETY TEST:** Confirm that your GLOCK pistol is unloaded by making sure the magazine is not inserted in the pistol and visually and physically (with your finger) checking to make sure that there is not a cartridge in the chamber. Cycle the slide to reset the trigger to the forward position. With the muzzle of your GLOCK pistol pointed in a safe direction (a safe direction is one in which no one can possibly be injured in the event of an unintentional discharge), grasp the sides of the trigger (without touching or depressing the trigger safety) and attempt to pull the trigger to the rear (Picture 41). The trigger safety should prevent rearward movement of the trigger, and the pistol should not dry fire.

▲ WARNING If the trigger safety fails to keep the trigger from moving rearward, and the pistol dry fires, **DO NOT LOAD OR FIRE YOUR GLOCK PISTOL** and have it inspected and repaired by the GLOCK entity for your region or a GLOCK-Certified Armorer.



2. **TRIGGER RESET TEST:** With the muzzle of your GLOCK pistol pointed in a safe direction, pull the trigger and hold the trigger to the rear. You should hear and feel the firing pin release. While continuing to hold the trigger to the rear, pull the slide to the rear (Picture 42) and release it, allowing it to snap forward. Now release the trigger. The trigger should reset to its forward position. Repeat the trigger reset test several times.



- 3. SLIDE LOCK-OPEN TEST:** Insert an EMPTY magazine into your pistol. Pull the slide fully to the rear. The slide should lock open (Picture 43). Repeat the slide lock-open test using each of your EMPTY magazines.

In addition to the limited (user level) inspection described in this manual, GLOCK pistols carried by law enforcement, security, or military personnel and other GLOCK pistols subjected to heavy usage, should be inspected periodically by a GLOCK-Certified Armorer, or by returning the pistols to the GLOCK entity for your region for inspection. Although the appropriate inspection interval will depend on the conditions of use, a reasonable rule of thumb for law enforcement, security, or military personnel is that the pistols should be inspected by a GLOCK-Certified Armorer once a year. To locate a GLOCK-Certified Armorer in your area or before returning the pistol for inspection, contact your local GLOCK dealer or the GLOCK entity for your region.



44

**GLOCK Gen4/Gen5 Backstraps
Customizing the Frame**

GLOCK Gen4 and Gen5 pistols feature interchangeable backstraps with or without a beaver tail to vary the circumference and the shape of the frame (Pictures 44-45). Without a backstrap attached, the Gen4 and Gen5 have the same frame circumference as the SF models. The medium backstrap adds an additional 0.08 in. / 2mm to the circumference of the frame. The large backstrap adds 0.16 in. / 4mm to the circumference of the frame. The backstraps with a beaver tail come with the same sizes and additionally they are enlarged at the top allowing the shooter's hand to better stabilize the pistol.

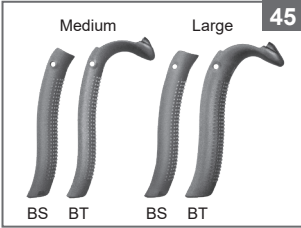

45

Available Options:

Without backstraps	Short Frame (SF-Frame)
Medium backstrap with a beaver tail (BT)	Medium Frame (M) + 0.08 in. / 2mm
Medium backstrap without a beaver tail (BS)	
Large backstrap with a beaver tail (BT)	Large Frame (L) + 0.16 in. / 4mm
Large backstrap without a beaver tail (BS)	

▲ WARNING Make sure that your GLOCK pistol is unloaded (magazine removed and chamber empty) before changing the backstraps.

The backstraps (17a/b 17c/d) are changed as follows. (Note: The part numbers referenced in parenthesis throughout this manual correspond to the list of component parts and exploded drawing on pages 45-51).

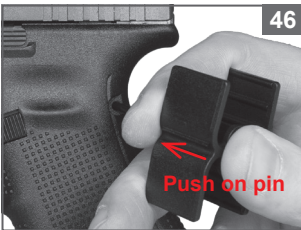

46

1. Remove the trigger housing pin (29/29a) with the multifunctional clip by pushing it from one side to the other and completely out of the frame (17) (Picture 46).



2. If a backstrap is already installed, remove it (Picture 47/48).
3. If you will be installing a backstrap, attach it to the frame by hooking the bottom of the backstrap to the bottom rear of the frame, then pivoting the top of the backstrap forward and onto the frame (Picture 49).



If you are installing a beavertail backstrap press it to the frame, until it clicks onto the small nose of the modular backstrap (MBS)/Gen5 frame. (Note: The beavertail backstrap also fits on older Gen4 pistols without the small nose. The nose is only an additional fixture (Picture 50)).

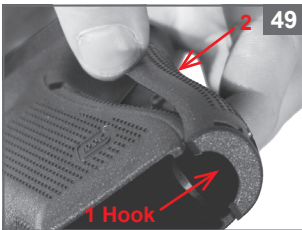

4. If you did not install a backstrap, install the short trigger housing pin by pushing it into the corresponding hole in the rear of the frame with the flat side of the multifunctional clip until it is completely centered in the frame. If you installed a backstrap, hold it in place against the frame while installing the long trigger housing pin by pushing it into the corresponding hole in the rear of the frame with the flat side of the multifunctional clip until it is completely centered in the frame (Picture 51).



5. Inspect the pistol to confirm that you have installed the correct trigger housing pin by ensuring that it is flush with the frame. If you installed the long trigger housing pin without a backstrap, it will protrude outside of the frame and could cause discomfort while shooting. If you installed the short trigger housing pin with a backstrap, it will not fully extend to the sides of the frame and may allow the backstrap to come loose.



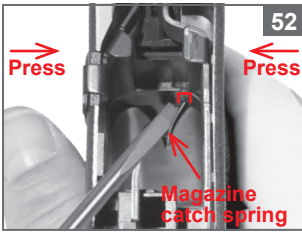

GLOCK Gen4/Gen5 Reversible Magazine Catch Reversing the Magazine Catch

GLOCK Gen4 and Gen5 also feature an extended magazine catch (19) that is reversible for right or left hand use. Standard GLOCK magazines can be used in Gen4 and Gen5 pistols when the magazine catch is installed in the right handed position. New Style magazines are required when the magazine catch is installed in the left handed position. The magazine catch on the GLOCK Gen4 and Gen5 can be reversed by proceeding as follows. (Note: The pistol must be field stripped pursuant to the instructions in Chapter 9 before the magazine catch can be reversed).

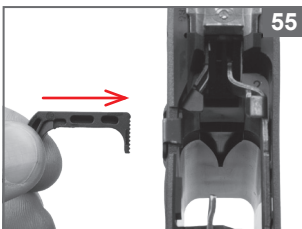
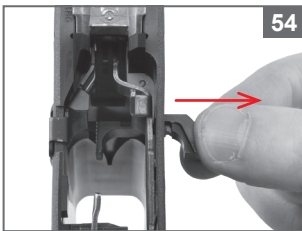
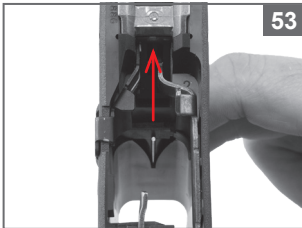

1. Hold the frame (17) so that you can see into the magazine well.
2. While pressing against both sides of the magazine catch to prevent it from moving, use a small flat head screwdriver to push the magazine catch spring (18) up and towards the “U” shaped cut in the magazine catch (Picture 52) to release the spring tension on the magazine catch. Use pliers to pull the magazine catch spring upwards and out of the receiver (Picture 53).
3. Remove the magazine catch by pulling it out of the frame from the outside (Picture 54).
4. Reverse the magazine catch and reinsert it in the other side of the frame from the outside (Picture 55).
5. Insert the magazine catch spring with the pliers in the provided hole and push this down. Make sure to seat it completely. Using a small flat head screwdriver, push the end of the magazine catch spring back into the “U” shaped cut in the magazine catch.

6. Insert an empty magazine into the frame and press the magazine release to confirm that it operates correctly. Repeat several times.
7. Reassemble your GLOCK pistol according to the instructions in Chapter 11.

56

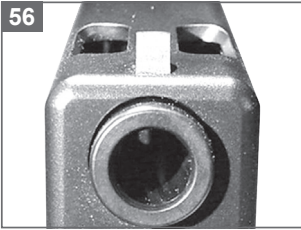
**GLOCK C** (Compensated)

▲ WARNING Hot gasses and powder are forcefully expelled from the ports on top of the slide of GLOCK C (Compensated) model pistols when they are fired. Never place your hand on top of the slide and make certain that no part of your body is covering the ports on the barrel when firing it.

57



GLOCK C models are equipped with an integrated compensator (Pictures 56-57), making the pistol even more controllable during rapid fire, thereby increasing accuracy. The compensator consists of two longitudinal openings in the barrel and side of the pistol arranged in a “V-position.” This minimizes front sight blackening through powder gases. The C configuration is available in GLOCK models 17, 19, 21, 24, and 31.

58

**GLOCK SF** (Short-Frame)*

The circumference of the frame on the SF models is reduced at the rear or “backstrap” (Picture 58), which will appeal to shooters with smaller hands and offer increased comfort and control to all. The SF configuration is available in GLOCK models 20, 21, 29 and 30.

Not available for Gen4 and Gen5 models.

*Not available in CA and MA.

59

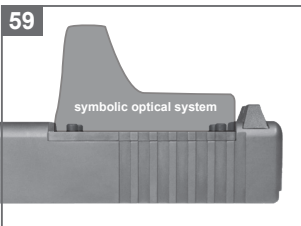
**GLOCK MOS** (Modular Optic System)

GLOCK pistol models in MOS configuration offer a set of adapter plates in order to mount different optical systems (Picture 59). The MOS configuration is not available for all GLOCK pistol models.



GLOCK Gen5

The frame design of the Gen5 is modular adaptable and offers a new grip without finger grooves, a reversible enhanced magazine release and an ambidextrous slide stop lever.



GLOCK Oval Magazine Catch

The oval magazine catch (Picture 61) was specifically developed for comfort conscious and left-handed users. Note: Frame adjustment is required at the factory.

Not available for Gen4 and Gen5.



GLOCK RTF2

(Rough textured frame, version 2)

The RTF2 models feature pyramid shaped cubids on the frame (Picture 62) for an improved grip. The RTF2 configuration is available in GLOCK models 17, 19, 22, 23 and 34.

Not available for Gen4 and Gen5.



Turn clockwise to unlock

Internal Locking Device

Some GLOCK pistols can be ordered with an optional factory-installed internal locking device designed to render the pistol inoperable by preventing the trigger from being pulled fully to the rear. (Note: If your GLOCK pistol contains the optional internal locking device, it has been shipped in the locked condition).

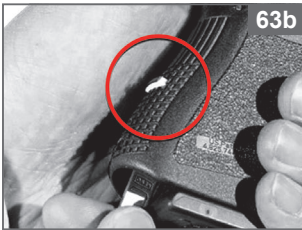

Indicator in the back of the grip indicates that the pistol is "locked"

To unlock the pistol, insert the specialized key into the keyhole located at the bottom of the frame behind the magazine well, and rotate it clockwise one full turn (Picture 63a). The pistol is now fully operational. To lock the internal locking device, insert the key into the keyhole and rotate it counter clockwise one full turn. A white tab will protrude from the back of the frame to indicate that the pistol is locked (Picture 63b).

Not available for Gen4 and Gen5.

▲ WARNING Never leave your GLOCK pistol where it could be accessed by a child or other unauthorized person. Store the key to the internal locking device separately from your GLOCK pistol.

STANDARD OPTIONAL

REAR SIGHT

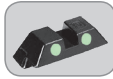
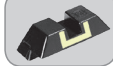
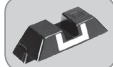
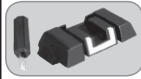

Several options are available to customize your GLOCK pistol. The general availability of these options is dependent on region and model. (Note: The part numbers referenced in parenthesis throughout this manual correspond to the list of component parts and exploded drawing on pages 45-51).

REAR SIGHTS: Most GLOCK pistol models come standard with polymer rear sights (15), which have a white contrast insert for rapid aim. Some models come standard with adjustable rear sights, which allow the point of impact to be adjusted for both windage and elevation, using the supplied tool. Steel rear sights with a white contrast insert for quick aim, steel luminescent sights and steel night sights with tritium contrast points, which appear white in the day light and illuminated in color at night are available as options. The fixed rear sights are available in four different heights, 6.1mm (0.24 in.), 6.5mm (0.26 in.), 6.9mm (0.27 in.) and 7.3mm (0.29 in.). Any one of the available rear sights can be easily installed on any GLOCK pistol by a GLOCK-Certified Armorer.

FRONT SIGHT

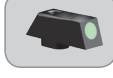
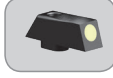

FRONT SIGHTS: All GLOCK pistol models come standard with polymer front sights (16a), which provide excellent damping characteristics on impact. Steel front sights with a white contrast point, steel luminescent sights and steel night sights with a self-illuminating tritium contrast point are available as options. Any one of the available front sights can be easily installed on any GLOCK pistol by a GLOCK-Certified Armorer.

CONNECTORS



CONNECTORS/TRIGGER SPRINGS: GLOCK offers different connectors (24) and trigger springs (25), which can be used in combination to adjust the trigger pull from approximately 4.5-11.2 lbs. / 20 - 50N.

STANDARD OPTIONAL

SLIDE STOP LEVER
not available for Gen5

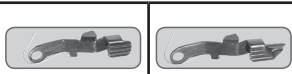

AMBIDEXTROUS SLIDE STOP LEVER
Gen5 only



MAGAZINE CATCH
not available for Gen4 and Gen5

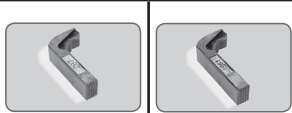

REVERSIBLE MAGAZINE CATCH
Gen4 and Gen5 only

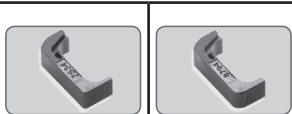

All available trigger pull combinations can be used in any GLOCK pistol and can easily be changed by a GLOCK-Certified Armorer.

SLIDE STOP LEVER: Most GLOCK pistol models come with the standard slide stop lever (27), which has flat dimensions for concealed carry. Some models come with an extended slide stop lever with a comfortable thumb rest, especially suitable for left-handed users. A standard or extended slide stop lever can easily be installed on any GLOCK pistol by a GLOCK-Certified Armorer.

MAGAZINE CATCH: Most GLOCK pistol models come with the standard magazine catch (19) that has flat dimensions designed to protect against inadvertent magazine release. Some models come with an extended magazine catch that produces the decisive tenths of a second increase in the speed of changing the magazine for dynamic shooting sport disciplines. A standard or extended magazine catch can easily be installed on any GLOCK pistol by a GLOCK-Certified Armorer.



64

Your GLOCK pistol comes standard (USA and Canada only) with a cable lock (Picture 64). The cable must be installed on an unloaded pistol with the slide locked in the open (rearward position). The cable must be placed through the ejection port and out of the magazine well. Insert the end of the cable into the lock and make sure it is locked into place.

▲ WARNING Never leave your GLOCK pistol where it could be accessed by a child or other unauthorized person. Store the key to the cable lock separately from your GLOCK pistol.

1	Slide
2	Barrel
3	Recoil spring assembly*
4	Firing pin
5	Spacer sleeve
6	Firing pin spring
7	Spring cups
8	Firing pin safety
9	Firing pin safety spring
10	Extractor
11	Extractor depressor plunger
12	Extractor depressor plunger spring
13	Spring-loaded bearing
14	Slide cover plate
15	Rear sight
16a	Front sight
16b	Front sight screw
17	Frame
17a/b	Backstrap medium / large
17c/d	Beavertail backstrap medium / large
18	Magazine catch spring
19	Magazine catch
20	Slide lock spring
21	Slide lock
22	Locking block
23	Trigger mechanism housing with ejector
24	Connector
25	Trigger spring
26	Trigger with trigger bar
27	Slide stop lever
28	Trigger pin
29	Trigger housing pin (short)
29a	Trigger housing pin (long)
30	Locking block pin
31	Magazine tube
32	Follower
33	Magazine spring
34	Magazine insert
35	Magazine floor plate

Magazine compatibility: Please note Gen4 Pistols require Gen4 style magazines for correct operation of the magazine catch in left handed position.

* The recoil spring assembly is designed to be used as a one-piece unit for easier handling and must not be disassembled. Prior to 1991, GLOCK pistols were supplied with a separate recoil spring and recoil spring tube. The separate recoil springs and recoil spring tubes can still be used on pistols that have them.

EXPLODED DRAWING GLOCK 17 GEN4

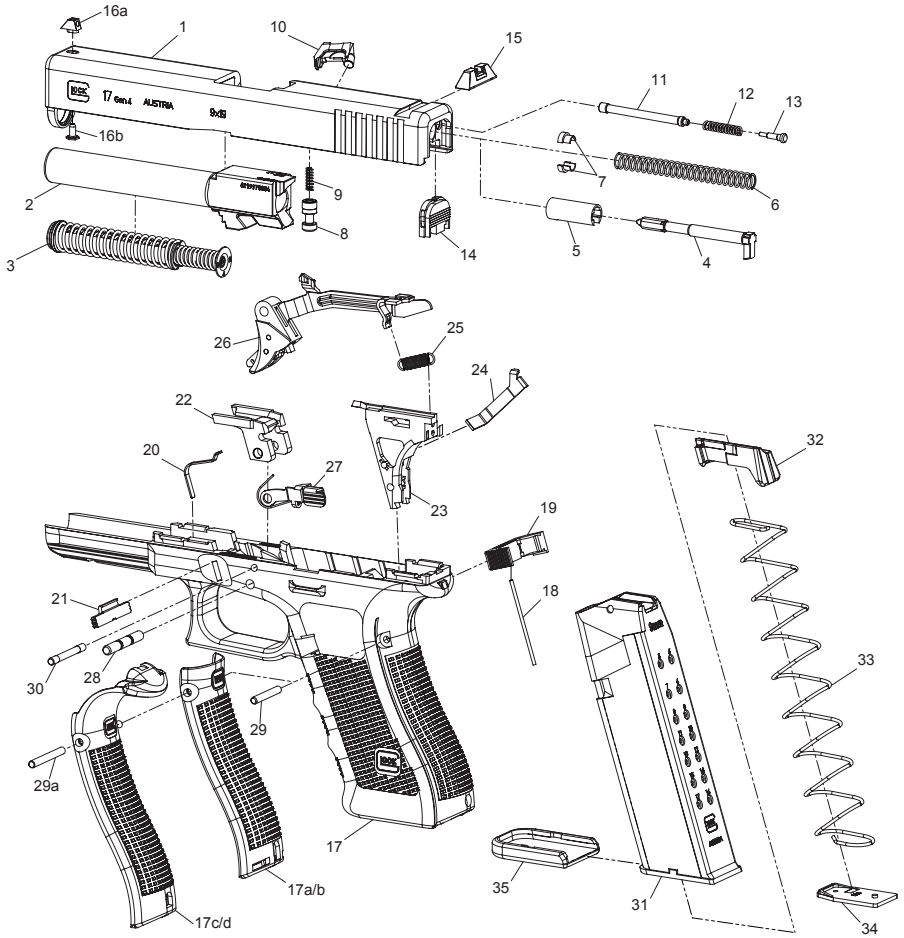

1	Slide
2	Barrel
3	Recoil spring assembly*
4	Firing pin
5	Spacer sleeve
6	Firing pin spring
7	Spring cups
8	Firing pin safety
9	Firing pin safety spring
10	Extractor
11	Extractor depressor plunger
12	Extractor depressor plunger spring
13	Spring-loaded bearing
14	Slide cover plate
15	Rear sight
16a	Front sight
16b	Front sight screw
17	Frame
17a/b	Backstrap medium / large
17c/d	Beavertail backstrap medium / large
18	Magazine catch spring
19	Magazine catch
20	Slide lock spring
21	Slide lock
22	Locking block
23	Trigger mechanism housing with ejector
24	Connector
25	Trigger spring
26	Trigger with trigger bar
27	Ambidextrous slide stop lever
28	Trigger pin
29	Trigger housing pin (short)
29a	Trigger housing pin (long)
30	---
31	Magazine tube
32	Follower
33	Magazine spring
34	Magazine insert
35	Magazine floor plate

EXPLODED DRAWING GLOCK 17 GEN5

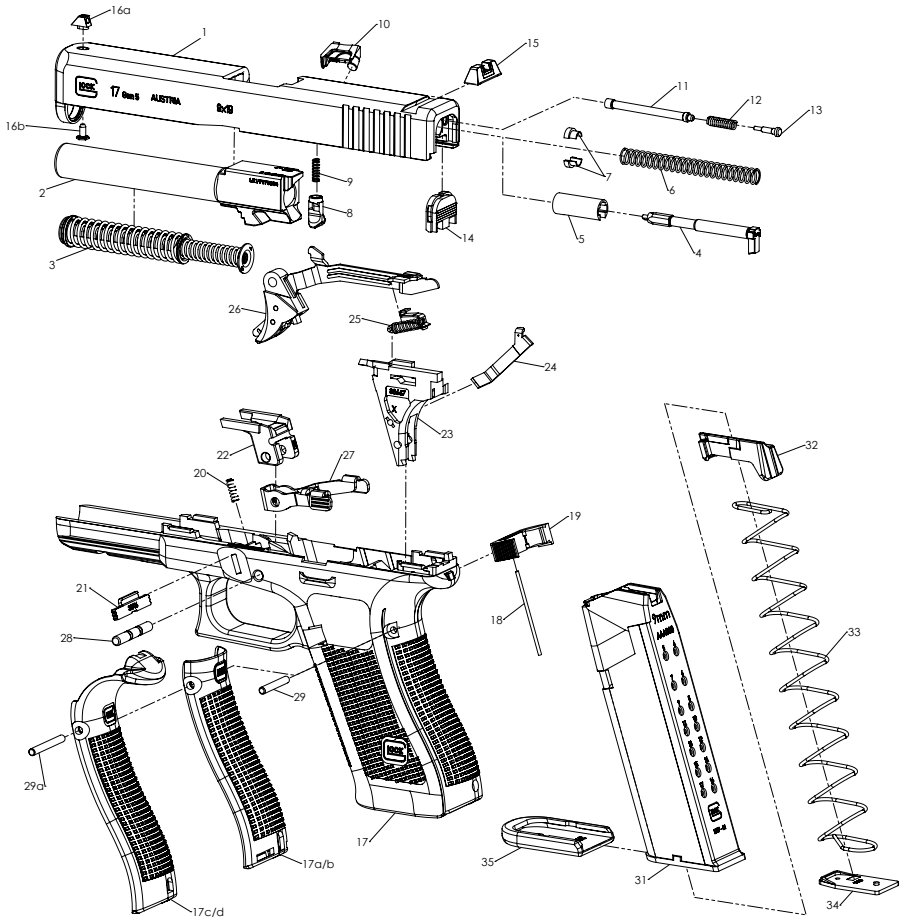

1	Slide
2	Barrel
3	Recoil spring assembly*
4	Firing pin
5	Spacer sleeve
6	Firing pin spring
7	Spring cups
8	Firing pin safety
9	Firing pin safety spring
10	Extractor
11	Extractor depressor plunger
12	Extractor depressor plunger spring
13	Spring-loaded bearing
14	Slide cover plate
15	Rear sight
16a	Front sight
16b	Front sight screw
17	Frame
18	Magazine catch spring
19	Magazine catch
20	Slide lock spring
21	Slide lock
22	Locking block
23	Trigger mechanism housing with ejector
24	Connector
25	Trigger spring
26	Trigger with trigger bar
27	Slide stop lever
28	Trigger pin
29	Trigger housing pin
30	---
31	Magazine tube
32	Follower
33	Magazine spring
34	Magazine insert
35	Magazine floor plate

EXPLODED DRAWING GLOCK 42

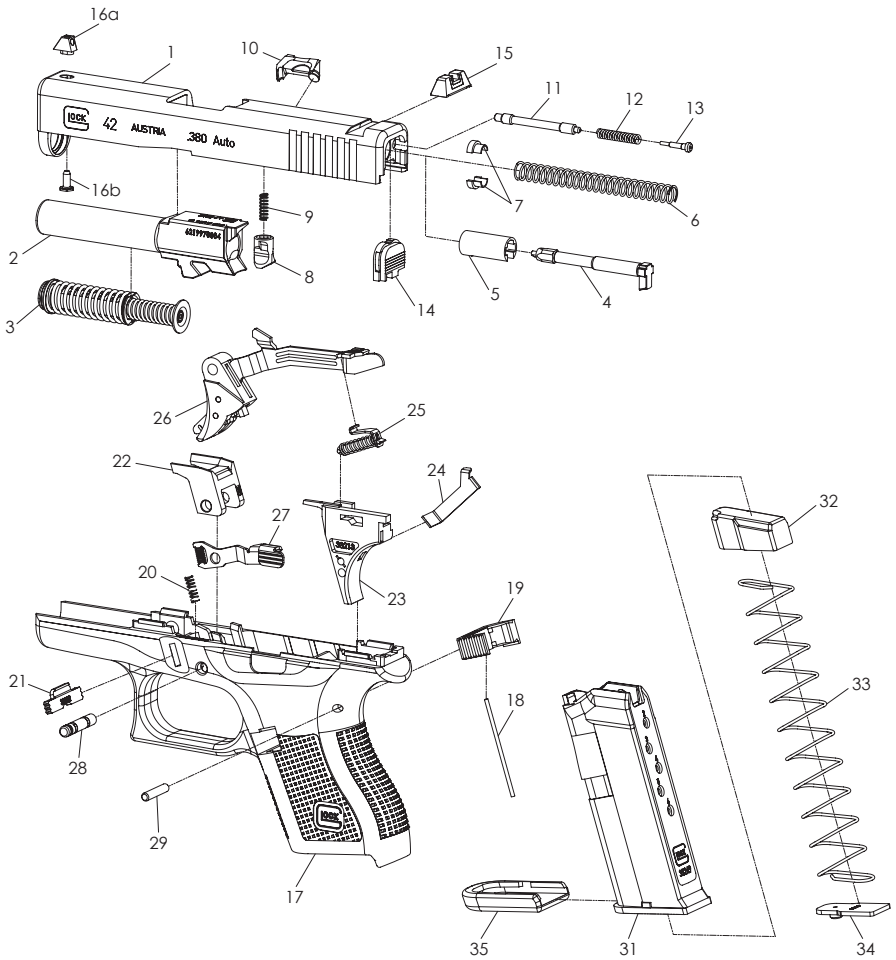

TECHNICAL DATA

Trigger pull (~)	N	lbs	28 6.3	26 5.8	28 6.3
Trigger travel (~)	mm	inch	12.5 0.49		
Weight loaded (~)	g	oz	915 32.28	945 33.33	975 34.39
Weight incl. magazine	g	oz	705 24.87	708 24.97	725 25.57
Magazine capacity	rounds		17		15
Barrel rifling			6		
Length of twist	mm	inch	250 9.84		
Barrel length	mm	inch	114 4.49		
Sight radius	mm	inch	165 6.50	169 6.65	165 6.50
Height incl. magazine	mm	inch	139 5.47		
Slide width	mm	inch	25.5 1.00		
Width (overall)	mm	inch	32 1.26	34 1.34	32 1.26
Slide length complete	mm	inch	186 7.32		
Length (overall)	mm	inch	204 8.03	202 7.95	204 8.03
Caliber			9x19		.40
Model	G17	G17 Gen4**	G17 Gen5	G17C Gen4	G22 G22 Gen4
					G31 G31 Gen4
					G37 G37 Gen4
					.45 GAP
			Standard		

Trigger pull (~)	N lbs	28 6.3	26 5.8	28 6.3
Trigger travel (~)	mm inch	12.5 0.49		
Weight loaded (~)	g oz	855 30.16	885 31.22	890 31.39
Weight incl. magazine	g oz	670 23.63	675 23.81	785 27.69
Magazine capacity	rounds	15	13	15
Barrel rifling		6		
Length of twist	mm inch	250 9.84		
Barrel length	mm inch	102 4.02		
Sight radius	mm inch	153 6.02	158 6.22	153 6.02
Height incl. magazine	mm inch	128 5.04		
Slide width	mm inch	25.5 1.00		
Width (overall)	mm inch	32 1.26	34 1.34	32 1.26
Slide length complete	mm inch	174 6.85		
Length (overall)	mm inch	187 7.36	185 7.28	187 7.36
Caliber		9x19		.40
Model		G19	G19 Gen4**	G23
		G19 Gen5	G19C Gen4	G23 Gen4
				G25
				.380 Auto
				G32
				.357
				G32 Gen4
				G38
		.45 GAP		
		Compact		

		G26		G27		G28		G33		G39		G42		G43	
Trigger pull (~)	lbs N	28 6.3		26 5.8		28 6.3		28 6.3		28 6.3		24 5.4		24 5.4	
Trigger travel (~)	mm inch	12.5 0.49		12.5 0.49		12.5 0.49		12.5 0.49		12.5 0.49		12.5 0.49		12.5 0.49	
Weight loaded (~)	g oz	730 25.75		739 26.07		750 26.46		685 24.16		735 25.93		790 27.87		450 15.87	
Weight incl. magazine	g oz	610 21.52		615 21.69		605 21.34		585 20.64		620 21.87		685 24.16		390 13.76	
Magazine capacity	rounds	10		10		9		10		9		6		6	
Barrel rifling		6		6		6		6		6		8		6	
Length of twist	mm inch	250 9.84		250 9.84		250 9.84		250 9.84		250 9.84		400 15.75		250 9.84	
Barrel length	mm inch	87 3.43		87 3.43		87 3.43		87 3.43		87 3.43		82.5 3.25		86.5 3.41	
Sight radius	mm inch	137 5.39		137 5.39		137 5.39		137 5.39		137 5.39		125 4.92		133 5.24	
Height incl. magazine	mm inch	106 4.17		106 4.17		106 4.17		107 4.21		106 4.17		105 4.13		108 4.25	
Slide width	mm inch	25.5 1.00		25.5 1.00		25.5 1.00		25.5 1.00		28.5 1.12		21 0.83		22 0.87	
Width (overall)	mm inch	32 1.26		33 1.30		32 1.26		32 1.26		33 1.30		25 0.98		27 1.06	
Slide length complete	mm inch	159 6.26		159 6.26		159 6.26		159 6.26		159 6.26		146 5.75		154 6.06	
Length (overall)	mm inch	165 6.50		163 6.42		165 6.50		165 6.50		163 6.42		165 6.50		151 5.94	
Caliber		9x19		.40		.380 Auto		.357		.45 GAP		.380 Auto		9x19	
Model		G26	G26 Gen4	G26 Gen5	G27	G27 Gen4	G28	G33	G33 Gen4	G39	G42	G43	Slimline		
		Subcompact												Slimline	

Trigger pull (~)	N lbs	26 5.8	24 5.4	28 6.3	24 5.4	
Trigger travel (~)	mm inch	12.5 0.49				
Weight loaded (~)	g oz	890 31.39	960 33.86	1090 38.45	945 33.33 940 33.16	
Weight incl. magazine	g oz	704 24.83	755 26.63	840 29.63	735 25.93 743 26.21 780 27.51 785 27.69	
Magazine capacity	rounds	17	15	17	15	
Barrel rifling		6				
Length of twist	mm inch	250 9.84				
Barrel length	mm inch	102 4.02	153 6.02	135 5.31		
Sight radius	mm inch	153 6.02	205 8.07	192 7.56	191 7.52 192 7.56	
Height incl. magazine	mm inch	139 5.47				
Slide width	mm inch	25.5 1.00				
Width (overall)	mm inch	33 1.30		34 1.34	33 1.30	
Slide length complete	mm inch	174 6.85	225 8.86	207 8.15		
Length (overall)	mm inch	189 7.44	242 9.53	224 8.82	222 8.74 224 8.82 222 8.74	
Caliber		9x19		.40		
Model		G19X	G17L	G24	G34 G34 Gen4** G34 Gen5** G35 G35 Gen4**	
		Cross-over	Competition			

Trigger pull (~)	N			28		6.3	
Trigger travel (~)	mm inch			12.5		0.49	
Weight loaded (~)	g oz	1130	39.86	1125	39.68	1100	38.80
Weight incl. magazine	g oz	870	30.69	865	30.51	830	29.28
Magazine capacity	rounds	15		13		825	
Barrel rifling		6		8		1095	
Length of twist	mm inch	250	9.84	400		15.75	
Barrel length	mm inch			117		4.61	
Sight radius	mm inch	172		6.77		177	
Height incl. magazine	mm inch			140		5.51	
Slide width	mm inch			28.5		1.12	
Width (overall)	mm inch			34		1.34	
Slide length complete	mm inch			193		7.60	
Length (overall)	mm inch			205		8.07	
Caliber		10mm Auto				.45 Auto	
Model		G20 Gen4	G20 SF	G21 Gen4	G21 SF	G21C Gen4	
		Standard					

Trigger pull (~)	N	lbs	28						24																	
Trigger travel (~)	mm	inch	12.5						0.49																	
Weight loaded (~)	g	oz	925	32.63		930	32.80		955	33.69		855	30.16		760	26.81		1265	44.62		1035	36.51				
Weight incl. magazine	g	oz	760		26.81		745		26.28		645		22.75		635		22.40		1005		35.45		760		26.81	
Magazine capacity	rounds		10						6		15		13													
Barrel rifling			6		8						6		8													
Length of twist	mm	inch	250		9.84		400		15.75		250		9.84		400		15.75									
Barrel length	mm	inch	96						3.78		153		6.02		135		5.31									
Sight radius	mm	inch	150						5.91		211		8.31		195		7.68									
Height incl. magazine	mm	inch	115		4.53		122		4.80		120		4.72		139		5.47									
Slide width	mm	inch	28.5		1.12		25.5		1.00		25.5		1.00		28.5		1.12		25.5		1.00					
Width (overall)	mm	inch	35						1.38		30		1.18		34		1.34									
Slide length complete	mm	inch	172		6.77		229		9.02		211		8.31													
Length (overall)	mm	inch	177						6.97		241		9.49		223		8.78									
Caliber			10mm		Auto		.45 Auto		.45 Auto		10mm		Auto		.45 Auto											
Model			G29	Gen4	G29	SF	G30	Gen4	G30	SF	G30S	G36	G40	Gen4**	G41	Gen4**										
			Subcompact						Slimline		Competition															

* depending on ammunition used

** Technical data also applicable for MOS configuration

TECHNICAL DATA MAY BE ALTERED WITHOUT NOTICE!

YOUTH HANDGUN SAFETY ACT NOTICE

- (1) The misuse of handguns is a leading contributor to juvenile violence and fatalities.
- (2) Safely storing and securing firearms away from children will help prevent the unlawful possession of handguns by juveniles, stop accidents, and save lives.
- (3) Federal law prohibits, except in certain limited circumstances, anyone under 18 years of age from knowingly possessing a handgun, or any person from selling, delivering, or otherwise transferring a handgun to a person under 18.
- (4) A knowing violation of the prohibition against selling, delivering, or otherwise transferring a handgun to a person under the age of 18 is, under certain circumstances, punishable by up to 10 years in prison.

FEDERAL LAW

The Gun Control Act of 1968, 18 U.S.C. Chapter 44, provides in pertinent part as follows:

18 U.S.C. § 922(x)

- (1) It shall be unlawful for a person to sell, deliver, or otherwise transfer to a person who the transferor knows or has reasonable cause to believe is a juvenile—
 - (A) a handgun; or
 - (B) ammunition that is suitable for use only in a handgun.
- (2) It shall be unlawful for any person who is a juvenile to knowingly possess—
 - (A) a handgun; or
 - (B) ammunition that is suitable for use only in a handgun.
- (3) This subsection does not apply to —
 - (A) a temporary transfer of a handgun or ammunition to a juvenile or to the possession or use of a handgun or ammunition by a juvenile if the handgun and ammunition are possessed and used by the juvenile—
 - i. in the course of employment, in the course of ranching or farming related to activities at the residence of the juvenile (or on property used for ranching or

farming at which the juvenile, with the permission of the property owner or lessee, is performing activities related to the operation of the farm or ranch), target practice, hunting, or a course of instruction in the safe and lawful use of a handgun;

ii. with the prior written consent of the juvenile's parent or guardian who is not prohibited by Federal, State, or local law from possessing a firearm, except—

(I) during transportation by the juvenile of an unloaded handgun in a locked container directly from the place of transfer to a place at which an activity described in clause (i) is to take place and transportation by the juvenile of that handgun, unloaded and in a locked container, directly from the place at which such an activity took place to the transferor; or

(II) with respect to ranching or farming activities as described in clause (i), a juvenile may possess and use a handgun or ammunition with the prior written approval of the juvenile's parent or legal guardian and at the direction of an adult who is not prohibited by Federal, State or local law from possessing a firearm;

iii. the juvenile has the prior written consent in the juvenile's possession at all times when a handgun is in the possession of the juvenile; and

iv. in accordance with State and local law;

(B) a juvenile who is a member of the Armed Forces of the United States or the National Guard who possesses or is armed with a handgun in the line of duty;

(C) a transfer by inheritance of title (but not possession) of a handgun or ammunition to a juvenile; or

(D) the possession of a handgun or ammunition by a juvenile taken in defense of the juvenile or other persons against an intruder into the residence of the juvenile or a residence in which the juvenile is an invited guest.

(4) A handgun or ammunition, the possession of which is transferred to a juvenile in circumstances in which the transferor is not in violation of this subsection shall not be subject to permanent confiscation by the Government if its possession by the juvenile subsequently becomes unlawful because of the conduct of the juvenile, but shall be returned to the lawful owner when such handgun or

ammunition is no longer required by the Government for the purposes of investigation or prosecution.

- (5) For purposes of this subsection, the term “juvenile” means a person who is less than 18 years of age.
- (6)
 - (A) In a prosecution of a violation of this subsection, the court shall require the presence of a juvenile defendant’s parent or legal guardian at all proceedings.
 - (B) The court may use the contempt power to enforce subparagraph (A).
 - (C) The court may excuse attendance of a parent or legal guardian of a juvenile defendant at a proceeding in a prosecution of a violation of this subsection for good cause shown.

18 U.S.C. § 924(a)(6)

- (A)
 - i. A juvenile who violates section 922(x) shall be fined under this title, imprisoned not more than 1 year, or both, except that a juvenile described in clause (ii) shall be sentenced to probation on appropriate conditions and shall not be incarcerated unless the juvenile fails to comply with a condition of probation.
 - ii. A juvenile is described in this clause if –
 - (I) the offense of which the juvenile is charged is possession of a handgun or ammunition in violation of section 922(x)(2); and
 - (II) the juvenile has not been convicted in any court of an offense (including an offense under section 922(x) or a similar State law, but not including any other offense consisting of conduct that if engaged in by an adult would not constitute an offense) or adjudicated as a juvenile delinquent for conduct that if engaged in by an adult would constitute an offense.
- (B) A person other than a juvenile who knowingly violates section 922(x)–
 - i. shall be fined under this title, imprisoned not more than 1 year, or both; and
 - ii. if the person sold, delivered, or otherwise transferred a handgun or ammunition to a juvenile knowing or having reasonable cause to know that the juvenile intended to carry or otherwise possess or discharge or otherwise use the handgun or ammunition in the commission of a crime of violence, shall be fined under this title, imprisoned not more than 10 years, or both.

STATE REQUIRED SAFETY WARNINGS

Certain states have laws requiring that specific warnings be provided with handguns sold in those states. Because GLOCK pistols are sold in all states, the safety warnings required by all states are included in this manual.

California:

⚠ WARNING “Firearms must be handled responsibly and securely stored to prevent access by children and other unauthorized users. California has strict laws pertaining to firearms, and you may be fined or imprisoned if you fail to comply with them. Visit the Web site of the California Attorney General at <https://oag.ca.gov/firearms> for information on firearm laws applicable to you and how you can comply. Prevent child access by always keeping guns locked away and unloaded when not in use. If you keep a loaded firearm where a child obtains and improperly uses it, you may be fined or sent to prison.”

⚠ ADVERTENCIA “Las armas de fuego deben operarse con responsabilidad y mantenerse guardadas en un lugar seguro fuera del alcance de niños o usuarios no autorizados. California tiene leyes estrictas con respecto a armas de fuego, y Usted puede ser multado o enviado a prisión por su incumplimiento con estas regulaciones. Visite la página web del Fiscal General de California en <https://oag.ca.gov/firearms> para obtener información acerca de las regulaciones sobre armas de fuego aplicables a su situación y que debe hacer para cumplir con ellas. Prevenga que niños tengan acceso a armas de fuego manteniéndolas descargadas y guardadas bajo llave cuando no las esté utilizando. Si Usted mantiene un arma de fuego cargada donde un niño pueda tener acceso y la usa de manera inapropiada, Usted puede resultar multado o enviado a prisión.”

Connecticut:

“UNLAWFUL STORAGE OF A LOADED FIREARM MAY RESULT IN IMPRISONMENT OR FINE.”

Florida:

“IT IS UNLAWFUL, AND PUNISHABLE BY IMPRISONMENT AND FINE, FOR ANY ADULT TO STORE OR LEAVE A FIREARM IN ANY PLACE WITHIN THE REACH OR EASY ACCESS OF A MINOR UNDER 18 YEARS OF AGE OR TO KNOWINGLY SELL OR OTHERWISE TRANSFER OWNERSHIP OR POSSESSION OF A FIREARM TO A MINOR OR A PERSON OF UNSOUND MIND.”

Maine:

“ENDANGERING THE WELFARE OF A CHILD IS A CRIME. IF YOU LEAVE A FIREARM AND AMMUNITION WITHIN EASY ACCESS OF A CHILD, YOU MAY BE SUBJECT TO FINE, IMPRISONMENT OR BOTH. KEEP FIREARMS AND AMMUNITION LOCKED UP. USE TRIGGER LOCKS.”

Maryland:

WARNING: “Children can operate firearms which may cause death or serious injury. It is a crime to store or leave a loaded firearm in any location where an individual knew or should have known that an unsupervised minor would gain access to the firearm. Store your firearm responsibly!”

Massachusetts:

“WARNING FROM THE MASSACHUSETTS ATTORNEY GENERAL: This handgun is not equipped with a de-

vice that fully blocks use by unauthorized users. More than 200,000 firearms like this one are stolen from their owners every year in the United States. In addition, there are more than a thousand suicides each year by younger children and teenagers who get access to firearms. Hundreds more die from accidental discharge. It is likely that many more children sustain serious wounds, or inflict such wounds accidentally on others. In order to limit the chance of such misuse, it is imperative that you keep this weapon locked in a secure place and take reasonable preventive steps necessary to limit the possibility of theft or accident. Failure to take reasonable preventative steps may result in innocent lives being lost, and in some circumstances may result in your liability for these deaths.”

“IT IS UNLAWFUL TO STORE OR KEEP A FIREARM, RIFLE, SHOTGUN OR MACHINE GUN IN ANY PLACE UNLESS THAT WEAPON IS EQUIPPED WITH A TAMPER-RESISTANT SAFETY DEVICE OR IS STORED OR KEPT IN A SECURELY LOCKED CONTAINER.”

New Jersey:

“IT IS A CRIMINAL OFFENSE TO LEAVE A LOADED FIREARM WITHIN EASY ACCESS OF A MINOR.”

New York City:

“THE USE OF A LOCKING DEVICE OR SAFETY LOCK IS ONLY ONE ASPECT OF RESPONSIBLE FIREARMS STORAGE. FOR INCREASED SAFETY, FIREARMS SHOULD BE STORED UNLOADED AND LOCKED IN A LOCATION THAT IS BOTH SEPARATE FROM THEIR AMMUNITION AND INACCESSIBLE TO CHILDREN AND OTHER UNAUTHORIZED PERSONS.”

North Carolina:

“IT IS UNLAWFUL TO STORE OR LEAVE A FIREARM THAT CAN BE DISCHARGED IN A MANNER THAT A REASONABLE PERSON SHOULD KNOW IS ACCESSIBLE TO A MINOR.”

Texas:

“IT IS UNLAWFUL TO STORE, TRANSPORT, OR ABANDON AN UNSECURED FIREARM IN A PLACE WHERE CHILDREN ARE LIKELY TO BE AND CAN OBTAIN ACCESS TO THE FIREARM.”

Wisconsin:

“IF YOU LEAVE A LOADED FIREARM WITHIN THE REACH OR EASY ACCESS OF A CHILD YOU MAY BE FINED OR IMPRISONED OR BOTH IF THE CHILD IMPROPERLY DISCHARGES, POSSESSES, OR EXHIBITS THE FIREARM.”

State laws and regulations concerning firearms change constantly. Please check with your local federally licensed firearm dealer or state police for additional laws and regulations regarding the storage and use of firearms in your state.



PERFECTION

GLOCK Ges.m.b.H.

Gaston Glock-Platz 1
A-2232 Deutsch-Wagram
AUSTRIA

Tel: +43 (0) 2247 - 90300-0
Fax: +43 (0) 2247 - 90300-312
Web: www.glock.com

GLOCK Inc.

6000 Highlands Parkway
Smyrna, GA 30082
U.S.A.

Tel: +1 770 - 432 1202
Fax: +1 770 - 433 8719
Web: www.glock.com

GLOCK International S.A.

Edificio PH Obarrio 60, Local 15-B
Calle 60 Este 6B, Barrio Obarrio
Ciudad de Panamá, PANAMÁ

Tel: +507 3866 186
Web: www.glock.com

GLOCK Asia Pacific Limited

Unit 3, LG/F, OB1, 92 Siena Avenue
DB North Plaza, Discovery Bay
Lantau, N.T., HONG KONG

Tel: +852 2375 - 3858
Fax: +852 2654 - 7089
Web: www.glock.com

GLOCK Middle East F.Z.E.

Dubai Airport Free Zone, West Wing 3,
Office 501, P.O. Box 54260, Dubai
UNITED ARAB EMIRATES

Tel: +971 - 4 - 299 5779
Fax: +971 - 4 - 299 4442
Web: www.glock.com



PERFECTION