



FALCON 50 PILOT TRAINING MANUAL

**VOLUME 2
AIRCRAFT SYSTEMS
SECOND EDITION**

REVISION 0.1

**FlightSafety International, Inc.
Marine Air Terminal, LaGuardia Airport
Flushing, New York 11371
(718) 565-4100
www.flightsafety.com**

FOR TRAINING PURPOSES ONLY

NOTICE

The material contained in this training manual is based on information obtained from the aircraft manufacturer's *Pilot Manuals* and *Maintenance Manuals* (Field CD). It is to be used for familiarization and training purposes only.

At the time of printing, it contained then-current information. In the event of conflict between data provided herein and that in publications issued by the manufacturer or the JAA/FAA, that of the manufacturer or the JAA/FAA shall take precedence.

We at FlightSafety want you to have the best training possible. We welcome any suggestions you might have for improving this manual or any other aspect of our training program.

NOTICE

These commodities, technology or software were exported from the United States in accordance with the Export Administration Regulations. Diversion contrary to U.S. law is prohibited.

FOR TRAINING PURPOSES ONLY

Courses for the Falcon 50 and other Dassault aircraft are taught at the following FlightSafety learning centers:

FlightSafety International
Houston Learning Center
7525 Fauna Street
Houston, TX 77061
Phone: (713) 393-8100
Toll-Free: (800) 927-1521

FlightSafety International
Paris Learning Center
BP 25, Zone d'Aviation d'Affaires
Bldg. 404, Aeroport du Bourget
93352 Le Bourget, CEDEX
FRANCE
Phone: +33 (1) 49-92-19-19
Fax: +33 (1) 49-92-18-92

INSERT LATEST REVISED PAGES, DESTROY SUPERSEDED PAGES

LIST OF EFFECTIVE PAGES

Dates of issue for original and changed pages are:

Second Edition.....0..... April 2008
Revision0.1 ... May 2015

NOTE:

For printing purposes, revision numbers in footers occur at the bottom of every page that has changed in any way (grammatical or typographical revisions, reflow of pages, and other changes that do not necessarily affect the meaning of the manual).

Page No.	*Revision No.	Page No.	*Revision No.
Cover	0.1	10-i-10-iv.....	0.1
Copyright.....	0.1	10-1-10-16	0.1
iii-vi.....	0.1	11-i-11-iv.....	0.1
1-i-1-iv	0.1	11-1-11-10	0.1
1-1-1-16	0.1	12-i-12-iv.....	0.1
2-i-2-iv	0.1	12-1-12-12	0.1
2-1-2-38	0.1	13-i-13-iv.....	0.1
3-i-3-iv	0.1	13-1-13-8	0.1
3-1-3-10	0.1	14-i-14-iv.....	0.1
4-i-4-iv	0.1	14-1-14-18	0.1
4-1-4-10	0.1	15-i-15-iv.....	0.1
5-i-5-iv	0.1	15-1-15-26	0.1
5-1-5-20	0.1	16-i-16-iv.....	0.1
6-i-6-iv	0.1	16-1-16-18	0.1
6-1-6-14	0.1	17-i-17-iv.....	0.1
7-i-7-iv	0.1	17-1-17-8	0.1
7-1-7-18	0.1	WA-1-WA-18.....	0.1
8-i-8-iv	0.1	APP-1-APP-2	0.1
8-1-8-6	0.1	ANN-1-ANN-4.....	0.1
9-i-9-iv	0.1		
9-1-9-10	0.1		

THIS PUBLICATION CONSISTS OF THE FOLLOWING:

*Zero in this column indicates an original page.

CONTENTS

Chapter 1	AIRCRAFT GENERAL
Chapter 2	ELECTRICAL POWER SYSTEMS
Chapter 3	LIGHTING
Chapter 4	MASTER WARNING SYSTEM
Chapter 5	FUEL SYSTEM
Chapter 6	AUXILIARY POWER UNIT
Chapter 7	POWERPLANT
Chapter 8	FIRE PROTECTION
Chapter 9	PNEUMATICS
Chapter 10	ICE AND RAIN PROTECTION
Chapter 11	AIR CONDITIONING
Chapter 12	PRESSURIZATION
Chapter 13	HYDRAULIC POWER SYSTEMS
Chapter 14	LANDING GEAR AND BRAKES
Chapter 15	FLIGHT CONTROLS
Chapter 16	AVIONICS
Chapter 17	MISCELLANEOUS SYSTEMS
WALKAROUND	
APPENDIX	
ANNUNCIATOR PANEL	

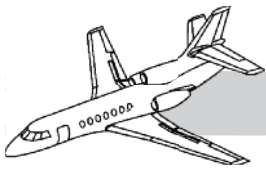

CHAPTER 1 AIRCRAFT GENERAL

CONTENTS

	Page
INTRODUCTION.....	1-1
GENERAL.....	1-1
STRUCTURES	1-3
General	1-3
Fuselage.....	1-4
Wing.....	1-10
Empennage.....	1-11
Aircraft Parking and Mooring.....	1-11
AIRCRAFT SYSTEMS	1-12
Electrical System	1-12
Lighting.....	1-12
Warning Systems	1-12
Fuel System.....	1-12
Auxiliary Power Unit	1-13
Powerplant.....	1-13
Fire Protection.....	1-13
Pneumatic System.....	1-13
Ice and Rain Protection.....	1-14
Air Conditioning	1-14
Pressurization.....	1-14
Hydraulic Power Systems	1-14

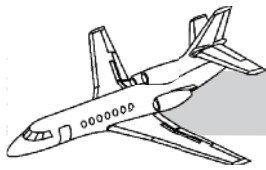

Landing Gear and Brakes	1-15
Flight Controls	1-15
Pitot-Static System.....	1-15
Oxygen System	1-16

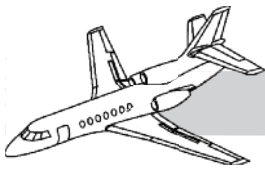

ILLUSTRATIONS

Figure	Title	Page
1-1	Falcon 50	1-2
1-2	Dimensions and Ground Clearances	1-2
1-3	Turning Radii	1-3
1-4	Structural View	1-3
1-5	Fuselage	1-4
1-6	Cockpit	1-5
1-7	Seats	1-5
1-8	Passenger Door	1-7
1-9	Baggage Compartment and Door	1-7
1-10	Aft Compartment and Door	1-8
1-11	Emergency Exit	1-9
1-12	Sliding Window Panel	1-9
1-13	Wing	1-10
1-14	Empennage	1-11

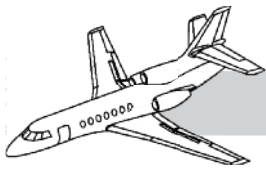

CHAPTER 1

AIRCRAFT GENERAL



INTRODUCTION

This training manual provides a description of the major airframe and engine systems installed in the Falcon 50. The information contained herein is intended only as an instructional aid. This material does not supersede, nor is it meant to substitute for, any of the manufacturer's system or operating manuals. The material presented has been prepared from the basic design data. All subsequent changes in aircraft appearance or system operation will be covered during academic training and in subsequent revisions to this manual.

GENERAL

The aircraft is manufactured by Avions Marcel Dassault Breguet Aviation. It is an all metal, sweptwing, three-engine monoplane designed to accommodate a crew of two and a maximum of ten passengers. A third seat is installed behind the pilot seat for use by a cockpit observer.

The Falcon 50 is equipped with three Garrett AiResearch TFE731-3 (or 3D) turbofan engines. Each engine is capable of producing 3,700 pounds of static thrust at sea level on a standard day.

The side engines are pylon-mounted on the aft fuselage, while the center engine is integrally mounted at the base of the vertical stabilizer. The center engine is equipped with a hydraulically operated thrust reverser.

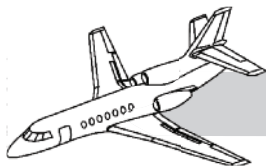

Figure 1-1. Falcon 50

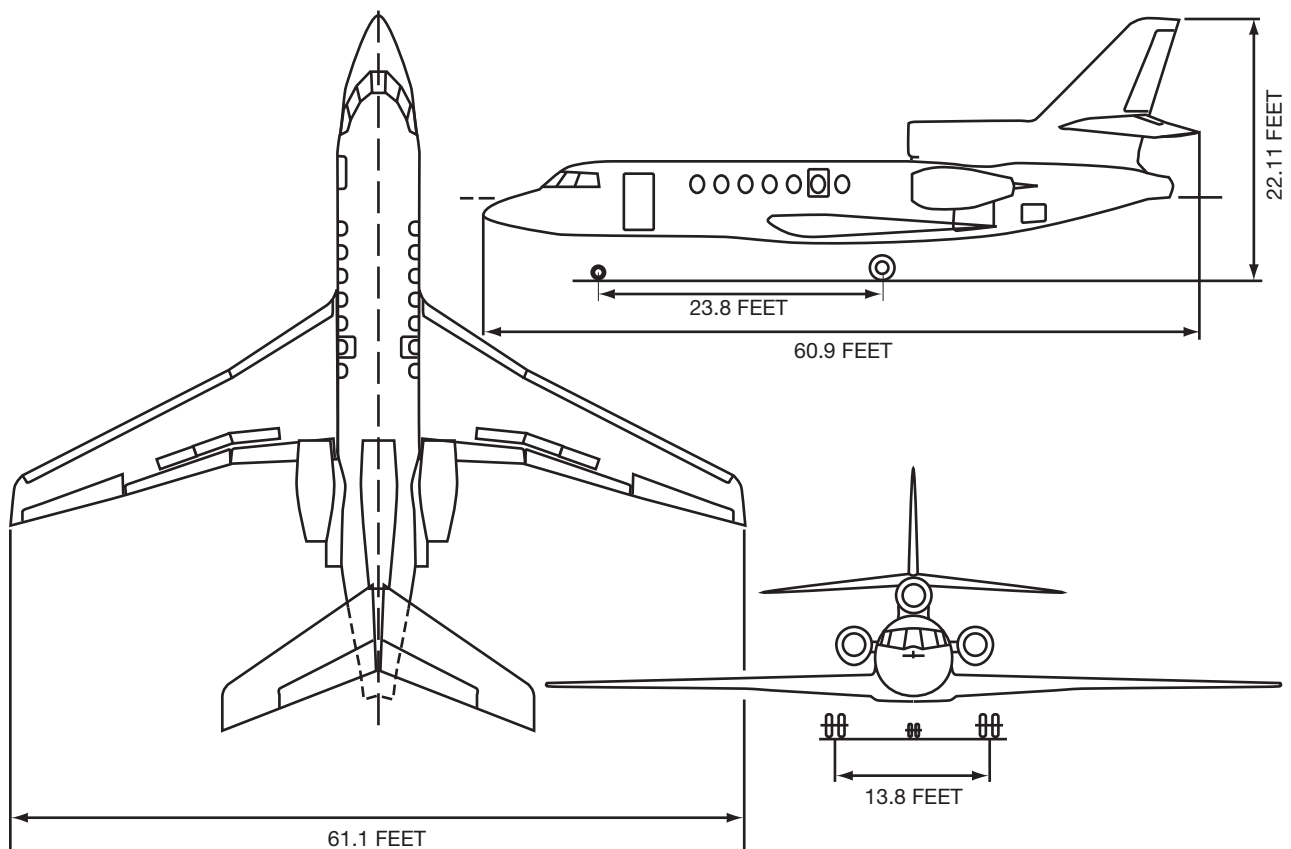

Figure 1-2. Dimensions and Ground Clearances

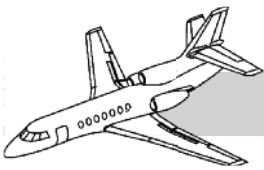

Figure 1-1 shows the Falcon 50, and Figure 1-2 displays the dimensions and ground clearances of the aircraft.

Figure 1-3 shows the turning radii applicable to the maximum nosewheel steering angle of 60 degrees, with the steering control engaged. The minimum turning radius with the steering control disengaged is 37.5 feet.

STRUCTURES

GENERAL

The aircraft is constructed mostly of high-resistance aluminum alloy. However, the ailerons are fabricated from composite materials. Titanium is used for slat and flap tracks. Figure 1-4 is the structural view of the Falcon 50.

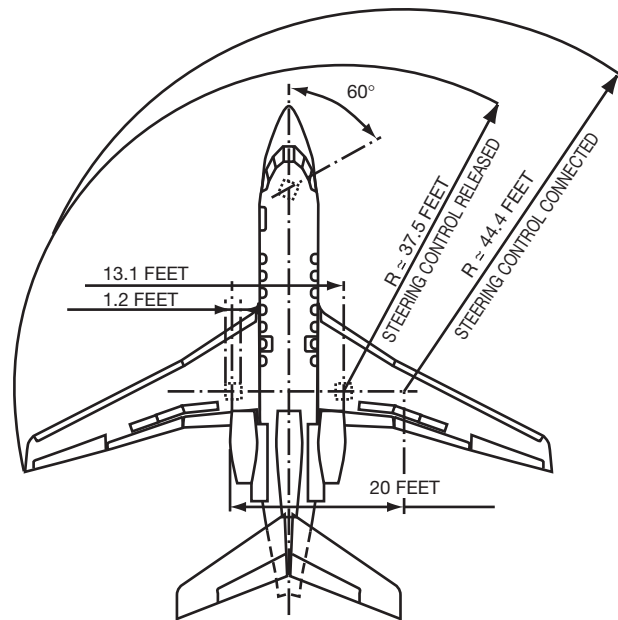

Figure 1-3. Turning Radii

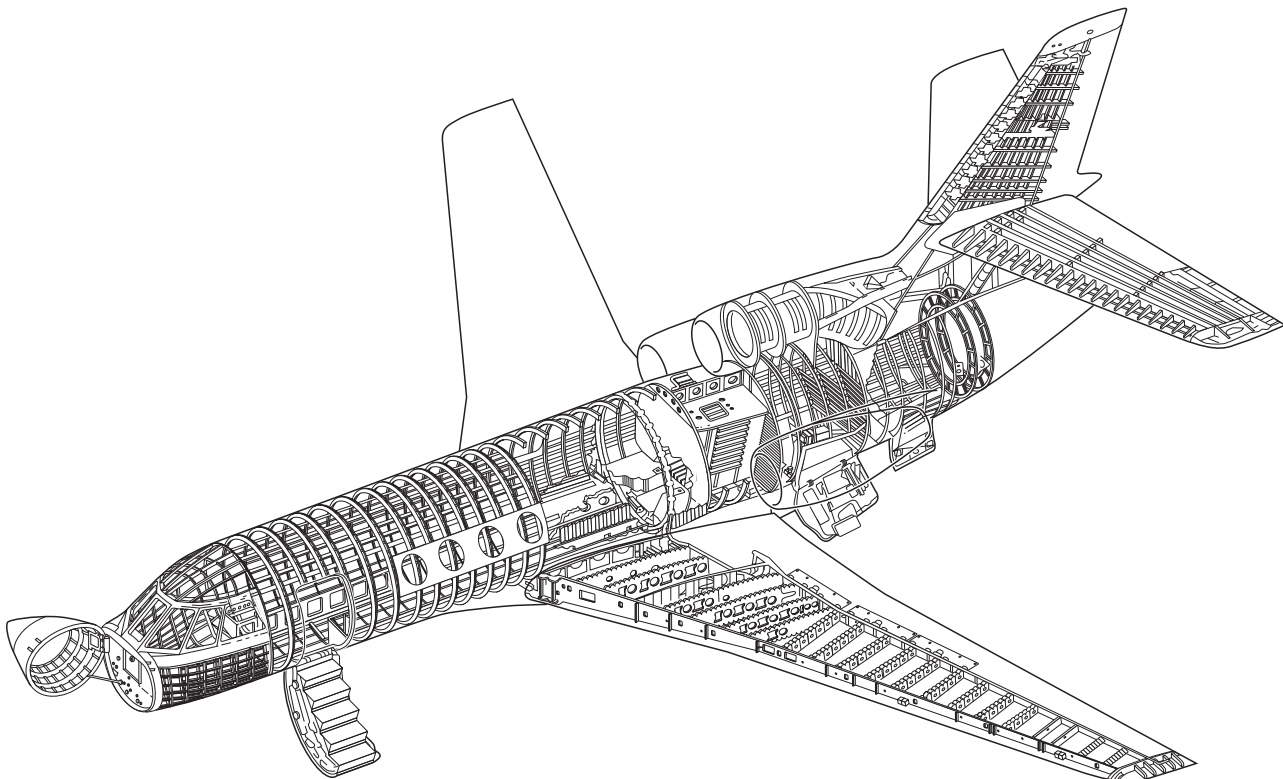
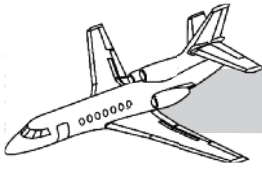

Figure 1-4. Structural View



FUSELAGE

The fuselage is a monocoque circular design. The fuselage is basically divided into five sections which include the following areas: cockpit, passenger cabin, feeder tanks, baggage compartment, and aft compartment (Figure 1-5).

The cockpit, passenger cabin, and baggage compartments are pressurized. These sections are designed for a normal rated differential pressure of 8.8 psi, or 9.1 differential with SB 163.

The cockpit and passenger cabin are sound-proofed, isolated, and protected against the effects of condensation from the air-conditioning system.

Nose Cone

The nose cone is partially pressurized. This section houses electrical components and avionics. The nose cone is opened by swinging it laterally to the right on hinge points.

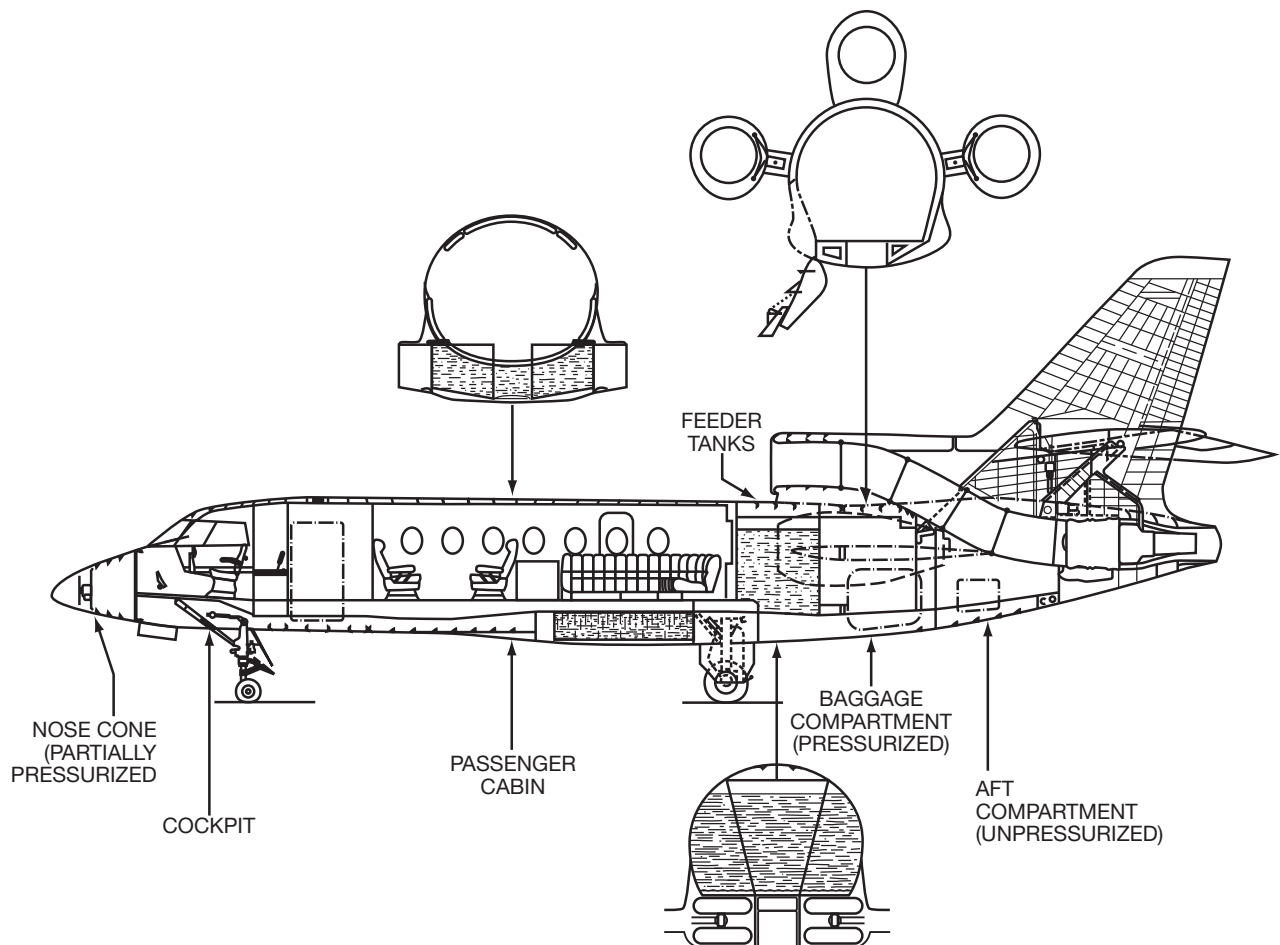
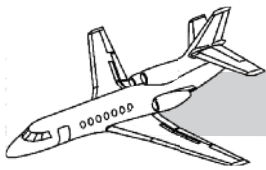

Figure 1-5. Fuselage



Cockpit

The cockpit is effectively divided by the flight compartment floor into upper and lower halves. The upper half comprises the flight compartment and includes some avionics equipment.

The flight compartment contains the aircraft instruments, caution warning lights, controls, circuit-breaker panels, two crew seats, an observer's seat, control columns, control wheels, and rudder pedals (Figure 1-6).

The lower half of the cockpit houses the nose wheel well and mounting structure. The nose landing gear assembly, mounted on the underside of the cockpit, is a conventional pneumatic, shock-absorbing strut fitted with two steerable wheels. The nose landing gear retracts forward into the well and is enclosed within the well by mechanically actuated doors.

Cockpit Seats

An individually adjustable six-way seat is installed for each pilot. The seats are manually adjustable fore and aft, and electrically adjustable up and down. In addition, they can be tilted back and forth. The armrests are adjustable individually up, down, fore and aft with switches located under each armrest. The seat adjustment controls and locations are illustrated in Figure 1-7.

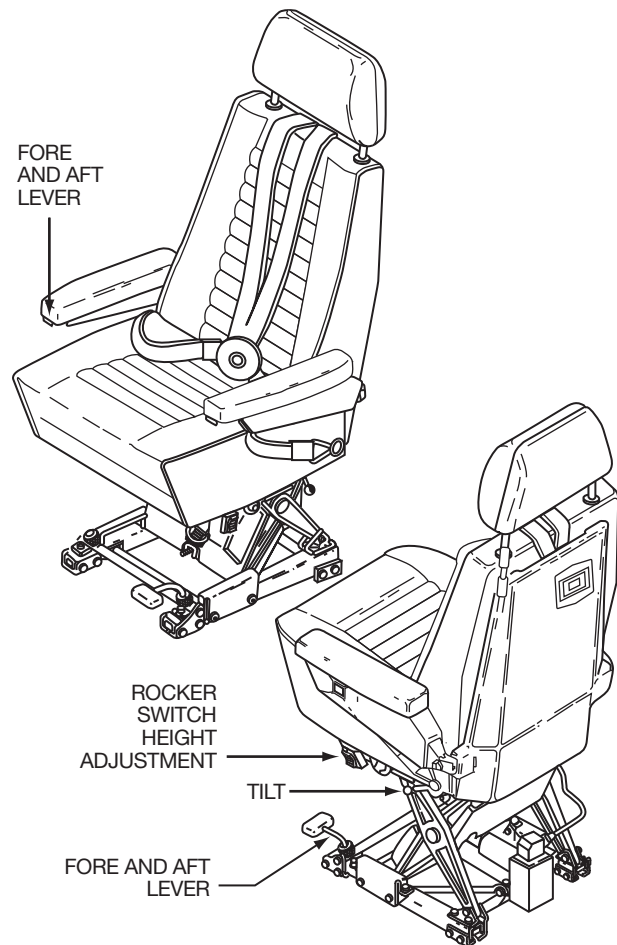
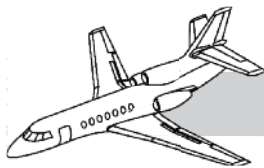

Figure 1-7. Seats



Figure 1-6. Cockpit



Passenger Cabin

The passenger cabin section is divided by the floor into the pressurized passenger area and three longitudinal underfloor sections. The underfloor sections house the flight control linkages, the wire bundles, and the air-conditioning plumbing. Hydraulic lines and fuel lines are routed outside the pressurized areas.

The passenger compartment incorporates the passenger-crew entrance door and two emergency exit hatches.

Fuselage Tank Section

A three-section feeder tank is installed just aft of the passenger cabin section. The tank is separated from the cabin by a machined frame. A similar frame separates the tank from the baggage compartment. Operation of the fuel system is covered in Chapter 5 of this manual.

Baggage Compartment

A pressurized baggage compartment is located just aft of the fuselage tanks. Access to the baggage compartment is provided by an external door.

Aft Compartment

An unpressurized aft compartment is located behind the baggage compartment. This compartment houses the main hydraulic and electrical system components, the air-conditioning system, aircraft batteries, and the optional APU.

In addition, the S-duct and its access door for the center engine is located at the top of this compartment. A firewall isolates the aft compartment from the No. 2 engine.

Dome Lights

Both the baggage compartment and the aft compartment are equipped with dome lights. The lights are turned on by microswitches when their respective doors are opened, and both auxiliary bus switches are in the ON position. In addition, at least one DC control switch must be on.

Doors

General

Doors consist of the passenger door, baggage compartment door, aft compartment door, emergency exits, and a door warning system.

Passenger Door

The passenger door is installed on the left forward side of the fuselage. The door is hinged at its lower part and opens outward and downward. When opened, the door is supported by telescopic rods, and a self-contained stairway and handrail are presented (Figure 1-8).

The door can be opened or closed from the inside or outside. It may be key locked from the outside using the same key as for the nose cone, the baggage compartment door, and the aft compartment door.

The pneumatic damper system partially compensates for the door weight and makes opening and closing easier.

The outer lock, safety lever, and handle are recessed in the door. The door-raising control lever is hinged on the fuselage surface. The door has storage in the second and third steps from the bottom.

Baggage Compartment Door

The door is opened by pressing a pawl located on the operating handle. Pressing the pawl causes the handle to pop out of its recess in the door structure. The handle is rotated downward. A flap is provided which, when pressed, allows the handle to be unlocked and removes residual pressurization in the baggage compartment (Figure 1-9).

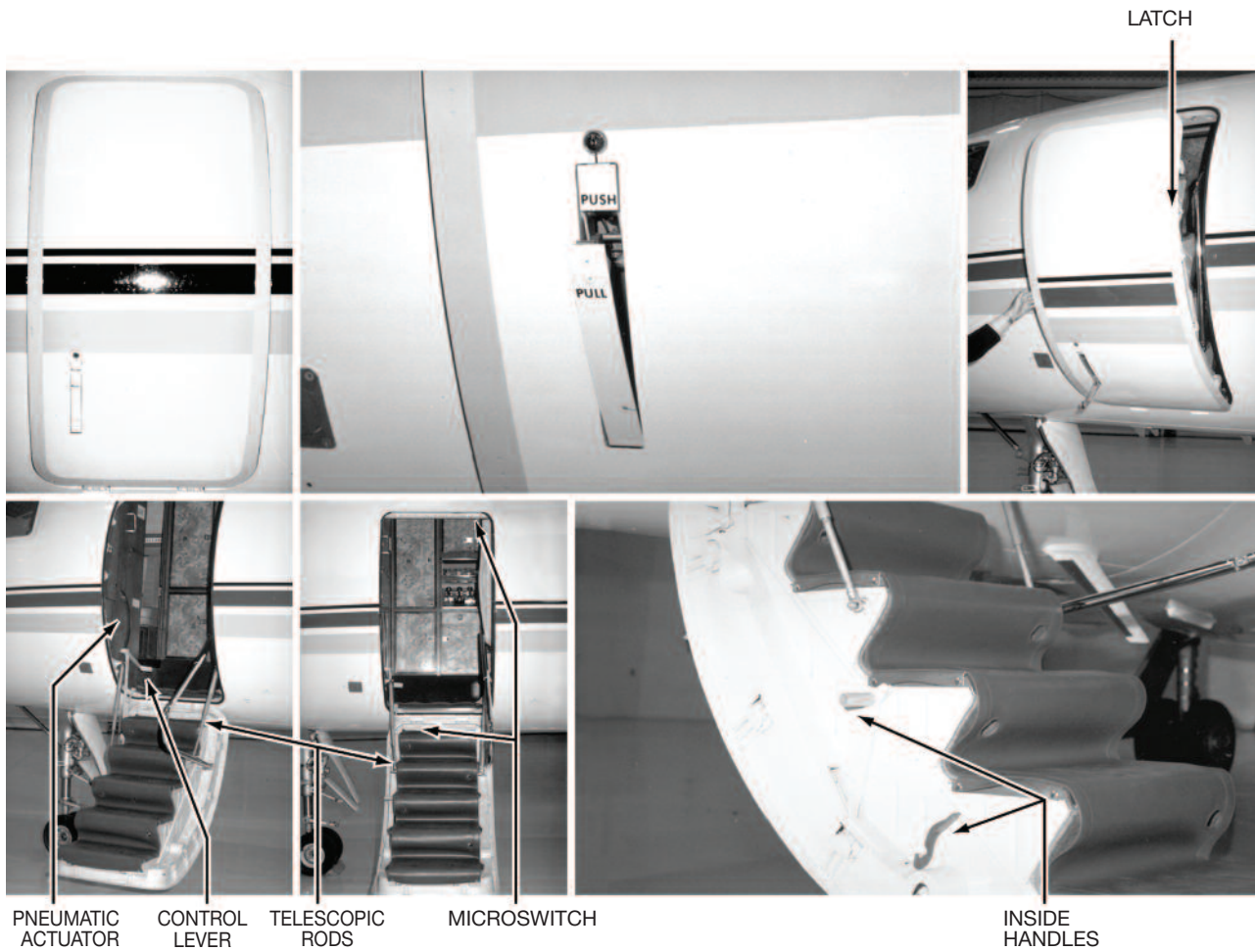
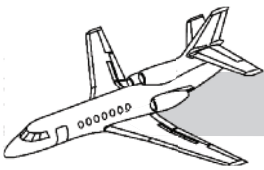

Figure 1-8. Passenger Door

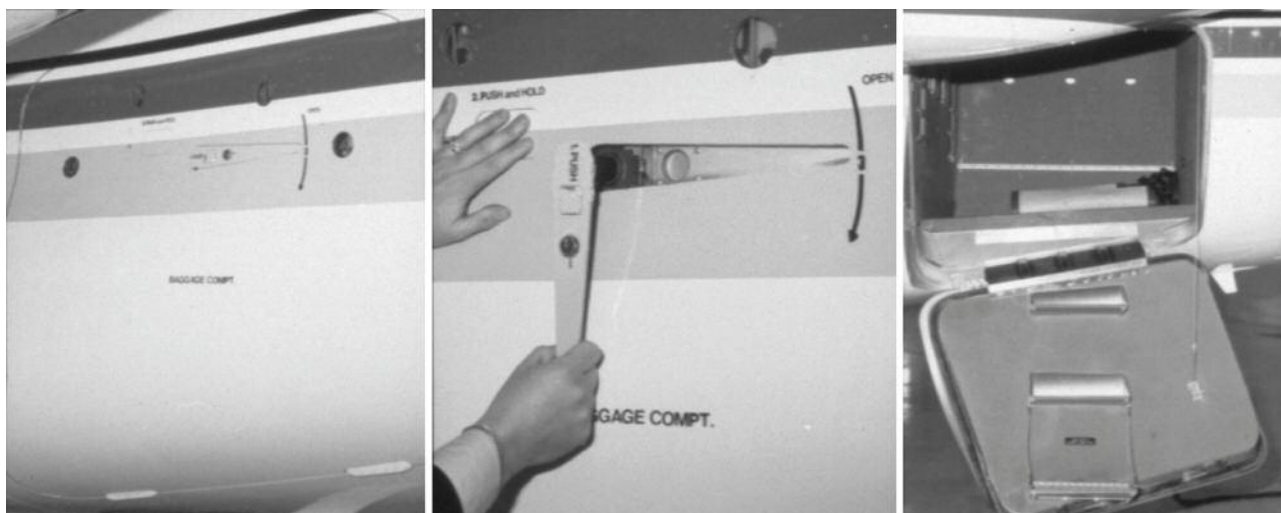
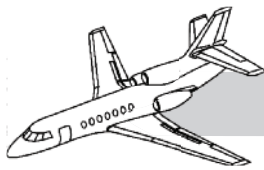

Figure 1-9. Baggage Compartment and Door



The compartment door is hinged at the bottom and swings outward and downward. It is counterbalanced by a bungee cord through a cable and pulley assembly.

The door is equipped with two fixed steps and a single hinged bottom step which may be folded outward and downward.

Proper closing of the door is verified by using four eyepieces located on the upper part of the door. Orange luminescent marks visible through the eyepieces must be aligned with associated marks on the eyepieces themselves. This indicates that the door bolts are properly engaged in their catches.

NOTE

On quick turns, **do not** leave the baggage compartment door open more than 20 minutes, or it may not close.

Aft Compartment Door

A single louvered door on the left side of the fuselage belly allows access to the aft compartment. The door is hinged at the bottom and opens outward and downward (Figure 1-10). The aft compartment door is opened by pressing a pushbutton to release the locking lever from its recess. The lever is pulled away from the door to release the catches.

Emergency Exits

The Falcon 50 has two emergency exits above the wings. The emergency exits include the sixth window structure on each side of the passenger cabin (Figure 1-11).

The exits are plug type and open inward. During pressurized flight, they are pressed outward against the fuselage by cabin pressurization.

The emergency exits can be opened from the inside by means of a handle located above each exit. The exits are opened from the outside by pressing a button located above each exit, provided the fuselage is depressurized first.

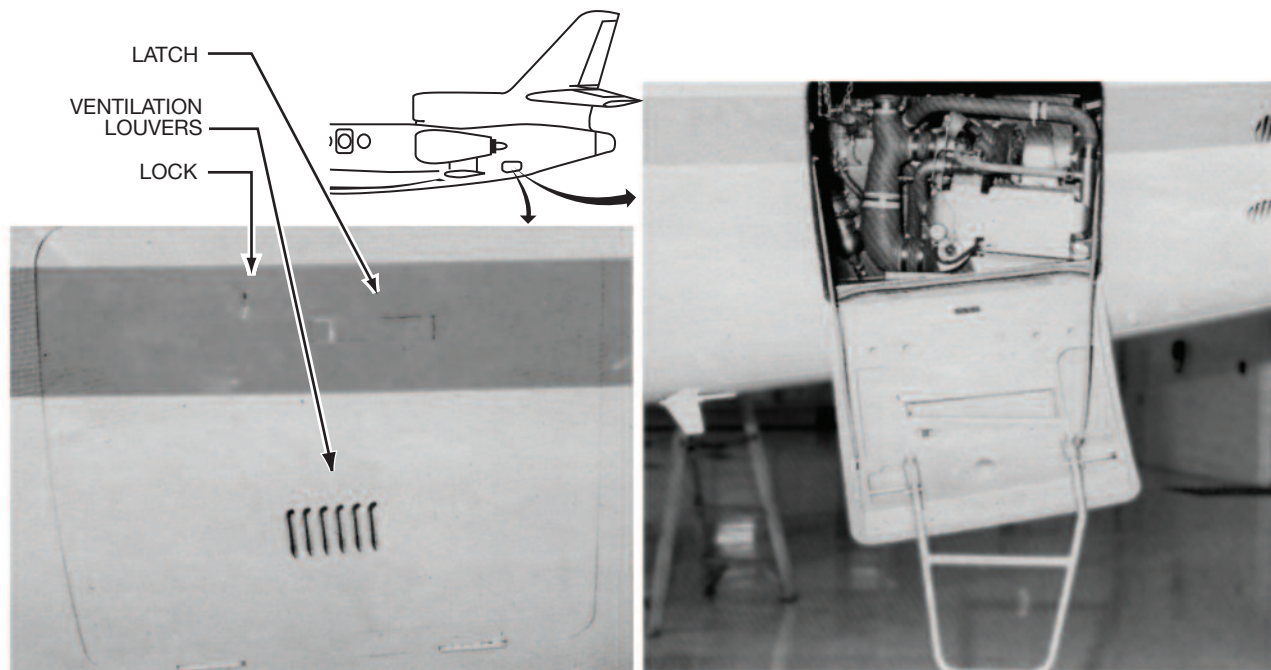

Figure 1-10. Aft Compartment and Door

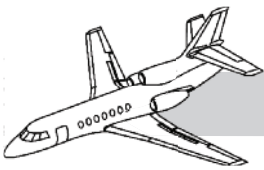

Figure 1-11. Emergency Exit

Door Warning System

The Falcon 50 is equipped with a door warning system. The warning system advises the pilot that the passenger door is either open or improperly latched.

The passenger door has three microswitches. Two are activated when the door opens. A third microswitch is activated when the door handle is not in the locked position.

The system also warns that the baggage compartment door, aft compartment door, or toilet-servicing door is open (front lavatory installations only).

Windows

The cockpit has seven windows. All the cockpit windows may be heated to protect against ice and mist formation. Heating of the left-hand aft window, however, is optional.

Operation of the windshield heaters is covered in Chapter 10, "Ice and Rain Protection."

The left-hand side window, which is fitted on tracks, may be opened by sliding it aft. This window may be used as an emergency exit in case evacuation is necessary (Figure 1-12).



SLIDING WINDOW PANEL SEEN FROM INSIDE

Figure 1-12. Sliding Window Panel

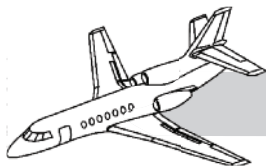

The passenger cabin has 14 ellipse-shaped windows. Each window is centered and secured in its frame by ten retainers.

Each window consists of two layers which are separated by a plexiglass shim. Air circulates between the two layers to ensure that mist does not form on the interior surfaces. Double protection against window failure is ensured, since each individual layer can withstand more than the rated pressurization loads.

WING

The Falcon 50 wing has a double-sweep tapered design. It is mounted low on the fuselage. The computerized, optimized wing design allows improved takeoff and landing performance and increased fuel tank volume without increasing its effective drag.

The wing basically consists of a box-type design with machined forward and aft spars sandwiched between six upper and lower load-carrying panels (Figure 1-13).

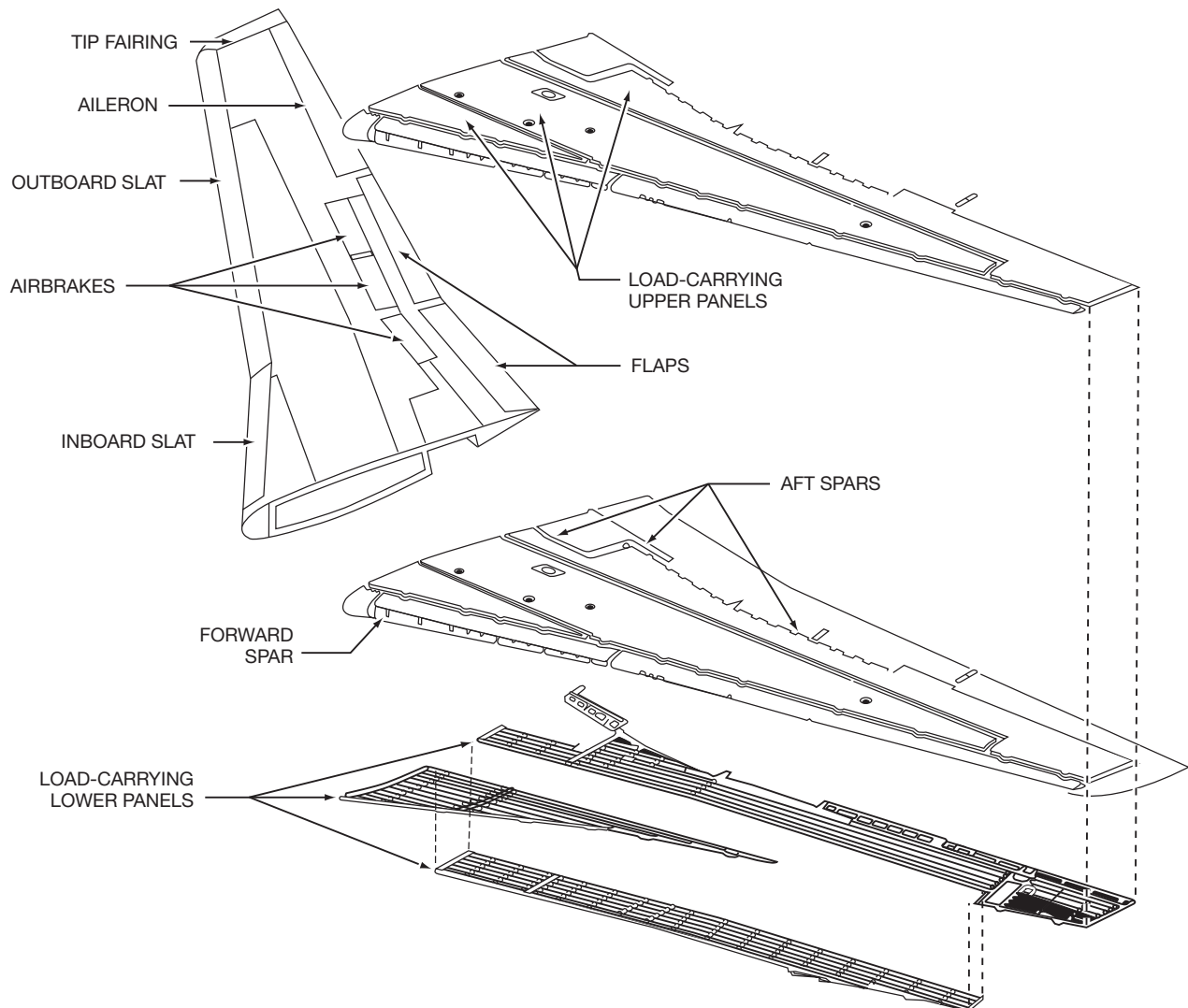
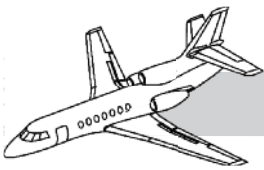

Figure 1-13. Wing



Each wing is bolted to the center wing section box. The center wing section also houses a fuel tank which is integral to the wing structure. Removable panels secured to the lower portion of each wing and centerwing provide access to these sections.

The exterior wing components include ailerons, inboard and outboard leading-edge devices, inboard and outboard flaps, three airbrake panels on each wing, and a wingtip fairing.

The aft spar on each of the wings supports the main landing gear forward hinge bearings. The forward wing spar supports the rollers for the leading edge slats.

EMPENNAGE

The empennage of the Falcon 50 consists of a vertical stabilizer, a movable horizontal stabilizer, elevators, and a rudder. The aircraft is not equipped with trim tabs (Figure 1-14).

The vertical stabilizer is a torsion box with two spars. It is attached to the fin stub by two fail-safe fittings and supports a single rudder.



Figure 1-14. Empennage

The horizontal stabilizer is composed of a forward spar, an aft spar, and three intermediate spars. The spars support a tapered laminated sheet which tapers from the root chord to the tip.

The horizontal stabilizer is attached to the fin stub at its trailing edge by a hinged fitting. An electrical jackscrew and scissors assembly at the leading edge allows the stabilizer to deflect around the hinged point. This allows trimming of the horizontal stabilizer.

Each half of the horizontal stabilizer has an elevator hinged to the trailing edge. The elevators are connected by means of a mechanical assembly that allows them to move in unison.

Operation of the flight controls and trim system are covered in the Flight Control Section of this manual.

AIRCRAFT PARKING AND MOORING

When the aircraft is stationary on the ground, precautions must be taken to ensure safety of personnel and equipment. The extent of safety measures to be observed depends upon the prevailing or expected weather conditions and the expected length of time the aircraft will be stationary. For complete safety, the aircraft should be parked in a hangar. If this is not possible, the aircraft must be parked or moored into the wind, with landing gear sleeves installed.

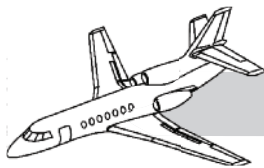

AIRCRAFT SYSTEMS

Electrical System

General

The electrical system is basically a 28-volt DC system. Electrical components which require AC power are supplied by static inverters.

DC System

DC electrical power is supplied by three engine-driven starter-generators, an auxiliary power unit (APU) starter-generator, or two 24–26-volt, 20-cell, 23-ampere-hour batteries. A ground power unit (GPU) also can be used to power the aircraft.

DC electrical power from the engine-driven generators and batteries is controlled and monitored by means of switches and indicators on the DC control panel located on the left side of the overhead panel.

Failure warning lights on the master caution panel monitor output, bus connection, and battery temperature. Battery temperature may be read on the indicator located on one of the forward instrument panels.

AC System

The 115-volt and 26-volt, 400-Hz AC systems are supplied by three 750-watt static inverters. Two are used for normal operations, while the third is a standby inverter. If the aircraft is equipped with an inertial navigation system (INS), a fourth inverter, identical with the others, supplies the INS.

The control panel for the AC power is located on the upper right of the overhead panel. Three switches control the static inverters.

Three switchlights, a single voltmeter and two warning lights, located on the master caution panel allow the pilot to monitor the output of any of the four inverters.

LIGHTING

The lighting system, controlled from the cockpit, provides illumination both externally and internally throughout the aircraft. The exterior lighting includes navigation lights, anticollision lights, wingtip strobe lights, landing lights, taxi lights, wing ice detection spotlights, and compartment lights. The interior lighting includes passenger area lights, service compartment lights, and flight compartment lights.

In addition, the aircraft is equipped with an emergency lighting system which illuminates areas used for emergency evacuation.

WARNING SYSTEMS

Warning systems provide the flight crew with 38 visual indications of system malfunctions through the master caution system and draw attention to 7 certain significant events through the audio warning system.

FUEL SYSTEM

The fuel system has two wing tanks, a wing center section tank, and three feeder tanks installed in the rear fuselage. Together, the tanks have a total usable fuel capacity of 15,513 pounds (2,315 gallons).

Fuel is transferred by transfer pumps and jet pumps. A pair of transfer interconnect valves allows fuel from any of the main tanks to reach any of the feeder tanks.

Booster pumps installed in each of the feeder tanks supply fuel to the engines. Crossfeed valves permit operation of two or three engines from a single booster pump.

Single-point pressure-fueling and overwing fueling is provided.

The fuel system is controlled by a fuel system panel in the center of the overhead panel.

Fuel quantity is displayed on gages mounted in the center instrument panel.

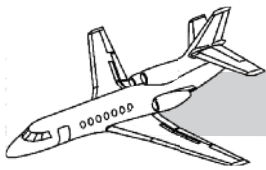

AUXILIARY POWER UNIT

The Falcon 50 may be equipped with an optional gas turbine auxiliary power unit manufactured by Garrett Turbine Engine Company GTCP36-100A or with the Solar T-40 unit. The APU is installed in a fireproof container in the rear fuselage compartment. It is designed for ground use only.

The APU provides regulated DC power for operation of the electrical components as well as for engine starting and battery charging. In addition, the APU supplies bleed air to the aircraft's environmental system for ground heating and cooling.

The APU is controlled from a single panel located on the copilot console. The fire panel contains provision for control of the APU fire protection system.

POWERPLANT

The engines are twin-spool, medium bypass turboprops. The TFE731-3-1C (3D) engines are manufactured by the Garrett Turbine Engine Company.

The TFE731-3-1C (3D) engine has a forward fan on a single-stage, high-pressure, centrifugal compressor and a four-stage, low-pressure axial flow compressor. The forward fan is driven by the axial flow compressor through a gearbox.

The turbine section consists of a single-stage, high-pressure turbine disc and three axial, low-pressure turbine discs.

Each engine is equipped with an accessory section. The accessory gearbox drives oil pumps, fuel pumps, a hydraulic pump, and a starter-generator.

Each engine is normally controlled by a computer using a conventional throttle lever on the pedestal, and engine performance is monitored by cockpit gauges and warning lights.

A hydraulically operated clamshell thrust reverser is provided on the center engine. The

thrust reverser is controlled with a lever mounted on the No. 2 throttle lever. Lights to indicate reverser operation are provided on the lower part of the center instrument panel and on the master caution panel.

FIRE PROTECTION

The Falcon 50 has a fire protection system which both detects and extinguishes fire on the aircraft.

The fire detection system warns the pilot of fire or overheat in the engines, APU, aft compartment, baggage compartment, and main landing gear wheel wells. The fire-extinguishing system allows application of an extinguishing agent to each of these areas except the wheel wells.

All protected areas except the baggage compartment use fire detection loops which sense excessively high temperatures and trigger visual and aural warnings. The baggage compartment is equipped with an optical smoke detector which triggers the appropriate warnings.

The control switches for the fire bottles are located on the fire protection panel below their associated lights. For most switch positions, electrical power for extinguishing is supplied directly from the battery.

PNEUMATIC SYSTEMS

The pneumatic system distributes engine bleed air for use in engine anti-icing, airframe anti-icing, air conditioning, pressurization, and various other systems.

Bleed air can also be supplied by the optional APU, but only while on the ground. APU bleed air is not used for the anti-icing system, or tank pressurization.

Low-pressure air is supplied anytime one of the engines is running. High-pressure air may be turned off with switches on the bleed-air panel. When the switch is in automatic, valve opening is determined by the position of the anti-ice switches.

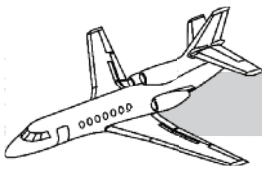

Bleed system operation is monitored by sensors that cause illumination of lights on the master warning panel.

ICE AND RAIN PROTECTION

The ice and rain protection systems prevent ice formation on the engine intake areas, wings, windshields, and pitot-static openings. Windshield wipers and demisting systems ensure unobstructed vision through the aircraft's windshield.

The engine anti-icing system uses hot bleed air from the bleed-air system to prevent ice formation on the engine nacelle lips, fan, or critical areas in the No. 2 engine S-duct. Bleed air is also used to prevent ice formation on the wing leading edges.

Ice formation on the windshield and side windows is prevented by electrically heated networks built into the glass panes. The pitot tubes, static ports, stall vanes, and the total ambient temperature probe are anti-iced electrically.

The aircraft is equipped with two conventional, motor-driven windshield wipers.

The interior of early model aircraft windshields may be demisted by using an electric blower and duct system which directs air against the windshields. The air may be electrically heated when selected.

AIR CONDITIONING

Two separate systems supply conditioned air to the cockpit and cabin. Should one system fail, the other system is capable of providing air conditioning and pressurization to both sections.

Cold air is produced by two environmental control units (ECU's). During ground operations, the ECU's may be supplied with bleed air from the APU.

Temperature control valves are controlled either manually or automatically through a temperature control system.

An overheat condition in either of the air-conditioning systems is indicated by a light on the master warning panel.

PRESSURIZATION

Air for cabin pressurization is supplied by the air-conditioning system. The pressurization system controls the cabin pressure by actuating the outflow valves. The system is designed to maintain a maximum cabin altitude of 8,000 feet at a flight altitude of 45,000 feet. This corresponds to a differential pressure of 8.8 psi or 9.1 psid for aircrafts with SB 163.

Each outflow valve protects against overpressure and has negative pressure relief as well. The system is also protected against a cabin pressure higher than 12,500 feet.

A triple indicator provides the pilot with a means to monitor system performance.

Emergency operation of the pressurization system is initiated by placing the pressurization switch in the MAN position and rapid depressurization can be achieved with the DUMP position.

A warning light and a silenceable horn activates if cabin altitude exceeds 10,000 ±500 feet.

HYDRAULIC POWER SYSTEMS

The Falcon 50 uses hydraulic pressure in the operation of the flight controls, slats, flaps, airbrakes, landing gear, wheel brakes, nosewheel steering, thrust reversers, and artificial feel units.

The aircraft has two independent hydraulic systems powered by hydraulic pumps driven by the engines. An electric motor-driven pump is used as a standby.

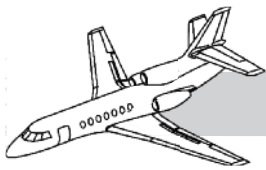

The controls and indicators for the hydraulic system are located on the hydraulic system indicator/control panel on the center instrument panel. The hydraulic panel contains switches, gauges, and indicating lights.

LANDING GEAR AND BRAKES

The Falcon 50 is equipped with fully retractable tricycle landing gear. The normal extension and retraction system is electrically controlled and hydraulically operated.

The nose gear assembly and both main gear assemblies are equipped with twin wheels. The nose gear assembly includes an electrohydraulic steering system and each main wheel has a hydraulic brake.

Normal extension and retraction of the landing gear is controlled with a conventional handle on the instrument panel.

The landing gear may be extended hydraulically in an emergency by using the red EMERG-GEAR PULL handle located adjacent to the normal gear handle. In addition, the gear may be gravity-lowered by mechanically releasing the landing gear uplocks, using the unlock release handles.

If electric and hydraulic power is available to the gear, they will be hydraulically and mechanically held down and locked. If no power is available, then they are mechanically downlocked. The landing gear are always mechanically uplocked.

The brakes are operated by using either the normal brake system, the emergency system, or the emergency parking system.

Nosewheel steering is engaged by pushing in on the control wheel. The wheel is spring-loaded to the neutral position. Steering is disengaged at liftoff when the nose gear strut expands.

FLIGHT CONTROLS

The elevator, rudder, and ailerons on the Falcon 50 are hydraulically operated. Each control surface is dual-actuated by independent hydraulic actuators powered by each of the two hydraulic systems. Loss of hydraulic pressure to one of the dual actuators does not affect the operation of the other actuator.

In case of total hydraulic failure, the aircraft may be controlled manually.

Pitch trim is fully electrical and controlled by means of normal trim switches on the control wheels and an emergency trim switch on the center pedestal. Aileron and rudder trim switches are also located on the pedestal.

Trim indicators for rudder, aileron, and stabilizer are located on the center instrument panel.

The aircraft has hydraulically operated leading-edge slats and trailing-edge flaps controlled by a single cockpit lever.

The outboard slat can also be controlled electrically by a switch or by the stall vanes.

The Falcon 50 is equipped with three airbrakes attached to the upper surface of each wing. They are controlled by the airbrake control lever on the trim panel.

PITOT-STATIC SYSTEM

The Falcon 50 is equipped with two independent pitot systems and three separate static systems.

The pilot pitot system supplies pressure to the pilot Mach-air speed indicator and the air data computer.

The copilot pitot system supplies pressure data to the copilot Mach-air speed indicator, the wing slat system, the landing gear warning system, and the aileron Arthur Q unit.

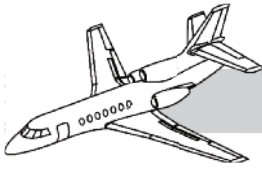

The pilot static system supplies static pressure data to the standby altimeter and the pilot vertical velocity indicator. In addition, the system is the normal static source for the pilot Mach-air speed indicator and the air data computer.

The pilot alternate static system is a backup source of static pressure data to the pilot Mach-air speed indicator and the air data computer.

The copilot static system is used for the:

- Copilot Mach-air speed indicator
- Copilot vertical velocity indicator
- Copilot altimeter
- Wing slat system
- Landing gear warning system
- Aileron and elevator artificial feel units
- Cabin pressurization system

Air Data Computer(s)

The Falcon 50 is equipped with a central air data computer (CADC). The computer corrects raw pitot-static inputs and produces electronically corrected electrical pitot-static data. A few aircraft have one air data computer, but most have two.

OXYGEN SYSTEM

The Falcon 50 is equipped with a single cylinder to supply oxygen to both the crew and passenger systems.

The crew compartment is equipped with two quick-donning masks with integral controls. The passenger compartment is equipped with drop masks. The passenger system is controlled from the cockpit using a rotary oxygen controller.

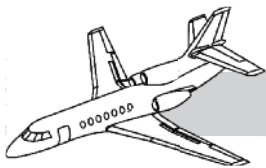

CHAPTER 2

ELECTRICAL POWER SYSTEMS

CONTENTS

	Page
INTRODUCTION.....	2-1
GENERAL.....	2-1
DC System.....	2-2
AC System.....	2-2
DC POWER SYSTEM.....	2-3
Distribution.....	2-3
BAT (1 or 2).....	2-6
AC POWER SYSTEM.....	2-23
Normal Inverters (Pilot, Copilot, and Standby).....	2-23
Two-Inverter System.....	2-24
INS Inverter.....	2-26
LIMITATIONS.....	2-29
DC Power Limitations.....	2-29
AC Power Limitations.....	2-29
Starter Limitations.....	2-29
TROUBLESHOOTING.....	2-30
CIRCUIT-BREAKER LISTING.....	2-34
QUESTIONS.....	2-36

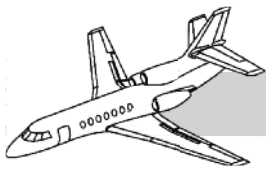

ILLUSTRATIONS

Figure	Title	Page
2-1	Electrical Component Locations.....	2-2
2-2	Electrical Control Panel.....	2-3
2-3	Circuit-Breaker Panels.....	2-4
2-4	Bus Tie Relay Circuit Breakers (Rear Compartment).....	2-5
2-5	Battery Indications.....	2-7
2-6	Battery Temperature Indicator	2-7
2-7	Hot Battery Bus Circuit—After S/B 318	2-8
2-8	DC Operation.....	2-9
2-9	Starter-Generator and APU Generator.....	2-9
2-10	Generator Indications	2-11
2-11	DC Electrical System—Configuration No. 1.....	2-12
2-12	DC Electrical System—Configuration No. 2.....	2-13
2-13	DC Electrical System—Configuration No. 3.....	2-14
2-14	DC Electrical System—Configuration No. 4.....	2-15
2-15	DC Electrical System—Configuration No. 5.....	2-16
2-16	DC Electrical System—Configuration No. 6.....	2-17
2-17	DC Electrical System—Configuration No. 7.....	2-18
2-18	DC Electrical System—Configuration No. 8.....	2-19
2-19	DC Electrical System—Configuration No. 9.....	2-20
2-20	DC Electrical System—Configuration No. 10.....	2-21
2-21	DC Electrical System—Configuration No. 11.....	2-22
2-22	Ground Power	2-23
2-23	Inverter Control and Indication	2-25

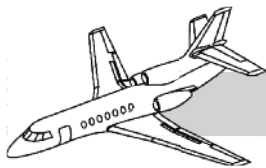

2-24	AC Power System	2-26
2-25	Simplified AC Power System	2-27
2-26	Total Electrical System.....	2-28
2-27	Start and Dry Motoring Sequence.....	2-29
2-28	Trouble Situations.....	2-30

TABLES

Table	Title	Page
2-1	Nicad Battery Specifications	2-6
2-2	Ground Power Functions and Indications.....	2-24
2-3	Circuit-Breaker Listing.....	2-34

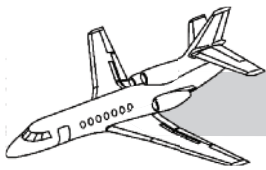

CHAPTER 2

ELECTRICAL POWER SYSTEMS

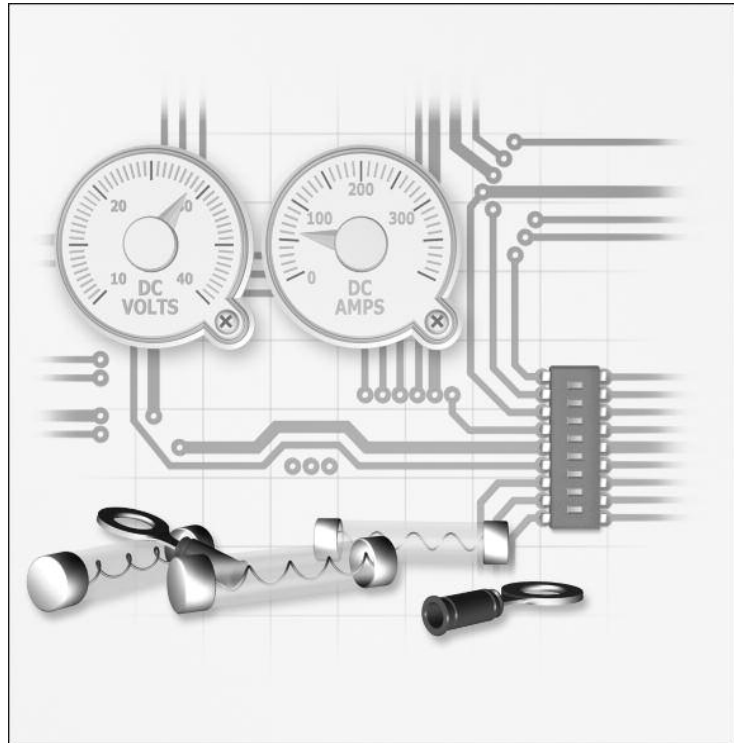

INTRODUCTION

The electrical system for the Falcon 50 consists of the DC system, the AC system, and their distribution. For aircrafts with an auxiliary power unit (APU) installed, a discussion on APU operation is included. The electrical chapter concludes with a section on specific limitations.

GENERAL

Electrical power is provided by a 28.5-volt DC supply system and by a 115-volt, 400-Hz and a 26-volt, 400-Hz power supply system. The DC system supplies 28.5 volts to the battery, start, main, and secondary buses which,

in turn, supply 28.5-volt power for inverter conversion. Since DC power must be available before AC power is possible, this chapter begins with the DC power system.

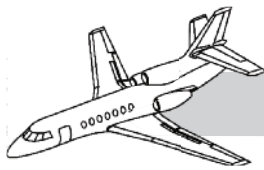

DC SYSTEM

The DC power system is supplied by the three engine-driven, 9-kw, 300-ampere starter-generators, as shown in Figure 2-1. For aircrafts with an APU installed, a fourth generator, driven by the APU, is provided.

Two 23-ampere-hour batteries are used. They provide a backup source of DC power and a means of starting the engines on the ground or in the air. Ground power may be connected to the aircraft via a ground power receptacle; it can be used to start the engines, APU, or to power the electrical system. It cannot be used to charge aircraft batteries.

The DC power is distributed by two independent subsystems which may be interconnected for safety reasons—and to minimize the effect of a distribution failure. The various aircraft

components to be supplied are divided between the two systems. In addition, within each system, the services to be supplied are again divided between two distribution buses. One directly supplies a components bus through a cockpit-controlled relay. These controlled buses are called load-shed buses.

AC SYSTEM

Aircraft not equipped with modification M1703 will have a three-inverter system consisting of inverter No. 1, inverter No. 2, and a standby inverter. This will include aircraft from SN 003 through SN 224. When the inverter switches are selected to on, DC power is applied to the 750-VA solid-state static-type inverters which, in turn, produce AC power and distribute it to the AC power buses. If either of these inverters fail, a third inverter

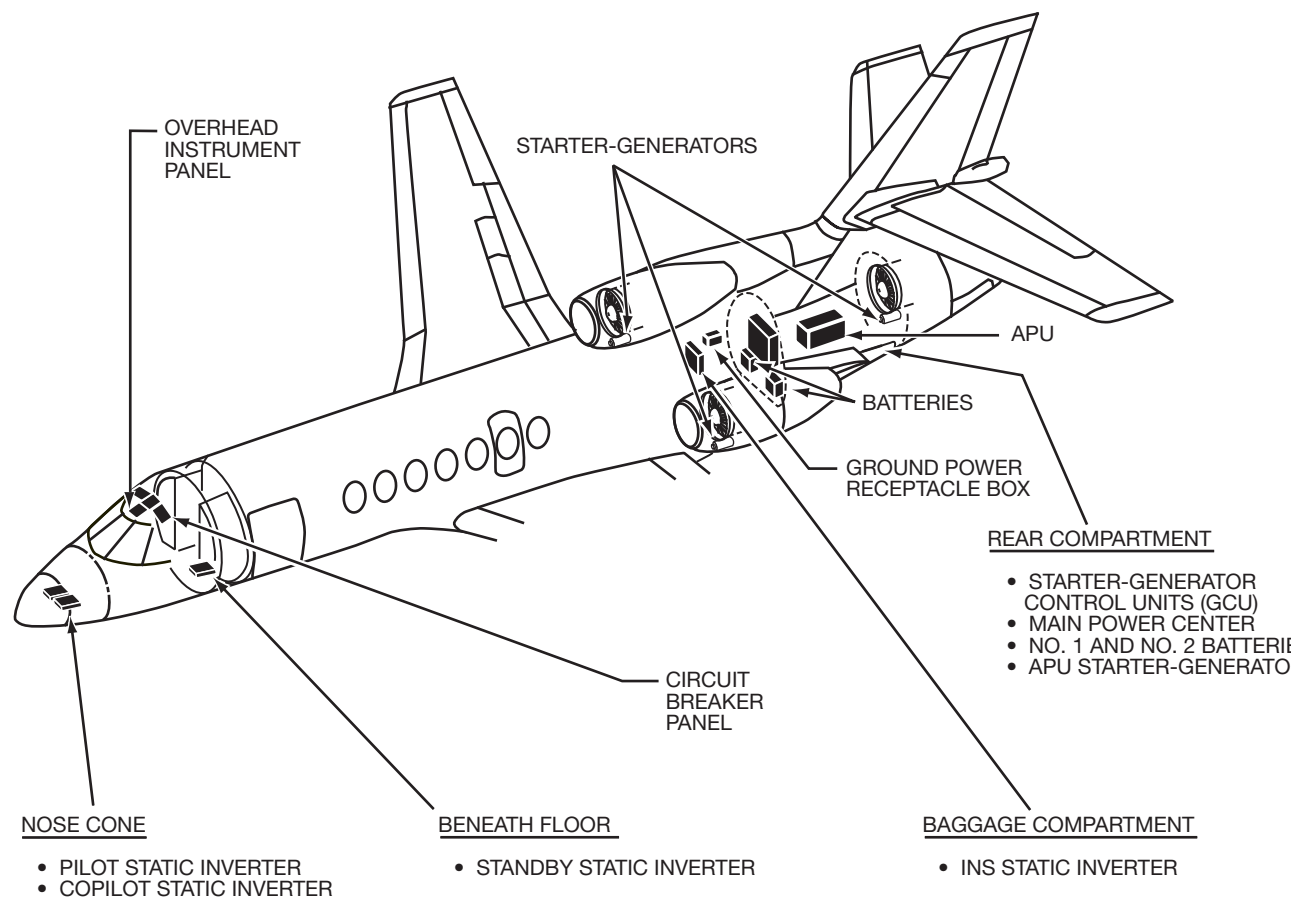
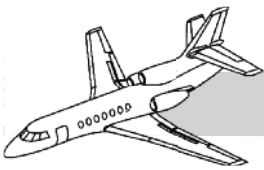

Figure 2-1. Electrical Component Locations



(standby inverter) may be selected to provide AC power in place of the failed inverter. If an inertial navigation system (INS) is installed, a fourth inverter is provided to power the INS exclusively.

Most of the aircraft SN 225 through SN 252 will be equipped with just two 350-VA solid-state static-type inverters. There is no standby inverter in this system. If an inverter fails, that inverter's bus system will be without power with no way to supply it from any other source. This is called the "simplified power AC generation system."

DC POWER SYSTEM

DISTRIBUTION

DC Buses

The distribution of DC power is through the left-hand (LH) and right-hand (RH) main buses. These buses are located in the lower section of the DC main power center in the rear compartment. They are isolated to ensure separation of the LH and RH distribution center circuits.

The LH main bus supplies the primary A bus and auxiliary C bus which may be load shed (Figure 2-2).

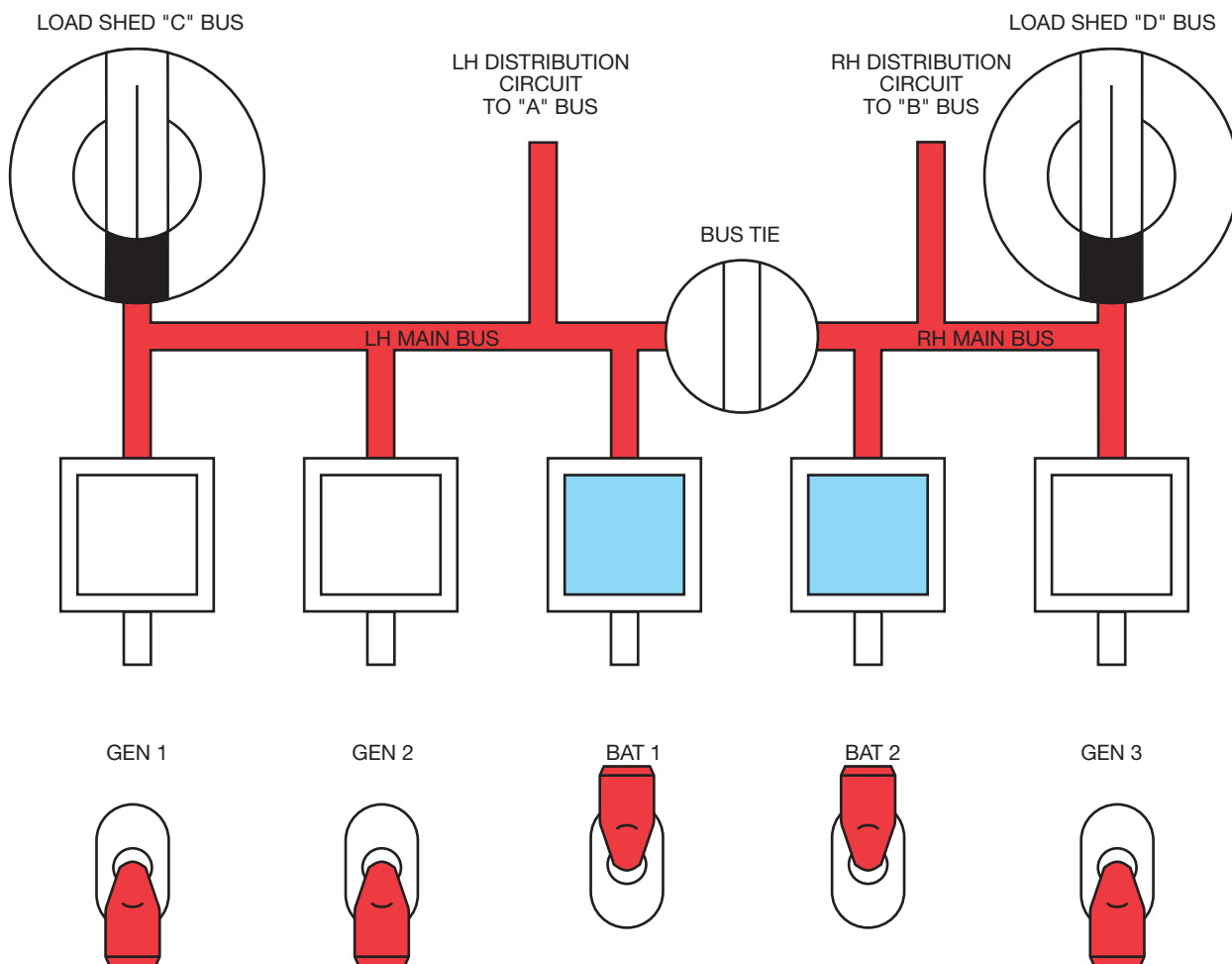
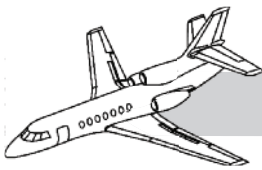

Figure 2-2. Electrical Control Panel



The RH main bus supplies the primary B bus and the auxiliary D bus, which also may be load shed.

Circuit Breakers

For circuit protection, there are three circuit-breaker panels (Figure 2-3) that collectively control DC power distribution. The LH panel

contains some of the breakers for buses A and C. The center circuit breaker panel contains most of the breakers for buses A, B, C, and D. The RH panel, however, contains breakers for buses A, B, and D. All breakers are color coded to indicate either primary circuit (white), secondary circuit (green), both primary buses (red), or AC (gray) association.

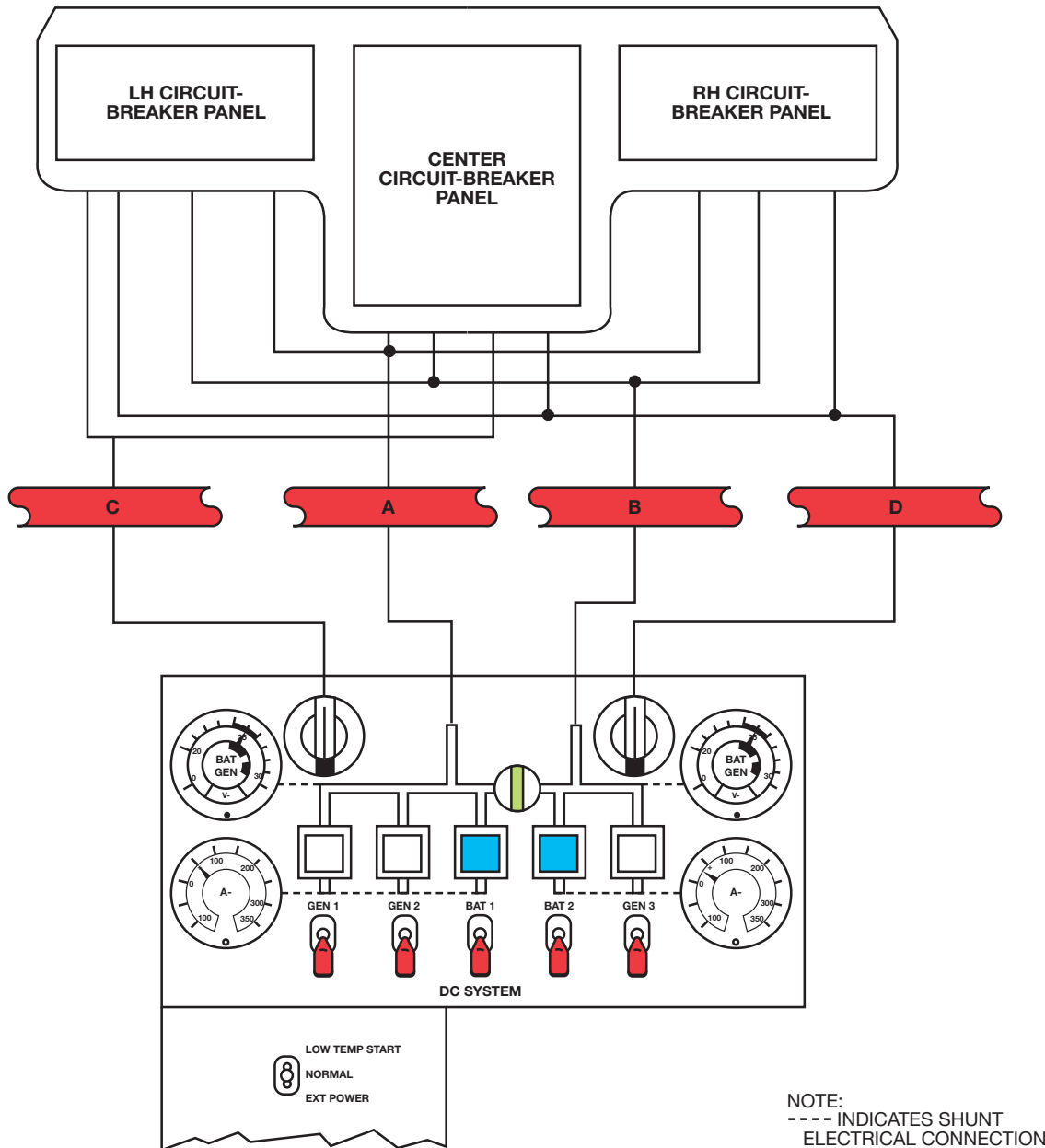
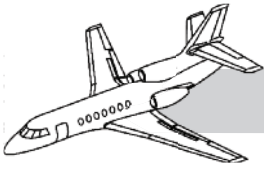

Figure 2-3. Circuit-Breaker Panels



Load shedding, a means of quickly reducing the overall DC load, is provided through two switches on the electrical control panel. The LH switch sheds the C bus, and the RH switch sheds the D bus. Either switch will cause shedding of the flight compartment dome lights, entrance lighting, rear compartment light, nose area light, and baggage compartment lighting.

Current Limits

The generators are operationally limited to a continuous current of 300 amperes and load limiting of 350 amperes for 1 minute. Each generator can supply maximum current at an operating speed of 6,200-12,000 rpm up to an altitude of 39,000 feet. Above 39,000 feet, the amperage load is limited to 250 amperes. Each battery has a continuous initial charge current rating of 220 amperes. Above 250 amperes, the BAT switch trips, in 50 seconds (time proportional to charge current).

Bus Tie System

A bus tie switch is provided to interconnect buses when No. 3 generator fails or any two generators fail without a bus short. This switch controls a relay which connects the LH and RH main buses in the main power center.

Figure 2-4 shows the circuit for the bus tie relay. The circuit breakers are located in the rear compartment. Circuit breaker 51p2 provides continuity for the 3-minute time delay associated with generator output reduction during engine start.

The bus tie relay can be energized from either bus. If either circuit breaker is popped, the other provides continuity. To determine which is popped, both voltmeters must be read.

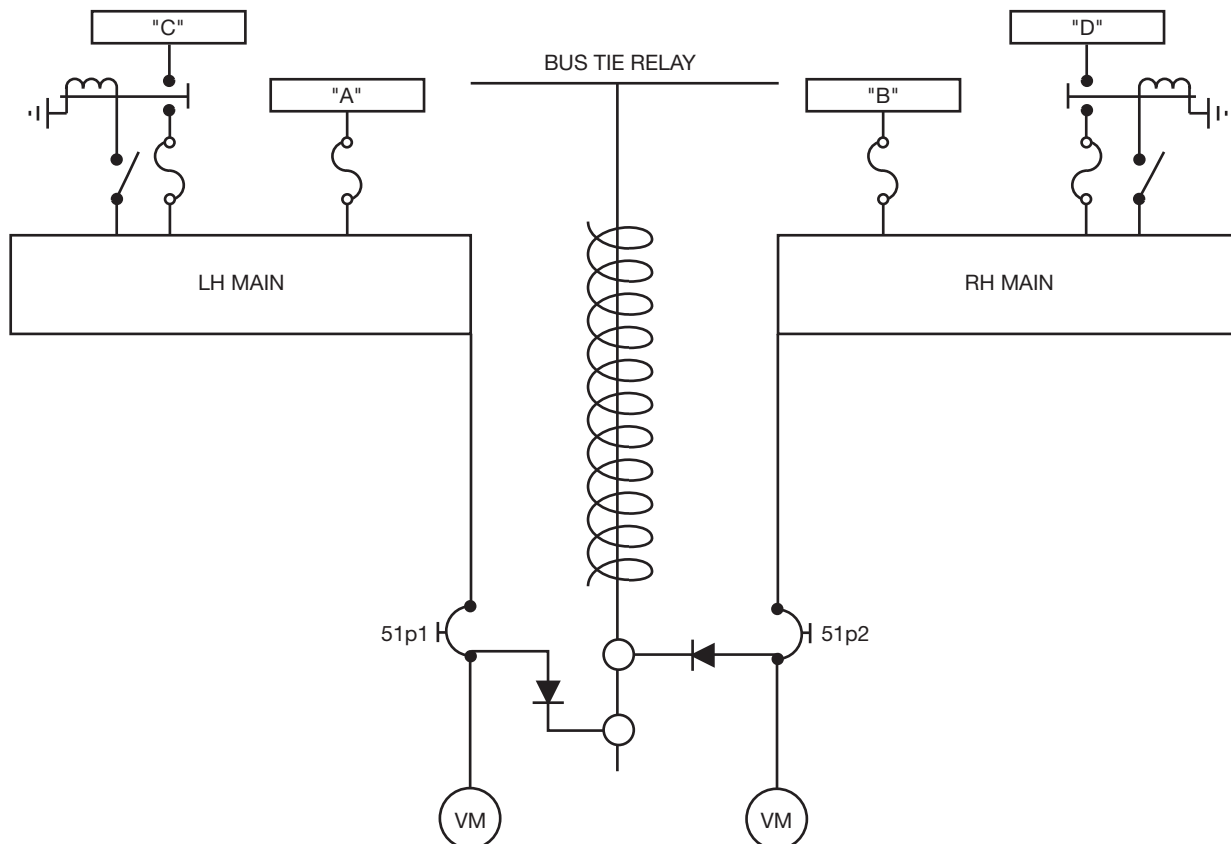
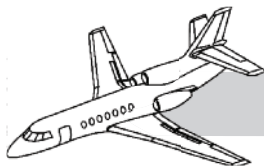

Figure 2-4. Bus Tie Relay Circuit Breakers (Rear Compartment)



Batteries

There are two 20-cell, nickel-cadmium batteries located in the rear compartment. The nominal voltage is 24-26 volts with an output capacity of 23 ampere-hours in parallel (Table 2-1).

Individually or in series, these batteries can be used to start the engines or to provide power to other aircraft services. The APU cannot be started in series.

Battery control is incorporated into the DC SYSTEM panel in the form of individual switches, one switch for each battery. The battery switches will automatically trip in the event of a reverse flow to the battery of 250 amperes or more.

To indicate battery functioning and provide for current monitoring, pushbutton switchlights are provided on the DC SYSTEM panel, as shown in Figure 2-3. The switchlights illuminate blue when depressed, thus indicating that they are operating properly and, at the same time, that the ammeter is connected to the corresponding battery circuit.

BAT (1 OR 2)

A light on the master warning panel (Figure 2-5) is provided to indicate the disconnection of the batteries from the main bus, and a HOT BAT light indicates battery overtemperature. Two temperature probes are connected in parallel to a HOT BAT light on the master

Table 2-1. NICAD BATTERY SPECIFICATIONS

CAPACITY
<ul style="list-style-type: none"> • 23 amps/hour • 20 cells • 24 to 26 volts • 22 volts minimum start limitations for engine start/23 volts minimum for APU start • If generators fail, 20 minutes in load shed, 10 minutes if EFIS-equipped
PROTECTION
<p>RCR:</p> <ul style="list-style-type: none"> • 18 volts minimum to close • 8 to 11 volts to hold closed (RCR opens no trip) • Opens with a reverse current of 250 amps, switches trip (50 sec.)
INDICATION
<ul style="list-style-type: none"> • Volts and amps • Temperature indication, American planes—Less 50° • Warning lights
MISC.
<ul style="list-style-type: none"> • Blower cooled on ground (No. 2 battery switch), venturi air-cooled in flight • Aircraft will draw: <ul style="list-style-type: none"> • Left main bus—50 amps* • Right main bus—30 amps*

* Upper-limit values

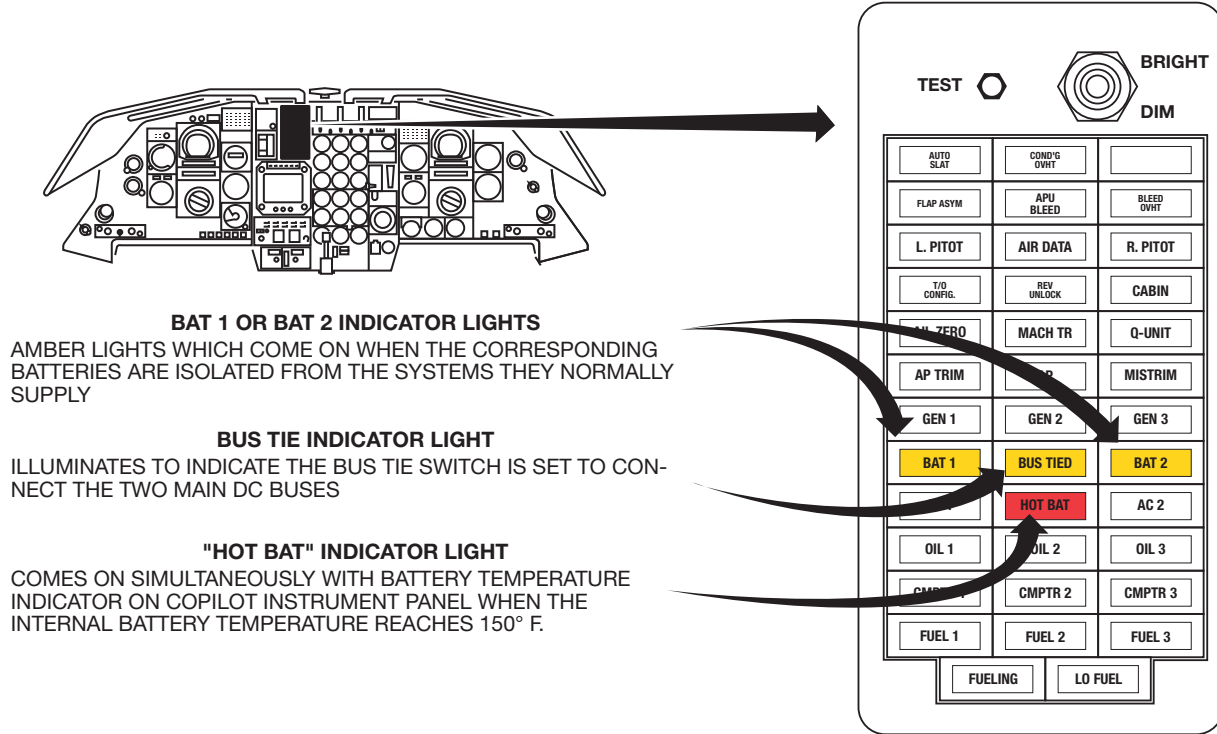
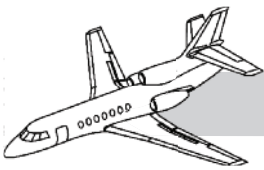

Figure 2-5. Battery Indications

warning panel. The light comes on if the internal temperature of either battery reaches 150°F. Each probe is also connected to a battery temperature indicator on the copilot instrument panel. The indicator is provided with a temperature scale for each battery (Figure 2-6). In addition, an amber WARM light on the temperature indicator comes on when the temperature of either battery exceeds 120°F; a HOT light for either battery comes on at 150°F. There is a LESS 50°F pushbutton which provides a means of reading an off-scale value. When the button is depressed, 50°F must be subtracted from the indicated value for a true temperature reading.

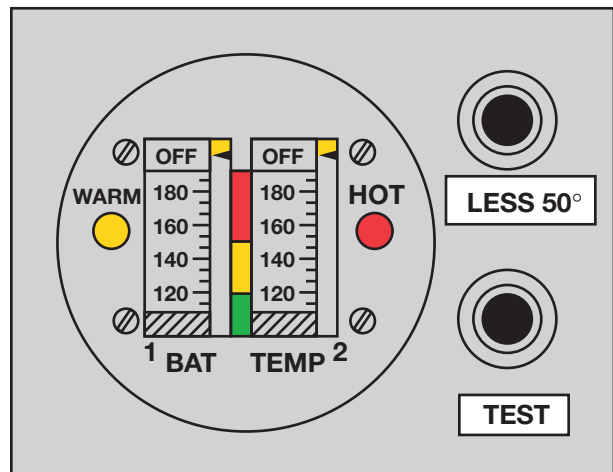
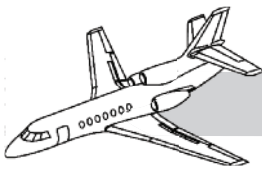

Figure 2-6. Battery Temperature Indicator



Operation

As soon as the batteries are connected, the No. 1 battery supplies power for the battery bus and the start bus. The No. 2 battery supplies power directly to the battery bus only.

Figure 2-7 shows the hot battery bus circuit.

- Pressure refueling system
- Fire extinguishers
- APU door-closing circuit (early aircrafts only; later aircrafts supplied from B bus)

NOTE

Certain items of equipment are directly supplied from the battery bus. They are:

- Lighting system

The power-up sequence is described below. Position BAT 1 switch to ON (Figure 2-8).

In this mode, the No. 1 battery supplies power to the LH main bus. The LH main bus then energizes the A and C buses. Power is applied to some master warning panel lights, and the BAT 1 indicator light is out.

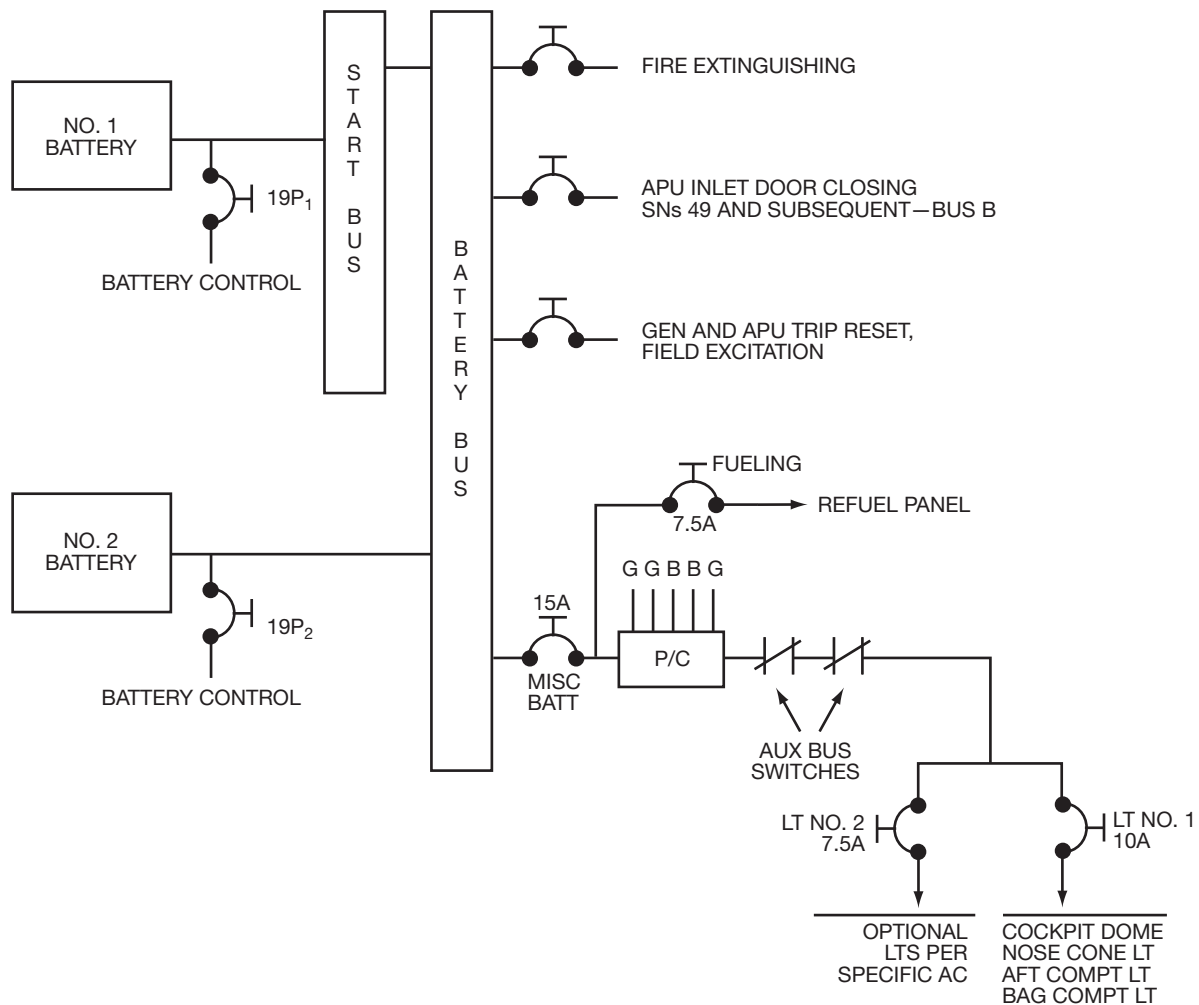
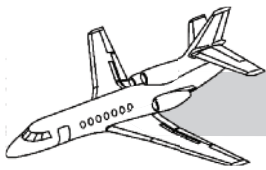

Figure 2-7. Hot Battery Bus Circuit—After S/B 318



NOTE

The battery switches will automatically trip in the event of an excessive charge rate.

As soon as power is on the A bus, the blue BAT 1 light comes on, and the LH main bus voltage will be indicated on the LH voltmeter. The LH ammeter indicates current being supplied by the No. 1 battery.

NOTE

It is not necessary to depress the battery blue light unless a generator is selected first.

The BAT 2 switchlight performs a similar function for the RH side.

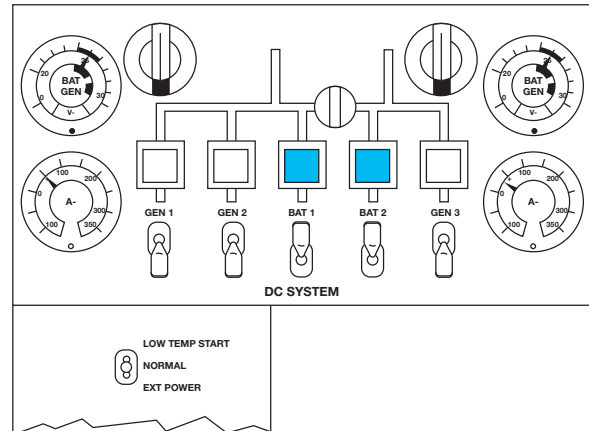

Figure 2-8. DC Operation

Generators

The three engine-driven starter-generators are identical (Figure 2-9).

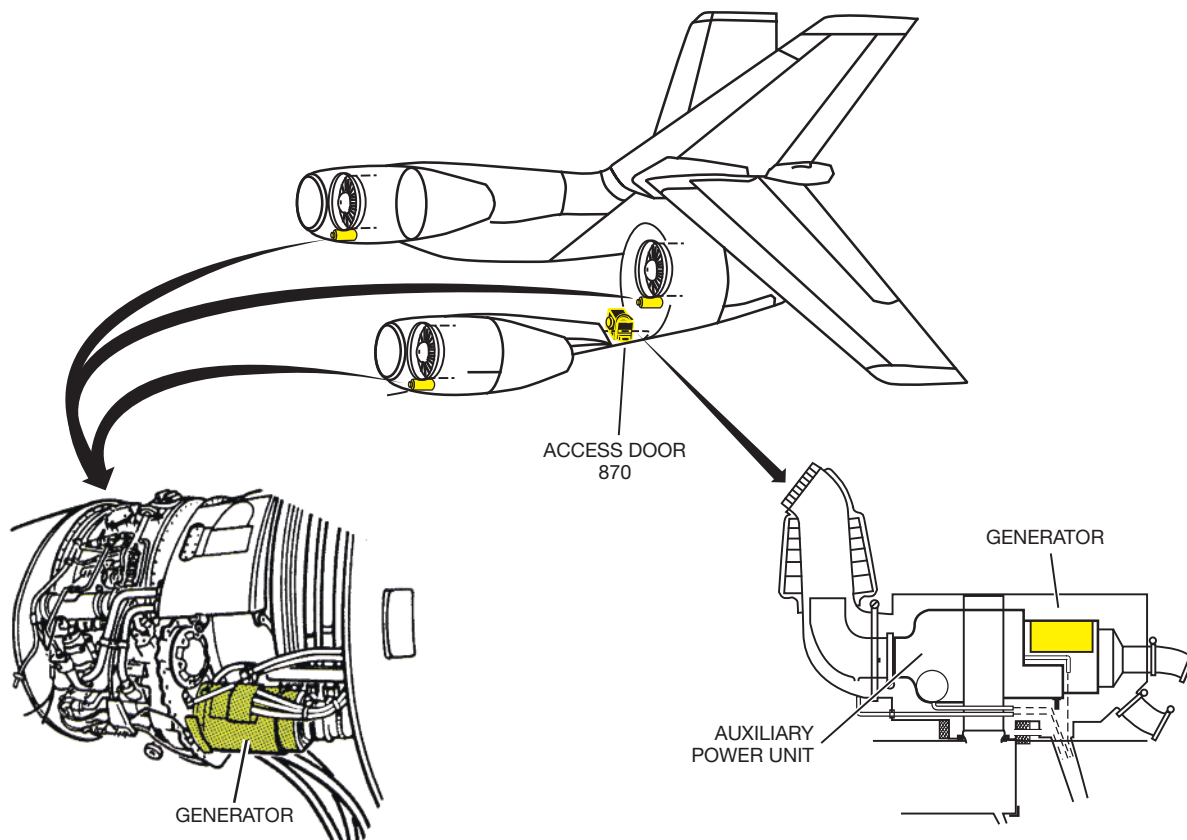
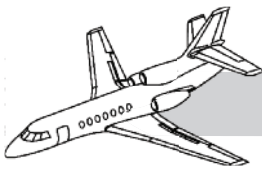

Figure 2-9. Starter-Generator and APU Generator



Generator characteristics are as follows:

- Maximum nominal voltage adjusted to 28.5 VDC
- Maximum authorized output—300 amperes maximum continuous and 250 amperes above FL 390
- Operating speed—6,200 to 12,000 rpm

The starter-generators are self-cooled and have a starting amperage draw of 900 amperes. The APU generator has a starting amperage draw of 600 amperes.

Each starter-generator operates in conjunction with a control unit (GCU) and performs the following functions:

- Regulates voltage to 28.5 VDC
- Load-shares between generators
- Provides 32-VDC overvoltage protection
- Provides generator load limitation of 375 amperes
- Reduces generator output to 27.5 VDC for 3 minutes if any engine or the APU is started

In addition, the GCU progressively weakens the field of the corresponding starter-generator during engine starting and limits battery charging current following engine starting.

Each starter-generator is connected to one of the main buses through a reverse-current relay.

Connection is made when the starter-generator output voltage exceeds the bus voltage by 0.3 to 0.8 VDC.

The connecting circuit is broken for a reverse-current. This occurs when the respective generator is being overpowered by a supply on the bus or, the respective generator cannot maintain the required potential matching the other generators on line with it.

The engine-driven starter-generators are mounted on the underside of each engine within the cowling. The APU generator is located in the aft compartment within the APU shroud.

To facilitate generator control, there are guarded isolation switches located on the main power center. When closed, they apply 28.5 VDC to close the generator load-sharing relays. They are also used to isolate individual generators from the main bus by opening the generator RCR for adjustment and test when the aircraft is on the ground. These switches are normally used for maintenance applications.

The generator-control switches located on the overhead control panel are mechanically latched and serve to control generator excitation. If a generator fails because of overvoltage or overcurrent, the corresponding switch automatically returns to the OFF position. Returning the switch to the ON position should accomplish normal reset.

Generator operation can be verified by depressing the blue GEN switchlight shown in Figure 2-10. When depressed, the light illuminates and the corresponding generator's current is displayed on the ammeter.

If for any reason the starter-generator becomes isolated from the system it normally supplies, the corresponding amber GEN light on the annunciator panel illuminates.

The starter-generators provide power for the main DC buses and, in certain cases, the start bus.

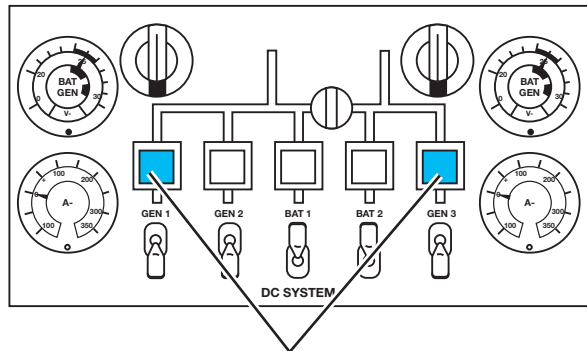
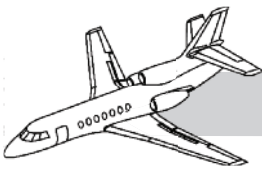

ILLUMINATE BLUE WHEN DEPRESSED
AND DISPLAY CORRESPONDING GENERATOR
CURRENT ON THE AMMETER

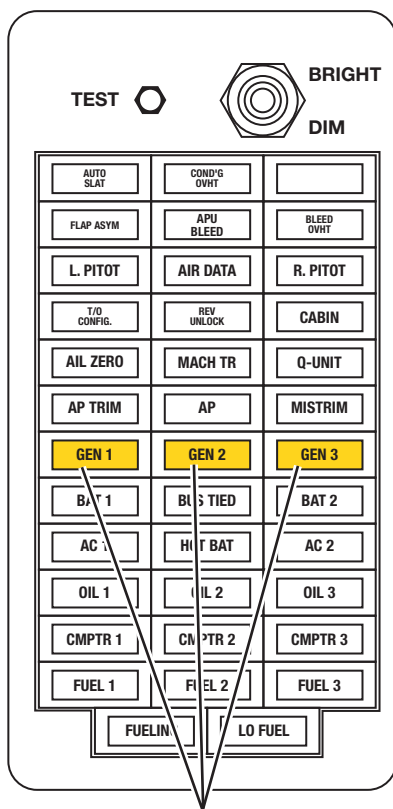

ILLUMINATE WHEN CORRESPONDING
GENERATOR BECOMES DISCONNECTED
FROM THE SYSTEM IT NORMALLY
SUPPLIES

During start, voltage from the batteries and the APU or one operating generator (Figure 2-10) energizes the engine starter-generator. The generator function of the starter-generator can be connected to the aircraft power supply only if the starter function is concluded. When the start is complete, the generator failure warning light on the master warning panel goes out. Simultaneously, this voltage is applied to the regulating and equalizing circuits. With the bus tie switch in flight NORMAL, the generators supply power as follows:

- Engine No. 1 starter-generator (S/G 1) supplies power for the LH main DC bus.
- Engine No. 2 starter-generator (S/G 2) supplies power for the LH main DC bus.
- Engine No. 3 starter-generator (S/G 3) supplies power to the RH main DC bus.
- The APU generator supplies power for the RH main DC bus.

Note that the APU starter-generator is identical with the other engine-driven units. When the APU reaches 95%, the generator function produces electrical power and ties it to the aircraft electrical system.

Eleven different configurations of the DC electrical system are shown in Figures 2-11 through 2-21.

Figure 2-10. Generator Indications

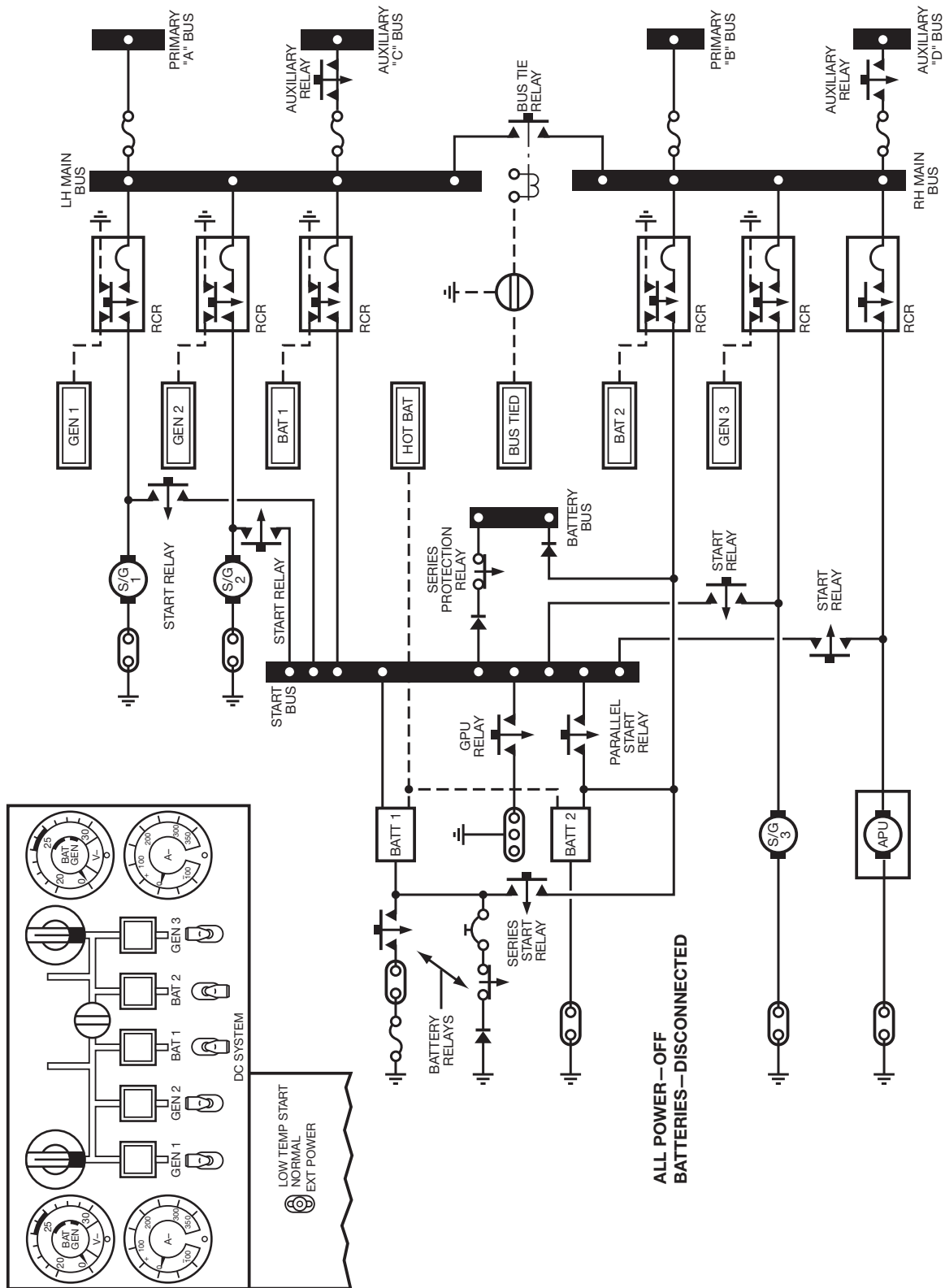
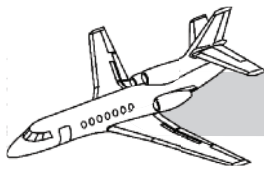

Figure 2-11. DC Electrical System—Configuration No. 1

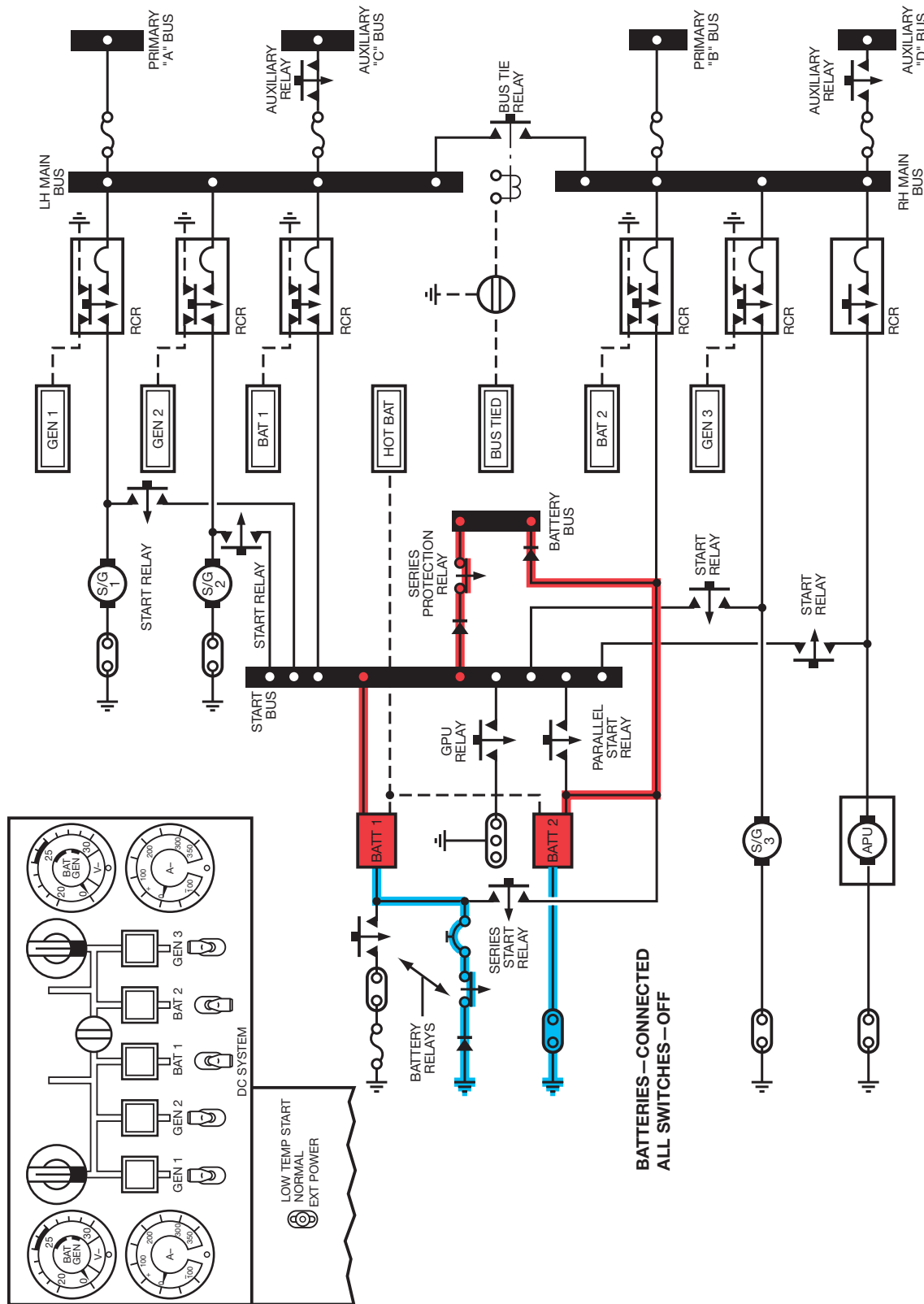
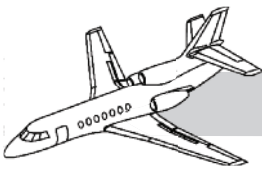

Figure 2-12. DC Electrical System – Configuration No. 2

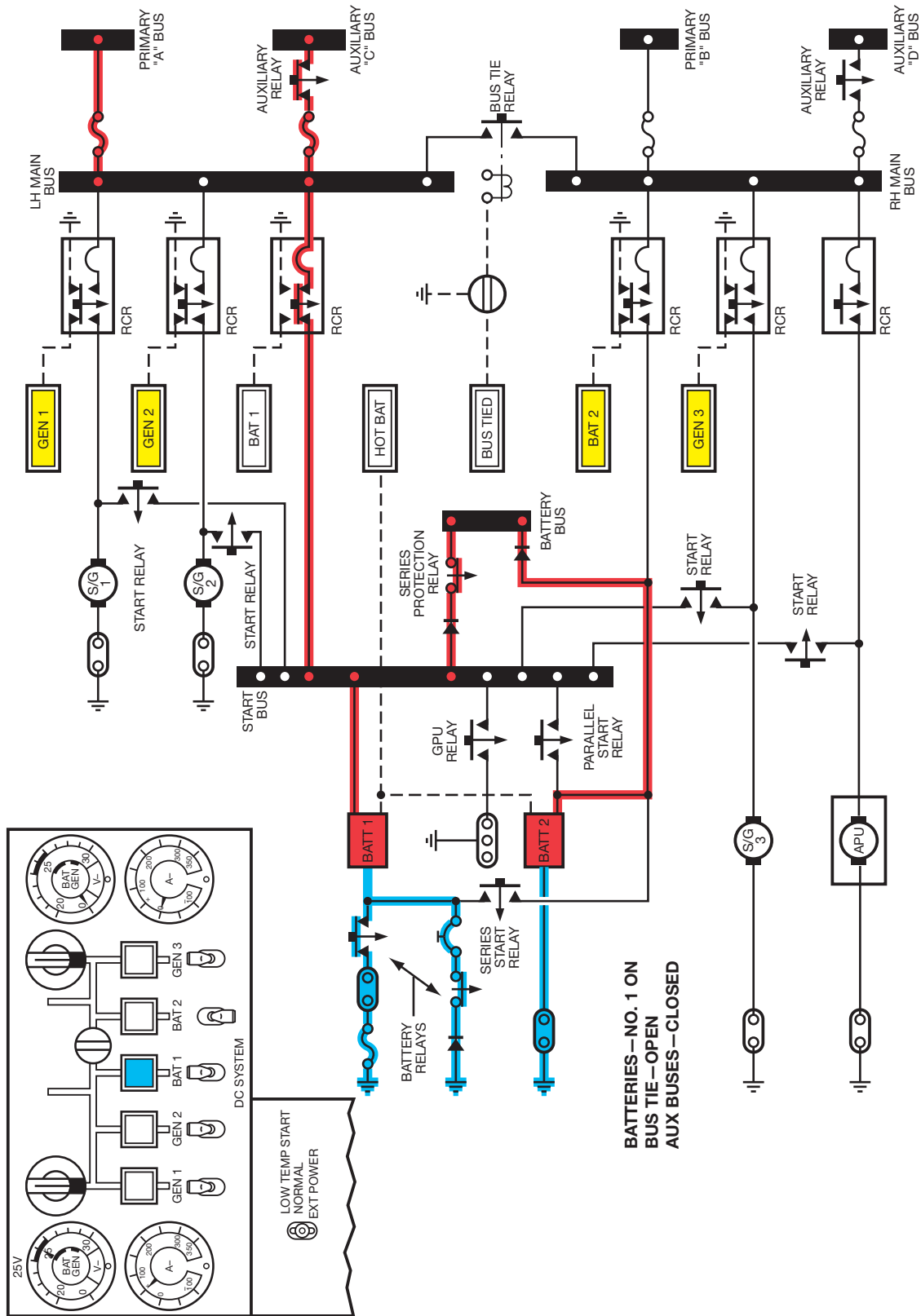
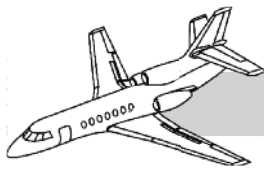

Figure 2-13. DC Electrical System – Configuration No. 3

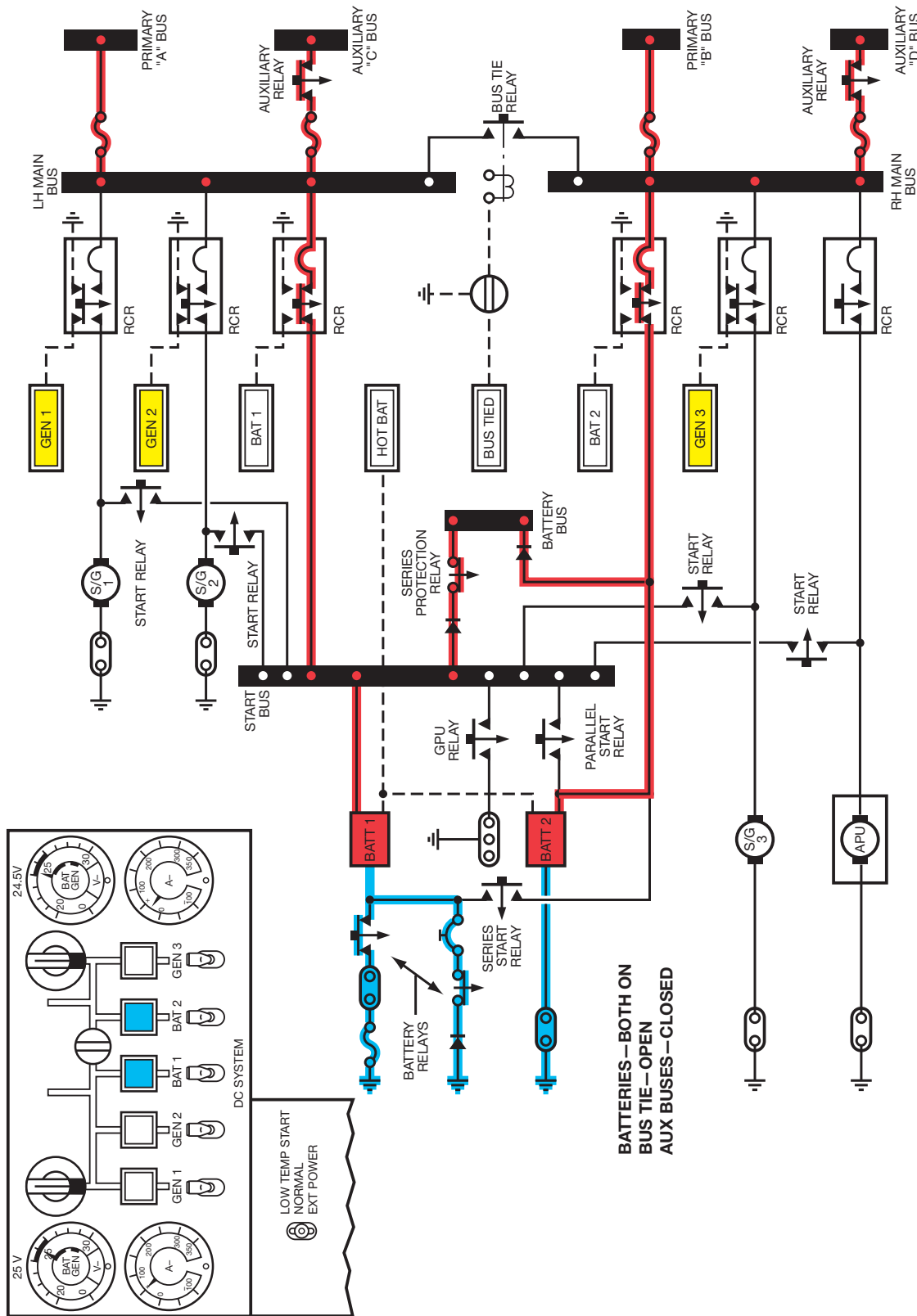
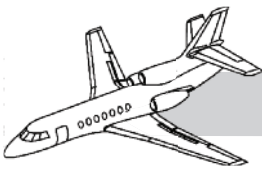

Figure 2-14. DC Electrical System — Configuration No. 4

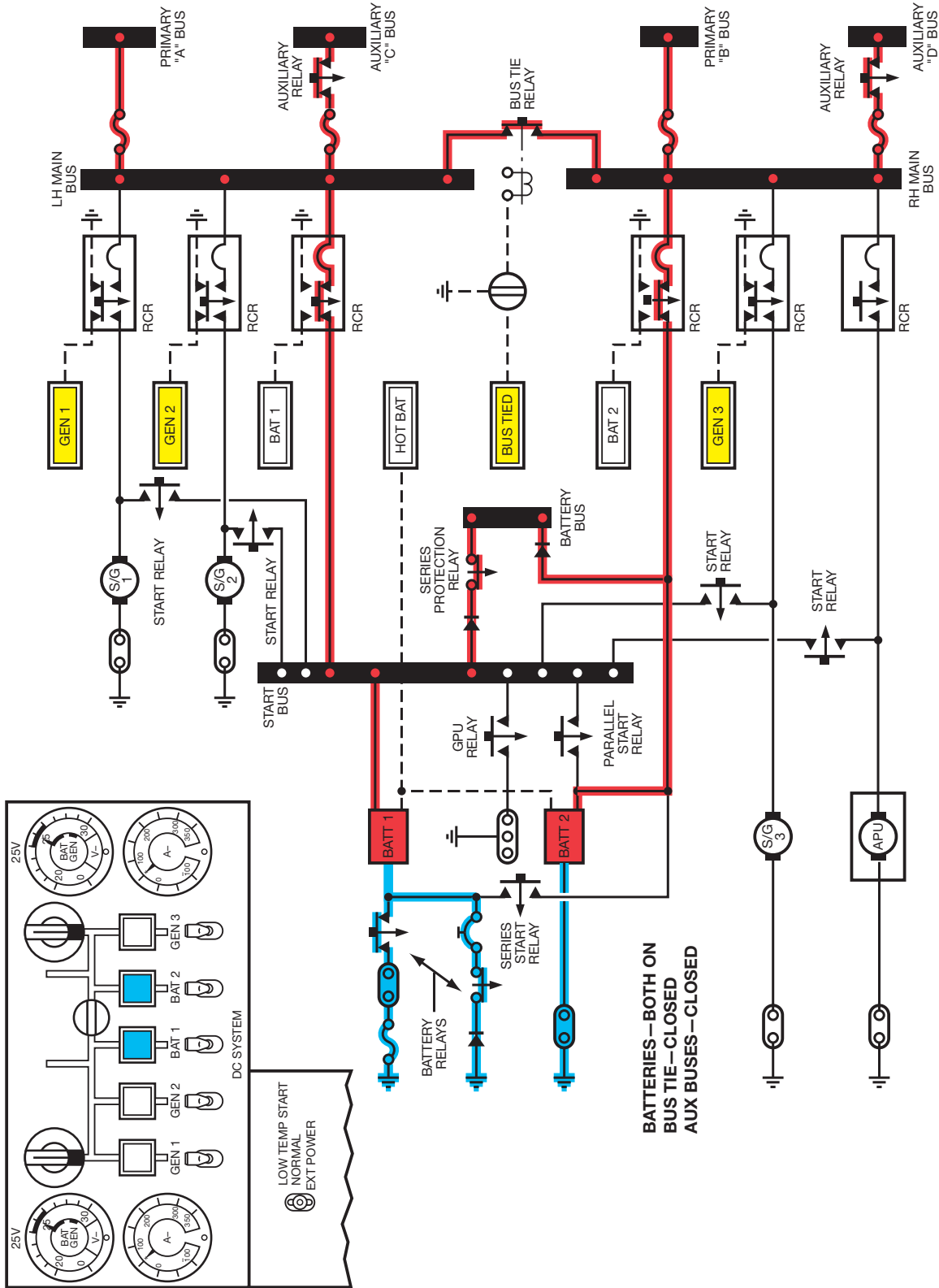
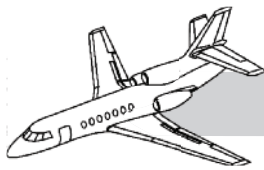

Figure 2-15. DC Electrical System – Configuration No. 5

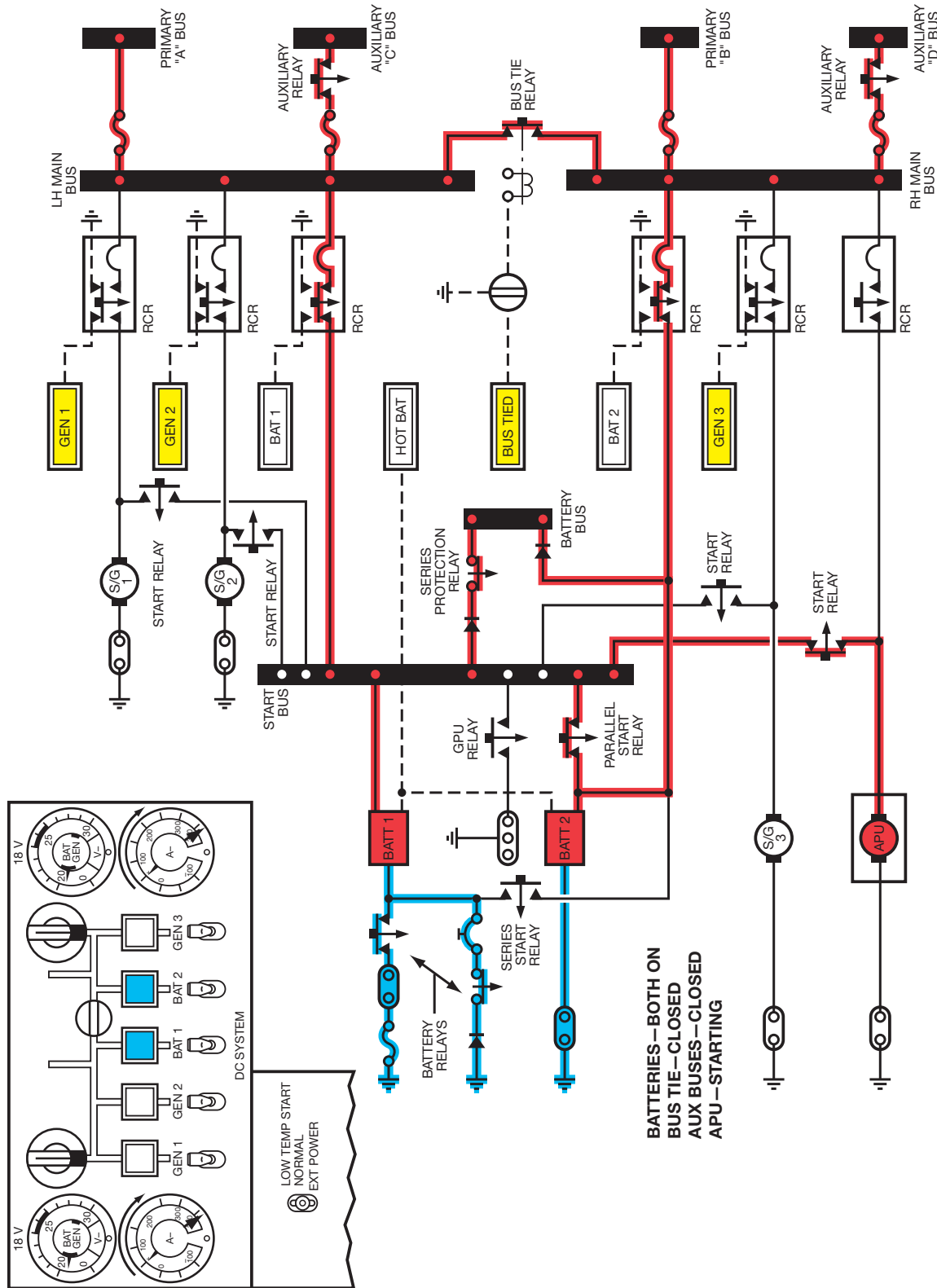
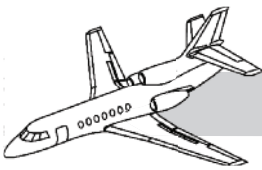

Figure 2-16. DC Electrical System — Configuration No. 6

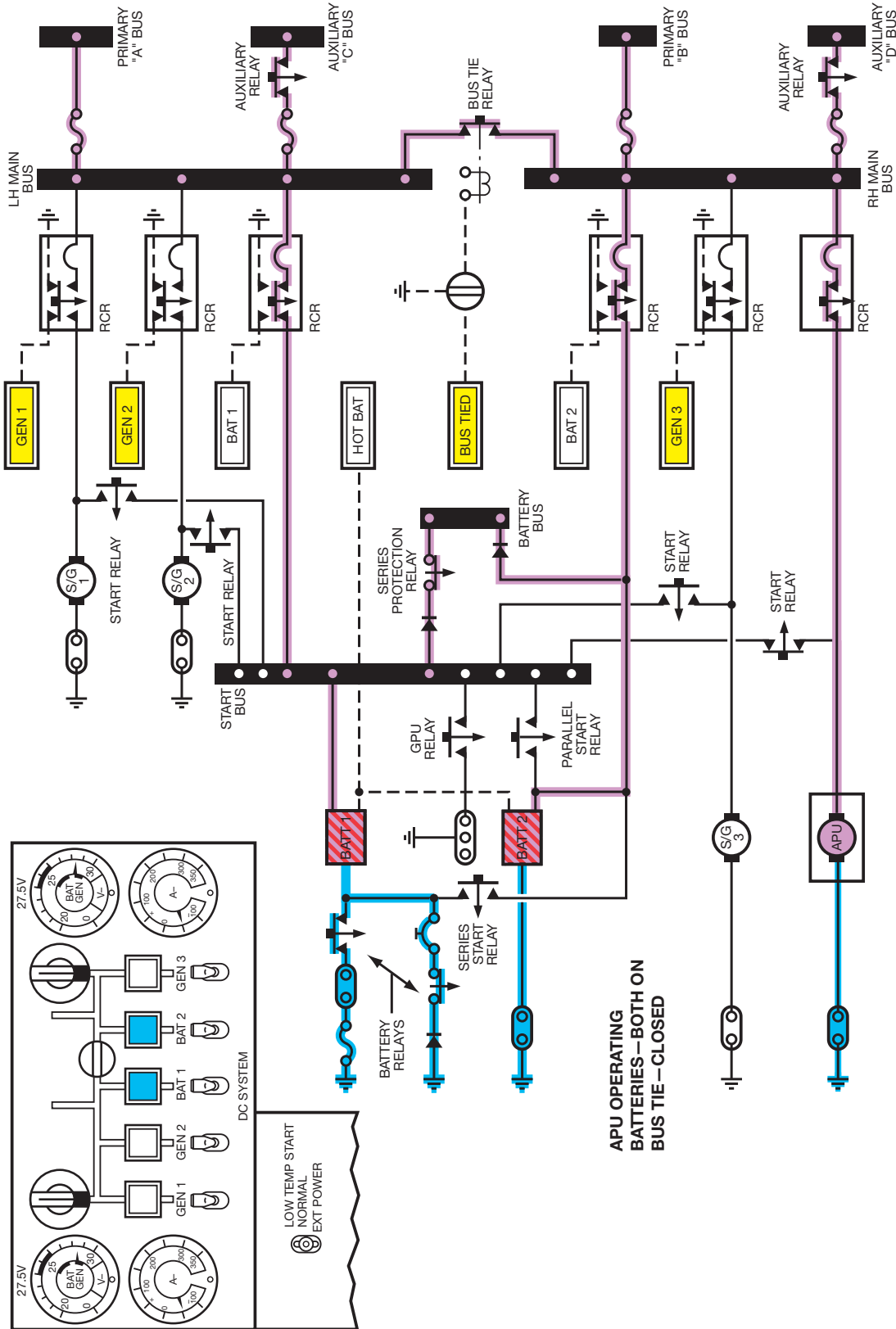
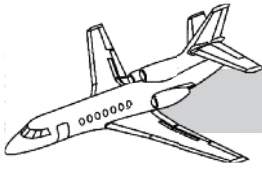

Figure 2-17. DC Electrical System – Configuration No. 7

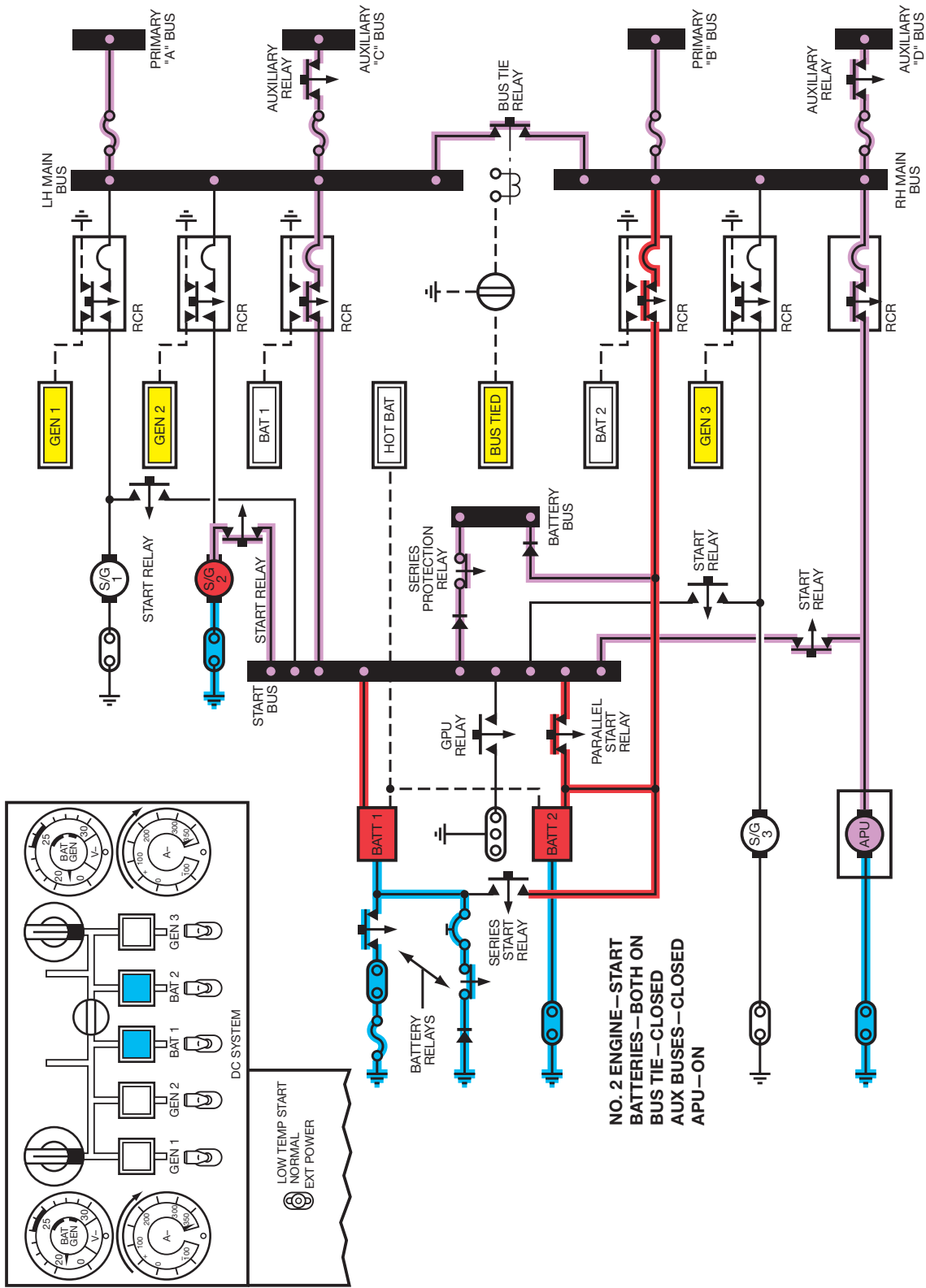
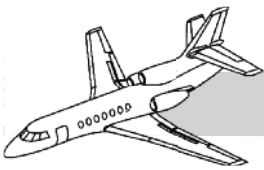

Figure 2-18. DC Electrical System – Configuration No. 8

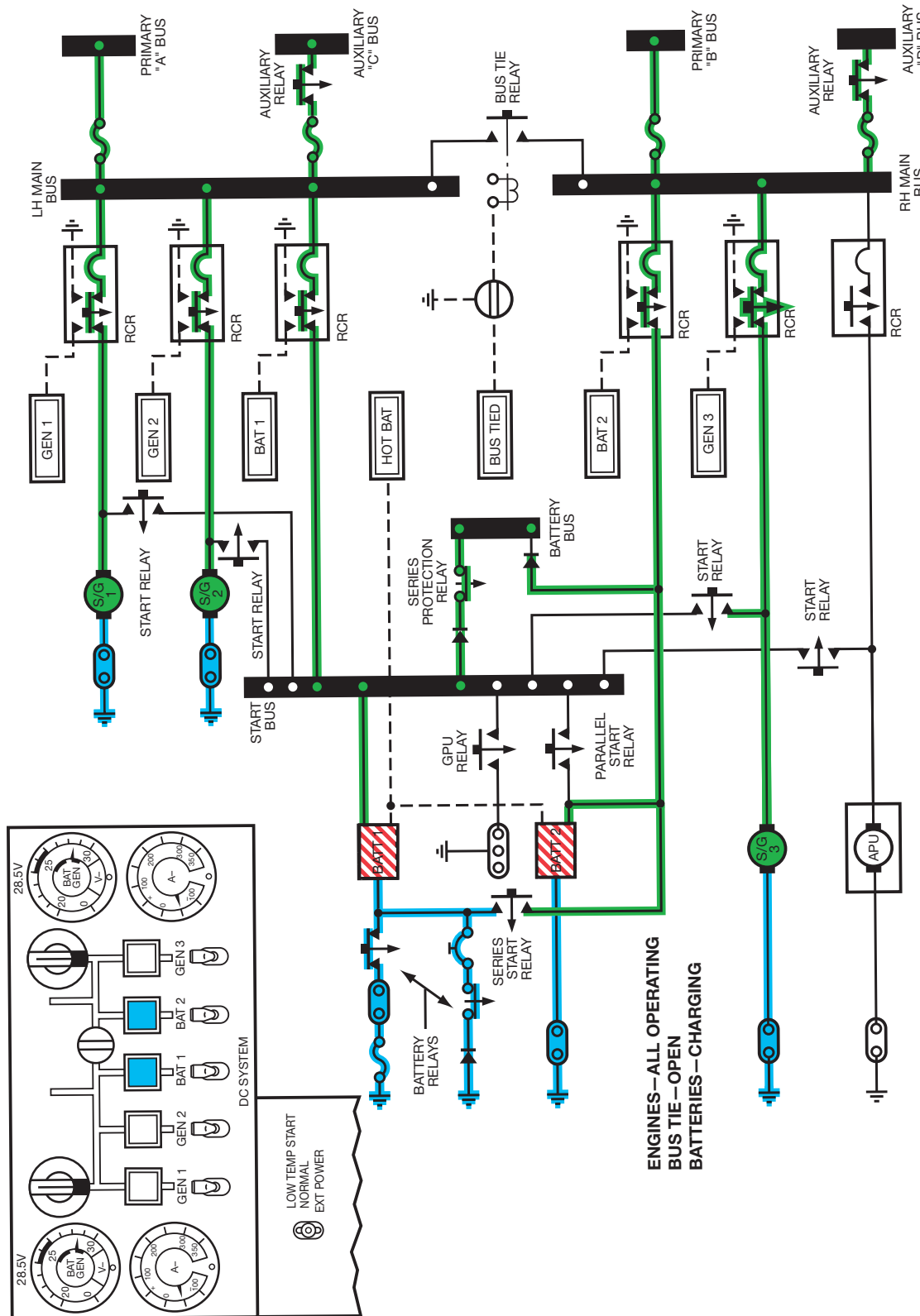
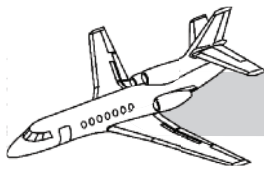

Figure 2-19. DC Electrical System — Configuration No. 9

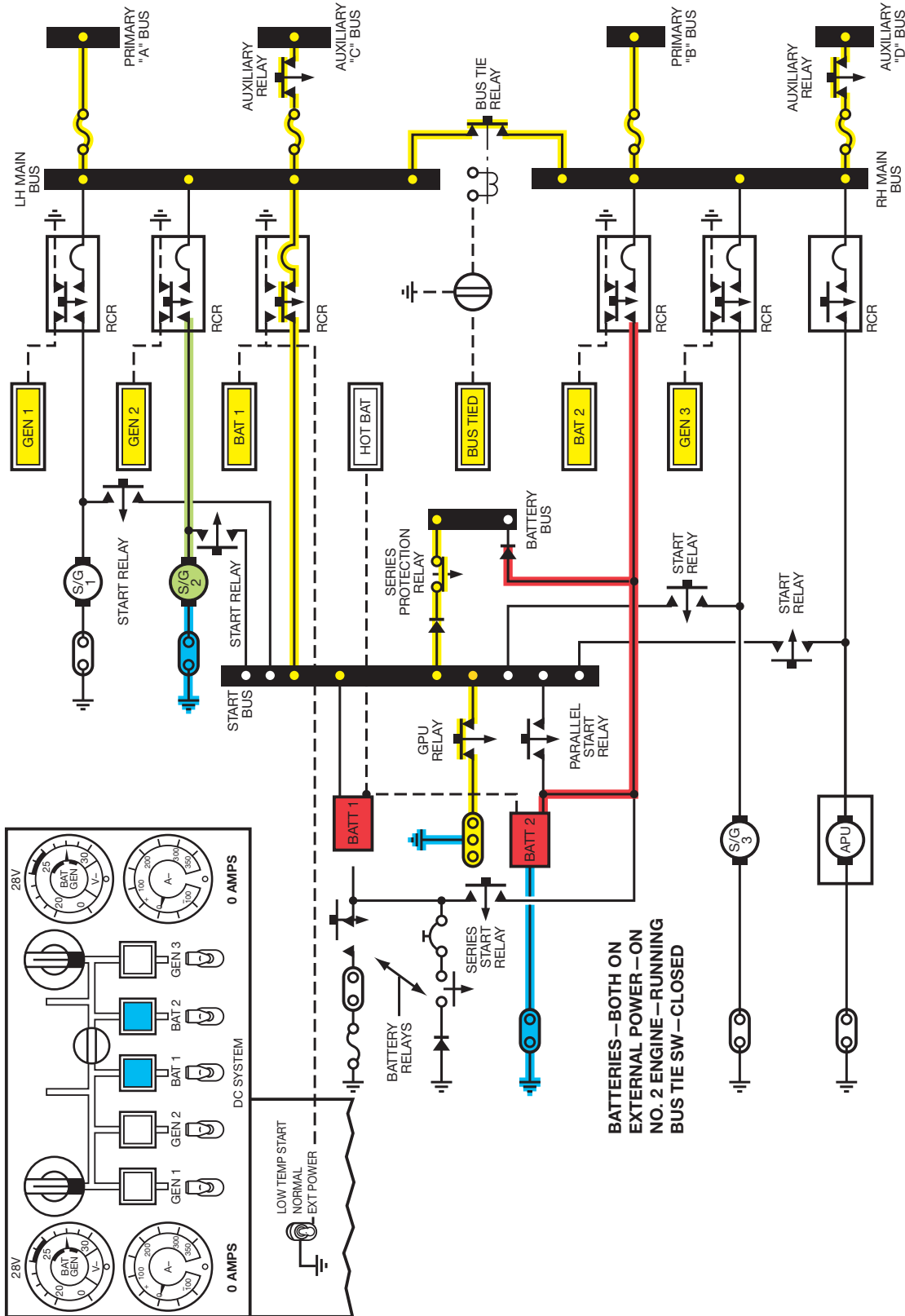
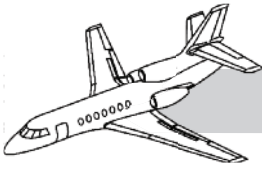

Figure 2-20. DC Electrical System — Configuration No. 10

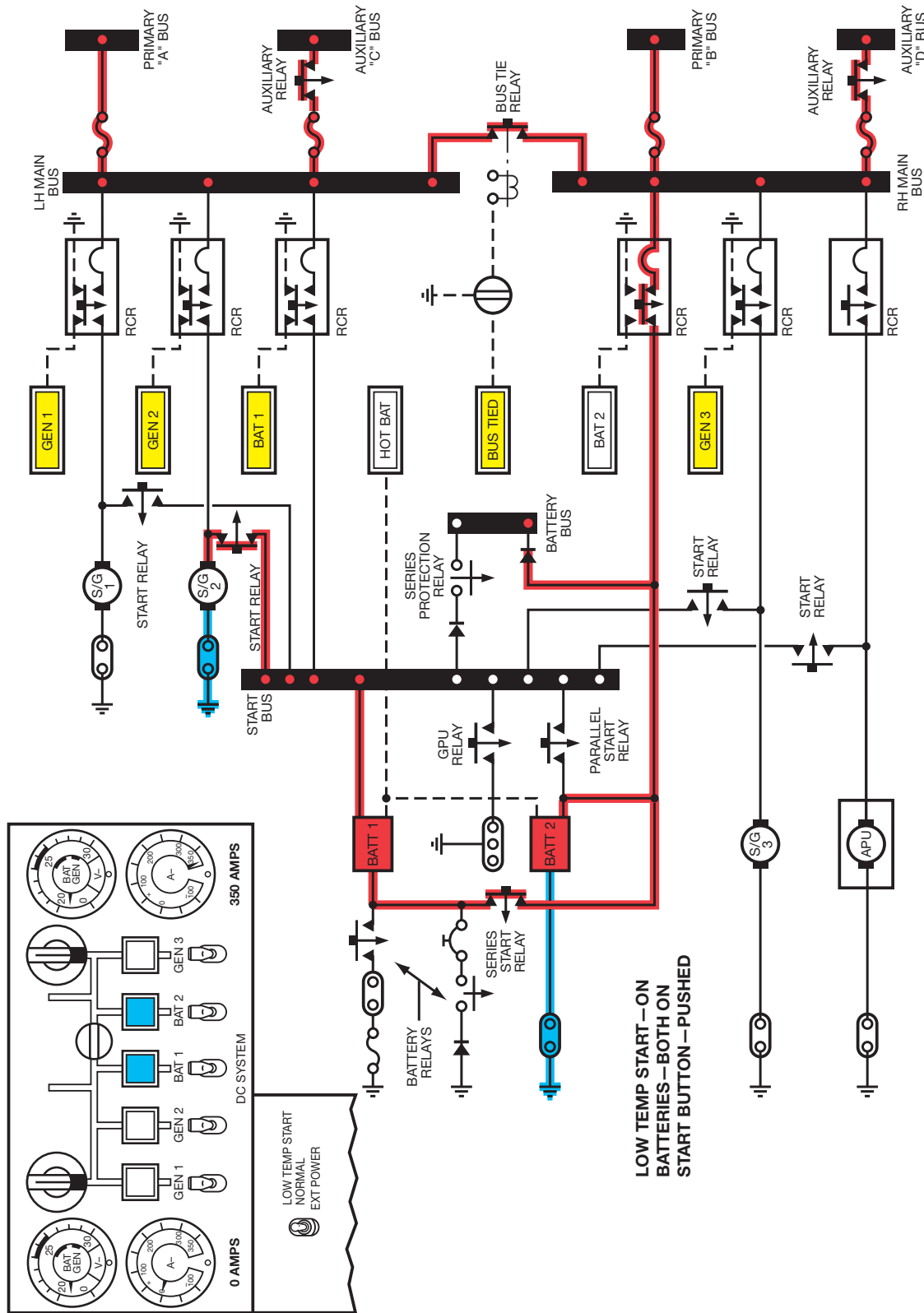
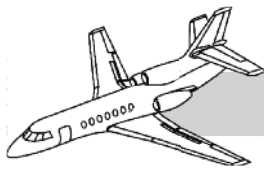
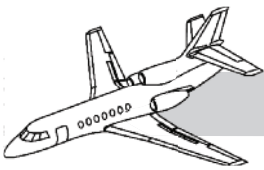

Figure 2-21. DC Electrical System – Configuration No. 11



Ground DC Power

A GPU can be used to start the engines, and the APU to power the electrical system.

The ground power receptacle (Figure 2-22) is located on the rear, RH side of the fuselage. A corresponding circuit is provided for overvoltage protection. Whenever the external power receptacle is used, the batteries' APU and engine generators are isolated from the system.

The voltage from a GPU must be 28 volts DC. The external power system includes a protection circuit that cuts off voltage at the receptacle if it increases to 32 volts. In addition, external power automatically drops off if voltage decreases to below 8 volts.

To apply external power, the DC power selector switch must be moved to the EXT POWER position. This applies power to the LH main bus but can be routed to the RH main bus through the bus tie relay. The bus tie switch placed in the tied position will cause the BUS TIED light to illuminate.

When external power is supplied to the aircraft, the BAT 1, BAT 2, GEN 1, GEN 2, and GEN 3 lights on the master warning panel will be illuminated.

Table 2-2 lists ground power functions and indications.

AC POWER SYSTEM

NORMAL INVERTERS (PILOT, COPILOT, AND STANDBY)

The AC power system is supplied by three single-phase, 750-watt static inverters, each producing outputs of 115-volt, 400-Hz power and 26-volt, 400-Hz power.

For operation, all three inverters require 28 ± 2 volts DC. The pilot inverter receives power from the A bus, the copilot inverter from B bus and the standby inverter control power from B bus with operating power from the RH main.

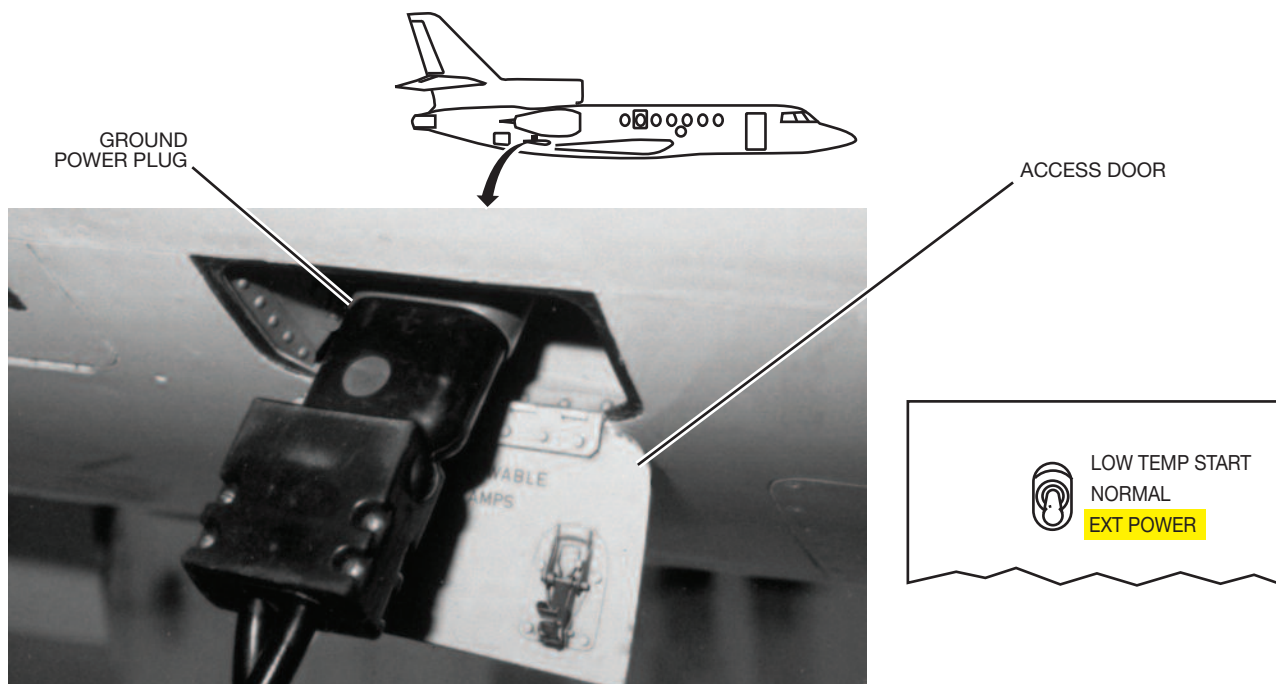

Figure 2-22. Ground Power

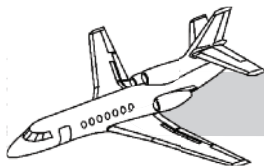

Table 2-2. GROUND POWER FUNCTIONS AND INDICATIONS

GPU POWER ON	GPU POWER OFF
DC Power Selector—Normal	DC Power Selector—Normal
<ul style="list-style-type: none"> • Battery switches—On Result: Battery power to main buses <li style="text-align: center;">OR • Battery switches—Off Result: Main buses not powered 	<ul style="list-style-type: none"> • Battery switches—On Result: Battery power to main buses <li style="text-align: center;">OR • Battery switches—Off Result: Main buses not powered
DC Power Selector—External Power	DC Power Selector—External Power
<ul style="list-style-type: none"> • Battery switches—On or off Result: Batteries isolate from main buses, No. 1 battery blue amp light on, No. 1 and No. 2 amber battery lights on 	<ul style="list-style-type: none"> • Battery switches—On Result: Main buses not powered <li style="text-align: center;">OR • Battery switches—Off Result: Main buses not powered

Inverter control is accomplished by the use of switches located on the overhead panel. The switches for the pilot and copilot inverters are two-position switches. In the ON position, the auxiliary loop used to supply control power for the inverter is closed. The OFF position removes power from the inverter.

The standby inverter (Figure 2-23) is controlled by a three-position switch located between the other inverter switches. In the center position, when on the ground, the inverter is used in parallel with the INS inverter to warm up the INS. When in the LH position, the inverter replaces the pilot inverter. In the RH position, it replaces the copilot inverter.

For operation indications, a voltmeter and AC bus 1 and AC bus 2 switchlights are used. The voltmeter is used for both of the 115-volt AC circuits and also for INS power displays. The switchlights—AC bus 1, AC bus 2, and INS—when depressed, connect the voltmeter to the corresponding circuit.

Amber AC 1 and AC 2 indicator lights on the master warning panel illuminate for zero inverter output or a frequency drift of ± 30 Hz, from 400 Hz (SB 214 also includes voltage drops of 5% from 26V). These lights sense only the 26-vac buses.

The operating sequence is to power the DC buses and set the inverter circuit breakers. Movement of the pilot or copilot inverter control switches to ON will activate the corresponding inverter. If either pilot or copilot inverter fails, moving the standby inverter's control switch to the LH or RH position provides power to the failed inverter's circuits with priority.

TWO-INVERTER SYSTEM

On the aircraft equipped with the two-inverter system, the inverters are single-phase, solid state, static-type which are rated at 350 VA and producing 115 volts at 400-Hz and 26 volts at 400-Hz power.

During normal operation, the two-inverter switches are placed in the ON position which will supply 28 volts to the inverters. The pilot inverter receives power from the A bus and the copilot inverter receives power from the B bus. Even though these inverters produce 115-volts and 26-volts AC power, only the 115-volt output is used on the aircraft equipped with this system.

The inverters are controlled with switches located on the overhead panel, same as the

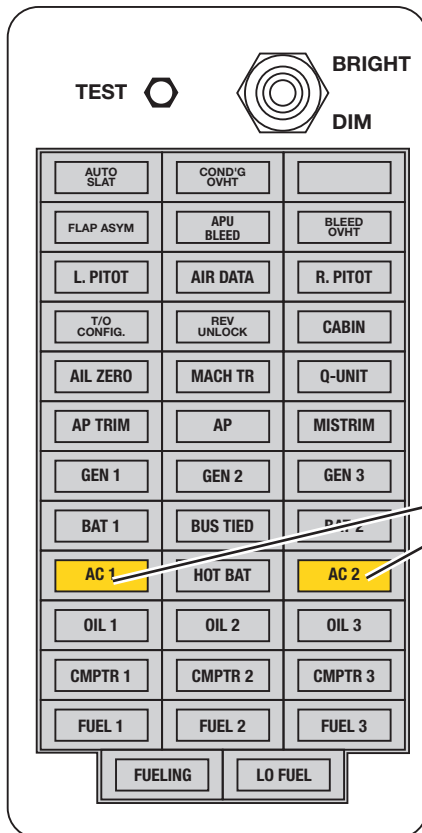
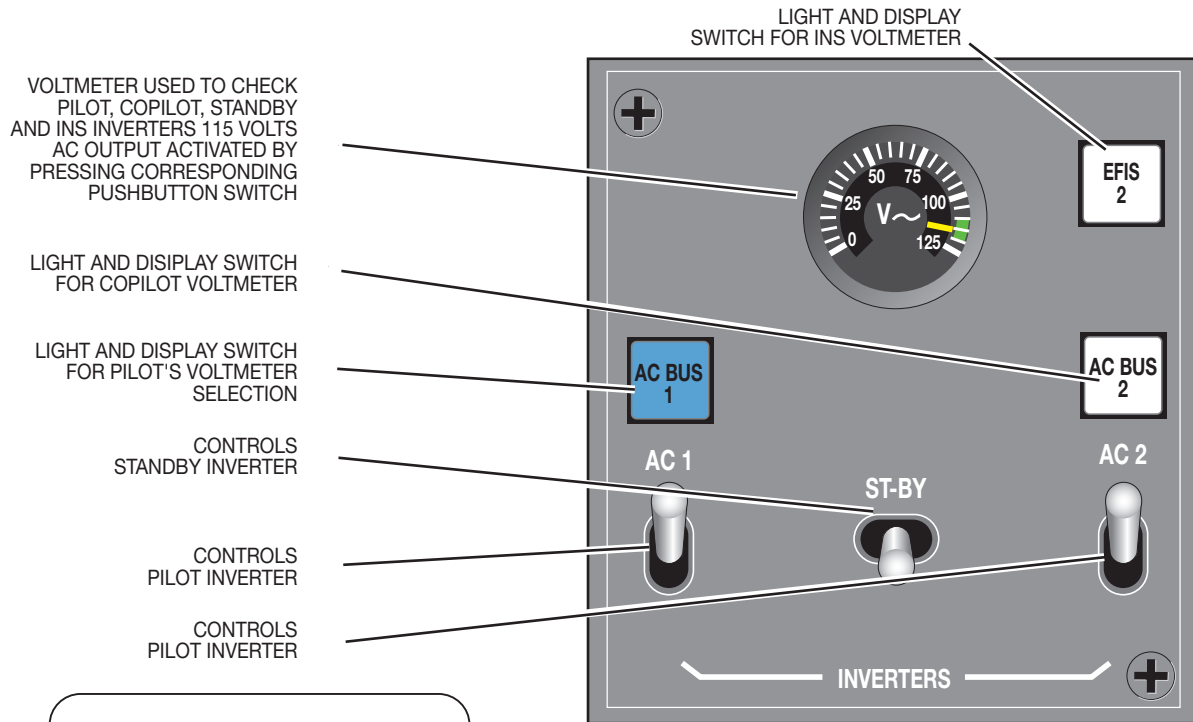
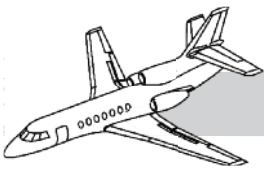

FOR THE 26V BUSES, LIGHTS COME ON FOR:

- NO INVERTER OUTPUT
- A FREQUENCY DRIFT
- VOLTAGE DROP (AC INCORPORATING SB 214)

Figure 2-23. Inverter Control and Indication

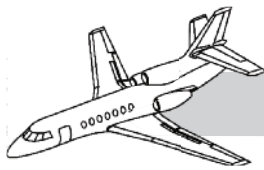

three-inverter system. However, this system does not have a voltmeter to display the 115-volt output. The only monitoring device is the AC 1 and AC 2 light in the warning panel. This light monitors a fault signal from the inverter itself. When the inverter voltage drops excessively low, or its frequency varies from 400 Hz by more than ± 30 Hz, the AC warning light will illuminate to indicate an inverter failure.

INS INVERTER

The INS inverter, located in the baggage compartment, has characteristics identical with those of the normal inverters. It requires an input of 28 ± 2 volts DC to produce 115 volts

AC for the INS bus. It also has a 26-volt AC output that is not used.

Distribution of the 115 volts AC is through the INS bus to the INS. Whenever the RH main bus is powered, the inverter is activated through a 50-amp fuse. When the INS is in alignment or in standby mode, the standby inverter is put in parallel with the INS inverter to warm up the INS to 70°F when it is cold.

Two supply systems distribute power: system 1, or pilot AC system, which feeds the 115-vac and 26-vac buses; and system 2, or copilot AC system, which feeds the 115-vac and 26-vac buses (Figure 2-24 and 2-25).

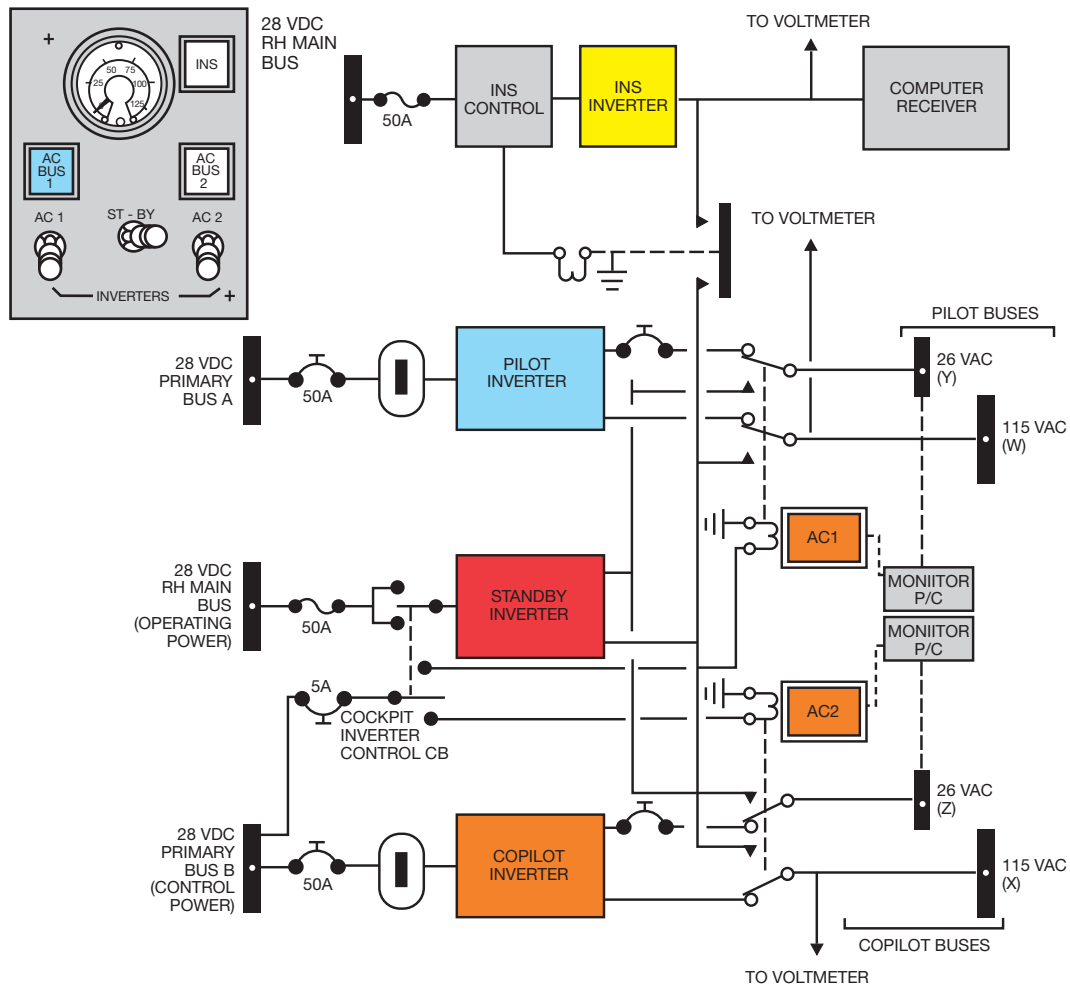
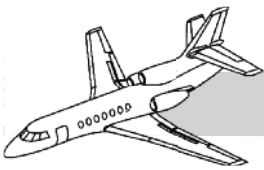

Figure 2-24. AC Power System



The total electrical system is shown in Figure 2-26.

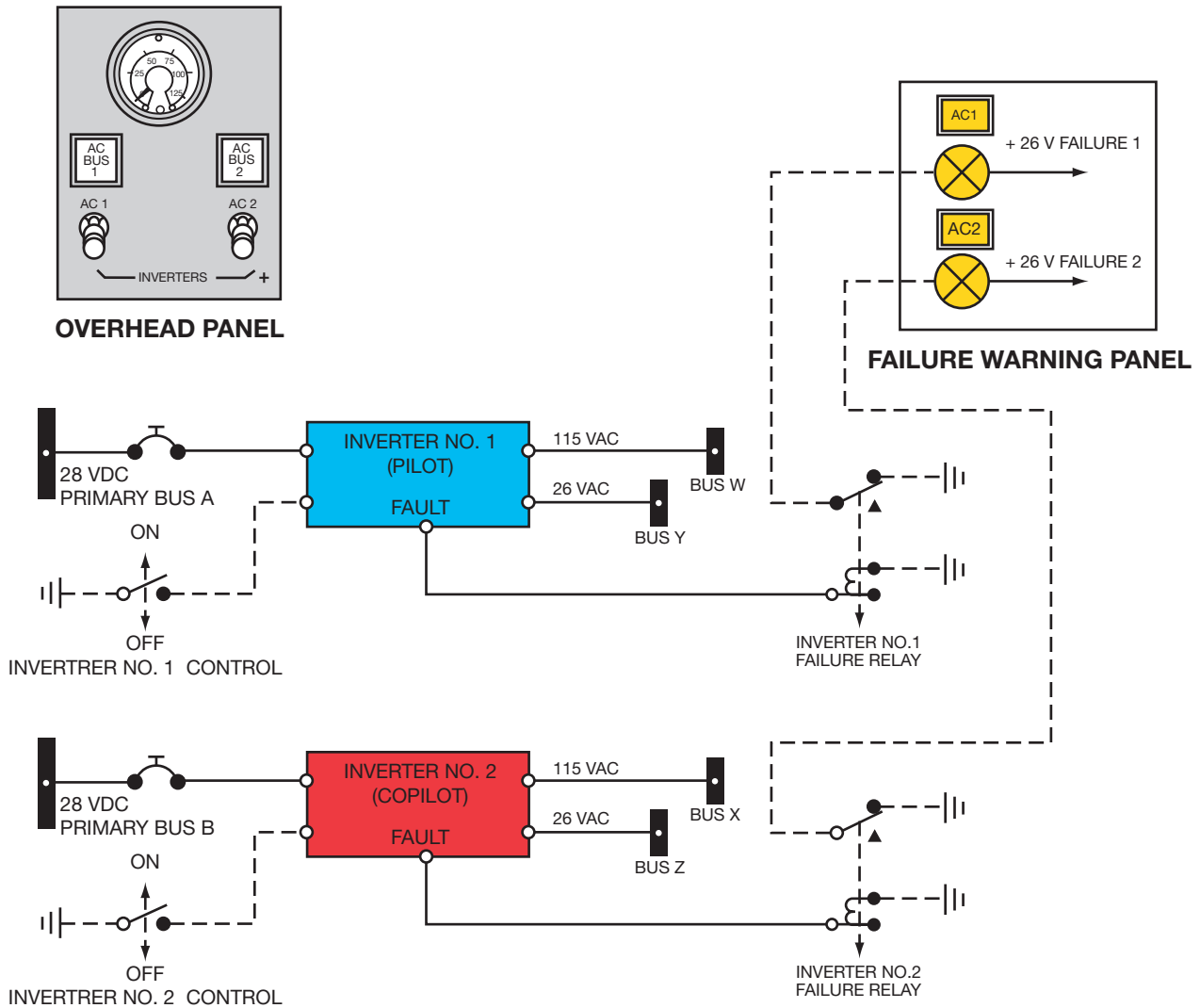

Figure 2-25. Simplified AC Power System

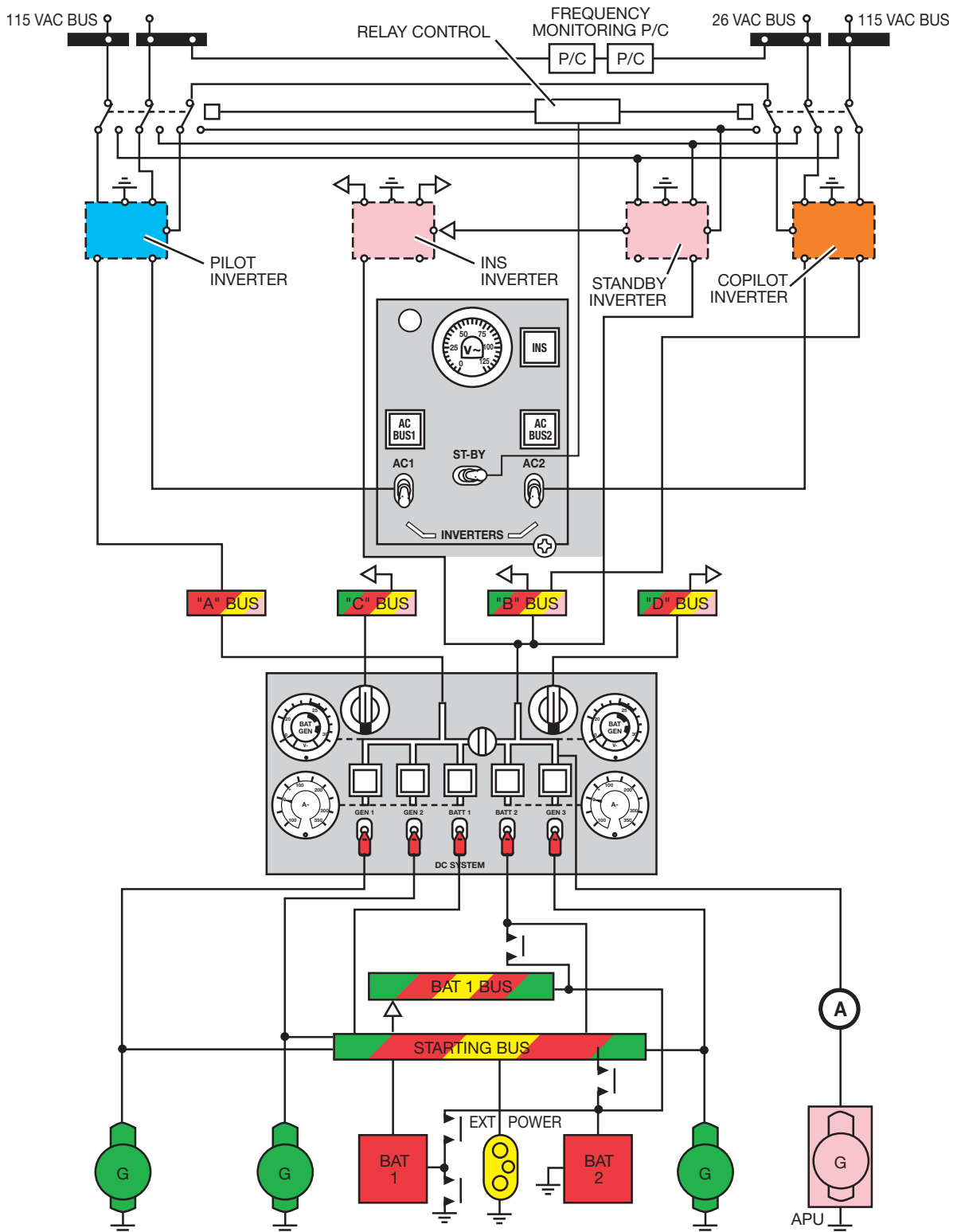
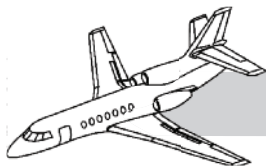
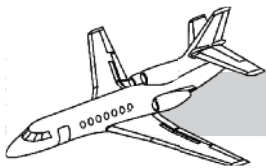

Figure 2-26. Total Electrical System



LIMITATIONS

DC POWER LIMITATIONS

Generators are operationally limited to a maximum output of 350 amperes for one minute. Up to 39,000 feet, they are limited to a steady maximum of 300 amperes. Above 39,000 feet, a steady maximum of 250 amperes is the limit.

The maximum bus load voltage for which the DC system has been designed is 32 volts.

AC POWER LIMITATIONS

Inverter input voltage must be a positive 28 ± 2 volts DC.

Current consumption under a full load is 39 amperes; under zero load, it is 1.5 amperes. Total output power should not exceed 115 volts AC, 600 va, nor 26 volts AC, 150 va. The output frequency is limited to $400 \text{ Hz} \pm 30 \text{ Hz}$.

STARTER DUTY RECOMMENDATIONS

Table 2-3 shows starter sequence limitations, and Figure 2-27 shows start and dry motoring sequence.

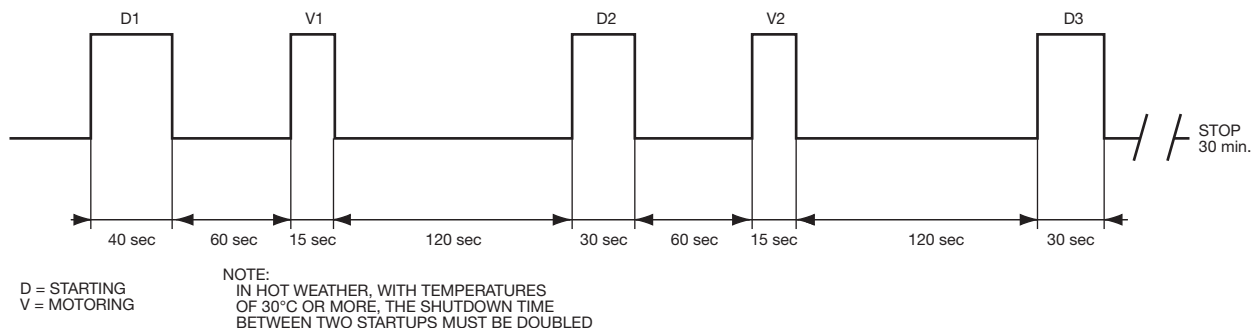
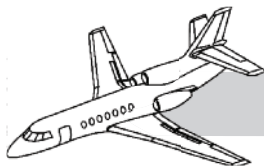

Figure 2-27. Start and Dry Motoring Sequence



TROUBLESHOOTING

The trouble situations shown in Figure 2-28 are a visual sequence depiction to ease understanding of the electrical abnormal checklist.

TROUBLE SITUATION NO. 1

CONDITIONS:
LEFT VOLTMETER—28.5 VOLTS
BOTH GEN SWITCHES—ON

CAUSE:
LOW VOLTAGE FROM NO. 2 GEN

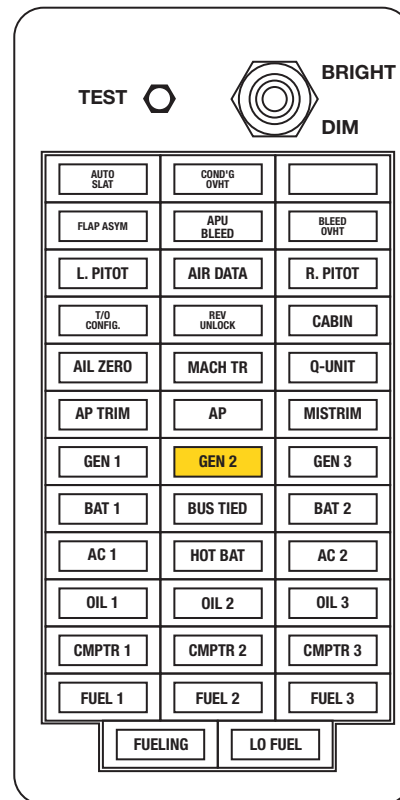
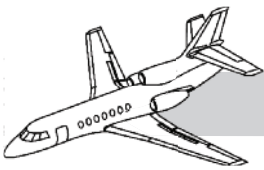

Figure 2-28. Trouble Situations (Sheet 1 of 4)



TROUBLE SITUATION NO. 2

CONDITIONS:
LEFT VOLTMETER—INDICATES VOLTAGE
INCREASING
GEN 1 LIGHT—ON,
GEN 1 SWITCH—ON

THEN

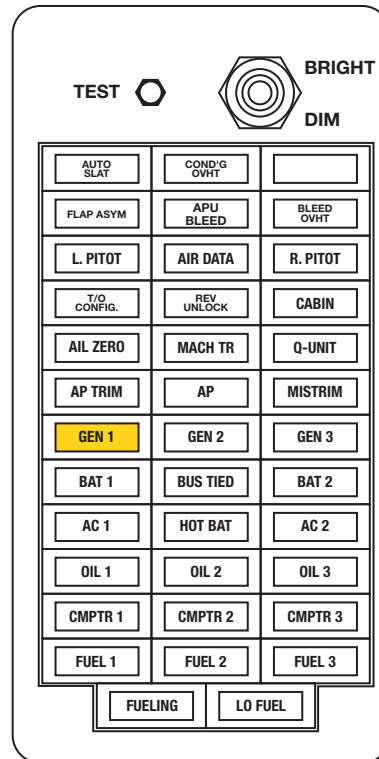

CONDITIONS:
GEN 2 SWITCH—OFF
GEN 2 LIGHT—ON
GEN 1 LIGHT—OUT
LEFT VOLTMETER—28.5 VOLTS

CAUSE:
SLOW VOLTAGE FROM NO. 2 GEN

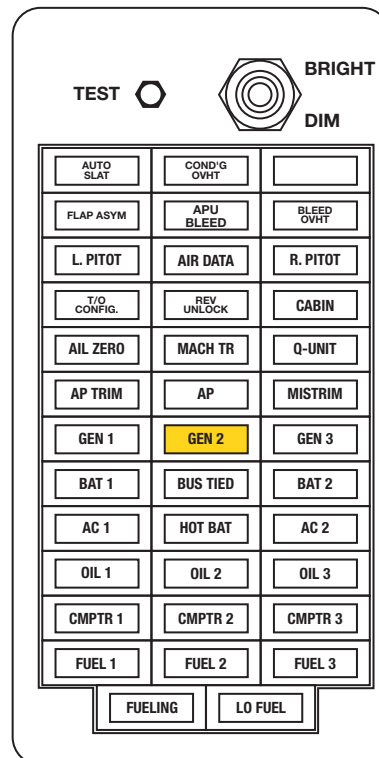
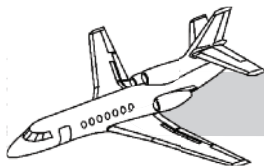

Figure 2-28. Trouble Situations (Sheet 2 of 4)



TROUBLE SITUATION NO. 3

CONDITIONS:
LEFT VOLTMETER—30 VOLTS
BOTH GEN SWITCHES—ON

CAUSE:
REVERSE CURRENT FROM NO. 2 GEN

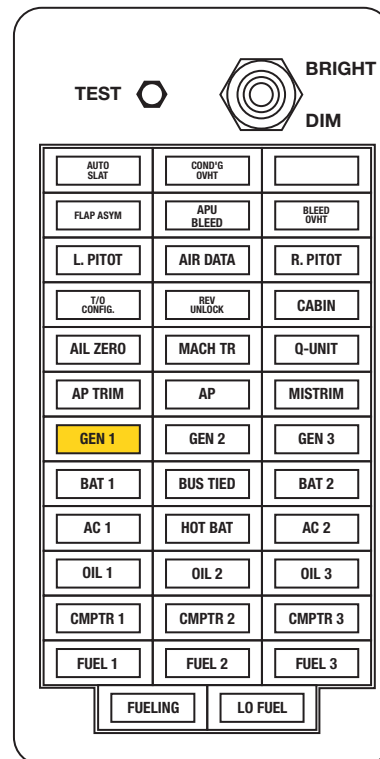

TROUBLE SITUATION NO. 4

CONDITIONS:
RIGHT VOLTMETER—24 TO 26 VOLTS
AMMETER—+ 120 AMPS
GEN SWITCH—TRIPPED OFF

CAUSE:
NO. 3 GEN HAS OVERVOLTS
OR OVERAMPS

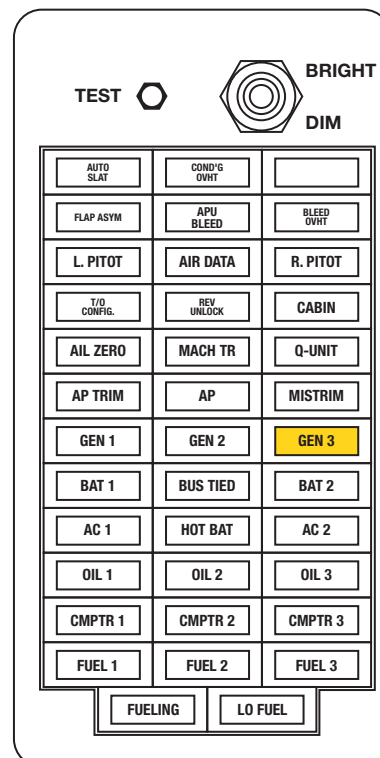
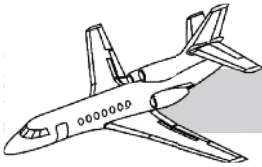

Figure 2-28. Trouble Situations (Sheet 3 of 4)



TROUBLE SITUATION NO. 5

CONDITIONS:
LEFT VOLTMETER—VOLTAGE DROPPING
AMMETER—INDICATES MAXIMUM
BOTH GEN SWITCHES—TRIPPED OFF

CAUSE:
LEFT MAIN BUS SHORTED

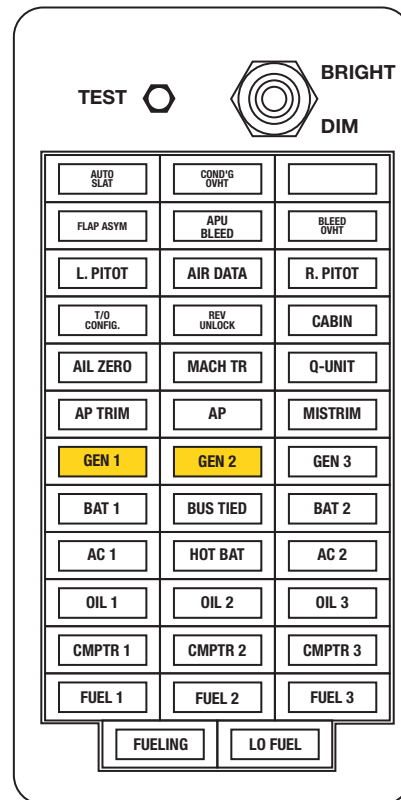
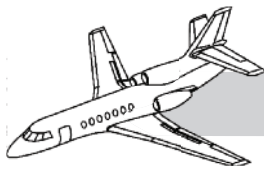

Figure 2-28. Trouble Situations (Sheet 4 of 4)



CIRCUIT-BREAKER LISTING

Table 2-3. CIRCUIT-BREAKER LISTING

BUS A	
DG 1-PILOT HEADING REFERENCE SYSTEM	LH GROUND/FLIGHT SWITCHES
ADF 1	ELECTRICALLY-DRIVEN PUMP CONTROL CIRCUIT
DME 1	HEATING CONTROL CIRCUIT FOR PILOT WINDSHIELD
VOR 1	HEATING CIRCUIT FOR LH PITOT PROBE
ICS 1—INTERPHONE AND PUBLIC ADDRESS SYSTEM	HEATING CIRCUIT FOR LH STATIC PORT
VHF 1	HEATING CIRCUIT FOR LH ANGLE OF ATTACK SENSOR
ATC 1	PILOT WINDSHIELD WIPER
LIGHTING OF INSTRUMENTS AND CENTER PANEL	NO. 1 ENGINE ANTI-ICING SYSTEM
LH LANDING LIGHT POWER SUPPLY	CONTROL CIRCUIT FOR FLIGHT COMPARTMENT AIR-CONDITIONING
ANTI-COLLISION LIGHT ON VERTICAL STABILIZER	PRESSURIZATION
CONTROL CIRCUIT FOR LH LANDING LIGHT	DUMP
READING—LIGHTING OF CIRCUIT BREAKER PANEL	NO. 2 ENGINE ANTI-ICING SYSTEM
PILOT MAP LIGHT	NO. 1 AND NO. 2 ENGINE HP BLEED
LIGHTING OF THE PILOT DIGITAL DISPLAY SEGMENTS	NO. 2 ENGINE PRV VALVE
NAVIGATION LIGHTS	DEFOGGING OF SLIDING WINDOW
LIGHTING OF LH SIDE OF CONTROL PEDESTAL	AIRBRAKE CONTROL SYSTEM
LIGHTING OF OVERHEAD INSTRUMENT PANEL	ARTHUR Q UNIT MONITORING
NO. 1 INVERTER	NORMAL HORIZONTAL STABILIZER CONTROL SYSTEM
AUTOMATIC IGNITION CONTROL SYSTEM	NO. 1 CONTROL CIRCUIT FOR SLATS
THRUST REVERSER CONTROL SYSTEM	INDICATION SYSTEM FOR SLATS
REVERSE CONTROL WARN	AIR DATA COMPUTER
NO. 1 ENGINE INTERTURBINE TEMPERATURE	AUX
N ₁ AND N ₂ ENGINE MONOPOLE SPEED SENSORS	EXT TEMP—ANTI-ICING OF OUTSIDE
NO. 2 ENGINE COMPUTER	TEMPERATURE PROBE
NO. 1 ENGINE STARTING CIRCUIT	FLIGHT RECORD—FLIGHT RECORDER
NO. 2 ENGINE INTERTURBINE TEMPERATURE	AP-RUD-YAW DAMPER
NO. 2 ENGINE N ₁ AND N ₂ MONOPOLE SPEED SENSORS	AP-ELEV—ELEVATOR POWER SERVO UNIT
NO. 2 ENGINE COMPUTER	AP-AIL—AILERONS POWER SERVO UNIT
NO. 1 ENGINE LP BOOSTER PUMP	AP-CMPTR—AUTOPILOT COMPUTER
NO. 2 ENGINE LP BOOSTER PUMP	HRZN-ST-BY PWR-STANDBY HORIZON
NO. 1 ENGINE FLOWMETER	INSTR 1—INSTRUMENTS CONNECTED TO
FUEL GAUGING UNITS OR LH TANKS	THE AIR DATA COMPUTER
NO. 2 ENGINE FLOWMETER	COMPAR—COMPARATOR
FUEL GAUGING UNITS FOR CENTER FUEL TANKS	FD1—PILOT FLIGHT DIRECTOR
LANDING GEAR CONTROL CIRCUITS	
LANDING GEAR AURAL WARNING ANNUNCIATOR	
BUS B	
AUXILIARY POWER UNIT	NO. 3 ENGINE FIRE DETECTION SYSTEM
NO. 3 ENGINE FLOWMETER CIRCUIT	NO. 3 ENGINE FIRE EXTINGUISHER SYSTEM
FUEL GAUGING UNITS FOR RH TANKS	OMEGA NAVIGATION SYSTEM
NO. 3 ENGINE LP BOOSTER PUMP	HF CONTROL SYSTEM
FUEL TRANSFER INTERCONNECTION	HF POWER SYSTEM
LANDING GEAR INDICATION	PASSENGER CABIN LOUDSPEAKERS
RH GROUND/FLIGHT SWITCH	INTERPHONE AND PUBLIC ADDRESS CIRCUITS
ANTI-SKID CIRCUIT	COPILOT HEADING REFERENCE SYSTEM
BRAKE INDICATION	INVERTERS IN COPILOT CIRCUIT
NO. 3 ENGINE ANTI-ICING SYSTEM	ST-BY-CONTROL OF INVERTER POWER TRANSFER
NO. 3 ENGINE HP BLEED CONTROL	AND SYNCHRONIZATION CIRCUIT
SHUTOFF VALVE CONTROL	CABIN INDIRECT—LIGHTING OF SECTIONS OF THE COPILOT
WING ANTI-ICING	INSTRUMENT PANEL SEGMENTS
PASSENGER CABIN AIR-CONDITIONING	LIGHTING OF COPILOT SEGMENTS
VALVE CONTROL	NO. 3 ENGINE INTERTURBINE TEMPERATURE
BAGGAGE COMPARTMENT PRESSURIZATION	NO. 3 ENGINE N ₁ AND N ₂ MONOPOLE SPEED SENSORS
INLET VALVE	NO. 3 ENGINE COMPUTER
BAGGAGE COMPARTMENT ISOLATION	NO. 3 ENGINE STARTING CIRCUIT
SHUTOFF VALVE	RH PITOT HEAT—HEATING OF RH PITOT PROBE
NO. 2 CONTROL CIRCUIT FOR SLAT	HEATING OF RH STATIC PORTS
FLAP POSITION INDICATION	HEATING OF RH ANGLE OF ATTACK SENSOR
AIRBRAKES POSITION INDICATION	WIPER RH—COPILOT WINDSHIELD WIPER
EMERGENCY HORIZONTAL STABILIZER CONTROL	ROLL EMER—EMERGENCY ROLL TRIM
FLIGHT CONTROL	TRIM RUDDER—RUDDER TRIM
RH POWER SUPPLY FOR MASTER WARNING PANEL	FLAP INDICATOR
RH POWER SUPPLY FOR AURAL WARNING	INSTR 2—VIBRATOR FOR COPILOT ALTIMETER
ANNUNCIATOR	ANNUNC RH—COPILOT WARNING ANNUNCIATOR
EMERGENCY LIGHTING SYSTEM	FD2—COPILOT FLIGHT DIRECTOR

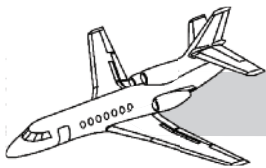
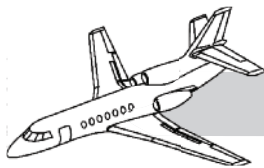

Table 2-3. CIRCUIT-BREAKER LISTING (Cont)

BUS C	
INERTIAL NAVIGATION SYSTEM	LP 1 CROSSFEED CONTROL
RADIO ALTIMETER	STEERING CIRCUIT
WEATHER RADAR	MONITORING OF NO. 1 HYDRAULIC SYSTEM
TAPE RECORDER	EMERGENCY WING ANTI-ICING SYSTEM
CONTROL CIRCUIT FOR BAR EQUIPMENT	DEFOGGING OF AFT SIDE WINDOWS
PASSENGER READING LIGHTS	FLIGHT COMPARTMENT TEMPERATURE REGULATION
CONTROL CIRCUIT FOR PILOT AND COPILOT SEATS	CABIN TEMP
STROBOSCOPIC WING LIGHTS	NOSE CONE BLOWER
TAXIING LIGHT	HEATING CARPET IN FLIGHT COMPARTMENT
PRESSURE-TEMPERATURE OF OIL OF NO. 1 ENGINE	A/A IND IC
PRESSURE-TEMPERATURE OF OIL OF NO. 2 ENGINE	ROLL TRIM, YAW TRIM, HORIZONTAL STABILIZER
NO. 1 TRANSFER PUMP	POSITION INDICATOR
NO. 2 TRANSFER PUMP	ROLL TRIM CONTROL CIRCUIT
BUS D	
FLITE FONE	COPILOT MAP LIGHT
ADF 2	LIGHTING OF RH SIDE CONTROL PEDESTAL
DME 2	TOILET LIGHTING SYSTEM—RAZOR OUTLET
VOR 2	CABIN DISPLAY
VHF 2	POWER SUPPLY FOR RH LANDING LIGHT
ATC 2	PRESSURE-TEMPERATURE OF NO. 3 ENGINE
ENGINE MONITORING AND COPILOT'S	ENGINE SYNCHRONIZATION
INSTRUMENT PANEL LIGHTING	NO. 3 TRANSFER PUMP
CONTROL CIRCUITS OF BELLY ANTI-	PRESSURE FUELING—REFUELING CIRCUIT
COLLISION LIGHT AND RH LANDING	LP 2-3 CROSSFEED CONTROL SYSTEM
LIGHT	MONITORING CIRCUIT OF NO. 2 HYDRAULIC SYSTEM
BELTS-NO SMK'G-PASSENGER INSTRUCTIONS	CABIN TEMPERATURE REGULATION
TOILET COMPARTMENT LIGHTING	COPILOT WINDSHIELD ANTI-ICING CIRCUIT
	FLAP CONTROL
BATTERY BUS	
	EXTINGUISHER POWER SUPPLY
	APU AIR INTAKE DOOR
	PILOT AND COPILOT DOME LIGHTS
	ENTRANCE LIGHTS
	BAGGAGE COMPARTMENT, REAR COMPARTMENT
	AND NOSE CONE LIGHTS
	PRESSURE REFUELING
	GEN 1-2 ENERGIZING
	GEN 3 ENERGIZING



QUESTIONS

1. What is the primary source of DC power when on the ground and the engines are not running?
 - A. 115-volt batteries
 - B. 26-28 volt inverters
 - C. 24-26 volt batteries
 - D. 28-30 volt generators
2. Placing both BAT switches to ON causes illumination of the blue:
 - A. GEN 1 and BAT 1 lights
 - B. GEN 1 and GEN 3 lights
 - C. BAT 1 and BAT 2 lights
 - D. GEN 3 and BAT 2 lights
3. Illumination of the blue BAT 1 light prompts reading of the:
 - A. Left battery voltage and ampere indicator
 - B. Left battery ampere indicator
 - C. Left battery voltmeter
 - D. None of the above
4. Pushing the GEN 3 light causes the:
 - A. Blue BAT 1 light to extinguish
 - B. Blue BAT 2 light to extinguish
 - C. GEN 1 and BAT 2 lights to illuminate
 - D. Blue GEN 3 light to extinguish
5. The battery reverse current relay opens if there is a:
 - A. 25-ampere continuous reverse current
 - B. Difference of 100 amperes between generators
 - C. 250-ampere continuous reverse current
 - D. Difference of 50 amperes between generators
6. When the battery reverse current relay opens due to a reverse current of 250 amperes, it causes the associated:
 - A. BAT light to extinguish
 - B. BAT switch to trip
 - C. BAT light to illuminate
 - D. Both B and C
7. Where are the batteries located?
 - A. Nose compartment
 - B. Rear compartment
 - C. Baggage compartment
 - D. Passenger compartment
8. The HOT BAT light comes on when the battery internal temperature reaches what level?
 - A. 212° F
 - B. 194° F
 - C. 176° F
 - D. 150° F
9. What preliminary warning is given to indicate that the battery is getting hot?
 - A. A buzzer sounds
 - B. An amber WARM light illuminates.
 - C. A red HOT light illuminates.
 - D. The lights on the annunciator panel flash.
10. How is it possible to indicate a low battery temperature on the battery temperature indicator?
 - A. Depress the BAT 1 switchlight.
 - B. Turn the BAT switch off.
 - C. Turn the LESS 25 switch.
 - D. Depress the LESS 50 pushbutton switch.

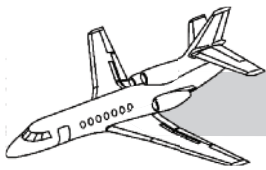

11. As soon as the batteries are connected, which battery supplies power to the start bus?
 - A. No. 1
 - B. No. 2
 - C. Emergency
 - D. Both No. 1 and No. 2
12. What systems are directly supplied from the battery bus?
 - A. Lighting, hydraulic pumps, air conditioning, and APU warning light
 - B. APU door closing, hydraulic pumps, altitude warning, and lighting
 - C. Annunciator panel, oxygen system, electronic cooling, and pilot seat adjust
 - D. Lighting, pressure refueling, fire-extinguishing, and APU door closing
13. When the start selector switch is in the EXT PWR position:
 - A. No. 1 battery is isolated.
 - B. No. 2 battery is isolated.
 - C. Both No. 1 and No. 2 batteries are isolated.
 - D. Neither battery is isolated.
14. If a generator switch trips, what action is required to reset its output?
 - A. Move the generator switch to OFF and then to ON.
 - B. Move the generator switch to ON.
 - C. Extinguish the indicator and switch the generator to ON.
 - D. Push the reset button.
15. Which engine generators supply electrical power to the main LH DC bus?
 - A. Nos. 1 and 3
 - B. Nos. 2 and 3
 - C. Nos. 1 and 2
 - D. Nos. 1, 2, and 3
16. Which generators supply power to the main RH DC bus?
 - A. Nos. 1 and 3
 - B. Nos. 2 and 3
 - C. Nos. 1, 2, and 3
 - D. No. 3 and APU
17. Where is the ground power receptacle?
 - A. On the left aft of the fuselage
 - B. In the nose wheel well
 - C. In the right wheel well
 - D. On the right, aft side of the fuselage
18. What voltage is required from a ground power unit?
 - A. 115 volts AC
 - B. 28 volts DC
 - C. 240 volts AC
 - D. 12 volts DC
19. How is ground power applied to the aircraft distribution system?
 - A. By turning the BAT switch to EXT
 - B. By selecting the DC power selector switch to EXT PWR
 - C. Automatically
 - D. By shutting off all electrical switches
20. When ground power is connected and selected which lights will be illuminated?
 - A. BAT 1, GEN 1, GEN 3
 - B. BAT 2, GEN 2, GEN 3
 - C. BAT 1, BAT 2, GEN 1
 - D. BAT 1, BAT 2, GEN 1, GEN 2
GEN 3

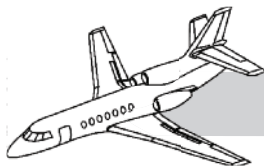

21. What voltage/Hz do the inverters produce?
- A. 28 volts DC and 26 volts AC, 400 Hz
 - B. 115 volts AC, 400 Hz and 26 volts AC, 400 Hz
 - C. 115 volts AC, 400 Hz and 28 volts DC
 - D. 115 volts AC, 400 Hz and 26 volts DC
22. If the AC 1 switch is set to ON and the standby inverter switch is full left, which inverter is supplying power to the 115- and 26-vac buses?
- A. The INS inverter, if power is on
 - B. The pilot inverter
 - C. The standby inverter
 - D. The copilot inverter, if it is turned on
23. By what means is the pilot inverter information displayed on the AC voltmeter?
- A. Depressing the INS switchlight
 - B. Depressing the AC BUS 2 switchlight
 - C. Depressing the AC BUS 1 switchlight
 - D. Depressing the AC BUS 1 and AC BUS 2 switchlights
24. If the pilot inverter frequency drifts beyond tolerance, what indication is shown?
- A. Illumination of the AC 2 master fault light
 - B. Extinguishing of the AC 2 master fault light
 - C. Illumination of the AC 1 master fault light
 - D. Extinguishing of the AC 1 master fault light
25. Which inverter(s) are in parallel with the INS inverter during warm up?
- A. Pilot
 - B. Copilot
 - C. Pilot and copilot
 - D. Standby

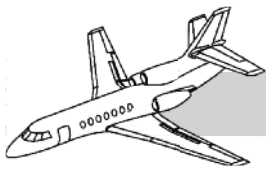

CHAPTER 3 LIGHTING

CONTENTS

	Page
INTRODUCTION.....	3-1
GENERAL.....	3-1
INTERIOR LIGHTING.....	3-2
Cockpit Dome Lights.....	3-2
Pilot and Copilot Map Reading Lights.....	3-2
Integrated Overhead Panel Lighting.....	3-2
Glareshield.....	3-2
Overhead Panel.....	3-2
Segment Digital Display.....	3-4
Control Pedestal and Console Instrument Lighting.....	3-4
FASTEN BELTS.....	3-4
NO SMOKING.....	3-4
Emergency Lighting.....	3-4
EXTERIOR LIGHTING.....	3-6
Navigation Lights.....	3-6
Anticollision Lights.....	3-6
Wingtip Strobe Lights.....	3-6
Landing Lights.....	3-6
Taxi Light.....	3-6
Wing Ice Detection Spotlights.....	3-6
Compartment Lights.....	3-8
QUESTIONS.....	3-9

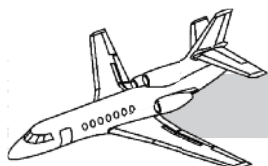

ILLUSTRATIONS

Figure	Title	Page
3-1	Lighting Controls.....	3-3
3-2	Emergency Lights	3-4
3-3	Emergency Lighting Locations.....	3-5
3-4	Exterior Lights	3-7
3-5	Exterior Access Compartment Lighting	3-8

TABLE

Table	Title	Page
3-1	Aircraft Lighting Bus Dependency	3-5

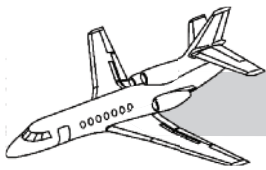

CHAPTER 3 LIGHTING

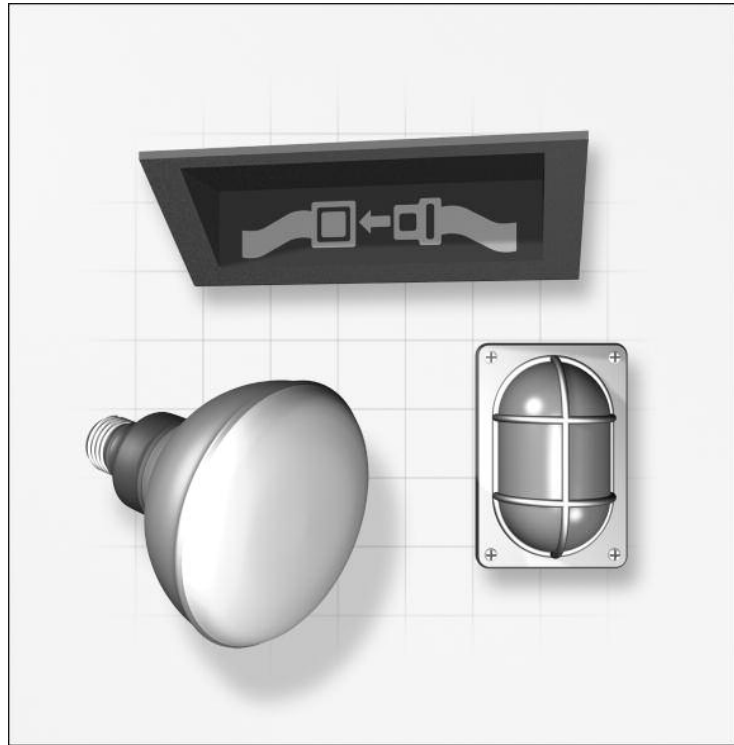

INTRODUCTION

In this chapter, aircraft lighting is divided into interior and exterior lighting. Interior lighting consists of cockpit dome, reading, integrated panel, glareshield, overhead panel, segment display, control pedestal and console instrument, passenger warning, and emergency lights. Exterior lighting consists of navigation, anticollision, wingtip strobe, landing, taxi, ice detection, and compartment lights. Each will be discussed separately.

GENERAL

The cockpit dome lights are supplied directly from the battery bus. However, should either auxiliary bus switch be rotated to the load-shed position, the cockpit dome lights will no longer be powered via the battery bus.

The rear compartment and baggage compartment dome lights are also powered via the battery bus. Again, should either auxiliary bus switch be rotated to the load-shed position, the compartment lights will no longer be powered

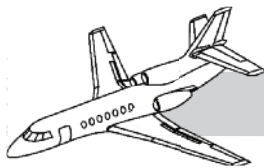

via the battery bus. A microswitch located in the door frame for both the baggage compartment and the rear compartment will provide automatic illumination of their respective dome lights when their doors are opened.

A portable light with a flex cord is located inside the nose cone. This light is also powered via the battery bus and, as previously stated for the other light circuits, is directly affected by the position of the auxiliary bus switches.

In the event of a failure of the normal electrical system, the emergency lighting system contained in three battery units will supply the emergency exit lights throughout the aircraft. In the ARMED or OFF positions, the battery packs are charged by 28 volts DC from buses A and B. These lights are controlled through a three-position switch located in the overhead panel, with the positions labeled OFF, ON, and ARMED. In the OFF position, the lights are not capable of illuminating. In the ON position, the lights will illuminate and be supplied directly from their individual battery packs. In the ARMED position (normal flight position), the lights should be extinguished; however, should there be any interruption of DC voltage from both of the main buses, the lights will automatically illuminate.

INTERIOR LIGHTING

Interior lighting is primarily controlled by dimmer rheostats (Figure 3-1) on the pilot and copilot dimmer control panels. Each map reading light has an individual dimmer control. The flight compartment dome light is controlled by a switch (DOME) located below the FASTEN BELTS indicator.

COCKPIT DOME LIGHTS

These lights are supplied directly from the battery bus. When either auxiliary bus switch

is rotated to the load-shed position, they will no longer be powered.

Three other lights are also wired through the load-shed switches and lose power when the switches are used. These lights are the rear compartment light, the baggage compartment dome light, and the portable nose cone light. These lights are controlled in their respective areas.

PILOT AND COPILOT MAP READING LIGHTS

Each light is installed on a swivel mount and has an individual dimmer.

INTEGRATED OVERHEAD INSTRUMENT PANEL LIGHTING

The uppermost dimmer on both pilot and copilot dimmers control panel is labeled INSTRUMENTS. The pilot dimmer controls the light intensity for the pilot essential flight instruments plus the fuel capacity gages. The copilot dimmer controls the copilot essential flight instruments plus the engine indicators.

GLARESHIELD

The next dimmer going down the left side of the dimmers control panel is labeled SHIELD. It controls the light intensity of the two fluorescent lights under the glareshield.

OVERHEAD PANEL

The second dimmer control down on the copilot panel is labeled OVERHEAD. It adjusts the overhead panel lighting intensity. It also varies the intensity of the dimmer panel lights, the blue ammeter selectors, and the standby compass lighting.

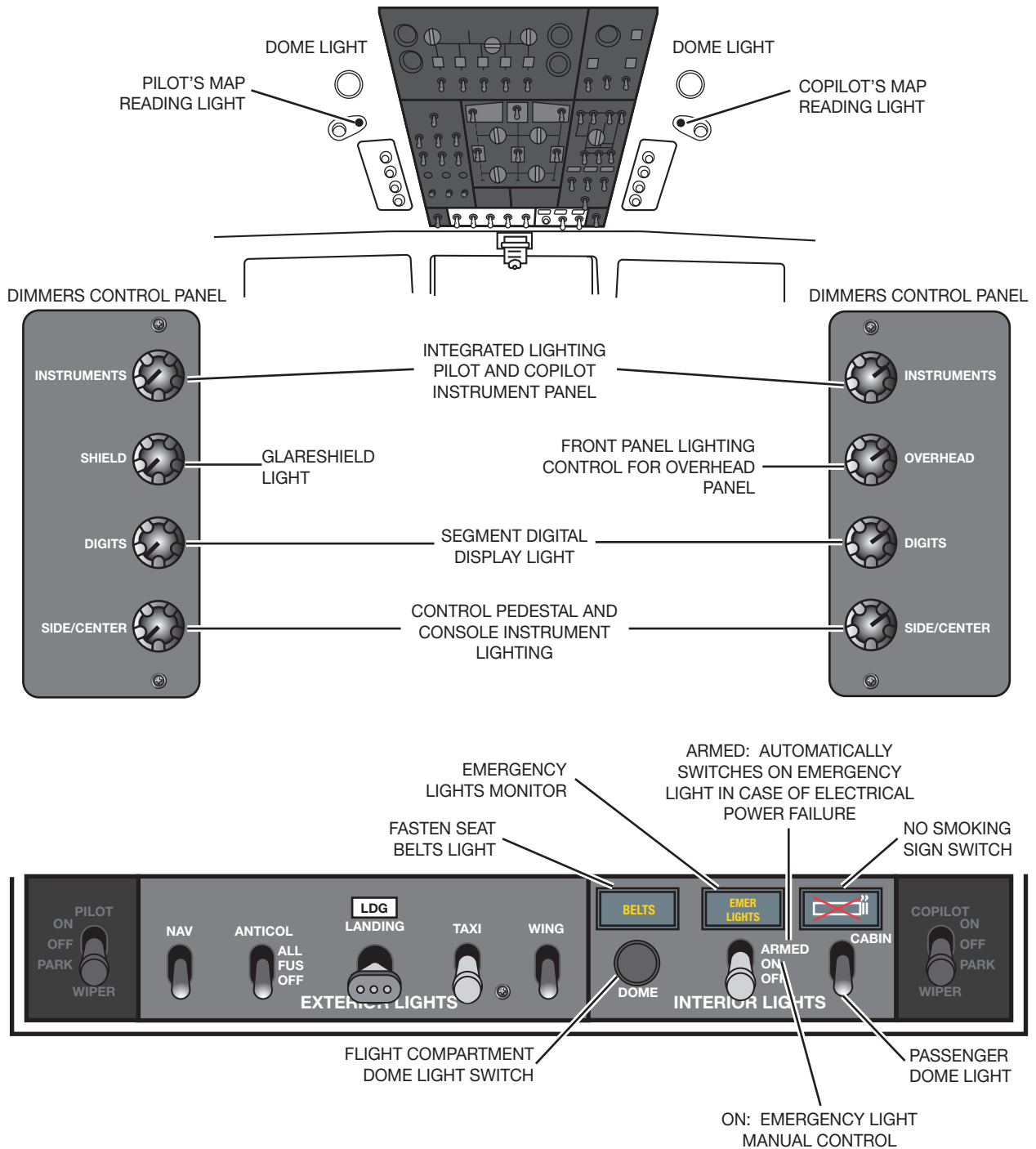
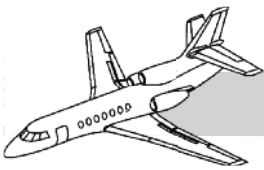
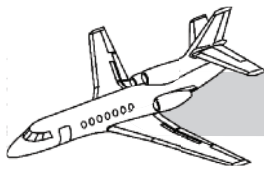

Figure 3-1. Lighting Controls



SEGMENT DIGITAL DISPLAY

The dimmers next to the bottom on both pilot and copilot panels are labeled DIGITS. They control the lighting intensity of the associated instrument digital display segments.

CONTROL PEDESTAL AND CONSOLE INSTRUMENT LIGHTING

The lower dimmers for both the pilot and copilot are labeled SIDE/CENTER. These dimmers switch on and off and control the intensity of integrated lighting. This lighting is for components and control panels located on the control pedestal and consoles.

FASTEN BELTS

When depressed, the switchlight illuminates and turns on the FASTEN BELTS sign in the passenger compartment.

NO SMOKING

When depressed, the switchlight illuminates and turns on the NO SMOKING sign in the passenger compartment.

EMERGENCY LIGHTING

In the event of electrical system failure, an emergency system which contains three battery packs will provide lighting. These units supply power to the emergency exit lights, the passenger indication lights, and the pilot and copilot dome lights. In normal operation, or in OFF position these battery units are charged by 28-volt DC aircraft power.

Control is accomplished by a three-position switch located on the overhead lighting panel, as shown in Figure 3-2. The switch positions are OFF, ON, and ARMED. In the OFF position, the battery units are disarmed. The EMER

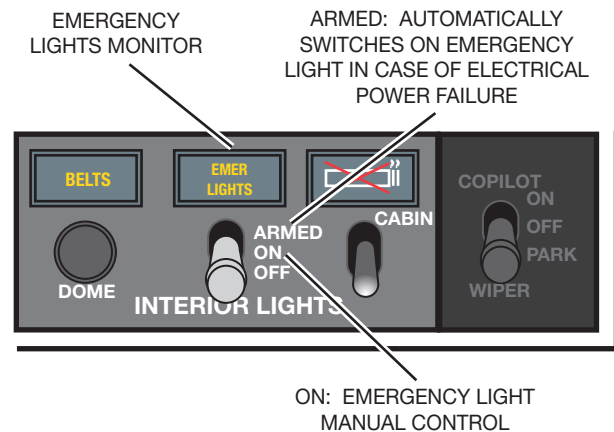

Figure 3-2. Emergency Lights

LIGHTS indicator light will be on if 28-volt DC aircraft power is applied while the switch is in the OFF position. In the ON position, the lights appropriately come on.

If power is being supplied, the battery units charge while the lights are in the ARMED or OFF switch positions.

When in the ARMED position, the lights come on only if power is lost on both primary buses. This position (ARMED) is selected prior to takeoff and should so remain for the entire flight. In the event of total electrical failure, the battery units maintain light illumination for approximately 15 minutes. The EMER LIGHTS indicator remains extinguished in this switch position.

The following lights, whose locations are shown in Figure 3-3, will illuminate with emergency lighting power:

- Pilot and copilot dome lights
- Passenger DOOR OPEN sign
- Emergency EXIT floodlights
- EXIT signs
- Underwing lighting

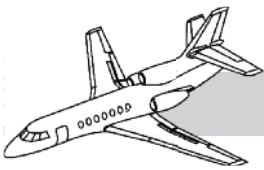

Table 3-1. AIRCRAFT LIGHTING BUS DEPENDENCY

AIRCRAFT LIGHTING			
BUS A	BUS B	BUS D	
Overhead Pane Standby Compass Pilot Reading Circuit-Breaker Panel Spot (2) Left Landing Light and Control Upper Anticollision Navigation Pilot Digits Pilot Instrument Ice Detection Spot Generator No. 1 and No. 2 (Blue) Battery No. 1 (Blue) Pilot Side/Center Console Left Wing Ice Inspection	Copilot Digits Overhead Panel Generator No. 3 (Blue) Battery No. 2 (Blue) Passenger Compartment Right Wing Ice Inspection Right Landing Light Standby Compass	Copilot Reading Copilot Instruments Copilot Center/Side Console Engine Instruments Right Landing Light Control Lower Anticollision	
	BUS C		BATTERY BUS
	Passenger Reading Taxi Strobe		
	BUS X 115 VOLT, 400 Hz		
	Glareshield		
EMERGENCY LIGHTING			
COCKPIT BATTERY (113L)	CABIN BATTERY (114L)	CABIN BATTERY (114L2)	
Passenger Door Exit Light Passenger Door Placard Light Dome Lights	LH Emergency Exit Light LH Wing Spotlight LH Slat Spotlight Ground Spotlight	RH Emergency Exit Light RH Wing Spotlight RH Slat Spotlight Passenger Door Handle Spotlight	

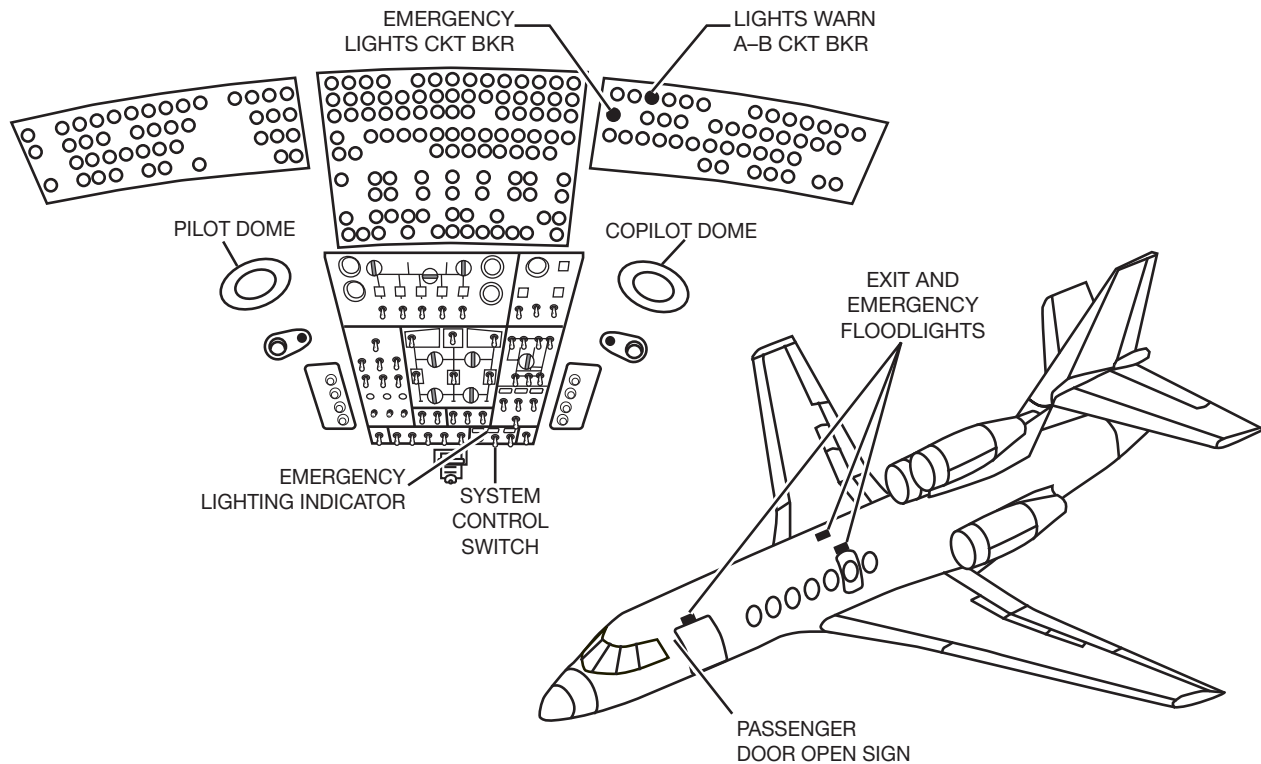
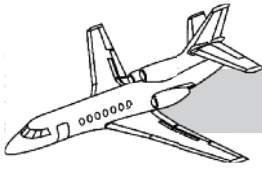

Figure 3-3. Emergency Lighting Locations



EXTERIOR LIGHTING

The exterior lighting consists of standard-type lights which include navigation, anticollision, wingtip strobe, landing, taxi, ice detection spot, and compartment lights (Figure 3-4).

NAVIGATION LIGHTS

The navigation lights consist of three 28-volt lamps. The left wingtip lamp is encased in red translucent plexiglass; the right wingtip, in green; and the tail fin lamp, in white. They are controlled by the NAV switch located on the overhead panel.

When the navigation lights are on, a small blue light illuminates the lower forward cockpit windows. This light is used as an ice detection system.

ANTICOLLISION LIGHTS

There are two strobe type anticollision lights—one located on the underside of the fuselage, the other on top of the vertical stabilizer. Each light consists of a discharge tube surrounding a multidirectional reflector. Each lamp is protected with a glass casing.

Control is accomplished with the ANTICOL switch on the overhead panel. The switch has three positions: ALL, OFF, and FUS. When positioned to FUS the fuselage and tail tip anticollision lights are activated. The ALL position adds the wingtip strobes.

WINGTIP STROBE LIGHTS

Each light is mounted in the wingtip beneath a plexiglass cover. The light consists of a discharge tube fixed in front of a parabolic reflector. When the anticollision switch is positioned to ALL, both the anticollision and the wingtip strobe lights are activated.

LANDING LIGHTS

The two landing lights are mounted in the wing fillets. Each light is a 600-watt assembly designed to operate with no limitation in flight. However, ground operation should be limited to 15 minutes on, followed by 45 minutes off.

When the LANDING switch on the overhead panel is activated, the landing lights will illuminate and the LDG indicator light comes on.

TAXI LIGHT

The 250-watt light is located on the nose gear strut. It has a range of approximately 820 feet. When the nose gear is extended and the TAXI switch on the overhead panel is activated, the taxi light illuminates.

WING ICE DETECTION SPOTLIGHTS

A 40-watt light for each side of the aircraft is designed to illuminate the wing leading edges. When leading-edge illumination is desired, activation of the WING switch will turn both lights on.

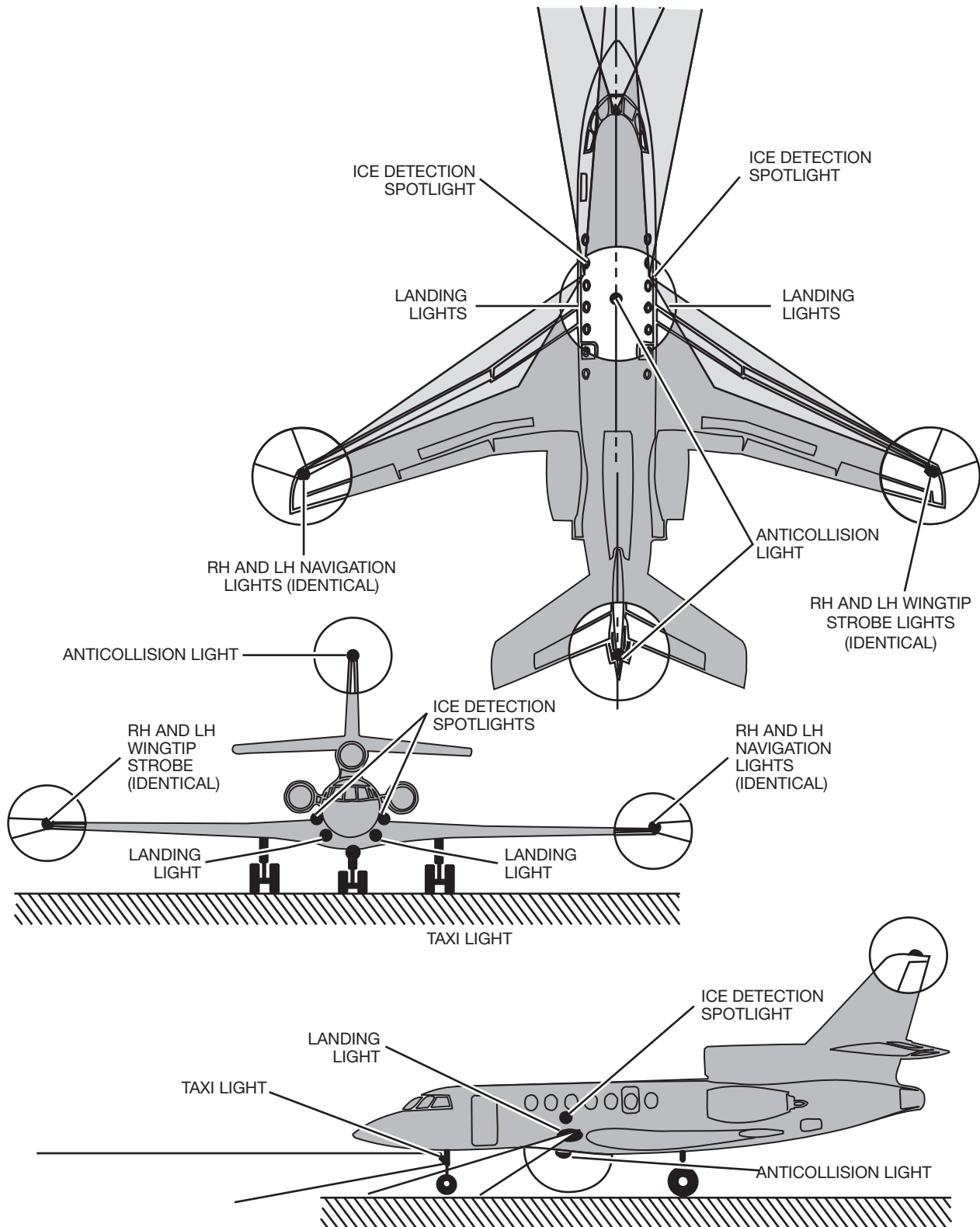
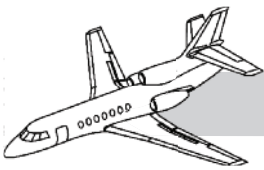
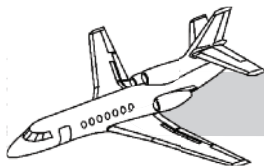

Figure 3-4. Exterior Lights



COMPARTMENT LIGHTS

Lighting of exterior access compartments is provided in the nose cone, baggage, and rear compartment areas as shown in Figure 3-5.

Nose cone lighting is in the form of a portable light. The light is equipped with a 20-watt bulb and a control switch located on the unit. It is fitted with a coiled cord and set on a stand attached to the nose cowl.

The baggage compartment light is a two-bulb, 42-watt dome light located on the baggage compartment ceiling. The light is automatically switched on when the compartment door is opened.

The aft compartment has two light units located on either side of the S-duct.

The lights are automatically switched on when the compartment door is opened, providing that switches for the buses C and D are in ON position.

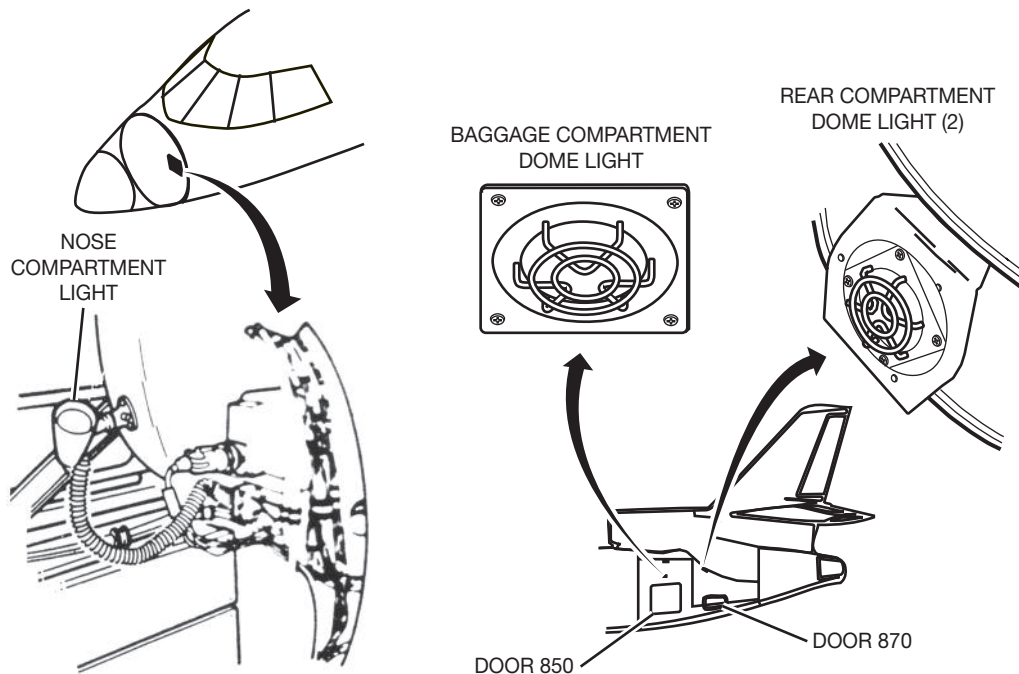
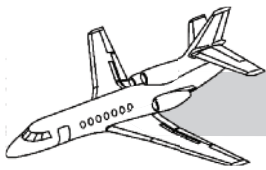
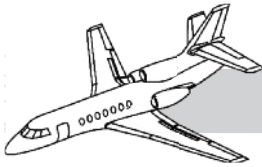

Figure 3-5. Exterior Access Compartment Lighting



QUESTIONS

1. What lights are directly fed from the battery bus?
 - A. Reading lights
 - B. Breaker panel lights
 - C. Dome lights
 - D. Emergency Lights
2. How are the cockpit dome lights turned on?
 - A. By a rheostat on the side console
 - B. By a push-button switch on the overhead panel
 - C. By a push-button switch on the entrance door
 - D. By a rheostat at the crew entrance way
3. What are the emergency lighting switch positions?
 - A. OFF, ARMED, STANDBY
 - B. OFF, ON, ARMED
 - C. OFF, STANDBY
 - D. OFF, CHARGE
4. In what switch position will the emergency lighting receive charging power?
 - A. ARMED
 - B. STANDBY
 - C. ON
 - D. ACTIVE
5. In which emergency lighting switch position will the lights automatically illuminate when power to both main buses is lost?
 - A. ACTIVE
 - B. ON
 - C. OFF
 - D. ARMED
6. After a total electrical failure, approximately how long will the emergency lights remain on?
 - A. 5 minutes
 - B. 10 minutes
 - C. 15 minutes
 - D. 45 minutes
7. When the anticollision light switch is positioned to FUS, which lights are on?
 - A. The beacon on the tail
 - B. The beacon on the fuselage
 - C. Both tail and fuselage strobes
 - D. Both beacons and wingtip strobes
8. What position of the anticollision light switch will turn on both the fuselage and the wingtip strobe lights?
 - A. OFF
 - B. FUS
 - C. ALL
 - D. ALL/FUS
9. During ground operation, what time ratio is required for landing light operation?
 - A. 15 minutes on and 45 minutes off
 - B. 45 minutes on and 15 minutes off
 - C. 25 minutes on and 15 minutes off
 - D. 25 minutes on and 25 minutes off
10. Other than looking out the window, what indication is there that the landing light is on?
 - A. Extinguishing of the LDG indicator light
 - B. Illumination of the LDG indicator light
 - C. Illumination of the landing light switch
 - D. Extinguishing of the landing light switch



11. How are the wing ice detection spotlights turned on?
 - A. Activation of the ICE switch
 - B. Activation of the TAXI switch
 - C. Activation of the INSP switch
 - D. Activation of the WING switch
12. When will the baggage compartment light illuminate?
 - A. When the cockpit lights are turned on
 - B. After the squat switch is activated
 - C. When the compartment door is opened
 - D. When the BAG switch is moved to ON
13. How many dome lights does the rear compartment have?
 - A. One
 - B. Two
 - C. Three
 - D. Four
14. Where is the nose cone light control?
 - A. In the cockpit
 - B. Incorporated into the access door
 - C. Located on the unit
 - D. Just inside the nose cone door

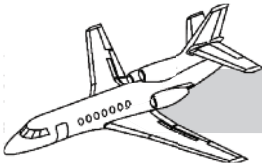

CHAPTER 4

MASTER WARNING SYSTEM

CONTENTS

	Page
INTRODUCTION.....	4-1
GENERAL.....	4-1
FAILURE.....	4-2
AUDIO WARNING SYSTEM.....	4-8
Activation Causes.....	4-8
LIMITATIONS.....	4-9
QUESTIONS.....	4-10

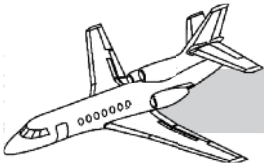

ILLUSTRATIONS

Figure	Title	Page
4-1	Failure Warning Panel.....	4-2

TABLES

Table	Title	Page
4-1	Annunciator Illumination Causes.....	4-3
4-2	Audio Activation Causes	4-8

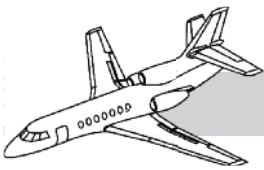

CHAPTER 4 MASTER WARNING SYSTEM

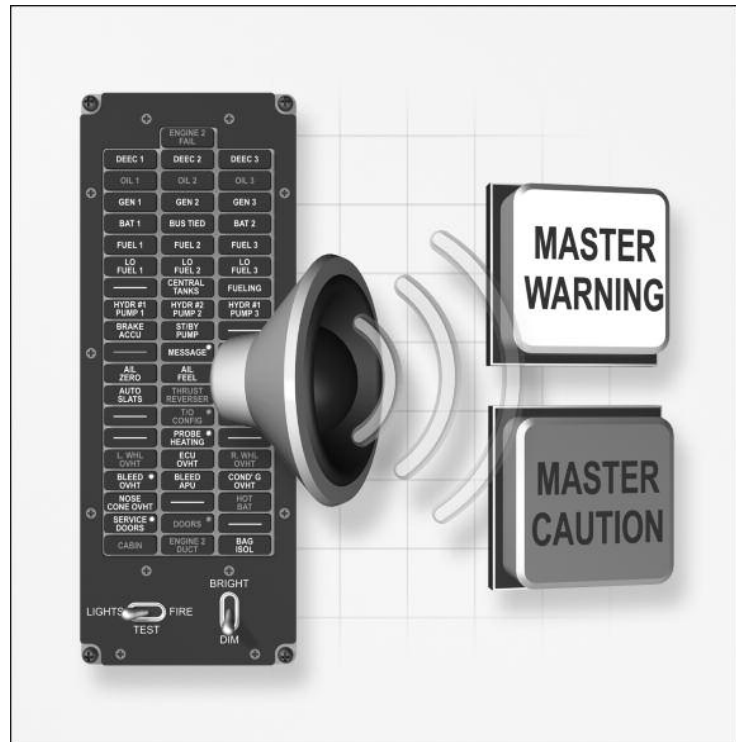

INTRODUCTION

The master warning system consists of the failure warning panel and the audio warning system. The system provides a warning to the crew of aircraft equipment malfunctions, unsafe operating conditions which require immediate attention, or an indication that a particular system is in operation. A system of aural tones is used to direct attention to certain system situations.

GENERAL

A panel with 38 indicator lights is mounted in front of the pilot. The lights, along with some audio tones, are designed to alert the pilot to some abnormal or undesirable system

conditions. The panel is known as the failure warning panel, and the tones are generated by the audio warning system.

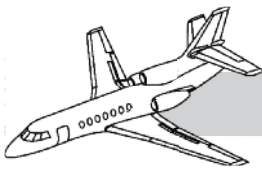

FAILURE WARNING PANEL

The failure warning panel (Figure 4-1) provides a means of alerting the pilot to certain system conditions. The annunciator lights are

either red or amber and will illuminate for the causes listed. A TEST pushbutton is provided to illuminate all annunciator lights. The BRIGHT DIM toggle switch is used to dim some of the indicator lights during night flight.

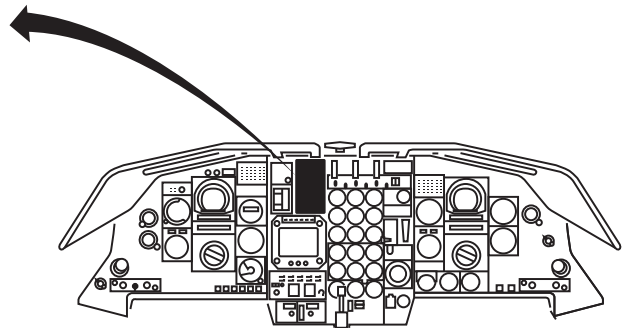
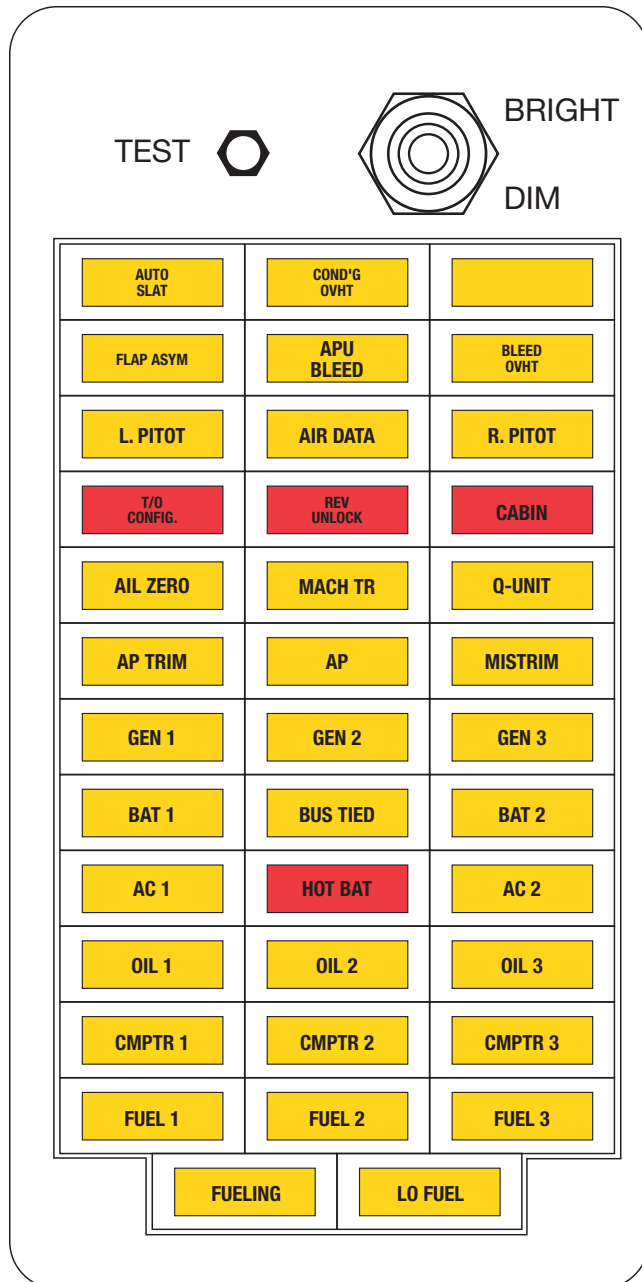

Figure 4-1. Failure Warning Panel

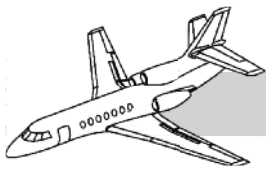

Table 4-1. ANNUNCIATOR ILLUMINATION CAUSES

WARNING LIGHT	CAUSES
<p style="text-align: center;">AUTO SLAT</p>	<p>Failure of IAS disarm contacts that normally prevent automatic extension of the outboard slats at IAS 270 kt. Also may include a problem with main L/G prox. switches. With SB 166, the LT indicates that one or both main prox. SWs are failed in ground mode following a 5 sec delay after T/O.</p>
<p style="text-align: center;">COND'G OVHT</p>	<p>Conditioned air overheat in the distribution ducts.</p> <p>Temperature of the air in the passenger cabin and/or cockpit supply duct becomes higher than 85–90°C.</p>
<p style="text-align: center;">[Empty Yellow Box]</p>	<p>RESERVED FOR FUTURE USE</p>
<p style="text-align: center;">FLAP ASYM</p>	<p>The flaps stop to move at the same time the light illuminates. Detection of LH and RH flap deflection asymmetry</p> <ul style="list-style-type: none"> • 5° for flap deflections of 20° • 8° for flap deflections of 48°
<p style="text-align: center;">APU BLEED</p>	<p>The APU bleed air valve is not closed, and any one of the three throttles is above 54° power lever angle (PLA).</p> <ul style="list-style-type: none"> • APU bleed switch is in OFF and APU bleed air valve is open • APU shutdown and bleed air valve is open
<p style="text-align: center;">BLEED OVHT</p>	<p>Steady illumination: With HP1, HP2, HP3 PRV switches in AUTO. Overheat in at least one of the engine bleed air lines—temperature is higher than 613°F (323°C) for all engine bleeds, 300°C for PRV.</p> <p>Note: Light will extinguish for a bleed air temperature lower than 510° F (265°C).</p> <p>Blinking light: Overheat is due to the associated HP/PRV valve control switch which has just been set to OFF.</p>
<p style="text-align: center;">L. PITOT</p> <p style="text-align: center;">R. PITOT</p>	<p>For associated LH or RH circuit:</p> <ul style="list-style-type: none"> • No electrical current for pitot heat or static probe heating or • Heating system monitoring circuit is failed

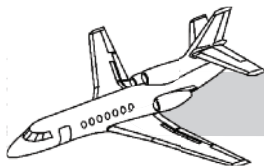

Table 4-1. ANNUNCIATOR ILLUMINATION CAUSES (Cont)

WARNING LIGHT	CAUSES
<div style="background-color: yellow; border: 1px solid black; padding: 5px; text-align: center; width: fit-content; margin: auto;">AIR DATA</div>	<p>Internal failure of the air data computer</p> <p>Note 1: Illumination of the light is controlled by the permanent self-test of the air data computer.</p> <p>Note 2: 1. If the validities of the different altitude words are not correct, the light will illuminate and the flag will come into view on the pilot's altimeter. 2. If the validities of Mach and IAS or V_S words are not correct, but altitude words are correct, only the light will illuminate.</p>
<div style="background-color: red; color: white; border: 1px solid black; padding: 5px; text-align: center; width: fit-content; margin: auto;">T/O CONFIG.</div>	<p>At least one of the three throttles must be at 82° power lever angle + Airplane is on the ground and one or more of the following + One of the four inboard airbrakes is not retracted or One of the four slats is not extended or The flaps are beyond the 22° position or The horizontal stabilizer is out of the takeoff range (-3° through -7°) or The autopilot is engaged or The parking brake is set or No. 2 brakes are applied</p>
<div style="background-color: red; color: white; border: 1px solid black; padding: 5px; text-align: center; width: fit-content; margin: auto;">REV UNLOCK</div>	<p>The thrust reverser is unlocked on the ground or in flight with the control handle in the STOW position.</p> <ol style="list-style-type: none"> 1. The control actuator not locked or 2. The microswitch which indicates STOW position for the RH or LH target door has not closed 3. The secondary latch has not locked <p>Remark: REV UNLOCK light illuminates as soon as stowing of the target doors is selected and will remain on as long as they have not reached the STOW position.</p> <p>Note: TRANSIT and DEPLOYED lights on the instrument panel illuminate sequentially.</p>

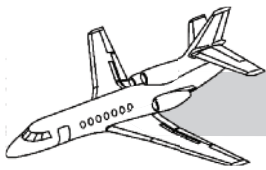

Table 4-1. ANNUNCIATOR ILLUMINATION CAUSES (Cont)

WARNING LIGHT	CAUSES
<div style="background-color: red; color: white; padding: 5px; text-align: center; font-weight: bold;">CABIN</div>	<ol style="list-style-type: none"> 1. With the aural warning: <ul style="list-style-type: none"> • The cabin altitude is higher than 10,000 ± 500 ft or 2. Without the aural warning: <ul style="list-style-type: none"> • The aft compartment door is not closed or • The baggage compartment door is not closed or • The passenger door locking handle is not latched or • The passenger door is not closed (latches are not engaged) or 3. The toilet service door is not closed (front lavatory only)
<div style="background-color: yellow; padding: 5px; text-align: center; font-weight: bold;">AIL ZERO</div>	<p>The emergency aileron actuator is not set to zero: (It is out of the ±30-minute range)</p>
<div style="background-color: yellow; padding: 5px; text-align: center; font-weight: bold;">MACH TR</div>	<p>This light illuminates when the MACH TRIM device is inoperative (The MACH TRIM device is not used or has failed) Limit A/S to .78m without Mach trim</p>
<div style="background-color: yellow; padding: 5px; text-align: center; font-weight: bold;">Q-UNIT</div>	<p>Failure of ARTHUR Q monitoring Discrepancy between speed information from the air data computer and that from the aileron and/or elevator Arthur Q</p> <p style="text-align: center;">Deviation of ± 30 kt up to IAS = 250 kt Deviation of ± 50 kt at 370 kt</p>
<div style="background-color: yellow; padding: 5px; text-align: center; font-weight: bold;">AP TRIM</div>	<p>AP coupler trim circuit has failed (monitoring of the electrical pulses sent to the horizontal stabilizer actuator by the AP computer)</p>
<div style="background-color: yellow; padding: 5px; text-align: center; font-weight: bold;">AP</div>	<p>Autopilot has failed.</p> <p>Automatic disengagement of the autopilot and illumination of the light. Failure detected by the AP internal monitoring circuit.</p> <p>Note: The light can be extinguished by again pressing the AP DISENGAGE button on either control wheel.</p>
<div style="background-color: yellow; padding: 5px; text-align: center; font-weight: bold;">MISTRIM</div>	<p>Horizontal stabilizer does not move, although commanded to do so by the autopi-</p>

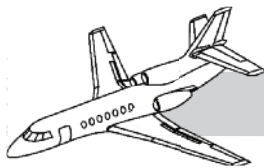

Table 4-1. ANNUNCIATOR ILLUMINATION CAUSES (Cont)

WARNING LIGHT	CAUSES
<p>GEN 1</p> <p>GEN 2</p> <p>GEN 3</p>	<p>The generator mounted on engine No. 1, 2, or 3 is not connected to the main bus bar (associated reverse current relay open).</p>
<p>BAT 1</p> <p>BAT 2</p>	<p>The main bus bars are no longer supplied by the batteries (associated contactor open).</p>
<p>BUS TIED</p>	<p>The bus tie switch is in the tied position.</p>
<p>AC 1</p> <p>AC 2</p>	<p>Inverter 1 or 2 is off. Frequency drift ± 30 Hz from 400 Hz. A voltage drop has occurred in the associated 26 VAC circuit (SB 214 only) or The associated inverter frequency is no longer synchronized (The light illuminates if frequency becomes lower than 370 Hz) (The light illuminates if frequency becomes higher than 430 Hz)</p>
<p>HOT BAT</p>	<p>Battery 1 and/or 2 overheat—light illuminates for an internal temperature of more than 150°F (160°F if aircraft has S/B 295)</p> <p>Note: This light is in parallel with the red light located on the double BAT TEMP indicator.</p>
<p>OIL 1</p> <p>OIL 2</p> <p>OIL 3</p>	<p>In the associated engine:</p> <ul style="list-style-type: none"> • Oil pressure becomes lower than 25 ± 1 psig or • Chips have been detected <p>Note: The light will extinguish if oil pressure rises again above 35 psig.</p>

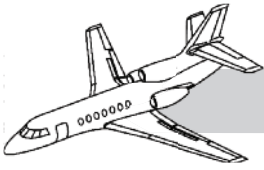
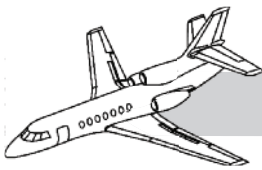

Table 4-1. ANNUNCIATOR ILLUMINATION CAUSES (Cont)

WARNING LIGHT	CAUSES
<p>CMPTR 1</p> <p>CMPTR 2</p> <p>CMPTR 3</p>	<p>The computer of the associated engine is off or The computer has failed (internal failure or electrical power supply failure or incorrect data has been processed to the computer)</p>
<p>FUEL 1</p> <p>FUEL 2</p> <p>FUEL 3</p>	<p>Fuel booster pump pressure becomes lower than 5.0–6.0 psig (345–415 relative mbar)</p>
<p>FUELING</p>	<p>Any one of the three air-vent valves (feeder tank or wing tank) is not closed or The defueling valve is not closed or The pressure refueling access door is not closed or The gravity fueling control switch is not in the OFF position or The auxiliary D bus switch is in the OFF position</p>
<p>LO FUEL</p>	<p>The fuel level in any one of the three feeder tanks becomes lower than 250–300 lb for a minimum period of 15 ±3 seconds</p>



AUDIO WARNING SYSTEM

The audio warning system generates audible warnings for certain conditions important to safety of flight. The system provides warning tones for the reasons listed. Cabin pressure, stall 1 and 2, and V_{MO} can be tested with push-

button switches located on the pilot side of the center console.

ACTIVATION CAUSES

The following listing gives the aural warning for each system, the type sound, and when it will activate.

Table 4-2. AUDIO ACTIVATION CAUSES

WARNING DESIGNATION	AUDIO WARNING	SIMULTANEOUS WARNING OR INDICATION	CAUSES	POSSIBILITY OF STOPPING WITH HORN SILENCE
V_{MO}/M_{MO}	Continuous variable-frequency sound. • Frequency varies between 660 Hz and 3,330 Hz for 1 second	Pilot and copilot Mach-air speed indicator readings above V_{MO}/M_{MO} red line	V_{MO}/M_{MO} limits are exceeded IAS higher than: 1. 350 kt at Z = 0 370 kt at Z = 10,000 ft Strait-line variation between these values 2. 370 kt at Z = 10,000 ft indicated Mach higher than 0.85 at Z >23,200 ft	No
Cabin Pressure	Intermittent sound Frequency: 250 Hz • On for 600 ms • Off for 200 ms	CABIN red light on failure panel Cabin altitude reading higher than 10,000 ft on cabin	Cabin altitude higher than 10,000 ±500 ft	Yes
Fire	Continuous two-pitch sound frequency: 550/555 Hz for 150 ms	Illumination of at least one FIRE light on fuel shutoff handle or on fire panel	Fire is detected	Yes
Altitude Deviation	Continuous sound • Aural frequency:		From a given altitude, the aircraft flies to the altitude selected on the altitude alerter. When within 1,000 ft from this altitude, the aural warning sounds for 2 sec. and the light on the indicator illuminates. Once the preset altitude is reached, the aural warning sounds for 2 sec. and the light illuminates whenever the aircraft deviates from this altitude more than 300 ft.	No

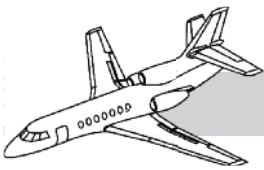
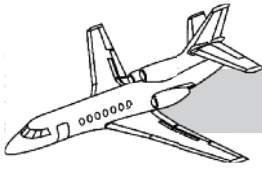

Table 4-2. AUDIO ACTIVATION CAUSES (Cont)

WARNING DESIGNATION	AUDIO WARNING	SIMULTANEOUS WARNING OR INDICATION	CAUSES	POSSIBILITY OF STOPPING WITH HORN SILENCE
Horizontal Stabilizer	Continuous sound: CLACKER <ul style="list-style-type: none"> • Frequency: 12.5 Hz • Pulses 	Horizontal stabilizer position indicator needle is moving (on trim panel)	Horizontal stabilizer is moving (up or down) in normal (controlled by crew or AP) or in emergency	No
Stall	Intermittent sound (BIP-BIP): <ul style="list-style-type: none"> • Frequency: 1,660 Hz • On for 100 ms • Off for 100 ms 	Illumination of the three <input type="checkbox"/> IGN lights on overhead panel Illumination of green slat light	Slats not extended LH local angle-of-attack >17° corresponding to an aircraft angle-of-attack >11°. RH local angle-of-attack >19° corresponding to an aircraft angle-of-attack >12°	No
		Illumination of the three <input type="checkbox"/> IGN lights on overhead panel	Slats extended LH and RH local angle-of-attack >27° corresponding to an aircraft angle-of-attack >17°	
Landing Gear	Continuous sound at 285 Hz		Flap handle is selected to 48°; any of the landing gear is not downlocked	No
		Landing gear control handle light is	Power setting is reduced (at least one of the three throttles) IAS < 160 ± 5 kt Any of the landing gear is not downlocked	Yes

LIMITATIONS

As indicated in the previous listing, some alarms can be silenced by means of the HORN SILENCE pushbutton.



QUESTIONS

1. How can the failure warning panel be checked?
 - A. By depressing the DIM switch
 - B. By depressing the TEST switch
 - C. By depressing the BRIGHT switch
 - D. By depressing the lighting test switch
2. If the red CABIN light on the failure warning panel illuminates, what sound will accompany it?
 - A. A continuous variable 660-3330-Hz tone
 - B. A continuous clacker of 12.5-Hz pulses
 - C. An intermittent 250-Hz tone
 - D. An intermittent 1660-Hz tone
3. Which of the following audible sounds can be silenced with the use of the horn silence button?
 - A. Fire
 - B. V_{MO}/M_{MO}
 - C. Stall
 - D. Altitude deviation
4. Where are the test switches for the stall 1 and 2 warning tone located?
 - A. On the pilot side console
 - B. On the forward instrument panel
 - C. On the copilot side console
 - D. On the center console
5. Which of the following has a test switch on the pilot side of the center console?
 - A. Fire
 - B. V_{MO} , CABIN PRES, STALL 1 and 2
 - C. Altitude deviation
 - D. Horizontal stabilizer

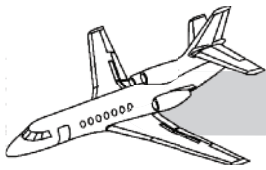

CHAPTER 5 FUEL SYSTEM

CONTENTS

	Page
INTRODUCTION.....	5-1
GENERAL.....	5-1
FORWARD TANKS.....	5-2
Wing Tanks.....	5-2
Center Wing Tank.....	5-4
FUEL TRANSFER SYSTEM.....	5-4
General.....	5-4
Jet Pumps.....	5-4
Isolation Shutoff Valves.....	5-4
Transfer Pumps.....	5-5
Interconnect Valves.....	5-5
Transfer Valves.....	5-6
Transfer System Controls and Indicators.....	5-7
Feeder Tanks.....	5-8
ENGINE FEED SYSTEM.....	5-8
Booster Pumps.....	5-8
Shutoff Valves.....	5-9
Engine Feed System Controls and Indicators.....	5-11
DRAINING AND DEFUELING.....	5-11
Sump Drains.....	5-11

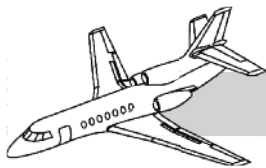

REFUELING	5-12
Pressure Fueling.....	5-12
Gravity Fueling	5-14
Defueling.....	5-17
LIMITATIONS	5-18
Authorized Fuels.....	5-18
Pressure-Fueling Limits	5-18
Fuel Additives	5-18
QUESTIONS	5-20

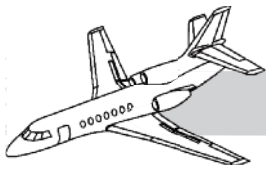

ILLUSTRATIONS

Figure	Title	Page
5-1	Transfer System Schematic	5-2
5-2	Fuel Storage	5-3
5-3	Fuel Quantity Gages, Indicators, and Controls	5-3
5-4	Isolation Shutoff Valve	5-5
5-5	Transfer Valves (Simplified)	5-6
5-6	Transfer System Block Diagram	5-7
5-7	Fuel Supply Schematic	5-9
5-8	Engine Feed System Block Diagram	5-10
5-9	Fuel Sump Drain Locations and Operation	5-11
5-10	Pressure Refueling Door and Panel	5-12
5-11	Refuel System Schematic.....	5-13
5-12	Gravity Refueling Schematic	5-16
5-13	Defuel System Schematic	5-17

TABLES

Table	Title	Page
5-1	Authorized Fuels	5-19

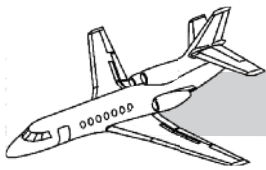

CHAPTER 5

FUEL SYSTEM



INTRODUCTION

The fuel system on the Falcon 50 consists of three separate subsystems: left, center and right. Each subsystem normally operates independently, supplying fuel to its respective engine. However, interconnect and crossfeed valves allow efficient fuel distribution in case of component failures, enabling transfer of fuel from any tank to any engine.

GENERAL

The aircraft has a total of six integral tanks with a total usable fuel capacity of 15,513.8 pounds (2,315.5 gallons at 6.7 pounds/gallon). Three tanks are located in the wing; two wing tanks, and a wing center section tank. The wing tank is divided into three sections. Three corresponding engine feeder tanks are installed in the rear fuselage. Low-pressure fuel is supplied to the engine-driven fuel pumps by combined tank pressurization, transfer pumps, and boost pumps (Figures 5-1 and 5-2).

Operation of the engine-driven fuel pumps is covered in Chapter 7, "Powerplant."

All tanks are pressurized by low-pressure bleed air coming from the No. 1 and No. 2 engines. The system is automatically pressurized as soon as either the No. 1 or the No. 2 engine is started.

Each of the three fuel subsystems also incorporates a transfer system, an engine feed system, a flowmeter, and controls and indicators.

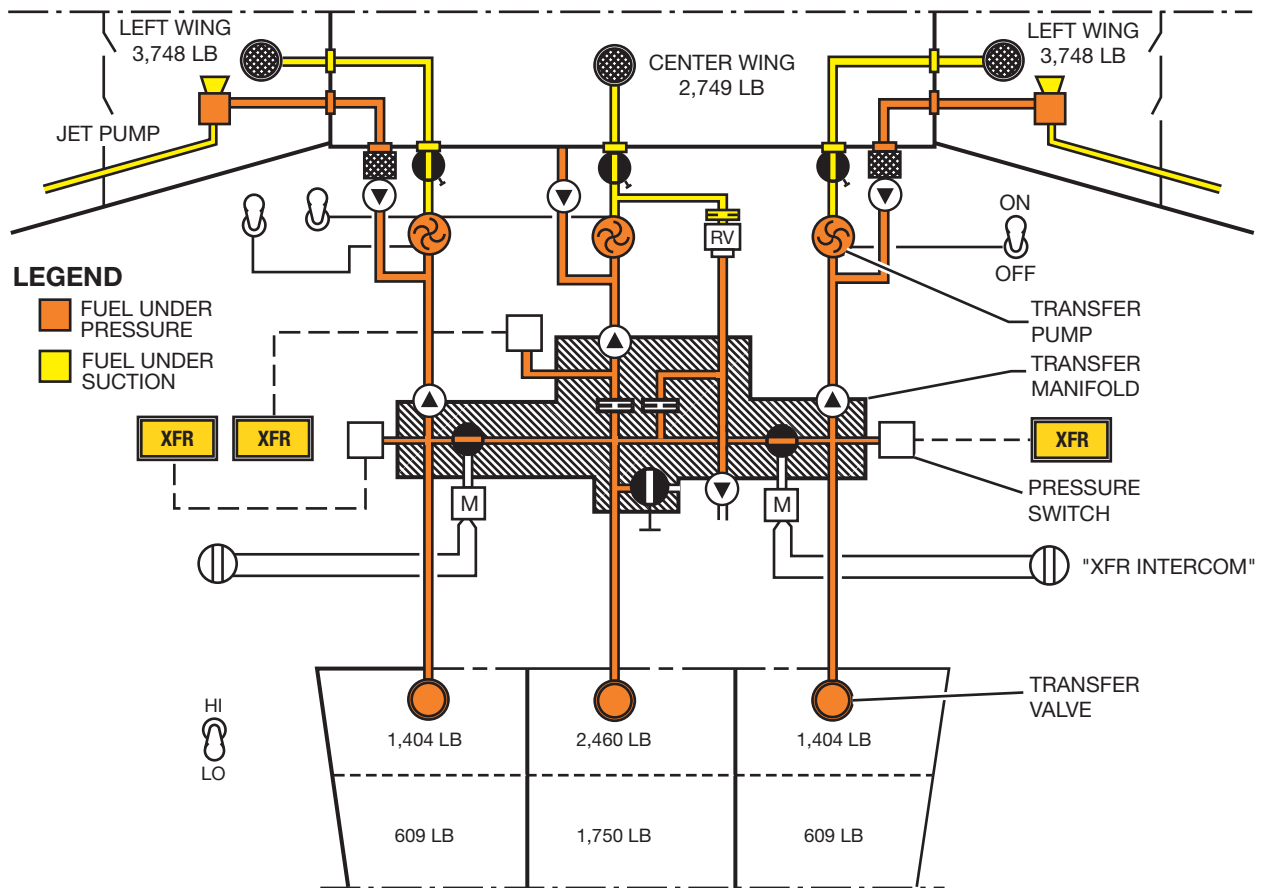
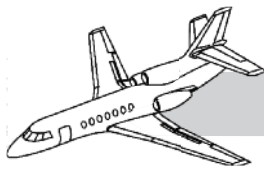

Figure 5-1. Transfer System Schematic

The aircraft can be fueled by the over-the-wing method or at a single-point pressure fueling station. The aircraft can be defueled by suction, pumping, and/or draining.

flow, fuel used, and gross weight measurements can also be provided.

FORWARD TANKS

Fuel quantity is measured by capacitor-type probes.

WING TANKS

The wing tanks are pressurized to approximately twice the pressure of the feeder tanks. This feature prevents fuel pump cavitation and assists fuel transfer to the feeder tanks in case of failure of the normal transfer system. The system is controlled and monitored by use of a fuel system panel, a master warning panel, and three fuel gages (Figure 5-3). Fuel

The aircraft is capable of operation using a wide variety of fuels, including Jet A, Jet A-1, and Jet B. Use of aviation gasoline is not permitted.

The fuel capacity of each wing tank is 3,748 pounds (approximately 560 gallons).

Each of the two wing tanks is divided into two sections; an inboard section and an outboard section. The tanks are divided by solid ribs to prevent fuel from sloshing inside the tanks and to maintain better lateral balance.

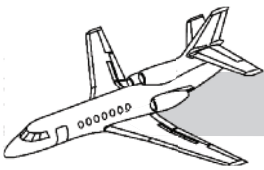

FALCON 50 PILOT TRAINING MANUAL

LEFT WING 3,748 LB 1,700 KG 2,117 LITERS 559 U.S. GAL	WING CENTER SECTION 2,749 LB 1,247 KG 1,553 LITERS 410 U.S. GAL	RIGHT WING 3,748 LB 1,700 KG 2,117 LITERS 559 U.S. GAL
--	--	---

WING TANKS

TANK PRESSURE WING TANKS 4.2 PSI FEEDER TANKS 1.9 PSI	LEFT	CENTER	RIGHT	REFUELED TO HIGH LEVEL 15,513 LB 7,037 KG 8,763 LITERS 2,315 U.S. GAL
	1,404 LB 637 KG 793 LITERS 210 U.S. GAL	2,460 LB 1,116 KG 1,390 LITERS 367 U.S. GAL	1,404 LB 637 KG 793 LITERS 210 U.S. GAL	
	609 LB 276 KG 344 LITERS 91 U.S. GAL	1,750 LB 794 KG 988 LITERS 261 U.S. GAL	609 LB 276 KG 344 LITERS 91 U.S. GAL	REFUELED TO LOW LEVEL 13,213 LB 5,993 KG 7,463 LITERS 1,971 U.S. GAL

FEEDER TANKS

Figure 5-2. Fuel Storage

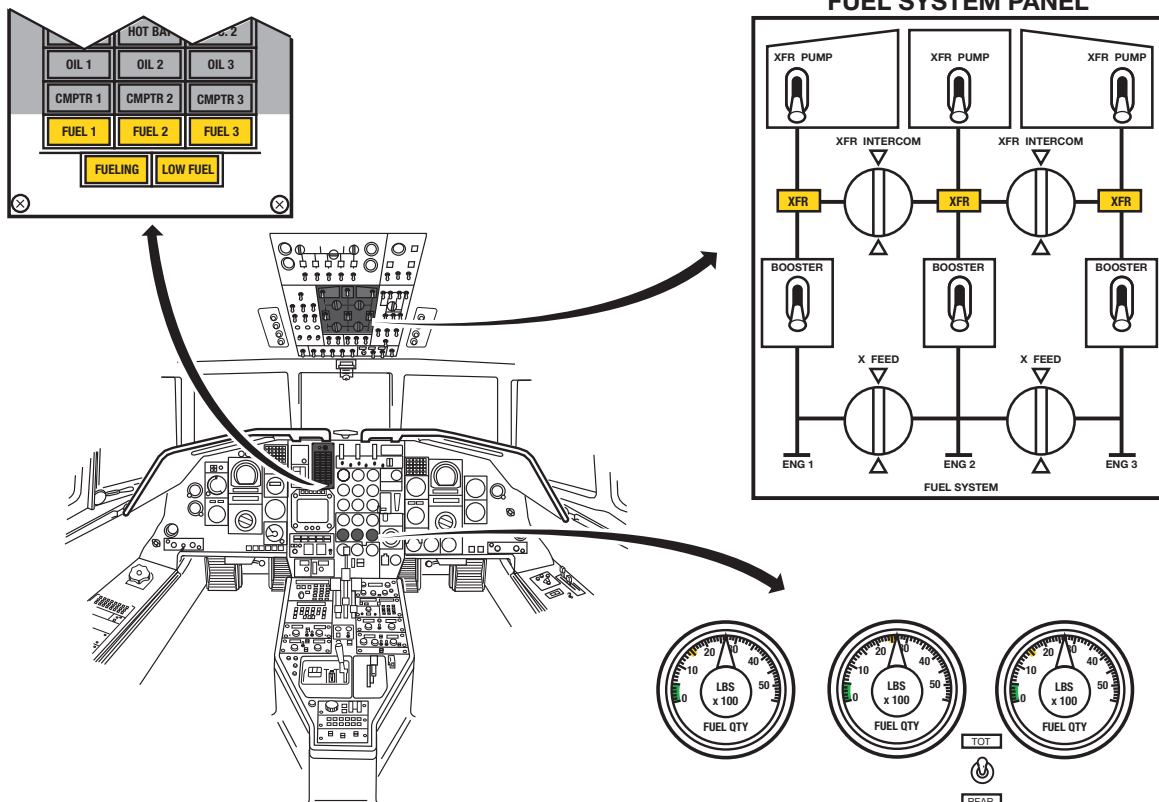
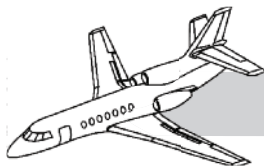

Figure 5-3. Fuel Quantity Gages, Indicators, and Controls



To assist in fuel distribution and maintain center of gravity, fuel is transferred from the outboard sections to the inboard sections by jet pumps. The jet pumps are powered by excess fuel pressure from the transfer pumps. Operation of the jet pumps will be discussed later.

Flapper valves are installed between the solid ribs which divide the inboard and outboard sections to prevent reverse fuel flow from the inboard wing section to the outboard wing section (see Figure 5-1). Small holes are drilled at the top of the solid rib so that air pressure can be distributed evenly.

CENTER WING TANKS

The center wing tank is installed between the wing tanks (see Figure 5-1). It has a capacity of 2,749 pounds (410 gallons). The top of the tank is vented and isolated from the pressurized cabin by a double skin.

Unlike the wing tanks, the center wing tank is not divided into sections and is not equipped with a jet pump. There is normally excess fuel flow from the transfer pump. However, instead of powering a jet pump, this fuel is simply pumped back into the tank to provide continuous circulation for pump cooling and to prevent stalling of the pump at zero flow.

FUEL TRANSFER SYSTEM

GENERAL

Fuel is transferred from the wing tanks and center wing tank to the feeder tanks by transfer pumps and differential pressure. The rate of fuel flow equals the engine consumption rate. The wing tank fuel must be exhausted before the feeder tanks drop below their regulated level.

A system of valves allows the pilot to control this fuel transfer.

JET PUMPS

The aircraft is equipped with two fuel jet pumps (see Figure 5-1). The pumps employ the venturi principle to drain fuel from the outboard wing sections to the inboard wing sections. This method maintains a more forward center of gravity by burning the fuel from the outer and more aft tank sections first.

The left and right jet pumps are powered by excess fuel flow and pressure produced by the No. 1 and No. 3 transfer pumps, respectively. The jet pumps function at all times when the associated transfer pump is operating.

In case of transfer pump failure, fuel is transferred by gravity through the flapper valves.

ISOLATION SHUTOFF VALVES

After leaving the wing tanks, the fuel passes through three manually operated isolation shutoff valves (see Figure 5-1).

The mechanically operated valves are installed on the rear spar of the wing center section. The valves are used to shut off any uncontrolled fuel transfer caused by a malfunction in the transfer system, such as a fuel leak.

Each valve may be actuated or closed from the interior of the aircraft by using a special T-handle wrench (Figure 5-4). Each end of the T-handle fits its corresponding receptacle and allows operation of the valves during flight to control a fuel leak.

NOTE

These valves can also be operated from the exterior of the aircraft for maintenance purposes.

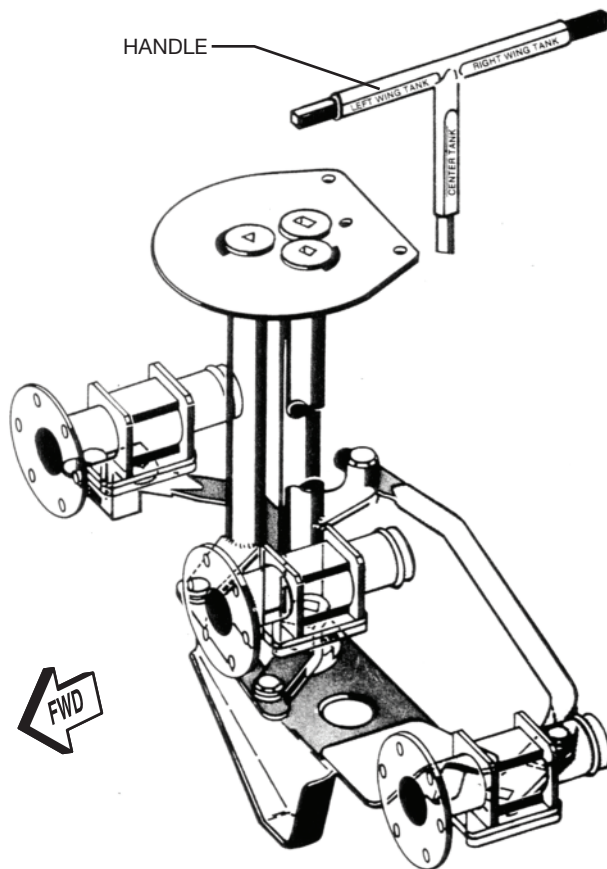
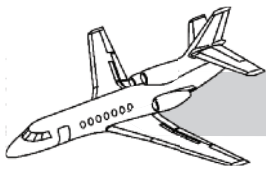

Figure 5-4. Isolation Shutoff Valve

TRANSFER VALVES

Three centrifugal transfer pumps supply fuel from the wing tanks and center section tank to the feeder tanks (see Figure 5-1). Turning on a transfer pump will normally extinguish its associated XFR light on the overhead fuel panel.

The DC-powered pumps are normally operated continuously when fuel remains in the wing tanks. The pumps should not be allowed to operate when no fuel is remaining.

The No. 1 and No. 2 pumps are powered by auxiliary bus C. The No. 3 pump is powered by auxiliary bus D.

Both auxiliary bus C and auxiliary bus D are subject to load shedding when the load shedding switches on the electrical panel are used. This means that the transfer pumps will not be powered if the load-shed switches are activated. Load shedding is covered in Chapter 2, “Electrical Power Systems.”

The pump is designed to allow fuel to flow freely through the pumping mechanism in case a pump motor fails or is turned off. In this situation, the fuel is transferred by differential air pressure.

INTERCONNECT VALVES

The fuel system is equipped with two interconnect valves (see Figure 5-1), which are controlled by a switch on the overhead panel labeled INTERCOM. The pilot can control the flow of fuel from the wing tanks to the feeder tanks by opening and closing the interconnect valves and operating various combinations of the transfer pumps. For additional information, refer to engine feed system controls and indicators. This feature improves the pilot’s ability to manage the fuel system and correct for malfunctions in the transfer system.

The center wing tank and the wing tanks are equipped with check valves which prevent inadvertent transfer of fuel from one wing tank to another.

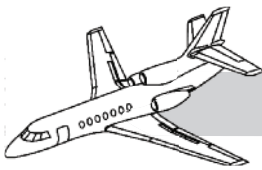

TRANSFER VALVES

A transfer valve is installed in the floor of each feeder tank (Figure 5-5). The valves control the flow of fuel into the feeder tanks and act as a check valve when fuel is not being transferred.

The transfer valves are controlled by their associated float valves. The level is determined by the solenoids on the bottom exterior of the tank. These solenoids allow the transfer valves to reference the desired float.

During flight, the fuel level in each of the feeder tanks is automatically maintained at

609 pounds (approximately 90 gallons). This is called “regulation” level, and the transfer valves only reference the low level floats.

The feeder tanks may, however, be refueled to quantities above the regulation level by referencing the upper floats. After refueling above regulation level, the fuel is not transferred from the wing tanks to the feeder tanks until fuel levels decrease to regulation levels (see Figures 5-3 and 5-5). When the regulation levels are reached, the transfer valves automatically operate so that fuel flows from the wing tanks to maintain the feeder tank at the regulation level (609 pounds).

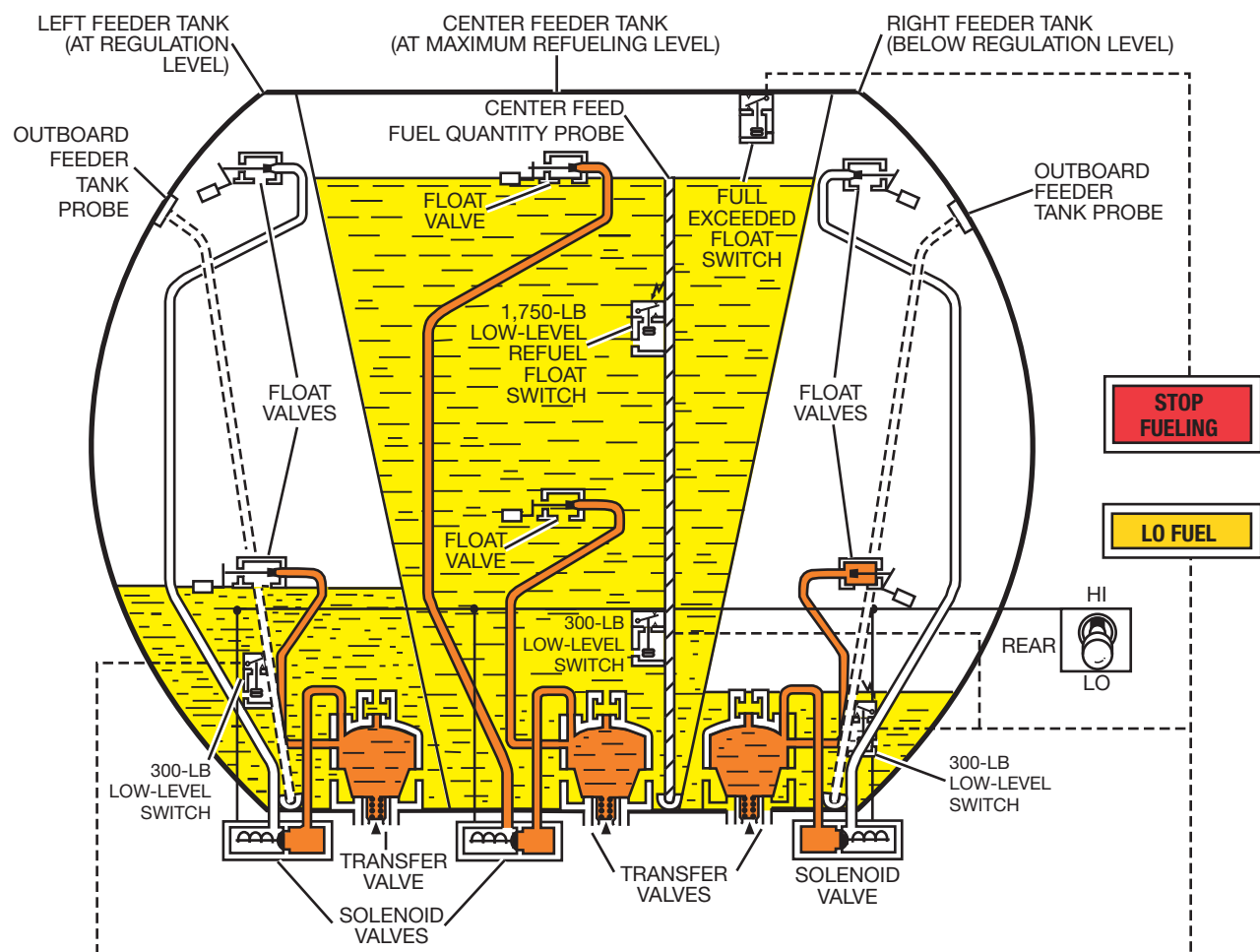
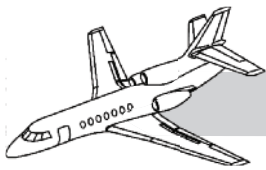

Figure 5-5. Transfer Valves (Simplified)



If aircraft has S/B 175, a three position switch with a guard is on the center, lower right side instrument panel. This allows the crew a means of correcting for a frozen or stuck lower transfer valve float. This service bulletin only affects the side feeder tanks but not the center.

TRANSFER SYSTEM CONTROLS AND INDICATORS

The transfer pumps and the interconnect valves are controlled by switches on the upper portion of the fuel system panel (Figure 5-6). The toggle

switches for the three transfer pumps are labeled XFR PUMP. The two rotary transfer valve switches are labeled XFR INTERCOM.

The upper portion of the fuel system panel has three yellow lights labeled XFR. The lights are controlled by pressure switches installed downstream from the transfer pumps.

The lights come on to indicate a malfunction in the transferring system, such as failure of the transfer pump. The lights also illuminate when their associated wing tank is empty.

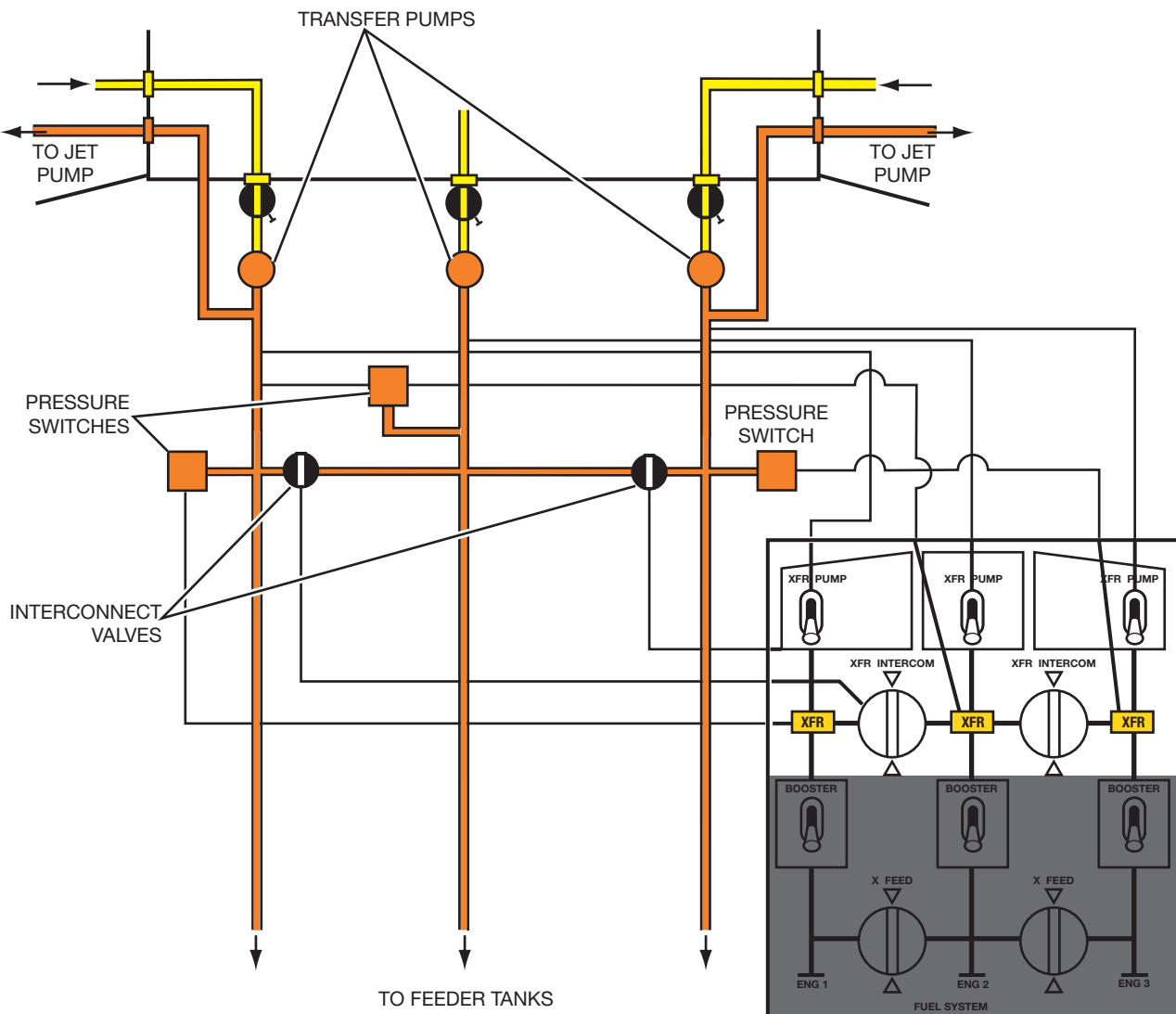
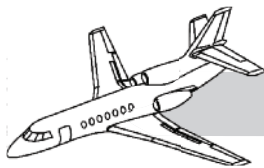

Figure 5-6. Transfer System Block Diagram



FEEDER TANKS

The feeder tanks supply fuel to the engines and increase the aircraft's total fuel capacity. During normal operation, the left wing tank supplies fuel to the left feeder tank. The wing center section tank supplies the center feeder tank, and the right wing tank supplies the right feeder tank (see Figure 5-1).

The maximum level in the left and right feeder tank is approximately 1,400 pounds (209 gallons). The maximum level in the center feeder tank is approximately 2,460 pounds (367 gallons). More fuel is stored in the center feeder tank to compensate for the difference between the amount of fuel in the wings and the amount of fuel in the wing center section.

The three fuel gages (see Figure 5-1) indicate either the overall weight of the fuel in each group of tanks or the weight of the fuel in each feeder tank. The indication depends on the position of the TOT-REAR switch (Figure 5-3). In the TOT position, the gages indicate the total fuel in the feeder tanks and the corresponding wing tanks. In the REAR position, the gages indicate only the fuel quantity in the feeder tanks.

During flight, the fuel quantity must be checked to ensure that fuel quantity in the tanks decreases as it should. This check is accomplished by positioning the selector to TOT from time to time. The pilot should bear in mind that 609 pounds will be indicated on the gage when the forward tank is empty. The 609 pounds of fuel represent the amount remaining in the feeder tank.

NOTE

The fuel quantity indicators could show slightly higher values than the quantity actually loaded. The difference can be as much as 200 to 300 pounds with 3,000 pounds in one set of tanks (wing tanks, or center wing plus associated feeder tank).

For better accuracy, the fuel quantity gage curves for this aircraft should be plotted by the owner.

ENGINE FEED SYSTEM

BOOSTER PUMPS

Each engine is fed by a low-pressure booster pump installed in the bottom of the associated feeder tank (Figure 5-7). A switch in each engine feed line turns on the applicable indicator should pump output pressure become low. For additional information, refer to engine feed system controls and indicators.

The pumps are powered by 28 volts DC. The pumps for engines No. 1 and No. 2 are powered by primary bus A. The pump for No. 3 engine is powered by primary bus B.

Primary bus A and primary bus B are non-shedding electrical buses. This means that the pumps will be powered in case load-shed switches for bus C and bus D on the electrical panel are activated.

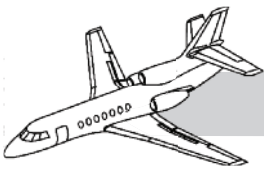

SHUTOFF VALVES

Each feeder tank is equipped with a fuel shutoff valve which is located downstream of the booster pump. When actuated, the valves shut off the supply of fuel to the engines (Figure 5-7).

The shutoff valves are cable-actuated by means of the FIRE PULL handles on the upper instrument panel. The teleforce (push-pull) cable arrangement ensures positive shutoff of the fuel supply to the engines.

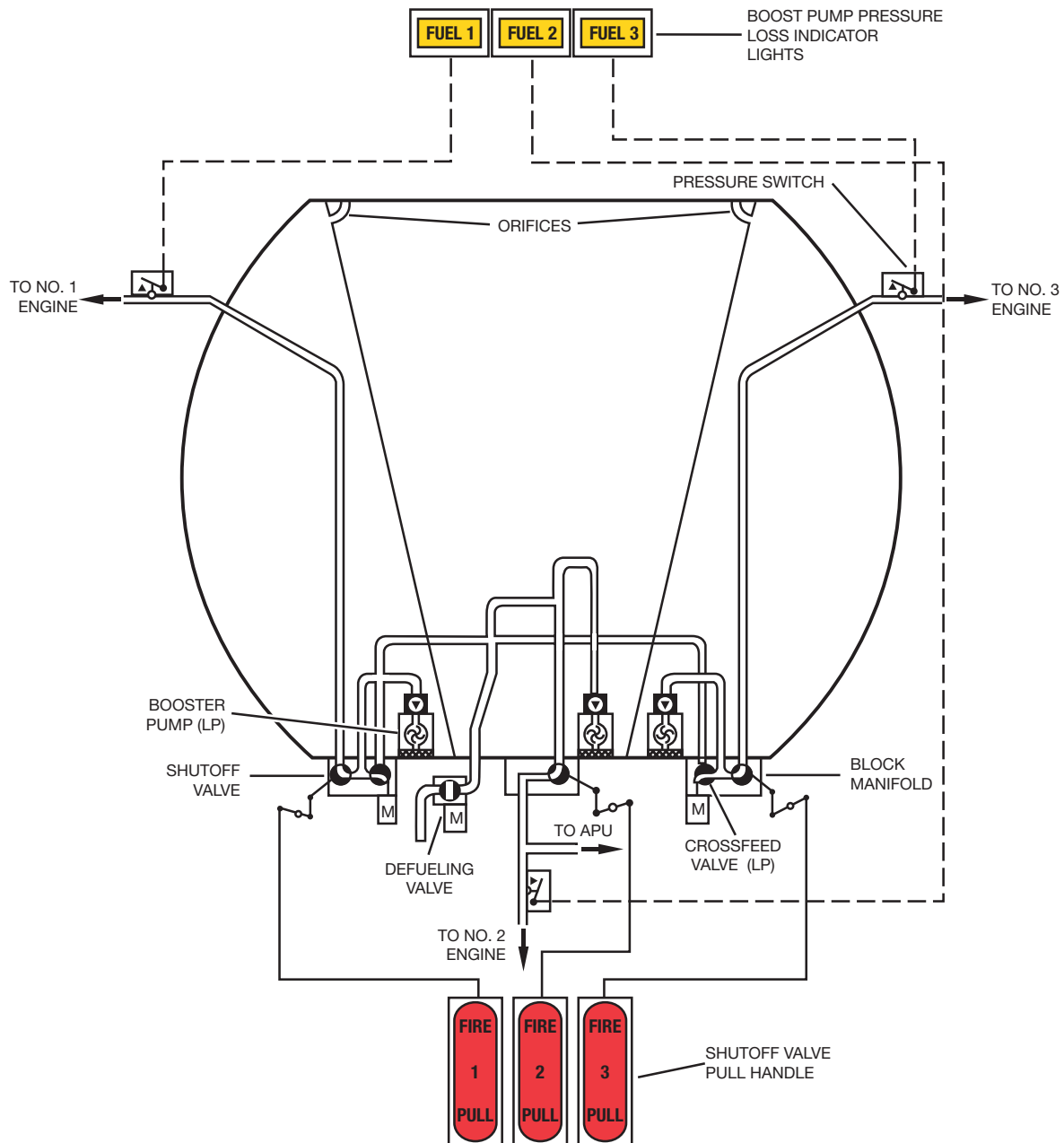
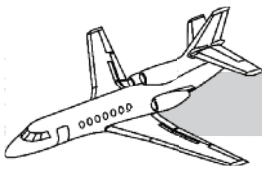

Figure 5-7. Fuel Supply Schematic



ENGINE FEED SYSTEM CONTROLS AND INDICATORS

The booster pumps and crossfeed valves are controlled by switches on the lower portion of the fuel system panel (Figure 5-8). The three booster pump switches are labeled BOOSTER and the two rotary crossfeed valve switches, X FEED.

Fuel pressure switches (see Figure 5-7) downstream of the booster pumps sense the output of the pumps. If low pressure is detected, the FUEL lights on the master warning panel come on. The lights may indicate a malfunctioning booster pump. However, turning on a booster pump will normally extinguish its associated light.

The motor-operated crossfeed valves enable crossfeed of fuel from any feeder tank to any

engine. These normally closed valves are primarily opened for feeding an engine, when its booster pump has failed, using the booster pump of the adjacent feeder tank. They are also opened for certain defueling modes. Each crossfeed valve is opened by rotating its X FEED knob on the overhead panel 90°.

Low fuel level in a feeder tank is indicated by the amber LO FUEL light and/or a low reading on the fuel gage. The light is controlled by float-type switches. The light indicates that the fuel remaining in at least one of the feeder tanks is less than 300 pounds. The warning circuit is delayed (15 seconds) to eliminate false indications caused by waves or fuel movement inside the tanks.

To balance fuel in the feeder tanks, the crossfeed valve to the low tank must be opened and the booster pump on the low tank turned off.

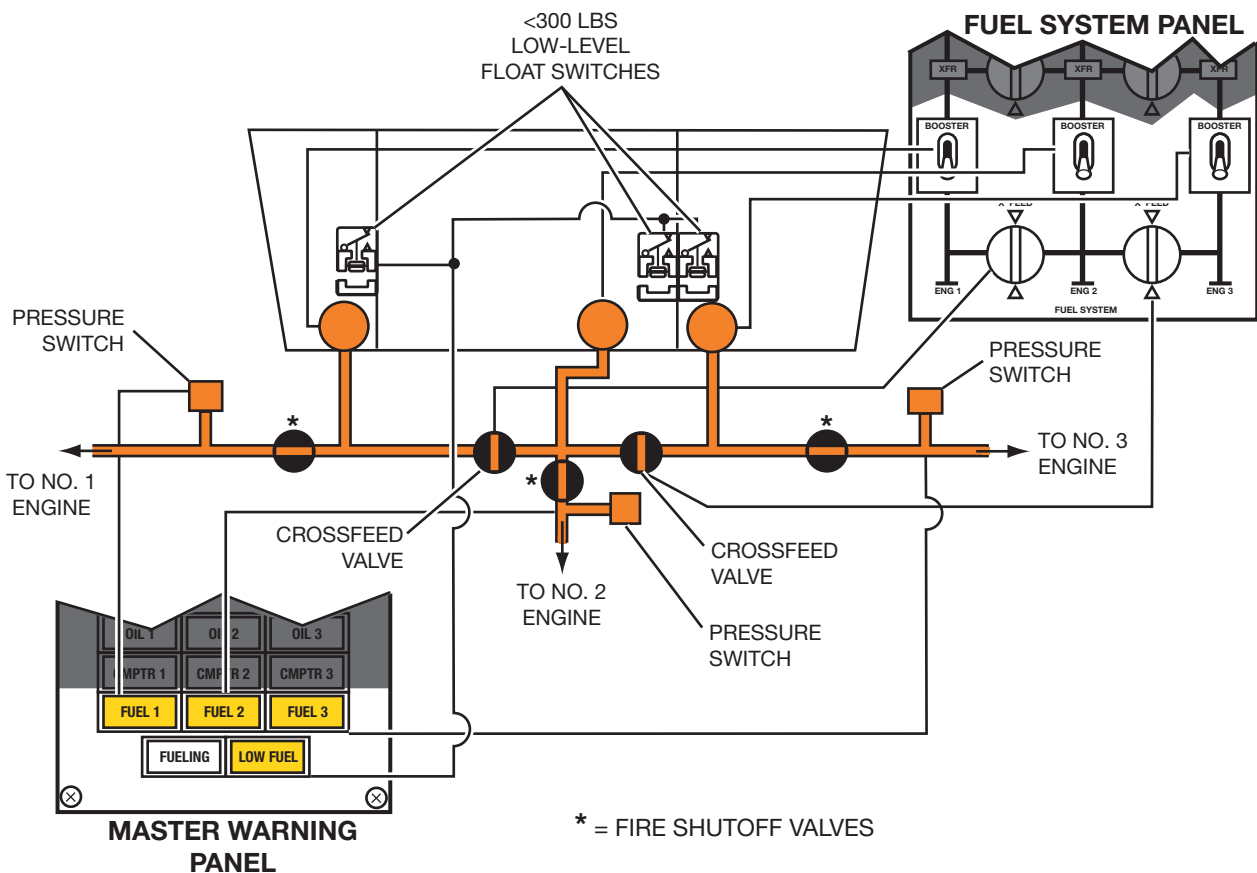
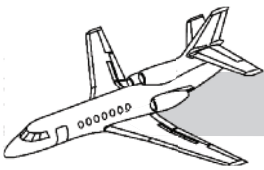

Figure 5-8. Engine Feed System Block Diagram



DRAINING AND REFUELING

SUMP DRAINS

Eight sump drains (Figure 5-9) are mounted under the fuselage at the lowest point of the tanks, including: one on the left wing tank, three on the center wing tank, one on the right wing tank, and one on each of the feeder tanks.

Tank draining is accomplished through three valves. One each is mounted in the two outboard feeder tank manifold blocks for feeder tank draining, and one is mounted in the transfer manifold for draining the wing tanks.

The sump drains provide means of eliminating condensation and other contaminants which settle to the bottom of the tanks. These drains are highly accessible and simple to operate. The drain valve tool is inserted into the PRESS AND TURN receptacle to open the drain (assure tanks are depressurized first).

For maintenance purposes, the tanks can be drained using various combinations of cross-feed and interconnection valve settings with applicable booster pumps turned on.

Defueling can be accomplished through the pressure fueling receptacle by using the fuel truck suction pump, providing the tanks are depressurized first.

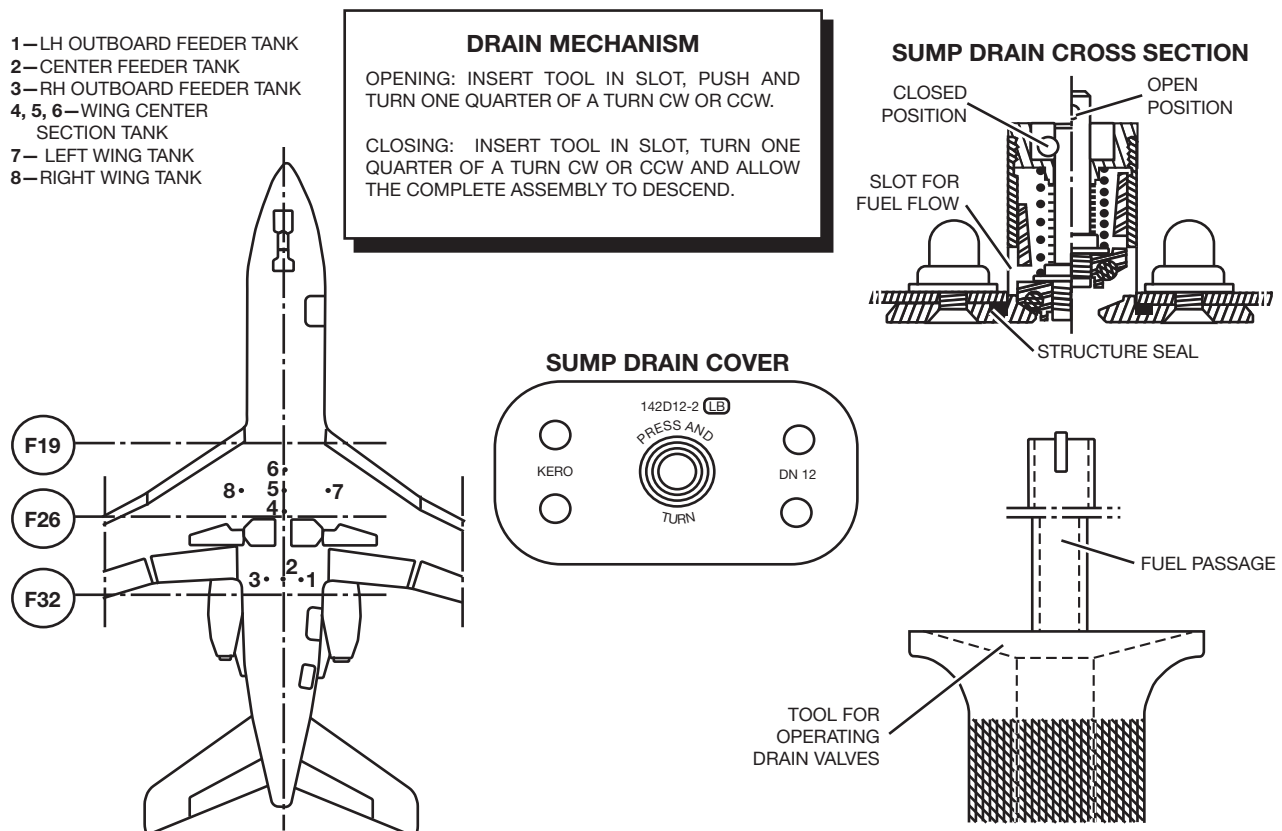
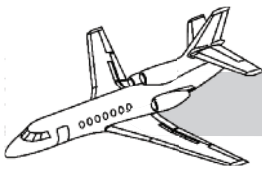

Figure 5-9. Fuel Sump Drain Locations and Operation



REFUELING

PRESSURE FUELING

A pilot may be required to participate in refueling operations. Certain precautions must be taken during refueling to prevent serious damage to the fuel system.

When the fueling door is first opened, the refueling system automatically receives electrical power from the battery bus and the red STOP FUELING light on the fuel panel comes on. This indicates that the tank vents are not open (Figure 5-10).

The amber FUELING light in the cockpit (see Figure 5-3) also illuminates when the fueling door opens (providing main bus power is available).

When the fueling nozzle is connected, it operates the air vent valve control lever. The control lever, in turn, actuates the air vent valve control microswitch.

A few seconds after the microswitch actuates the air vent valves open. When the valves are fully open, the red STOP FUELING light goes out and the green FUELING OK light comes on (Figure 5-11).

Fueling may be continued only after the STOP FUELING light goes out and the FUELING OK light comes on. These lights are PUSH-TO-TEST.

To continue the fueling operation, the fueling valves on the wing tanks are opened by placing the LH WING, CENTER, and RH WING switches to the ON position. In addition, the

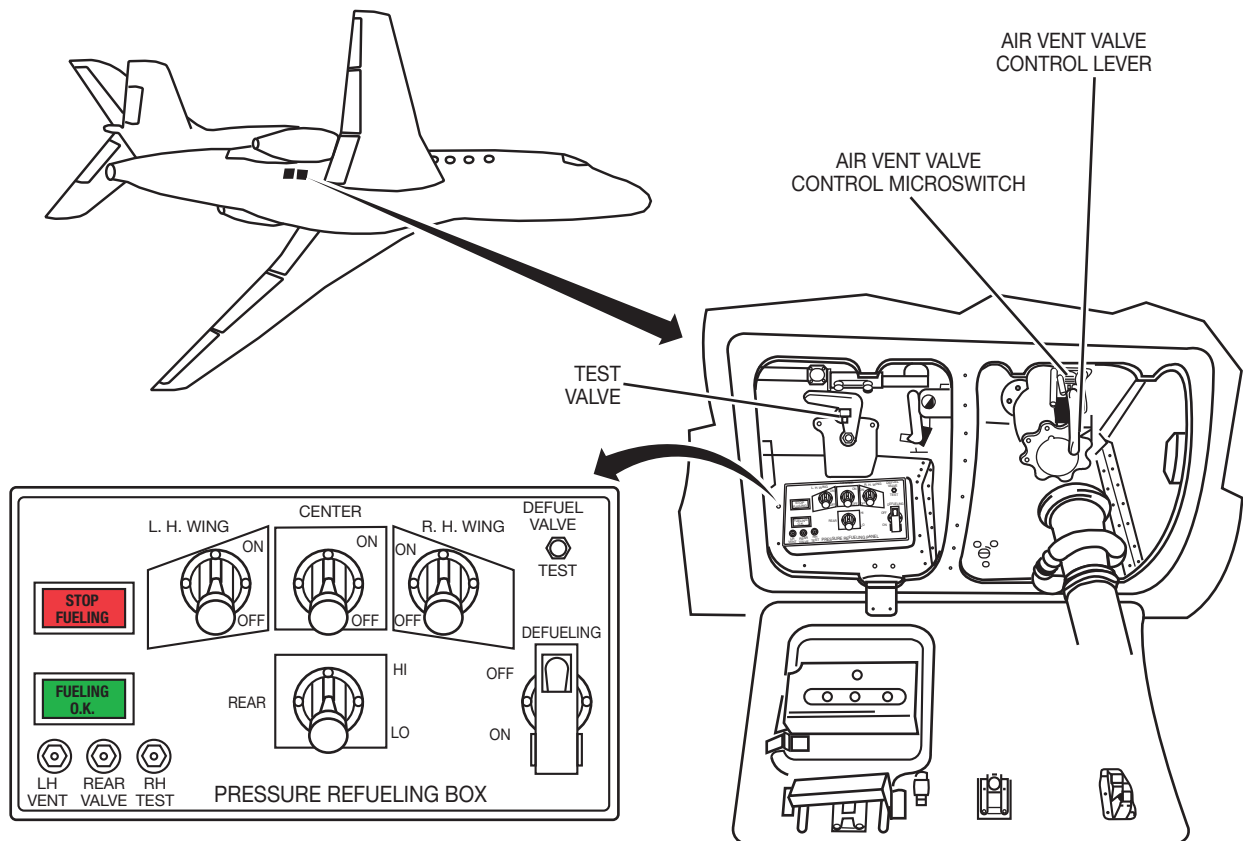

Figure 5-10. Pressure Refueling Door and Panel

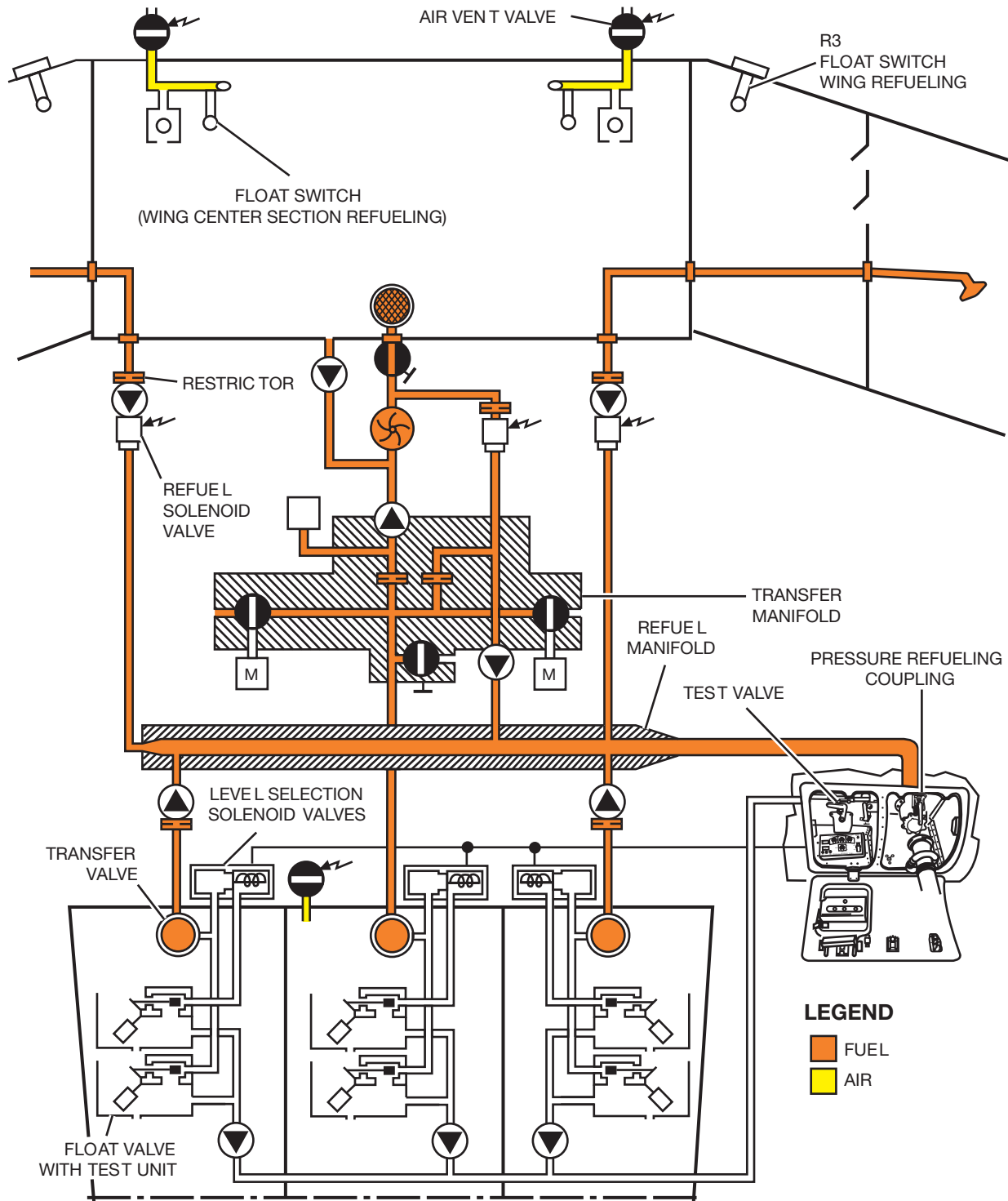
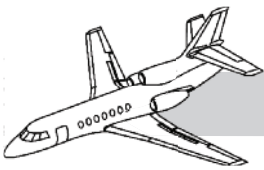
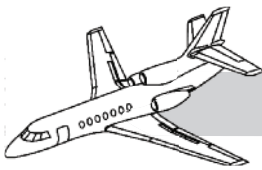

Figure 5-11. Refuel System Schematic



desired level of fuel in the feeder tanks must be selected by placing the switch labeled REAR (see Figure 5-5) to the HI or LO position.

The HI position is used if a fuel load of 15,513 pounds is desired (maximum high-level fueling).

With the switch in the HI position, fueling will automatically stop when fuel in the feeder tanks reaches the maximum level. The maximum level of the left and right feeder tanks is 1,400 pounds. The maximum level of the center feeder tank is 2,460 pounds.

If fueling is accomplished with the switch in the LO position, the left and right feeder tanks will fill to the regulation, or 609-pound, level. The center feeder tank will fill to the low refueling, or 1,750-pound, level. Maximum fuel load for the low refueling level is 13,213 pounds.

One additional check must be made immediately after fueling begins. This check confirms that the individual refueling valves for each tank will close when deenergized. The float valves are also checked during this test.

The test is accomplished during refueling by placing the VALVE TEST handle on the fueling panel to the TEST position. A successful test is indicated when fueling automatically stops after a few seconds.

After a successful test, the test valve is returned to the normal position and refueling is continued until the desired fuel level is reached.

If the red STOP FUELING light comes on at any time during actual fueling, fueling must be immediately discontinued by stopping fuel flow at the fuel truck. In this situation, the light indicates that the maximum fuel level in one or more of the tanks has been exceeded.

When fueling is complete, the fueling procedure is reversed; that is, when the fueling door is closed, the FUELING LIGHT in the cockpit should go out. If the light stays on, it

indicates that the fuel system is at least partially configured for refueling and ground service must complete the fueling procedures prior to takeoff.

The FUELING light may indicate any of the following conditions:

- One or more air vent valves are open.
- The defueling valve is open.
- The refueling door is open.
- The gravity fueling switch is not off.
- The air vent control lever is in the VENT OPEN position.
- Auxiliary bus D switch is off.

GRAVITY FUELING

Gravity fueling is accomplished through the inlet port near the top of each wing upper outboard surface. These ports fuel the outer portion of each wing tank.

The GRAVITY FUELING switch is located on the mechanic flight test panel which is found in the cockpit or opposite the jump seat.

The gravity fueling process below requires that the aircraft's 28-VDC power system be on with C bus and D bus energized and that someone operate the controls in the cockpit.

When the GRAVITY FUELING switch is turned on, a number of results occur. The three air vent valves of the feeder tank and center wing tank open in sequence. The FUELING light illuminates on the master warning panel. The transfer solenoid valves are energized, depending on selection of HI or LO level on the refueling panel. The center wing tank fueling valve is electrically powered open.

Next, the fuel caps on the wings must be opened and the grounding plug connected.

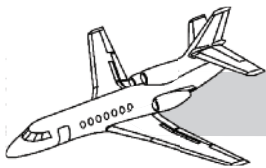

The system consists of:

- One overwing fueling port per wing.
- One GRAVITY FUELING switch located on the test panel above the LH electrical rack.

Do not connect grounding plugs to life line fittings.

Procedure

1. Switch on Aircraft Power (Ground Power Unit)

- To perform complete refueling

2. Gravity fueling switch set to ON

- Opening of vent valves
- Energization of the center wing center section refueling solenoid valve

3. Open door provided access to the refueling panel and set REAR selector to LO.

- Select HI only after aircraft is filled to low level and more fuel is needed.

4. Open wing tank caps and attach grounding plugs.

5. REFUELING OF WING TANKS

6. XFR INTERCOM crossfeed rotary selectors to open position, RH and LH, XFR PUMP switches set to ON.

- Replenishing of feeder tanks through the transfer system
- Refueling of wing center section through the refueling solenoid valve

Interruption of feeder tank and wing center section refueling is automatic and is accomplished in the same way as for pressure refueling.

7. Wing tank replenishing

8. Job close up

- GRAVITY FUELING switch OFF.
- If necessary REAR switch set to LO and closing of refueling door.
- Check that FUELING indicator light on Master warning panel is extinguished.

CAUTION

The grounding wire must not be connected to the life line fittings situated next to the gravity fueling ports.

The desired fueling level must be selected and the fuel quantity selector on the instrument panel set to the REAR position.

The outboard portion of each wing tank is fueled through the gravity fueling inlet ports. The inboard portion of the wing tanks gravity fills. Proper distribution is ensured by the transfer jet pumps.

The side feeder tanks are fueled by the side transfer pumps which draw fuel from the inboard portion of the associated wing tank. As in pressure refueling, the fuel level in the feeder tanks is controlled by the HI/LO switch on the pressure refueling panel.

The center wing tank and center feeder tank are fueled by the side transfer pumps but only after the interconnect valves have been opened. The interconnect valves are opened by using the XFR INTERCOM switches on the fuel panel.

With low level selected, the filling sequence is identical to that of pressure fueling (Figure 5-12). The center feeder tank can be fed up to approximately 600 pounds of fuel, at which point fueling is interrupted until the center wing tank is full. Once the center wing tank has filled, the center feeder tank can be filled to 1,750 pounds.

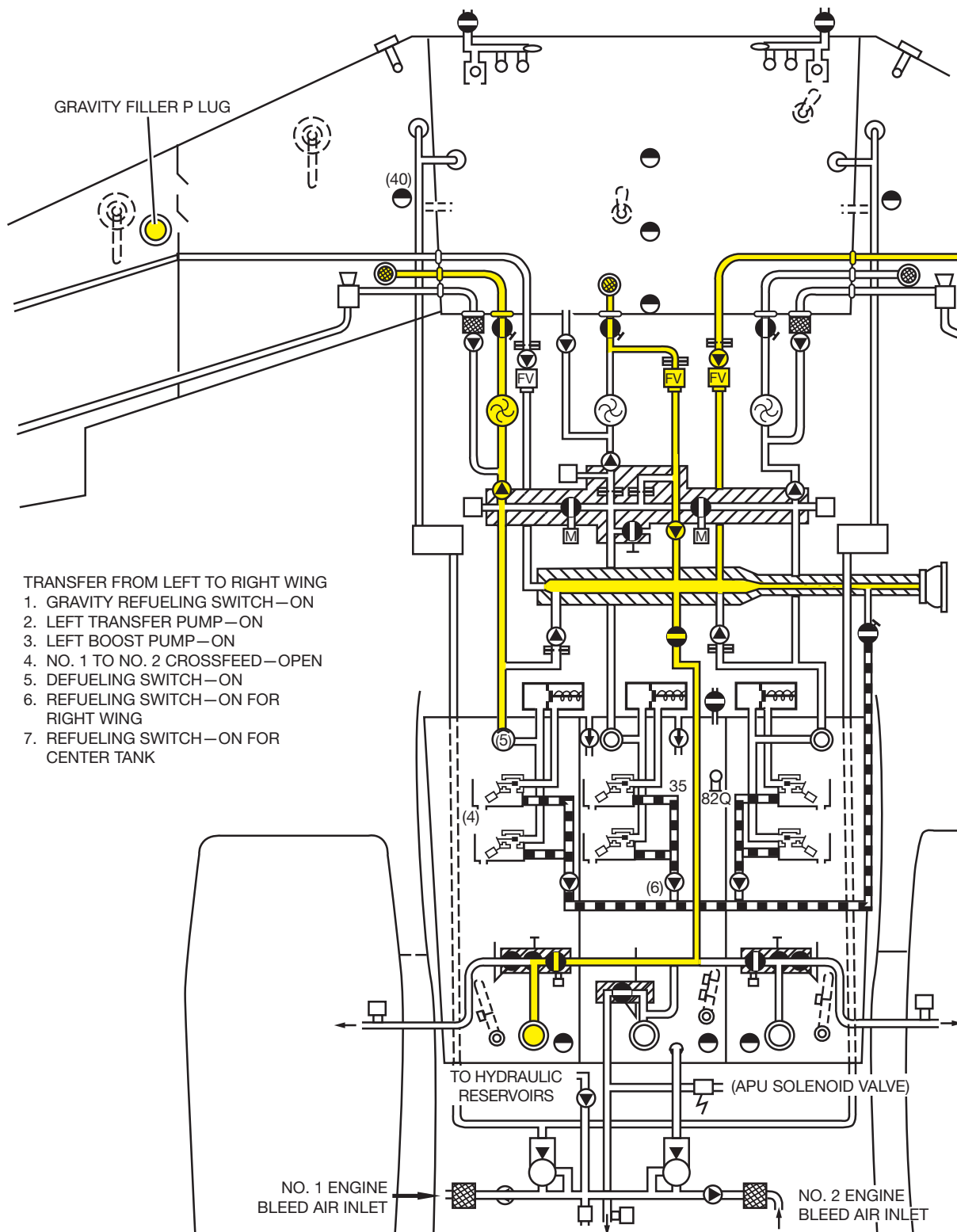
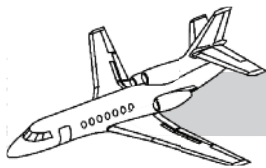
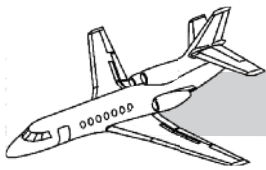

Figure 5-12. Gravity Refueling Schematic



If the high level is selected, all feeder and wing tanks will refuel at the same time. However, if the wing tanks are empty, fueling should begin at the wing tanks to avoid cavitation of the transfer pumps.

DEFUELING

General

The fuel system includes a defueling system (Figure 5-13). This enables defueling through the pressure refueling coupling by using the fuel truck suction pump. This procedure requires 28 VDC on the aircraft.

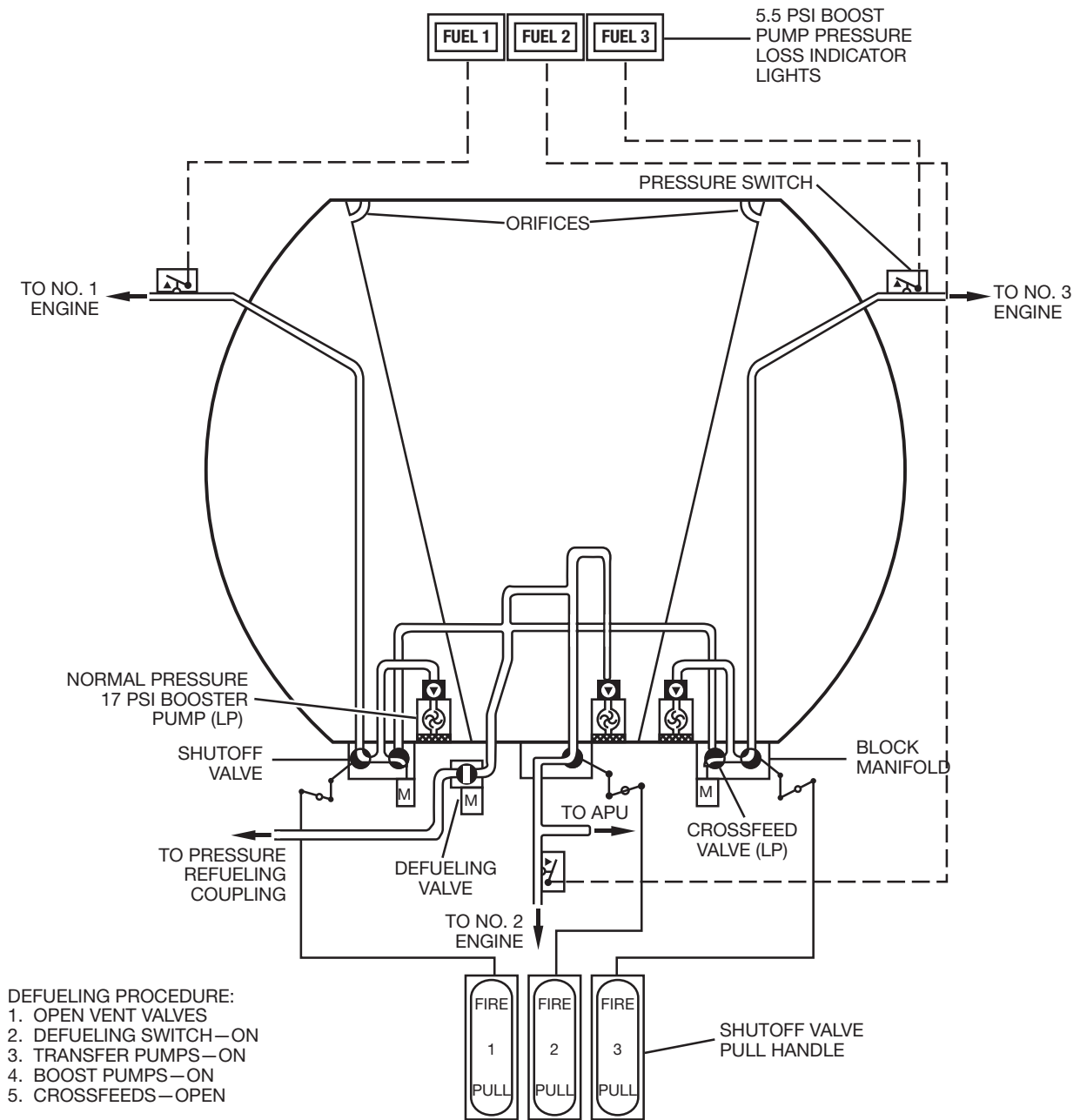
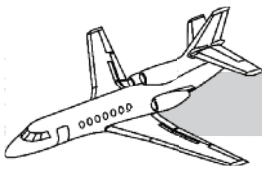

Figure 5-13. Defuel System Schematic



Description

The system includes a solenoid valve controlled by the defueling switch on the refueling panel. This valve connects the pressure refueling system to the LP crossfeed line. Fuel suction from the feeder tanks is performed through LP booster pumps.

To defuel the wing tanks, it is necessary to start the transfer system in order to transfer fuel into the feeder tanks.

NOTE

Fuel tanks must be vented prior to any defuel procedure.

LIMITATIONS

AUTHORIZED FUELS

Table 5-1 lists the types of fuels authorized for use in the Falcon 50.

If the type of fuel used is changed or if fuels are mixed, the appropriate adjustment must be made at the fuel control computer in conformance with instructions in the approved *AIRE-SEARCH TFE 731-3 Maintenance Manual*.

PRESSURE-FUELING LIMITS

The maximum feed pressure for pressure refueling is 50 psi. Minimum pressure is 30 psi. Maximum flow rates are limited to 1,800 pounds per minute.

FUEL ADDITIVES

The following additives are authorized for use in the fuel:

- Anti-icing additive, conforming to AIR 3652 or MIL-I-27686E specifications or equivalent, at a concentration not in excess of 0.15% by volume.
- Anti-icing additive, conforming to MIL-I-27686D/E (JP-4/JP-8) or MIL-I-85470 (JP-5) specifications or equivalent at a concentration not in excess of 0.15% by volume or the following CIS additives at a concentration not in excess of 0.30% by volume.
 - I fluid GOST 8313
 - I-M fluid TU6-10-1458
 - TGF-M fluid TU6-10-1457
 - TGF fluid GOST 17477
- SHELL ASA 3 antistatic additive, or equivalent, in amounts to bring the fuel up to 300 conductivity units providing the quantity added does not exceed one part per million.
- SOHIO Biobor JF biocide additive, or equivalent, is approved for use in the fuel at a concentration not to exceed 270 ppm of elemental boron.

NOTE

Do not pour undiluted additives into an empty tank.

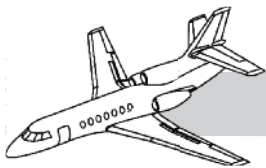
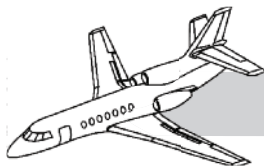

Table 5-1. AUTHORIZED FUELS

DESIGNATION		FREEZING POINT (°C)	GARRETT	SPECIFICATIONS		ADDITIVES		NATO CODE
				EQUIVALENCE (FOR INFO)		ANTI-ICE	ANTI-ICE	
	JET A	-40	EMS 53111	ASTM D 1655 CAN 2-3.23	JET A JET A	*	*	-
	JET A1	-47	EMS 53112	ASTM D 1655 CAN 2-3.23	JET A1 JET A	*	*	-
KEROSENE	JP8	-50	EMS 53112	MIL-T-83133 AIR 3405 C DERD 2494 DERD 2453	JP8 - AVTUR AVTUR/FSII	WITH * WITHOUT WITH	*	F34 F34/F35 F35 F34
	JET B	-50	EMS 53113	ASTM D 1655 CAN 2-3.22	JET B JET B	*	*	-
WIDE CUT TYPE FUEL	JP4	-58	EMS 53113	MIL-T-5624 AIR 3407B DERD 2486 DERD 2454 CAN 2-3.22	JP4 - AVTAG AVTAG/FSII F40	WITH * WITHOUT WITH WITH	*	F40 F40 - F40 F40
HIGH FLASH POINT TYPE FUEL	JP5	-46	EMS 53116	MIL-T-5624 AIR 3407B DERD 2486 DERD 2454 CAN 2-3.22	JP5 - AVTAG AVTAG/FSII -	WITH * WITHOUT WITH *	WITHOUT * WITHOUT WITHOUT *	F44 F43/F44 F43 F44 F43/F44

* Information to be checked with the fuel supplier



QUESTIONS

1. How are the isolation shutoff valves operated during flight?
 - A. The valves can be operated by using switches on the overhead panel.
 - B. The valves can be operated by using a special wrench.
 - C. The valves can be operated by using switches on the refueling panel.
 - D. The valves cannot be operated during flight.
2. How can fuel be transferred from the left wing tank to the right wing tank during flight?
 - A. Fuel can be so transferred by opening the interconnect valve.
 - B. Fuel can be so transferred by opening the crossfeed valves.
 - C. Fuel can be so transferred by turning on the boost pumps.
 - D. Fuel cannot be transferred from the left to right wing.
3. How are an engine's fuel shutoff valves controlled?
 - A. By FIRE PULL handles
 - B. By the HI LO switch
 - C. By boost pump switches
 - D. By solenoid valves
4. What may be indicated when this light comes on?

FUEL 1

 - A. Boost pump failure
 - B. Jet pump failure
 - C. Transfer pump failure
 - D. Fuel gage failure
5. In flight, what is the regulation fuel level in the feeder tank?
 - A. 609 pounds in the left and right feeder tanks and 1,450 pounds in the center feeder tank
 - B. 609 pounds in each feeder tank
 - C. 1,450 pounds in the left and right feeder tanks and 609 pounds in the center feeder tank
 - D. 609 pounds in the left and right feeder tanks and 1,750 pounds in the center feeder tank
6. After landing, when are the fuel booster pumps turned off?
 - A. They are turned off after engine shutdown.
 - B. They are turned off before engine shutdown.
 - C. They are turned off at 30% N₂ rpm.
 - D. The boost pumps are not turned off. This avoids damaging the pumps by thermal expansion of the fuel.
7. What fuel level will be indicated on the gage when this light comes on?

LO FUEL

 - A. 100 pounds
 - B. 200 pounds
 - C. 300 pounds
 - D. 400 pounds

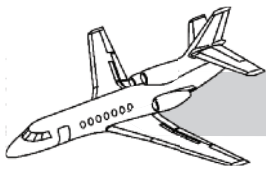

CHAPTER 6

AUXILIARY POWER UNIT

CONTENTS

	Page
INTRODUCTION.....	6-1
GENERAL.....	6-1
AUXILIARY POWER UNIT.....	6-3
Major Sections	6-3
APU Oil System.....	6-4
APU Fuel System.....	6-4
APU Ignition System	6-6
APU Temperature	6-6
APU Control.....	6-6
APU Indication and Warning.....	6-7
APU Protection	6-8
OPERATING PROCEDURES	6-9
APU Starting.....	6-9
Overspeed Protection	6-11
Low Oil Pressure.....	6-11
High EGT.....	6-11
Overcurrent	6-11
Normal Shutdown	6-11
Alternate Shutdown.....	6-11
LIMITATIONS	6-12
QUESTIONS	6-13

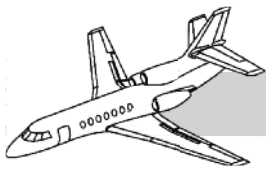

ILLUSTRATIONS

Figure	Title	Page
6-1	General View of a Typical APU	6-2
6-2	APU Installation	6-3
6-3	APU Cutaway View	6-4
6-4	Oil System Schematic	6-5
6-5	High Pressure Fuel System Schematic.....	6-5
6-6	APU Control Panels	6-7
6-7	APU Control Panel (Expanded Version)	6-7
6-8	Master Warning Panel	6-8
6-9	ECU Schematic	6-9
6-10	APU Starting Sequence.....	6-10

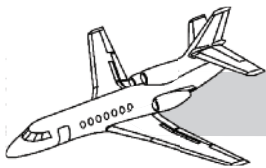

CHAPTER 6

AUXILIARY POWER UNIT

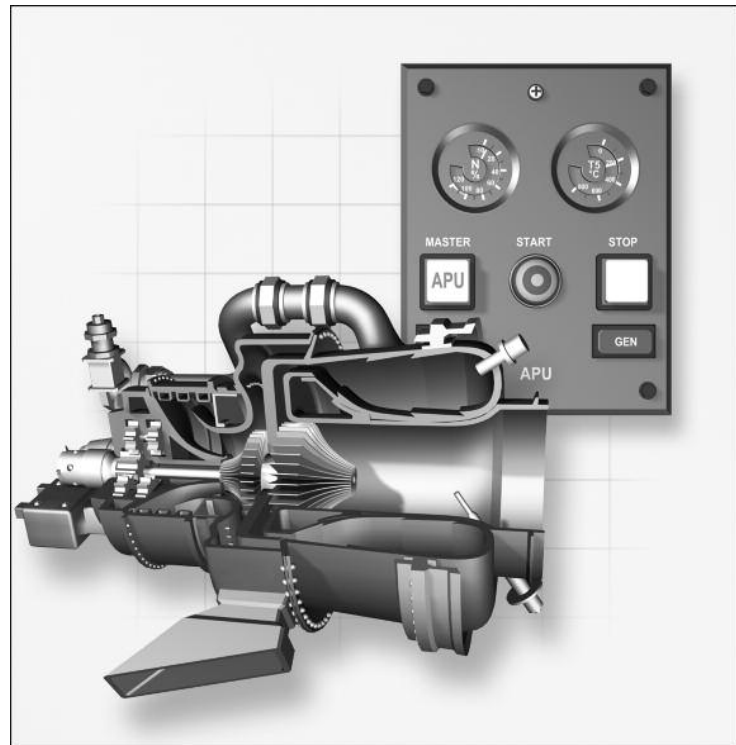

INTRODUCTION

This chapter deals with the onboard auxiliary power unit installed in the Falcon 50.

GENERAL

The auxiliary power unit (APU) (Figure 6-1) installed in the Falcon 50 aircraft is a self-contained gas turbine engine manufactured by the Garrett Turbine Engine company and is designated GTCP36-100A.

The APU is certificated for ground operation only. Power connections are wired through the landing gear proximity switch

system to prevent in-flight starting and to produce automatic shutdown if a takeoff is made with the APU operating.

The APU is installed in a stainless-steel fire-proof container in the rear compartment (Figure 6-2), aft of the rear pressure bulkhead. It is provided with independent fire detection and extinguishing systems.

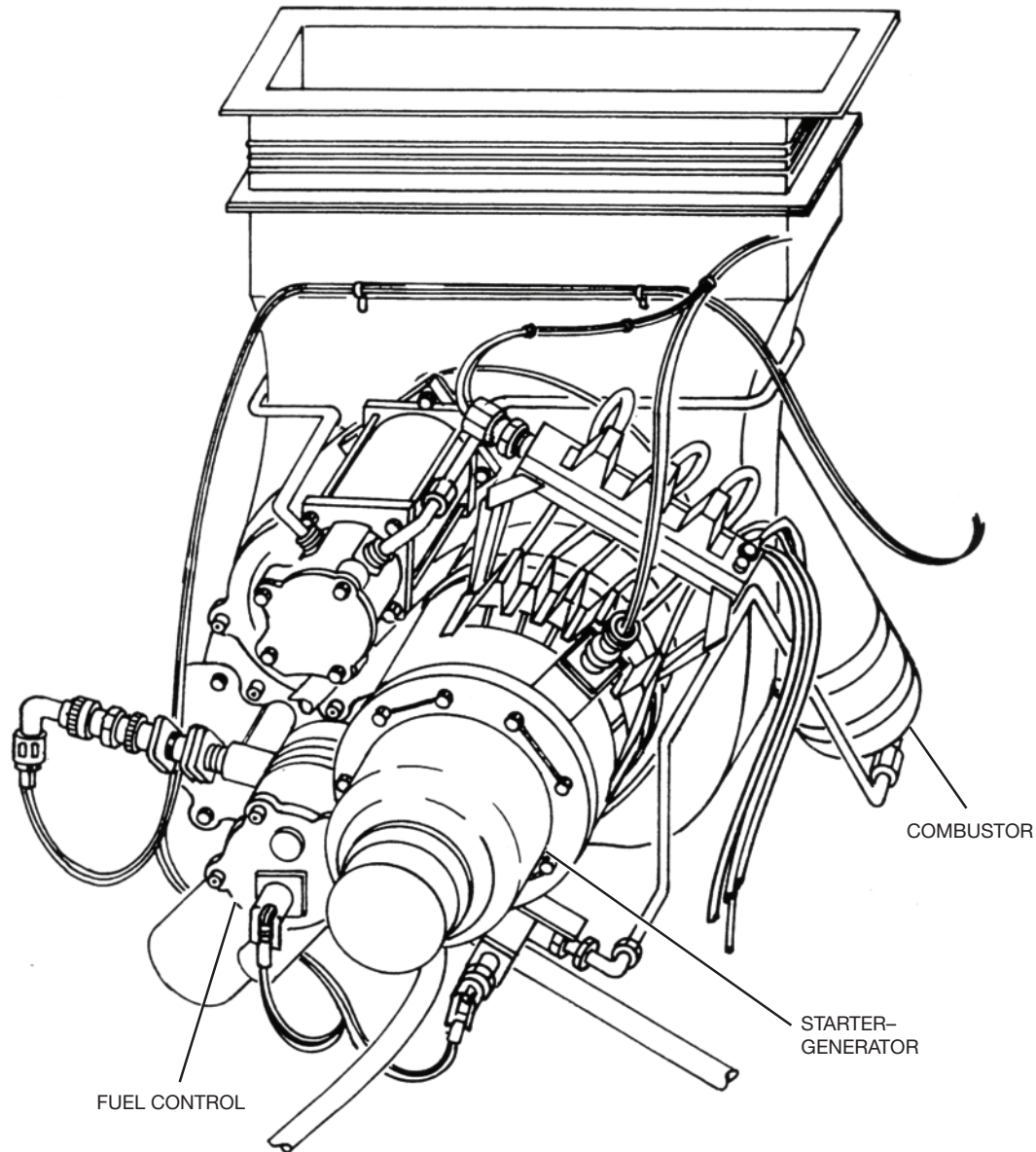
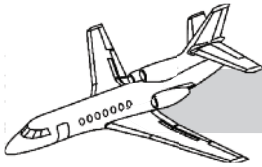

Figure 6-1. General View of a Typical APU

The primary functions of the APU are to:

- Drive a DC starter-generator capable of supplying the aircraft's DC distribution system with 300 amps at 28.5 volts in continuous operation
- Partially charge the aircraft's batteries
- Assist in engine starting, resulting in increased battery life and reduced starting time

- Provide a supply of hot compressed bleed air to the aircraft's environmental systems for ground heating and cooling

The APU is independent of all aircraft systems except for a DC power supply for starting and a fuel supply from the aircraft's fuel system.

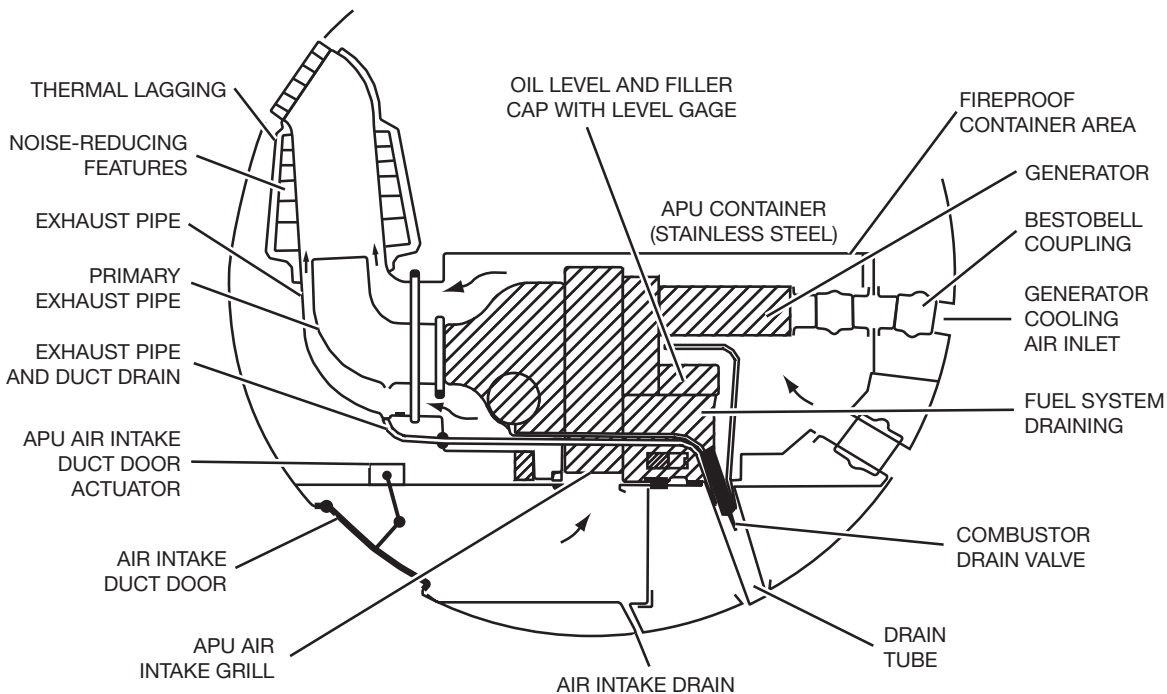
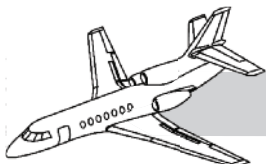

Figure 6-2. APU Installation

AUXILIARY POWER UNIT

MAJOR SECTIONS

The APU consists of six major sections as shown in Figure 6-3:

- Air Intake
- Compressor
- Combustor
- Turbine
- Exhaust
- Accessory gearbox

Air Intake

The air intake is located on the lower right side of the rear fuselage. The intake includes an electrically operated flush door.

Compressor

The compressor is a single-stage centrifugal type, which draws air in through the air intake, compresses the air, and directs the airflow for combustion and bleed-air extraction, when required.

Combustor

The combustor section consists of a single combustion chamber. Fuel is supplied from the No. 2 engine fuel feed line downstream of the low-pressure (LP) fuel pump to the single-stage APU fuel pump. From the APU fuel pump the fuel is metered by a torque motor fuel controller, which sends the proper amount of fuel to a single atomizer nozzle in the combustion chamber. The fuel-air mixture is ignited by a single high-energy igniter plug.

Turbine

A single-stage radial turbine is rigidly mounted to the compressor rotor shaft. The turbine is designed to extract almost all the total energy

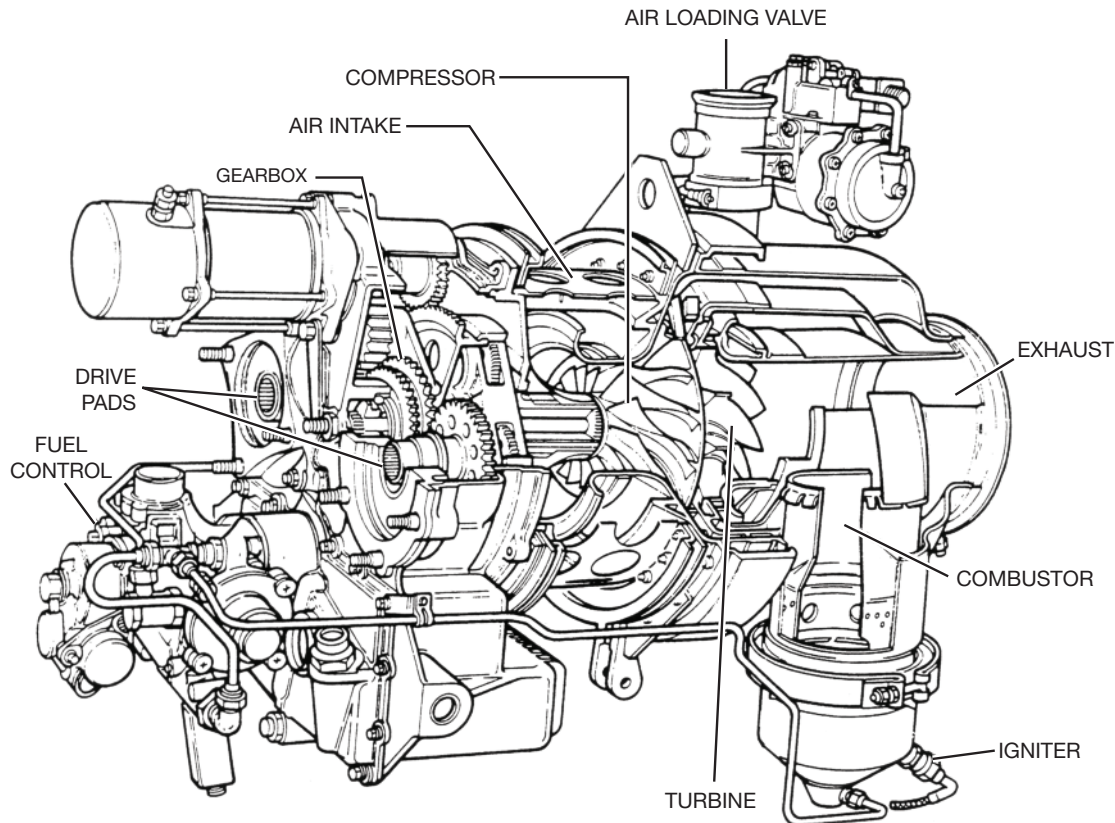
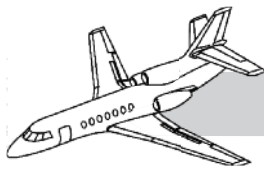
**Figure 6-3. APU Cutaway View**

from the expanding combustion gases. The major portion of the energy is used to drive the compressor, the gearbox, and some APU and aircraft accessories.

Exhaust

A short exhaust pipe, attached to the APU, directs the spent gases to the atmosphere through an exhaust duct on the right side of the rear fuselage. The exhaust velocity produces a jet pump action to induce fumes from the APU enclosure.

Accessory Gearbox

A simple planetary-type gearbox forms an integral part of the APU. The gearbox is designed to convert the high turbine speed to the values required for the APU accessories which include:

- APU lubricating pump
- APU fuel controller and fuel pump

- DC starter-generator
- RPM monopole

APU OIL SYSTEM

The APU oil system (Figure 6-4) is a self-contained, fully automatic system which provides lubrication for the engine bearings and the accessory gearbox.

APU FUEL SYSTEM

The APU fuel system (Figure 6-5) is a high-pressure, fully automatic system with no operator controls or adjustments. The function of the fuel system is to supply varying amounts of fuel to the atomizer so that the power developed by the APU is equal to the power required and thereby maintain a constant rpm throughout all APU load variations.

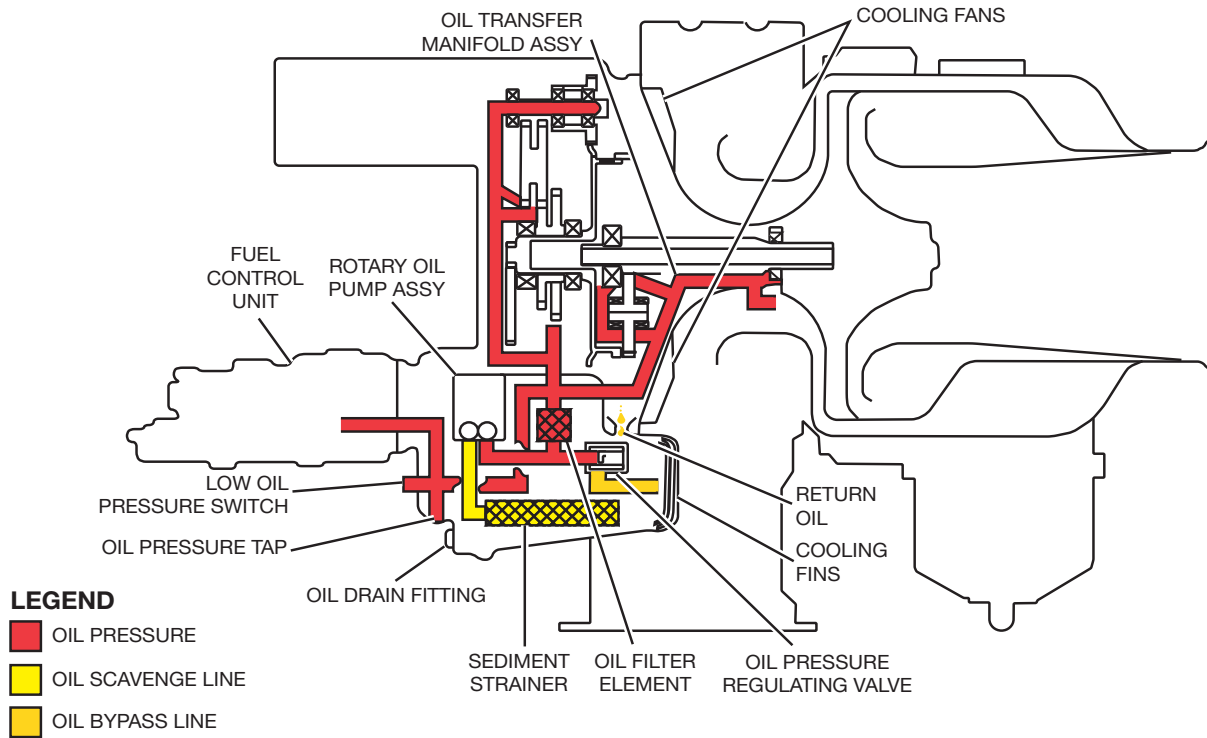
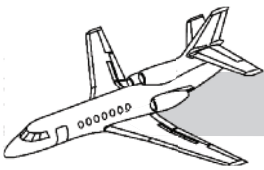

Figure 6-4. Oil System Schematic

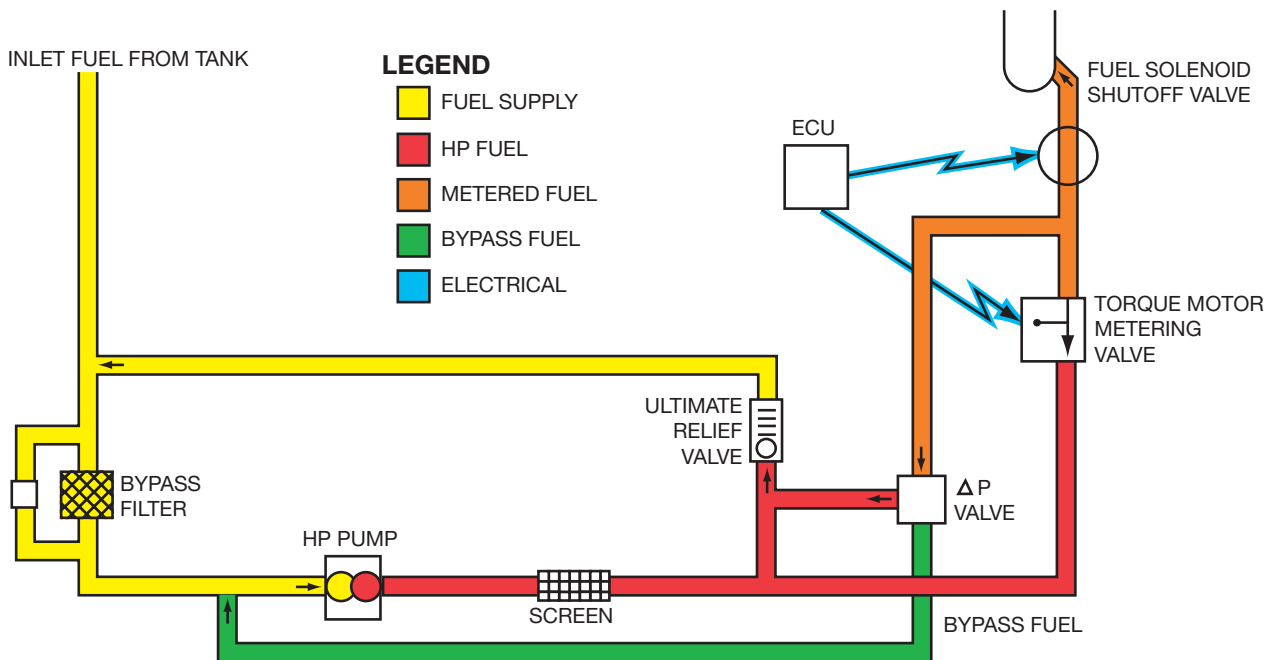
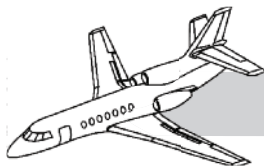

Figure 6-5. High Pressure Fuel System Schematic



APU IGNITION SYSTEM

A fully automatic ignition system provides high-voltage electricity to the single igniter plug in the combustion chamber.

The ignition is controlled by an electronic control unit (ECU) which turns on the ignition at 10% rpm and turns it off at 95% rpm.

APU TEMPERATURE

APU combustion temperature (T_5) is sensed by a single thermocouple in the APU exhaust. Thermocouple signals are sent to the left scale of a dual-scale gage located on the APU control panel in the cockpit.

APU CONTROL

The APU is controlled from a panel located on the right-hand side console (Figures 6-6 and 6-7). The APU control panel contains five switches labeled START, GEN, BLEED, STOP, and MASTER. The functions of these switches are discussed below in order of priority.

MASTER Switchlight

The APU MASTER switch is a two-position ON-OFF pushbutton switchlight. When pushed on, this switch will perform the following:

- Open air intake door.
- Power ECU.
- Open fuel shutoff valve.
- Power indicators.

GEN Switchlight

The APU GENERator switchlight is a two-position ON-OFF switch. When pushed on, this switch will arm the start sequence.

START Switchlight

The START switch, when pushed, will perform the following:

- Begin cranking cycle
- 10%—ignition + fuel
- EGT rises suddenly at 15%, peaking about 30% (maximum 690° C).
- Start cycle terminates at 60%—*Oil light must be out.*

Automatic Protection

- Overspeed of 110%
- High EGT >732° C
- Low oil pressure (<31 psi for >10 seconds at 95% >rpm)
- 4 amps overcurrent in control circuit
- Fire (shuts fuel off/closes APU door)
- Loss of thermocouple
- Loss of monopole
- Overvoltage (mod 682)
- Overcurrent (mod 682)
- Main gear proximity switches

BLEED Switchlight

The BLEED switchlight is a two-position ON-OFF switch. When pushed on, it will perform the following functions:

- Turn on the green switchlight.
- Initiate opening of the APU air loading valve (bleed valve), provided that the APU rpm is at least 95%.

NOTE

Garrett recommends a 2 minute stabilization period prior to selecting bleed air on.

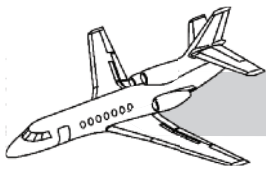

GARRETT-DASSAULT PANEL



GARRETT OR SOLAR-PATS PANEL

Figure 6-6. APU Control Panels

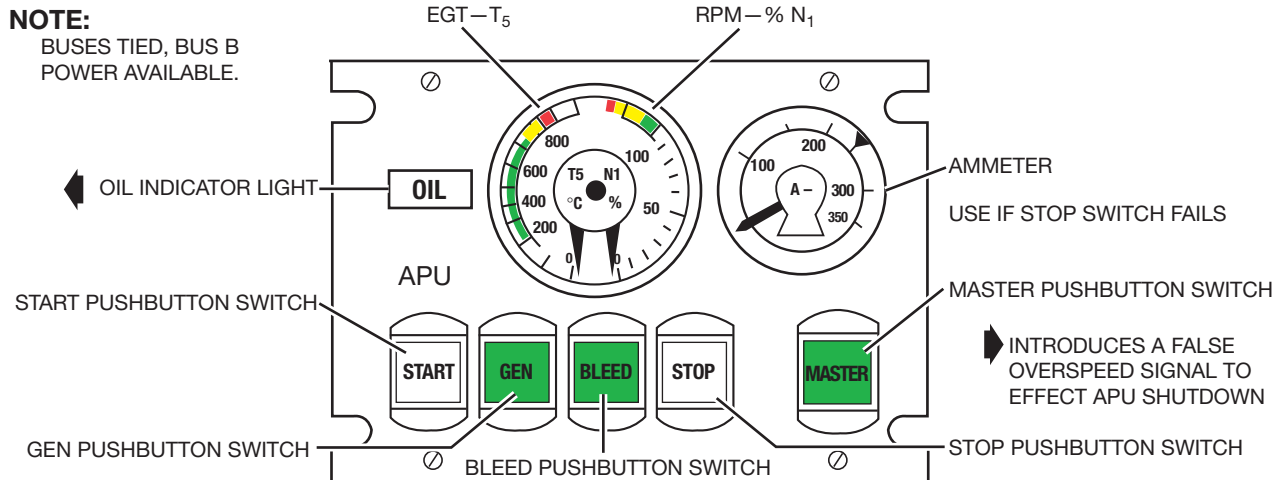

Figure 6-7. APU Control Panel (Expanded Version)

STOP Switchlight

The APU STOP switch is a two-position ON-OFF switch. When pushed, it will initiate a simulated overspeed signal in the ECU that will automatically close the APU fuel solenoid shutoff valve and the airloading valve causing the APU to flame out.

APU INDICATION AND WARNING

APU indication consists of a dual-scale, dual-needle gage located on the APU control panel (Figure 6-6).

The right scale and needle provide indication of APU rpm in percentage of design 100% rpm. Input rpm signals are provided by the monopole mounted on the accessory gearbox. In addition to providing for rpm indication, the monopole also supplies rpm signals to the ECU to permit the ECU to control the following:

- Starting and ignition cycles
- Generator operation
- APU bleed air
- Automatic APU overspeed shutdown

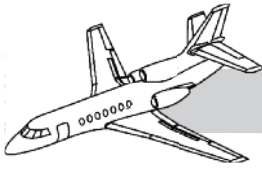

The left scale and needle of the gage provide APU temperature (T_5) indication. The scale is calibrated in degrees Celsius identified as exhaust gas temperature (EGT). EGT indication is supplied from the single thermocouple in the APU exhaust duct. As well as providing input signals to the EGT gage, the thermocouple also supplies a signal to the ECU to provide for automatic exhaust gas temperature limiting and automatic overtemperature APU shutdown.

The warning systems provided for the APU consist of an amber, low oil pressure light labeled OIL located on the APU control panel (see Figure 6-6). This light is controlled (through the ECU) by a pressure switch sensing APU oil pump pressure. The light will come on if the APU oil pressure drops to an abnormal value for 10 seconds or more when the APU rpm is 95% or more.

A light labeled APU BLEED is located on the master warning panel (Figure 6-8). The APU BLEED light will come on if the APU air loading valve (bleed valve) is not fully closed when a main engine throttle lever is advanced to 54° or more, if the control bleed switch is turned off, or if the APU is commanded off.

APU PROTECTION

The electronic control unit (ECU) (Figure 6-9) monitors all APU operations and provides for an automatic APU shutdown by closing the APU fuel solenoid shutoff valve and the APU air loading valve (bleed valve) if any one of the following conditions occurs:

- APU overspeed or loss of rpm input signals to the ECU
- EGT high or loss of EGT input signals to the ECU
- APU oil pressure low for 10 seconds or more when APU rpm is 95% or more
- ECU detection of overcurrent in the APU control circuitry
- APU overheat or fire

NOTE

Following an automatic shutdown, the ECU fault logic is latched in. The fault logic can be reset by momentarily pushing the master switch off and back on.

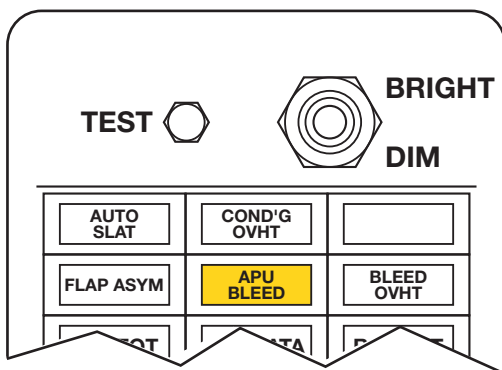
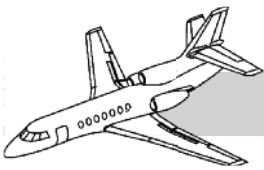

Figure 6-8. Master Warning Panel



OPERATING PROCEDURES

APU STARTING

NOTE

The APU should not be started until the cockpit safety check and the exterior check are both completed and all discrepancies corrected.

The APU may be started by using the aircraft's batteries or a ground power unit (GPU). Battery power and/or external power distribution must be controlled as outlined in Chapter 2, "Electrical Power Systems."

The crewmember pushes the APU master switch (Figure 6-10) and checks to see that the green switchlight comes on. This action performs the following:

- Opens the APU air inlet door
- Opens the airframe fuel shutoff valve

When the APU air inlet door reaches the fully open position, it will close a microswitch to supply power to the ECU.

The ECU, in turn, will supply power to the:

- RPM indicator
- EGT indicator

The crewmember pushes the GENERATOR switch and determines that the green switchlight

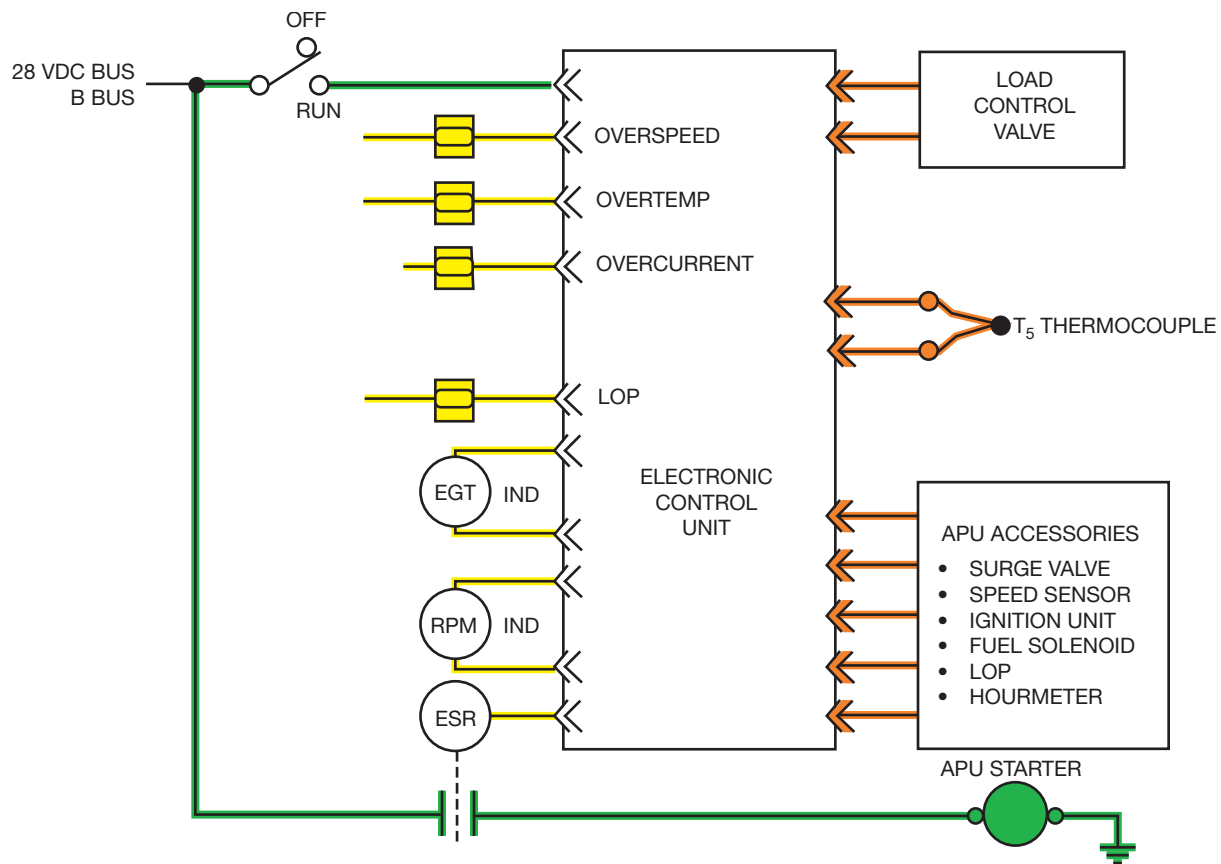

Figure 6-9. ECU Schematic

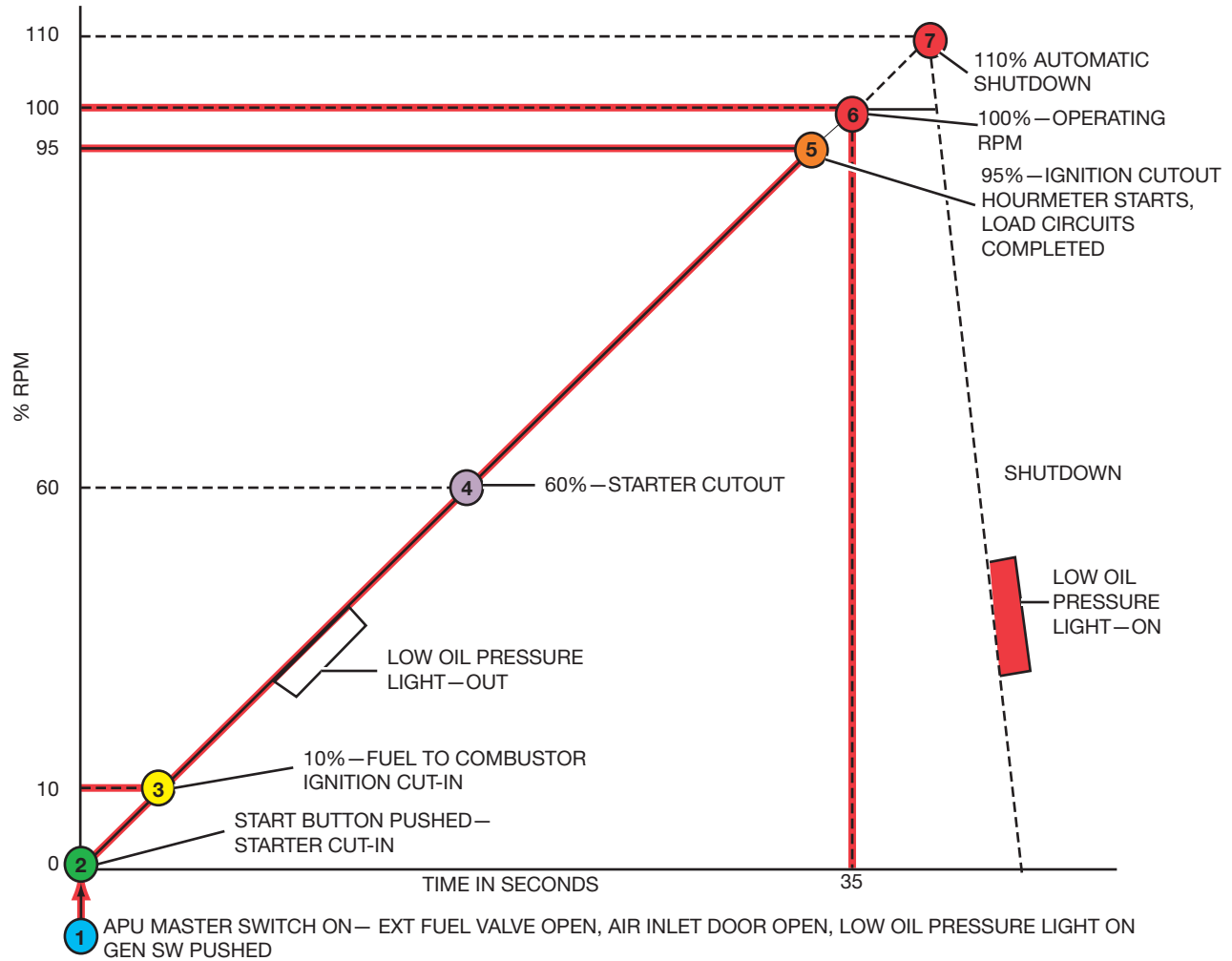
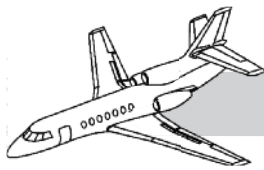

Figure 6-10. APU Starting Sequence

comes on. This action completes the generator excitation circuits.

The crewmember pushes the START switch and observes that the green light comes on. This action completes the automatic start sequence. The starter-generator rotates the engine.

At 10% rpm, the following will occur:

- The fuel solenoid valve opens and supplies fuel to the atomizer.
- The ignition is turned on and combustion should begin.

- The RPM and EGT indicators rise. Monitor EGT and rpm. EGT should rise suddenly at 15% rpm, peak at about 30%, and continue constant (or decrease slightly) until 100% rpm.
- RPM will increase at an almost constant rate to 65%, then accelerate to 100%. (Starting time is about 35 seconds.) If EGT indicates low or not at all, shut down the APU by pushing the STOP switch.

At some point in the early part of the start cycle, the amber OIL light will go out. It must be out by 60% rpm.

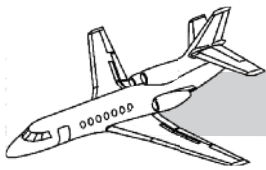

At 60% rpm, an ECU output signal will terminate the cranking cycle.

At 95% rpm plus four seconds, the following will occur:

- Ignition will be terminated.
- The hourmeter will operate.
- The generator will supply the bus.
- Bleed air is available for selection.
- Low oil pressure shutdown is armed.

At $101 \pm 1\%$, the APU will stabilize and rpm will be controlled by the fuel control unit.

OVERSPEED PROTECTION

If the APU control system allows rpm to increase to 110%, or if the monopole fails, the ECU will perform the following:

- The APU fuel valve will close.
- As rpm drops, the oil light will come on.

LOW OIL PRESSURE

If, at any time during APU operation when rpm is 95% or more and the oil pressure drops to a low value and remains there for 10 seconds, the ECU will close the fuel solenoid valve and flameout the APU.

HIGH EGT

If the EGT reaches 732°C ($1,356^{\circ}\text{F}$) or if the thermocouple fails, the ECU will close the fuel solenoid valve and flameout the APU.

OVERCURRENT

If, at any time during APU operation, any electrical unit of the APU demands excessive current, the ECU will close the fuel solenoid valve and flameout the APU.

NORMAL SHUTDOWN

The APU may be shut down at any time during the start cycle or when in any operating mode by pushing the STOP switch. The ECU will transmit a simulated overspeed signal that will close the fuel solenoid valve and the air-loading valve. The rpm gage will show a decrease and the EGT will drop toward 200°C . When rpm drops to between 40 and 30%, the oil light will come on. When the rpm gage shows 0%, push the MASTER switch. The switchlight will go out. This action will initiate the following:

- The APU air inlet door will close.
- The oil light will go out.
- The rpm and EGT gages will drop below zero.
- Power will be removed from the ECU.

NOTE

Even though the rpm gage will show a slight increase when the STOP switch is pushed, an actual APU overspeed does not occur. The indication simply results because of the false signal from the 114% ECU test device.

ALTERNATE SHUTDOWN

If the APU fails to shut down when the STOP switch is pushed, it may be shut down by pushing the MASTER switch. The switch-

light will go out and the following will occur:

- The airframe fuel shutoff valve will close.
- In one minute, the APU air inlet door will close.
- The oil light will *not* come on.
- Power will be removed from the ECU.
- EGT and rpm will drop below zero.

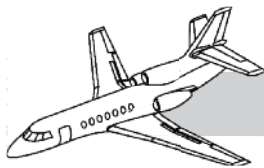

NOTE

If the engine generator switches and the battery switches are all turned off while the APU is running, the APU fuel solenoid valve will close and the APU will flame out.

CAUTION

The alternate method for shutting down the APU should be used only if the normal method fails because as the APU air inlet door closes while the APU is spooling down, low pressure in the inlet duct may cause duct damage.

LIMITATIONS

The limitations outlined in the *Approved Flight Manual (AFM)* and pertaining to the APU must be complied with in any type of operation.

- The APU is certificated for ground use only.
- The APU is temperature limited to 732°.
- The maximum rpm is 110%.
- Engine or airframe anti-icing tests should not be carried out when the APU bleed is on.

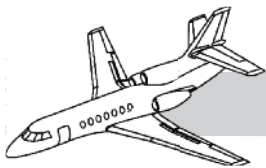

QUESTIONS

1. The GTCP36-100A APU consists of:
 - A. One axial compressor and a two-stage turbine
 - B. A single-stage compressor and a free turbine
 - C. One centrifugal compressor and one radial turbine
 - D. A centrifugal compressor and axial turbine
2. Fumes are extracted from the APU container by:
 - A. Ram air pressure
 - B. Exhaust jet pump action
 - C. A fan driven by the starter-generator
 - D. A bleed-air driven ground blower
3. When the APU master switch is pushed and the green light is on, it will perform the following functions:
 - A. Engage the starter and arm the ignition.
 - B. Turn on the oil light and engage the starter.
 - C. Open the exhaust outlet door.
 - D. Open the airframe fuel valve and the air inlet door.
4. When starting the APU, the GENERator switchlight must be pushed on:
 - A. Before pushing the START switch
 - B. When rpm exceeds 95%
 - C. After the rpm gage shows starter engaged
 - D. When the APU EGT stabilizes
5. Automatic APU shutdown will occur if:
 - A. Combustion does not occur within 10 seconds after pushing the START switch.
 - B. The OIL light remains on for 10 seconds after rpm reaches 95%.
 - C. RPM exceeds 101.5%.
 - D. EGT hangs at 25% rpm.
6. If the APU bleed light comes on while the APU is operating, it indicates that:
 - A. APU bleed air temperature is too high.
 - B. Bleed air pressure is too high.
 - C. The APU air loading (bleed) valve is closed.
 - D. One main engine throttle is advanced to 54° or more and the APU bleed valve did not close fully.
7. At about 60% rpm, the ECU will perform the following functions:
 - A. Open the airloading (bleed) valve.
 - B. Allow the starter-generator to supply the DC system.
 - C. Terminate the crank cycle.
 - D. Terminate ignition.
8. According to the “Limitations” section of the *AFM*, the maximum EGT is:
 - A. 350°C at 100% rpm
 - B. 500°C for 5 seconds
 - C. 732°C
 - D. 690°C all conditions
9. If an automatic shutdown occurs, the APU logic system can be reset by:
 - A. Pushing and releasing the STOP switch when power is on
 - B. A reset switch on the ECU
 - C. Momentarily pushing the master switch to off and back on
 - D. Pushing and holding the GENERator switch and the start switch until rpm exceeds 10%

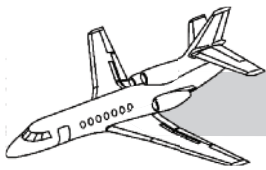

CHAPTER 7 POWERPLANT

CONTENTS

	Page
INTRODUCTION.....	7-1
GENERAL.....	7-1
ENGINES.....	7-2
Major Sections.....	7-2
Engine Oil System.....	7-4
Engine Fuel System.....	7-6
Engine Ignition System.....	7-9
Engine Power Control.....	7-11
Engine Instrumentation.....	7-11
No. 2 Engine Failure Monitor.....	7-12
THRUST REVERSER.....	7-13
General.....	7-13
Control and Indication.....	7-14
Emergency Mode.....	7-14
LIMITATIONS.....	7-14
Engine Thrust Ratings (Uninstalled Sea Level ISA).....	7-14
Engine Rotor Speed.....	7-15
Engine Interstage Turbine Temperature.....	7-15
Starter.....	7-15
Fuel Computers.....	7-15
Fuels.....	7-15

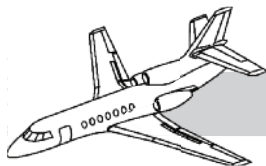

FALCON 50 PILOT TRAINING MANUAL

Oil Temperature	7-15
Instrument Color Codes	7-15
QUESTIONS	7-16

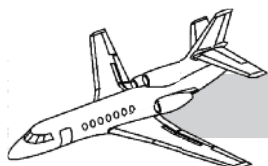

ILLUSTRATIONS

Figure	Title	Page
7-1	Main Engines	7-2
7-2	Engine Cutaway	7-2
7-3	Engine Oil System Schematic	7-4
7-4	Engine Oil Temperature and Pressure Monitoring System	7-5
7-5	Engine Fuel Schematic	7-6
7-6	Fuel Computer Control Schematic	7-7
7-7	Computer Switches and Failure Indicator Lights	7-8
7-8	Ignition System	7-9
7-9	Ignition Switches	7-10
7-10	Engine Instrumentation	7-11
7-11	LP and HP RPM	7-12
7-12	Engine ITT Indicator	7-12
7-13	No. 2 Engine Failure Monitor.....	7-13
7-14	Thrust Reverser.....	7-13
7-15	Thrust Reverser Controls and Indicators.....	7-14

TABLE

Table	Title	Page
7-1	Ignition Sequence—Immediate-Action Items	7-10

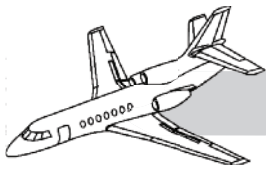

CHAPTER 7

POWERPLANT

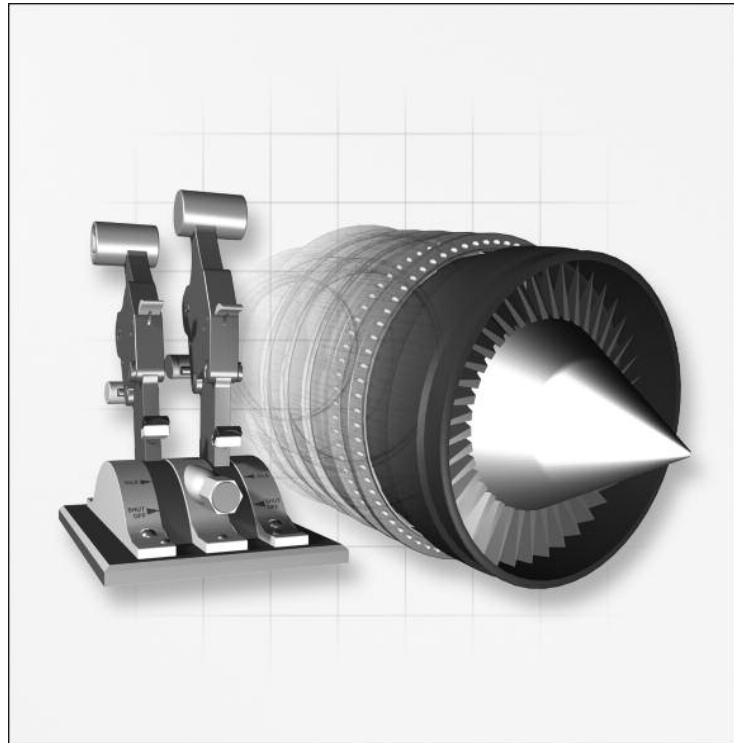

INTRODUCTION

This chapter deals with the powerplant of the Falcon 50.

The information contained in this chapter is a result of research of various manuals and publications supplied by the manufacturers. All values such as for pressures, temperatures, rpm, and power are used for their illustrative meanings only. Actual values must be obtained from the approved Flight Manual. Information in this chapter must not be construed as superseding the information issued by or on behalf of the manufacturers or the Federal Aviation Administration.

GENERAL

The Falcon 50 is powered by three turbine engines, as shown in Figure 7-1. The No. 1 and No. 3 engines are pylon-mounted on the left and right sides of the rear fuselage. The No. 2 engine is mounted internally in the fuselage tail cone. The Falcon 50 engines are twin-spool, bypass turbofans, manufactured by the Garrett

Turbine Engine Company of Phoenix, Arizona. The engines are designated TFE 731-3-1C (3D). Each engine is rated at 3,700 pounds of thrust, static, at sea level.

The maximum continuous rating at 40,000 feet is 817 pounds of thrust.

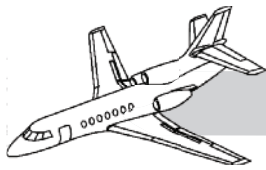

ENGINES

MAJOR SECTIONS

The TFE 731 engine (Figure 7-2) is of modular design for ease of maintenance. For the purpose of this explanation, the engine is divided into eight major sections which are:

1. Air Inlet Section
2. Fan Section
3. Planetary Gear Section
4. Compressor Section
5. Combustor Section
6. Turbine Section
7. Accessory Section
8. Exhaust Section

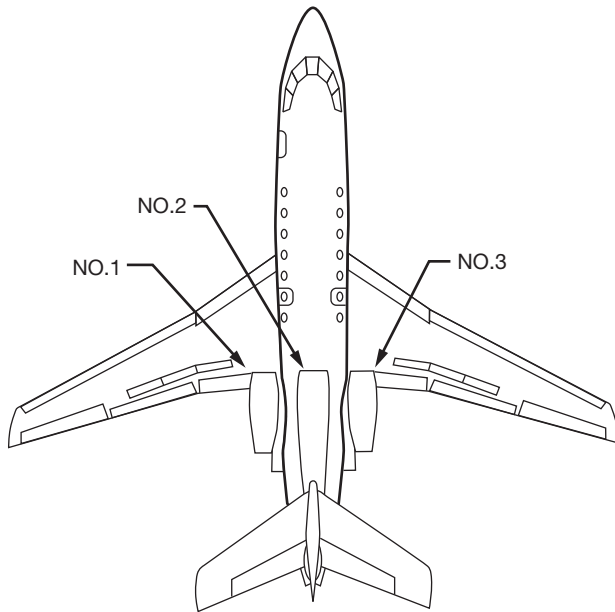

Figure 7-1. Main Engines

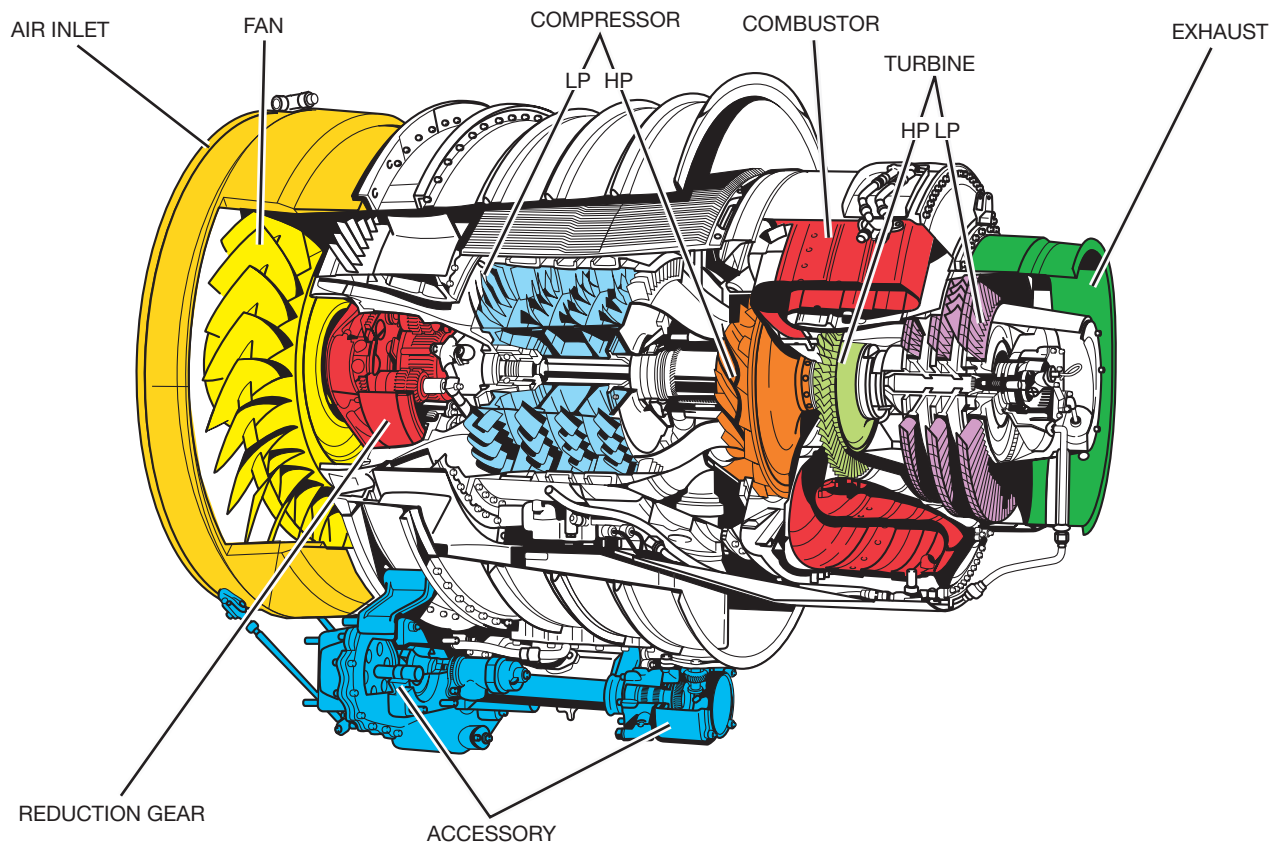
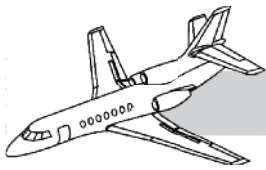

Figure 7-2. Engine Cutaway



Air Inlet Section

The inlet section forms the main air inlet to the engine. It is divided into a full-length bypass duct and a gas generator inlet.

Fan Section

The fan section includes the single-stage fan and the fan spinner. The fan functions to supply a large air mass at a relatively low velocity into the bypass duct and into the gas generator duct. The fan is driven by the low-pressure (LP) turbine through a planetary-type reduction gear case. The LP compressor is also driven by the LP turbine through a coaxial shaft. The fan bypass ratio is 2.67 at sea level on a standard day.

Planetary Gear Section

The planetary gear section is used to reduce the high rotational speed of the LP turbine to the design fan rpm. The ratio is 1.8:1.

Compressor Section

The compressor is a twin-spool type consisting of a single-stage centrifugal high-pressure (HP) compressor and a four-stage axial low-pressure (LP) compressor. The HP and LP compressors are mounted on coaxial shafts. The compressors function to provide air for cooling and combustion and for certain aircraft pneumatic and environmental systems.

Combustor Section

The combustor section is an annular, reverse-flow type. The combustor contains twelve duplex spray nozzles and two igniter plugs.

The combustor's function is to control the mixing of the combustion airflow with the fuel spray which comes from the nozzles. This mixture is initially ignited by the two igniter plugs until combustion is self-sustaining.

Turbine Section

The turbine section is made up of a single-stage, high-pressure (HP) turbine disc and three axial flow, low-pressure (LP) turbine discs.

The HP turbine is connected to the HP compressor. The HP turbine functions to extract sufficient energy from the expanding combustion gases and uses that energy to drive the HP compressor and the accessory gear section. The HP compressor and HP turbine combination are referred to as the HP spool, designated as N_2 .

The LP turbine consists of three axial discs, and the assembly is connected directly to the LP compressor and to the single-stage fan through the planetary gear section.

The LP turbine functions to extract sufficient energy from the escaping combustion gases to drive the LP compressor directly and to drive the single-stage fan through the planetary gear section. The LP compressor and LP turbine combination are referred to as the LP spool. The LP spool is designated as N_1 .

Accessory Section

The accessory section is made up of a transfer gearbox and an accessory gearbox. The transfer gearbox is driven by a tower shaft assembly from the HP spool shaft; in turn, the transfer gearbox drives the accessory gearbox.

The accessory gearbox is used to drive the engine and aircraft accessories, which consist of:

- Oil pumps
- Fuel pumps and fuel control unit (FCU)
- Hydraulic pump
- Starter-generator
- N_2 monopole

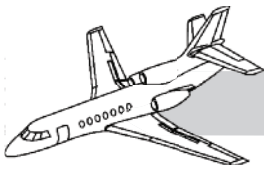

Exhaust Section

The function of the exhaust system is to accelerate and direct the combustion gases to the atmosphere to provide the propulsive force necessary to push the aircraft forward.

ENGINE OIL SYSTEM

General

The engine oil system is a self-contained dry sump system that provides for the cooling and lubrication of the engine bearings, the planetary gear system, and the accessory gear section (Figure 7-3).

The oil is contained in an engine-mounted tank which includes a filler and level indicator.

The oil system is a pressure and scavenge system consisting of a five-in-one pump assembly which includes one pressure element and four scavenge elements. A pressure regulator limits the maximum operating pressure.

Oil cooling is achieved by a fuel oil-cooler and a three-section air-oil cooler. A chip detector in the sump provides cockpit indication of metal particles in the oil. The oil system also includes a filter, a filter clog indicator, and a fuel heater.

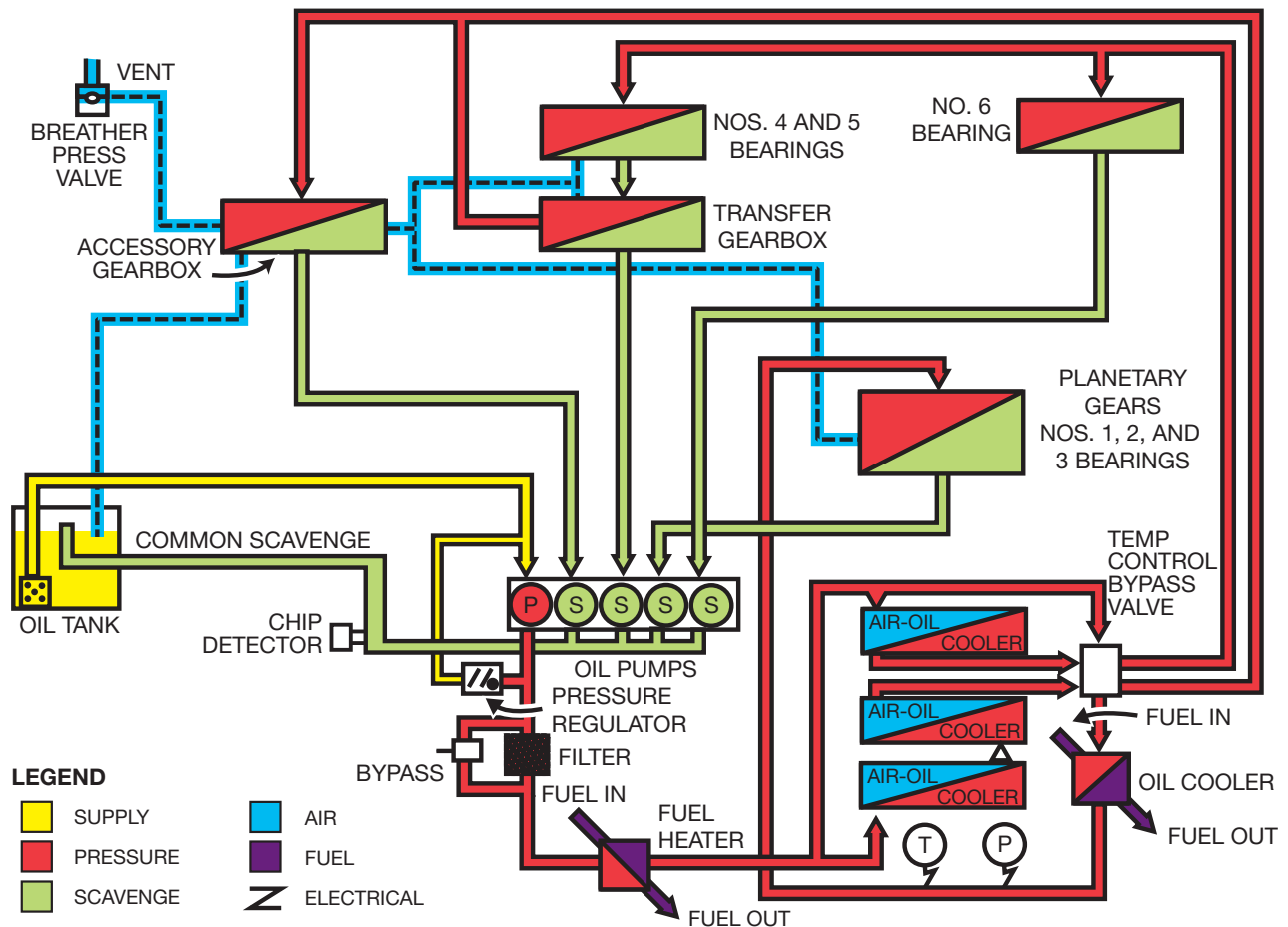
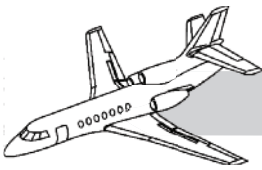

Figure 7-3. Engine Oil System Schematic



Indications

Oil Pressure

Oil pressure is sensed by transmitters and sent to a dual-scale gage for each engine, as shown in Figure 7-4. One scale indicates oil pressure in psi; the other, oil temperature in degrees Celsius.

Low Oil Pressure

Low oil pressure is sensed by pressure switches and transmitted to a light for each engine marked OIL 1, OIL 2, and OIL 3, respectively. The lights are located on the master warning panel.

Oil Temperature

Oil temperature is sensed by probes and transmitted to a dual-scale gage for each engine. One scale indicates oil temperature in degrees Celsius; the other, oil pressure in psi.

Chip Detector

The chip detector, mounted on the oil pump assembly, is a magnetic type. Metal chips attracted to the detector will ground the unit and turn on the low OIL pressure light. If the low OIL pressure light comes on, check the oil pressure gage. If the reading is normal, it must be assumed that the light came on because of metal particles in the oil.

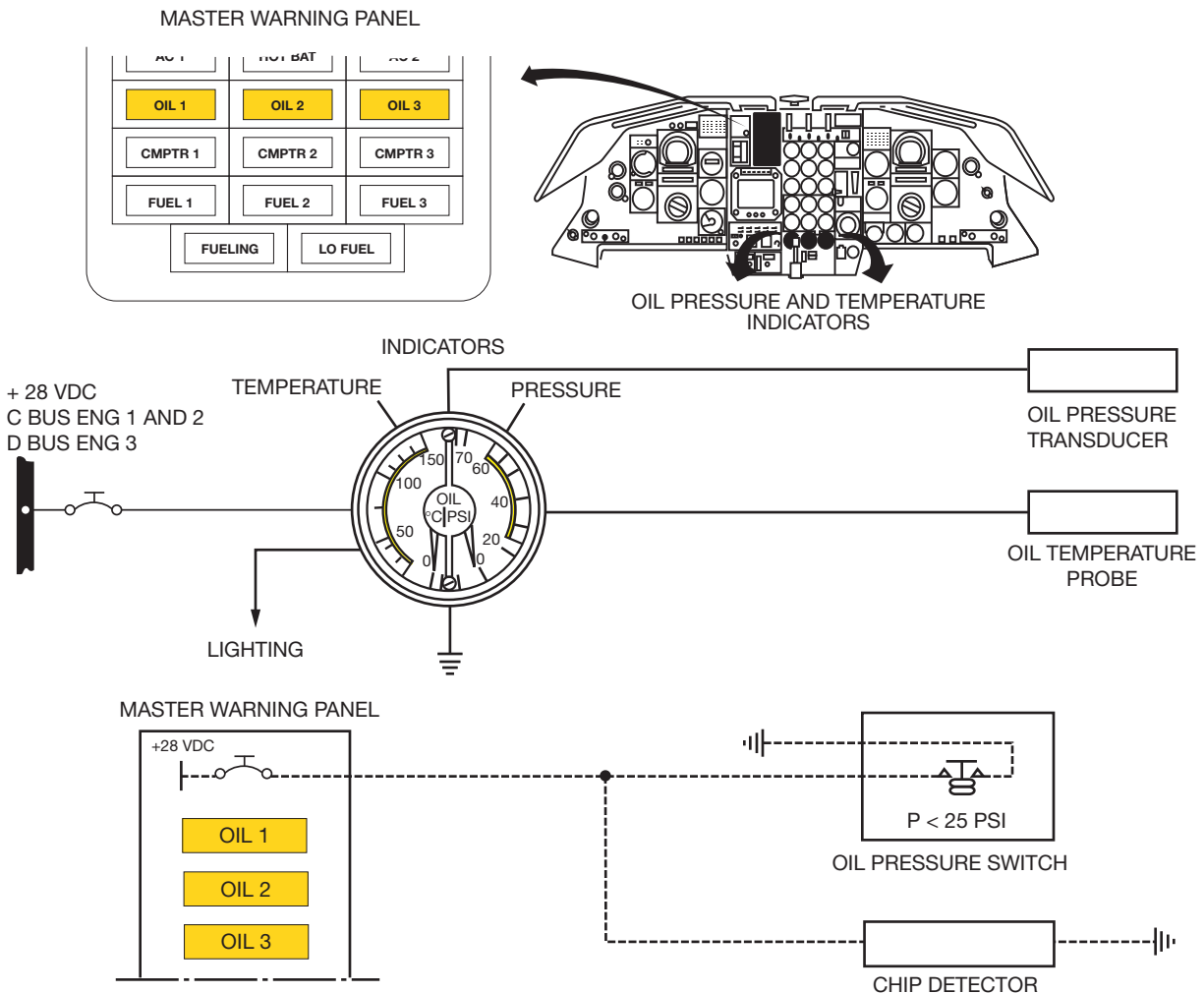
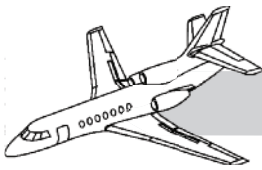

Figure 7-4. Engine Oil Temperature and Pressure Monitoring System



Operation

Oil system operation begins as soon as engine rotation occurs. The pressure pump draws oil from the tank and develops a pressure in the oil. The pressure is limited by the pressure regulator. Pressurized oil is directed through a bypass filter, through a fuel heater, and then to a temperature control valve which either directs the oil through the three-section air-oil cooler or allows it to bypass the air-oil cooler (Figure 7-3). This oil is now directed for lubrication of the accessory gear section, the transfer gearbox, and the Nos. 4, 5, and 6 engine bearings. A portion of the pressure flow is directed to a fuel-oil cooler, where another bypass valve determines whether the oil goes through or bypasses the cooler on its way to the planetary gear system and the Nos. 1, 2, and 3 bearings.

Positive scavenging of the lubricated areas is done by the four scavenge pumps. These pumps direct all oil back to the tank through a common scavenge line.

All lubricated areas are positively vented, including the oil tank. Venting pressure is controlled by a breather pressurizing valve. Oil pressure and temperature are sensed at the outlet of the fuel oil cooler and transmitted to the cockpit gages.

ENGINE FUEL SYSTEM

The engine fuel system consists of a hydro-mechanical fuel control unit (FCU). The fuel control unit includes an engine-driven boost pump and an engine-driven (HP) pump (Figure 7-5).

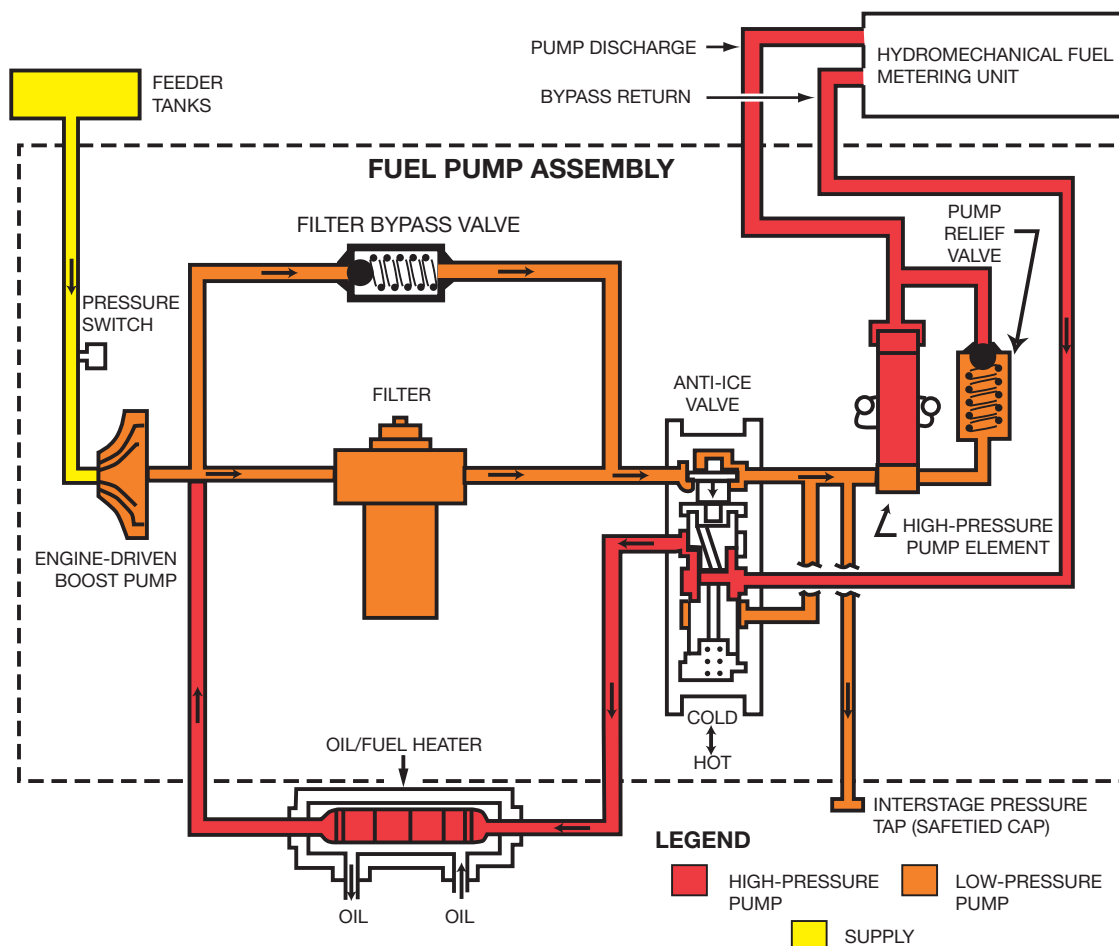
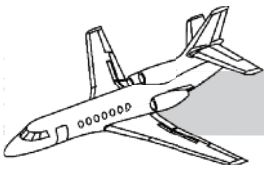

Figure 7-5. Engine Fuel Schematic



The function of the FCU is to meter fuel to the combustor system to meet all operating requirements. Under all normal operating conditions, the FCU is controlled by an electronic computer.

NOTE

This info pertains to F50s with EECs. Aircraft may have DEECs based on a S/B or STC. Refer to S/B or STC for specific information.

Electronic Computer

The electronic computer senses six parameters:

1. LP spool rpm N_1
2. HP spool rpm N_2
3. P_{T2} engine inlet total pressure

4. T_{T2} engine inlet total temperature
5. T_5 interstage turbine temperature
6. Power lever angle (PLA) through a potentiometer

The electronic computer (Figure 7-6) receives these signals and converts them to electrical output signals transmitted to (1) a torque motor on the fuel control unit to adjust metered fuel to the combustor and (2) solenoids on the LP spool bleed valve to control bleed valve opening and closing during acceleration and deceleration to prevent LP compressor stalls and surges.

In addition, the electronic computer sends output signals to control engine start fuel and fuel enrichment, starting temperature, ignition, HP and LP spool ultimate overspeed, and automatic termination of the start.

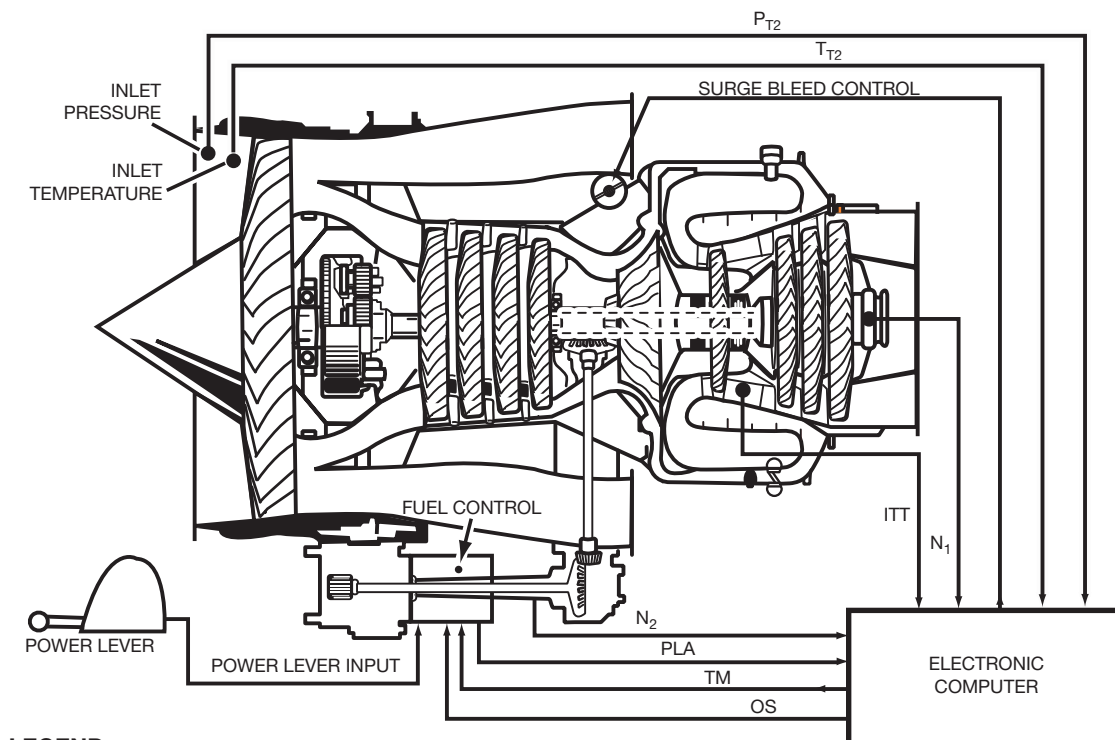

LEGEND

- | | |
|---|--------------------------------------|
| N_1 = LOW-PRESSURE SPOOL SPEED | ITT = INTERSTAGE TURBINE TEMPERATURE |
| N_2 = HIGH-PRESSURE SPOOL SPEED | PLA = POWER LEVER ANGLE |
| P_{T2} = ENGINE INLET TOTAL PRESSURE | TM = DC TORQUE MOTOR |
| T_{T2} = ENGINE INLET TOTAL TEMPERATURE | OS = OVERSPEED SOLENOID |

Figure 7-6. Fuel Computer Control Schematic

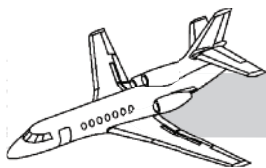

The electronic computer is such that it automatically switches to a manual mode if input signals are absent. Provisions may be incorporated on some aircraft to provide rpm synchronization for the engines.

Control and Indication

The electronic computer is controlled by a two-position switch for each engine, marked CMPTR 1, CMPTR 2, and CMPTR 3, as shown in Figure 7-7.

Three lights on the master warning panel provide indication of computer malfunction. The lights are marked CMPTR 1, CMPTR 2, and CMPTR 3. The lights come on if the associated fuel computer switch is off or if the switch is on and the computer has switched to a manual mode because of a loss of input signals or other malfunctions.

Start Pressure Regulator (SPR)

The engine fuel system includes a start pressure regulator (SPR) valve to automatically control fuel enrichment during engine starting. Enrichment is controlled by the fuel computer.

A pushbutton switch for each engine is used to manually control the SPR valve. In the manual mode, fuel enrichment continues for that engine as long as the pushbutton switch is held in.

Remember that the automatic temperature control function of the electronic computer is overridden by the SPR switch and that engine temperatures must be monitored carefully when manual start fuel enrichment is used.

NOTE

If aircraft has S/B or STC for DEECs to be installed, the SPR buttons now become event initiator buttons (see S/B or STC for exact information).

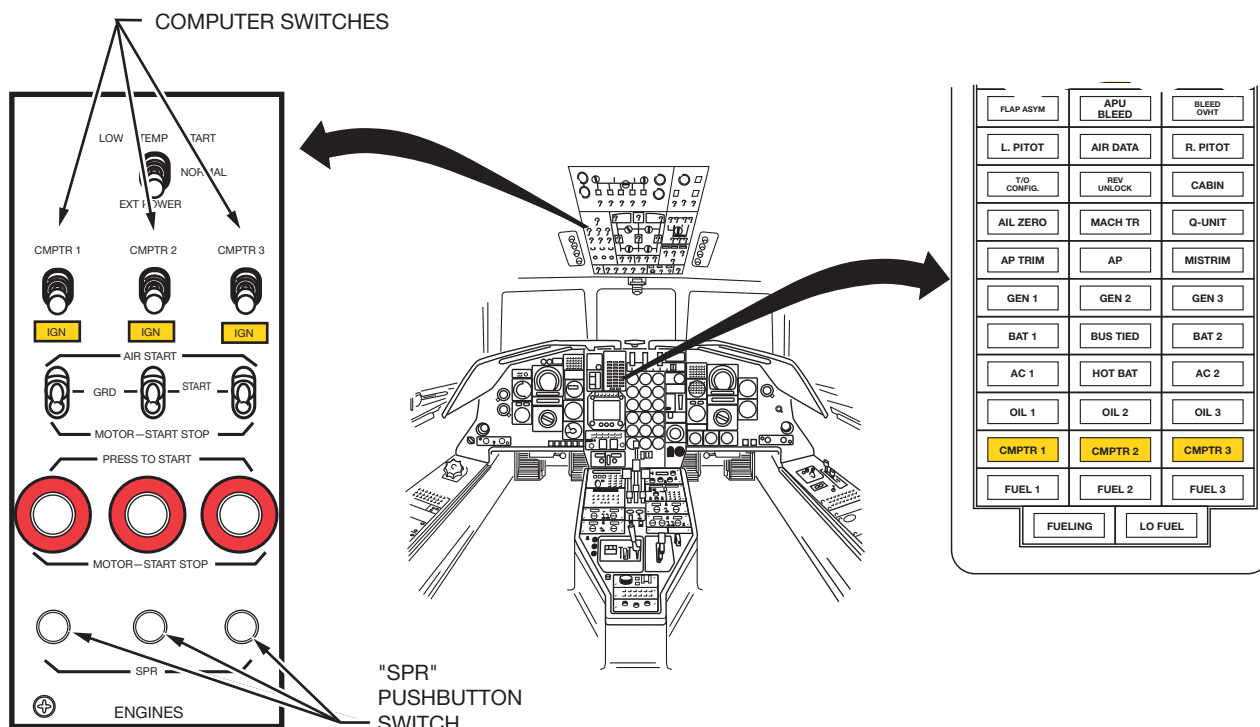
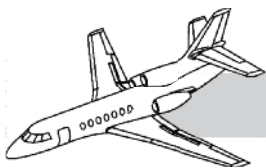

Figure 7-7. Computer Switches and Failure Indicator Lights



Compressor Bleed Valve

The compressor bleed, or antisurge valve is electropneumatic. It uses HP compressor air to open or close the valve, and it allows air to be dumped from the LP compressor into the bypass duct to prevent compressor stalls and surges. The bleed valve is controlled by the electronic computer through one of two solenoid valves that produces three positions of the valve—that is, CLOSED, 1/3 OPEN, and FULL OPEN.

If the electronic computer fails, the valve is fail-safe to the 1/3 OPEN position.

Operation

Basic pressure for the engine fuel system is supplied by a boost pump in the feeder tank. Fuel is directed through the normally open fuel fire shut-off valve to the inlet of an engine-driven LP pump which increases fuel pressure and directs it through a bypassable filter and an anti-ice valve to the HP pump. The HP pump directs HP fuel to the FCU. If fuel temperature is low, the anti-ice valve directs fuel through a fuel-oil heater to the inlet of the filter to prevent ice formation.

In normal operating conditions, the electronic computer sends output signals to a torque motor on the FCU to determine metered fuel to the combustor. The computer also controls the operation of the SPR valve to provide increased fuel during starting. The SPR valve may also be controlled by the pilot through the SPR switch.

The metered fuel from the FCU is directed through a fuel-oil cooler to the flow divider. The flow divider will direct fuel through the primary manifold at low power settings (such as starting) and, during high power settings, to the primary and secondary manifold. If the electronic computer fails, the FCU is controlled by power lever input signals.

ENGINE IGNITION SYSTEM

The TFE 731 engine uses a high-energy ignition system (Figure 7-8) consisting of a dual-ignition unit mounted on the engine and two igniter plugs in the combustion chamber.

The ignition system is subdivided into three categories:

1. Ground Start Ignition
2. Airstart Ignition
3. Stall Ignition

Control

The ignition system is controlled in the ground- start and airstart modes by a three-position switch for each engine. The switch positions are marked MOTOR—START STOP, GRD START, and AIR START (Figure 7-9).

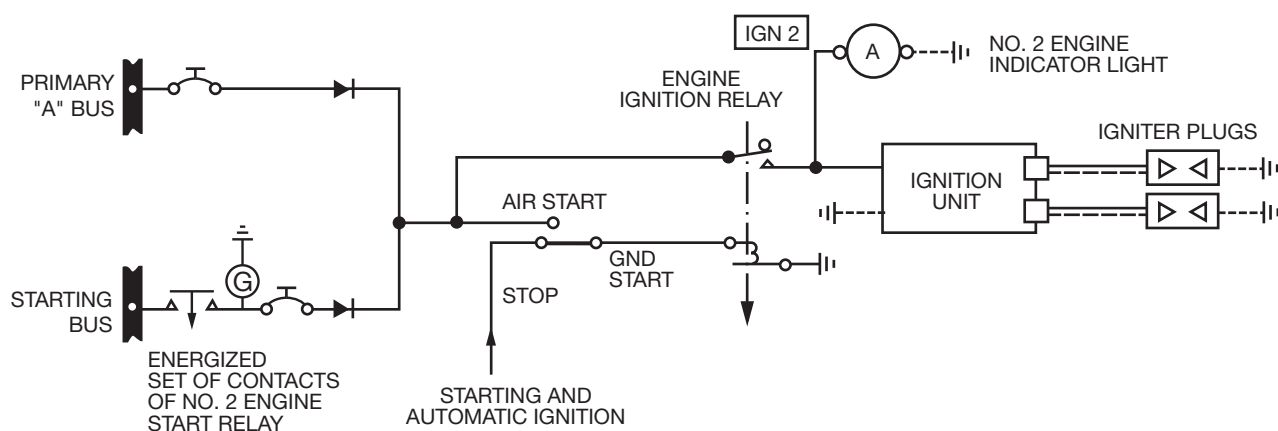

Figure 7-8. Ignition System

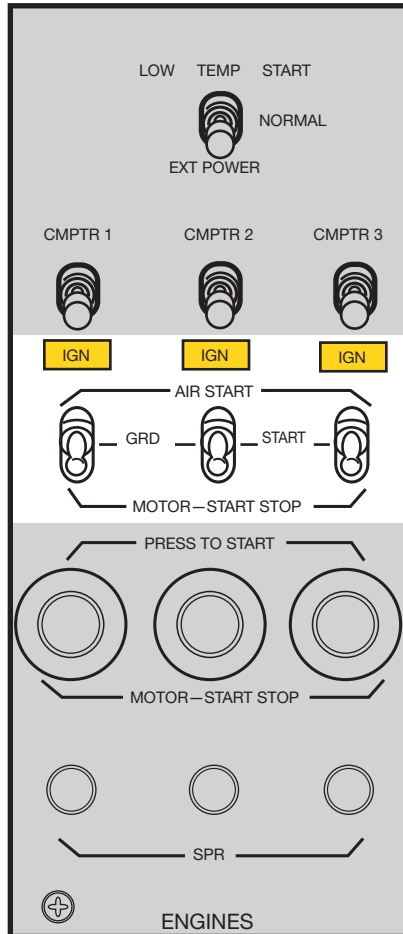
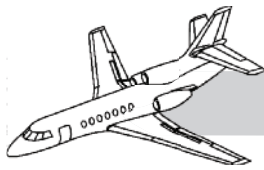

Figure 7-9. Ignition Switches

When the switch is moved to the MOTOR—START STOP position, the ignition system is interrupted to permit engine cranking without ignition. This position may also be used to interrupt ignition, and release the start relay if it becomes necessary to terminate a start. (Table 7-1).

The GRD START position on the switch is the normal position, and ignition is initiated when the associated engine throttle is moved out of the STOP position. At 50% rpm, ignition is automatically terminated by an electronic speed switch in the fuel computer. GRD START position can be used only on the ground.

The AIR START position of the switch provides ignition during a windmilling start. Ignition in this case will be continuous as long as the switch is left in the AIR START position.

The AIR START position of the switch may also be used on the ground to test operation of the ignition unit and the igniter plugs.

Stall Ignition

The stall ignition system is an automatic ignition system that receives input from the slat system and from Stall 1 and Stall 2 systems to initiate ignition and prevent flameout if the aircraft approaches a stall configuration or a specific angle of attack. The stall ignition system is armed

Figure 7-1. IGNITION SEQUENCE—IMMEDIATE ACTION ITEMS

	START SELECTOR TO MOTOR-START STOP	POWER LEVEL TO CUTOFF AND START SELECTOR TO MOTOR-START STOP
N ₂ fails to rotate	*	
N ₂ fails to reach 10% in 6 seconds	*	
No ITT 10 seconds after P/L opened at 10% N ₂		**
No N ₁ by 20% N ₂		**
N ₁ or N ₂ stops accelerating to idle		**
ITT rises rapidly through max start temp minus 50°C		**
ITT approaches max start limit		**
No oil pressure within 10 sec after light-off		**
Any unusual noise or vibration		**
Starter or ignition fails to disengage	*	
Engine does not reach idle within 50 sec after light-off		**

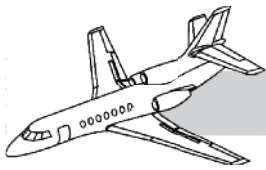

whenever the ignition control switch is at the GRD START position.

When ignition is initiated by Stall 1 or Stall 2 systems, the ignition remains on for ten seconds after the angle of attack is reduced to below 17°.

The stall ignition may be tested by using the STALL 1 or STALL 2 test switches (with the aircraft on the ground only). Ignition operation continues for ten seconds after either test switch is pushed. During the test the audio warning sounds.

Indication

An ignition light for each engine is located above the ignition switch. The light will come on at any time that the ignition system is powered.

ENGINE POWER CONTROL

Each engine is controlled by a throttle lever operating in a quadrant on the pedestal. The throttle is mechanically connected to the FCU. The throttle also operates a variable resistor in the FCU to provide power lever angle (PLA) inputs to the electronic computer.

The throttle lever has three basic detented positions: STOP, IDLE, and FULL POWER. A finger latch on the throttle lever must be raised before the lever can be moved from IDLE to STOP. A positive stop is provided at the FULL POWER position.

ENGINE INSTRUMENTATION

Fuel flow is sensed by a mass flow transmitter for each engine. It is shown on a gage which is calibrated in pounds of fuel per hour times 100. (Figure 7-10).

A fuel flow totalizer and aircraft weight indicator may be installed as an optional item.

N₁ or LP compressor spool rpm (Figure 7-11) is sensed by a monopole at the rear of the LP rotor shaft. The monopole output is transmitted to gages calibrated in percent of design 100% rpm. A digital readout window is also provided on the N₁ gages. The N₁ monopole also provides an input signal to the electronic computer of the engine fuel system.

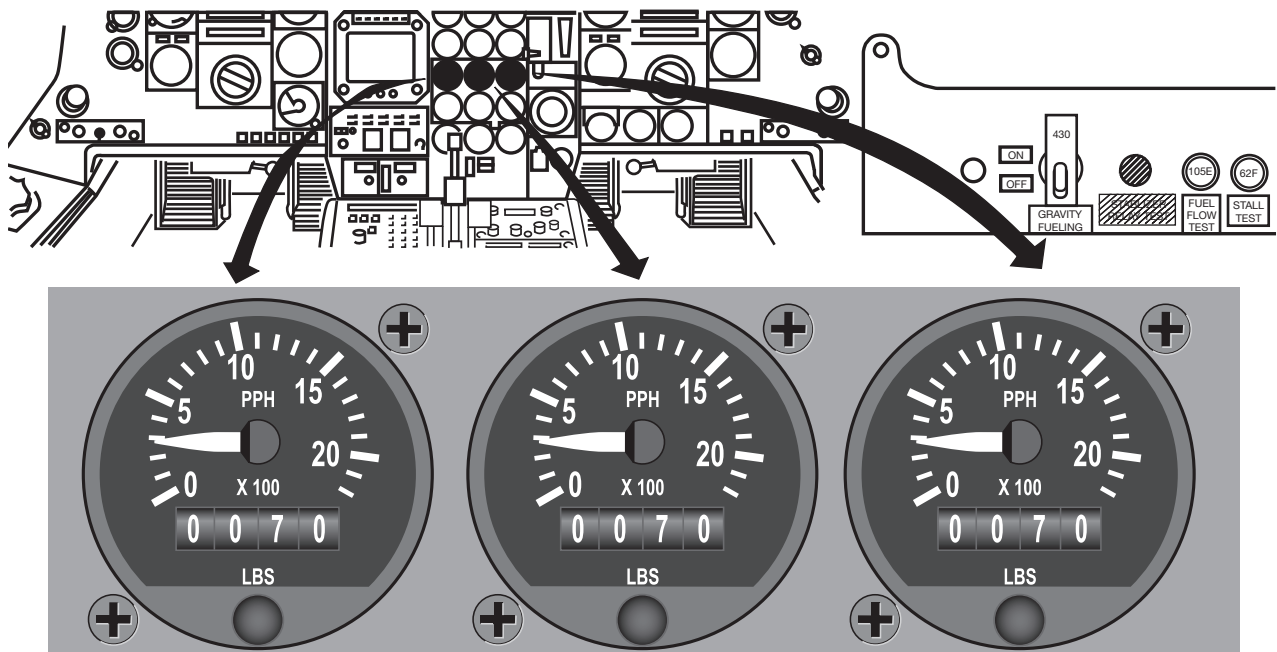

Figure 7-10. Engine Instrumentation

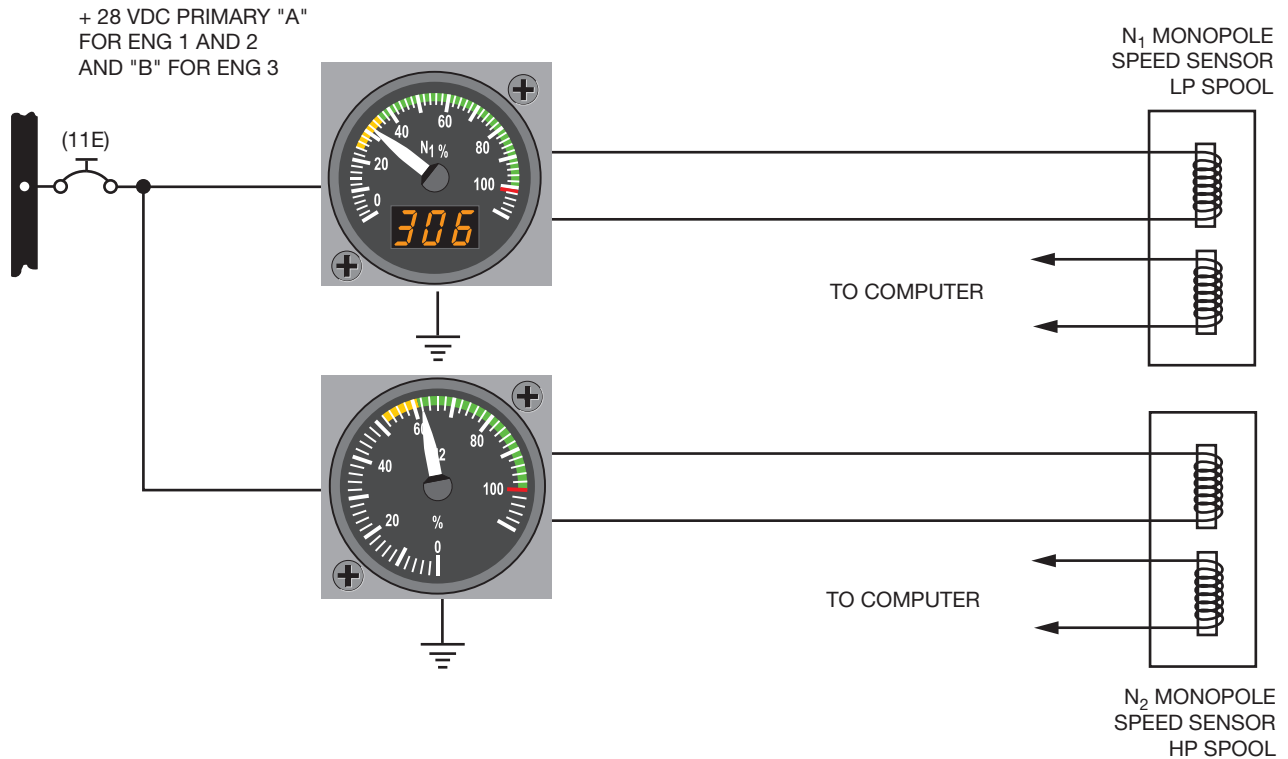
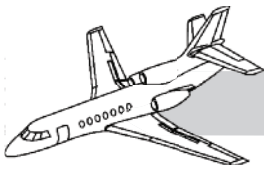

Figure 7-11. LP and HP RPM

N₂ or HP compressor spool rpm (Figure 7-11) is sensed by a monopole on the transfer gearbox. The monopole output signals are sent to gages calibrated in percent of design 100% rpm. N₂ monopole signals are also sent to the electronic computer.

Engine combustion temperature (Figure 7-12) is sensed by thermocouples located between the HP and LP turbines. The output signals are sent to gages calibrated in degrees Celsius and indicated as interstage turbine temperature (ITT). The ITT thermocouples also provide an input to the electronic computer.

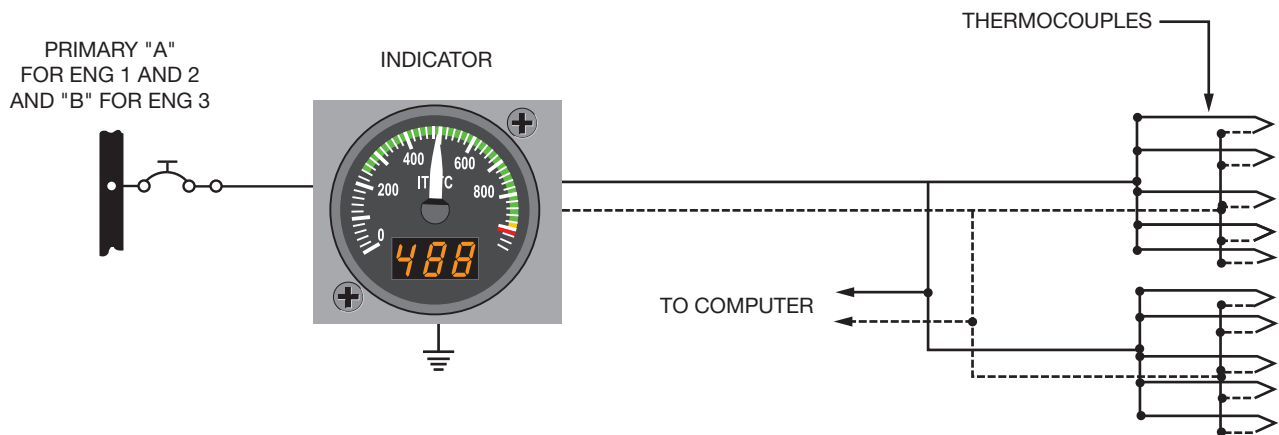
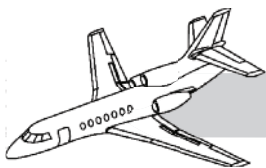

Figure 7-12. Engine ITT Indicator



NO. 2 ENGINE FAILURE MONITOR

The No. 2 engine has a failure monitoring system that warns the crew that the No. 2 engine is not developing takeoff thrust or that an access door in the No. 2 engine S-duct is not closed.

The monitoring system is effective only when the aircraft is on the ground. A light marked ENG 2 FAIL is located on the pilot instrument panel above the attitude director indicator (ADI).

The No. 2 engine failure sensing unit (Figure 7-13) receives input signals from the nose gear proximity switch (weight switch), from the No. 2 engine N_1 monopole and from a switch operated by the No. 2 engine throttle. This latter switch closes at a throttle angle representing about 84% rpm. Finally, an input signal is provided by a microswitch which will be closed if the No. 2 engine S-duct air intake door is not fully closed. This circuit is

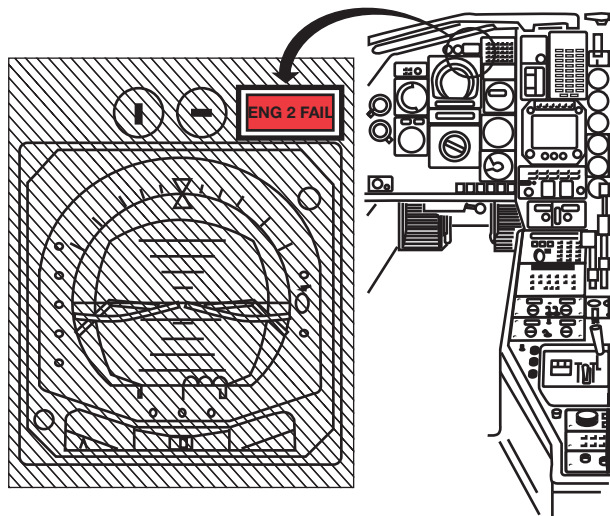

Figure 7-13. No. 2 Engine Failure Monitor available on the ground and in flight.

The ENG 2 FAIL light may be tested before starting the engine by moving the throttle lever to the FULL POWER stop. The ENG 2 FAIL light should come on.

THRUST REVERSER

GENERAL

Thrust reversal is built into the No. 2 engine (Figure 7-14). While in stow configuration, the clamshell doors form the rear section of the exhaust duct. When deployed, the two doors deflect exhaust gases horizontally. Thrust reverser efficiency is approximately 40% of takeoff thrust, and may be maintained until the aircraft is stationary.

The thrust reverser lever is mounted on the No. 2 throttle lever.

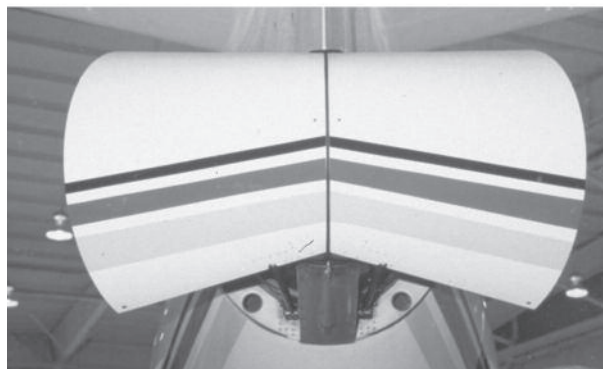
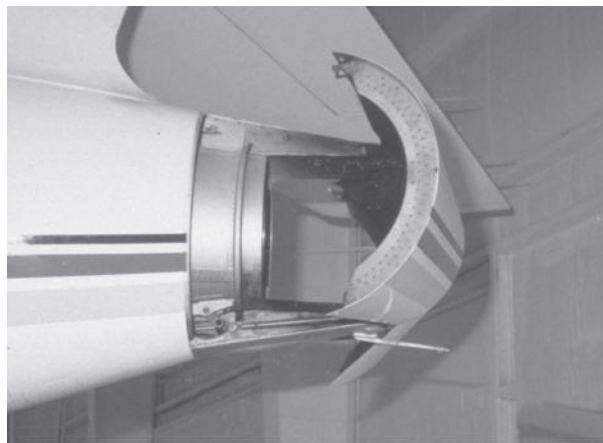
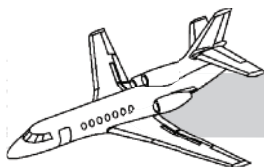

Figure 7-14. Thrust Reverser



DEPLOYED and TRANSIT indication lights are located on the instrument panel, and a REV UNLOCK light is located on the master warning panel (Figure 7-15).

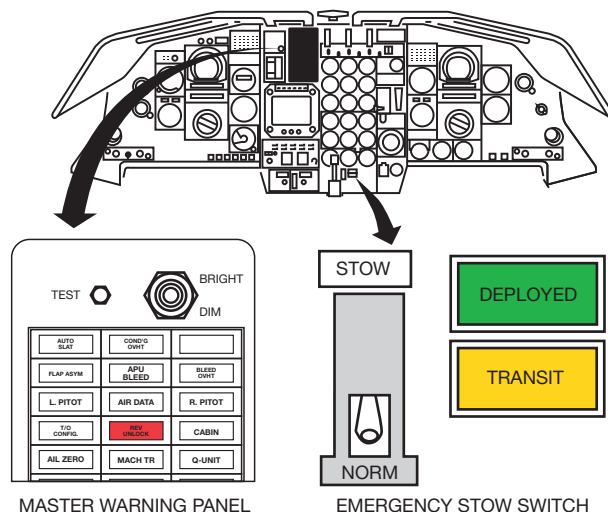

Figure 7-15. Thrust Reverser Controls and Indicators

CONTROL AND INDICATION

Thrust reversal uses an electrohydraulic-hydraulic control system. It is activated by the reverse thrust control mounted on the throttle lever of the No. 2 engine. The throttle lever must be locked in IDLE position during reverse thrust operation. Hydraulic power is supplied by the No. 1 hydraulic system or by an accumulator which allows one full deploy-retraction cycle should the No. 1 system fail.

Two conditions must be met before the thrust reversers can be deployed. First, the aircraft must be on the ground, as sensed by the main landing gear proximity sensors. Second, the throttle must be set to IDLE.

When these conditions are met and the handle is activated, a solenoid sends a signal to the TRANSIT indicator light. Hydraulic pressure releases the clamshell door locks, deploys the doors, and locks the throttle lever.

When the doors are deployed, engine acceleration is activated, the TRANSIT light goes out, and the green DEPLOYED light comes on, allowing the T/R handle to be unlocked to increase power. Hydraulic pressure is maintained on the actuator throughout operation.

Initiate the retraction cycle by returning the handle to the retracted position, which allows the engine to return to IDLE. As the clamshell doors leave the DEPLOYED position, the green DEPLOYED light goes out and the amber TRANSIT light comes on. A red REV UNLOCK indication appears on the master warning panel. Completion of the cycle is indicated by all three lights being off and the throttle lever lock being released. With the power lever in idle, the thrust reverser is hydraulically and mechanically locked in stow. Otherwise, the lock is only mechanical.

EMERGENCY MODE

An emergency retraction STOW switch is located on the instrument panel adjacent to the DEPLOYED and TRANSIT lights. Moving it to the STOW position directly retracts the clamshell doors, regardless of flight conditions or switch positions.

LIMITATIONS

The Falcon 50 aircraft must be operated in compliance with the limitations listed in Section 1 of the approved *Flight Manual*. Compliance is required by Federal Aviation Regulations.

ENGINE THRUST RATINGS (UNINSTALLED SEA LEVEL ISA)

Takeoff 3,700 pounds

Maximum Continuous . . . 3,700 pounds

Thrust setting parameters are based on N_1 rpm, and computed from the charts in the approved *Flight Manual*.

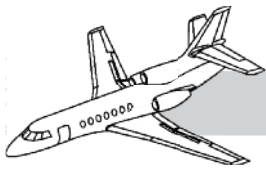

The takeoff and maximum continuous N_1 values must be determined from the charts in Section 5 of the approved Flight Manual.

Takeoff thrust is limited to five minutes.

Other limits for takeoff and maximum continuous thrust must be determined from the approved *Flight Manual* Section 5, "Performance."

ENGINE ROTOR SPEED

The maximum N_1 for takeoff or for maximum continuous power is 101.5%.

The maximum N_2 for takeoff or for maximum continuous power is 100%.

A transient rpm for N_1 and N_2 of 103% is permissible for one minute, and a transient of 105% N_1 or N_2 is permissible for five seconds.

ENGINE INTERSTAGE TURBINE TEMPERATURE

The maximum starting ITT is 907°C. Transient ITT up to 927°C is allowable for 10 seconds. If ITT exceeds 977°C for 5 seconds, a hot section inspection must be performed. If ITT exceeds 977°C, an overtemperature inspection must be performed. The Garrett Turbine Engine Company recommends a maximum ITT of 885°C for 30 minutes.

STARTER

The starting time for ground start or a starter-assisted airstart from 10% N_2 to light-off is ten seconds. For a windmilling start from windmilling N_2 rpm to 60%, N_2 is 25 seconds. For ground starting, the engine should accelerate from light-off to idle in 50 seconds.

FUEL COMPUTERS

All engine fuel control computers must be on and operating for takeoff.

FUELS

Chapter 5 outlines the total usable fuel load and the approved fuels. If fuel types are changed or mixed, the appropriate adjustment must be made at the fuel control computer in accordance with the instructions in the approved *Garrett Turbine Engine Maintenance Manual*.

Oils

The approved oils must conform to the Garrett Turbine Engine Company specifications.

For takeoff and maximum continuous operation, the minimum oil pressure is 38 psi and the maximum, 46 psi.

The minimum idle rpm oil pressure is 25 psi, the maximum, 46 psi.

The maximum transient oil pressure is 55 psi for less than three minutes.

The low OIL pressure lights on the master warning panel come on during operation if the oil pressure is less than 25 psi.

OIL TEMPERATURE

The minimum for initiating takeoff, and for continuous operation is 30°C. From sea level to 30,000 feet, the maximum oil temperature is 127°C. Above 30,000 feet, the maximum oil temperature is 140°C. Transient oil temperature at all altitudes is 149°C for less than two minutes.

INSTRUMENT COLOR CODES

The maximum operating limit is indicated on instruments by a red radial marker.

The caution range is indicated by an amber band.

The normal range is indicated by a green band.

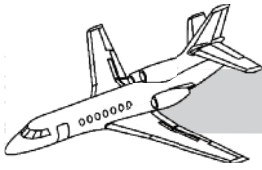

QUESTIONS

1. Which of the following most accurately describes the TFE 731 engine?
 - A. Free-spool turbofan
 - B. Single-spool turbofan
 - C. Twin-spool turbofan
 - D. Twin-spool aft fan
2. Which action must be taken if an engine low oil pressure light comes on?
 - A. Operate at reduced power if the oil pressure gage shows normal.
 - B. Shut the engine down.
 - C. Increase power to increase oil pressure.
 - D. Land as soon as possible, using minimum power on that engine.
3. If a fuel computer light comes on when lined up for takeoff, which of the following is the required action?
 - A. Match the N_1 to that of the highest engine.
 - B. Abort the flight and have the system corrected.
 - C. Set takeoff power to the N_1 or EGT limit.
 - D. Match EGT to that of the lowest engine.
4. If an engine stalls and surges during power changes, which of the following would be suspected?
 - A. Fuel filter icing
 - B. Low fuel pressure
 - C. Malfunction of the surge bleed valve
 - D. Contaminated fuel
5. Which of the following best describes the planetary gear system?
 - A. Reduces HP rpm to design fan rpm.
 - B. Maintains a fixed ratio between HP and LP rpm.
 - C. Provides proper ratios for accessories.
 - D. Reduces LP rpm to design fan rpm.
6. If the fuel computer inputs to the surge bleed valve fails, you can expect:
 - A. The surge bleed valve to assume 1/3 open
 - B. Surges in cabin pressure
 - C. Fluctuating N_2 rpm
 - D. A higher EGT

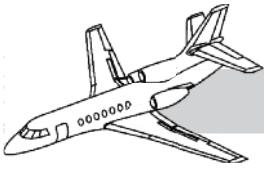

7. N_1 or N_2 transients of 105% are acceptable for:
 - A. Five minutes
 - B. One minute
 - C. Continuous operation
 - D. Five seconds
8. If ENG 2 FAIL light comes on when take-off power is applied, it indicates that the:
 - A. Electronic fuel computer has failed.
 - B. S-duct access door is open or engine power is low.
 - C. Fuel computer manual mode switch is on.
 - D. Nose gear proximity switch is in a flight mode.
9. Takeoff thrust setting parameters for the TFE 731 engine are based on:
 - A. N_2 rpm
 - B. EGT
 - C. N_1 rpm
 - D. Fuel flow
10. Which statement is true concerning reversal?
 - A. It is only built into the No. 2 engine, which must be retarded to IDLE for the thrust reverser control to operate, and only on the ground.
 - B. It can be operated in flight to reduce airspeed.
 - C. It will not function if hydraulic system No. 1 fails.
 - D. The only light indication is REV UNLOCK on the master warning panel.

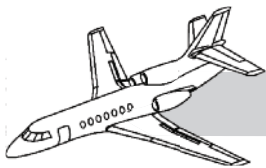

CHAPTER 8 FIRE PROTECTION

CONTENTS

	Page
INTRODUCTION.....	8-1
GENERAL.....	8-1
FIRE DETECTION.....	8-2
Engine Fire Detection.....	8-2
APU Fire Detection.....	8-3
Aft Compartment Fire Detection.....	8-3
Landing Gear Wheel Well Fire Detection.....	8-3
Baggage Compartment Fire Detection.....	8-3
Fire Test.....	8-3
FIRE EXTINGUISHING.....	8-4
General.....	8-4
Engine Fire Extinguishing.....	8-4
APU Zone Fire Extinguishing.....	8-5
Baggage Compartment and Aft Compartment Fire Extinguishing.....	8-5
Portable Fire Extinguishers.....	8-5
QUESTIONS.....	8-6

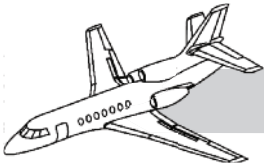

ILLUSTRATIONS

Figure	Title	Page
8-1	Fire Protection.....	8-2
8-2	Fire Protection Panel.....	8-3
8-3	Fire-extinguishing Schematic	8-4
8-4	Portable Fire Extinguishers.....	8-5

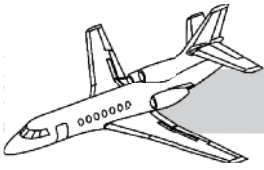

CHAPTER 8 FIRE PROTECTION



INTRODUCTION

The Falcon 50 has a fire protection system to detect and extinguish fires in certain sections of the aircraft. The detection system activates warning lights and an aural tone in the cockpit. The extinguishers are controlled by crew command.

GENERAL

Fire can be detected in the engines, the optional APU, aft compartment, baggage compartment, and the main landing gear wheel wells. Figure 8-1 shows the location of each detector loop, as well as the location of the five fire extinguishers (six when the APU is installed).

Fire extinguishers can discharge Halon into the three engines or into either the aft or baggage compartments. Most extinguishers have the capability of discharging into two different

locations, and most locations can receive a discharge from two different extinguishers. One exception is that if the APU is installed, its fire extinguisher is single shot and only for the APU. The other exception is that the LH baggage compartment extinguisher can discharge only into the aft compartment.

If extreme heat is detected in the main landing gear wheel wells, a warning is transmitted to the cockpit, but there is no extinguishing capability.

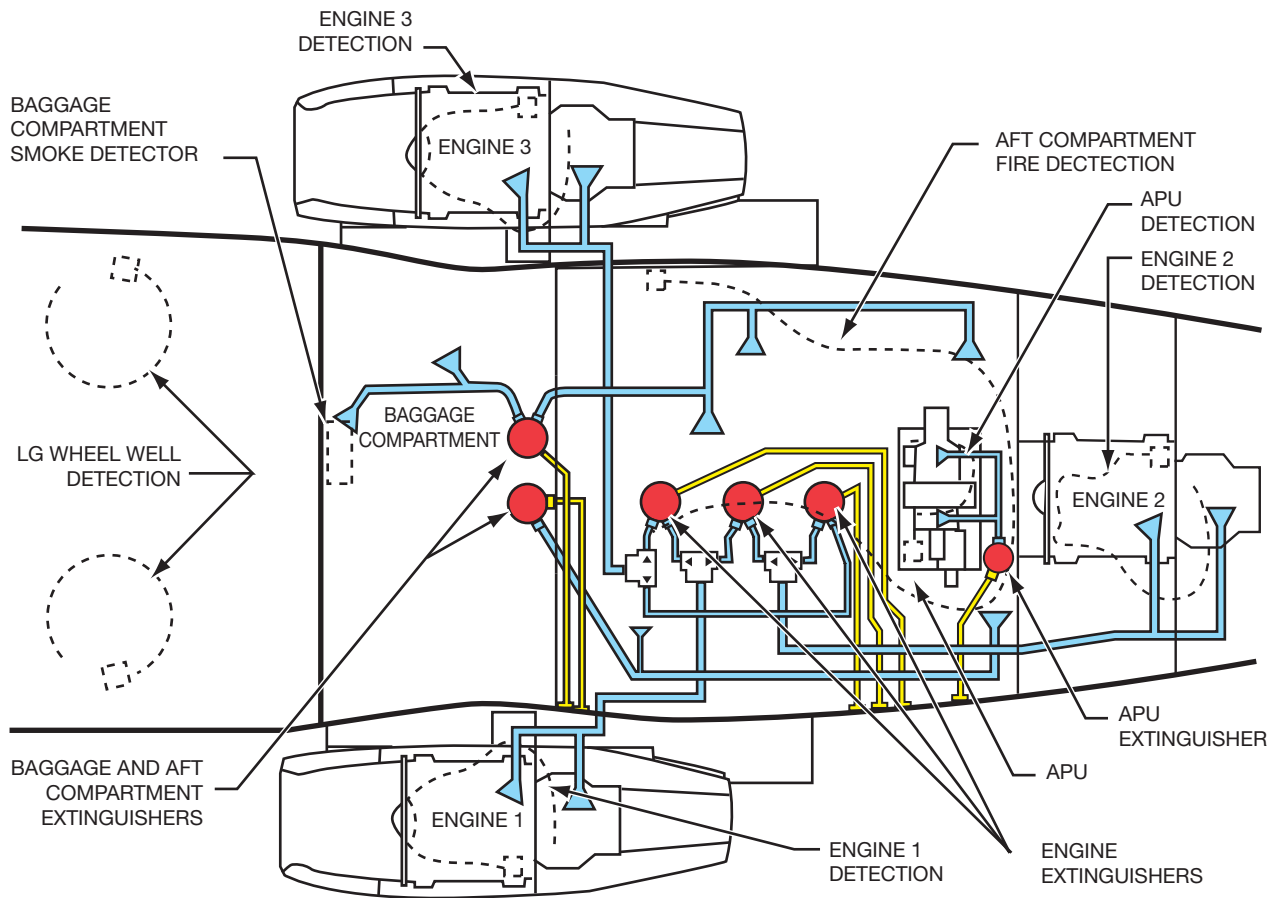
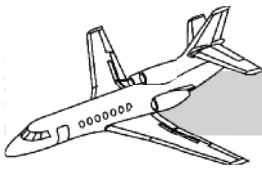

Figure 8-1. Fire Protection

FIRE DETECTION

ENGINE FIRE DETECTION

A fire detection loop is installed in the fire zone of each of the three engines. Each loop is 12 feet long and coiled around the engine. At the end of the tube is a switchbox containing an alarm and a test switch.

When a preset temperature is detected, the accompanying pressure caused by gas expansion causes the alarm switch to close and thus produce an audible cockpit warning and then illumination of the fire warning light in the applicable fuel shutoff handle (Figure 8-2).

Activating the test circuit checks:

- Electrical continuity of the extinguisher discharge squib
- Electrical continuity of the detector head
- Continuity of the tube (no gas leak)
- Electrical continuity of fire protection circuits

A successful check results in illuminating all appropriate lights and the sounding of the audible warning signal.

NOTE

Bottle pressure is not checked during this test.

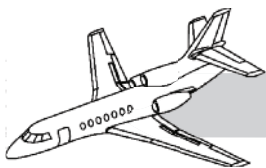

APU FIRE DETECTION

If an APU is installed, detection is the same as for the engines. However, instead of turning on lights in the fuel shutoff handle, the signal illuminates a FIRE APU light on the fire protection panel (Figure 8-2). The fire detection loop triggers the audible warning tone and also sends a shutoff signal to the APU fuel supply and air intake.

AFT COMPARTMENT FIRE DETECTION

Fire detection is similar to that for the engines, even though the aft baggage compartment is not a designated fire zone. High temperature is detected by the same type of loop, and the signal is transmitted to an aural alarm and to the red FIRE AFT COMP light on the fire protection panel (Figure 8-2).

LANDING GEAR WHEEL WELL FIRE DETECTION

Loop detectors similar to those used elsewhere, also supply an audible and illumination signal for overtemperature in the main gear wheel wells. The signal lights the respective

red L or R WHEELS warning light on the fire wheel wells. The signal lights the respective red L or R WHEELS warning light on the fire protection panel. There is no extinguishing agent in the wheel wells.

BAGGAGE COMPARTMENT FIRE DETECTION

Instead of the loop detector used elsewhere in the aircraft, there is an ambient smoke-optical detector in the baggage compartment. It is activated by the concentration of smoke detected through diffusion and reflection of the light produced by the detector. A photocell activates a Wheatstone bridge circuit which, in turn, activates the aural warning tone and the red FIRE BAG COMP light.

FIRE TEST

Activating the TEST button on the fire protection panel checks the continuity of all detection loops, the baggage compartment smoke detector, all eight lights, and the aural warning tone. The tone can be silenced during the test or for an actual fire or overheat condition by using the HORN SILENCE button on the pedestal. It does not check fire bottle pressure.

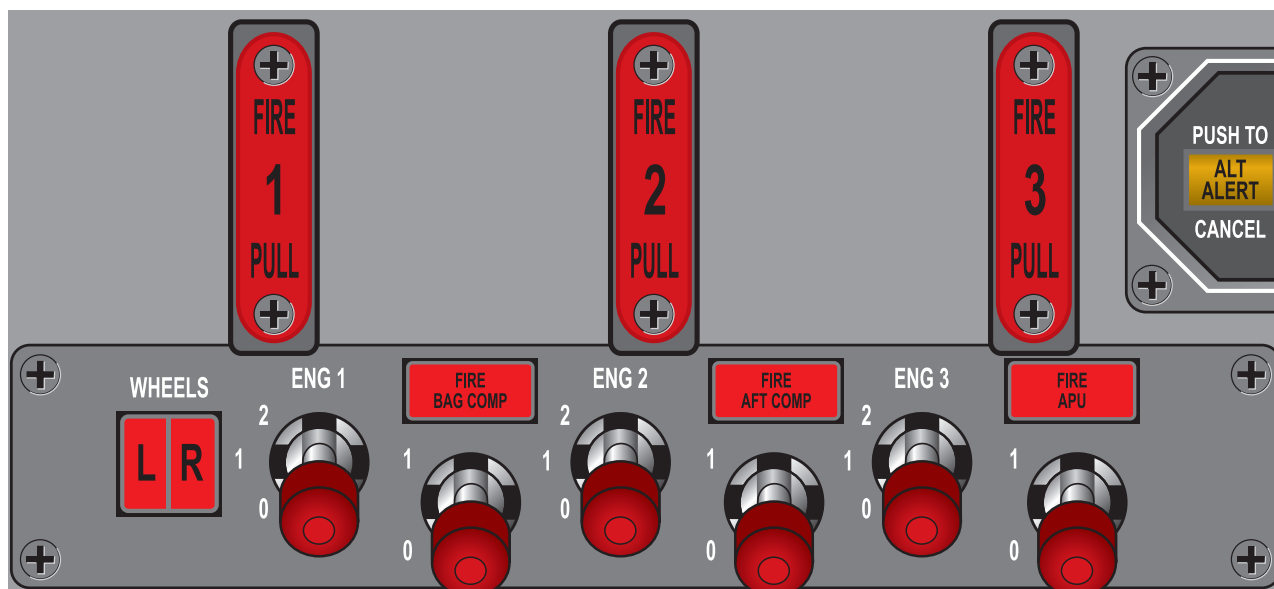
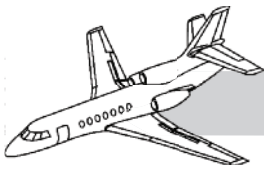

Figure 8-2. Fire Protection Panel



FIRE EXTINGUISHING

GENERAL

The aircraft is equipped with five fire extinguishers, or six if an APU is installed (Figure 8-3). Three are located on the left side of the aft compartment, and they share responsibility for the three engines. Two extinguishers, located in the baggage compartment, share the extinguishing responsibility for the baggage and aft compartments. The sixth extinguisher is located adjacent to the APU and dedicated solely to extinguishing an APU fire. Each

installed extinguisher has a representative frangible disc as well as a bottle pressure gage on the left-hand fuselage. All extinguishers are filled with CF_3Br , known as Halon 1301 Agent. When this agent has been exposed to high temperature, a dangerous gas is formed, so personnel should not enter enclosed areas after a discharge until the area has been well ventilated.

ENGINE FIRE EXTINGUISHING

The illuminated FIRE PULL T-handle is connected to the fuel shutoff valve. When pulled,

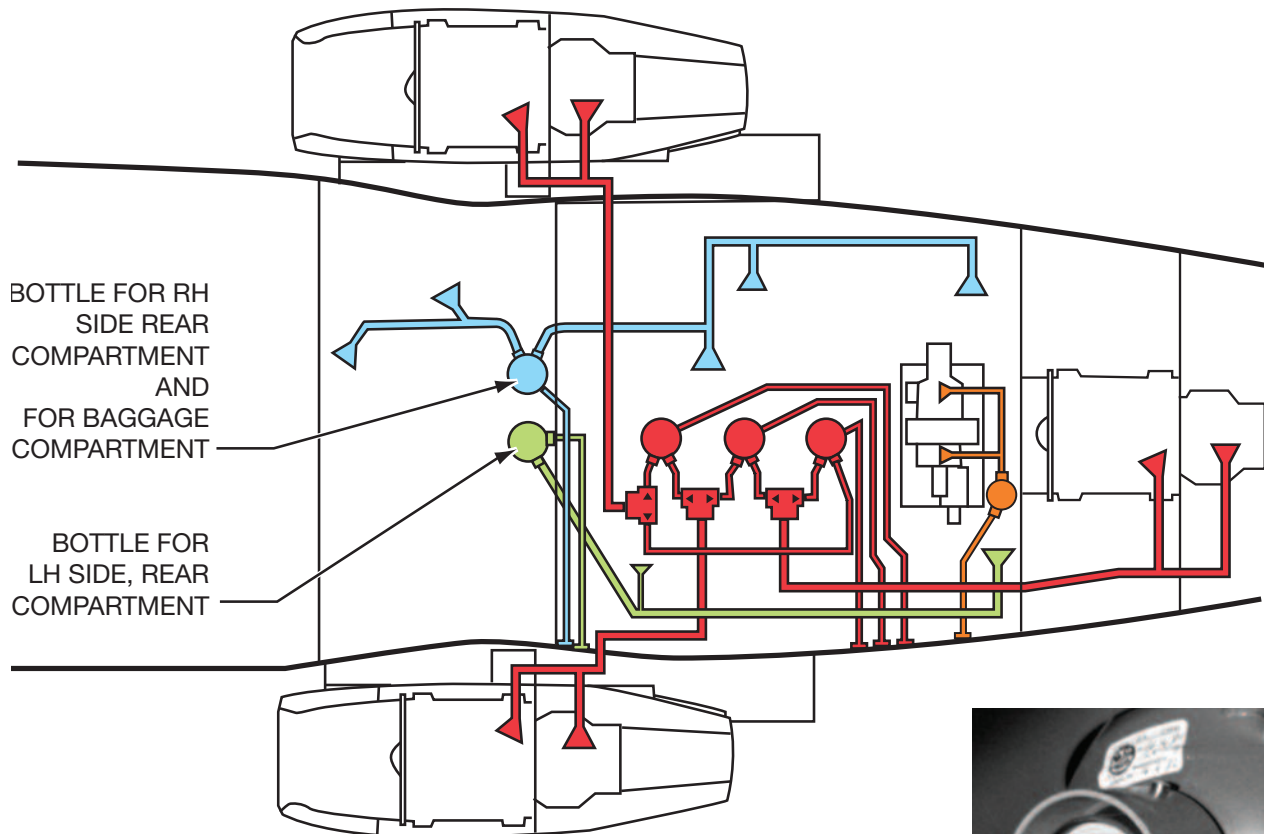

FIRE BOTTLE



Figure 8-3. Fire-extinguishing Schematic

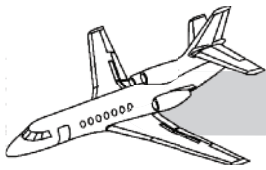

the fuel supply to the engine is cut off so the engine will be stopped by fuel starvation. This effectively stops the fuel from feeding the fire, as well.

Three extinguishers are located above the aft compartment door. Each holds 3 pounds of agent. The precharge pressure on these bottles should be 800 psi.

Each extinguisher has primary responsibility for one engine and is a backup for an additional engine. Under each FIRE PULL HANDLE (Figure 8-2) there is a toggle switch labeled "0, 1, 2." The switches are safety wired to the 0 or normal position. When the wire is broken and the switch moved to position 1, the primary bottle's content is discharged into the engine fire zone. Pulling out and moving the switch up to position 2 fires an additional extinguisher bottle into the same engine.

When the switch is set to position 1, electrical power is supplied by the A or B primary buses. In position 2, battery bus power fires the squib. Therefore, primary bus does not preclude fire-extinguishing capability.

If any bottle is subjected to extreme pressure, the frangible disc on the fuselage disintegrates. The discs are to be checked during the preflight inspection.

APU ZONE FIRE EXTINGUISHING

If the optional APU is installed in the aft compartment, the fire extinguisher is installed with it. It employs a single head and is not used to back up any other extinguisher, nor is the agent from any other extinguisher directed into the APU enclosure. It is controlled by a 0, 1 switch on the fire protection panel. This extinguisher holds 2.2 pounds of agent and also has both the frangible disc and the pressure gage located on the left side of the fuselage. This bottle should be precharged to 360 psi.

BAGGAGE COMPARTMENT AND AFT COMPARTMENT FIRE EXTINGUISHING

Two fire extinguishers are located in the baggage compartment. The RH extinguisher is the only one that is activated when the pilot selects position 1 below the FIRE BAG COMP light. If there is a fire in the aft compartment, the contents of the RH and LH extinguishers are directed into the aft compartment. Each bottle holds 6 pounds of agent and should be precharged to 600 psi.

PORTABLE FIRE EXTINGUISHERS

Two portable extinguishers are installed in the Falcon 50 (Figure 8-4). One, in the cockpit, contains carbon dioxide and can be used to fight any class of fire. In the front of the passenger compartment is a portable water extinguisher which is used for Class A fires only.

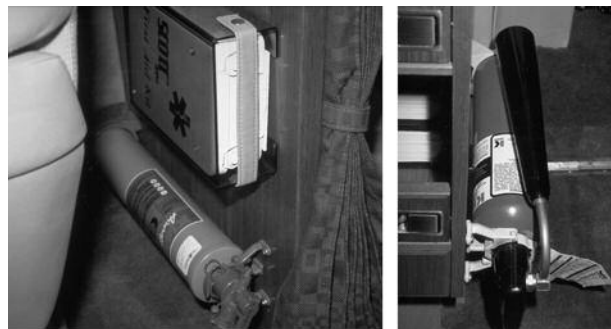
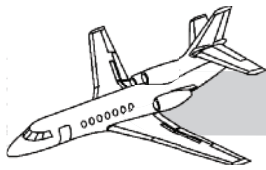

Figure 8-4. Portable Fire Extinguishers



QUESTIONS

1. If the FIRE 1 PULL handle illuminates:
 - A. It automatically activates the fire extinguisher for engine No. 1.
 - B. Pulling the handle cuts off the fuel to No. 1 and activates the fire extinguisher.
 - C. Pulling the handle cuts off fuel to No. 1 engine. Then, the switch below the handle must be moved to 1 or 2 to activate a fire extinguisher.
 - D. It indicates that the No. 1 fire extinguisher has been activated.

2. If the FIRE BAG COMP light illuminates and the switch below it is placed to position 1, what is activated?
 - A. Only the RH extinguisher in the baggage compartment
 - B. Both extinguishers in the baggage compartment
 - C. Either extinguisher may be activated, depending on whether position No. 1 or No. 2 is selected.
 - D. That light is a warning only. There is no fire extinguisher for the baggage compartment.

3. What should the precharge pressure be on the three engine extinguisher bottles?
 - A. 950 psi
 - B. 800 psi
 - C. 600 psi
 - D. 360 psi

4. Activating the TEST button on the fire protection panel tests:
 - A. The three engine fire lights only
 - B. The three engine fire lights and the three compartment fire lights. You cannot test the wheel well lights.
 - C. The three engine fire lights and the aural tone
 - D. All detection and extinguishing loops, all eight lights, and the aural warning tone

5. If an optional APU is installed:
 - A. It is located in the aft compartment and shares the aft compartment fire extinguisher.
 - B. It has its own fire extinguisher and detection loop.
 - C. It is not protected by a fire extinguisher, although there is an over-heat detection loop.
 - D. It will not have a burst disc or pressure gage on the fuselage.

6. What should the precharge pressure be on the two bottles in the baggage compartments?
 - A. 950 psi
 - B. 800 psi
 - C. 600 psi
 - D. 360 psi

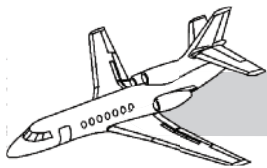

CHAPTER 9 PNEUMATICS

CONTENTS

	Page
INTRODUCTION.....	9-1
GENERAL	9-1
Low-Pressure Bleed-Air System	9-5
High-Pressure Bleed-Air System	9-5
APU Bleed-Air System	9-6
Controls and Indicators	9-6
QUESTIONS.....	9-9

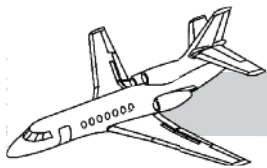

ILLUSTRATIONS

Figure	Title	Page
9-1	Bleed-Air System Overall Diagram	9-2
9-2	Bleed-Air System Controls and Indicators.....	9-7
9-3	Bleed-Air Simplified Flow Diagram.....	9-8

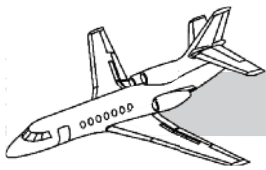

CHAPTER 9

PNEUMATICS



INTRODUCTION

Pneumatics is the use of compressed air to perform certain services on an aircraft. On turbine-powered aircrafts the engines produce an abundance of compressed air; therefore some air may be extracted from the engines for use in the pneumatic systems. This air that is taken from the engines is referred to as bleed air. The Falcon 50 utilizes low-pressure (LP) bleed air and high-pressure (HP) bleed air in its pneumatic systems. Bleed air is used to provide air conditioning, pressurization, airframe anti-icing, nacelle anti-icing, fuel tank pressurization, and hydraulic reservoir pressurization. The APU can also supply bleed air to the main bleed-air system and the secondary HP bleed-air system while the aircraft is on the ground.

GENERAL

The pneumatic systems are subdivided into two groups: main bleed-air system and secondary bleed-air systems. Each engine has three bleed-air ports. Two are LP bleed-air ports located at the 3 o'clock and 9 o'clock positions on the low-pressure case of the engine. The third port is the HP bleed located on the top of the high-pressure compressor case of the engine. All of the bleed-air ports

supply the aircraft's pneumatic systems, except the No. 3 engine's LP port at the 3 o'clock position, which is capped off. Each engine will also supply HP bleed air for its own nacelle anti-icing system. The pneumatic systems of this aircraft will utilize numerous check valves to establish an airflow priority to determine which source will supply the bleed air. These check valves will also naturally prevent reverse flow of air to an engine that may be shut down or running at a lower power setting than the other engines.

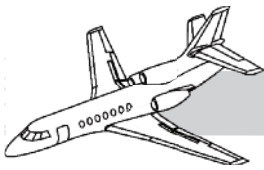

SECONDARY BLEED

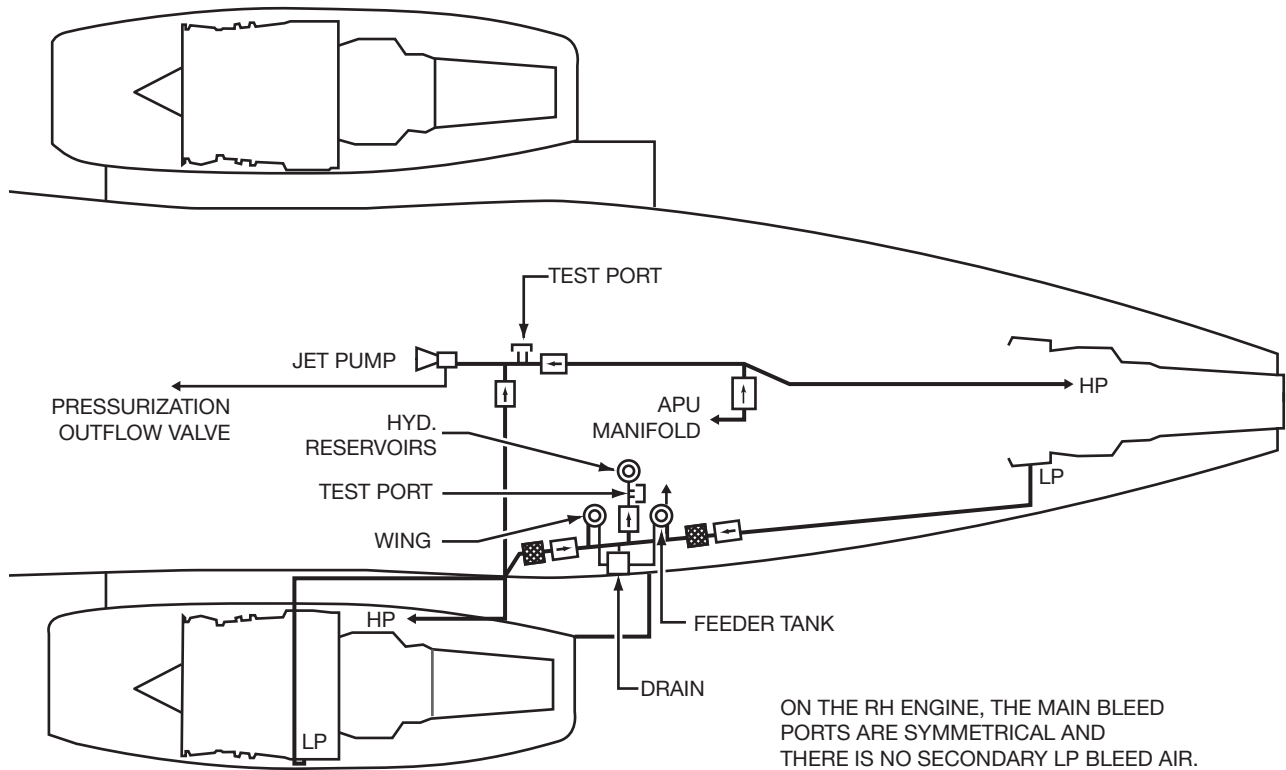

DETAIL C

LEGEND

- | | |
|---|----------------------------|
| CHECK VALVE
(DIRECTION OF ARROWS:
DIRECTION OF AIR) | RESTRICTOR |
| EXPANSION SLEEVE | TEMPERATURE PROBE (SENSOR) |
| HP BLEED AIR | BLEED-AIR CONTROLS |
| LP BLEED AIR | FILTER |
| ON-OFF VALVE | PRESSURE REDUCER |
| PRESSURE REGULATING VALVE | DRAIN |

Figure 9-1. Bleed-Air System Overall Diagram (Sheet 1 of 3)

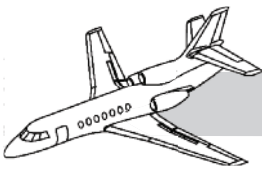

MAIN BLEED

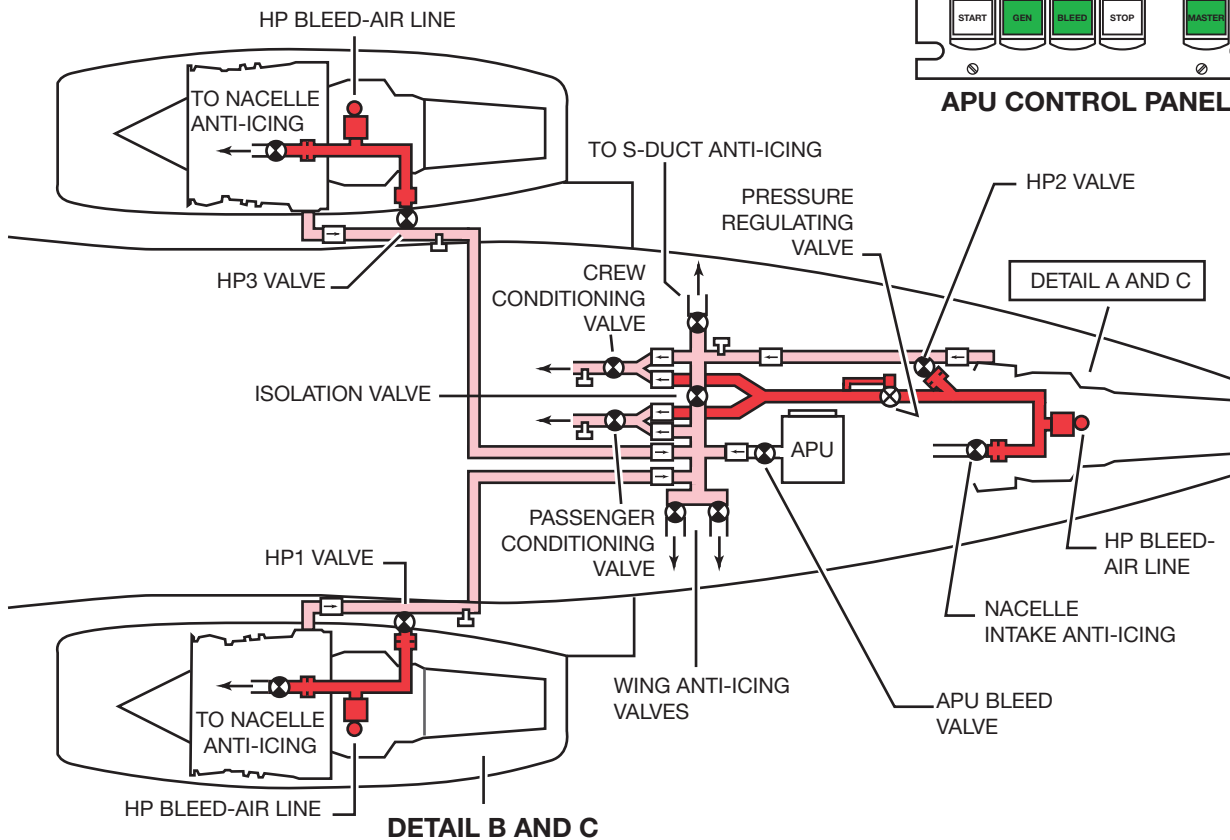
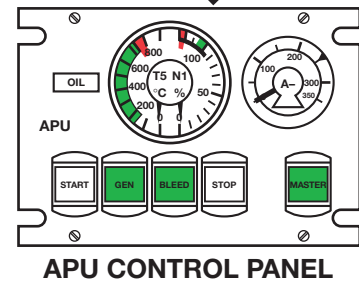
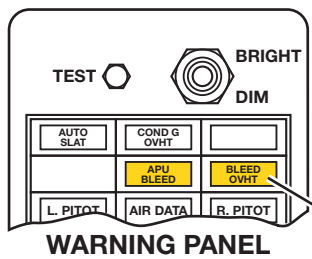
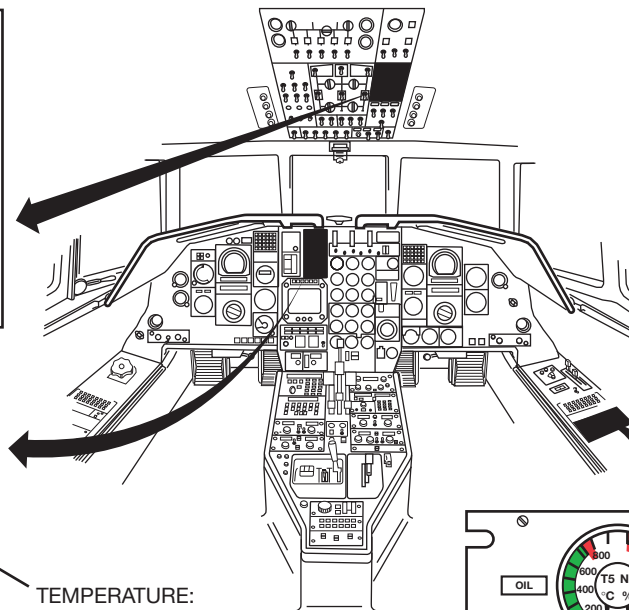
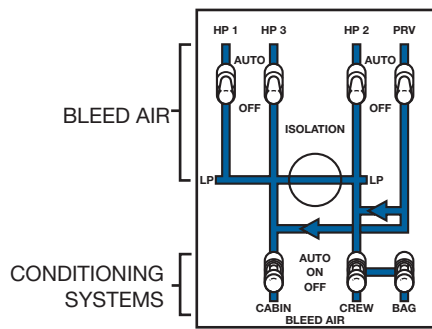

Figure 9-1. Bleed-Air System Overall Diagram (Sheet 2 of 3)

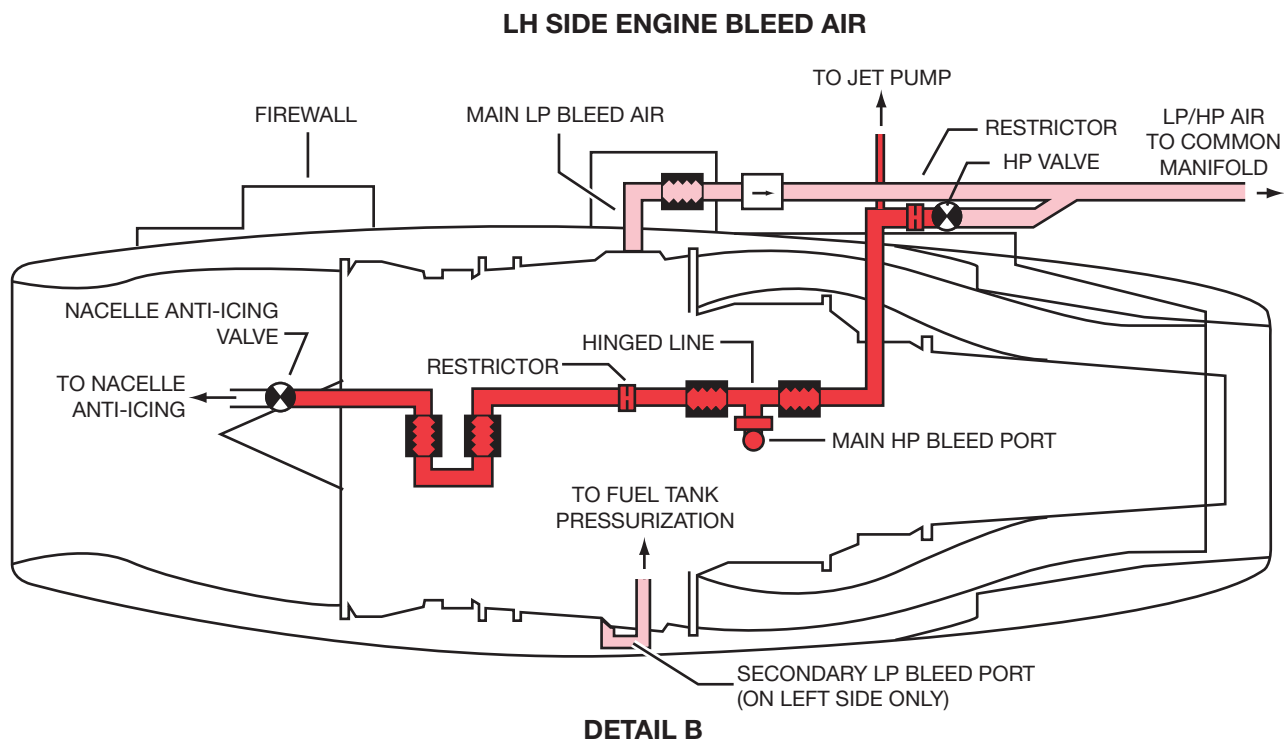
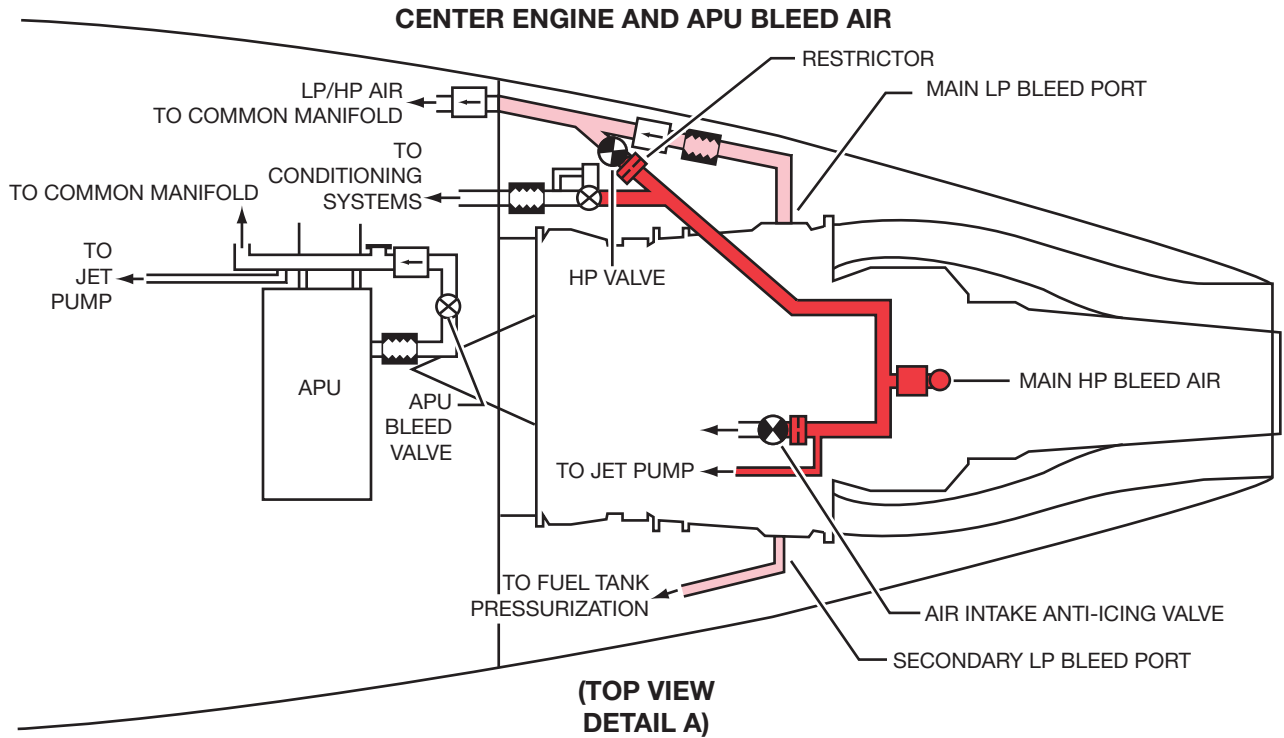
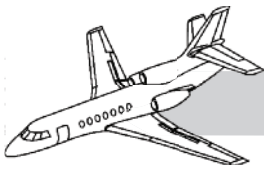
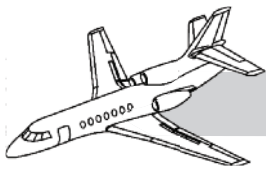

Figure 9-1. Bleed-Air System Overall Diagram (Sheet 3 of 3)



LOW-PRESSURE BLEED-AIR SYSTEM

The LP bleed air is normally supplied by all three engines to the main bleed-air manifold (common manifold). The manifold will in turn supply this compressed air to the air-conditioning system, which will also be used to pressurize the aircraft cabin as well as the baggage compartment and the nose cone. The LP bleed-air port at the 3 o'clock position on engines No. 1 and 2, and the LP port at the 9 o'clock position on No. 3 engine comprise the primary bleed-air sources. LP bleed air is supplied any time the engines are running. The only way to terminate LP airflow from an engine is by shutting down the engine, because there are no shutoff valves that may be closed to shut off the airflow. See Figure 9-1 for an overall diagram of the main bleed-air system.

The secondary LP bleed-air system is supplied low-pressure air from the LP bleed port located at the 9 o'clock position of No. 1 and No. 2 engines only. The secondary LP manifold is supplied bleed air when engines No. 1 and No. 2 are running and ends when they are shut down. The pilot has no switches to control this system as there are no shutoff valves. Pressure regulating valves in this system will regulate the air pressure to the proper level and supply it to the fuel tanks and hydraulic reservoirs. No. 3 engine is not connected to any secondary bleed-air system; therefore it cannot supply air to this system.

HIGH-PRESSURE BLEED-AIR SYSTEM

Under normal conditions, the HP bleed-air system is *not* used. Each engine is equipped with an HP bleed-air valve, which will normally be closed. These valves are controlled by three HP bleed switches on the overhead control panel. The switches have two positions: OFF and AUTO. They should normally be placed in the AUTO position so that the HP bleed valves will open automatically when the anti-ice systems are selected to ON. When the pilot switches the anti-icing systems to ON, the HP

valves open and the common manifold is now pressurized to HP level. At this time, the check valve in the LP bleed line at the LP case of the engine goes closed and thereby shuts off LP airflow from the engine and prevents reverse flow of HP air to the LP port.

As shown in Figure 9-1 (details A, B, and C), the HP bleed-air lines tee into the LP bleed-air lines, but are normally isolated from the bleed-air system by an HP valve at each engine. As previously stated, each HP valve is controlled by a switch on the overhead panel located in the pneumatic section, and is normally placed in the AUTO position. These switches are labeled HP 1, HP 2, and HP 3. The AUTO position of the HP switch will normally have the valve closed, but will automatically open when the pilot switches the airframe and No. 2 engine anti-icing systems on.

The HP bleed valves work as follows: when airframe anti-ice is selected to ON, HP bleed valves 1 and 3 will open to supply high-pressure bleed air from engines 1 and 3 to the common manifold near the airframe valve(s). Since the manifold is normally common to all systems, the whole manifold becomes high pressure at this time. The airframe anti-ice valve(s) are located on the left side of the common manifold so the airframe anti-ice system can now receive HP bleed air to heat the wing leading edges.

When No. 2 engine anti-icing is selected to ON, the HP 2 valve opens and supplies high-pressure bleed air from No. 2 engine to the right side of the manifold. Since the No. 2 engine S-duct anti-ice valve receives air from the right side of the manifold and the valve is now open, HP bleed air now flows to the S-duct heater to keep ice out of the No. 2 engine air intake S duct.

NOTE

No. 1 and No. 3 engine anti-ice operation has no effect on the HP bleed-air valves.

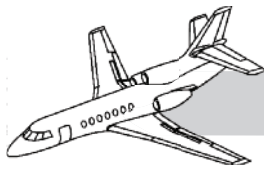

A pressure regulating valve (PRV) is installed in the No. 2 engine HP bleed-air system. The purpose of the PRV is to reduce No. 2 engine HP bleed air down to LP level and supply it to the air-conditioning system when the engines are at too low a power setting to support the operation of the air-conditioning systems. This is the only function of the PRV. The PRV cannot supply any air to the common manifold. When the engines are powered up to a level where the manifold pressure is greater than the PRV output, the PRV will close and the manifold will then automatically start supplying air to the air-conditioning systems. When No. 2 engine anti-ice is switched on, the HP 2 valve will open, as previously mentioned, but the PRV will close if it is open. The PRV is controlled by a switch in the pneumatic portion of the overhead panel. This switch also has two positions: OFF and AUTO. The switch should normally be selected to AUTO. In this position, the PRV will automatically perform its designed function of supplying regulated air pressure to the air-conditioning systems when the engines are at low power settings. When the PRV is open and regulating air to the air-conditioning systems, the No. 2 engine ITT will run higher than engines No. 1 and No. 3.

NOTE

If the No. 2 engine runs hotter than the No. 1 and No. 3 engines when taxiing the aircraft and while the PRV is operating, the PRV switch may be placed to the OFF position in order to equalize engine temperatures/or check No. 2 Engine A/I.

Finally, engines No. 1 and No. 2 will also supply HP bleed air to the secondary HP bleed-air manifold. Again, the pilot has no switches to control this system. The secondary HP bleed-air manifold will be supplied HP air when No. 1 and No. 2 engines are running and airflow to the manifold will stop when engines No. 1 and No. 2 are shut down. The HP air supplied to the manifold is jetted through a venturi tube to produce a negative pressure to control the outflow valves in the cabin pres-

surization system. The APU can also supply air to the secondary HP bleed-air manifold when in operation and the APU bleed switch is selected to ON. When the aircraft is on the ground, the negative pressure signal supplied by the jet pump will open the outflow valves and keep the cabin from pressurizing. This signal will also be used in flight to control cabin pressurization (refer to Chapter 12, "Pressurization").

APU BLEED-AIR SYSTEM

The APU may be used as a pneumatic source for the common manifold while on the ground if the APU speed is equal to or greater than 95% and if all of the engine thrust levers are positioned below 54° PLA (see Figure 9-1, detail A). When the aircraft is on the ground, the APU provides sufficient bleed air to operate the air-conditioning system.

NOTE

APU bleed air should *never* be used when the anti-ice systems are in use.

Refer to Figure 9-2 for an illustration of the APU bleed-air system indications and controls.

CONTROLS AND INDICATORS

The controls and indicators (Figure 9-2) for the bleed-air system are located on the master warning panel, APU control panel, and the overhead panel.

The BLEED OVHT and the APU BLEED warning lights are found on the master warning panel. The BLEED OVHT warning light illuminates if any one of the five temperature switches senses an excessive bleed-air temperature (300°C–323°C). If this light illuminates when the anti-icing systems are not operating, the PRV is usually the problem. Under this situation, the pilot should position the PRV switch to OFF.

If the BLEED OVHT warning light is on, the PRV switch and the HP bleed switches should

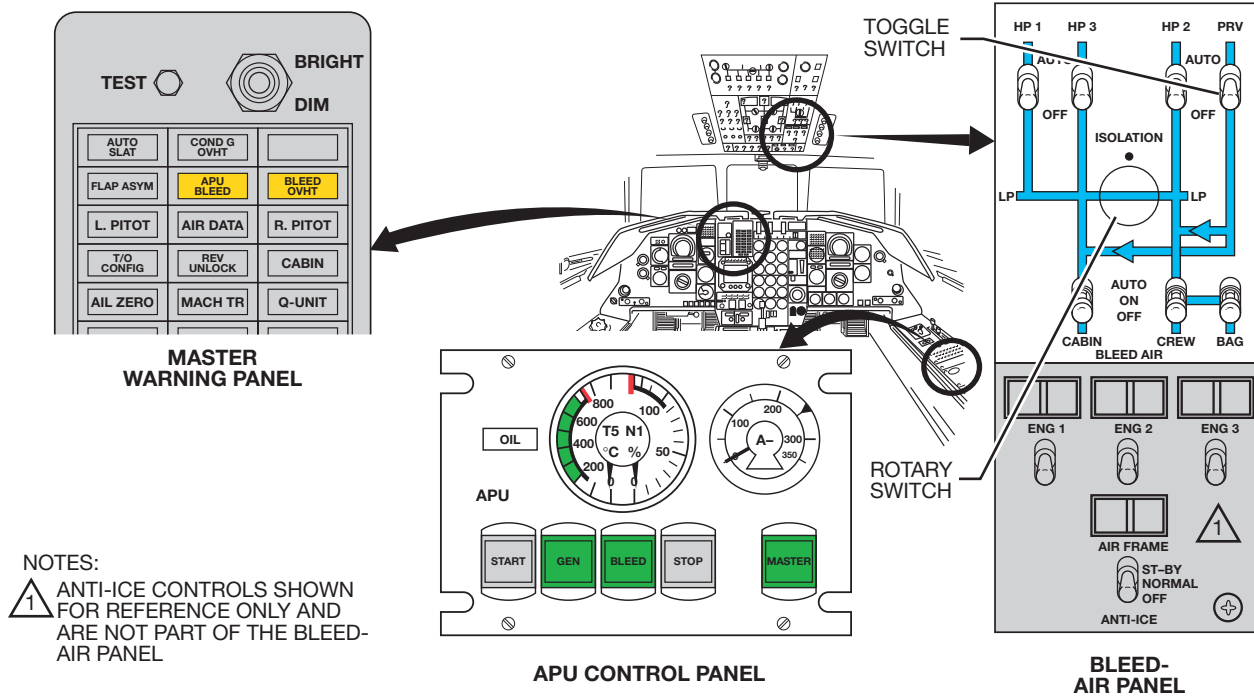
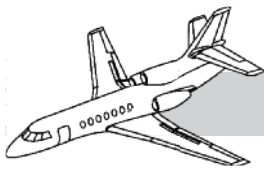

Figure 9-2. Bleed-Air System Controls and Indicators

be selected of OFF (one at a time). When the correct switch is selected to OFF, the BLEED OVHT light will *flash*. When the light flashes, leave that switch in the OFF position and follow checklist procedures.

The APU control panel has an internally illuminated switch to control the APU bleed valve. Depressing the switch will cause it to illuminate green and at the same time open the bleed valve (see Figure 9-1, detail A) to supply APU bleed air to the common manifold and the jet pump (see Figure 9-1, detail C). Depressing the switch again will extinguish the green light in the switch and close the APU bleed valve, thus terminating the APU bleed-air supply. With the APU bleed switch on, if any engine thrust lever is advanced above 54° PLA, the bleed valve will automatically close until the thrust lever is retarded below 54° PLA again. Refer to Chapter 6, “Auxiliary Power Unit,” for more information on the APU operation.

The APU BLEED warning light illuminates if the APU bleed valve is open when it should be

closed. An example of this would be when the APU bleed switch is set to the OFF position but the bleed valve remained open. Another example would be when an engine thrust lever is positioned above 54° PLA and the APU bleed valve remains open.

NOTE

There is a four-second time delay before this light will illuminate from the time the command to close is received.

The engine HP bleed-air switches are located on the overhead panel on the center right side. This portion of the overhead panel, where these switches are located, has a blue schematic of the bleed-air system painted on the surface. This schematic is a simplified, yet accurate, representation of the system. Across the top of the schematic are four, two-position toggle switches, one for each of the three HP valves and the fourth for the PRV. They are la-

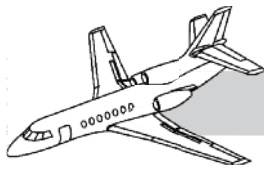

beled HP 1, HP 3, HP 2, and PRV (reading from left to right). Each switch has an AUTO and an OFF position. In the AUTO position, these switches control their respective valve as described previously. In the OFF position, the respective valve will be closed. Across the bottom of the schematic are three more toggle switches that control airflow to the cabin, cockpit (nose cone), and baggage compartment. These switches are labeled CABIN, CREW, and BAG. The CABIN and CREW switches have three positions: OFF, ON, and AUTO. Conditioned air is supplied to the cabin and cockpit with these switches in the AUTO position, if the aircraft is on the ground with the thrust levers below 54° PLA. In flight, with the switches in the AUTO position, the motor-operated conditioning valves will be open and supplying air to the cabin and cockpit regardless of thrust lever positions. In the ON position, the air-conditioning valves will be open under all conditions and provide an uninterrupted airflow to the compartments. With the switches in the OFF position, airflow is shut off to the compartments. The BAG switch, though not labeled, has two positions: OFF and ON. When the switch is placed in the ON position, a valve on the rear pressure bulk-head will open, allowing air to flow from the cabin through a tube to the baggage compartment to pressurize it with cabin air.

In the center of the bleed-air schematic is a rotary ISOLATION switch. The rotary selector switch controls a motor-operated ISOLATION valve in the common manifold. This valve is used for three situations: unwanted airframe anti-ice operation, unwanted No. 2 engine anti-ice operation, or air-conditioning smoke. When performing those procedures, the rotary selector switch should be placed to the ISOLATION position to close the valve. This will divide the common manifold into two sections, left and right (Figure 9-3).

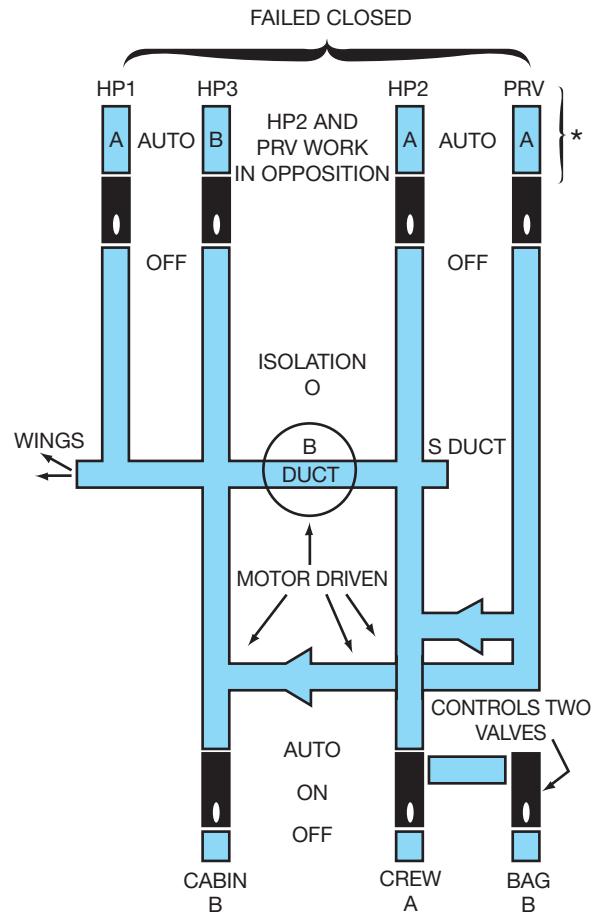

* MOST TROUBLE-PRONE. SUPPLEMENTS AIR-CONDITIONING BLEED-AIR REQUIREMENTS.

NOTE

NO. 2 ENGINE RUNS HOTTER THAN NO. 1 AND NO. 3 WHEN TAXIING AND WHEN PRV FUNCTIONS. TURN OFF PRV WHEN TAXIING.

Figure 9-3. Bleed-Air Simplified Flow Diagram

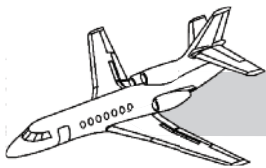

QUESTIONS

1. What system(s) does not get bleed air from the common manifold?
 - A. Engine anti-icing and air conditioning
 - B. Pressurization and air conditioning
 - C. Nacelle anti-icing
 - D. Door seal and S-duct anti-icing
2. When do HP 1 and HP 3 bleed-air valves open?
 - A. When the airframe anti-ice is initiated
 - B. When the air-conditioning system is operating
 - C. When the aircraft becomes airborne
 - D. During emergency pressurization operation
3. When does the HP 2 bleed-air valve open?
 - A. When the airframe anti-ice is initiated
 - B. When the air-conditioning system is operating
 - C. When the aircraft becomes airborne
 - D. When No. 2 engine anti-ice is initiated
4. What is the purpose of the PRV?
 - A. Provide air to the air-conditioning systems when the engines are at low power
 - B. Supply regulated bleed air to the common manifold under all conditions
 - C. Supply regulated bleed air to the secondary LP bleed-air manifold
 - D. Supply regulated bleed air to the secondary HP bleed-air manifold
5. The PRV is used with what systems?
 - A. Pressurization system only
 - B. Airframe and S-duct anti-icing systems
 - C. APU bleed-air regulating system
 - D. Air-conditioning and pressurization systems
6. What indication does the pilot receive when one of the five temperature switches senses excessive bleed-air temperatures in the bleed-air system?
 - A. PRV fail light illuminates
 - B. BLEED OVHT light illuminates
 - C. BLEED OVTEMP light illuminates
 - D. DUCT OVTEMP light illuminates
7. When the BLEED OVHT light illuminates, how does the pilot determine what caused the overheat condition?
 - A. Switching OFF the APU bleed air
 - B. Switching OFF the PRV and HP switches one at a time
 - C. Switching OFF the airframe anti-ice system
 - D. Switching OFF the No. 2 engine anti-ice system
8. When the proper switch is selected to OFF, in the previous question, how will the pilot know it is the one that is the cause of the overheat condition?
 - A. The APU bleed light will extinguish.
 - B. The APU bleed light will flash.
 - C. The PRV bleed light will extinguish.
 - D. The BLEED OVHT light will flash.

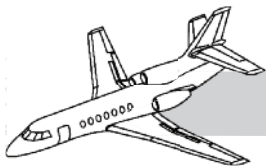

CHAPTER 10

ICE AND RAIN PROTECTION

CONTENTS

	Page
INTRODUCTION.....	10-1
GENERAL.....	10-3
Engine Anti-Icing	10-3
Wing Leading Edge Anti-Icing	10-5
Pitot-Static Anti-Icing	10-6
Windshield Anti-Icing and Demisting	10-7
Side Window Anti-Icing and Demisting	10-7
Interior Windshield Demisting (SNs Prior to 80)	10-8
Windshield Wipers	10-8
CONTROLS AND INDICATORS	10-9
Engine Anti-Icing	10-9
Leading-Edge Anti-Icing.....	10-10
Pitot-Static Anti-Icing	10-12
Windshield and Side Window Anti-Icing and Demisting.....	10-12
Interior Windshield Demisting.....	10-13
Windshield Wipers	10-14
LIMITATIONS	10-14
QUESTIONS	10-15

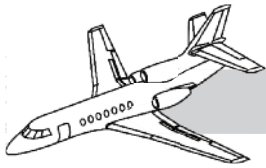

ILLUSTRATIONS

Figure	Title	Page
10-1	Ice and Rain Protection	10-2
10-2	Anti-icing Solenoid Controls.....	10-3
10-3	No.1 Engine Anti-icing (with SB 87).....	10-4
10-4	No. 2 Engine Anti-icing (with SB 87).....	10-4
10-5	Wing Leading-Edge Anti-icing	10-5
10-6	Leading-Edge Anti-icing (Before S/B 225)	10-5
10-7	Pitot-Static Anti-icing.....	10-6
10-8	Windshield and Side Window Anti-icing and Demisting	10-7
10-9	Interior Windshield Demisting (SNs Prior to 80)	10-8
10-10	Windshield Wipers.....	10-8
10-11	Controls and Indicators—Leading-edge Anti-icing	10-10
10-12	Controls and Indicators—Pitot-static Anti-icing.....	10-12
10-13	Controls and Indicators—Windshield and Side Window Anti-icing and Demisting	10-13
10-14	Controls and Indicators—Interior Windshield Demisting	10-13
10-15	Controls and Indicators—Windshield Wipers.....	10-14

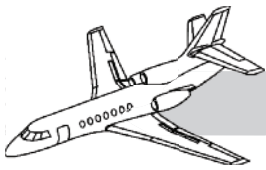

CHAPTER 10

ICE AND RAIN PROTECTION



INTRODUCTION

The ice and rain protection system as shown in Figure 10-1 contains two types of systems: those that use engine bleed air and those that use electrical power for operation. Engine bleed air supplies the engine nacelles, and wing leading edges with hot air to prevent the formation of ice. Electrical elements are used to heat the pitot-static system, OAT probe, AOA transmitter, engine P_{T2} and T_{T2} probes. In addition, windshield demisting and the windshield wipers are electrically powered.

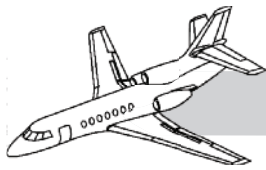

FALCON 50 PILOT TRAINING MANUAL

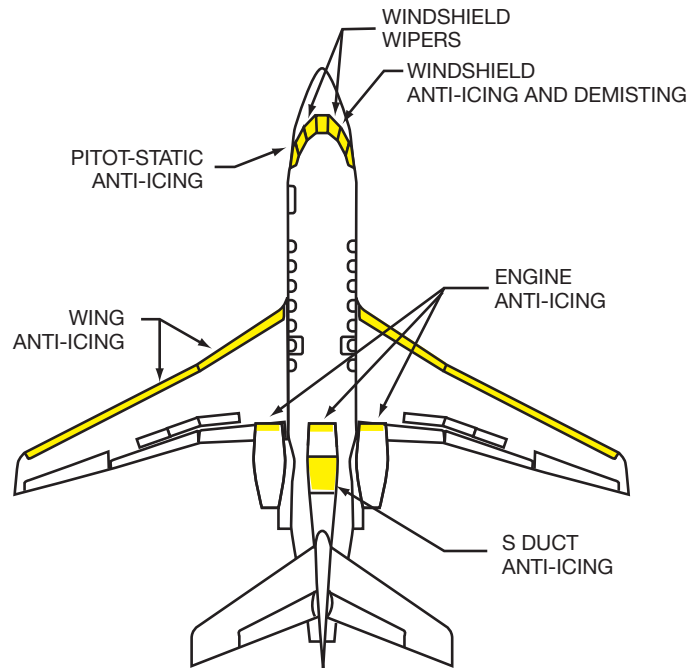

OVERHEAD PANEL

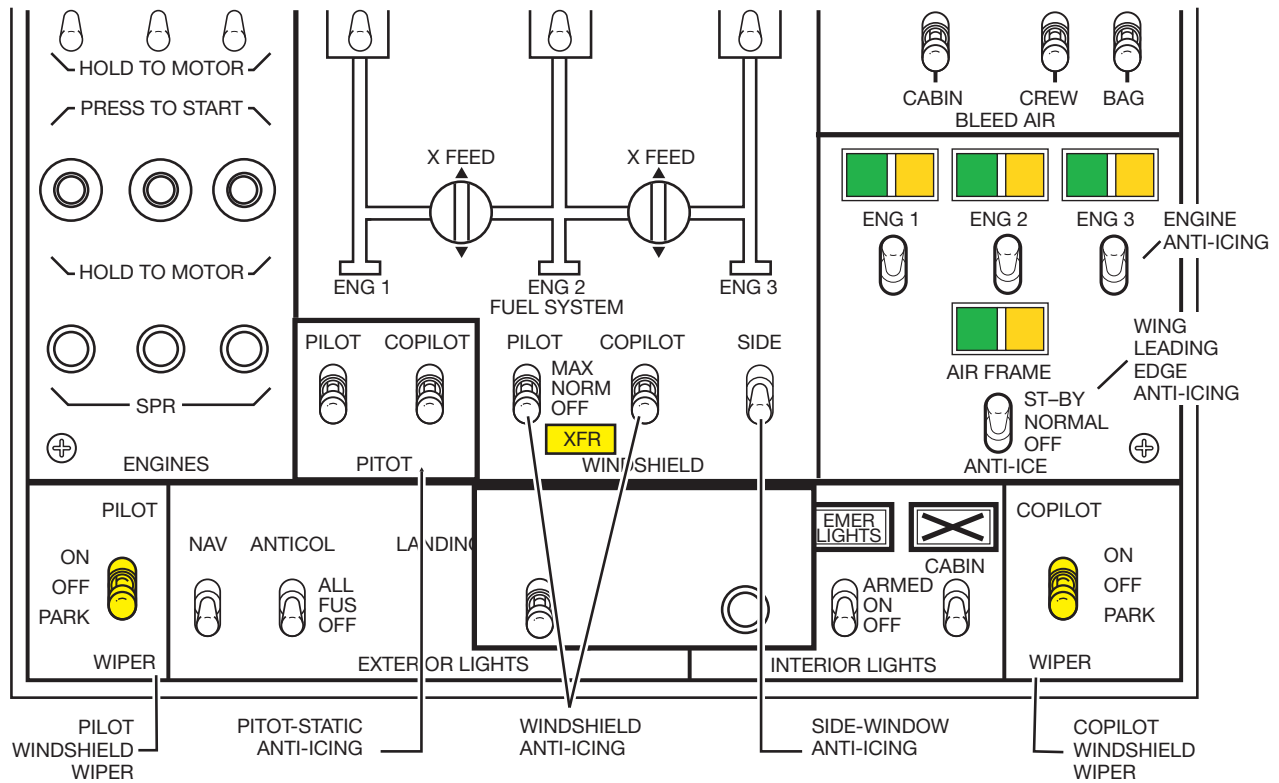
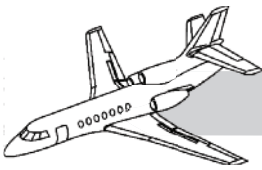

Figure 10-1. Ice and Rain Protection



GENERAL

ENGINE ANTI-ICING

The engine anti-icing system uses air from the bleed air system to protect the engine from ice formation on exposed components.

Anti-icing protection is provided for the nacelles for all three engines. In addition, the S-duct leading to the No. 2 engine is heated pneumatically to prevent ice formation in critical areas of the duct (Figure 10-2). High-pressure bleed air is used to anti-ice the fan cones

and the nacelles. This air is taken directly from a high-pressure bleed air port on each engine (Figure 10-3 and 10-4).

The fan cones are not anti-iced if SB 87 is incorporated (conical spinners).

High-pressure bleed air is used to anti-ice the S-duct area on the No. 2 engine. This air is taken from a common bleed air manifold. When the isolation valve (Figure 10-4) is in its normal open position, air used to anti-ice the S-duct is supplied by all engines. If the isolation valve is closed, the air comes from No. 2 HP bleed port only.

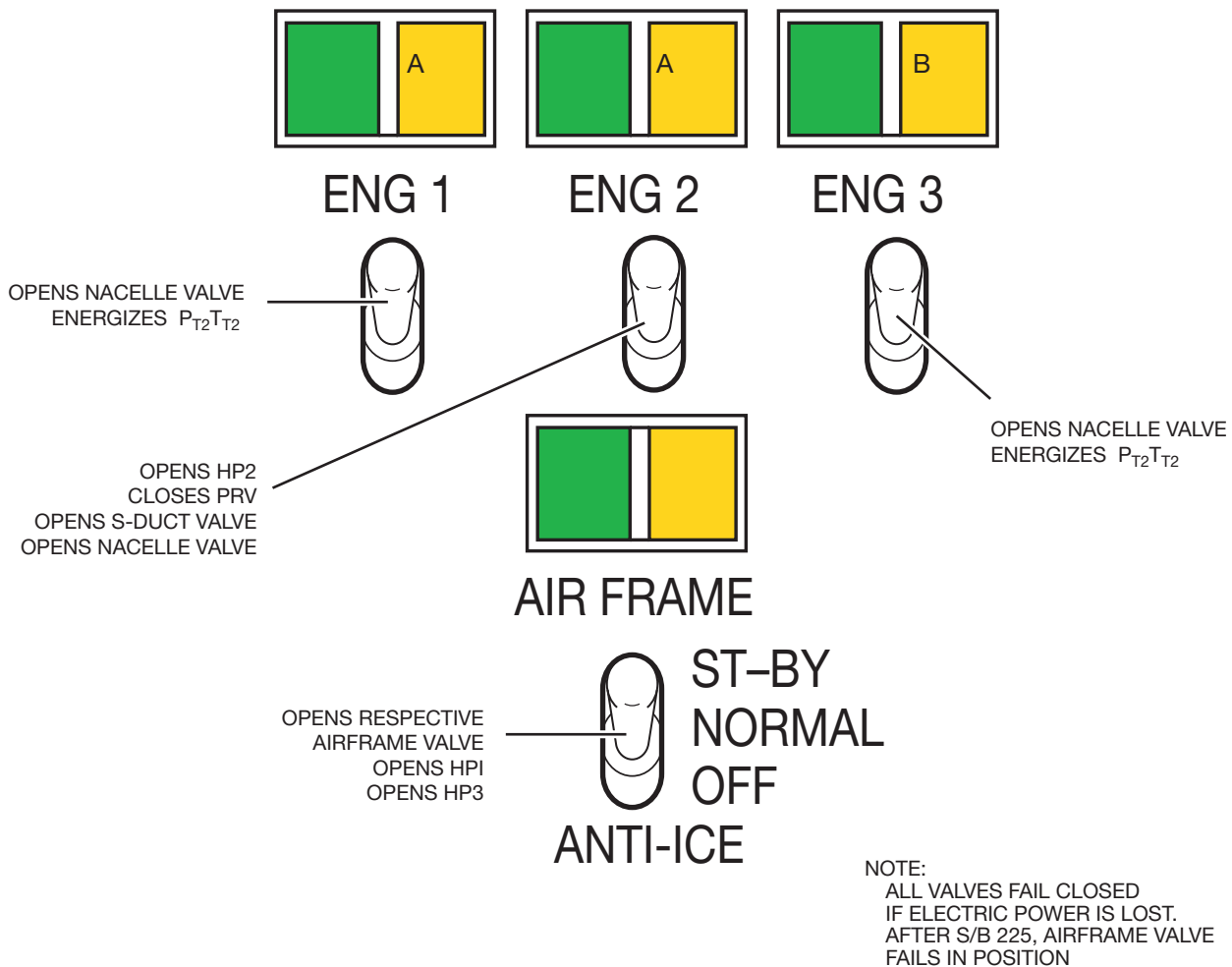

Figure 10-2. Anti-icing Solenoid Controls

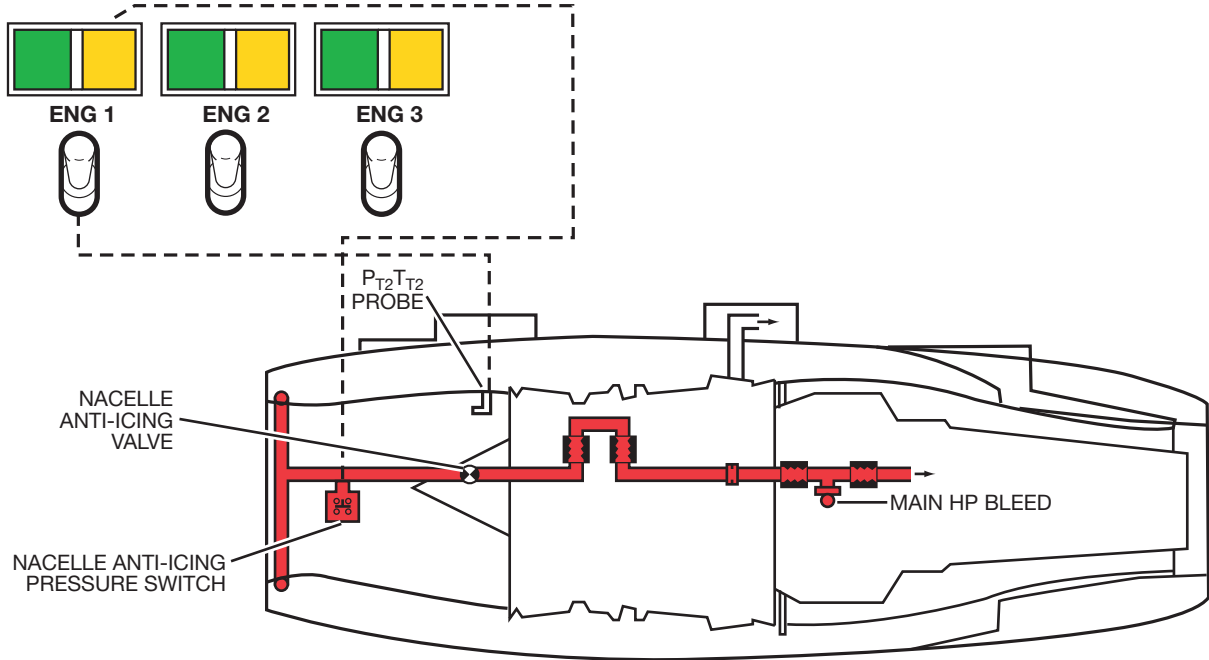
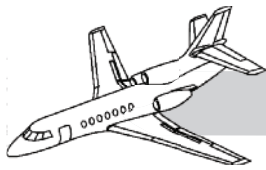

Figure 10-3. No. 1 Engine Anti-icing (with SB 87)

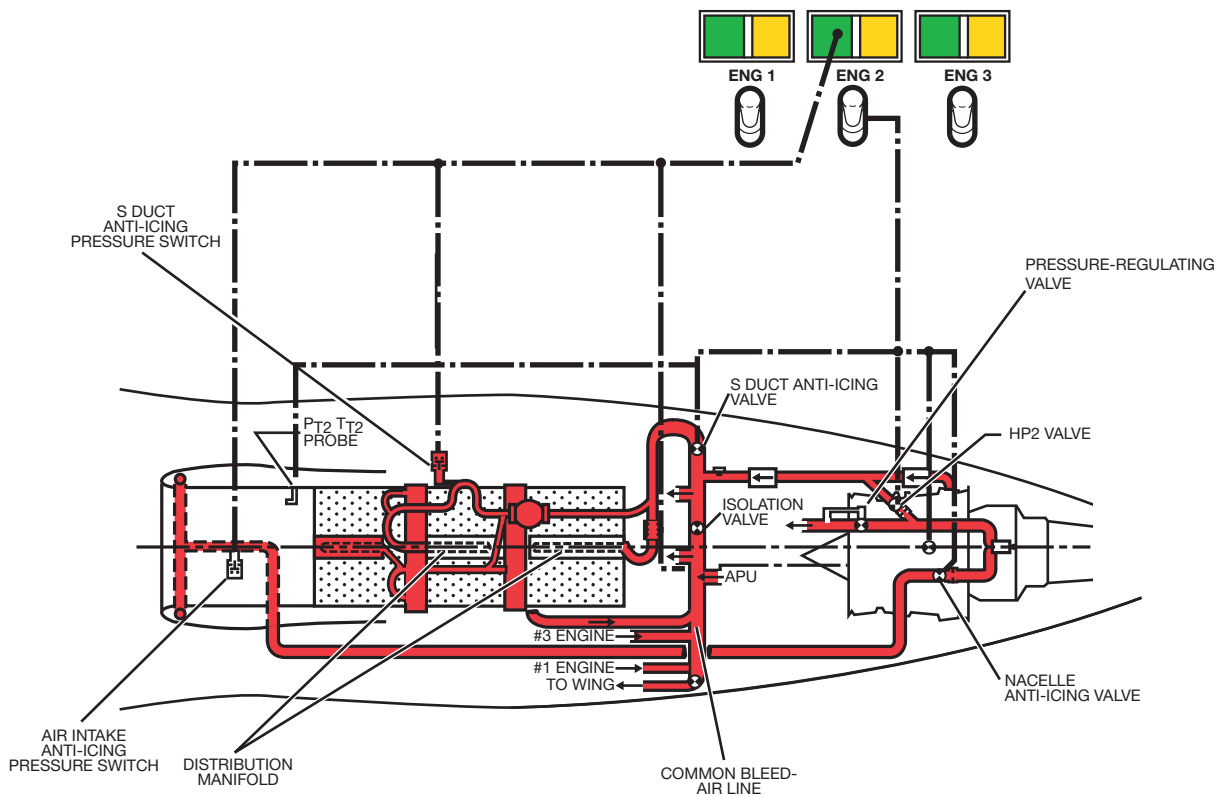
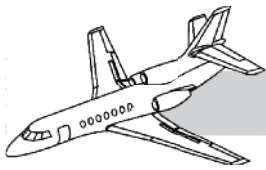

Figure 10-4. No. 2 Engine Anti-icing (with SB 87)



WING LEADING EDGE ANTI-ICING

The wing leading-edge anti-icing system (Figure 10-5) also uses hot bleed air to heat the leading edge of the wing to prevent ice formation. The empennage is not anti-iced.

Both the inboard and outboard slats are heated when either extended or retracted (Figure 10-6). High-pressure bleed air flows to the inboard and outboard slat manifolds. Telescopic tubes allow the flow to continue regardless of whether the slats are in the retracted or extended position.

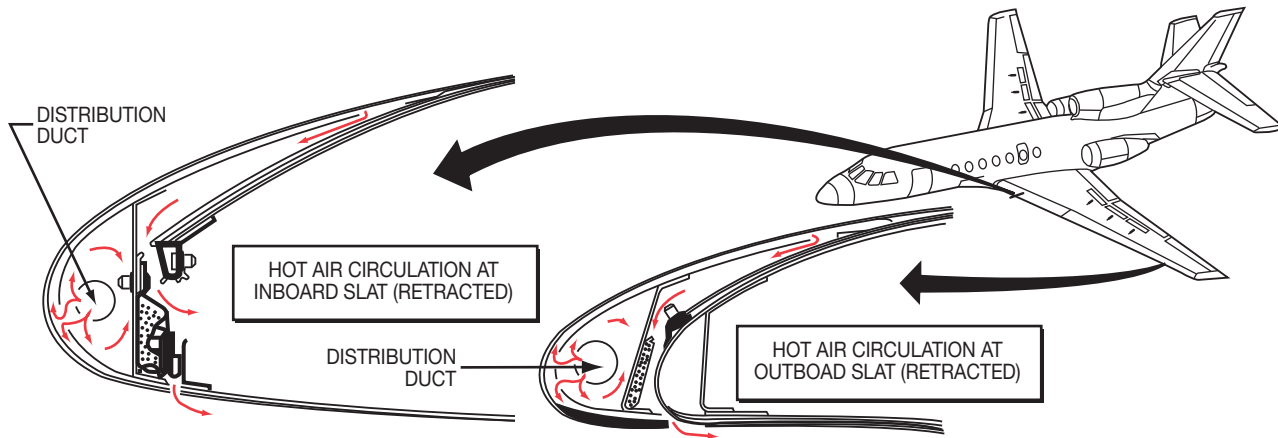

Figure 10-5. Wing Leading-Edge Anti-icing

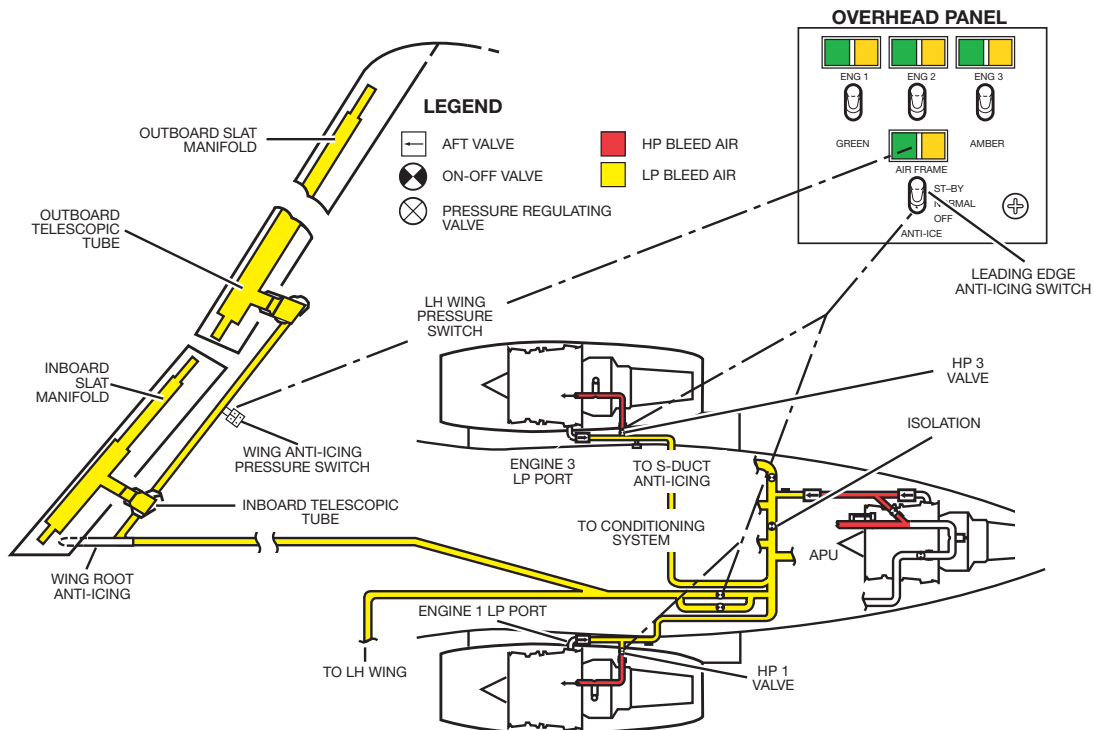
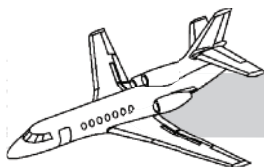

Figure 10-6. Leading-Edge Anti-icing (Before SB 225)



Hot bleed air also is routed to anti-ice the wing root area, which is uncovered when the inboard slat is extended. This air is ducted into the space between the fixed leading-edge skin and the internal shroud.

The airframe anti-icing system is not designed as a deicing system. The system should be turned on prior to entering visible moisture whenever the total air temperature is $+10^{\circ}\text{C}$ or below. In addition, the system must not be in use when total air temperature is more than $+10^{\circ}\text{C}$.

Icing conditions are indicated by ice formation on the areas around the windshield panes that are not anti-iced. During night operations, a small spotlight illuminates the lower right corner of the left windshield panel. The light is controlled by the NAV switch on the overhead panel.

If activation of the anti-icing system is delayed until after entering icing conditions, care must be taken when activating the system. If ice accumulates in the air intake or on the slats, turning on the anti-icing system causes lumps of ice to melt off and be ingested by the engines.

S/B 225: Modified System for Ground Operation Detection

Service bulletin 225 applies to aircraft with modification F50-M1844.

On the ground, hot airflow in the slat anti-icing system from inadvertent actuation or a valve air leak—from the normal system, standby system, or both—may cause slat damage.

The service bulletin replaces the two existing valves with one valve. Technicians discard the Y-pipe downstream of the old valves and cap the bypass branch on the Y-pipe. They then install a new valve between two new pipes on the normal anti-icing system.

The original control on the overhead panel remains. The NORMAL and ST-BY positions retain the same functions: the valve opening order is set through the B bus bar (NORMAL) or C bus bar (ST-BY). However, technicians replace the ANTI ICE switch; the new switch has a pull-to-unlock OFF position. The new switch requires modification or replacement of the CLAROPAN panel.

After accomplishing the service bulletin, the new valve energizes a buzzer in the cockpit 30 seconds after the crew activates the slat anti-icing system on the ground.

PITOT-STATIC ANTI-ICING

Anti-icing of the pitot-static system (Figure 10-7) is accomplished electrically. Two separate 28-VDC power circuits, one from the primary 28-VDC A bus and one from the 28-VDC auxiliary D bus, are used for the anti-icing system.

The pilot circuit powers the heating elements in the left-hand and right-hand static ports, the left-hand pitot head, the total ambient temperature probe, and the left-hand stall vane.

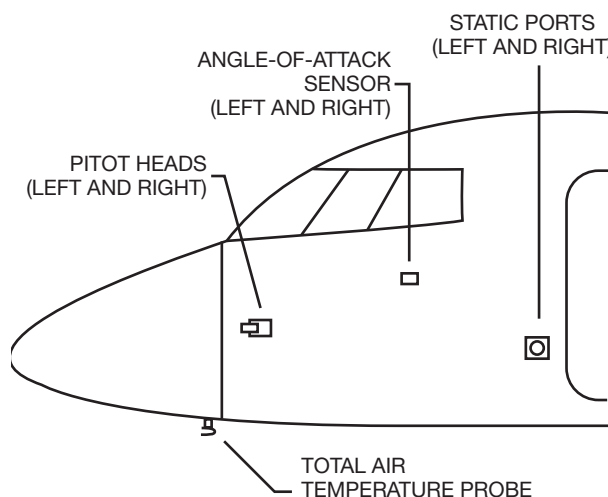
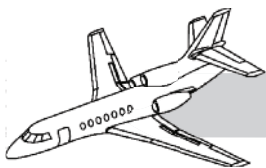

Figure 10-7. Pitot-Static Anti-icing



The copilot circuit heats the left-hand and right-hand static ports, the right-hand pitot head, and the right-hand stall vane. Note that the static ports are heated by power from both the pilot and copilot circuits.

WINDSHIELD ANTI-ICING AND DEMISTING

The pilot, copilot, and center windshield panels (Figure 10-8) are anti-iced and demisted electrically by a heating network which is integral to each panel. The network is installed between the two outer layers of the windshield.

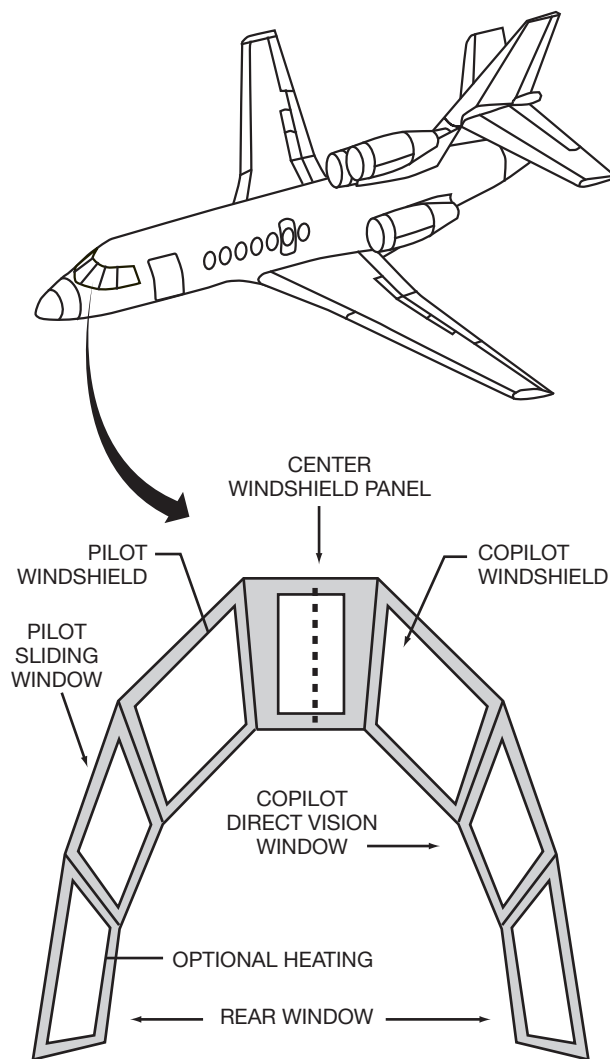

Figure 10-8. Windshield and Side Window Anti-icing and Demisting

Two separate electrical circuits power the windshield anti-icing networks. The left-hand main bus powers the pilot windshield and the left half of the center windshield. Right-hand main bus power is used to heat the copilot windshield and right half of the center windshield.

Control power for the pilot system is provided by primary bus A while secondary bus D powers the control circuits for the copilot system.

Probes embedded in the pilot and copilot windshields control the temperature in each set of windshields in conjunction with a pair of regulators. The windshield heater power is automatically cycled between 77°F and 86°F with the control switches in normal or maximum position. Should one of the probes fail, control of both sets of windshields is automatically transferred to the other probe and regulator and a transfer light (XFR) comes on.

SIDE WINDOW ANTI-ICING AND DEMISTING

The side windows are not normally subject to icing due to their position with regard to the airflow. However, mist formation due to extreme temperature changes is likely. For this reason, the side windows are electrically heated. The heating system operates very much like the windshield anti-icing system. Note, however, that electrical demisting of the aft left window is optional (option 30-45-10).

As with the windshield anti-icing system, there are two independent temperature regulators which control two separate circuits. The temperature regulators operate much like the windshield regulators except that no transfer function exists.

If the aft left window is heated (option 30-45-10), the window has a regulator connected to its own temperature probe. In such cases, the heating relays for the aft side windows are wired in series. As a result, the aft windows are not heated until both regulators simultaneously command heating. One regulator is used for the sliding pilot and copilot direct-view A bus. Another regulator is used for the aft right-hand window load shed.

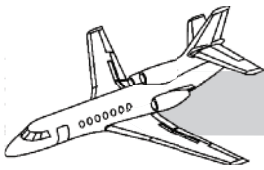

INTERIOR WINDSHIELD DEMISTING (SNS PRIOR TO 80)

The interior surface of the three front windshields may be demisted by air supplied through distribution manifolds in the glareshield. The air is supplied by a blower located below the instrument panel and forward of the pedestal as shown in Figure 10-9. The air is warmed by a heating resistor when the blower is operated at high speed

WINDSHIELD WIPERS

The aircraft is equipped with a pair of conventional, motor-driven windshield wipers (Figure 10-10). When not in use, the single-speed wipers are in the park position. In this position, they are stowed in recesses below the pilot and copilot windshields.

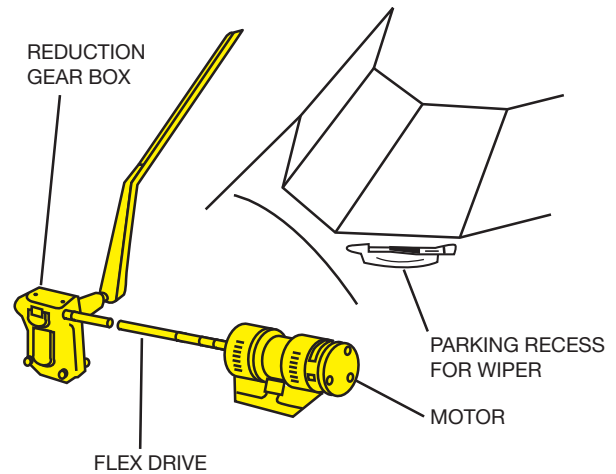

Figure 10-10. Windshield Wipers

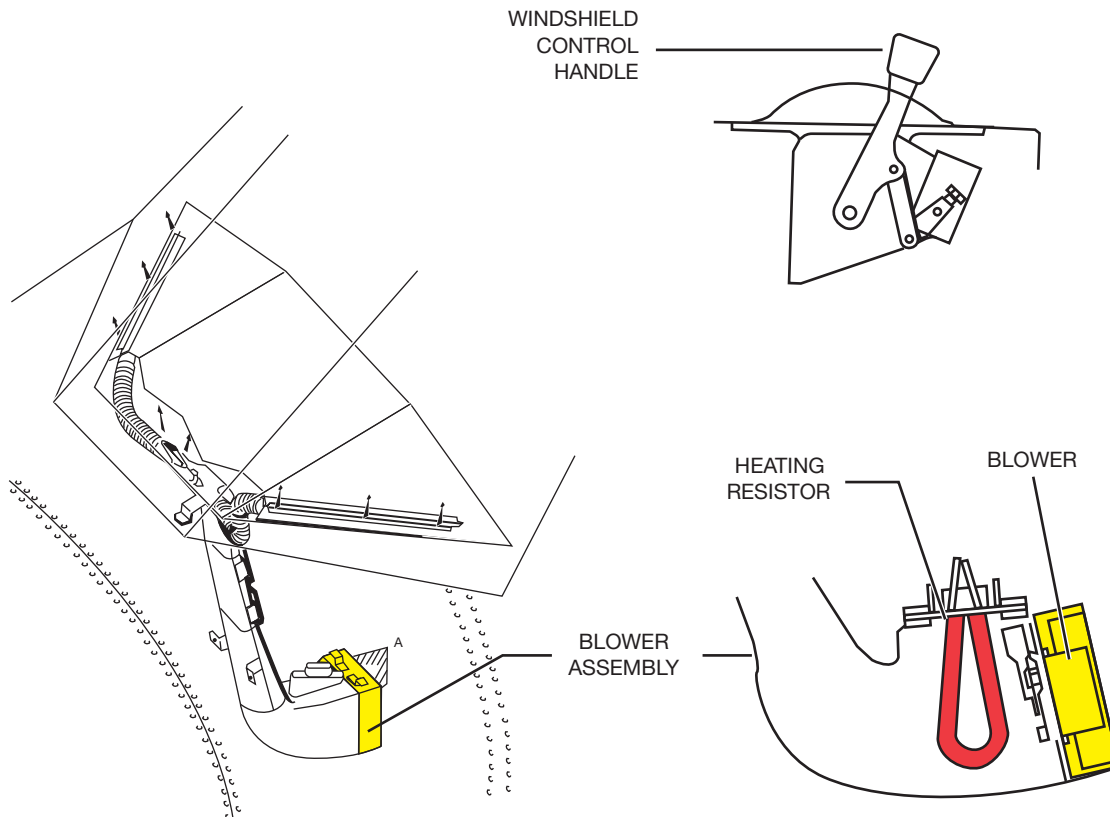
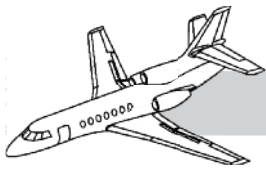

Figure 10-9. Interior Windshield Demisting (SNs Prior to 80)



CONTROLS AND INDICATORS

ENGINE ANTI-ICING

The powerplant anti-icing is controlled by three switches on the overhead panel. The switches are marked ENG 1, ENG 2, and ENG 3, as shown on Figure 10-2.

ENG 1 and ENG 3 switches each control one valve (see Figure 10-2). The valve supplies air to the nacelle inlet lip. All the engines now have SB 87 (conical spinner), and the spinners are not heated. The P_{T2} T_{T2} probes are electrically heated when the engine anti-ice switches are on.

The ENG 2 switch controls four valves (see Figure 10-3). When the anti-icing system for the No. 2 engine is turned on, the following valves are affected:

1. The nacelle anti-icing valve opens, allowing high-pressure bleed air to anti-ice the nacelle area.
2. The S-duct anti-icing valve opens, allowing a mixture of high-pressure and low-pressure bleed air to heat the S-duct.

If the HP2 and PRV switches are in their normal auto position:

3. The HP2 valve on No. 2 engine opens, allowing high-pressure bleed air to flow to the common bleed-air line.
4. The PRV valve closes. This reduces air-flow from No. 2 engine to the environmental control units and ensures an adequate air supply for No. 2 engine anti-icing.

A dual amber-green light is located above each engine anti-ice switch. The lights are controlled by pressure switches connected for each engine and are located in the nacelle and the S-duct supply lines.

If a switch is turned on and the amber section

of the lights comes on and remains on, it indicates that either the nacelle, the engine, or in the case of No. 2 engine, the S-duct valve, failed to open. If the green light comes on, it indicates that all associated valves are open. When an engine anti-ice switch is first turned on, the amber light blinks on and off as the green light comes on. This is a normal indication.

If the amber light remains on when a switch is turned off, valve failure or a pressure switch malfunction may be indicated. At low engine rpm, the amber light may be on until the power level is increased.

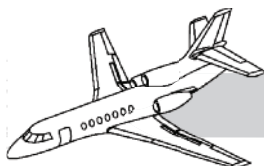

LEADING-EDGE ANTI-ICING

The leading-edge anti-icing system (Figure 10-11) is controlled by a single three-position switch labeled AIR FRAME ANTI-ICE. The switch controls four valves—two directly and two indirectly.

The switch directly controls the anti-icing valves. When the switch is placed in the NORM position, the normal anti-icing valve opens. This allows bleed air to flow to the leading-edge anti-icing system.

Should the normal anti-icing valve fail to open, the standby valve may be opened by placing the switch in the ST-BY position. This provides an alternate route for bleed air from the manifold.

The airframe anti-ice switch also indirectly controls two other bleed air valves. In either the NORM or ST-BY position, the switch also opens the No. 1 and No. 3 high-pressure bleed air valves. However, this is true only

when the HP 1 and HP 3 switches are in the AUTO position.

A double green-amber indicator light is located just above the airframe anti-ice switch. When the anti-ice switch is in the NORM or ST-BY position, the green light comes on to indicate that the wing anti-icing pressure switches sense bleed air pressure in both wings.

If pressure in both wings is not detected, the green light remains off and the amber light comes on.

With the anti-ice switch in the OFF position, the amber light comes on to indicate a system malfunction. This indication may be caused by inadvertent opening of one of the anti-icing valves or by a pressure switch malfunction.

Airframe anti-ice should not be used on the ground, except for system operational checks, and never with the APU operating.

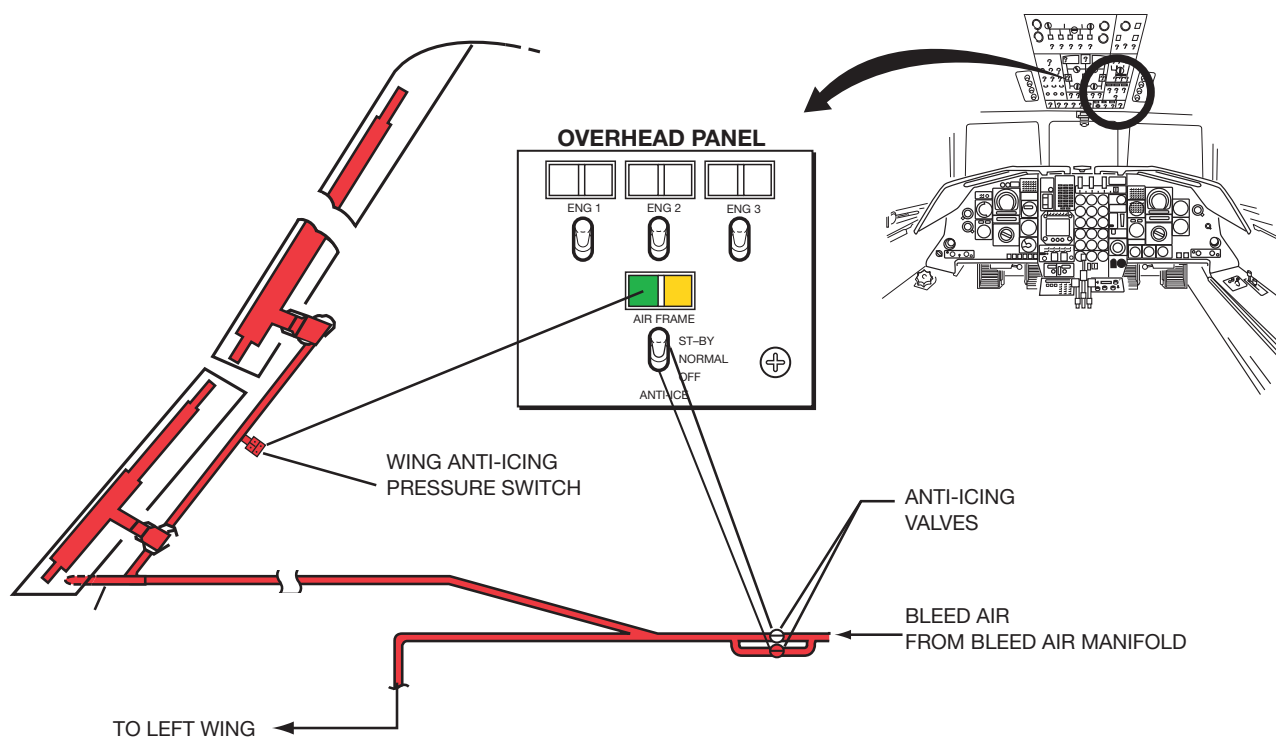
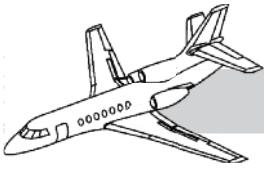

Figure 10-11. Controls and Indicators—Leading-edge Anti-icing



Modified System for Ground Operation Detection

Service Bulletin 225 is applicable to Falcon 50 aircraft. It covers Dassault Aviation modification F50 M1844.

Reason

On the ground, hot airflow in the slat anti-icing system generated by an inadvertent actuation or by a valve air leak (from one of both NORM or ST-BY parallel systems) may lead to slat damage.

The purpose of this Service Bulletin is to:

- Modify the slat anti-icing supply system
- Add an audio warning that advises the crew of the slat anti-icing system non-closure
- Improve the control safety using a pull-to-unlock switch that prevents any inadvertent maneuver

Description

Work consists in:

1. Modifying the slat anti-icing system as follows:
 - The two existing valves are replaced by only one valve. This new valve is equipped with a switch enabling energizing of an audio warning in the cockpit.
 - The pipes are modified:
 - Downstream of the old valves, the Y-pipe is discarded
 - Upstream, on the Y-pipe, the by-pass branch is plugged with a cap
 - The new valve is installed between two new pipes on the normal anti-icing system

2. Installing an audio warning electrical system—At ground, this system initialized by the new valve energizes a buzzer after a 30-second time delay. The original control on the overhead panel is kept. The NORM and ST-BY positions have the same function: order of valve opening through B bus bar (NORM) or C bus bar (ST-BY).
3. The ANTI-ICE control switch is replaced. The new switch is locked in the OFF position. Installing this switch onto the overhead panel requires modification or replacement of the CLAROPAN panel.

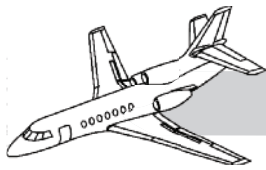

PITOT-STATIC ANTI-ICING

The pilot and copilot pitot-static systems are turned on and off by a pair of switches on the overhead panel (Figure 10-12).

A monitoring system monitors both the left-hand and right-hand pitot heads and static port heaters for proper operation. Warning lights on the annunciator panel come on to indicate that the current is insufficient for proper operation.

Proper heating of the angle-of-attack sensors and total temperature probes is not monitored.

WINDSHIELD AND SIDE WINDOW ANTI-ICING AND DEMISTING

Controls for the windshield anti-icing and demisting system consist of two three-position switches labeled PILOT and COPILOT on the windshield section of the overhead panel and shown in Figure 10-13. The pilot switch controls the pilot windshield and the left half of the center windshield. The copilot switch controls the copilot windshield and the right half of the center windshield. The maximum windshield heat is 86°F.

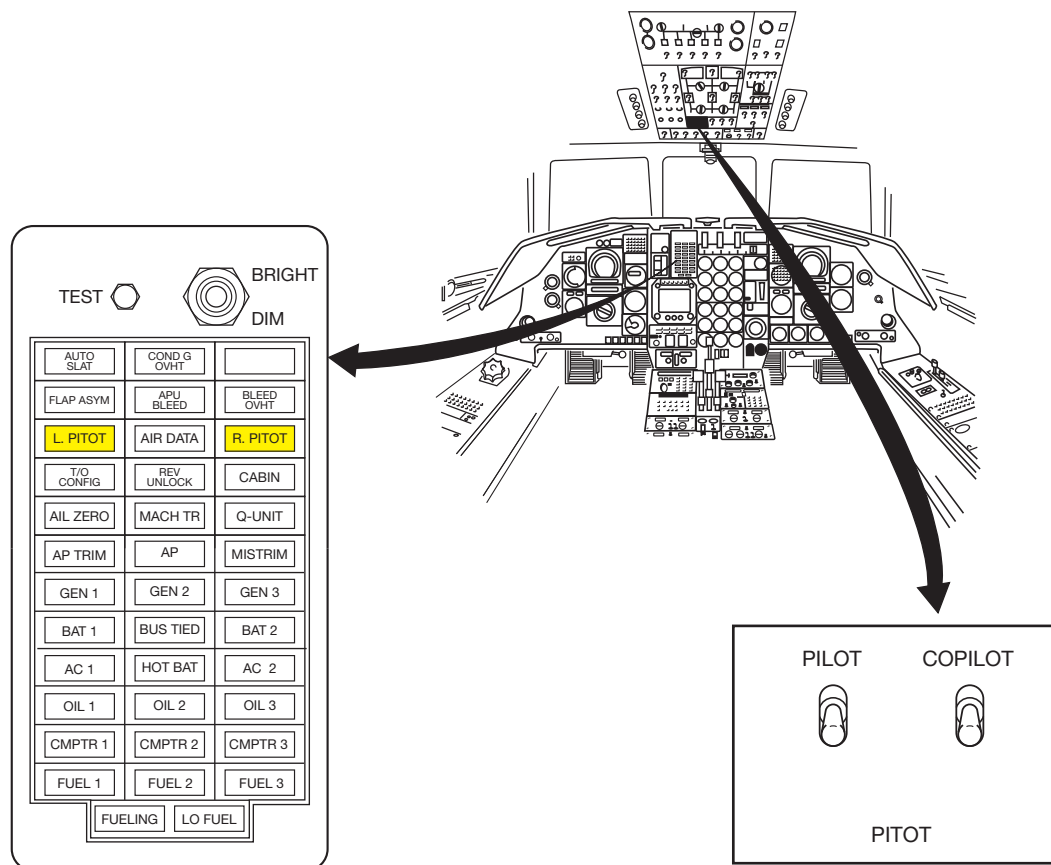

Figure 10-12. Controls and Indicators—Pitot-static Anti-icing

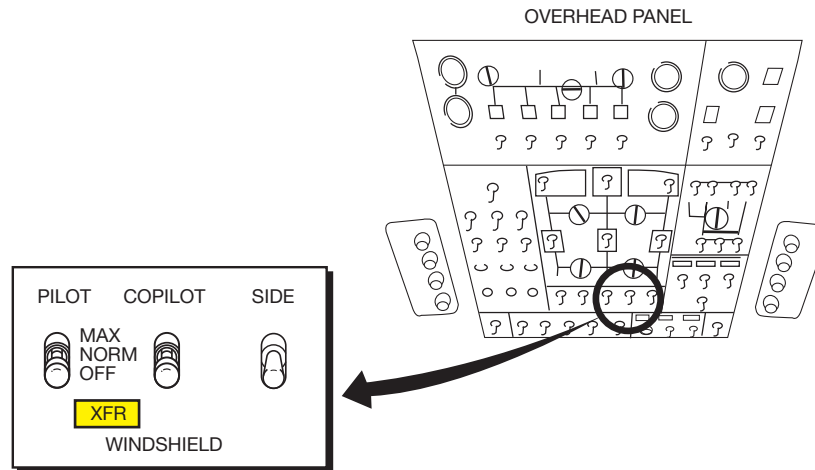
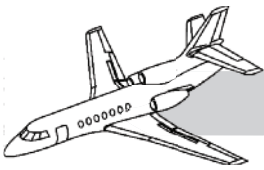

Figure 10-13. Controls and Indicators—Windshield and Side Window Anti-icing and Demisting

Each switch has three positions: MAX, NORM, and OFF. The NORM position is used for ordinary icing conditions. The MAX position may be used only during flight in severe icing conditions. In the MAX position, current in the associated windshield is increased. At the same time, current is decreased in just the associated half of the center windshield.

The XFR (transfer) indicator light is located just below the pilot and copilot windshield switches. The light comes on to indicate that one of the heating systems is inoperative and heating regulation has automatically transferred to the other regulator system.

The side window heaters are controlled by a single switch labeled SIDE. The switch controls two regulators which control both side windows and the right hand aft window.

INTERIOR WINDSHIELD DEMISTING

The interior windshield demisting system is controlled by the defog handle (Figure 10-14) on the right-hand side console. The handle both controls the speed of the blower and activates the heating resistor in the system.

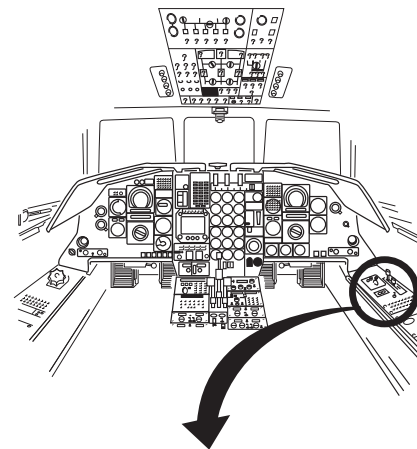
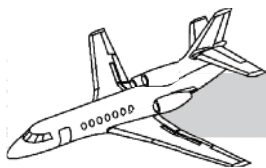

Figure 10-14. Controls and Indicators—Interior Windshield Demisting



When the handle is placed in the aft position, the blower is off. In the middle position, the blower runs but the air is not heated.

The motor is an AC-powered unit and the heating coil is DC powered.

When the handle is placed full forward, the heating resistor is energized, the air is heated, and the blower operates at full speed. When the heater is energized, the blown air reaches its maximum temperature in approximately three minutes. A heat control thermostat cycles the heating resistors and limits temperature.

This system is used only in aircraft prior to SN 80. It has been deleted on subsequent serial numbers.

WINDSHIELD WIPERS

The controls for the windshield wipers are installed on the lower corners of the overhead panel. Each wiper is controlled by a three-position rocker-type switch labeled ON, OFF, and PARK (Figure 10-15). The PARK position

causes each wiper blade arm to move slowly to the stow position in recesses below the pilot or copilot windshield, respectively.

LIMITATIONS

The airframe anti-ice system must not be used when the total air temperature is more than +10°C.

The airframe anti-ice system must be switched on in flight prior to entering visible moisture if the total air temperature is less than +10°C.

The airframe anti-ice system must not be used on the ground except for maintenance checks conducted in accordance with the maintenance manual.

Windshield wipers will not be used above 205 kts.

Windshield MAX heat should only be used in flight and only if normal does not keep ice off.

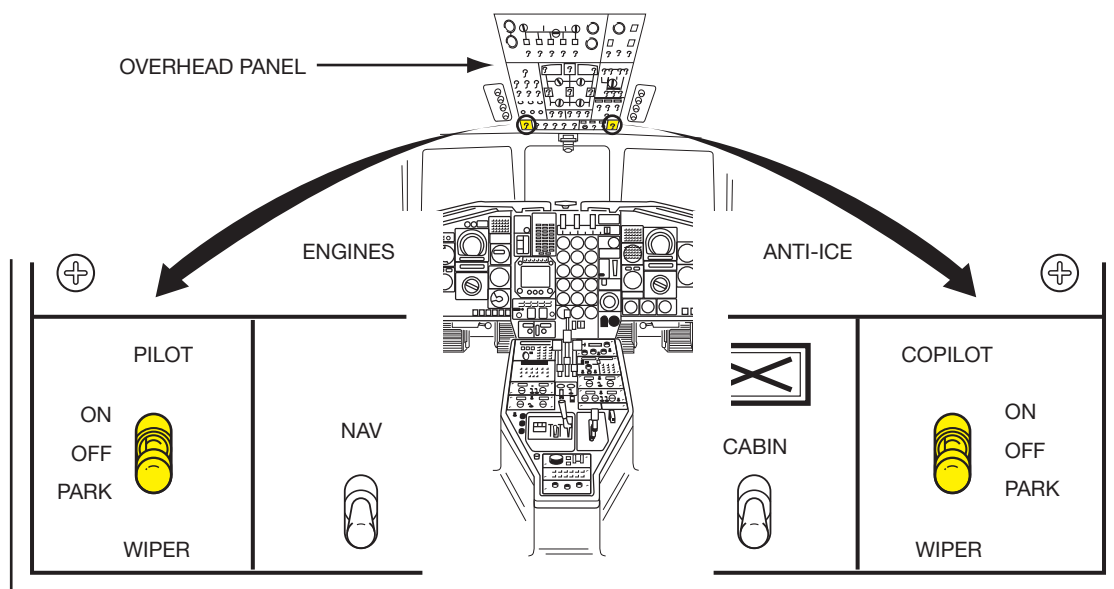
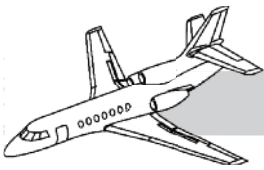
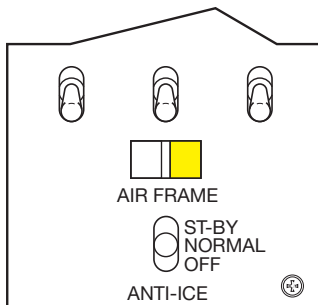

Figure 10-15. Controls and Indicators—Windshield Wipers



QUESTIONS

- How is the vertical stabilizer anti-iced?
 - By using bleed air
 - Electrically
 - Hydraulically
 - The vertical stabilizer is not anti-iced.
- What is the power source for the left-hand and right-hand static port heaters?
 - The pilot circuit
 - The copilot circuit
 - The pilot and copilot circuits
 - The windshield heater circuit
- What happens to the pilot windshield if its temperature probe fails?
 - It loses anti-icing protection.
 - It is anti-iced continuously.
 - It is automatically controlled by means of the copilot windshield temperature probe.
 - It overheats.



- What is indicated when this light comes on?
 - The system is operating normally.
 - The anti-ice valve is stuck closed.
 - The anti-ice valve is stuck open.
 - A bleed air valve is stuck closed.

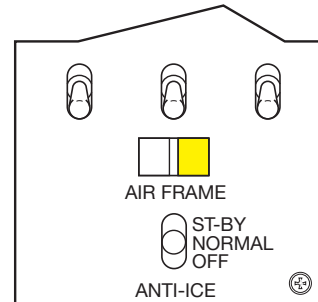

- What may be indicated when this light comes on with the airframe anti-ice switch off?
 - The system is operating normally.
 - An anti-icing valve has failed closed.
 - A pressure switch has malfunctioned.
 - An HP bleed air valve is stuck closed.

FLAP ASYM	APU BLEED	BLEED OVHT
L. PITOT	AIR DATA	R. PITOT
T/O CONFIG	REV UNLOCK	CABIN

- What is indicated when this light comes on?
 - Malfunction of the angle-of-attack probe anti-icing
 - Malfunction of the total temperature probe anti-icing
 - Malfunction of the right static port anti-icing
 - Malfunction of the left pitot anti-icing system

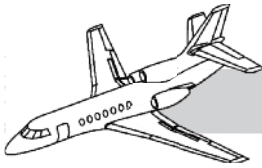

7. When may the MAX position be used for the pilot and copilot windshield heater?
 - A. To remove snow while on the ground
 - B. To demist the interior of the windshield
 - C. If ice continues to build with the switch in NORM
 - D. During taxi to heat the windshield for takeoff

8. Prior to entering visible moisture, at which temperature should the airframe anti-icing system be turned on?
 - A. +10°C
 - B. +8°C
 - C. +6°C
 - D. +5°C

9. What is the maximum total air temperature at which the airframe anti-ice system can be used?
 - A. +5°C
 - B. +10°C
 - C. +15°C
 - D. +20°C

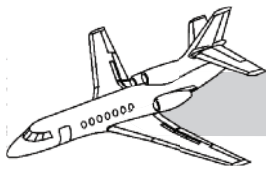

CHAPTER 11

AIR CONDITIONING

CONTENTS

	Page
INTRODUCTION.....	11-1
GENERAL.....	11-1
OPERATION	11-1
Hot Air.....	11-4
Cold Air.....	11-4
Temperature Regulation	11-4
Distribution.....	11-5
VENTILATION AND AIR CONDITIONING OF THE BAGGAGE COMPARTMENT	11-6
VENTILATION AND AIR CONDITIONING OF THE NOSE CONE	11-7
INDEPENDENT SYSTEMS ASSOCIATED WITH AIR CONDITIONING.....	11-8
Thermal Insulation—Main Cabin Door.....	11-8
Electrically Heated Crew Carpets	11-8
QUESTIONS	11-9

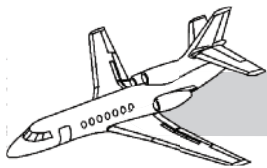

ILLUSTRATIONS

Figure	Title	Page
11-1	Air-Conditioning System.....	11-2
11-2	Air-Conditioning System Block Diagram.....	11-3
11-3	Air-Conditioning Panel.....	11-4
11-4	COND’G OVHT Light.....	11-5
11-5	Baggage Compartment Conditioning.....	11-6
11-6	Nose Cone Conditioning and Ventilation.....	11-7
11-7	Heated Carpets—Controls.....	11-8

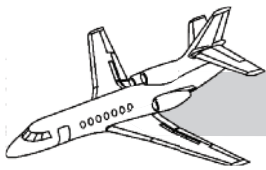

CHAPTER 11

AIR CONDITIONING



INTRODUCTION

The air-conditioning system of the Falcon 50 is used to maintain the crew, passenger, and baggage compartments, and the nose cone at a suitable pressure and temperature, regardless of flight conditions.

GENERAL

There are two identical air-conditioning channels: the right-hand system for the cockpit, and the left-hand system for the cabin. Both are fed bleed air from a common bleed-air manifold or PRV. They share an interconnecting distribution and circulation system, but in all other respects the two air-conditioning subsystems can be totally independent of each other. As long as one system is serviceable, the air distribution system will supply conditioned air to the cockpit and cabin, as seen in Figure 11-1.

OPERATION

Whenever the engines are running, low-pressure (LP) bleed air is supplied to the common manifold. With the isolation valve normally open, the manifold is a single chamber and supplies both air-conditioning channels. When the anti-ice systems are selected to OFF, and the engine power is at a low setting, the PRV will automatically open and regulate HP bleed air to a low pressure level and supply it to the air-conditioning units.

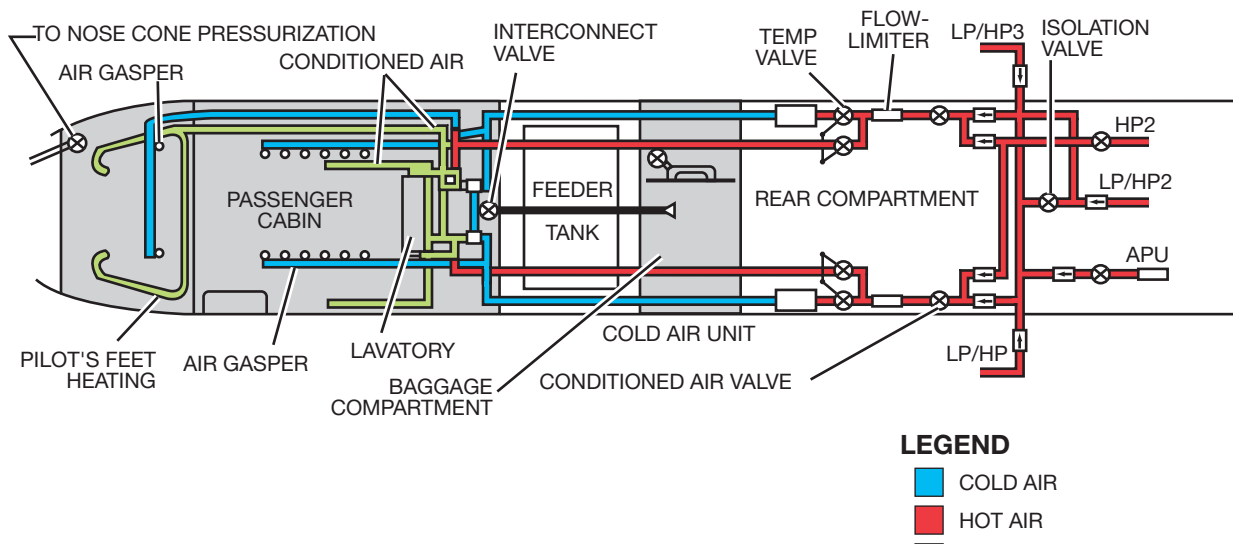
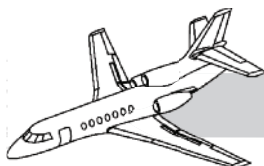

Figure 11-1. Air-Conditioning System

Each air-conditioning channel employs an air-conditioning valve and a restrictor. The valves control delivery of engine or APU bleed air to the systems. The valves are controlled by a CABIN or CREW switch located on the overhead panel (Figure 11-2). This switch has AUTO, ON, and OFF positions.

ON—The corresponding valve receives a permanent OPEN signal.

OFF—The corresponding valve receives a permanent CLOSED signal.

AUTO—(Normal operating position) The valve is controlled by the power lever angle (PLA) when the aircraft is on the ground.

- With the aircraft on the ground and the PLA below 54°, the valve is controlled to OPEN. When the PLA is advanced beyond 54°, the valve is closed very quickly.
- In flight, the valve is allowed to slowly open as soon as the aircraft senses that the landing gear is off the ground. The valve is fully open in 3 minutes.

NOTE

When the thrust reverser is deployed while PLA is above 54°, the valves close, but quickly reopen as soon as the reverser is retracted.

After leaving the air-conditioning valve, bleed air passes through a restrictor which limits the airflow and dampens surges produced by engine speed variations.

Downstream of each flow restrictor, the air is again divided and passes through two butterfly valves which function as dual, temperature regulating valves. The valves are mechanically connected to drive in opposite, compensating directions, controlled by the cockpit temperature selector. The hot valve travel is controlled between 60° and full closed, while the cold valve can be opened as wide as 90°; however, the cold valve restricts its airflow to not less than 30% of the total flow, thus ensuring a supply of fresh, cooled air to the crew and passengers.

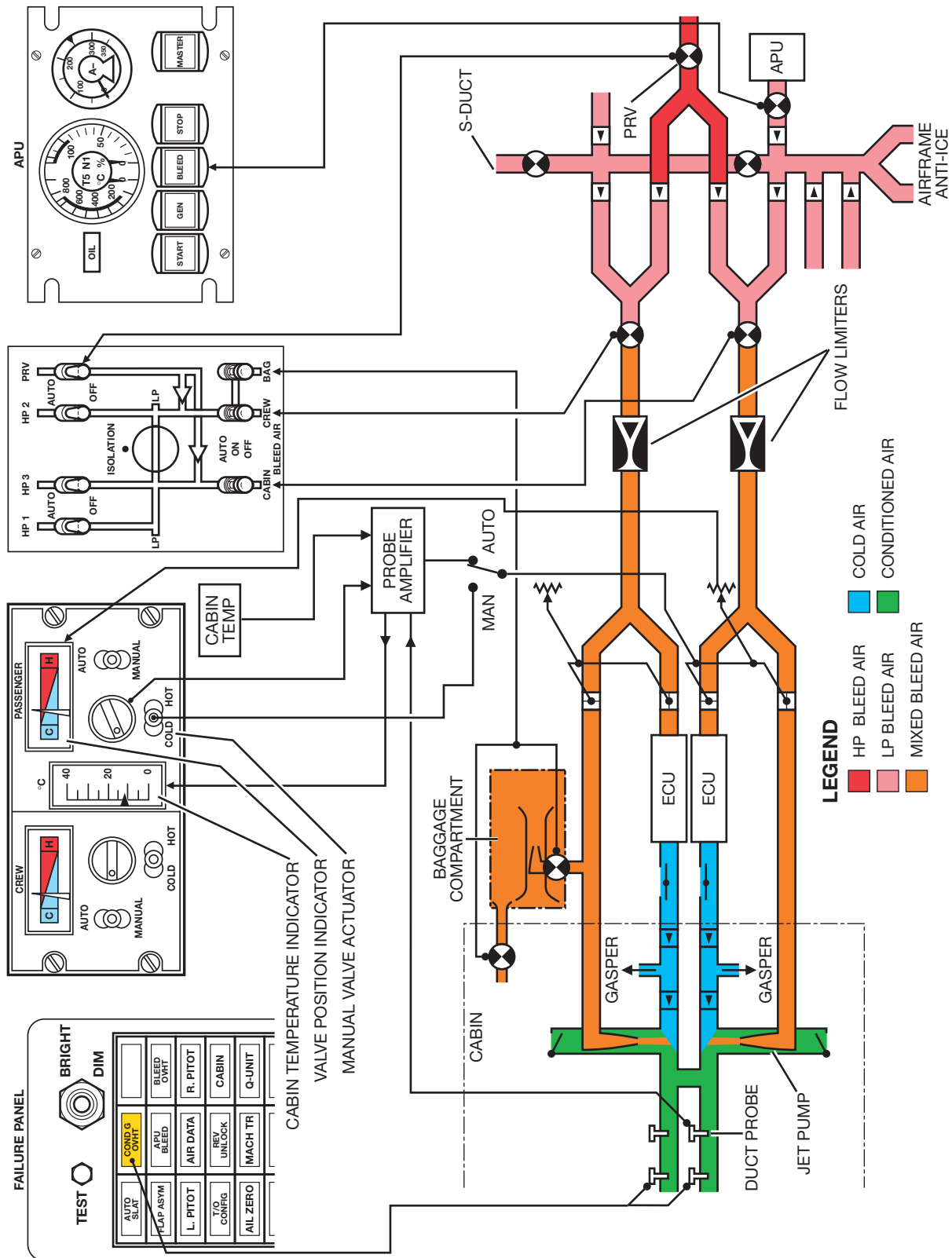
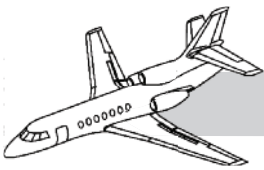
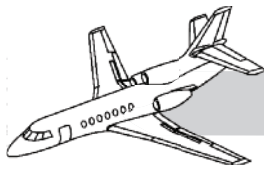

Figure 11-2. Air-Conditioning System Block Diagram



HOT AIR

Hot air from the bleed system is directed through one valve of the dual temperature valve into the rear of the cabin and into the distribution system. It produces a venturi effect which causes recirculated cabin air to reenter the distribution system and mix with the hot air.

COLD AIR

The bleed air passes through the “cold” butterfly side of the dual temperature valve and into the environmental control units (ECU).

Each ECU has a two-stage heat exchanger: the first stage is cooled by ambient air and evaporation; and the second stage is cooled by cold turbine discharge air. The temperature is controlled at the turbine discharge, so that it does not drop below +3°C, and is directed, at a reduced pressure, through the delivery system.

TEMPERATURE REGULATION

The air conditioned flow to the crew and passenger compartments is a mixture of hot bleed air and the cold air output of the ECU's. The mixture is controlled by the dual temperature valves which, in turn, are controlled from the cockpit. This is accomplished using the air-conditioning panel, as seen in Figure 11-3.

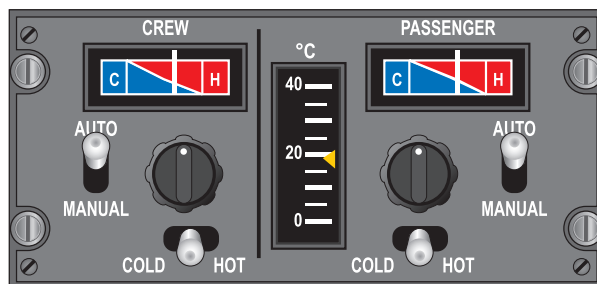

Figure 11-3. Air-Conditioning Panel

The panel has two sections: CREW and PASSENGER. Each section has its respective AUTO-MANUAL switch and COLD-HOT switch.

- **AUTO**—When set to AUTO, the system will permit probes that sense duct and cabin temperature to regulate the dual temperature valve to maintain the temperature selected by the temperature control knob, which can be set between 57° and 91°F (14° and 33°C).
- **MANUAL**—When set to MANUAL, the temperature control knob no longer controls the selection. The control is transferred to the COLD-HOT switch, which directly operates the dual temperature valve. The COLD-HOT switch is a momentary switch. It is held in the direction of the desired change, and when released, returns to the neutral position, leaving the dual temperature valve in the last selected configuration. Remember, the cold side of the dual temperature valve is designed so that it cannot be closed below 30% of total flow.

The temperature indicator, located in the center of the panel, displays the ambient temperature which exists in the passenger cabin. It is displayed on a scale between 0° and 40°C.

At the top of the air conditioning panel, there are two indicators, one each for the crew and passenger systems, which display the position of the respective dual temperature valves. The dial graduates between C (cold) and H (hot), and a pointer is positioned by a potentiometer on the corresponding dual valve. When the pointer is full right, it indicates as hot as the valve can be set, which still passes a minimum of 30% cold air.

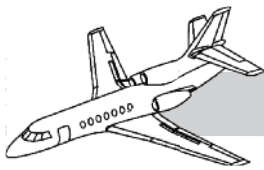

An amber COND’G OVHT (conditioning over-heat) light on the master warning panel (Figure 11-4) receives signals from two thermostats located in the ducts on the rear bulkhead on each of the crew and passenger systems. Illumination of the COND’G OVHT light alerts the crew to a condition of excess duct temperature, but it reflects a different temperature in each duct.

HOT switch to COLD, set the dual temperature valves to COLD. The valve indicators should reflect the valve movement, and the light should go out. If the light remains on, the air-conditioning switches should be turned off consecutively, in order to isolate the faulty system.

DISTRIBUTION

The ducts containing hot air, cold air, and recirculated cabin air come together in a sound-proof manifold located at the rear of the cabin on the bulkhead (Frame 28).

Cold air is at the top of the bulkhead, while hot and reconditioned air are at the lower section. Only cold air is distributed to the overhead gaspers, while a mixed combination of cold, hot, and recirculated air is supplied to the LH and RH cabin outlets and to the cockpit outlets.

If the dual temperature valves are set to full COLD, no recirculated air is drawn into the mix.

The system is designed to deliver primarily RH system air to the cockpit, and LH system air to the passenger area. Since the cockpit requires less than the passenger cabin, the cabin also receives supplemental flow from the RH system.

There are cold air gaspers for the passengers use, as well as one at the extreme left and right sides of the instrument panel for the pilots.

Cabin air conditioning is supplied through left and right ducts which direct the air through six manifolds and heated floors. A door next to the floor in the divan corner may be opened to allow a more direct flow of conditioned air into the cabin.

In the cockpit, the conditioned air enters through the two cold air gaspers previously mentioned, and mixed air enters from an opening behind the rudder pedals.

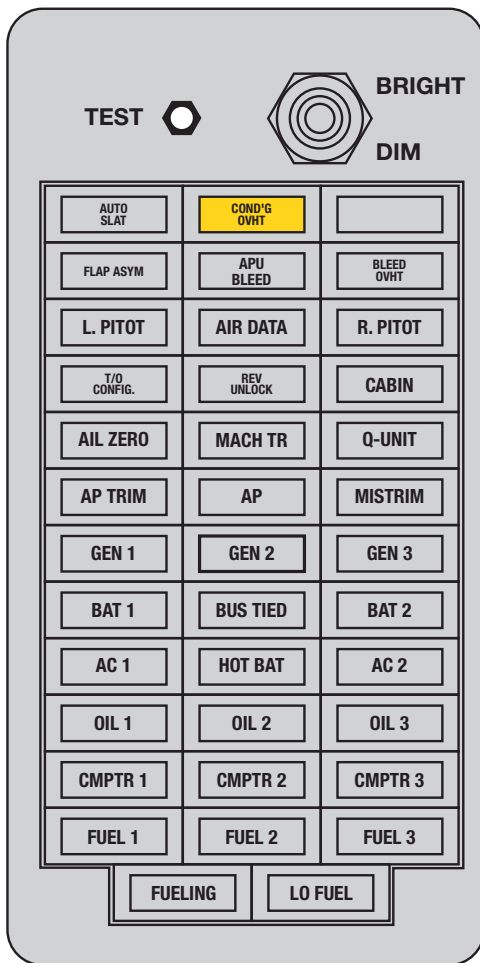
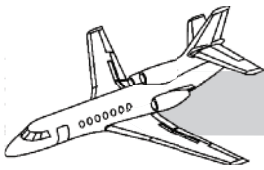

Figure 11-4. COND’G OVHT Light

PASSENGER SUPPLY LINE—85° to 90°C or more

CREW SUPPLY LINE—85° to 90°C or more

If the light is illuminated, alternately set the crew and passenger AUTO-MANUAL controls to MANUAL and, by holding the COLD-



VENTILATION AND AIR CONDITIONING OF THE BAGGAGE COMPARTMENT

The baggage compartment is conditioned by RH system hot bleed air and an interconnection with the passenger cabin (Figure 11-5).

Two valves affect baggage compartment air, both of which are normally open. A baggage compartment conditioning inlet valve passes the RH hot bleed air, which is circulated inside the baggage compartment by the jet pump effect.

The second is the baggage compartment isolation shutoff valve which is located at the rear of the cabin on Frame 28 bulkhead. This valve balances the pressure between the passenger cabin and the baggage compartment. Both valves are controlled by the BAG switch, located on the bleed air panel on the overhead panel. The switch is detented OPEN. Positioning the BAG switch to OFF shuts both valves.

In the cockpit, two amber lights are located on the mechanic test panel. These permit checking the operation of the two baggage compartment valves.

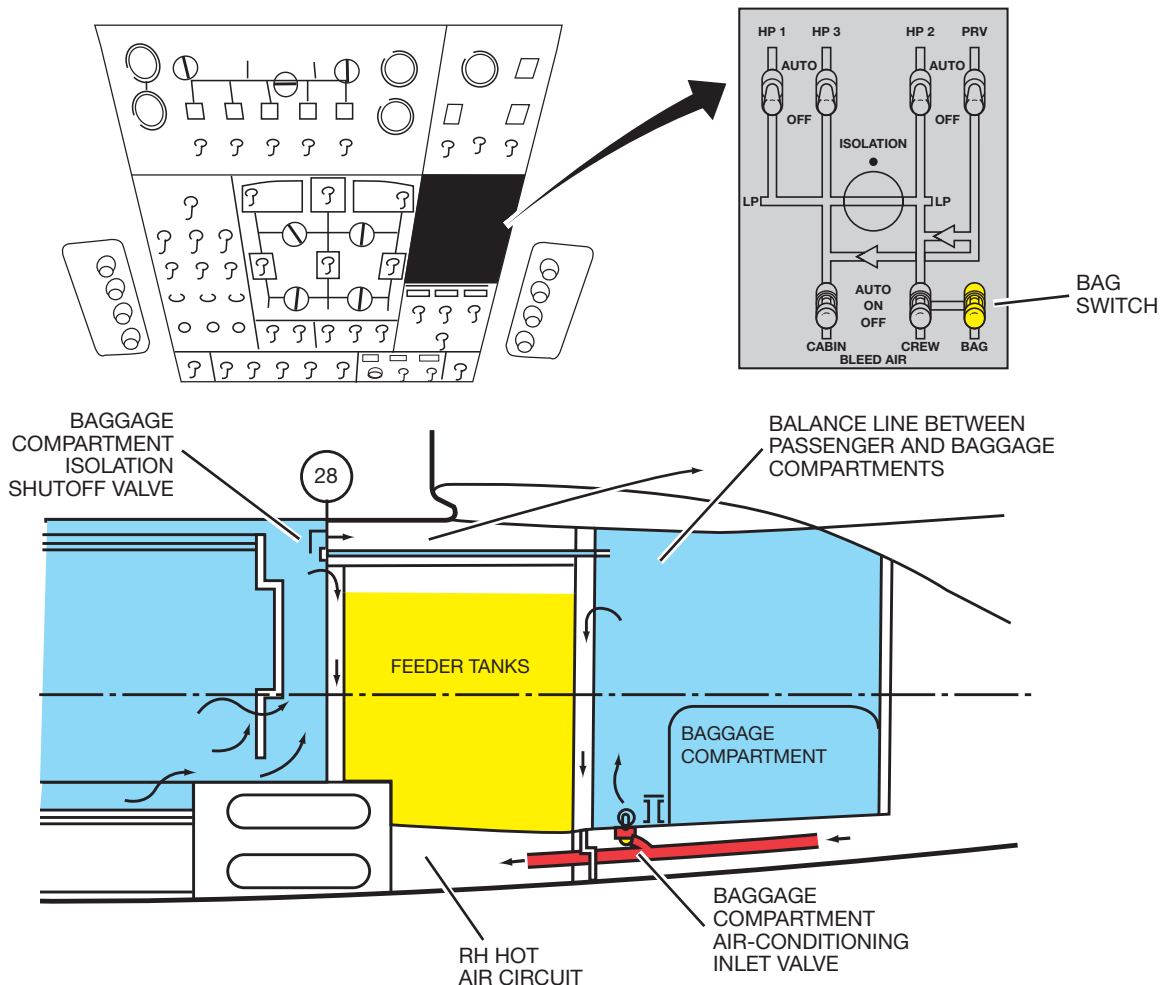
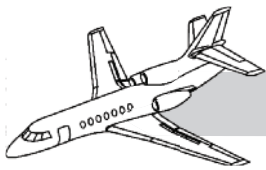

Figure 11-5. Baggage Compartment Conditioning



VENTILATION AND AIR CONDITIONING OF THE NOSE CONE

While on the ground, a fan installed within the nose cone draws air through the compartment, protecting the installed electronic equipment. (See Figure 11-6.) The landing gear proximity switch, sensing aircraft on ground, allows auxiliary C bus power to actuate the fan and open the exhaust port into the nose wheel well, as long as power is available.

In flight, the blower is inoperative, but pressurized/conditioned cabin air is allowed to enter the nose cone through a manually controlled valve, operated by a handle on the right con

sole labeled NOSE. The cabin air passes through a butterfly valve, operating as an out-flow valve, which senses the pressure differential between the cockpit and the nose cone.

When the cockpit pressure exceeds nose cone pressure by 1.7 psid (120 mb), the butterfly starts to close and is fully closed at a cabin pressure differential of 3 to 3.6 psi (190 mb). Nose cone pressurization will then be maintained through two calibrated holes in the butterfly valves. The pressure will be maintained at an approximate 25,000-foot altitude when the aircraft is at 40,000 feet.

Pressure relief is controlled by another valve which opens if the pressure differential reaches 3.65 ± 0.36 psi (250 ± 25 mb).

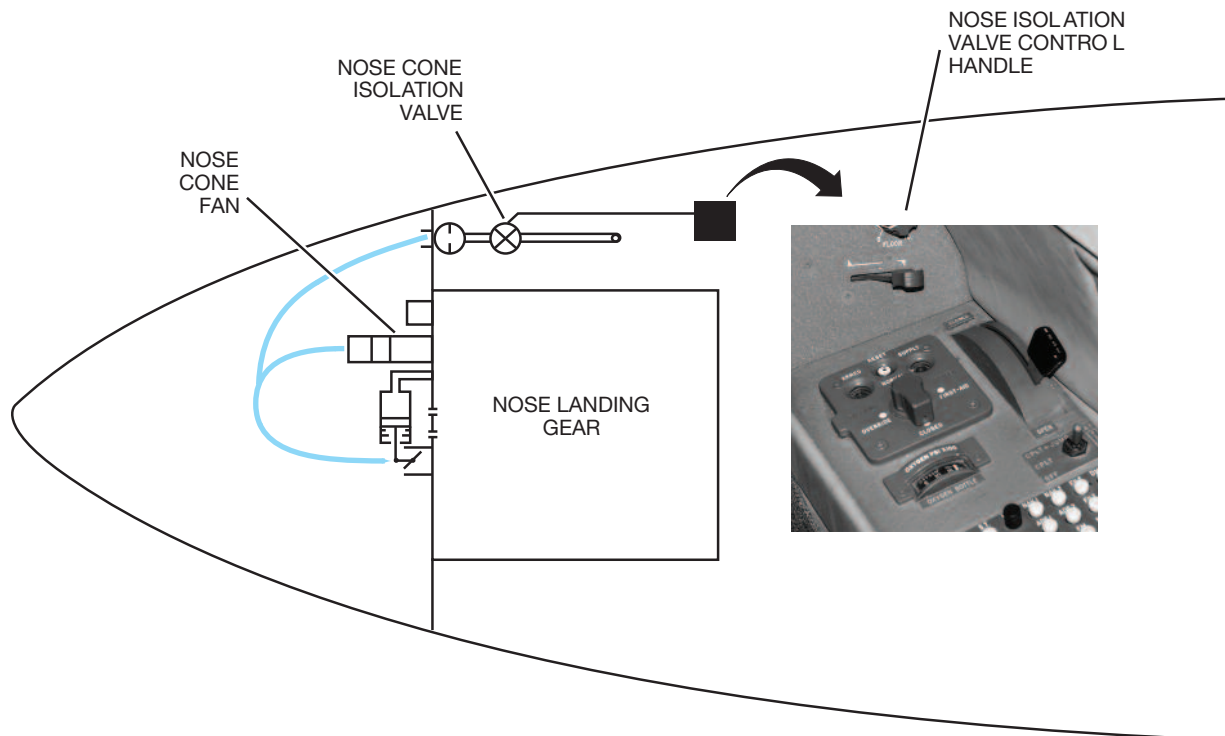
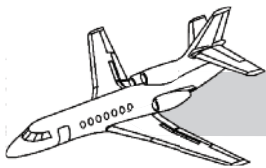
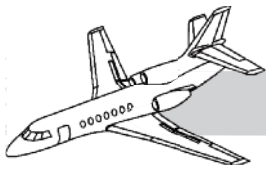

Figure 11-6. Nose Cone Conditioning and Ventilation



QUESTIONS

1. When the PRV valve switch is positioned to AUTO, what takes place?
 - A. Engine No. 2 bleed air supplies all bleed air to the ECU's.
 - B. Center engine HP bleed air is regulated to LP level and supplied to the air conditioning systems.
 - C. All HP bleed air going through the pressure regulating valve is reduced to LP air.
 - D. It allows regulated air to be used for pressurizing the nose cone and baggage compartment.
2. How can conditioned air be rapidly supplied to the cabin while on the ground?
 - A. Conditioned air can be supplied on the ground only if APU bleed air is available.
 - B. Turn off the CREW selector and leave CABIN switch at ON.
 - C. Position the PASSENGER temperature controller to MANUAL, and move the momentary switch to COLD.
 - D. There is a flood duct door next to the floor in the divan corner which may be opened on the ground for rapid conditioning. This door must be closed in flight.
3. What does the 0° to 40°C indicate on the temperature controller display?
 - A. It displays the passenger compartment temperature.
 - B. It displays the average temperature of the crew and cabin system.
 - C. It is an indicator of OAT.
 - D. It is either the crew or passenger area temperature.
4. Which statement about electrically heated carpets is true?
 - A. The pilot has a switch to turn them to NORMAL or OFF, and the copilot has the temperature regulator control.
 - B. On the pedestal is a NORMAL-OFF control, but the temperature regulator is on the copilot side console.
 - C. Each side console has an independent NORMAL-OFF control, but the temperature regulator is on the copilot console.
 - D. They are located at each crew and passenger position.
5. Which statement about the nose cone environmental system operation is true?
 - A. When the manual NOSE valve control on the copilot side console is opened, air conditioning and pressurization are available both on the ground and in flight.
 - B. On the ground, a butterfly valve opens, so pressurization is not available, but a blower will supply ventilation.
 - C. The copilot manual NOSE valve control is normally closed for proper pressurization.
 - D. If a pressure leak develops in the nose cone, the copilot manual NOSE valve control should be kept open so that cabin pressure can continue to pressurize the electronic equipment.



CHAPTER 12 PRESSURIZATION

CONTENTS

	Page
INTRODUCTION.....	12-1
GENERAL.....	12-1
NORMAL PRESSURIZATION SYSTEM.....	12-4
Electropneumatic Outflow Valve Operation.....	12-6
Protection Against Overpressure.....	12-6
Cabin Maximum Pressure Altitude Protection.....	12-6
Anti-nicotine Filter.....	12-7
EMERGENCY PRESSURIZATION SYSTEM.....	12-7
Manual Pressure Controller.....	12-7
Emergency Pneumatic Outflow Valve.....	12-7
Rapid Depressurization (Dump) Function.....	12-7
INDICATIONS AND PROTECTION DEVICES.....	12-8
Triple Cabin Pressure Indicator.....	12-8
Audible and Visual Warnings.....	12-8
BAGGAGE COMPARTMENT PRESSURIZATION.....	12-9
LIMITATIONS.....	12-9
QUESTIONS.....	12-11

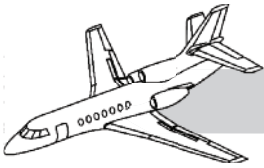

ILLUSTRATIONS

Figure	Title	Page
12-1	Pressurized Areas.....	12-2
12-2	Pressurization System.....	12-2
12-3	Pressurization System Schematic	12-3
12-4	Pressurization Controls and Indicators	12-4
12-5	Automatic Pressure Controller	12-5
12-6	Outflow Valves.....	12-6
12-7	Manual Operation	12-7
12-8	DUMP Position	12-8
12-9	Triple Indicator	12-8
12-10	Pressurization System Diagram	12-10

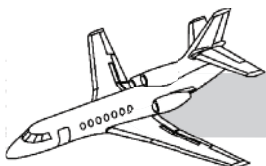

CHAPTER 12

PRESSURIZATION

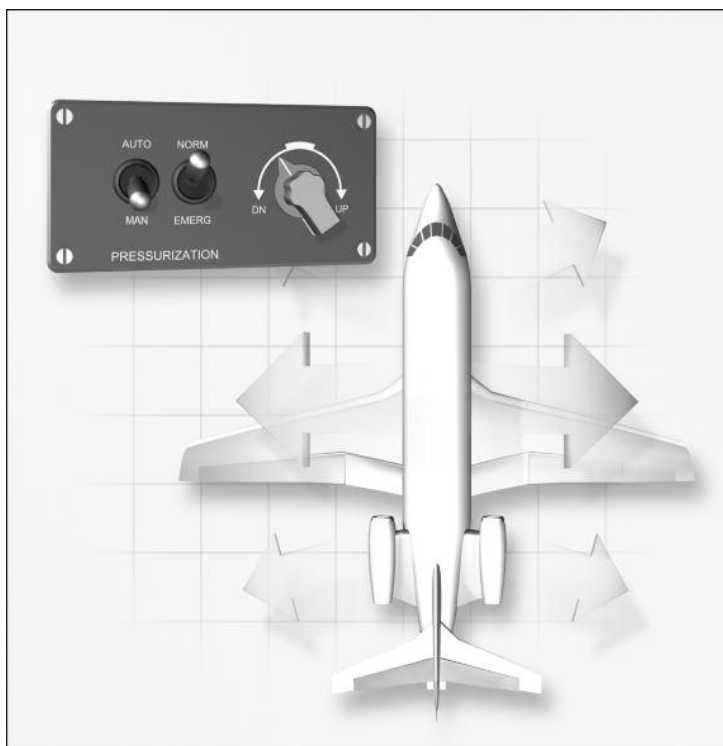

INTRODUCTION

The Falcon 50 pressurization system is supplied engine bleed air and routed through the air-conditioning system. It is designed to maintain a maximum differential pressure of 8.8 psid (607 mb), which is a cabin altitude of 8,000 feet at a flight altitude of 45,000 feet or 9.1 psid (628 mb) which is a cabin altitude of 8,000 feet at a flight altitude 49,000 feet. Cabin pressurization is controlled and maintained by two outflow valves which are controlled either automatically or manually by the pilot. The baggage compartment is pressurized and conditioned. The nose cone is also partially pressurized.

GENERAL

The fully pressurized compartments of the airplane consist of the passenger cabin, the cockpit, and the baggage compartment (Figure 12-1). In addition, the nose cone is partially pressurized.

During normal pressurization (automatic mode), an electropneumatic outflow valve controls pressurization. In the manual system (manual mode), a fully pneumatic outflow valve is primary for operation. Both outflow valves

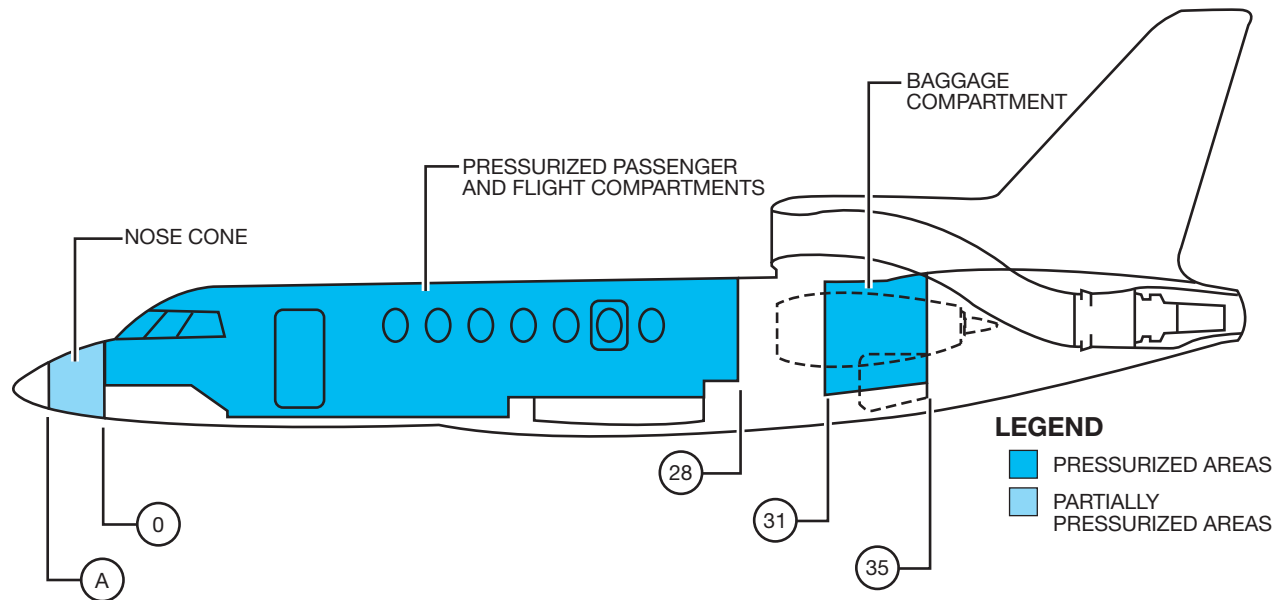
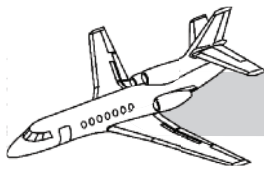

Figure 12-1. Pressurized Areas

operate all the time. The mode of operation determines which valve is the master, and which is the slave (Figure 12-2).

Figure 12-3 illustrates the pressurization system in greater detail.

The compartment is also protected against negative pressures by the vacuum valves installed

in the cold air supply circuits. In addition, the valves are each fitted with a cabin altitude limiting device which operates in the event of failure or leakage. The nose cone and the baggage compartment can be isolated from the passenger compartment, if necessary. They are provided with their own particular safety features for protection against overpressure and negative pressure differentials.

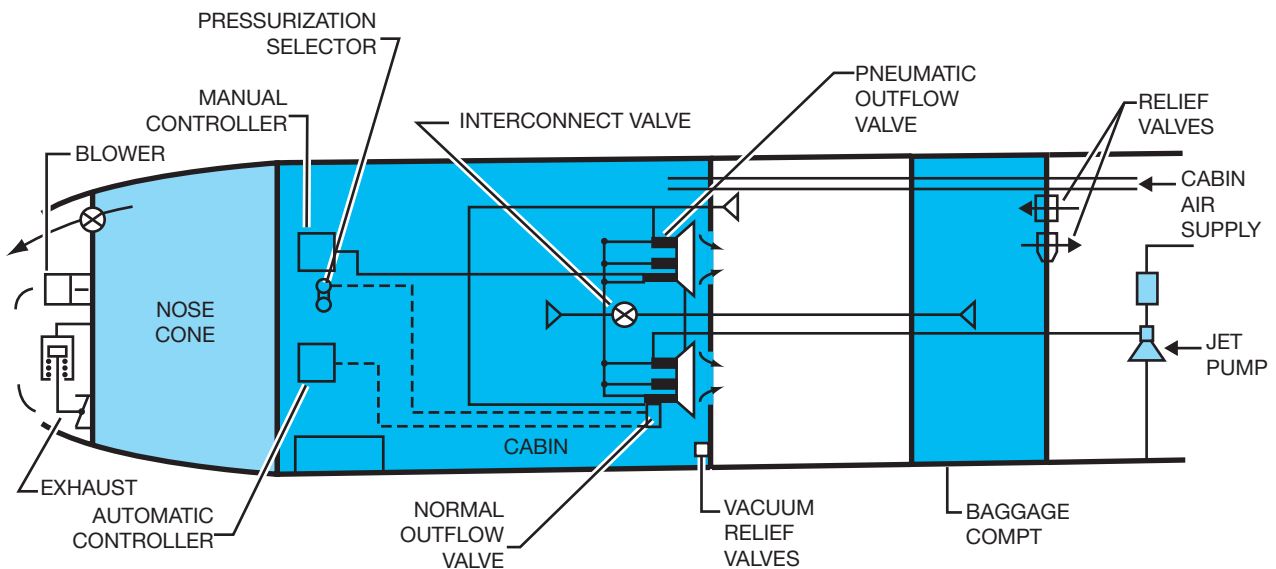
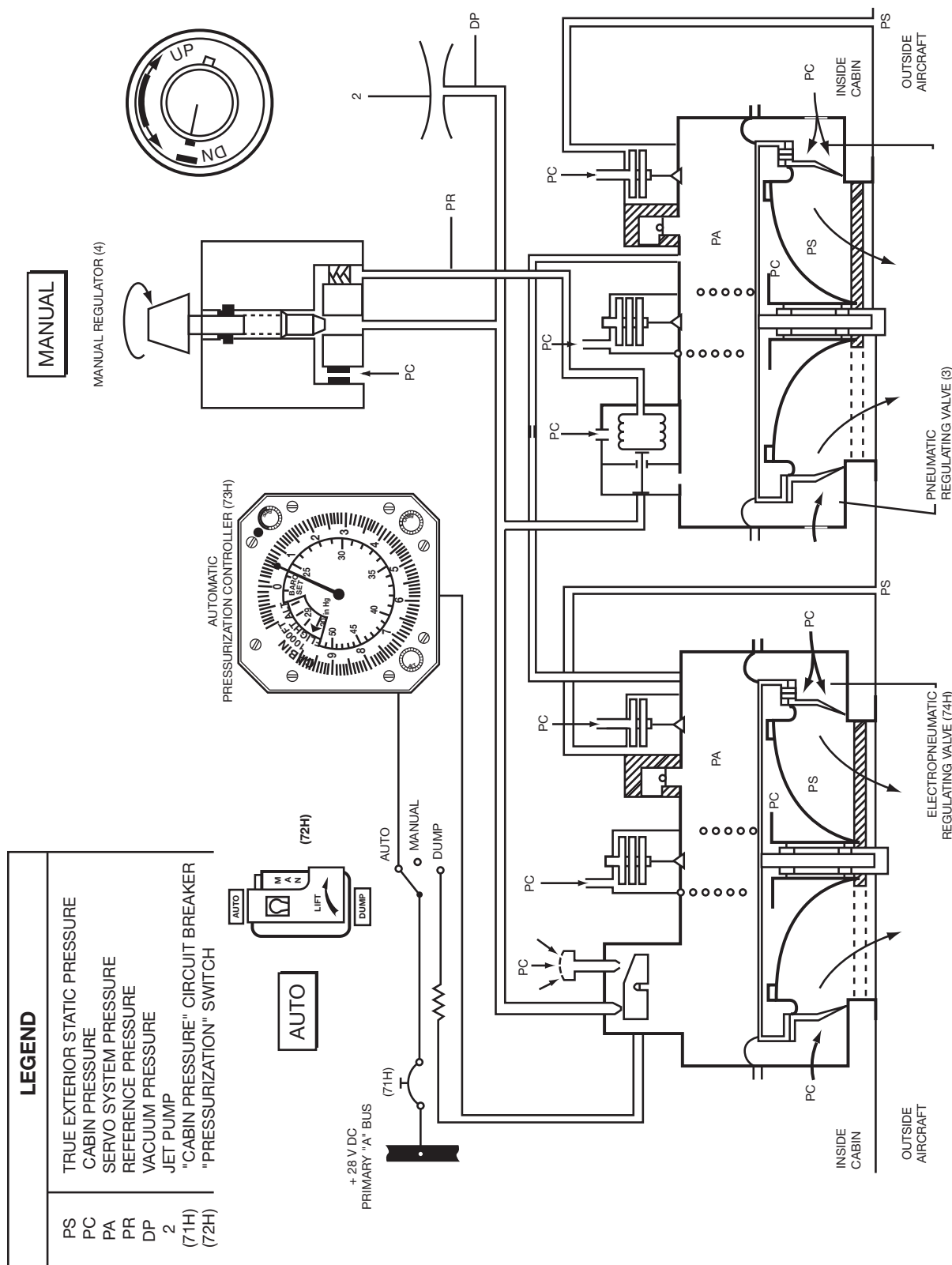
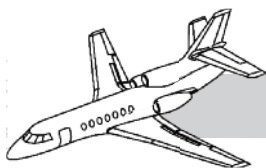

Figure 12-2. Pressurization System



LEGEND

PS	TRUE EXTERIOR STATIC PRESSURE
PC	CABIN PRESSURE
PA	SERVO SYSTEM PRESSURE
PR	REFERENCE PRESSURE
DP	VACUUM PRESSURE
2	JET PUMP
(71H)	"CABIN PRESSURE" CIRCUIT BREAKER
(72H)	"PRESSURIZATION" SWITCH

Figure 12-3. Pressurization System Schematic

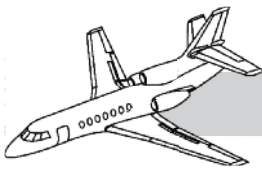

NORMAL PRESSURIZATION SYSTEM

The normal system consists of:

- A cabin automatic pressure controller
- A normal pressure electropneumatic outflow valve

- A pneumatic outflow valve (follows normal valve in automatic mode)
- An anti-nicotine filter

A three-position PRESSURIZATION switch is located on the lower right of the center instrument panel (Figure 12-4). Setting this guarded switch to the AUTO position places the pressurization system into the normal, or automatic mode.

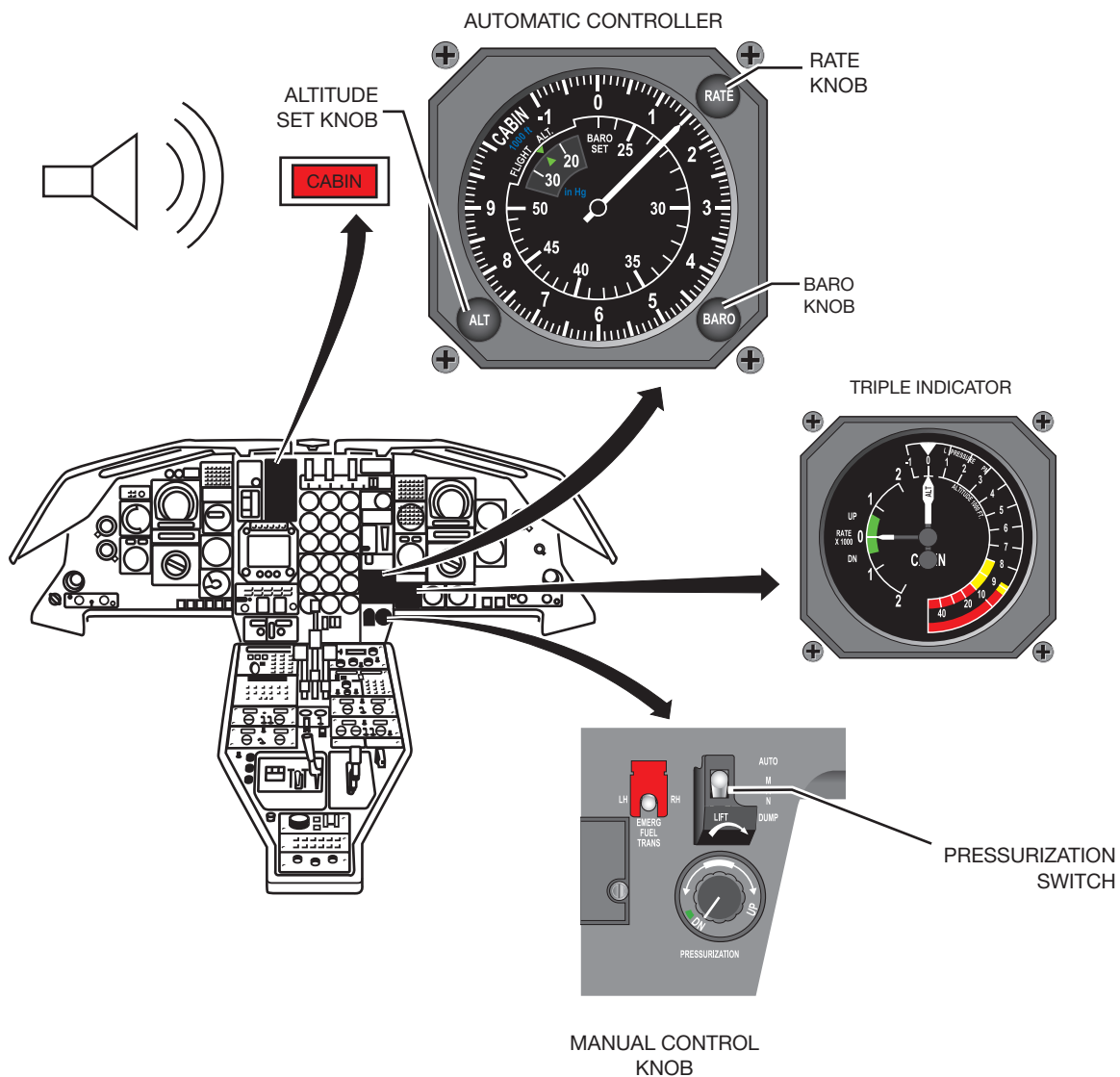
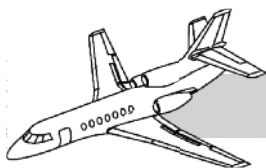

Figure 12-4. Pressurization Controls and Indicators



When the PRESSURIZATION switch has been set to AUTO, the system operates automatically, responding to cockpit inputs on the automatic pressure controller (Figure 12-5). Located on the lower portion of the center instrument panel just above the pressure switch, it has three input knobs. The controller generates electrical signals to the electropneumatic LH outflow valve as a function of:

- Pilot input
- Cabin pressure and rate of change
- Aircraft configuration



Figure 12-5. Automatic Pressure Controller

The pilot establishes the desired cabin altitude by rotating the ALT knob which positions the large white pointer between -1,000 feet and +10,000 feet of cabin pressure altitude.

Rotating the BARO knob causes the whole outer ring (including the fixed arrow) to rotate, until the arrow is positioned opposite the selected barometric pressure within the BARO SET window. The BARO SET window has readings from 29 to 31 inches of mercury.

The RATE knob is used to select the pressure rate of change. This knob does not position a pointer on the indicator. A detent pointer is calibrated to adjust the rate of change to:

- +650 feet per minute increasing altitude
- -450 feet per minute decreasing altitude

If the RATE knob is set full counterclockwise, it will establish a rate of climb of +200 feet per minute and a descent of -100 feet per minute. At the opposite extreme, it sets +1,450 and -1,000 feet per minute.

Cabin altitude and cabin rate-of-change detection operate differently for flight and ground conditions. While in flight, the electrical preset cabin altitude and rate of change is compared to the actual flight conditions. The controller sends commands to the electropneumatic valve torque motor to position the valves as desired. If the deviation between the preset and true cabin altitude is more than 100 feet, the RATE knob must be adjusted. For deviations of less than 100 feet, the requested rate of change will decrease as the deviation decreases, and will be maintained between ± 50 feet per minute.

While on the ground, the preset altitude is not considered. There are two variables in this situation as well. If no throttle is positioned above 54° PLA, the aircraft is depressurized according to the RATE knob setting. In that case, the cabin pressure is maintained at ambient pressure and the outflow valves are fully open.

If a throttle is set above 54° PLA, the controller commands the pressure increase signal set on the RATE knob. This closes the conditioning valves, cutting off airflow to the cabin. The out-flow valves close, but cabin pressure does not vary.

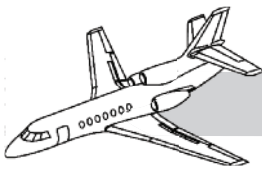

ELECTROPNEUMATIC OUTFLOW VALVE OPERATION

Two outflow valves are installed at the rear of the cabin (Frame 28) (Figure 12-6). The electropneumatic outflow valve, located on the LH side, is primary during the normal, or automatic, mode. It is controlled by signals from the automatic pressurization controller installed on the instrument panel. The RH outflow valve is pneumatic and is slaved to the electropneumatic valve during automatic operation, but becomes primary during manual operation.

PROTECTION AGAINST OVER-PRESSURE

A pressure sensor (on each outflow valve) senses both cabin and static pressure. When Δp reaches 9.1 ± 0.1 psid, a pressure relief valve opens and, in turn, opens the outflow valve.

The airflow increases and prevents cabin pressure from exceeding that value. On aircraft with SB 163 (increased cruise altitude to FL 490) the overpressure relief is 9.5 psid.

CABIN MAXIMUM PRESSURE ALTITUDE PROTECTION

A cabin pressure sensor is also installed on each outflow valve. When it senses a cabin pressure altitude above $12,500 \pm 500$ feet, a valve opens to allow cabin pressure to be sensed by the pilot pressure chamber. The outflow valve closes, decreasing or stopping the airflow, to maintain the cabin pressure altitude at approximately 12,500 feet. On aircraft with SB 154 (increase of take-off field altitude) the outflow valves are modified to maintain the cabin pressure altitude at approximately 14,500 feet.

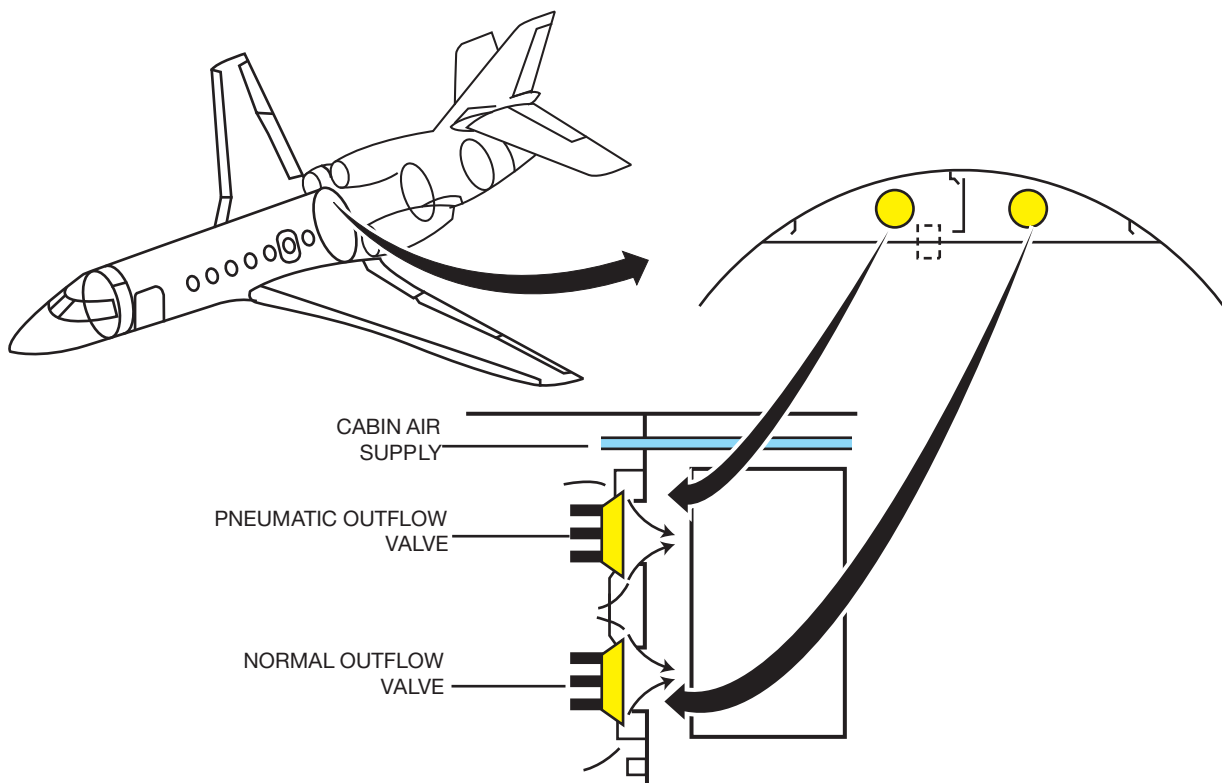
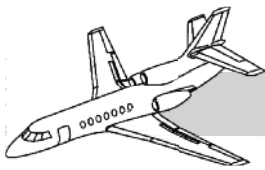

Figure 12-6. Outflow Valves



ANTI-NICOTINE FILTER

An anti-nicotine filter, installed on the cabin air inlet to the outflow valves, protects the chamber against nicotine contamination.

MANUAL PRESSURIZATION SYSTEM

The manual system operates from the cabin manual pressure selector and the manual outflow valve. Both of these components operate pneumatically.

The manual mode is selected by moving the guarded PRESSURIZATION switch (Figure 12-7) to MAN. This removes power from the automatic pressure controller and the electro-pneumatic outflow valve torque motor. That valve will then function as a slave to the pneumatic valve, by pressure within an interconnection. The manual outflow valve servo pressure is controlled by a pneumatic relay which senses cabin pressure relative to the manual pressure selected. The difference between cabin pressure and the manual reference pressure (which is always lower than or equal to cabin pressure) determines the valve position.

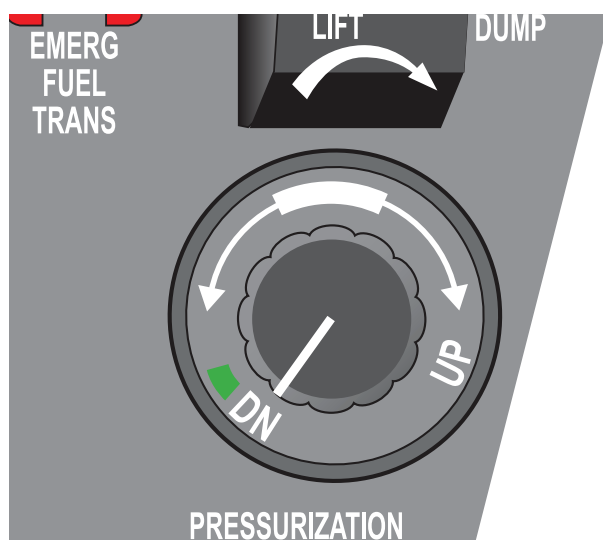

Figure 12-7. Manual Operation

MANUAL PRESSURE CONTROLLER

The manual controller is located on the instrument panel (Figure 12-7) below the automatic controller. When the control is set opposite DN (the green sector), the system will be directed to a setting of $-1,000$ feet per minute. When set opposite UP, it will establish a $+1,500$ feet-per-minute setting. Moving it all the way clockwise to the stop, it goes as high as $+2,500$ feet per minute. Near the center of the white band, there is a position of no rate of change.

NOTE

When operating in automatic mode, keep the manual regulator set to DN. If there is an electrical power failure to the automatic controller, the emergency outflow valve will respond to this DN signal and cause the cabin pressure to change at a rate of $-1,000$ feet per minute.

MANUAL PNEUMATIC OUTFLOW VALVE

This valve is mounted on the right side of the cabin. It operates exactly like the normal outflow valve except that the torque motor is replaced by a pneumatic relay. In automatic mode, the relay is inoperative. The pneumatic valve slaving pressure is equal to that of the electropneumatic valve, due to a crossfeed pipe, but there is a built-in delay. Therefore, in automatic mode, the manual valve is slaved to the position of the normal valve. Pressure relief function is identical with that of the normal valve.

RAPID DEPRESSURIZATION (DUMP) FUNCTION

Rapid depressurization can be accomplished using either of the two outflow valves. If the PRESSURIZATION switch is moved to DUMP (after moving the guard to the right as

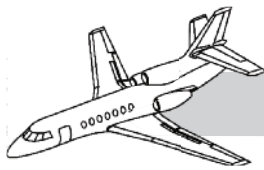

in Figure 12-8), power is supplied directly from A bus to the electropneumatic valve torque motor, opening the valve to the outside. When this procedure is used, the 12,500-foot maximum pressure altitude protection is still retained. There will be a very rapid rate-of-pressure change.

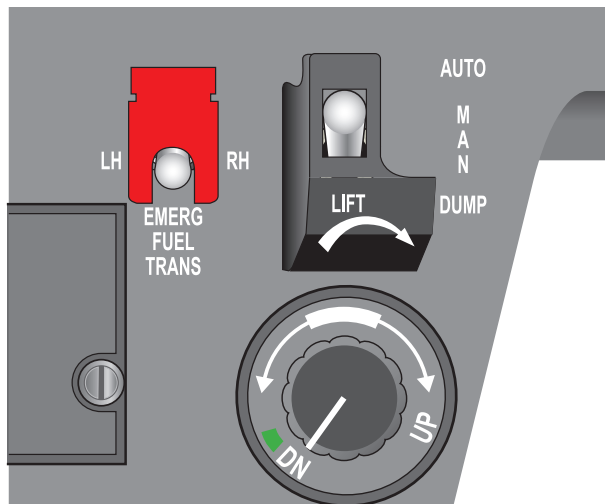

Figure 12-8. DUMP Position

If the automatic mode is not operational, pressure can be dumped by positioning the PRESSURIZATION switch to MAN and rotating the manual regulator knob fully clockwise. That allows a pressurization change of approximately +2,500 feet per minute.

INDICATIONS AND PROTECTION DEVICES

TRIPLE CABIN PRESSURE INDICATOR

The triple cabin pressure indicator (Figure 12-9) is located on the instrument panel to the right of the automatic pressure controller. This indicator displays:

- Pressure differential (Δp)
- Cabin altitude
- Cabin rate of change



Figure 12-9. Triple Indicator

The pressure differential scale (marked DIFF PRESSURE PSI) is at the right side of the instrument face, calibrated between -1 and $+10$ psid. Between 8.9 and 9.2 psid, the scale is outlined in amber. Between 9.2 and 10 psid, the scale is outlined in red.

A cabin altitude scale is concentric with the Δp scale, and marked ALTITUDE 1000 FT. It is calibrated between $-1,000$ and $50,000$ feet. Between $8,000$ and $10,000$ feet, the scale is amber. It changes to red above $10,000$ feet. The third indicator is a rate-of-change scale, located at the left portion of the instrument. It is calibrated to show $\pm 2,000$ feet per minute. Between -500 and $+700$ feet per minute, there is a green bar. This scale is used to check the manual regulator operation and also displays the rate of change when the manual mode is selected.

AUDIBLE AND VISUAL WARNINGS

In normal operation, the cabin altitude should never exceed $8,000$ feet, which corresponds to a pressure differential of 8.8 psid at $45,000$ feet flight altitude. If the cabin altitude reaches $10,000$ feet, indicating an abnormal opera-

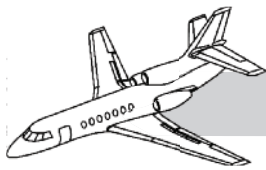

tion, warning is given by the illumination of the CABIN light on the master warning panel and a 250-Hz audible tone. These indications are initiated by a pressure-sensitive switch set for 10,000 (± 500) feet, cabin altitude. The indications can be checked by depressing a test button, and the horn may be silenced using the HORN SILENCE pushbutton.

BAGGAGE COMPARTMENT PRESSURIZATION

The baggage compartment pressurization is controlled by the BAG switch on the overhead bleed air panel. The compartment can be pressure isolated by selecting OFF on that switch. This will close two valves: one which passes hot conditioned air and another which interconnects the baggage and passenger compartments.

Each valve is connected to one of two amber indicator lights, which are located on the mechanic's test panel.

Both positive and negative pressure-relief valves are installed. Pressure relief occurs at +9.3 psid positive pressure, and at -0.3 psid negative pressure. These valves supplement the existing protection available if the cabin interconnect valve is open.

LIMITATIONS

The maximum differential pressure is 9.1 psid. Maximum differential pressure in the baggage compartment is 9.3 psid. Negative pressure relief is -0.3 psid. Nose cone pressure relief is 3.65 psid.

On aircraft with SB 163, the maximum differential pressure is 9.5 psid. Also, with this service bulletin the maximum differential pressure in the baggage compartment is increased to 9.7 psid.

The pressurization system controls and relationship is shown in Figure 12-10.

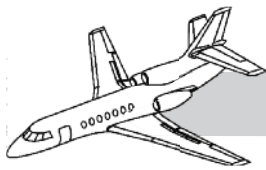

QUESTIONS

1. While on the ground, with the settings prepositioned in the automatic pressure controller, which statement is correct?
 - A. The cabin altitude, positioned by the ALT knob, will establish the ground pressurization.
 - B. If no engine throttle is set above 54° PLA, the outflow valves are closed and pressure builds up according to the setting of the RATE knob.
 - C. With any throttle above 54° PLA, the outflow valves close and cabin pressure does not vary.
 - D. Cabin pressurization is controlled by the manual knob during all ground operations.
2. **SITUATION: IN FLIGHT—AUTOMATIC PRESSURIZATION THEN: ELECTRICAL POWER IS LOST TO THE AUTOMATIC REGULATOR**
 - A. The aircraft will immediately depressurize.
 - B. The pneumatic emergency outflow valve assumes control of the pressurization, in response to manual regulator knob movement.
 - C. Emergency-manual operation is not possible until the PRESSURIZATION switch is moved to MANUAL.
 - D. An immediate descent to 14,000 feet is required.
3. The PRESSURIZATION switch is moved to DUMP, even though the torque motor and all electrical power are normal. What value will the cabin pressure altitude assume?
 - A. It will automatically stabilize at 12,500 feet if the aircraft is above that altitude.
 - B. It will depressurize the aircraft.
 - C. It will respond to the setting on the manual regulator knob.
 - D. DUMP will have no effect if the outflow valves are operational.
4. When using the automatic pressure controller, where should the manual control knob be positioned?
 - A. It makes no difference.
 - B. Full CW (UP position)
 - C. Centered in the white area
 - D. At the DN end, in the green index

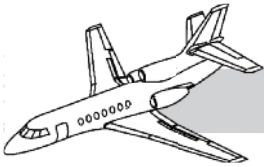

CHAPTER 13

HYDRAULIC POWER SYSTEMS

CONTENTS

	Page
INTRODUCTION.....	13-1
GENERAL.....	13-1
MAIN HYDRAULIC SYSTEM NO. 1.....	13-3
MAIN HYDRAULIC SYSTEM NO. 2.....	13-4
CONTROL AND INDICATION.....	13-5
AUXILIARY HYDRAULIC SYSTEM.....	13-5
General.....	13-5
Operation.....	13-5
QUESTIONS.....	13-8

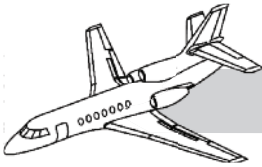

ILLUSTRATIONS

Figure	Title	Page
13-1	Hydraulic System Block Diagram.....	13-2
13-2	Hydraulic Reservoir.....	13-3
13-3	Hydraulic System Control and Display Panel.....	13-4
13-4	Electrical Pump Selector Valve	13-6

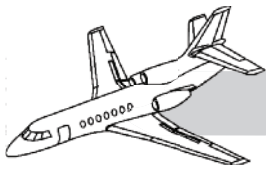

CHAPTER 13

HYDRAULIC POWER SYSTEMS



INTRODUCTION

The Falcon 50 has two separate and independent hydraulic systems. Main system No. 1 uses self-regulating pumps driven by engines No. 1 and 2. The No. 3 engine drives a pump which powers main system No. 2. An electrical auxiliary pump, located in the rear compartment, serves as a standby source of power for system No. 2. The auxiliary pump may be operated to perform a ground test for system No. 1.

GENERAL

Figure 13-1 is a simplified schematic of hydraulic pressure usage. Main systems No. 1 and No. 2 are in the upper left and right, respectively, represented by their reservoirs. System No. 1 utilizes two self-regulating pumps, one each driven by engines No. 1 and No. 2. System No. 2 is powered by a self-regulating pump, driven by the No. 3 engine. An electric pump is installed in the No. 2 hydraulic system as a backup pump in case the

No. 3 engine hydraulic pump fails or the No. 3 engine is shut down.

The electrical pump normally functions as the backup to main system No. 2, as portrayed in Figure 13-1. It may be selected on the ground to power main system No. 1, but only for a system ground test.

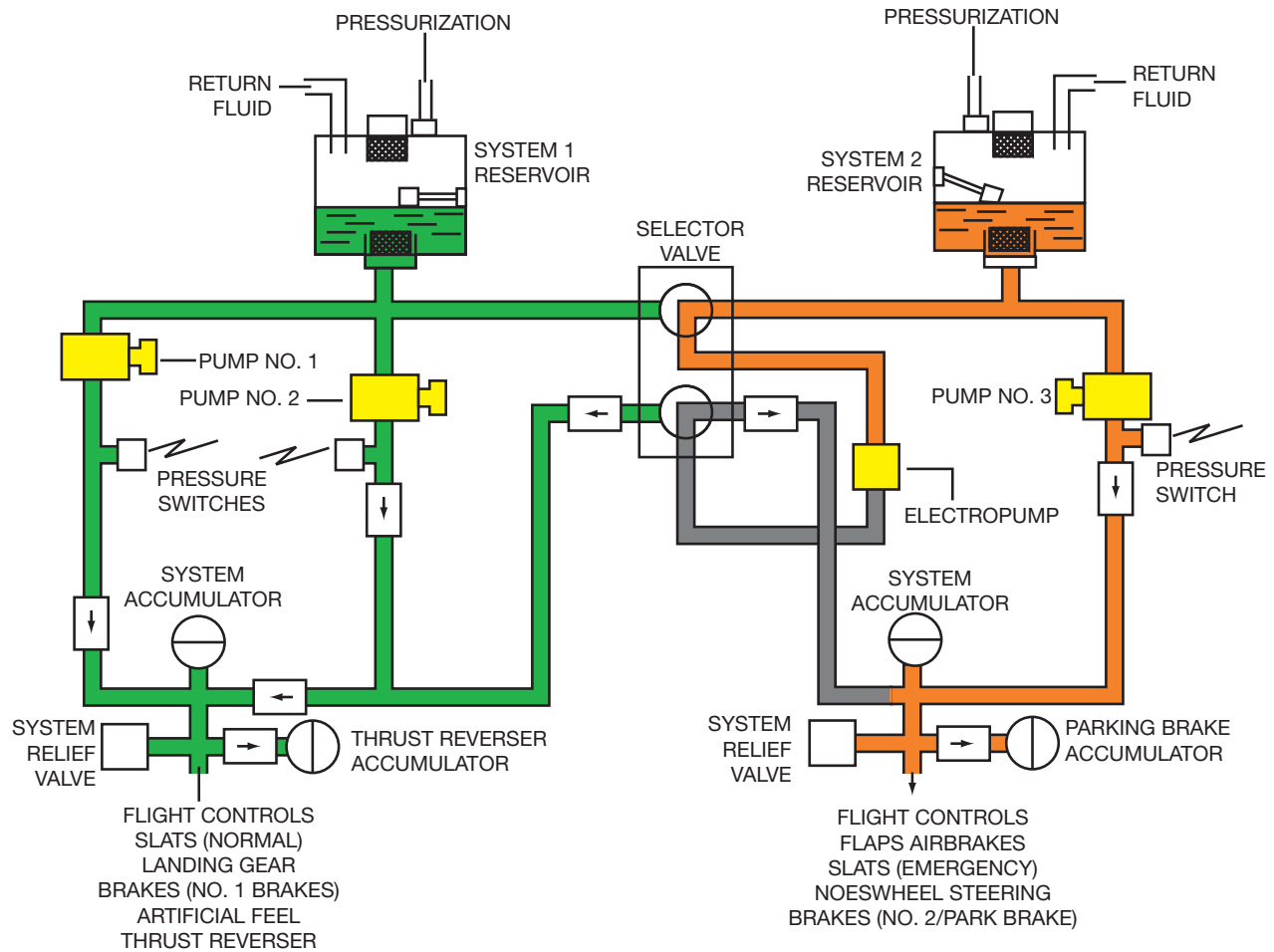
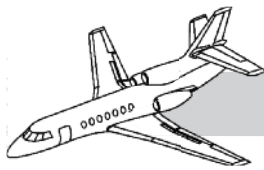

Figure 13-1. Hydraulic System Block Diagram

System No. 1 provides power to the following units:

- One barrel of each dual servo-actuator for the elevator, aileron, and rudder power servo unit
- Arthur Q units, which are variable bell-cranks associated with the artificial feel units for the roll and pitch channels
- Inboard and outboard slats—Both leading-edge drives use system No. 1 pressure for normal operation. The outboard slats can also use system No. 1 pressure for automatic operation.
- Normal brakes and antiskid
- Thrust reverser on engine No. 2

- Landing gear and landing gear doors

System No. 2 provides hydraulic power to the following units:

- The second barrel of each dual servo-actuator in the three primary flight control axes
- Flaps—Each wing, has an inboard and outboard flap.
- Airbrakes—There are three on each wing, located at the aft portion of the upper surface.
- Outboard Slats—Standby operation uses system No. 2 power. Automatic operation uses system No. 2 as well as system No. 1.

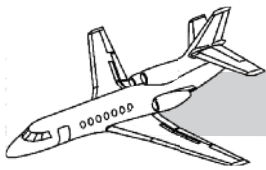

- Nosewheel steering
- Emergency and parking brakes—Emergency brakes do not have antiskid capability. The parking brake can also be powered by an accumulator.

MAIN HYDRAULIC SYSTEM NO. 1

The No. 1 system reservoir is located on the left-hand side of the rear compartment. It is capable of storing 3.65 U.S. gallons of MIL-H 5606 (AIR 3520) fluid. The normal level, however, as seen in the sight gage window (Figure 13-2), is 2.62 U.S. gallons. The reservoir is pressurized by engine bleed air. A pressure switch illuminates an amber TK P1 (Tank Pressure 1) light on the cockpit hydraulic panel if the bleed air pressure drops below a preset value.

Fluid from the No. 1 reservoir is distributed by the engine-driven pumps on engines No. 1 and No. 2 at a nominal pressure of 3,000 psi (206 bars). In the rear compartment, each pump has a corresponding pressure relief

valve. If the pressure regulation system within the self-regulating pump fails, the valve protects the system when an increasing pressure of 3,500 (± 100) psi (245 bars) is sensed. A decreasing signal of approximately 3,400 psi (235 bars) allows the system to return to normal operation.

The system No. 1 accumulator is located in the left-hand section of the aft compartment with the other No. 1 system components. It has a fluid capacity of 50 cubic inches (393 cubic centimeters). The accumulator has a nitrogen precharge of 1,470 psi (100 bars) which is read on a self-contained pressure gage. The accumulator absorbs the pulsation of the self-regulating pumps, maintaining a steady pressure, and provides a reserve source of pressure within its own system.

Each engine-driven pump has a corresponding pressure switch. Each switch, located in the rear compartment, sends a signal to the cockpit hydraulic panel if it senses a decreasing discharge pressure of 1,500 psi (± 50) (103 bars) from its respective pump. The signal illuminates the respective amber PMP 1, PMP 2, or PMP 3 light

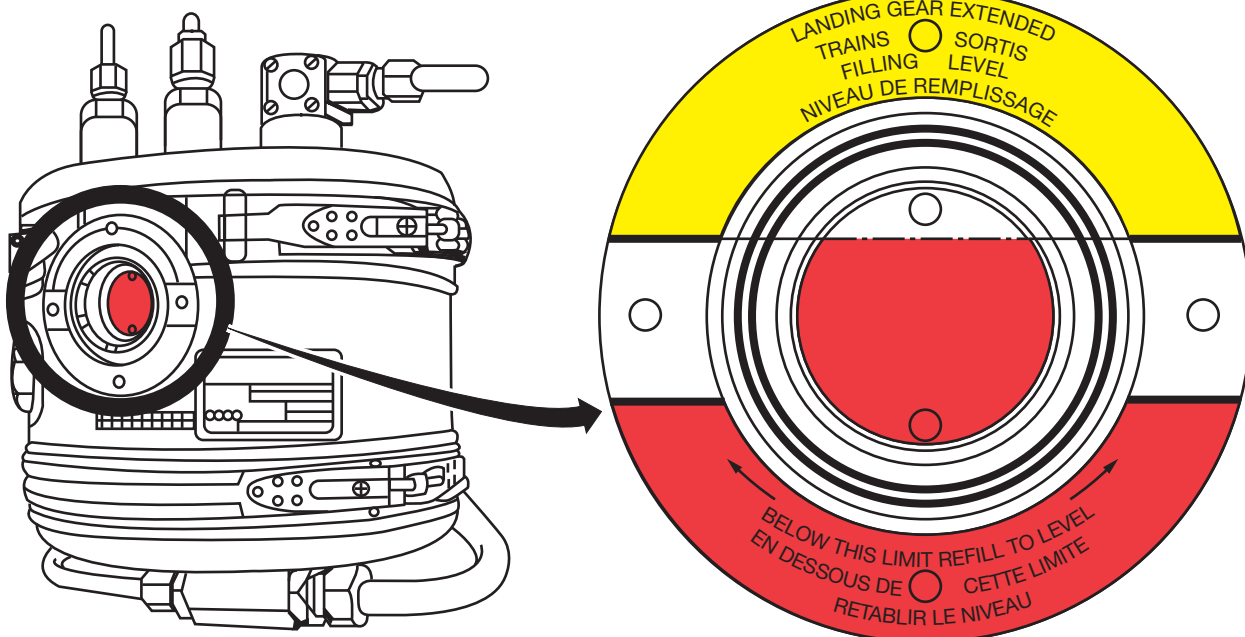
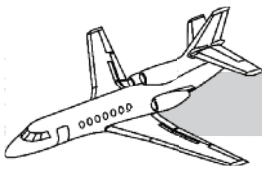

Figure 13-2. Hydraulic Reservoir



(Figure 13-3). An increasing pressure of 2,150 psi (± 100) (148 bars) turns off the light.

A ground hydraulic connection is located on the left side in the rear compartment.

of a second engine-driven pump. The system No. 2 components are located on the right-hand side of the rear compartment. This system can also receive hydraulic pressure from a ground cart through connectors on the right-hand side of the fuselage. A check valve isolates the two systems and prevents fluid transfer. The No. 2 system accumulator is also precharged to 1,470 psi.

MAIN HYDRAULIC SYSTEM NO. 2

The system No. 2 components and operation are almost a duplicate of the No. 1 system, except for an electrical auxiliary pump instead

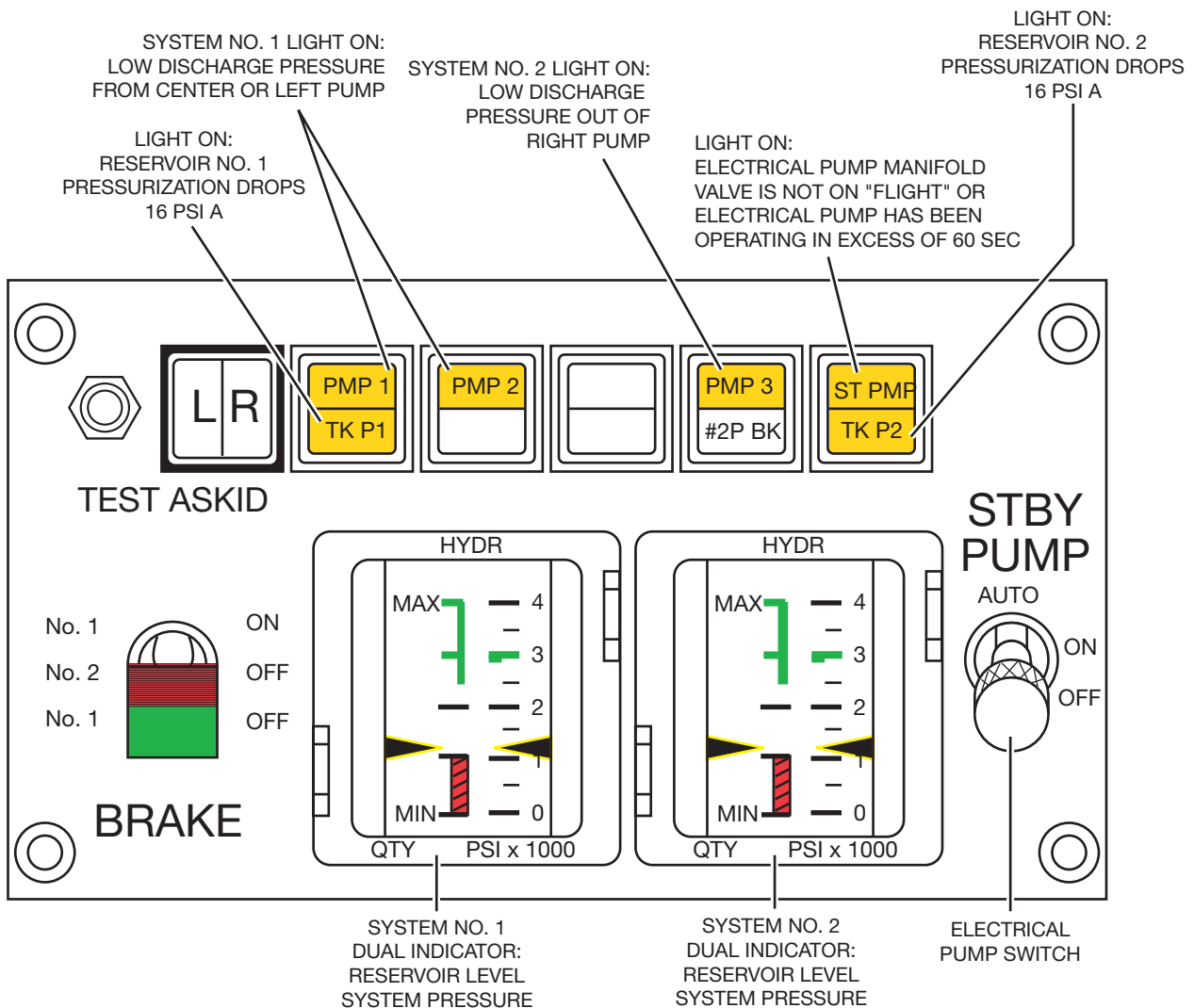
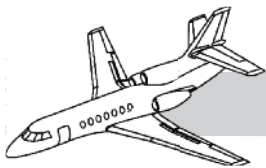

Figure 13-3. Hydraulic System Control and Display Panel



CONTROL AND INDICATION

The hydraulic system control and display panel is located on the cockpit front panel (Figure 13-3).

There are four pump indicator lights across the top of the panel. PMP 1, 2, and 3 correspond to the engine-driven pumps of the main hydraulic systems. They illuminate when the respective pump discharge pressure drops to 1,500 (± 50) psi, and go off when increasing pressure reaches 2,150 (± 100) psi. The fourth light, labeled "ST PMP" (standby pump), illuminates after the electrical pump has been operating continuously for sixty seconds. It also lights to denote the position of the standby pump valve switch, which will be discussed later.

On the second row are TK P1 and TK P2 (tank pressure 1 and 2), which come on when the respective reservoir head pressure drops below a preset figure.

The two dual indicators display reservoir fluid level and system output pressure for each main system.

The switch labeled STBY PUMP is the cockpit control for the electrical pump. The operation of the standby pump will be covered in the section on the auxiliary system.

AUXILIARY HYDRAULIC SYSTEM

GENERAL

The auxiliary hydraulic system, consisting of an electrical pump and a control valve, has three purposes. They are:

1. To aid or back up main hydraulic system No. 2
2. To be automatically operated by the air-brake system in flight, and to supply all loads normally supplied by No. 2 system should the engine-driven pump fail.
3. To allow ground testing of hydraulic system No. 1

The electrical pump is controlled by the STBY PUMP switch on the hydraulic control and display panel.

OPERATION

With the cockpit switch in the OFF position, electrical power is removed from the standby pump. With the switch in other than OFF position, the electrical pump is capable of operation. It draws fluid from the reservoir of whichever system it is powering, and its output pressure is displayed on the applicable indicator.

The system to be powered is selected by positioning the electrical pump selector valve to the IN FLIGHT or GROUND TEST position.

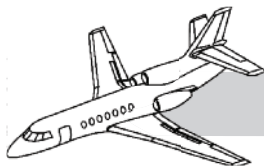

The selector valve is located in the rear compartment, and is normally safety-wired to the IN FLIGHT position (Figure 13-4).

When the valve is positioned to GROUND TEST, it tests system No. 1. Switching the STBY PUMP switch in the cockpit to ON or AUTO allows the electrical pump to operate using system No. 1 fluid and display. During the test, the STBY PUMP indicator light is continuously illuminated.

CAUTION

Do not move the valve control lever while the electrical pump is running.

Normal operation is conducted with the selector valve control set and safety-wired to the IN FLIGHT position. This allows the standby pump to provide hydraulic pressure to the No. 2 system when the system pressure goes below 1500 psi.

Standby Operation

For flight operations of the Falcon 50, the standby pump selector valve must be set in the IN FLIGHT position and the cockpit STBY PUMP switch set to AUTO. In this configuration and with the PUMP 3 light illuminated, due to a drop of system pressure below 1,500 psi and the airbrakes selected to position 1 or 2, the standby pump will automatically run to

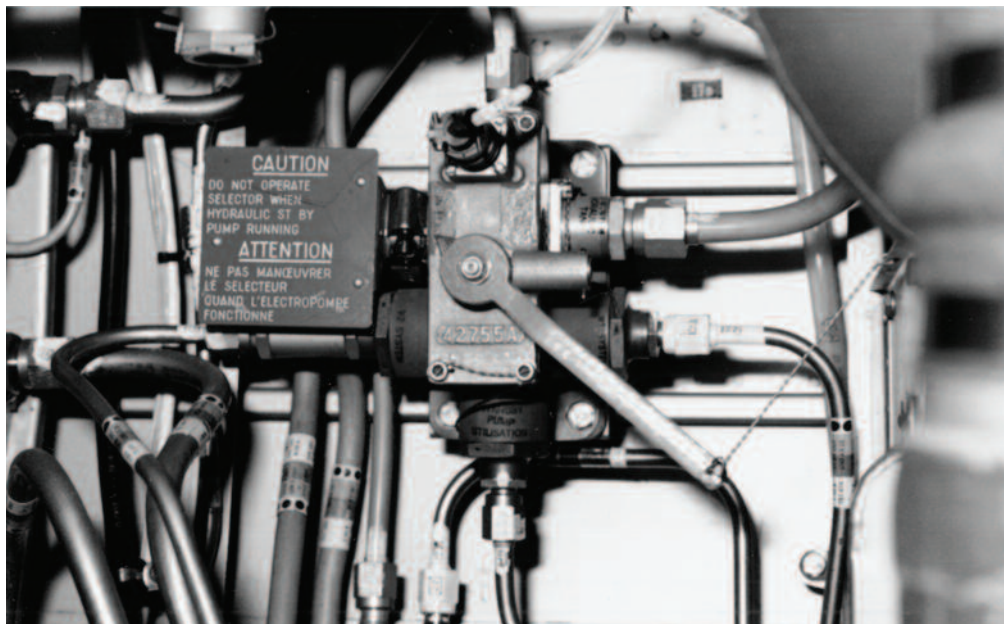
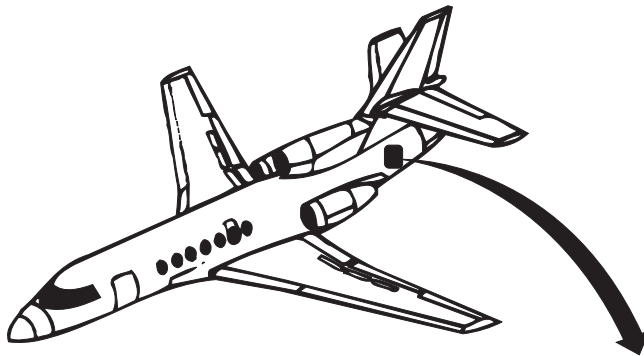
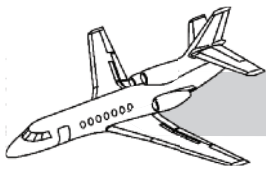

Figure 13-4. Electrical Pump Selector Valve



power the airbrakes. LH main DC bus power will be applied to start the standby pump, allowing it to draw fluid from system No. 2 reservoir and pressurize system No. 2.

Automatic Operation

The automatic operation has two different applications, depending on the compression of the left strut. The first is operation with the strut compressed (aircraft on the ground); the second is aircraft in flight.

On Ground

The selector valve is positioned to IN FLIGHT, and the STBY PUMP switch is positioned to either AUTO or ON. Since the strut is compressed, the proximity sensors allow power through to a control relay. If system No. 2 pressure drops below 1,500 psi, the electrical pump is automatically activated. Pressure will cycle between 1,500-2,150 psi.

In Flight

With the selector valve set to IN FLIGHT, and the cockpit switch in AUTO, but the landing gear either extended fully or retracted, the strut proximity sensors operated microswitch will not pass voltage. In this mode, the automatic function is triggered by airbrake operation. When the airbrake lever is moved away from the retracted position, standby pump power is made available through a different microswitch. Then, if system No. 2 drops below 1,500 psi, the electrical pump automatically activates. If the ON position were selected, you would have the same operation as covered in the on-ground description.

The STBY PUMP light illuminates when the electrical pump has been operating in excess of 60 seconds of continuous operation.

NOTE

Standby pump requires A bus power for control plus power from the left main bus bar to power the motor which turns on the pump. The power supply circuit is protected by a 100A current limiter on the left main bus.

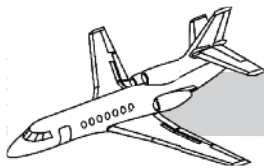

QUESTIONS

1. If the No. 1 system reservoir loses its pressurization:
 - A. TANK PRESS 1 light on the master warning panel illuminates.
 - B. TANK PRESS light on the hydraulic system control and display panel illuminates.
 - C. TANK PRESS 1 light on the hydraulic system control and display panel illuminates.
 - D. There is no light indication.
2. How may hydraulic fluid be transferred between systems No. 1 and No. 2?
 - A. By depressing the fluid transfer button on the hydraulic panel
 - B. By an automatic device built into the system
 - C. Fluid cannot be transferred between systems.
 - D. By pulling the emergency transfer handle
3. Hydraulic pressure light PMP 1, if on, indicates:
 - A. Loss of hydraulic system No. 1
 - B. Loss of the engine-driven pump
 - C. Normal hydraulic pressure
 - D. Loss of hydraulic system No. 2
4. There is a selector valve in the rear compartment labeled IN FLIGHT and GROUND TEST. Which statement is true?
 - A. There is no cockpit light indication to show the position of the valve.
 - B. When the valve is set to IN FLIGHT, it allows the standby electrical pump to power either system, as selected in the cockpit.
 - C. It is always set to GROUND TEST for all ground operations.
 - D. It will be safety-wired to IN FLIGHT to allow the standby pump to back up system No. 2 during inflight operation.
5. The selector valve is in the IN FLIGHT position, and the STBY PUMP switch on the hydraulic system control panel is in AUTO. Which sentence is correct?
 - A. During flight conditions, the standby pump automatically takes over the No. 2 system whenever the No. 2 system pump fails.
 - B. On the ground, the standby pump automatically assumes the load of the No. 2 system, if necessary.
 - C. In flight, the electrical standby pump supplements speedbrake operation regardless of system No. 2 capability.
 - D. On the ground, the standby pump is available to test system No. 1 operation.

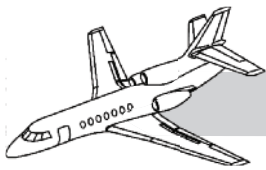

CHAPTER 14

LANDING GEAR AND BRAKES

CONTENTS

	Page
INTRODUCTION.....	14-1
LANDING GEAR	14-2
General	14-2
Control and Indication.....	14-2
Emergency Extension.....	14-9
WHEEL BRAKES.....	14-10
General	14-10
Control and Indication	14-12
Normal Brakes with Antiskid	14-13
Landing Gear Retraction—Automatic Braking.....	14-13
NOSEWHEEL STEERING.....	14-15
General	14-15
Control	14-15
GROUND PROXIMITY SENSORS.....	14-15
QUESTIONS	14-17

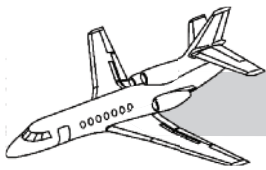

ILLUSTRATIONS

Figure	Title	Page
14-1	Landing Gear and Doors	14-2
14-2	Landing Gear Control.....	14-3
14-3	Light Indications.....	14-3
14-4	Light Sequence—Retraction.....	14-5
14-5	Light Sequence—Extension	14-6
14-6	Normal Gear Operation Schematic (Landing Gear Down and Locked).....	14-7
14-7	Normal Gear Operation Schematic (Landing Gear Retracting—Initial Phase).....	14-8
14-8	Emergency Gear Extension Schematic	14-10
14-9	Manual Gear Unlocking Handles.....	14-11
14-10	Braking Control and Indicator	14-12
14-11	Braking Schematic	14-14
14-12	Nose Steering Handwheel Location.....	14-15
14-13	Nose Gear Coupling Link	14-16

TABLES

Table	Title	Page
14-1	Emergency Extension	14-9
14-2	Ground Proximity Warning Switches	14-16

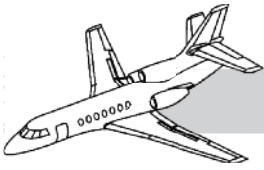

CHAPTER 14

LANDING GEAR AND BRAKES

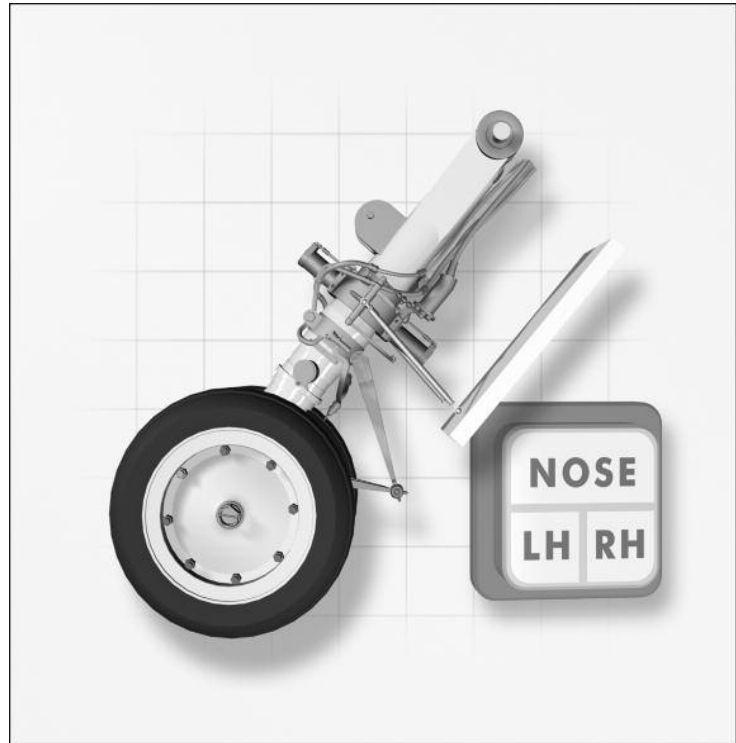

INTRODUCTION

The Falcon 50 has fully retractable, tricycle landing gear. Retraction and extension of the landing gear, and opening and closing of the main wheel doors is hydraulically powered by the No. 1 main hydraulic system. A backup mechanical-hydraulic system opens the doors and extends the gear, and an emergency mechanical system unlocks the doors and landing gear.

Each of the four main wheels has its own hydraulic brake. System No. 1 powers normal braking, while system No. 2 supplies pressure for an emergency brake system and for the parking brake. Antiskid capability functions only when the No. 1 system is in operation. During landing gear retraction, pressure is applied to the normal brakes using No. 1 system pressure.

A steerable nosewheel is operated by a handwheel at the pilot position with up to 60° of steering control either side of centerline. Nosewheel steering pressure is supplied by the No. 2 system.

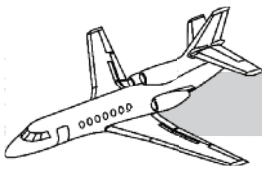

LANDING GEAR

GENERAL

Figure 14-1 shows the retractable tricycle landing gear. Each gear has two wheels. Some of the wheel well doors are hydraulically activated, and the rest operate mechanically.

Retraction and extension of the gear assemblies, and opening and closing of the doors are controlled from the cockpit through an electrohydraulic system. This system has a backup mechanical-hydraulic system to open the doors and extend the gear assemblies, and an emergency mechanical system to unlock the main gear doors and the landing gear.

CONTROL AND INDICATION

Normal retraction and extension of the landing gear and opening and closing of the wheel well doors is controlled electrohydraulically from the cockpit (Figure 14-2). Normal operation uses power from the No. 1 hydraulic system.

Light Indications

The red LH and RH rectangular indicators each illuminate when the respective gear door is not closed and locked (Figure 14-3).

The red NOSE rectangular indicator illuminates when the nose gear is neither up and locked nor down and locked.

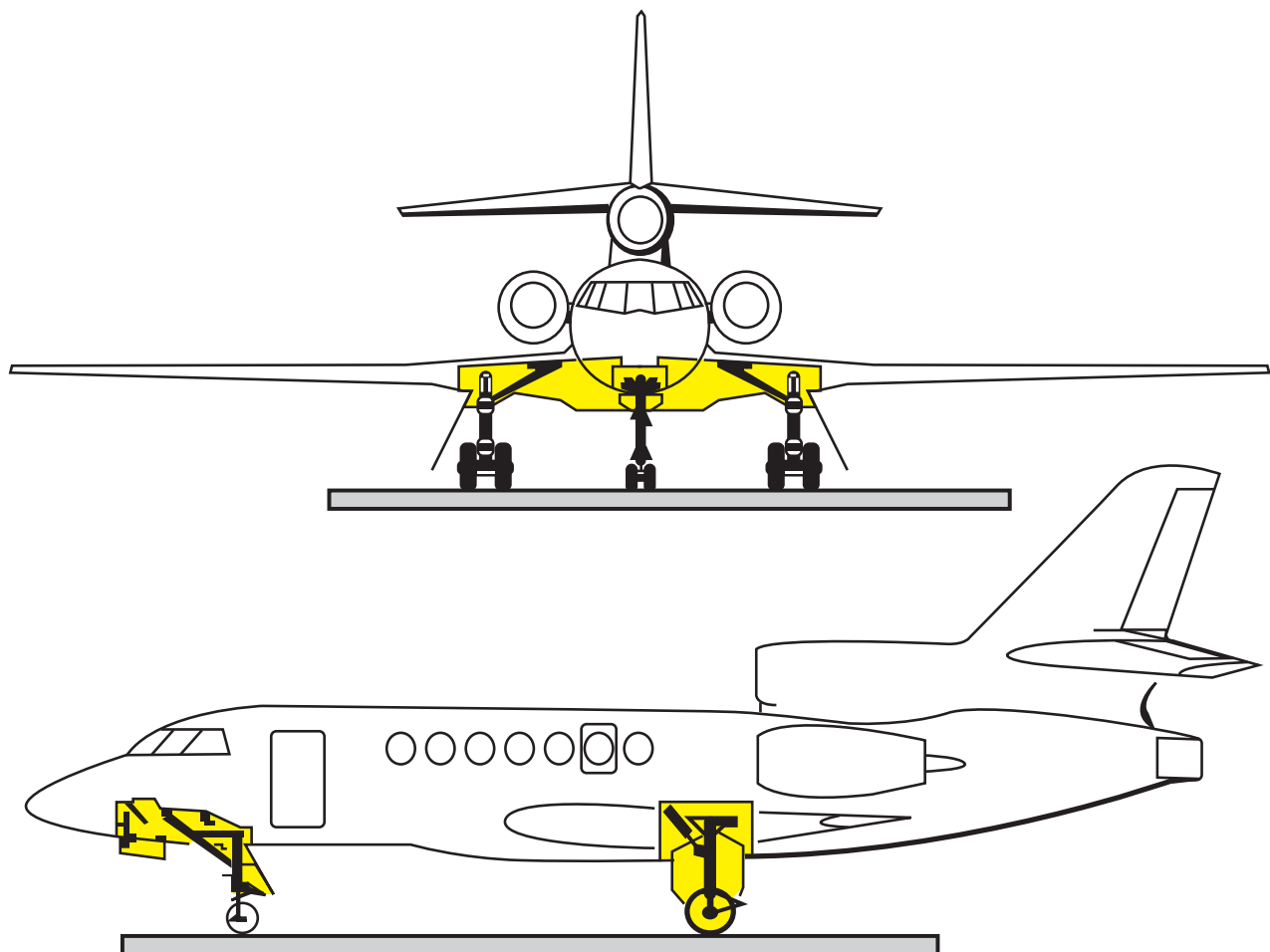

Figure 14-1. Landing Gear and Doors

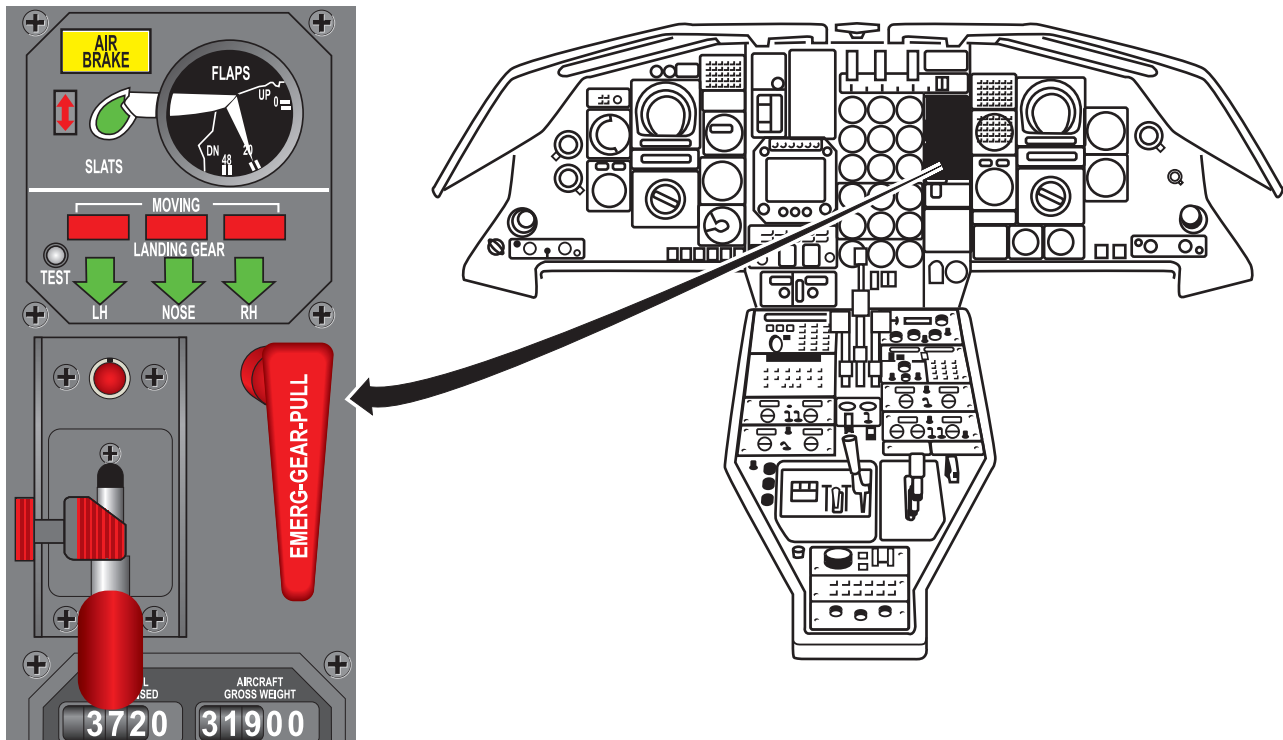
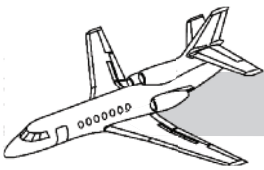

Figure 14-2. Landing Gear Control

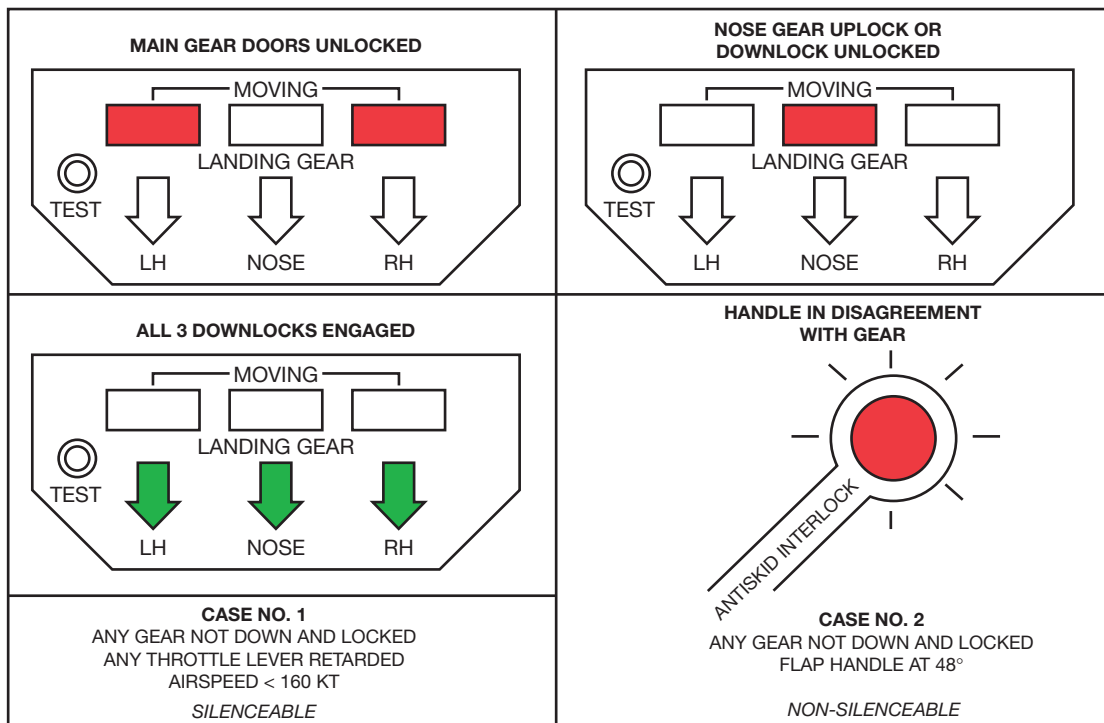
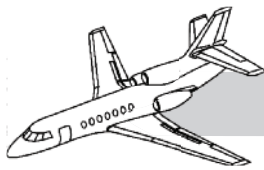

Figure 14-3. Light Indications



All three green lights are triggered by sensors in the downlock.

A flashing red toggle light on the landing gear selector indicates that the selector handle is not in agreement with the position of one or more gear. It also flashes in conjunction with the aural tone when the gear is not downlocked, a throttle is retarded, and airspeed is below 160 knots.

Aural Indications

The Falcon 50 has an aural warning annunciator to provide a continuous tone under the following circumstances:

- One or more landing gear is not locked down, while any one throttle lever is retarded to reduced thrust and the airspeed is less than 160 knots. This warning tone can be silenced by pushing the cutout button.
- One or more of the landing gear is not locked down and the flap control lever is set for 48° of flaps (landing configuration). This warning cannot be silenced except by changing the gear or flap configuration.

Test the warning tone by activating the push-button on the configuration panel.

Normal Retraction

When the landing gear is down and locked on the ground, the three green arrow-shaped lights are all on.

When the gear is down and aircraft weight-on-wheels is felt by the proximity sensors in the gear legs, an electrical lock within the selector handle precludes retraction on the ground. There is a manual release in case the electrical interlock malfunctions.

Immediately after lift-off, the expansion of left and nose gear shock absorbers releases the electromagnetic lock preventing retraction on the ground. The steering system selector valve is no longer energized. Figure 14-4 shows the sequence of light indications.

Retraction starts when the landing gear selector is moved to the UP position. When the handle is up, and the assemblies are still down, there is incompatibility between the selector and the assemblies, causing the toggle lights to flash.

Moving the control handle upwards (retraction) modifies the proximity switch status and enables the following sequence:

1. The control handle light flashes.
2. The brake antiskid system is no longer energized.
3. The landing gear extension solenoid of the selector valve is no longer energized.
4. The hydraulic pressure in the gear actuating cylinders (on gear extension side) drops.
5. The door-opening solenoid of the selector valve is energized.
6. Main doors unlock and open. RH and LH MOVING lights come on.

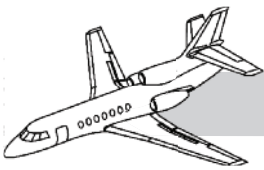

7. The gear retraction solenoid of the selector valve is energized.
 8. The gear unlock and the green LH, NOSE, and RH lights go out.
- The red center light (nose gear) comes on.
9. The gears retract and uplock. The control handle light and the red center light go out.
 10. The door-closing solenoid of the selector valve is energized.
 11. The landing gear retraction solenoid of the selector valve is no longer energized. The hydraulic pressure in the actuating cylinders drops.
 12. Main doors close and uplock. The LH and RH MOVING lights go out.
 13. The door-closing solenoid of the selector valve is no longer energized. Hydraulic pressure is withdrawn from the gear and door assemblies, as all uplocks are mechanical.

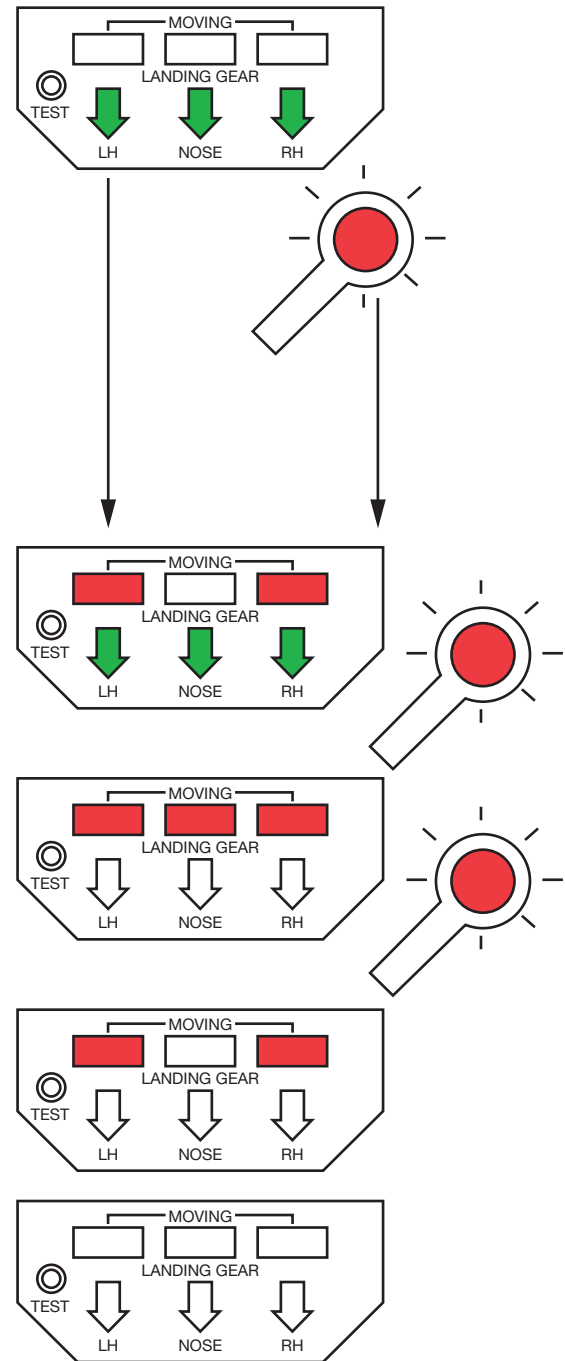
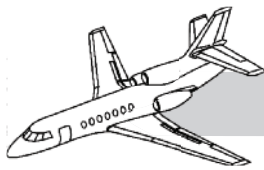

Figure 14-4. Light Sequence—Retraction



Normal Extension

Moving the control handle downwards (extension) modifies the proximity switch status and enables the following sequence (Figure 14-5):

1. The brake antiskid system is energized.
2. The control handle light flashes. The warning is triggered if the IAS is less than or equal to 160 knots and if at least one power lever is in the reduced position.
3. The door-opening solenoid of the selector valve is energized.
4. Doors unlock and open. The RH and LH MOVING red lights come on.
5. The gear extension solenoid of the selector valve is energized.
6. The gears unlock and extend. The red center light comes on.
7. The gears downlock (extension). The green LH, NOSE, and RH lights come on, and the red center light goes out. The gear extension solenoid of the selector valve remains energized. The hydraulic pressure is maintained in the main gear and nose gear actuating cylinders.
8. The control handle flashing light goes out.
9. The main door-closing solenoid of the selector valve is energized.
10. Main doors close and lock. The red RH and LH MOVING lights go out.
11. Hydraulic pressure to the door-actuating cylinders is cut off.

On landing, compression of the left and nose gear shock absorbers locks the control handle in the downlock position (extension). The electromagnetic lock is no longer energized. The nosewheel steering electrical circuit is energized, and the steering system can be used.

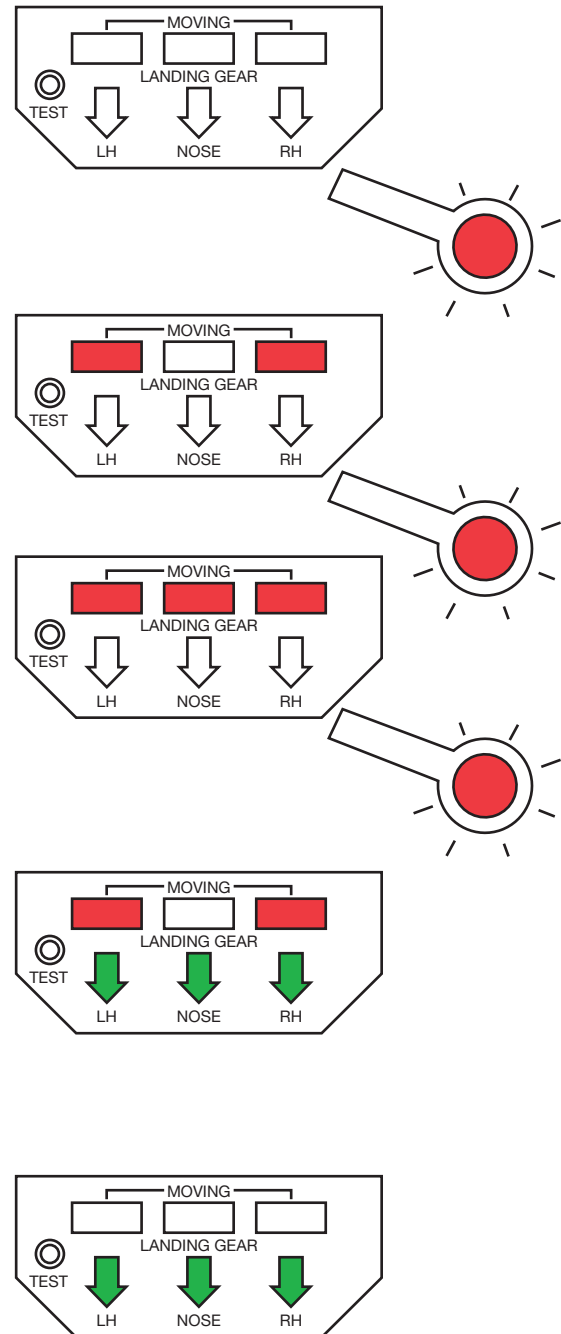

Figure 14-5. Light Sequence—Extension

Figures 14-6 and 14-7 further illustrate normal gear operations.

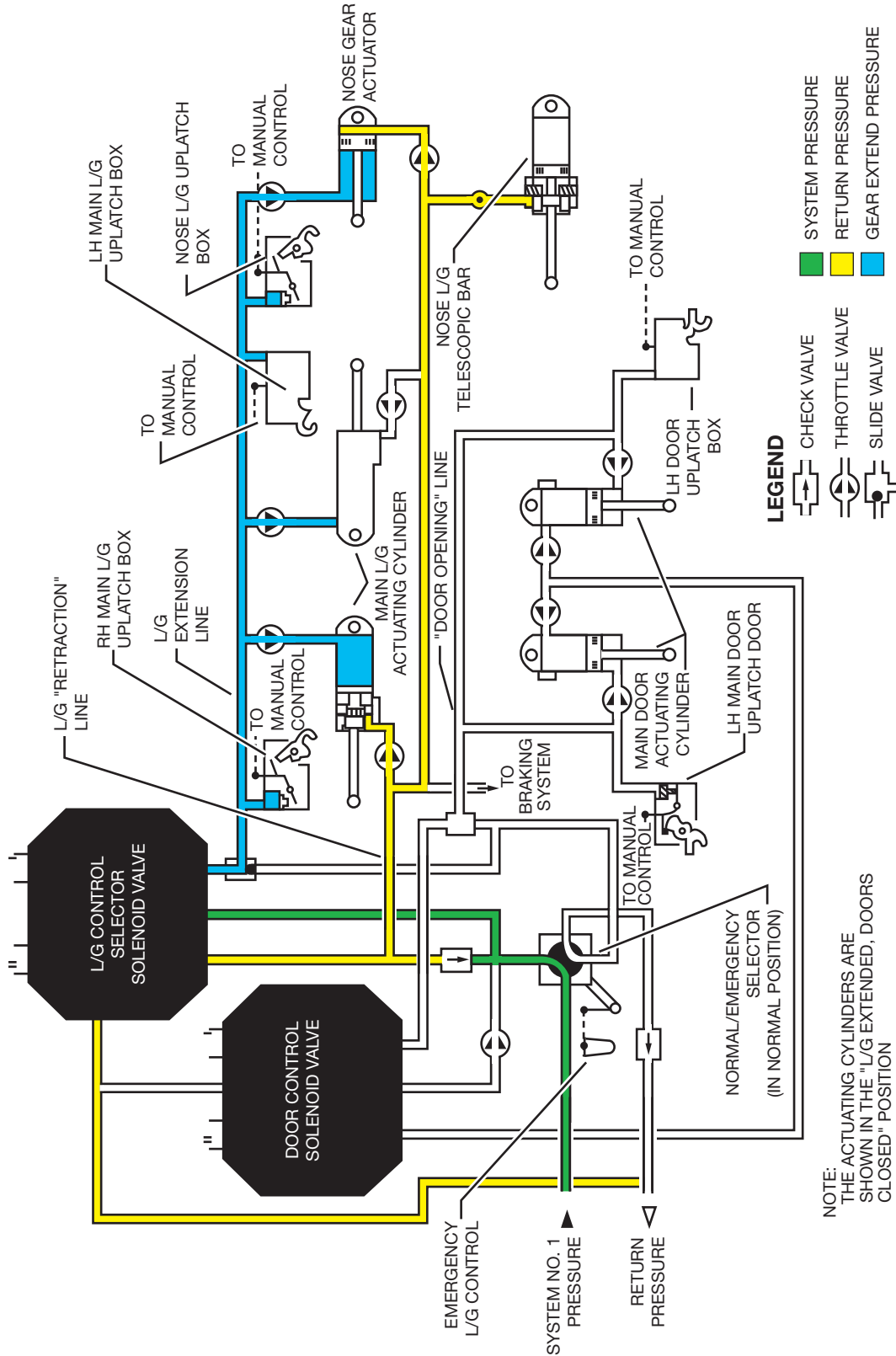
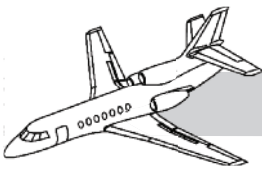

Figure 14-6. Normal Gear Operation Schematic (Landing Gear Down and Locked)

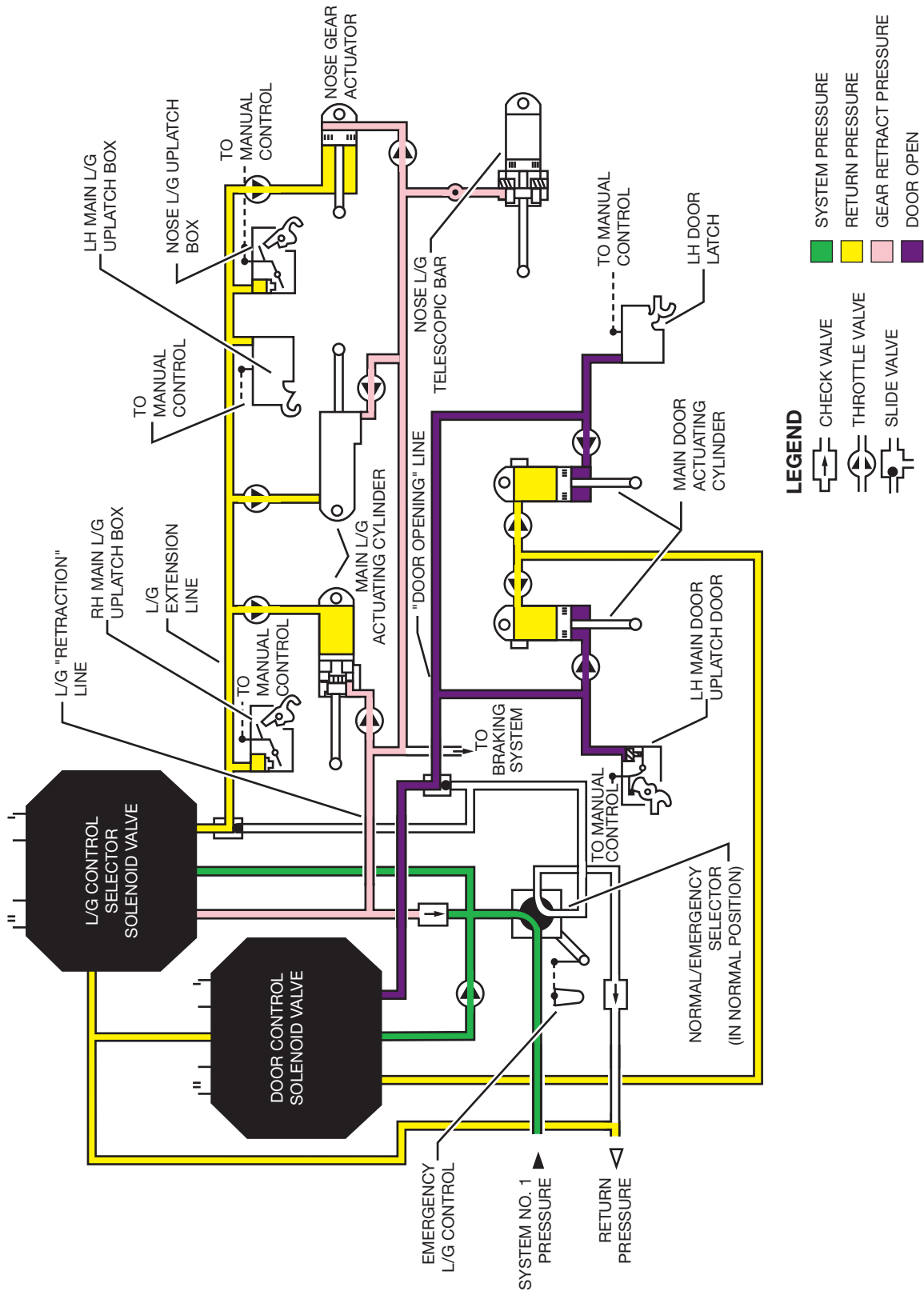
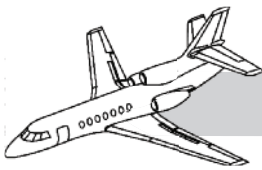
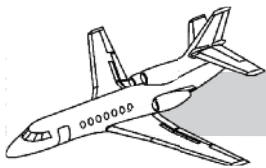

Figure 14-7. Normal Gear Retracting Schematic (Landing Gear Retracting - Initial Phase)



EMERGENCY EXTENSION

Emergency extension can be employed if either hydraulic or electrical power to the landing gear system is lost. Table 14-1 shows the procedures for and effects of both conditions.

The EMERG GEAR PULL control (see Figure 14-2) is used for gear extension when No. 1 system hydraulic pressure is available, but there is an electrical control failure. Even though pulling this handle cuts off electrical power to the normal control circuit, the selector lever should still be *down* for antiskid operation.

Activating this handle causes:

- Isolation of the electrical sequence circuit of normal mode
- Hydraulic opening of the doors (but not reclosing)
- Hydraulic extension of the landing gear (but not retraction) (Figure 14-8).

Indications

Unless there is a widespread electrical problem, normal landing gear control light indications will still function. At the end of the operation, all three gear legs will be extended and locked, and the doors will remain open. Therefore, all three green indicator lights will be on, as will the red LH and RH indications of doors unlocked.

Emergency Manual Unlocking of Landing Gear and Doors

If hydraulic failure precludes operation of the emergency extension just covered, a mechanical unlocking capability is provided. Before any of the three mechanical unlock handles are pulled, the EMERG GEAR PULL handle should be activated to allow hydraulic fluid to return quickly to the reservoir.

Table 14-1. EMERGENCY EXTENSION

CAUSE	PROCEDURE	EFFECT	OUTCOME
Electrical Control Failure	Pull emergency gear handle	<ul style="list-style-type: none"> • Isolates electrical control • Mechanically controls valve to allow No. 1 hydraulic system pressure to unlock gear and door uplocks and to pressurize the extend side of the main door and all gear actuators 	<ul style="list-style-type: none"> • Landing gear locked down • Doors opened, remain open • Gear not retractable
Hydraulic Failure	<ol style="list-style-type: none"> 1. Pull emergency gear handle 2. Pull mechanical uplock releases 	<ul style="list-style-type: none"> • Ports all hydraulic fluid to reservoir • Releases respective door uplocks, then respective landing gear uplocks 	<ul style="list-style-type: none"> • Doors and gear mechanically unlocked, gravity-force open • Gear downlocked by aerodynamic force • Doors remain open • Gear not retractable

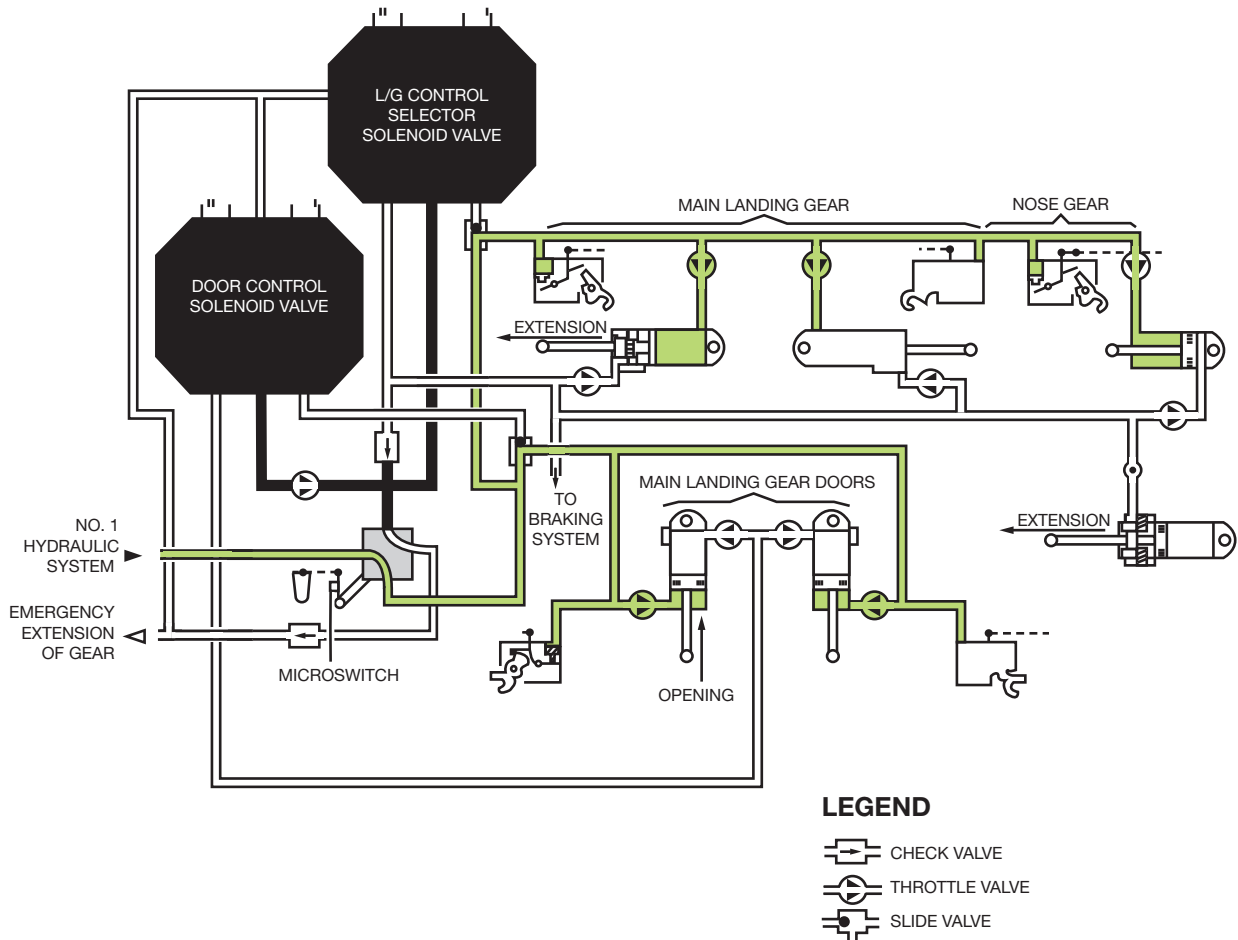
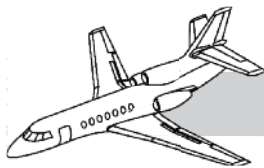

Figure 14-8. Emergency Gear Extension Schematic

Pulling each of the three unlock handles (Figure 14-9) releases its respective door uplock, then the landing gear uplock. Once unlocked, they open by gravity force and are not sequenced. Downlocking is accomplished by aerodynamic force. The doors remain open, and the red and green indicator lights remain on.

WHEEL BRAKES

GENERAL

The normal braking system is pressurized by hydraulic system No. 1. It performs two functions:

- No. 1 braking, controlled by toe pads on either pilot rudder pedals

- Automatic braking during landing gear retraction

The No. 2 brake system is powered by hydraulic system No. 2 and uses a different segment of the brake units. The system employed is controlled by the position of the brake selector switch. In No. 2—OFF, antiskid is not available.

Both brake systems are differential and apply progressively greater braking with an increase in pedal pressure.

The parking brake system is supplied by the No. 2 hydraulic system or an accumulator. This power is progressive, but nondifferential. It is applied to the same part of the brakes as

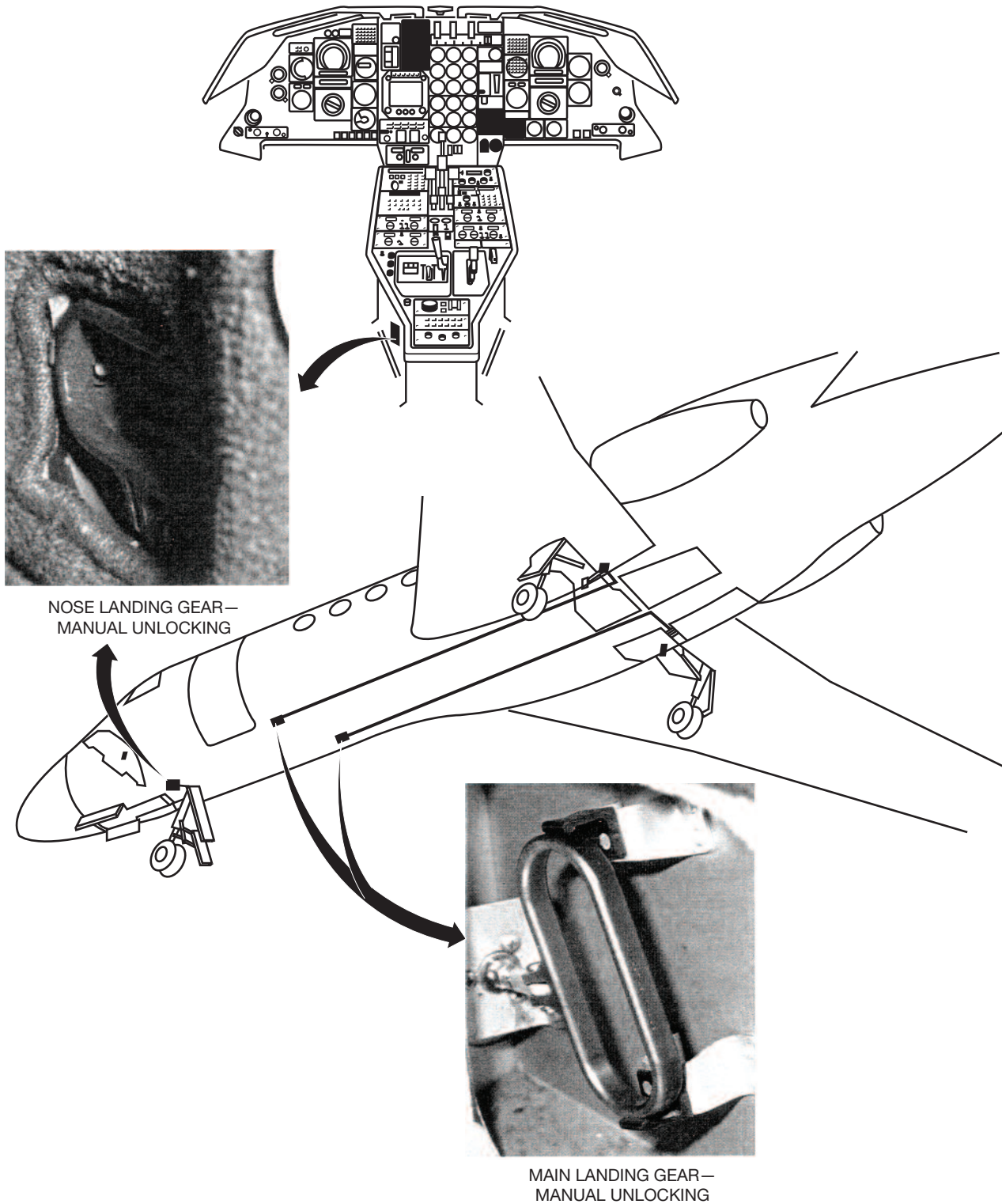
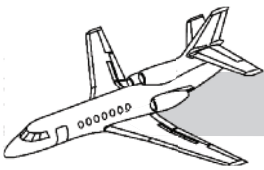
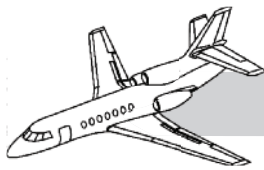

Figure 14-9. Manual Gear Unlocking Handles



the No. 2 brake system. This system will operate regardless of the position of the brake switch.

CONTROL AND INDICATION

The hydraulic braking control panel is located on the instrument panel, as part of the hydraulic control and display panel. (See Figure 14-10). The lower half houses the three-position brake switch. It denotes the brake system on the left side, and antiskid availability on the right side.

With the switch set to No. 1 ON, No. 1 brakes are available, using No. 1 hydraulic power. When the landing gear selector is set to DOWN, antiskid operation is available.

When the switch is positioned to No. 2—OFF, the antiskid is off. No. 2 hydraulic power is applied through the No. 2 ports of the brakes.

The bottom position is brake system No. 1 —OFF, with anti-skid off.

Above the switch is a small TEST button, which initiates a circuit continuity check and operation of the antiskid system. The landing gear control lever must be down for the test. The green L and R lights are controlled by the brake pressure switches and respond to the test.

Indication of Braking Pressure

Pressurization of the No. 1 brakes is indicated on the L and R indicator lights.

The PARK BRAKE control handle is located at the top center of the glareshield. In the center of the handle is an UNLOCK—PUSH button. There are two latching positions for this handle. The intermediate latch applies light braking. Pulling the handle to its full travel is comparable to maximum brake application.

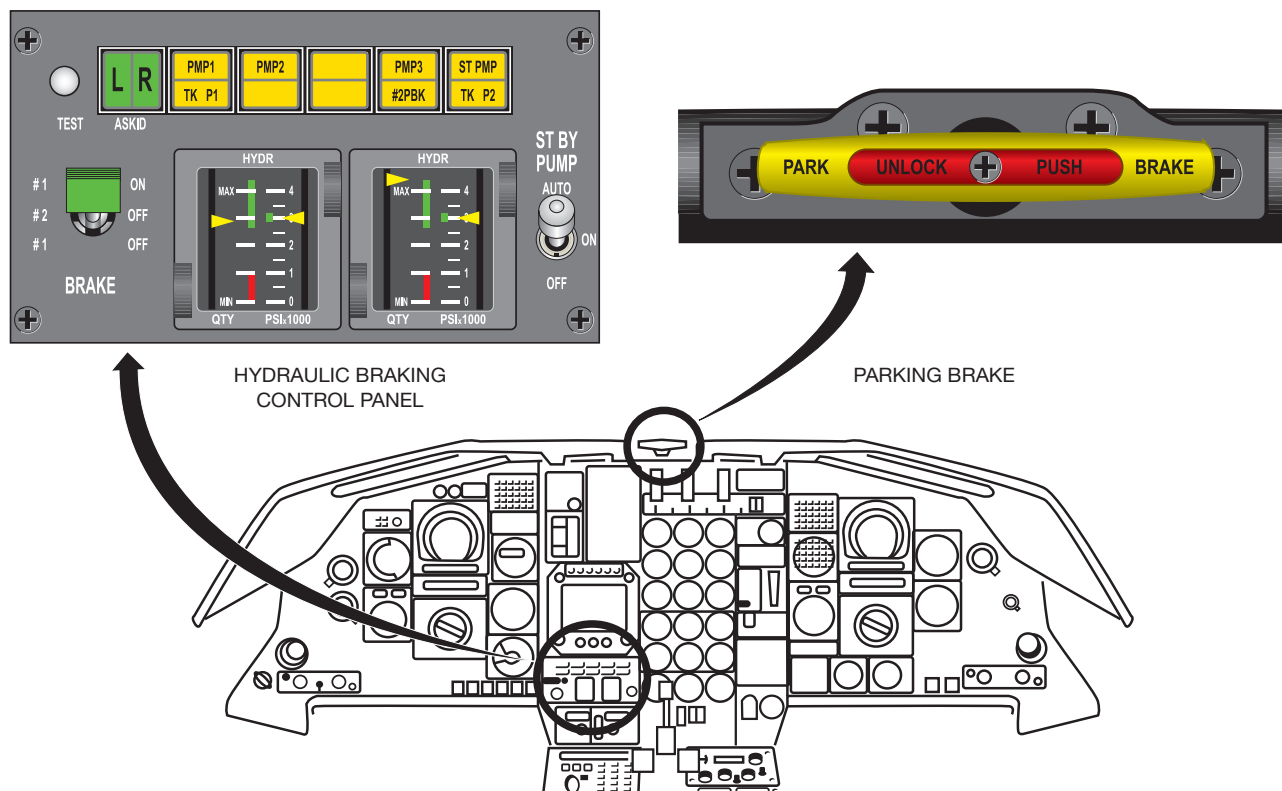
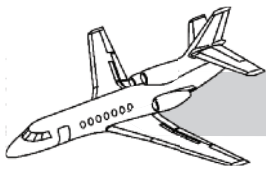

Figure 14-10. Braking Control and Indicator



On the control panel, an amber No. 2 P BK light can give two different indications:

Steady Light—Parking brake is set or the No. 2 brake system is operating.

Flashing Light—Pressure in the parking brake accumulator has dropped to below 1,200 psi.

Figure 14-11 shows the braking schematic.

NORMAL BRAKES WITH ANTISKID

Antiskid protection is powered from bus B.

Antiskid function is available when:

- Brake selector switch is in No. 1 ON.
- Circuit breaker is set.
- Landing gear selector handle is down.
- Velocity is a minimum of 20 mph.
- Nose strut is depressed.

A monopole speed sensor in the wheel axles signal the skid control to release brake pressure during the following conditions:

- When both wheels of the affected gear are skidding:
 - If velocity is above 60 knots, current to the antiskid servo will limit the braking action to prevent exceeding a force of 0.6 g.

- If velocity is below 60 knots (but more than 20 mph), current to the antiskid servo is limited to prevent exceeding a force of 0.3 g.

- When a single wheel of a pair starts to skid, braking pressure is released from both wheels. If the second wheel doesn't begin to skid, brake pressure is reapplied.

LANDING GEAR RETRACTION—AUTOMATIC BRAKING

During retraction, pressure is applied to the normal valve. The signal is stopped and hydraulic fluid is returned to the hydraulic reservoir when the wheel rotation stops.

The hydraulic pressure for automatic braking is supplied by system No. 1 and is delivered through the retract side of gear operation.

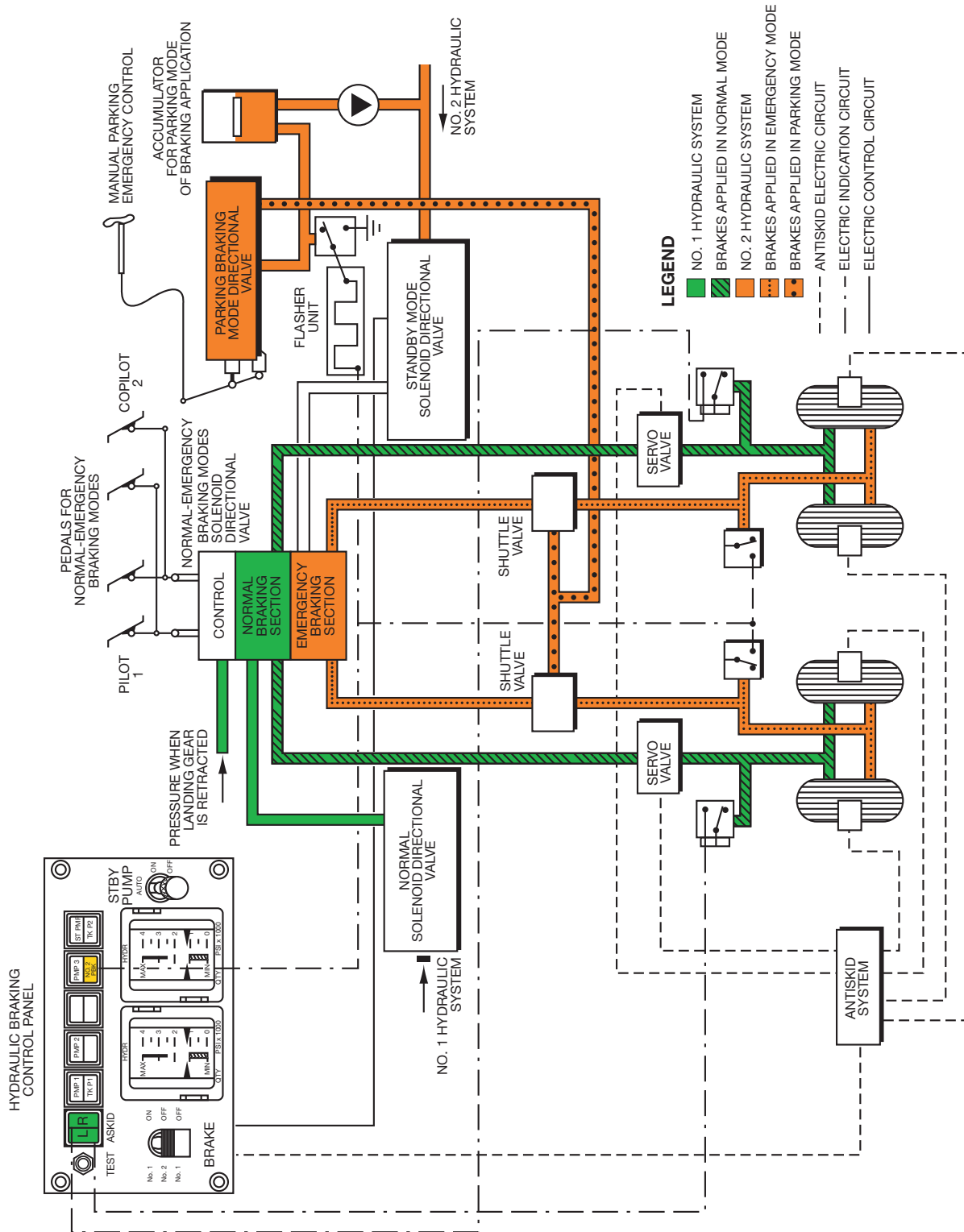
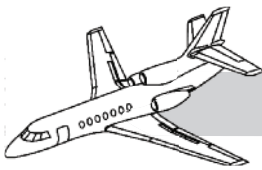
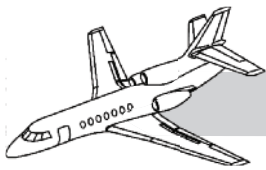

Figure 14-11. Braking Schematic



NOSEWHEEL STEERING

GENERAL

The Falcon 50 is equipped with a steerable nosewheel (Figure 14-12) controlled by a handwheel at the pilot left hand. 60° of handwheel rotation turns the nosewheel up to 6° either side of center. The second 60° of handwheel rotation produces an additional 54° of nosewheel travel. The steering mechanism is powered by the No. 2 hydraulic system. When high pressure is not available, a hydraulic accumulator supplies a lower pressure to the steering actuator for antishimmy and castering.

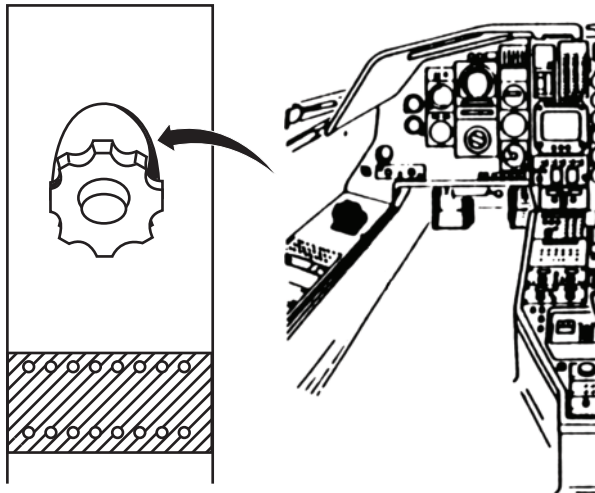

Figure 14-12. Nose Steering Handwheel Location

CONTROL

The handwheel is engaged by pushing in and turning to the desired position. If the handwheel is kept in, but no further angular pressure is applied, the handwheel returns to the center position, realigning the nosewheel with the aircraft's centerline. In the center, or zero, position, springs return the handwheel to the disengaged position.

When the nose leg (Figure 14-13) is no longer compressed (during and after lift-off), hydraulic pressure is removed from the steering valve. When the landing gear leg has moved 15° from the LOCKED DOWN position, the handwheel control is hydraulically disengaged. During retraction, a mechanical cam ensures that the nose leg is aligned with the aircraft's longitudinal axis.

During towing operation, the mechanism must be disengaged to allow 360° freedom to the nose leg.

GROUND PROXIMITY SENSORS

There are two ground proximity switches on each landing gear assembly. The switch numbers and the affected systems are listed in Table 14-2.

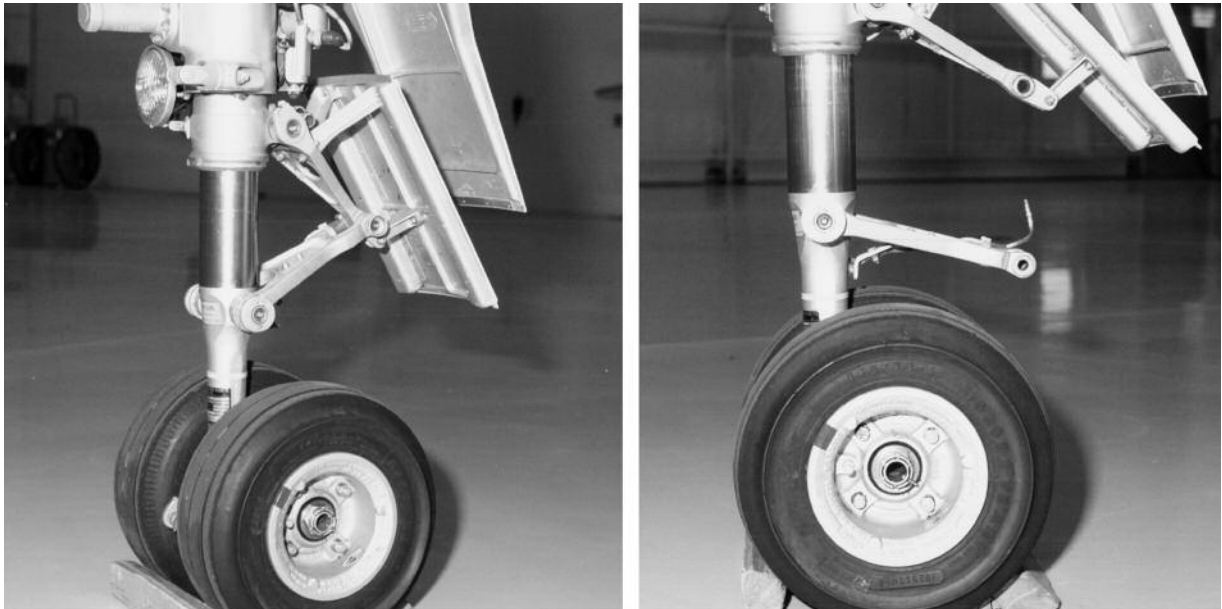
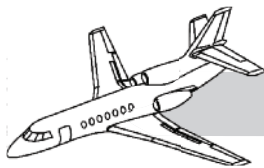
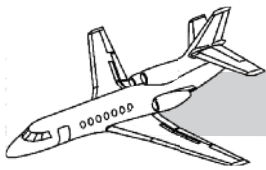

Figure 14-13. Nose Gear Coupling Link

Table 14-2. GROUND PROXIMITY WARNING SWITCHES

LEFT MAIN GEAR	NOSE GEAR	RIGHT MAIN GEAR
Switch No. 1	Switch No. 1	Switch No. 1
Stall No. 1 Test – Stall warning flight-left vane Standby hydraulic pump	Landing gear control solenoid	Stall No. 2 Test Stall warning flight—right vane
Switch No. 2	Switch No. 2	Switch No. 2
Passenger air-conditioning valve control Air data computer APU ground/flight relay Battery blower Cabin pressurization Engine-starting relays Landing gear control solenoid Nose fan control Single-point refueling Standby horizon Takeoff warning Thrust reverser—ground only	Nosewheel steering amplifier	Crew air-conditioning valve control Air data computer APU ground/flight relay Battery blower Cabin pressurization Engine-starting relays INS
	Switch No. 1 and 2	Nose fan control Standby horizon Single-point refueling Standby horizon Takeoff warning Thrust reverser—ground only
	Brake control antiskid Engine No. 2 fail-ground	



QUESTIONS

1. During normal operation, the wheel well doors:
 - A. All operate hydraulically
 - B. Are closed hydraulically and opened mechanically
 - C. Are hydraulically and mechanically operated on the main gear assemblies and mechanically operated on the nose gear
 - D. Are all closed when the gear is retracted and are open while the gear is extended
2. What is the normal indication that all landing gear are down and locked?
 - A. Three green lights, no red lights
 - B. No lights
 - C. Only the red toggle light is illuminated.
 - D. The control lever is latched in the DOWN position. There are no light indications for gear legs, only indication for door operation.
3. When the tone cutoff button is depressed, and it does not stop the aural warning tone, what does it indicate?
 - A. At least one gear leg is not locked down and the aircraft is below 1,600 feet.
 - B. All gear legs are locked down, the throttles are retarded, airspeed is below 160 knots, and 48° of flaps are selected.
 - C. One or more gear legs is *not* locked down and the flaps are set for landing (48°).
 - D. One or more gear legs is not locked down, and at least one throttle is retarded.
4. Normal gear extension does not function properly, and the EMERG GEAR PULL control is activated. Which answer describes the proper gear reaction?
 - A. All gear extend fully, and all gear doors close.
 - B. All gear extend fully, but gear indicator lights do not function.
 - C. All gear extend fully, the doors remain open, and the lights indicate properly.
 - D. Pulling that control unlocks the door and gear uplocks, and they free-fall to the extended position.
5. Which statement correctly reflects the differences between normal and emergency braking?
 - A. Normal braking uses No. 1 system hydraulic power and has antiskid operation. Emergency braking operates from the No. 2 system and does not allow antiskid.
 - B. Both normal and emergency brakes are actuated during gear retraction.
 - C. When normal braking is lost, emergency braking automatically operates.
 - D. Either system can employ antiskid, depending on the position of the brake and antiskid control.
6. Which statement is correct concerning the No. 2 P BRAKE light on the hydraulic control and display panel?
 - A. If on STEADY, the parking brake has failed.
 - B. If FLASHING, the parking brake accumulator has a low pressure.
 - C. A STEADY light indicates that System No. 2 is not available.
 - D. A FLASHING indication means that the parking brake is set.

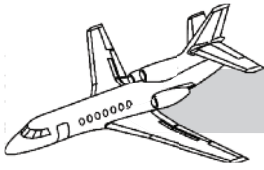

7. The nose steering handwheel:
 - A. Is engaged by pushing it in and turning it to the desired position. When angular pressure is no longer applied, it slowly returns to center and springs out to the disengaged position.
 - B. Is first turned to the desired position, and then pushed in to lock it in place
 - C. Must not be turned in flight, as it will turn the wheel in the wheel well
 - D. Is located at the aft end of the pedestal

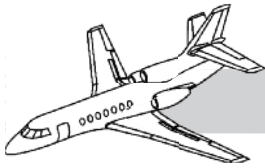

CHAPTER 15 FLIGHT CONTROLS

CONTENTS

	Page
INTRODUCTION.....	15-1
GENERAL.....	15-1
AILERON CONTROL SYSTEM.....	15-2
System Description	15-3
Component Description	15-4
Controls and Indications	15-5
System Operation	15-8
RUDDER CONTROL SYSTEM.....	15-9
System Description	15-9
Component Description	15-9
Controls and Indications	15-11
ELEVATOR CONTROL SYSTEM.....	15-11
System Description	15-11
Component Description	15-12
HORIZONTAL STABILIZER	15-13
System Description	15-13
Controls and Indications	15-14
System Operation.....	15-15
SLATS.....	15-16
System Description	15-16
Controls and Indications	15-18

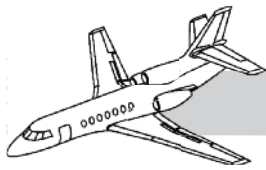

System Operation.....	15-19
FLAPS	15-20
System Description	15-20
Controls and Indications	15-21
AIRBRAKES.....	15-23
System Description	15-23
Controls and Indications	15-23
System Operation.....	15-25
LIMITATIONS	15-25
QUESTIONS	15-27

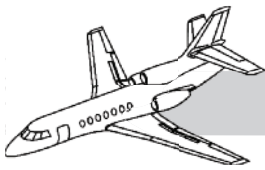

ILLUSTRATIONS

Figure	Title	Page
15-1	Flight Control Surfaces	15-2
15-2	Hydraulic Aileron Control System.....	15-3
15-3	Typical Aileron Servoactuator.....	15-4
15-4	Aileron System Controls and Indications	15-6
15-5	Aileron Trim Control.....	15-8
15-6.	Aileron Trim Indicator	15-8
15-7	Rudder Control Hydraulic System.....	15-10
15-8	Rudder Trim Actuator Switch	15-11
15-9	Rudder Trim Indicator.....	15-11
15-10	Elevator Control System	15-12
15-11	Pitch Trim.....	15-13
15-12	Horizontal Stabilizer Controls and Indications.....	15-14
15-13	Slats Location.....	15-16
15-14	Slats Controls and Indications	15-17
15-15	Flaps	15-20
15-16	Flaps Location.....	15-21
15-17	Flaps, Controls and indications.....	15-22
15-18	Airbrakes	15-23
15-19	Airbrakes Controls and Indications	15-24

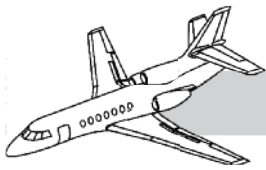

CHAPTER 15

FLIGHT CONTROLS

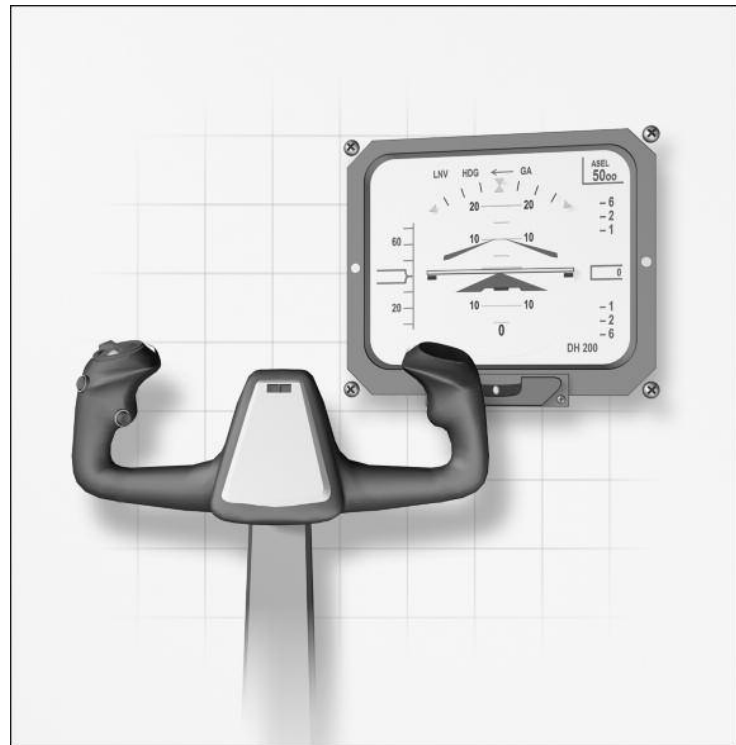

INTRODUCTION

The primary flight controls are the ailerons, elevators, and rudder. The hydraulically boosted primary flight controls can be manually actuated during a failure of both hydraulic systems. The mechanically actuated ailerons and elevators also incorporate electric trim. The secondary flight controls consist of electrically/manually controlled and hydraulically actuated leading-edge slats, trailing-edge flaps, and airbrakes.

Aileron and rudder trim is hydraulically powered and initiated by electric motors. Hydraulic gust effect damping is provided and is not dependent upon hydraulic pump pressure. A hydraulically powered yaw damper, controlled by an autopilot servo, prevents yaw oscillations. Electrically powered horizontal stabilizer trim is also provided.

GENERAL

Conventional cockpit control columns and rudders move the primary flight control surfaces through the roll, pitch, and yaw axes. Two ailerons provide roll control. Two elevators and a moving horizontal stabilizer provide pitch control. A rudder provides yaw control.

The primary flight control system is fully boosted and nonreversible. Control inputs from the cockpit are transmitted through a system of push-pull rods and bellcranks to dual barrelled hydraulic servoactuators powering the ailerons, rudder, and elevators.

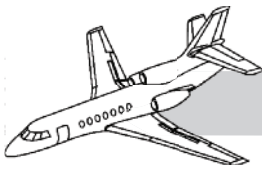

Failure of an input control linkage results in the affected servoactuator returning to neutral.

The secondary flight controls consist of four mobile slats and four flaps serving as high lift devices, and six airbrakes for aerodynamic braking. Figure 15-1 displays the primary and secondary flight controls.

The pitch and roll systems incorporate an artificial feel, variable-Load Arthur Q-unit system. A three-axis, electrically controlled trim system contains standby emergency controls for the roll and pitch axis. Servoactuators utilize a neutral feedback unit (NFU) that returns the servoactuator to the neutral position.

In the event of a total hydraulic failure, the primary flight controls may be operated manually but with some loss of efficiency. In this case, the servoactuators mechanically transmit control inputs to the control surfaces, and airspeed should be limited to 260 KIAS/.76 Mach.

Aileron and rudder trim are controlled by dual-rocker switches located on the trim control box on the center pedestal. Electric trim actuators reposition the applicable servoactuators by moving the entire control surface to provide aileron and rudder trim. There are no trim tabs on the aircraft.

Horizontal stabilizer (tailplane) trim is controlled by dual-rocker switches on the control wheels or by an emergency trim control in the trim control box. The stabilizer is repositioned by two independent 28-VDC motors (one normal and one emergency) to provide pitch trim.

The electrically/manually controlled leadingedge slats can be actuated by the No. 1 or No. 2 hydraulic systems. The airbrakes and trailingedge flaps are powered by the No. 2 system. **AILERON CONTROL**

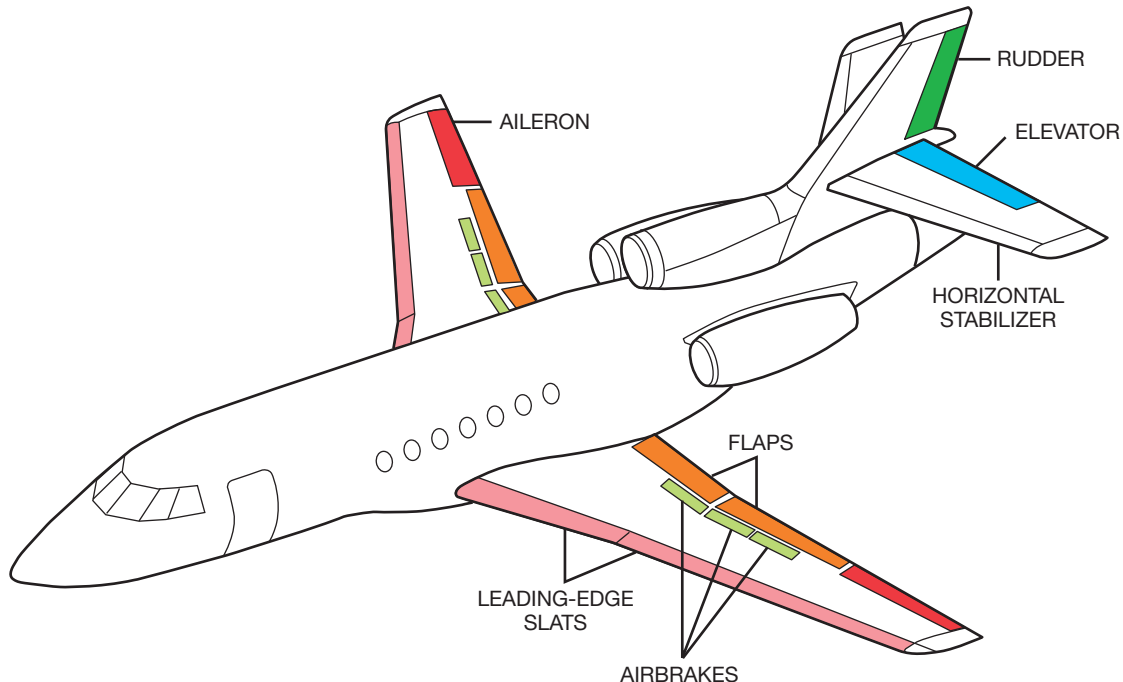
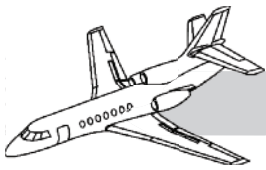

Figure 15-1. Flight Control Surfaces



AILERON CONTROL SYSTEM

SYSTEM DESCRIPTION

The pilot and copilot control columns operate the ailerons through a linkage system

(Figure 15-2). The system consists of adjustable and nonadjustable rods hinged to cranks, levers, and bellcranks. The linkages are routed through the fuselage and wing leading edges.

An irreversible, double-barreled servoactuator controls each aileron. The independent

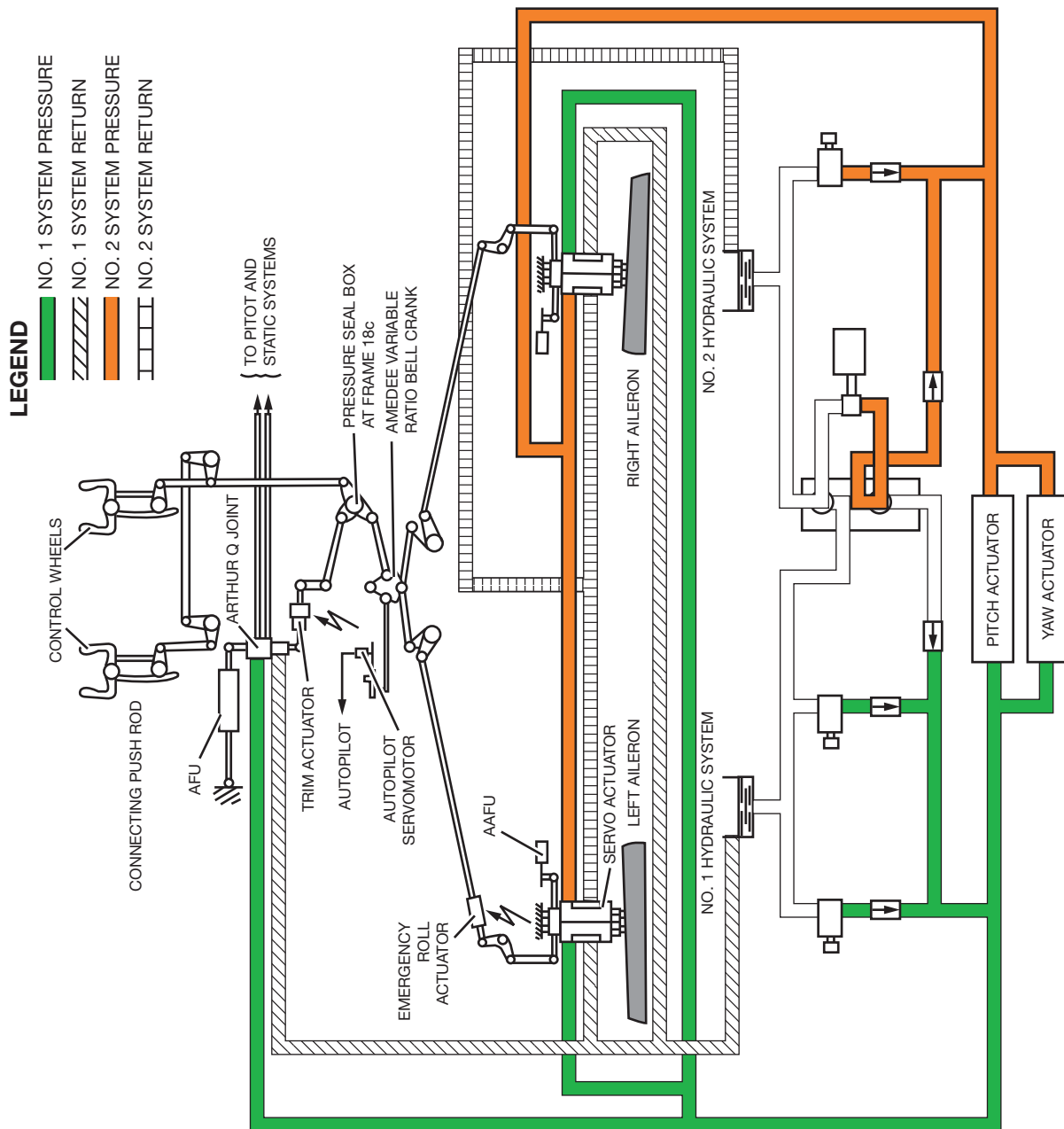
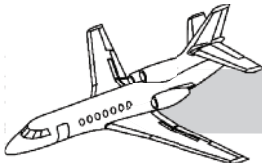

Figure 15-2. Hydraulic Aileron Control System



hydraulic systems supply power to each half of both servoactuators. Each power servo unit contains a neutral feedback unit. The aileron angular displacement is limited to 25° 20' upwards and 24° 50' downwards.

The ailerons operate using a variable input/output ratio bellcrank called an AMEDEE located forward of the outer wing. A two-way switch, on the cockpit pedestal, controls an emergency roll trim electric actuator in the left wing leading edge.

COMPONENT DESCRIPTION

The aileron components consist of the following:

- Servoactuators
- Artificial feel unit (AFU)
- Neutral feedback unit
- Arthur Q-unit

Servoactuators

Hydraulic servoactuators in each primary control axis position the primary flight control surfaces in response to control inputs. Figure 15-2 shows the hydraulic aileron control system and Figure 15-3 shows the servoactuators. The servoactuators consist of two independent barrel and piston assemblies operating in unison. One barrel is powered by the No. 1 hydraulic system, the other barrel by the No. 2 system.

If one hydraulic system fails, a bypass valve in the corresponding barrel interconnects the two chambers. The depressurized barrel offers minimal resistance to the remaining operative barrel. If both hydraulic systems fail, return springs move the slide valves to neutral. Control inputs then mechanically move the barrels to provide manual deflection of the control surface.

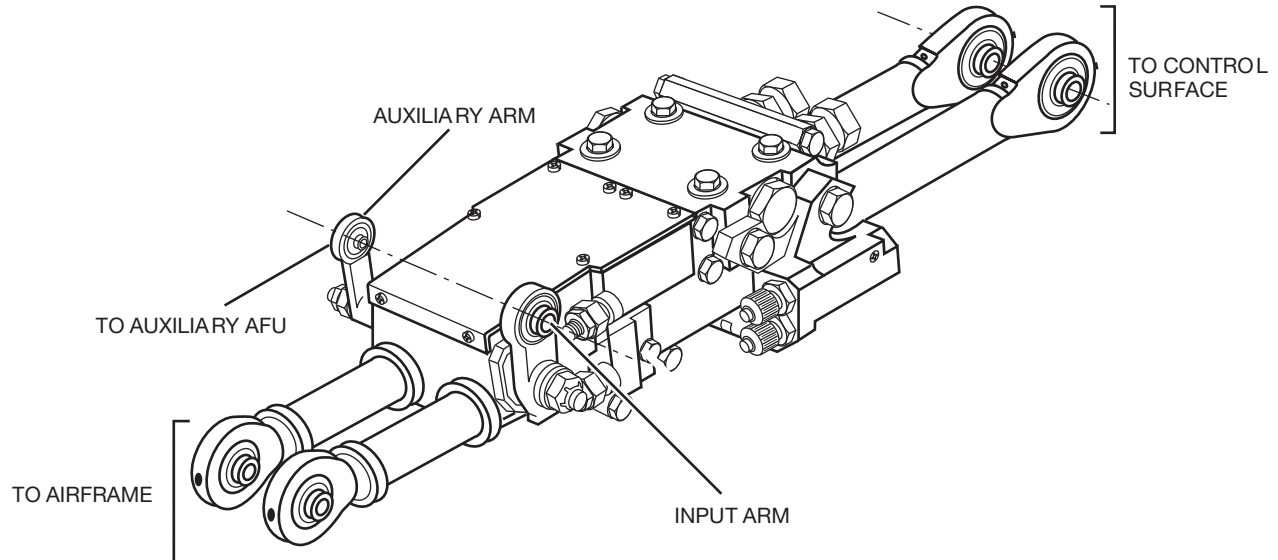
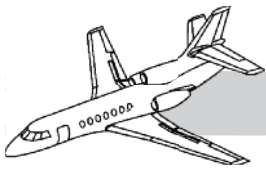

Figure 15-3. Typical Aileron Servoactuator



Artificial Feel Unit

Hydraulically boosted flight controls do not provide aerodynamic load feel to the pilot. Springloaded artificial feel units (AFUs) are installed in the primary flight control linkages prior to the servoactuators. The spring loaded AFU and the Arthur Q-unit provide artificial feel. The load feel provided is in direct proportion to the magnitude of the control input movement and the resultant spring compression. The pilot or the autopilot must overcome the force produced by the compression or extension of the AFU.

Arthur Q-Unit

The spring tube provides a load function of the control displacements independent of airspeed. The purpose of the Arthur Q-unit is to provide a load that increases with airspeed for a given displacement of the input controls.

The Arthur Q-unit is a variable bellcrank with input and output levers. The levers consist of a piston rod and hydraulic actuator. The piston displacement within the cylinder changes the output lever to input lever length ratio by changing the length of both levers.

The position of the piston is hydraulically slaved to the indicated airspeed (IAS) with a sealed capsule. The capsule is integral with the Q-Unit and supplied by the pitot system.

When IAS is 140 ± 15 knots (low-speed Arthur position), the ratio between input and output of the Arthur Q-unit is 1:1. The total run of the bellcrank is 44 mm providing a step-down ratio of 2.02:1 when the IAS exceeds 378 ± 15 knots.

CONTROLS AND INDICATIONS

Control Columns and Wheels

The roll system includes two yoke type control wheels mounted on the pilot and copilot control columns (Figure 15-4). The wheel travel is limited to $\pm 60^\circ$.

Each control wheel drives a dual groove pulley that transmits motion through cables to a second pulley located at the foot of the control column. This pulley receives the control column output bellcrank. The neutral position of this bellcrank is equal to the control column hinge center line. A rod-bellcrank assembly provides the coordination function between pilot and copilot wheels.

Each control wheel is equipped with a dual rocker switch. The switch is used for normal control of the horizontal stabilizer.

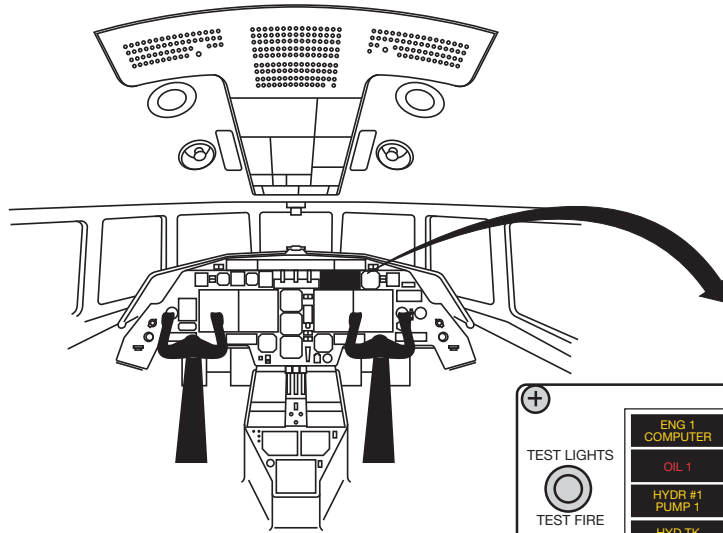
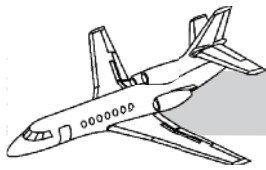

WARNING PANEL 50E

TEST LIGHTS TEST FIRE BRIGHT DIM	ENG 1 COMPUTER	ENG 2 COMPUTER	ENG 3 COMPUTER	T/O CONFIG	L. PITOT	R. PITOT
	OIL 1	OIL 2	OIL 3	ENG 2 FAIL	AUTO SLATS	Q. UNIT
	HYDR #1 PUMP 1	HYDR #1 PUMP 2	HYDR #2 PUMP 3	REVERSER UNLOCK	FLAP ASYM	AIL ZERO
	HYD TK PRESS	BRAKE ACCU	ST PUMP #2	AP	AP TRIM FAIL	MISTRIM
	GEN 1	GEN 2	GEN 3	APU GEN	—————	—————
	BAT 1	BUS TIED	BAT 2	HOT BAT	—————	—————
	FUEL 1	FUEL 2	FUEL 3	APU BLEED	BLEED OVHT	COND'G OVHT
	FUELING	LO FUEL	—————	CABIN	DOORS	NOSE FAN FAIL

WARNING PANEL 50B

AUTO SLATS	COND'G OVHT	AIR DATA
FLAP ASYM	APU BLEED	BLEED OVHT
L. PITOT	AIR DATA	R. PITOT
T/O CONFIG	REV UNLOCK	CABIN
AIL ZERO	MACH TR	Q-UNIT
AP TRIM	AP	MISTRIM
GEN 1	GEN 2	GEN 3
BAT 1	BUS TIED	BAT 2
AC 1	HOT BAT	AC 2
OIL 1	OIL 2	OIL 3
CMPTR 1	CMPTR 2	CMPTR 3
FUEL 1	FUEL 2	FUEL 3
FUELING	LO FUEL	

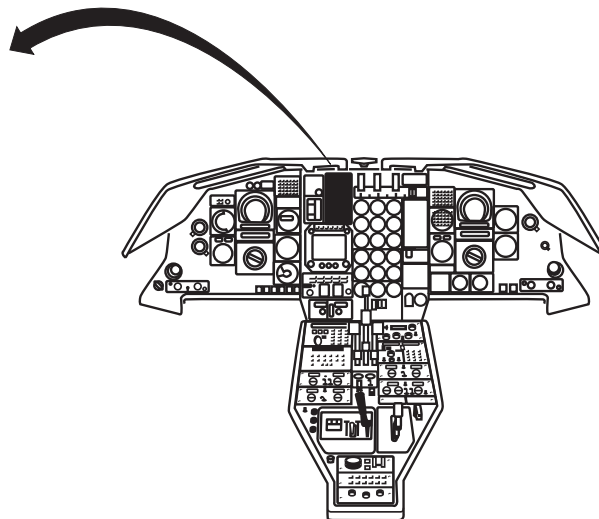
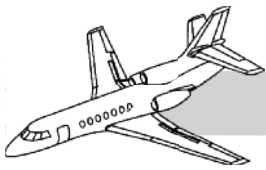

Figure 15-4. Aileron System Controls and Indications (Sheet 1 of 2)



Aileron Trim Control

The aileron trim control includes the trim circuit used to trim the aircraft by displacing the AFU neutral position (Figure 15-5). Control is completed by the roll emergency circuit. The electric actuator, mounted between the two ailerons, provides limited roll authority during control linkage seizing.

An electrical actuator located upstream of the Arthur Q-unit provides aileron trim. The actuator is mounted in line with the standby channel. The actuator travel is limited by electrical stops. Should the electrical stops fail, the travel will be limited by mechanical stops. This travel corresponds to an aileron deflection of $\pm 10^{\circ} 30'$.

A dual rocker switch, located in a box installed on the pedestal, provides trim control. The dual rocker switch controls the grounding of the electrical signal.

The electric motor has two windings. Switching either one will change the direction of rotation. The two-way switch of the control box controls switching. Protection is provided by interlocked relays in such a way that energizing one winding precludes energizing the other. Should an untimely positive signal be applied to the other line, simultaneous energizing of the two circuits cuts off both supplies by simultaneously locking both relays and cutting off electrical power to the motor.

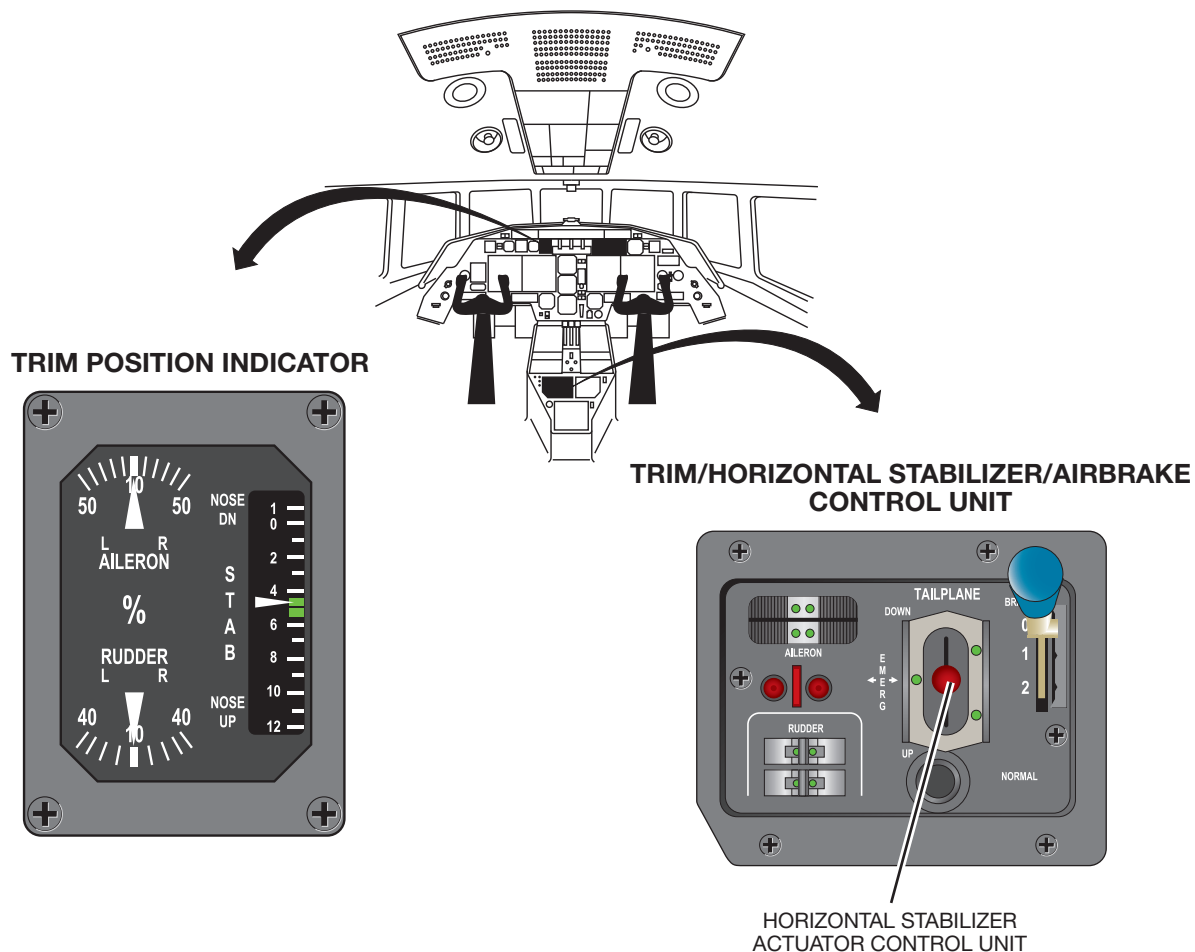

Figure 15-4. Aileron System Controls and Indications (Sheet 2 of 2)

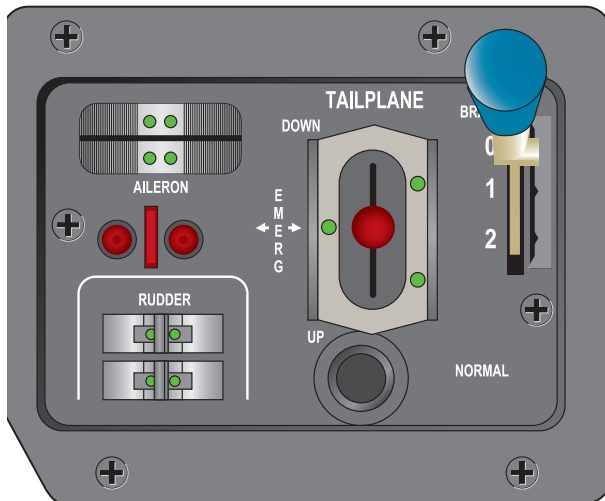
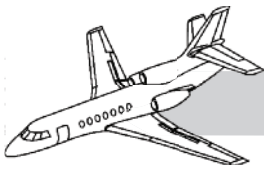

Figure 15-5. Aileron Trim Control

Aileron Emergency Actuator

The emergency actuator is controlled by two red pushbuttons located behind the trim controls (Figure 15-5). Both buttons are separated by a partition preventing the pilot from pressing both buttons at the same time.

The emergency aileron actuator is electrically controlled and in line with the left wing linkage system. Travel corresponds to $\pm 7^\circ$ deflection with a transit time of 10 seconds.

The AIL ZERO amber light illuminates on the warning panel when the emergency actuator is not set to the neutral position (see Figure 15-4).

Aileron Trim Indication

A trim indicator provides trim information for all three axis (Figure 15-6). The indicator is located on the instrument panel and receives a signal generated by a potentiometer incorporated in the actuator.

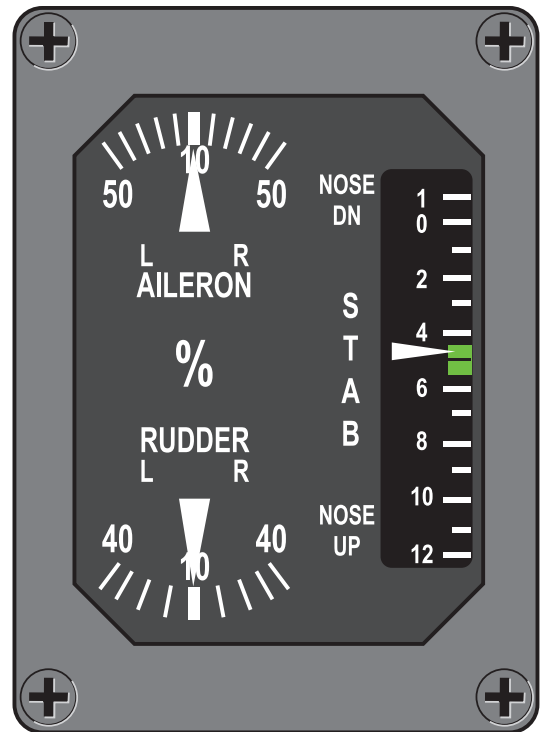

Figure 15-6. Aileron Trim Indicator

SYSTEM OPERATION

Arthur Q-Unit

When hydraulic pressure is applied, hydraulic fluid fills the actuator small section chamber. Fluid tapped from this chamber flows through a filter and through a fixed nozzle into the large section chamber. A variable nozzle is installed in parallel with this line. A capsule drives a flapper valve to control nozzle leakage.

IAS Less than 140 ± 15 Knots

The flapper and capsule are held on the orifice of the variable nozzle. When the IAS is less than 140 ± 15 knots, there is no flow and the actuator is in the low-speed Arthur position. The input arm has the same length as the output arm. IAS greater than 140 ± 45 knots.

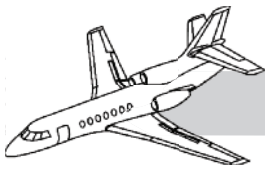

As airspeed increases above 140 knots, the flapper and capsule move away from the orifice of the adjustable nozzle and the flow becomes greater downstream of the fixed nozzle. The ratio between the input and output arms changes and reaches its maximum at an IAS of 370 ± 15 knots.

Monitoring is accomplished by comparing the aircraft speed with the Arthur Q-unit position data. If a preset difference is exceeded, the Q-unit light on the warning panel illuminates. The airspeed data comes from the air data computers.

The position data is provided by a linear potentiometer integral with the Arthur Q-unit. The comparison function is performed by a printed circuit board located in the left center electrical rack. The detection threshold is ± 30 knots at low speed and ± 60 knots at high speed.

NOTE

Roll and pitch Arthur Q-units use a common monitoring and indicating circuit.

Secondary AAFU

In the event of broken or open linkages, the AAFU returns the levers of the servoactuator to neutral to fair the control surfaces. If this happens, one aileron is hydraulically locked in the neutral position. The other aileron provides acceptable steering of the aircraft.

RUDDER CONTROL SYSTEM

SYSTEM DESCRIPTION

The rudder is driven by an irreversible servoactuator with a dual-barrel. Each moving barrel is supplied by an independent hydraulic system (Figure 15-7).

The pilot and copilot rudder pedals control the servoactuator through linkages consisting of rods hinged on bellcranks, cranks, and levers. The linkage is routed under the passenger compartment floor to a pressure-sealed box located at the rear of the pressurized portion of the fuselage. The box provides transfer between the pressurized and nonpressurized zones. The linkages are then routed through the box to the vertical stabilizer. Travel is limited by adjustable stops located on the rudder pedal supports.

COMPONENT DESCRIPTION

Servoactuator

The rudder servoactuator is similar to the aileron servoactuators. Each barrel is hydraulically operated. Routing of the two systems is segregated. The No. 1 system is routed behind the rear spar, and the No. 2 system is routed in front of the front spar.

Each servoactuator barrel is equipped with a built-in gust damper valve. The gust damper valve allows hydraulic fluid to be stored in each barrel during supply drops. The gust damper includes a check valve in the supply line and a calibrated valve in the return line. Opening of this valve is controlled by either the bypass spool valve or by the differential pressure across the servoactuator if greater than 100 bar.

A restrictor is installed in the interconnection line between the chambers. The restrictor provides damping of control surface movement caused by wind gusts, both on the ground and in flight, when the servoactuator is without hydraulic pressure.

Yaw Trim Actuator

The yaw trim actuator is located between the AFU and an attachment point on the front spar of the vertical stabilizer stub in the rear compartment. A maximum of 40% authority is available which corresponds to $\pm 9^{\circ}30'$ rudder deflection.

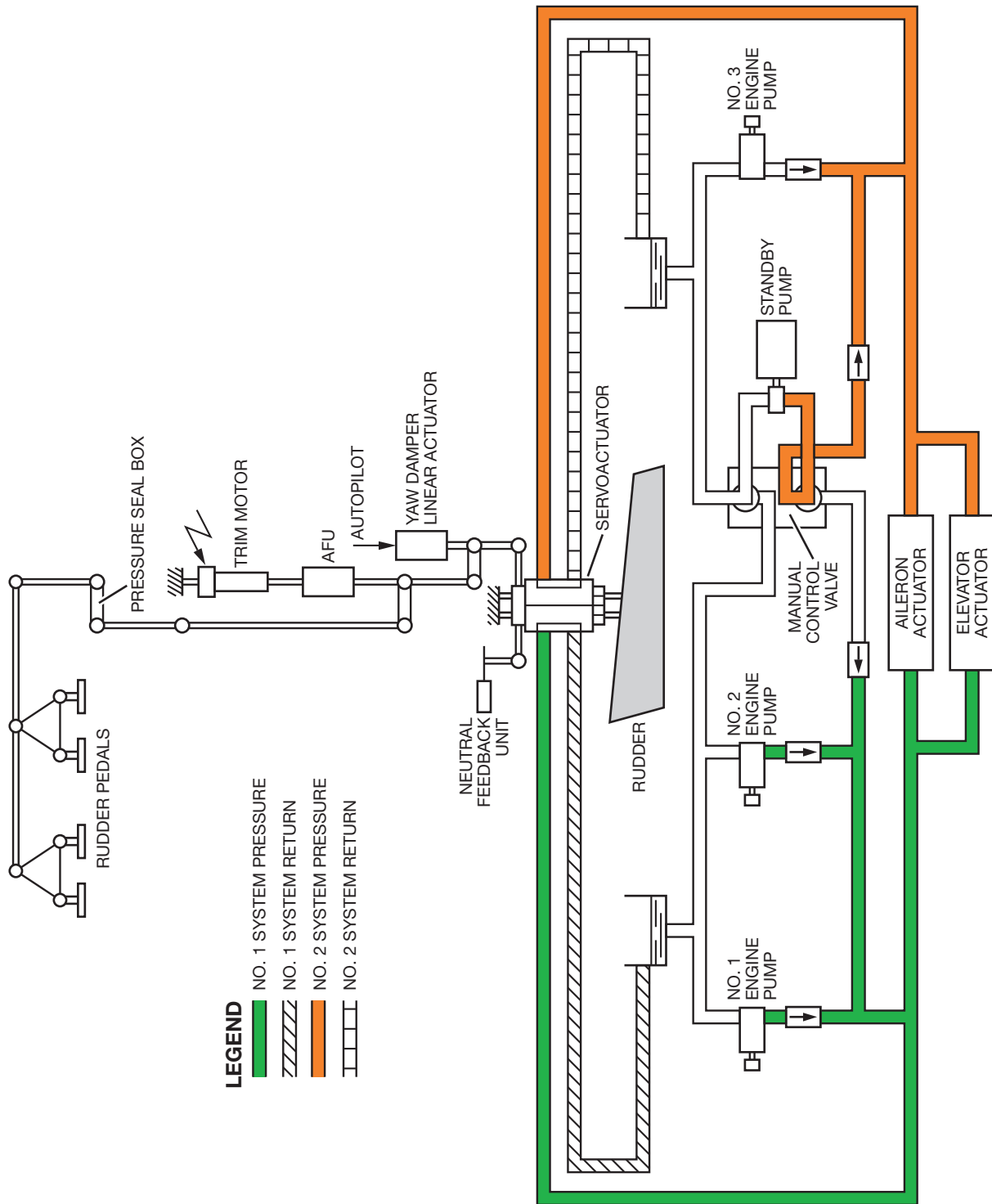
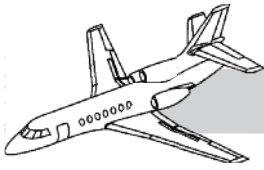
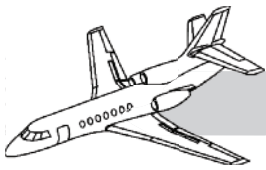

Figure 15-7. Rudder Control Hydraulic System



The trim actuator is electrically controlled and travel is limited to 7.47 inches (19 mm) by electrical stops. The electrical motor is sealed in order to prevent any ingress of humidity. Should the electrical stops fail, travel is limited to 8.26 inches (21 mm) by mechanical stops. Electrical transit time is 10 seconds.

CONTROLS AND INDICATIONS

Rudder Trim Actuator Switch

A dual rocker switch, installed in the control box of the center pedestal, controls the electric actuator. This switch controls grounding and the electrical control signal (Figure 15-8).

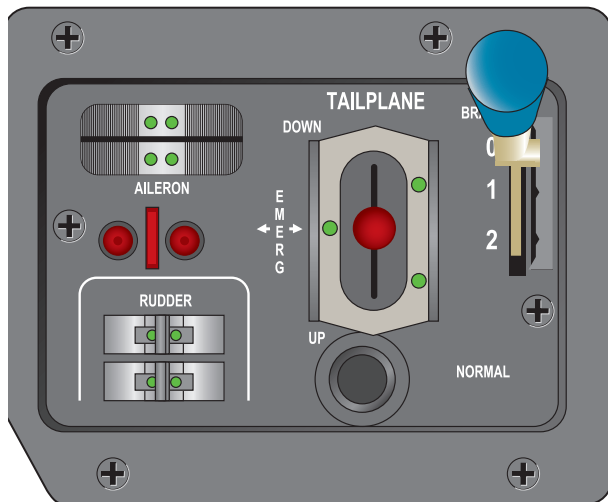

Figure 15-8. Rudder Trim Actuator Switch

The trim motor has two windings. Switching of either one will control the direction of rotation. The dual rocker switch of the control box controls switching. Protection is provided by interlocked relays so that supply of one winding precludes supply to the other winding.

Should a spurious signal be applied to one line, simultaneous supply of both circuits will be cut off. This occurs by a simultaneous locking of both relays, cutting off power to the electrical motor.

Rudder Trim Position Indicator

The horizontal stabilizer, aileron, and rudder trim position indicator is located on the instrument panel (Figure 15-9). The indicator receives the signal from a potentiometer integrated into the rudder trim actuator.

The rudder dial, with L 40, 0, and R 40 marks, indicates, in percentage of full range, the actual rudder deflection.

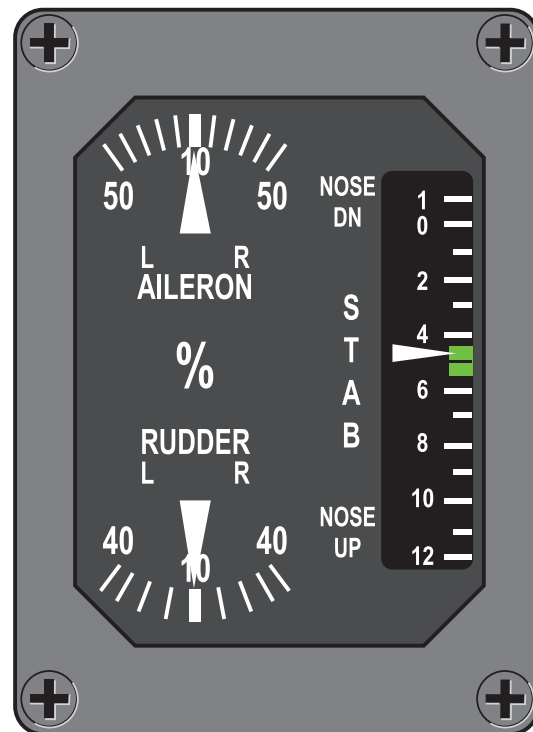

Figure 15-9. Rudder Trim Indicator

ELEVATOR CONTROL SYSTEM

SYSTEM DESCRIPTION

Pilot and copilot columns control the servoactuators through linkage consisting of rods hinged on bellcranks, cranks, and levers (Figure 15-10). The linkage is routed under the passenger cabin floor to the pressure-sealed

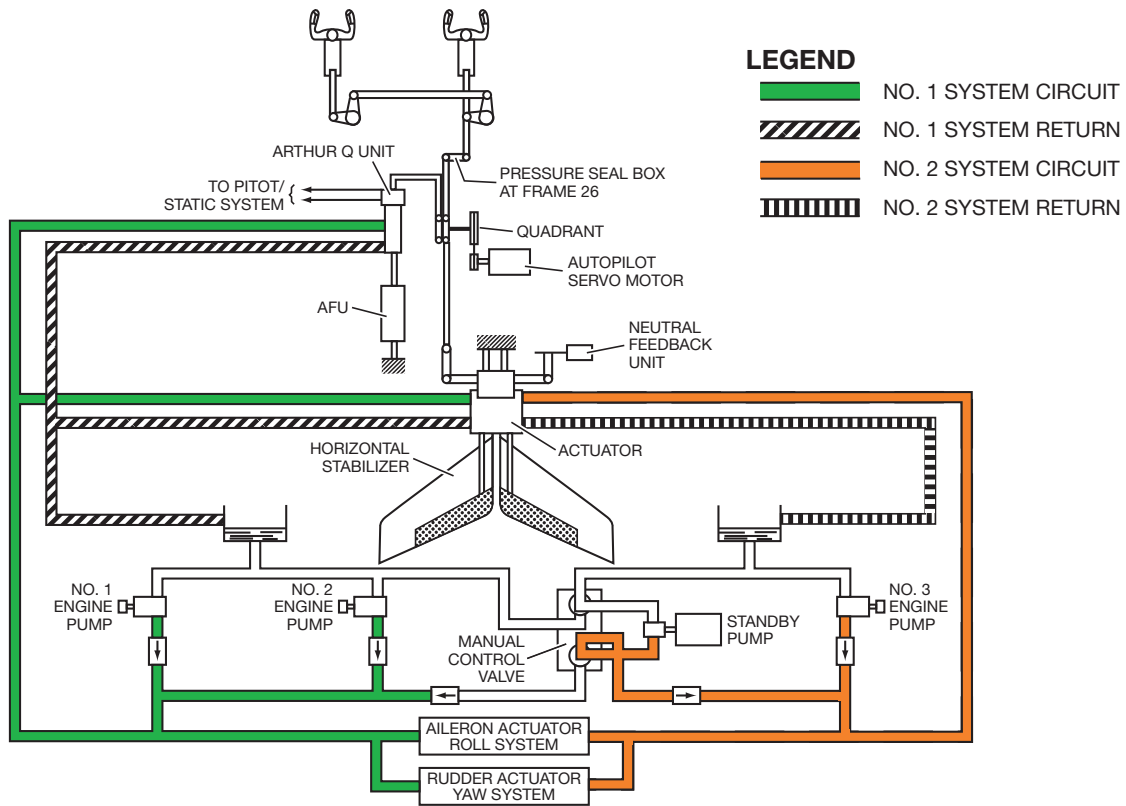
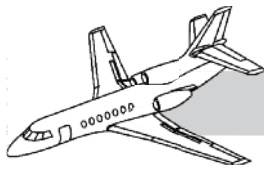

Figure 15-10. Elevator Control System

box located at the rear of the pressurized section of the fuselage. The linkage exits the pressurized zone and is routed toward the vertical stabilizer stub.

- The Arthur Q-unit that adjusts the AFU authority (i.e., the load) according to the indicated airspeed

- One autopilot servomotor

NOTE

Displacement of the horizontal stabilizer is used to trim the aircraft in pitch.

The following components are connected in parallel to the main control system:

- Artificial feel unit generating loads by means of two subsystems:
 - An artificial feel unit that applies forces proportional to the displacement of the control linkage

COMPONENT DESCRIPTION

Linkage

The pitch system consists of two yoke-type wheels fitted on control columns. Displacement of the control columns is 100 mm forward and 95 mm backward. Travel limits are provided by adjustable stops located at the base of the control column which bear on the fitting at the base of the control column.

The linkage is routed under the right side of the cabin floor parallel to the other control cables. Routing above the centerwing is provided by a rod sliding into ball bearings. The rod center section is fitted with a buckling-proof bearing.

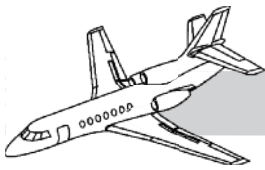

The pressure sealed box at the rear of the pressurized zone routes the controls into the unpressurized zone. Passage toward the left side is accomplished through a rod parallel to the centerwing rear spar. At the ceiling of the rear compartment, a torque tube connects with the autopilot and the AFU. Crossing of the stub rear section is accomplished with a long horizontal rod that is routed behind the horizontal stabilizer actuator. A rod goes through the horizontal stabilizer box structure to reach the power servo unit.

Trim

The main elevator control system is completed by a trim circuit. The circuit allows setting of the horizontal stabilizer angle of incidence with a fail-safe actuator.

Servoactuator

The hydraulically powered servoactuator has two parallel-moving barrels (Figure 15-10). The aileron and elevator servoactuators are similar.

Artificial Feel Unit

The artificial feel unit (AFU) of the elevator control system is similar to that of the aileron system. The monitoring circuit is common to the two systems. The AFU is installed in the rear compartment and is a helical spring box with a triple slope pattern and no threshold. It is attached at one end to the stub front beam, and at the other end to the Arthur Q-unit large arm.

Arthur Q-Unit

When the airspeed is less than 140 ± 15 knots (low-speed Arthur position), the lever ratio between input and output is 1:1. The total lever stroke is 4.0 inches (60 mm), providing a step-down ratio of 2.71:1 when the airspeed is greater than 370 ± 15 knots.

HORIZONTAL STABILIZER

SYSTEM DESCRIPTION

The horizontal stabilizer provides pitch trim (Figure 15-11). The stabilizer is hinged at the following two points:

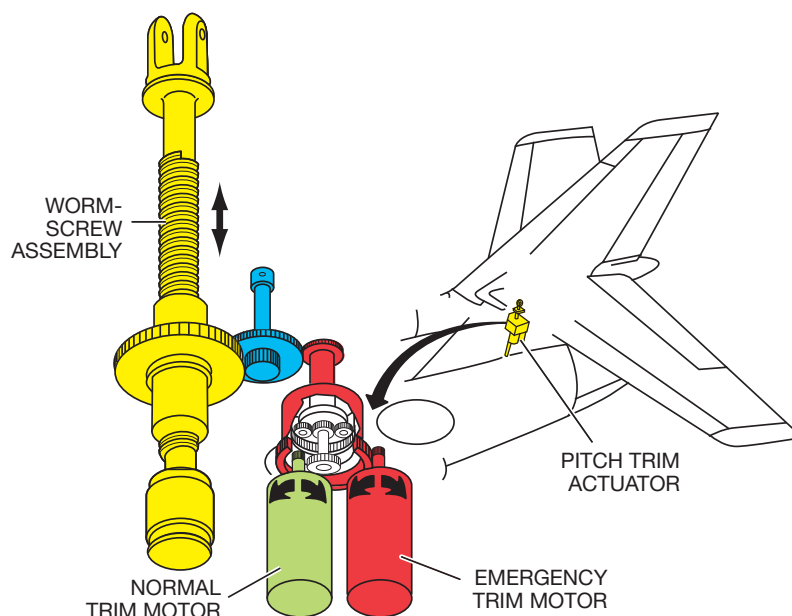
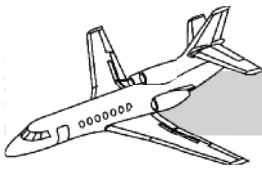

Figure 15-11. Pitch Trim



- At the rear, on a fitting integral with the vertical stabilizer stub
- At the front, through a torque link hinged on the horizontal airfoil structure and the vertical stabilizer stub

One motor provides normal operation, with A bus powered, and the other provides emergency operation. Nominal deflection is +1° to -11°. The motors operate independently of each other.

CONTROLS AND INDICATIONS

Horizontal Stabilizer Actuator Control Lever

The horizontal stabilizer actuator control switches control the horizontal stabilizer actuator through two motors (Figure 15-12).

During emergency operation, with B bus powered, the actuator is controlled by the horizontal stabilizer actuator TAILPLANE control lever located in the trim/horizontal stabilizer/airbrake control unit on the center console.

Horizontal stabilizer position and movement are indicated by the following:

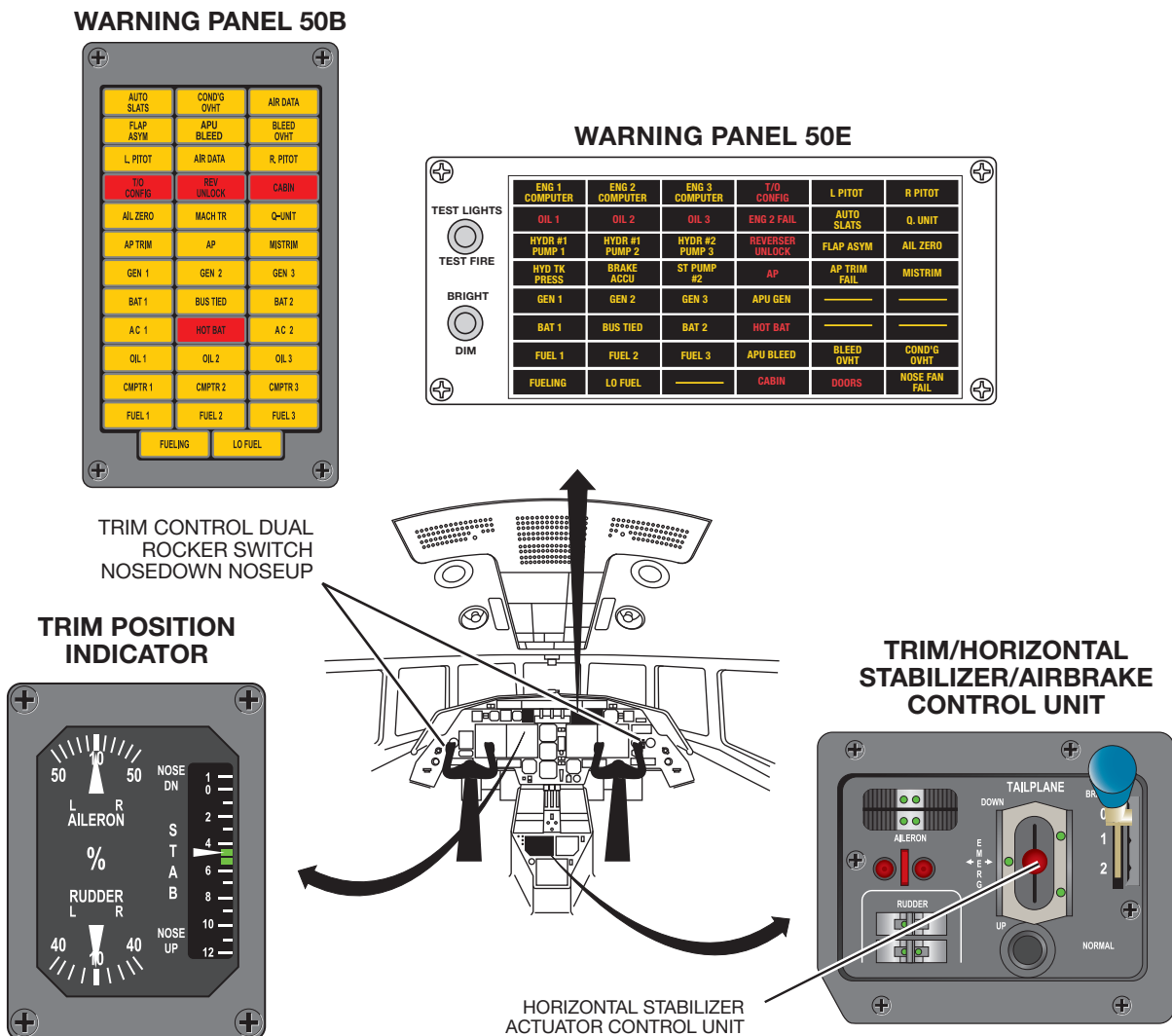
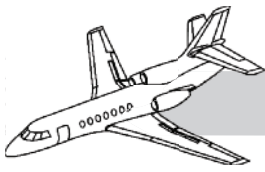

Figure 15-12. Horizontal Stabilizer Controls and Indications



- Trim position indicator located on the instrument panel
- Audio warning unit located on the instrument panel

On the ground, the T/O CONFIG light illuminates if the horizontal stabilizer configuration is out of the takeoff range.

An electromagnetic motion sensor is built into the horizontal stabilizer actuator. The sensor sends pulses that generate a rattle sound in the audio warning unit during any motion of the actuator, regardless of the mode of operation.

The horizontal stabilizer position is displayed in degrees on the trim position indicator on the center control pedestal (Figure 15-12). The indicator receives its input from the horizontal stabilizer position sensor.

SYSTEM OPERATION

In normal operation, the actuator is controlled by dual rocker switches on the pilot and copilot control wheels.

Operations in the auto trim and Mach trim modes are similar to operations in the normal mode. Autopilot or Mach trim arming and control inputs are applied in parallel with the pilot and copilot circuits.

Normal Operation

The operations are similar for the nose up and nose down actions. For a nose down action, the pilot or copilot presses the pushbutton that energizes the arming relay (cutting off the nose up power circuit). The B set of contacts of this relay removes the ground from the nose down power circuit and provides a ground to the nose up command circuit. This closes the nose down contactor and powers the motor through the deenergized relay.

End-of-travel limits are provided and consist of the following:

- The nose up end-of-travel limit is provided by two microswitches built into the horizontal stabilizer position sensor. The microswitches cut off grounding feedback of the contactor at an angle of -11° .

NOTE

Normal trim is limited to $+1^\circ$ to -5° nose up at airspeeds above 200 kts.

Emergency Operation

Actuation of the horizontal stabilizer actuator control lever on the control unit mechanically opens the circuit breaker located on the unit and causes the following:

- Opening of the normal control circuit
- Applies power to the emergency circuit

Positioning the lever to DOWN or UP energizes the windings of the standby motor through two microswitches used as end-of-travel electrical stops.

Auto Trim Mode Operation

When a change in flight conditions occurs, the airloads created by a permanent deflection of the elevators are taken into account. The deflection of the horizontal stabilizer cancels the permanent deflection of the elevators and allows the autopilot servomotor to operate around its neutral position.

NOTE

The difference between elevator slaving and horizontal stabilizer slaving is important. Elevator slaving positions the elevator according to the aircraft attitude deviation and returns it to neutral as soon as the deviation is canceled. Auto trim moves

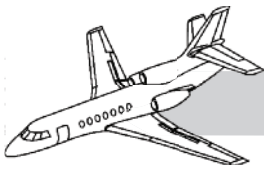

the horizontal stabilizer, as long as a command is applied, and maintains it in the new position. The deflection of the horizontal stabilizer is taken into account by the control signal coming from the autopilot.

Mach Trim Mode Operation

Mach trim is used to modify the manual longitudinal handling characteristics of the aircraft at high Mach numbers. It automatically ensures the required corrective maneuvers of the horizontal stabilizer when flying at speeds close to the maximum operating Mach number. Mach trim is engaged manually and inhibited when the autopilot is engaged.

The Mach trim actually works only when a Mach number of 0.78 is reached and when the autopilot is disengaged.

When the Mach trim is engaged, a synchronizer enables the pilot to manually correct the position of the horizontal stabilizer by using the trim switches without disengaging the Mach trim.

SLATS

SYSTEM DESCRIPTION

Each wing is fitted with inboard and outboard slats. The inboard slat (sliding) has a 20° deflection, and the outboard slat (slotted) has a 30° deflection. The slats are hydraulically powered by actuators to one of two positions: either fully extended or fully retracted (Figure 15-13).

A single four-position control lever (Figure 15-14), located on the pedestal, simultaneously

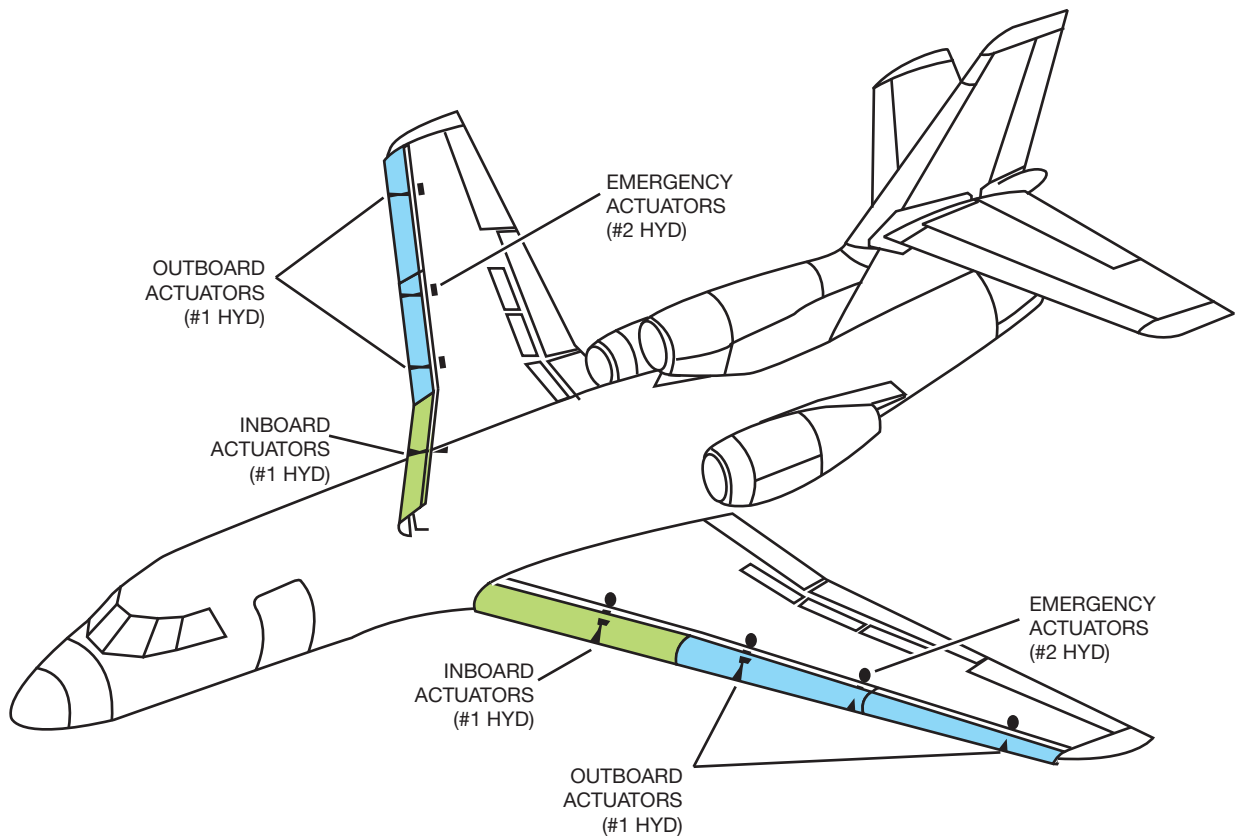

Figure 15-13. Slats Location

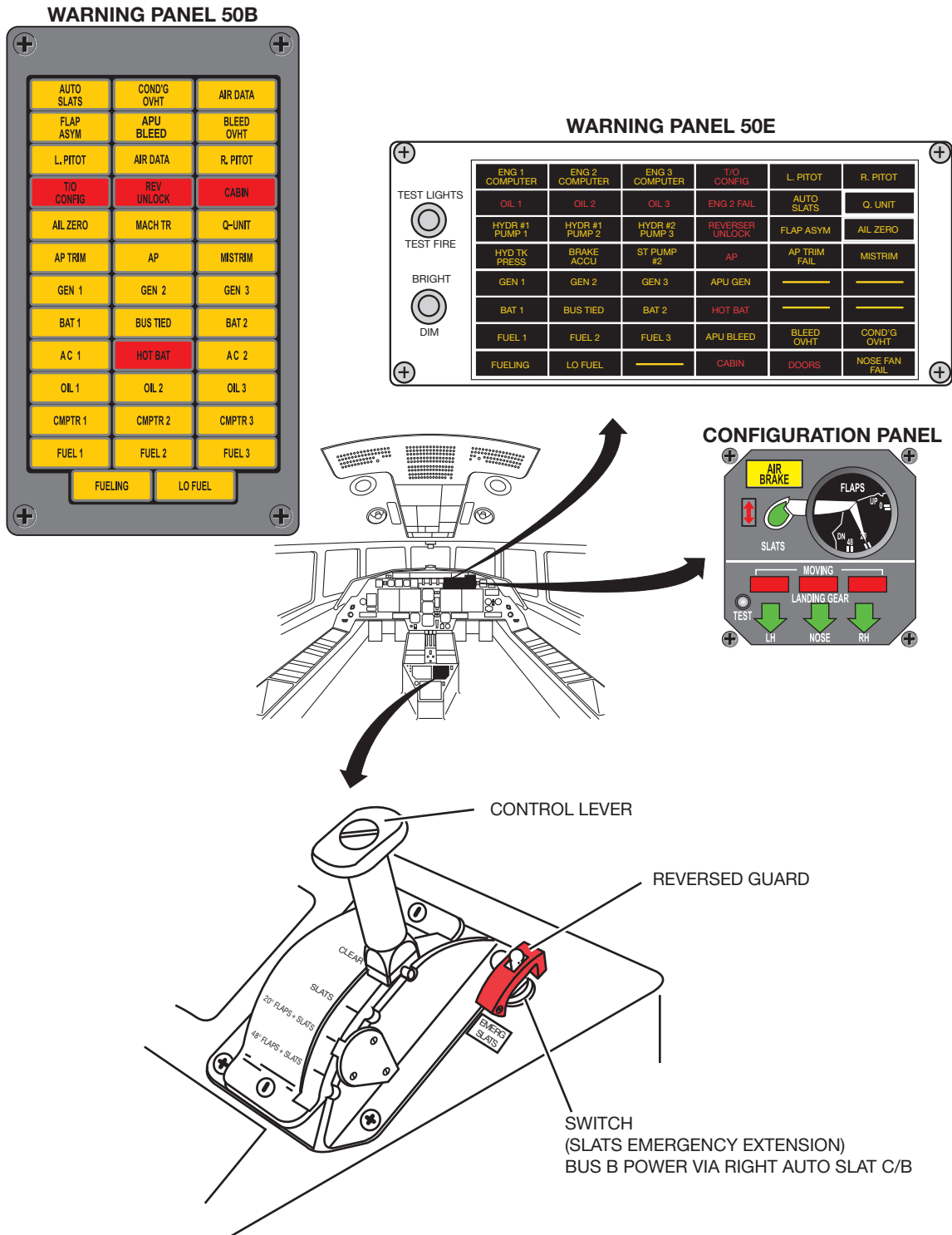
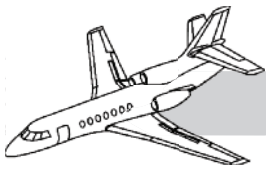
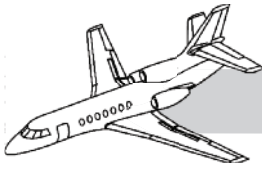

Figure 15-14. Slats Controls and Indications



positions both the flaps and the slats. There are three modes of operation:

- Normal operation—Controlled from the cockpit with simultaneous extension and retraction of all slats
- Emergency operation—For extension of outboard slats only and controlled from the cockpit
- Automatic operation—Provides outboard slat extension when nearing stall conditions. The slats are controlled by stall vane angle-of-attack sensors.

The slats are heated by hot air delivered through telescopic tubes in the slat ducts. Normal retraction actuators have a differential section with retraction chambers. The chambers continuously receive pressure from the No. 1 system. Once extended, the chambers are connected either to the reservoir return line or to the pressure line of the No. 1 system.

The emergency actuators are identical to the normal actuators except that both chambers are connected either to the reservoir return line or to the pressure line of the No. 2 system. The emergency actuators always operate in the differential mode and can be used only for extension of the slats.

CONTROLS AND INDICATIONS

Slats/Flaps Control Unit

The control unit is on the cockpit pedestal (see Figure 15-14). The control lever closes electrical contacts to simultaneously select flap positions and set the mechanical spool of the control valve (through a control cable) to obtain the associated slat positions.

The control unit includes a four-position lever:

- CLEAN—Slats and flaps retracted
- SLATS—Slats extended and flaps retracted
- 20° FLAPS + SLATS—20° flaps + slat-extended (takeoff and approach)
- 48° FLAPS + SLATS—48° flaps + slats extended (landing)

The four lever positions are notched and latched. To unlatch the lever first pull it up. A special notched position makes it impossible to move the lever from SLATS to 48° FLAPS + SLATS. A stop prevents the 48° FLAPS + SLATS position from being overridden.

Indicating Circuit

The indicating circuit consists of a green light and a red light. The green light illuminates when the slats are extended. The red light illuminates during slat transit.

Circuit logic is determined by microswitches actuated by the inboard and outboard slats.

AUTO SLAT Light

With S/B 166, the AUTO SLAT light on the warning panel simultaneously monitors the ground/flight detectors whatever the air speed (logic independent from IAS). A possible discrepancy can then be detected immediately after lift-off.

The flight manual is modified to give the crew the possibility to determine the difference between two types of failures:

- Light illuminating at low speed (below 65 ±5 knots) indicates that a ground/

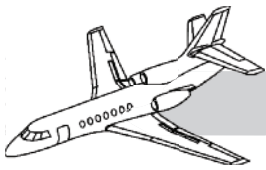

flight microswitch is faulty. Take care not to come too close to a stall condition during approach.

- Light illuminating at high speed (280 knots or above) indicates that the IAS safety microswitch is faulty. Speed must not exceed 265 ± 5 knots.

T/O CONFIG Takeoff Warning Light

This light on the warning panel indicates that the aircraft takeoff configuration is incorrect.

Illumination at takeoff occurs if the slats are not extended with the aircraft (landing gear shock absorbers depressed) on the ground and the throttle levers set to the TAKEOFF position.

SYSTEM OPERATION

Extension

When the lever is set to SLATS and the slats are not extended, the red indicator light illuminates.

Four nonextended slats microswitches control the light:

- Two for the inboard slats
- Two for the outboard slats

When the slats extend, the red light extinguishes and the green light illuminates.

Retraction

Setting the lever to CLEAN extinguishes the green light and illuminates the red light through operation of the following microswitches:

- Nonretracted inboard slat microswitches
- Outboard slat microswitches

The red light extinguishes when all of the microswitches sense that the slats have returned to the retracted position.

Emergency Slat Control

During extension, a switch causes illumination of the red light. When both slats are extended, actuation of two microswitches extinguishes the red light and illuminates the green light.

Automatic Slat Control

Two angle-of-attack vanes, one on either side of the front fuselage, sense the aircraft attitude and alert the pilot to an imminent stall condition.

The automatic mode initiates when the LH vane senses an angle of 17° or greater and an IAS below 270 knots. The main hydraulic system No. 1 supplies power to extend the outboard slats. A stall warning audio signal sounds, and automatic ignition signals are supplied to the engines.

As the angle of attack decreases below 17° , the signal reverses, and the slats are allowed to retract. As a safety factor, automatic ignition remains on for an additional 10 seconds on the EIED 1.

The RH vane also initiates an automatic mode when a 19° angle is sensed while the aircraft speed is below 270 KIAS. Both hydraulic systems are used to extend the outboard slats. Again, the engines receive automatic ignition. The same reverse mode applies as the angle of attack decreases below 19° .

Slat indication is the same for normal, emergency, and both automatic modes of operation. A red indicator light means the slats are in transit, while the green indication means a full extension. When the slat is fully retracted, all lights are extinguished. The slat configuration is an input to the red T/O CONFIG light. When the aircraft KIAS exceeds 270 ± 5 knots, the air data computer prevents the slats from extending by disabling the 17° and 19° contacts.

The slat system has an amber light labeled AUTO SLAT on the master warning panel. This light illuminates if either one of the auto

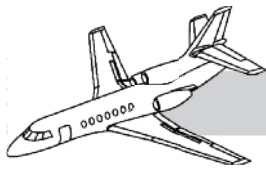

slat's deployment systems is still armed to extend the leading edges automatically above 280 knots. This airspeed input is received from the air data computers. If the speed-sensing switches malfunction, the amber AUTO SLAT light illuminates. Aircraft speed is then limited to 270 KIAS.

NOTE

Each stall vane is equipped with a 27° circuit which is active if the slats are fully extended. With the slats extended, the 17° and 19° circuits are disarmed; if the 27° circuit is activated, it will activate the stall audio warning and ignition to all three engines.

Stall Test Circuits

Two preflight test circuits test each automatic slat extension circuit. Each circuit is self-tested before flight with the self-test buttons on the pedestal:

- Stall 1 test for the 17° circuit
- Stall 2 test for the 19° circuit

Depressing the button causes the following:

- Operation of stall audio warning unit
- Engine ignition unit operation (all three engines) and illumination of the amber IGN lights
- Illumination of the red light when slats are in operation
- Slat extension (in either mode)
- Illumination of the green light at the end of extension with simultaneous extinguishing of the red light

Stall 2 Test

This test is conducted on the ground with the electric hydraulic pump running before starting the engines. This allows an actual check of the No. 2 system because there is no pressure in the No. 1 system. Continue holding the TEST

button and observe the AUTO SLATS light on (5 to 7 seconds). With S/B 166, the light illuminates only at the end of test.

NOTE

When the button is released, the slat remain extended and are retracted when system No. 1 is pressurized.

Stall 1 Test

This test is conducted on the ground following the starting of the No. 2 engine.

NOTE

With S/B 166, the auto slat also illuminates if either auto slat system remains in the ground test mode after takeoff.

FLAPS

SYSTEM DESCRIPTION

Each wing is equipped with inboard and outboard flaps (Figures 15-15 and 15-16). The flaps are double-slot, fixed Fowler type flaps. Rollers moving on tracks guide the flaps during extension and retraction.

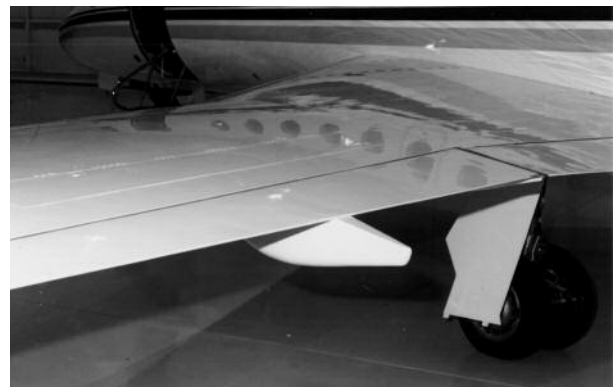
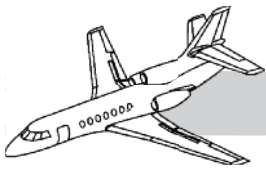

Figure 15-15. Flaps



The inboard flaps are positioned by two separate actuators, and the outboard flaps by a single actuator. The actuators are irreversible screwjacks. An adjustable rod provides interconnection between the two flaps.

One hydraulically operated gear motor positions the flaps and receives power from the No. 2 hydraulic system and D bus power.

CONTROLS AND INDICATIONS

Control Unit

The control unit is located on the right side of the pedestal (Figure 15-17). It has a lever moving between two notched sectors and may be set to any of four positions:

- CLEAN—Retracted slats and flaps
- SLATS—Extended slats
- 20° FLAPS + SLATS—20° flaps + slats extended (takeoff/approach)
- 48° FLAPS + SLATS—48° flaps + slats extended (landing)

To move the lever from one position to another, first free the lever by pulling it up before moving it. The lever drives the cable controlling the slats control valve to activate the microswitches. The microswitches then transmit an electrical control signal to the flap reduction gear motor control valve.

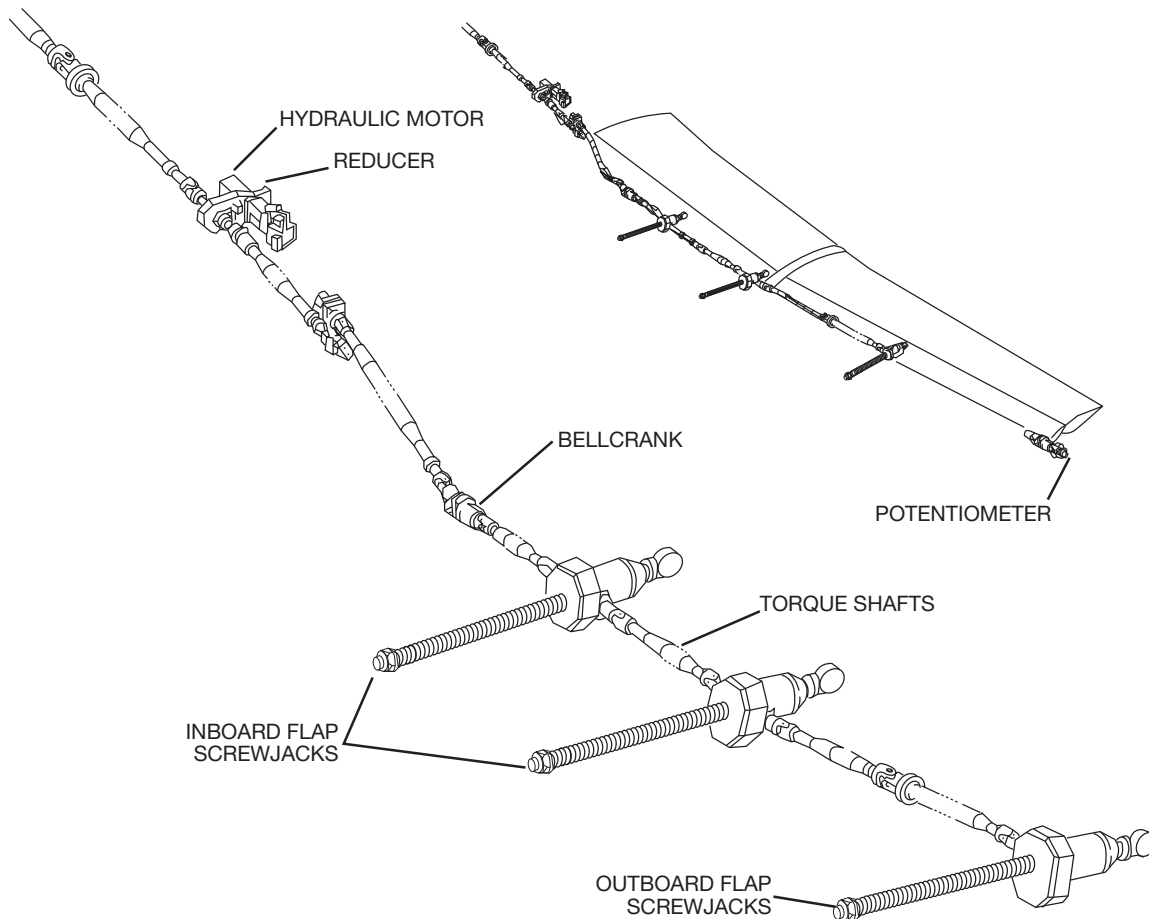

Figure 15-16. Flaps Location

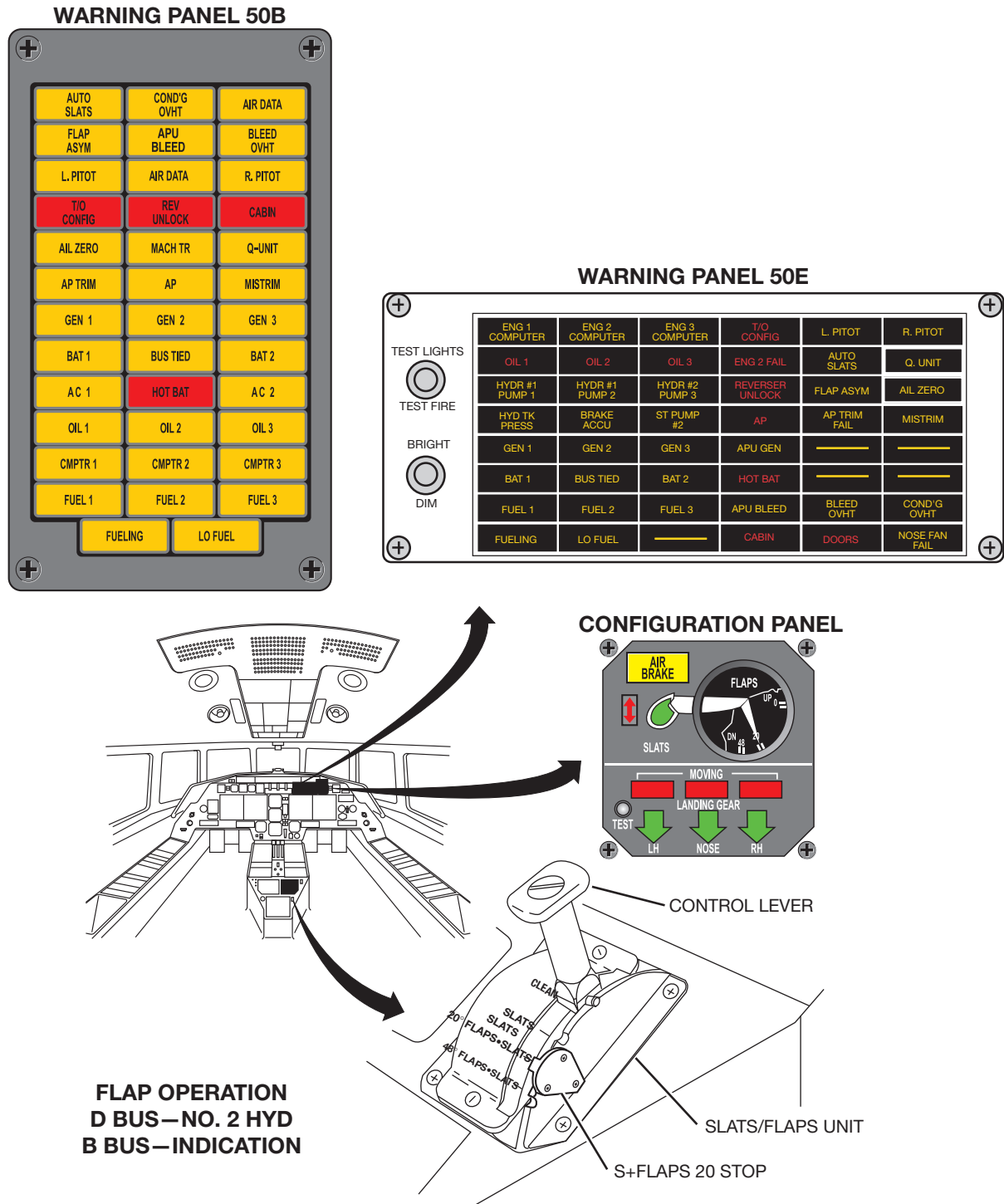
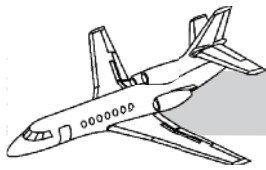
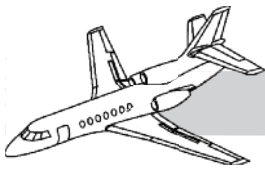

Figure 15-17. Flaps, Controls and indications



A special stop at the 20° FLAPS + SLATS position requires a brief pause regardless of the direction of motion. There is no emergency control. Electrical power for flap control is from bus D through the flap control circuit breaker.

Flaps Position Indicator

The flaps position indicator (Figure 15-17) is on the instrument panel in a box that displays slats, flaps, and airbrake positions. Flap position is displayed as a symbol of the flap profile with the inscription of the three controlled positions (0°, 20°, and 48°). The position data is supplied by a potentiometer unit located at the tip of the left outboard flap. Power for flap indication is provided through B bus flap A/B indicator circuit breaker.

Asymmetry Detection Circuit

On each wing, the potentiometer unit sends a position signal to the terminals of a differential relay located in the right electrical cabinet.

For an asymmetry difference of 5 to 8° between the two signals, a ground is provided to the differential relay, and the following events take place:

- The amber FLAP ASYM light on the warning panel illuminates
- The FLAP CONTROL circuit breaker opens, removing the power supply to the reduction gear motor control valve stopping the flaps in their present position

AIRBRAKES

SYSTEM DESCRIPTION

The aircraft is equipped with an airbrake system consisting of three moving panels hinged at the rear of the upper surface of each wing (Figure 15-18). The six panels are actuated by a differential section hydraulic actuator. The actuators are powered by the No. 2 hydraulic

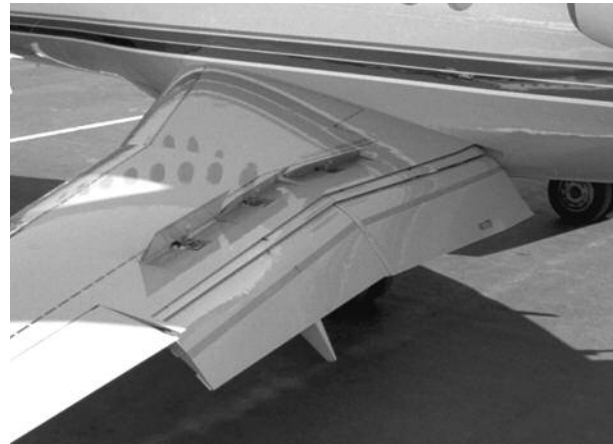

Figure 15-18. Airbrakes

system. Normal pressure comes either from the main pump driven by the No. 3 engine or, in case of failure, from the standby electric pump.

Retraction and extension of the airbrakes are controlled by a handle located on the left side of the pedestal. The handle controls the position of two solenoid control valves, which supply the two center panel actuators and the four inboard and outboard panel actuators, respectively.

Maximum deflection of each panel is as follows:

- Inboard panel—37°
- Center panel—50°
- Outboard panel—68°

CONTROLS AND INDICATIONS

Airbrake monitoring is provided by an indicating circuit whose function is to indicate to the pilot whether the airbrakes are extended or retracted (Figure 15-19). This circuit essentially consists of an amber AIRBRAKE light, incorporated into the configuration panel, and of six microswitches.

The microswitches are connected in parallel and are actuated if the corresponding panel leaves the retracted position. Illumination of

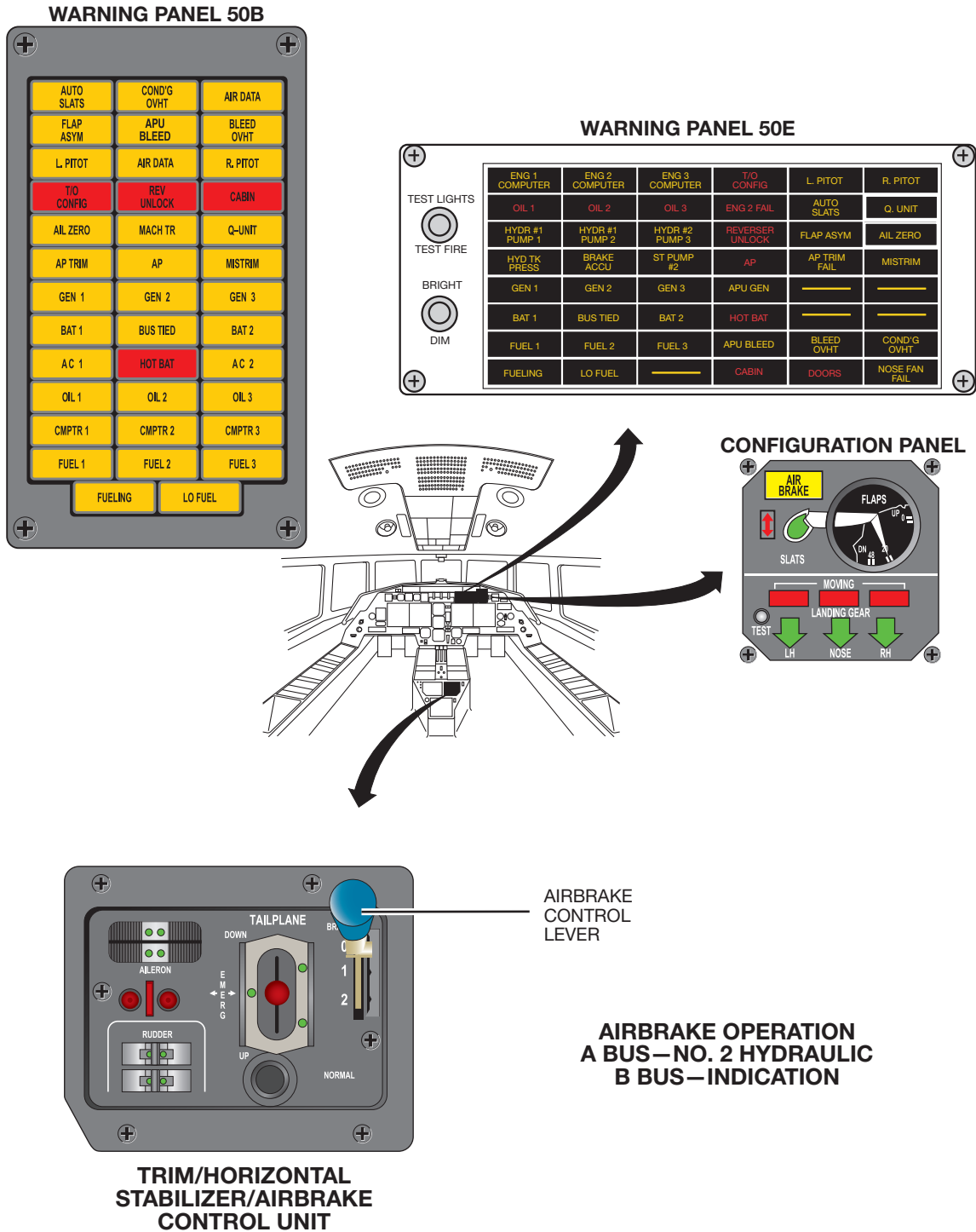
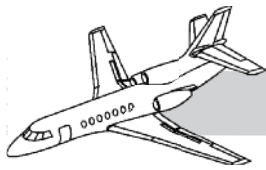
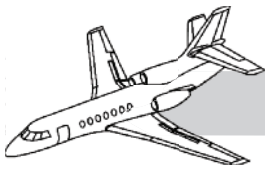

Figure 15-19. Airbrakes Controls and Indications



the AIRBRAKE light occurs when at least one of the six airbrakes is not retracted. Power for the airbrake indications is supplied from B bus.

T/O CONFIG Warning Light

This light is on the warning panel and alerts the pilot when takeoff configuration could influence flight safety. It illuminates when at least one of the three throttles is at 82° power lever angle, the aircraft is on the ground and one or more of the following is true:

- One of the four inboard airbrakes is not retracted
- One of the four slats is not extended
- The flaps are beyond the 22° position
- The horizontal stabilizer is out of the takeoff range (-3° through -7°)
- The autopilot is engaged
- Parking brake is applied or No. 2 brakes are applied

SYSTEM OPERATION

The airbrakes can be used at any speed to help slow the aircraft. At high speeds, the angular deflection of the panels is a function of the speed due to the capability of the actuators. The position corresponds to the balance between the airload on the panel and hydraulic pressure applied to the piston of the actuator.

Control Lever

The airbrake system is controlled by a lever located on the pedestal and built into the trim control panel (Figure 15-19).

The lever has three positions marked 0, 1, and 2 (front to aft). The lever is held in each position by a detent which requires a slight effort to move from one position to another in either direction. Airbrake control power is from bus A through the airbrake and control circuit breaker.

Position 0

The solenoid control valves are not energized, and hydraulic pressure is permanently applied to the retraction chambers of the actuators to maintain the airbrakes in the retracted position.

Position 1

Moving the lever to this position closes two microswitches:

- Center airbrake panel control valve microswitch—Energization of the valve solenoid provides hydraulic power to extension chambers of the actuators, and the center panels are extended.
- Electric pump start microswitch—Closes if the control switch is set to AUTO and if the No. 2 hydraulic system pressure is less than 1,500 psi.

Position 2

The microswitch controlling the inboard and outboard airbrake control valves closes, and the extension chambers of the outboard and inboard panel actuators are powered, which in turn, extends the panels.

LIMITATIONS

VA210 Knots

CAUTION

Full application of rudder or aileron controls, as well as maneuvers that involve angles-of-attack near the stall must be confined to speeds below VA. Rapidly alternating large rudder applications in combination with large sideslip angles may result in structural failure at any speed.

VFE

Slats Extended 200 Knots

Slats +20° Flaps 190 Knots

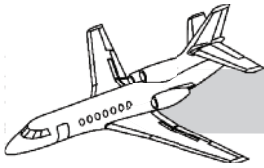

Slats +48° Flaps 175 Knots

Stall speed:

CAUTION

Do not intentionally fly the airplane slower than initial stall warning onset.

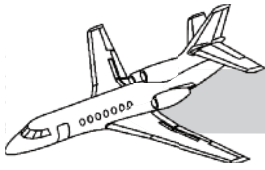

QUESTIONS

1. Hydraulic power is supplied to the primary flight controls:
 - A. Through dual-barrel servoactuators of which each barrel is pressurized by independent hydraulic systems
 - B. By the No. 1 system for normal operation and by the No. 2 system for trim operation
 - C. For operation of the ailerons and elevators (the rudder does not use hydraulic power)
 - D. Through independent servoactuators, one for each hydraulic system
2. Pitch trim is accomplished by:
 - A. A trim tab on the elevators
 - B. Operation of the Arthur Q-unit
 - C. A moveable horizontal stabilizer driven by two independent electric motors
 - D. A pitch trim control handle on the instrument panel
3. Which statement about the flaps and slats control unit is correct?
 - A. Flaps may be selected without selecting slats.
 - B. The S + FLAPS 20° position may be bypassed only when retracting the surfaces.
 - C. The control operates only the inboard flaps.
 - D. During normal operation of the slat flap handle, the outboard slats are the first to extend and the last to retract.
4. The stall prevention device is:
 - A. A stick shaker
 - B. Externally mounted angle-of-attack vanes that automatically control the slat extension/ ignition and audio warning
 - C. Active only below an airspeed of 215 knots
 - D. Not reflected on the slat indicator lights.
5. The electric standby pump automatically operates the air brakes when:
 - A. The airbrakes are moved from the retracted position
 - B. The No. 1 hydraulic system cannot support airbrake operation
 - C. The standby control is in AUTO, the airbrake control lever is set to 1 or 2, and the No. 2 hydraulic system pressure is too low to support airbrake operation
 - D. The amber AIRBRAKE light on the configuration panel is on

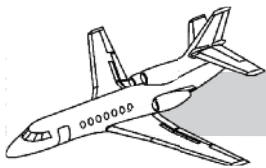

CHAPTER 16

AVIONICS

CONTENTS

	Page
INTRODUCTION.....	16-1
GENERAL.....	16-1
PITOT-STATIC SYSTEM.....	16-2
Pilot Pitot System.....	16-2
Copilot Pitot System	16-5
Static System.....	16-6
PITOT-STATIC INSTRUMENTS.....	16-8
Mach-Airspeed Indicator.....	16-8
Altimeters	16-8
Vertical Speed Indicators (IVSI).....	16-11
Triple Indicator.....	16-12
Miscellaneous Pitot-Static Devices.....	16-12
Pilot Pitot-Static System Malfunction	16-12
Copilot Pitot-Static System Malfunction.....	16-13
AIR DATA COMPUTER (ADC).....	16-13
Air Data Warning System	16-15
Air Data Computer Failure	16-16
ELECTRONIC FLIGHT INSTRUMENT SYSTEM (EFIS).....	16-16
General	16-16
QUESTIONS	16-17

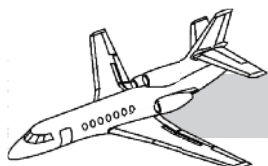

ILLUSTRATIONS

Figure	Title	Page
16-1	Pitot-Static System—Simplified Diagram.....	16-2
16-2	Pitot-Static System—Block Diagram.....	16-3
16-3	Pitot-Static System—Electrical Schematic	16-4
16-4	Pitot-Static System—Exterior Component Location	16-5
16-5	Pitot-Static System—Controls and Indicators.....	16-7
16-6	Mach-Airspeed Indicator.....	16-8
16-7	Pilot Altimeter	16-9
16-8	Copilot Altimeter.....	16-10
16-9	Emergency Altimeter.....	16-10
16-10	Altitude Alerter.....	16-11
16-11	Vertical Speed Indicator	16-11
16-12	Triple Indicator.....	16-12
16-13	Pilot Static System Malfunction.....	16-13
16-14	Copilot Pitot-Static System Malfunction	16-13
16-15	Air Data Computer	16-14
16-16	Central Air Data Computer—Inputs	16-14
16-17	Air Data Warning System	16-15

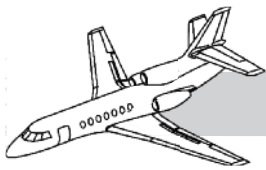

CHAPTER 16

AVIONICS



INTRODUCTION

Avionics equipment installed in the Falcon 50 varies considerably, depending upon the preferences of the operator. Certain basic equipment, however, is common to most aircraft. This equipment includes a number of basic instruments and components associated with the aircraft's pitot-static system.

GENERAL

The Falcon 50 is equipped with two independent pitot systems: the pilot system and the copilot system. The aircraft has three separate static systems: the pilot static system, the pilot alternate static system, and the copilot static system.

The instruments associated with the pitot-static system include the Mach-airspeed indicators, the

altimeters, the vertical speed indicators, air data computer, and the triple indicator. Miscellaneous devices associated with the pitot-static system include airspeed contact switches for the slat and landing gear systems and for the artificial feel system. The final section of this chapter concerns the air data computer system. Included is a list of the components which receive signals from the air data computer.

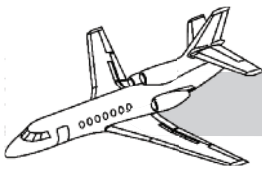

PITOT-SYSTEM

The Falcon 50 has two separate pitot systems: the pilot pitot system and the copilot pitot system. Figures 16-1, 16-2, and 16-3 are representative of the three common arrangement of pitot-static systems installed in the aircraft.

PILOT PITOT SYSTEM

The pilot pitot system (Figure 16-1) provides pitot pressure to the pilot direct reading, Mach-airspeed indicator, and the air data computer(ADC). In this system, there is only one ADC, and it supplies signals to the pilot- side

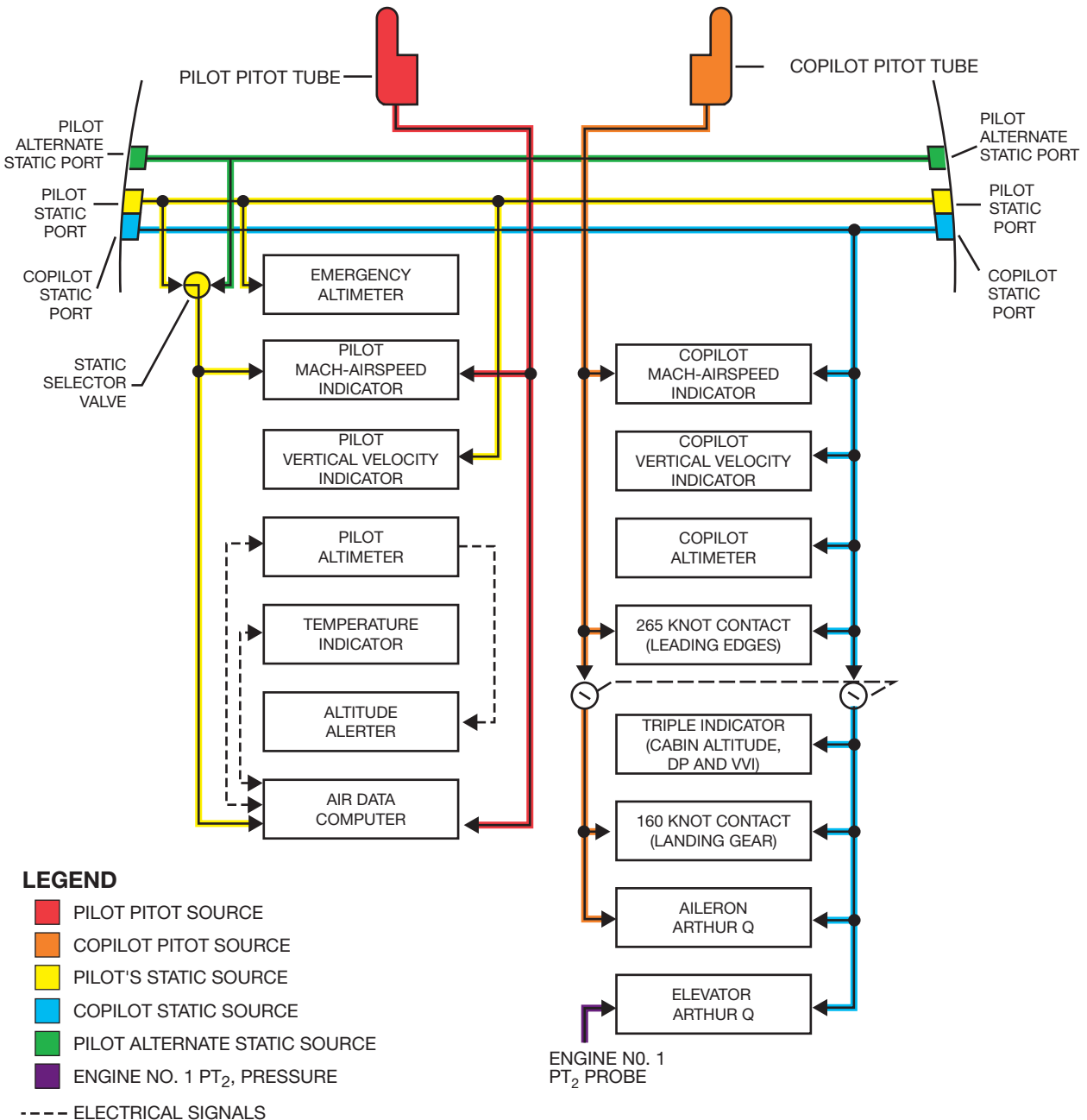

Figure 16-1 Pitot-Static System—Simplified Diagram

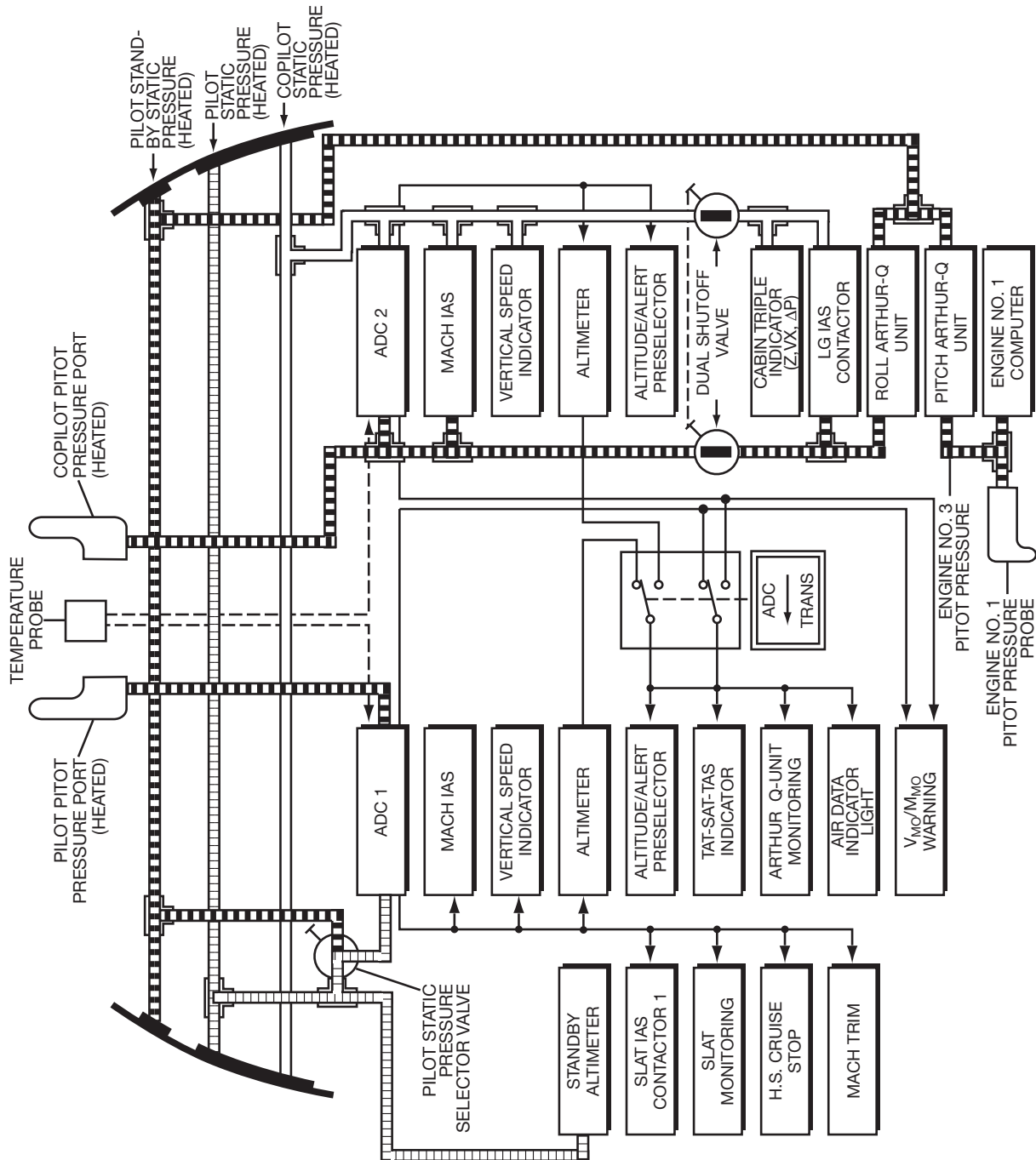
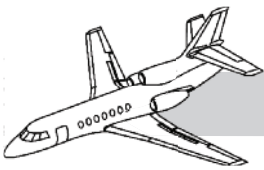

Figure 16-2. Pitot-Static System – Block Diagram

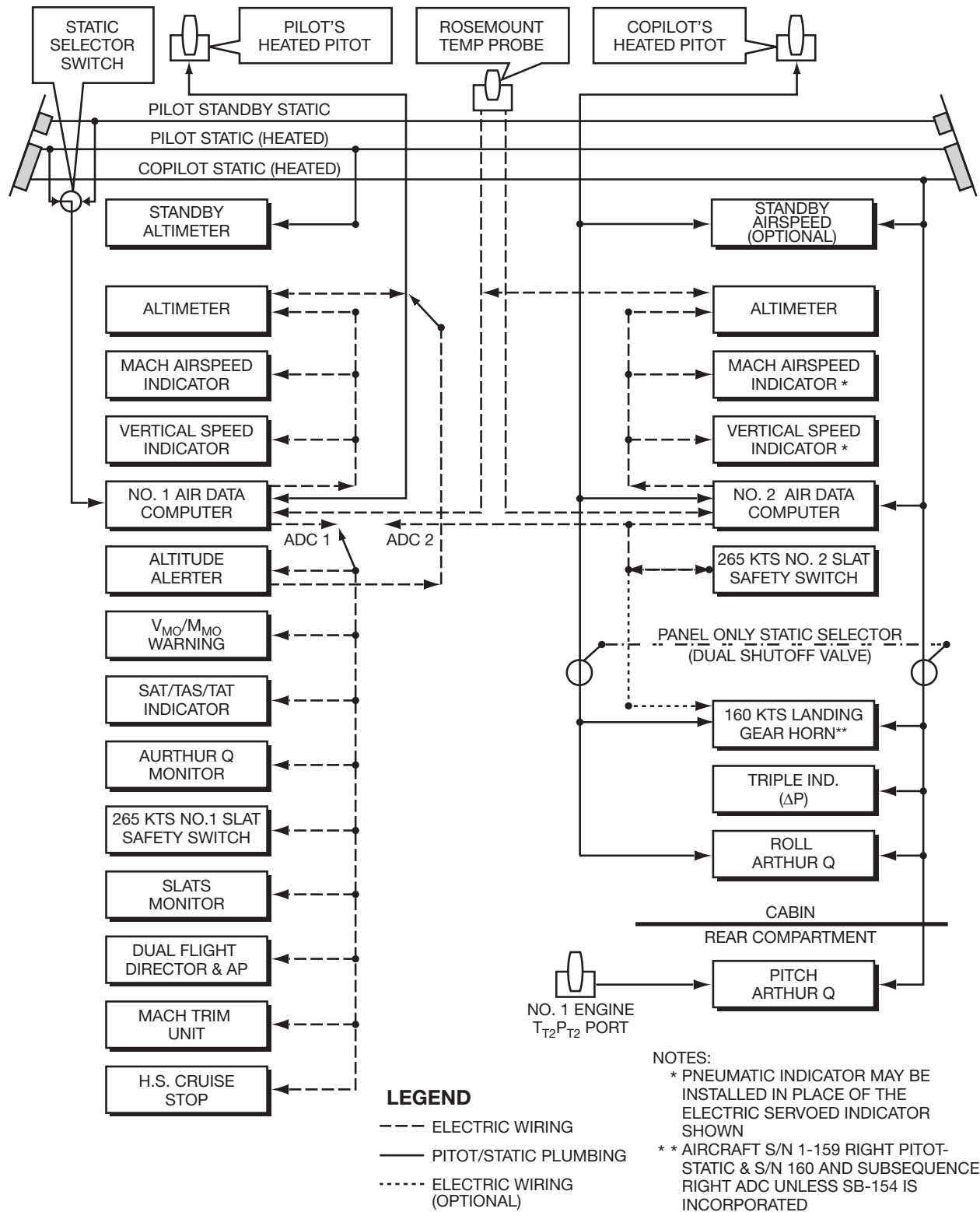
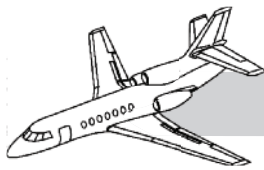
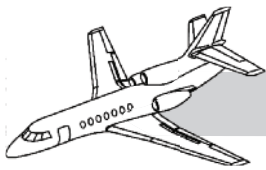

Figure 16-3. Pitot-Static System—Electrical Schematic



only. In the systems represented by Figures 16-2 and 16-3, the Mach-airspeed signals are supplied electrically by the pilot ADC.

COPILOT PITOT SYSTEM

The copilot pitot system (see Figure 16-1) provides pitot pressure to four components: the copilot direct reading Mach-airspeed indicator and the 265-knot contact switch (RH stall vane AUTO SLAT disarming switch) are supplied pitot pressure prior to the dual isolation valve; downstream of the dual isolation valve are the 160-knot contact switch (for the landing gear warning system) and the Arthur Q units for the aileron artificial feel system. In

the system represented by Figure 16-2, the Mach-airspeed signals are supplied electrically by the copilot ADC. In the system represented by Figure 16-3, the Mach-airspeed and landing 160-knot warning signals are supplied electrically by the copilot ADC.

Pitot Tubes

The pilot pitot tube is located on the left side of the forward fuselage, as shown in Figure 16-4. The copilot pitot tube is located on the opposite side of the fuselage. Both pitot tubes are anti-iced electrically. Ice protection for the pitot tubes is discussed in Chapter 10, “Ice and Rain Protection,” of this training manual.

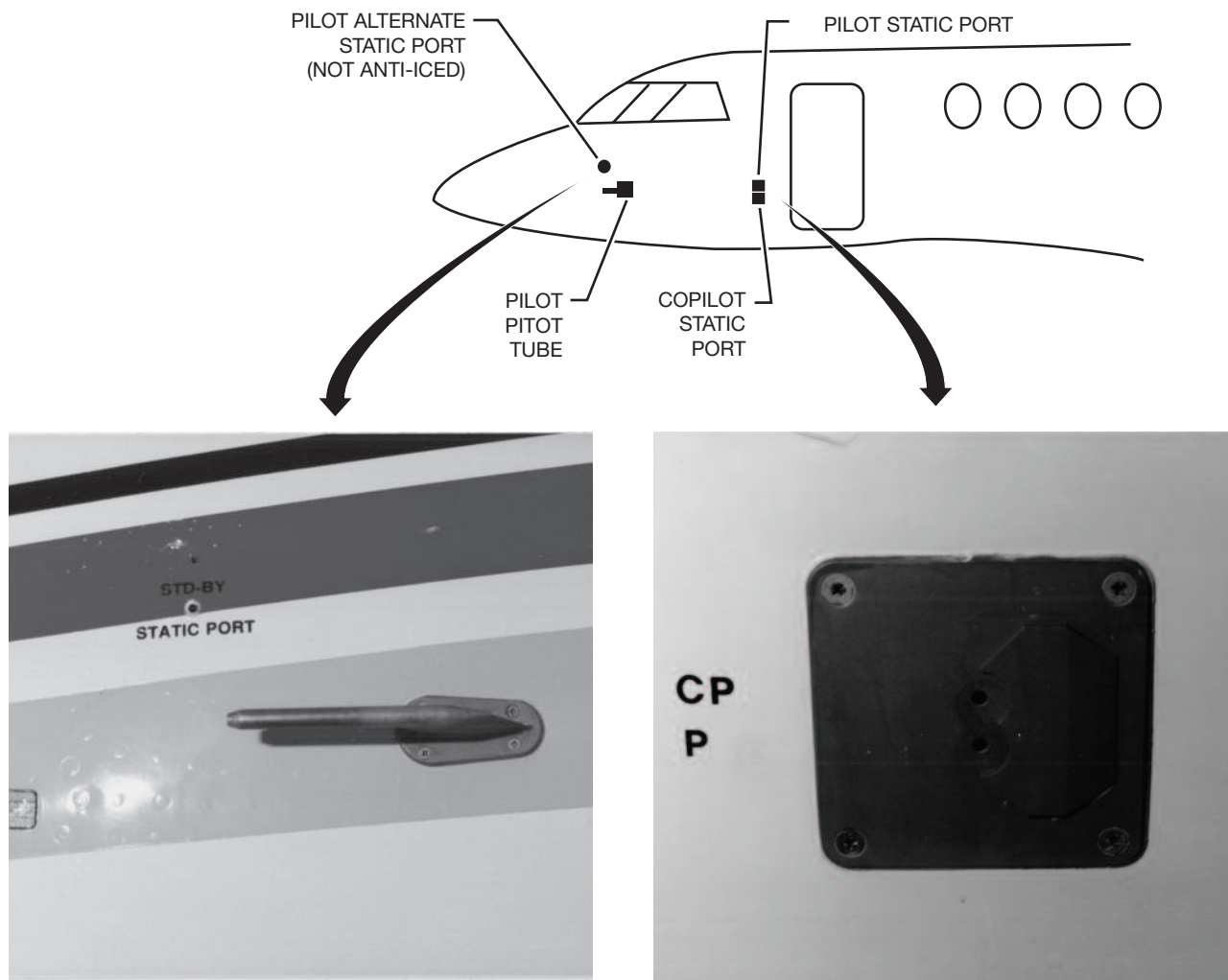
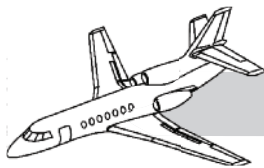

Figure 16-4. Pitot-Static System—Exterior Component Location



STATIC SYSTEM

As previously mentioned, the Falcon 50 has three independent static systems. The pilot has two systems; the pilot normal static system and pilot alternate static system. The copilot has only one static system, with no alternate system available (see Figure 16-1, 16-2, and 16-3).

The pilot and copilot static ports (see Figure 16-4) are installed on each side of the fuselage, just aft of the cockpit section. Both systems have an port on each side of the aircraft. The pilot alternate static ports are located just above the forward tip of the pitot tubes on each side (see Figure 16-4).

Pilot Static System

The pilot static system, as presented in Figure 16-1, provides a direct static pressure source to five components. These components are the pilot Mach-air-speed indicator, altimeter, vertical speed indicator (IVSI), ADC, and standby altimeter. The functions of the ADC will be discussed later in the chapter.

The standby altimeter and the pilot IVSI receive static pressure directly from the pilot normal static system and cannot receive alternate static pressure. When the pilot static selector is in the NORMAL position, the pilot Mach-air-speed indicator and ADC will receive static pressure from the pilot normal system, as shown in Figure 16-1.

In the systems represented by Figure 16-2 and 16-3, only two items are supplied static pressure. These are the ADC and standby altimeter. The ADC will supply signals to the Mach airspeed, altimeter, and IVSI.

Pilot Alternate Static System

In case the pilot Mach airspeed, IVSI, and altimeter read incorrectly, the pilot may place the static selector in the EMERG position. This action will supply the alternate static source through the selector valve to the pilot Mach-air-speed indica-

tor and ADC only (see Figure 16-1). In this particular system, the standby altimeter and the IVSI will remain on the pilot normal static system and therefore may be inaccurate. In the system represented by Figure 16-2 and 16-3, only the ADC will receive alternate static pressure as it will supply electrical signals to the Mach airspeed, altimeter, and IVSI.

The static selector valve is located on the lower left corner of the pilot instrument panel.

Unlike the pilot and copilot static ports, the pilot alternate static ports do not have anti-ice protection.

Copilot Static System

The copilot static system, as depicted in Figure 16-1, provides static pressure directly to the copilot Mach-air-speed indicator, IVSI, and altimeter. In addition, the copilot system supplies static pressure for operation of the RH stall vane AUTO SLAT system 265-knot contact switch, the landing gear warning horn 160 knot switch, the cabin pressurization system triple indicator, as well as the aileron and elevator Arthur Q units.

In some aircraft, an ADC will be installed in the copilot pitot-static system. The functions of the air data computers will be discussed later in this chapter.

Dual Isolation Valves

The dual isolation valves, (see Figures 16-1 and 16-2) are used to shut off the copilot pitot, and static pressure from the triple indicator, the 160-knot contact switch, and Arthur Q units.

The dual isolation valves are controlled by the pitot-static selector on the right corner of the copilot instrument panel (Figure 16-5).

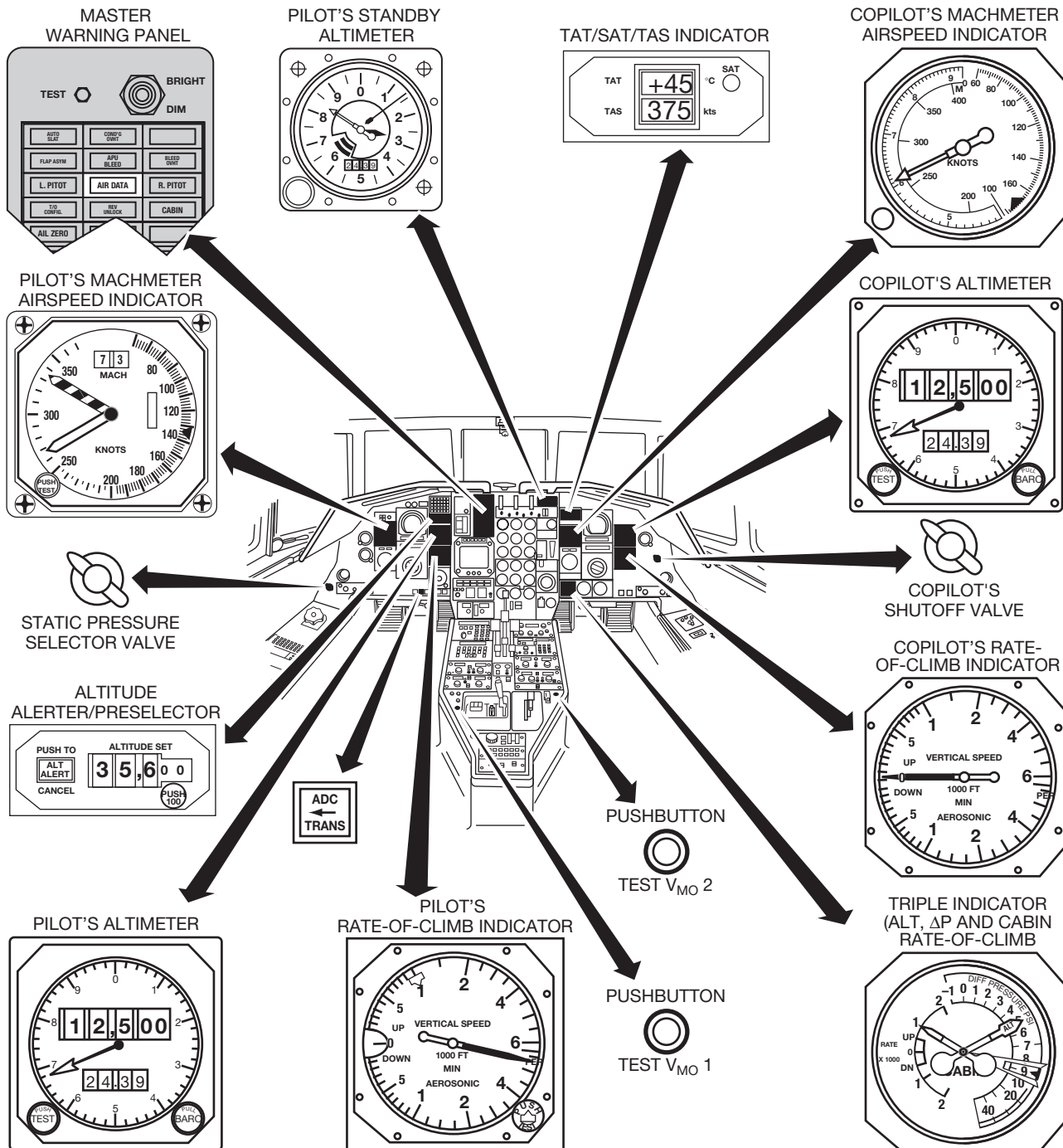
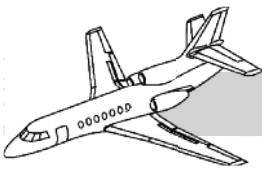
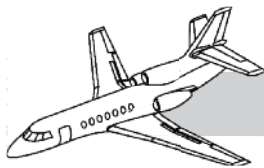

Figure 16-5. Pitot-static System—Controls and Indicators



PITOT-STATIC INSTRUMENTS

MACH-AIRSPEED INDICATOR

The Mach-air speed indicator (Figure 16-6) indicates both indicated airspeed (IAS) and Mach, using a single pointer. This is accomplished by a mobile Mach scale that rotates with changes in temperature and altitude. The appropriate Mach number remains aligned with the indicated airspeed scale, allowing the IAS-Mach to be read under the same pointer.

Limiting airspeed is indicated by the V_{MO}/M_{MO} pointer. Limiting airspeed varies from 350 KIAS to 370 KIAS between an altitude of sea level and 10,000 feet. Between 10,000 feet and 24,370 feet, the pointer remains at a steady value of 370 KIAS. While the aircraft is climbing, the Mach scale in the window under the pointer rotates counterclockwise reflecting the increasing Mach number until 0.86 Mach aligns with the pointer. When static system errors are considered, indicated Mach of 0.86 is actually a true Mach of 0.85.

A reference bug knob in the lower left-hand corner of the indicator controls the reference bug. This bug can be set to any desired airspeed for use as an airspeed reminder.

In the early aircraft (see Figure 16-1), the indicator was a pneumatic/mechanical instrument supplied pitot-static pressure directly to provide speed indications. In the later systems, the ADC supplies electrical signals to the Mach-air speed indicator (see Figures 16-2 and 16-3).

ALTIMETERS

Pilot Altimeter

The pilot altimeter is an electrical encoder type using signals from the ADC. This altimeter is not only a reference for the pilot, but also performs the altitude reporting function for air traffic control through the aircraft's transponder system and provides information to the altitude alerter which will be covered later.

The pilot altimeter has a rotating pointer which covers 1,000 feet per revolution. Altitude is also indicated in a rotating drum-type indicator window. (Figure 16-7).



Figure 16-6. Mach-Airspeed Indicator

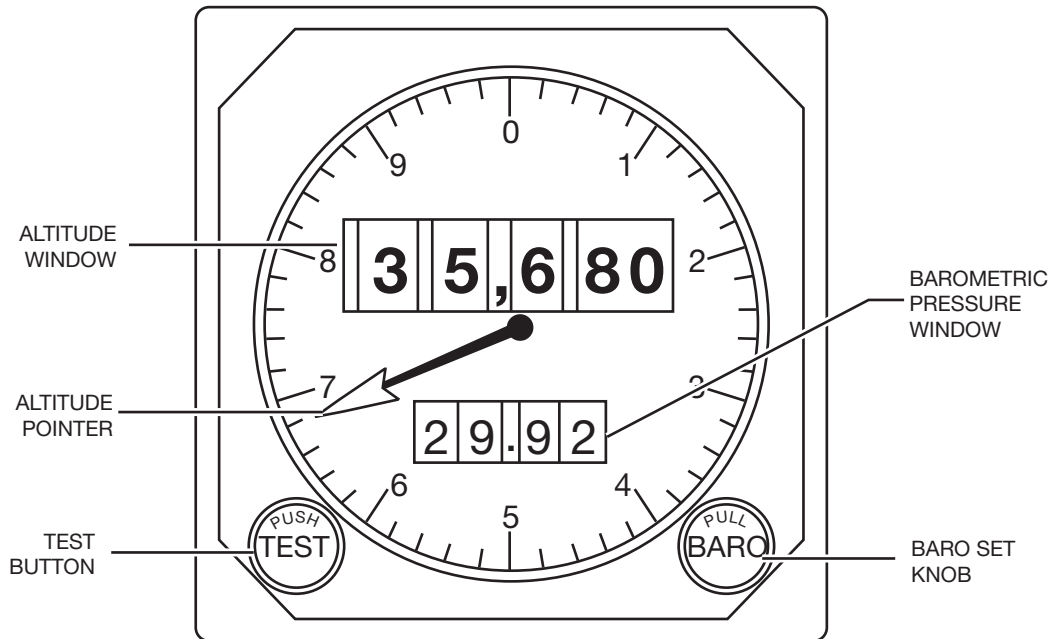
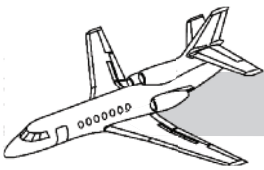

Figure 16-7. Pilot Altimeter

The smaller window indicates the reference barometric pressure in either inches of mercury or millibars. This reference pressure is adjusted by rotating the baro set knob on the lower right instrument bezel. The pressure window indicates inches of mercury when the knob is pushed in, and millibars when the knob is pulled out.

A TEST button is located in the lower left bezel of the instrument. When the button is pushed, a flag appears for half a second and the pointer rotates 750 feet, indicating a successful test.

Copilot Altimeter

The copilot altimeter may be a pneumatically operated instrument or an electrically operated indicator just like the pilot. If the aircraft has only one ADC the copilot indicator will be a pneumatically operated instrument. If the aircraft has two ADC's the copilot will most likely have an electrically operated instrument. The copilot electrically operated altimeter will work like the pilot indicator.

The copilot pneumatically operated altimeter will have the drum-type altitude windows with a drum to display ten thousands, thousands and hundreds of feet (Figure 16-8). The altitude pointer indicates altitude in 20-foot increments above the value displayed on the hundreds drum.

Emergency Altimeter

The emergency altimeter is a counter-drum-pointer type pneumatic altimeter, as shown in Figure 16-9. The crosshatch area represents a low-altitude warning indicator whenever the altitude indicates below 10,000 feet. This area disappears as the altitude increases and the 10,000-foot drum indicator appears. A baro set knob adjusts the reference pressure of the barometric pressure window.

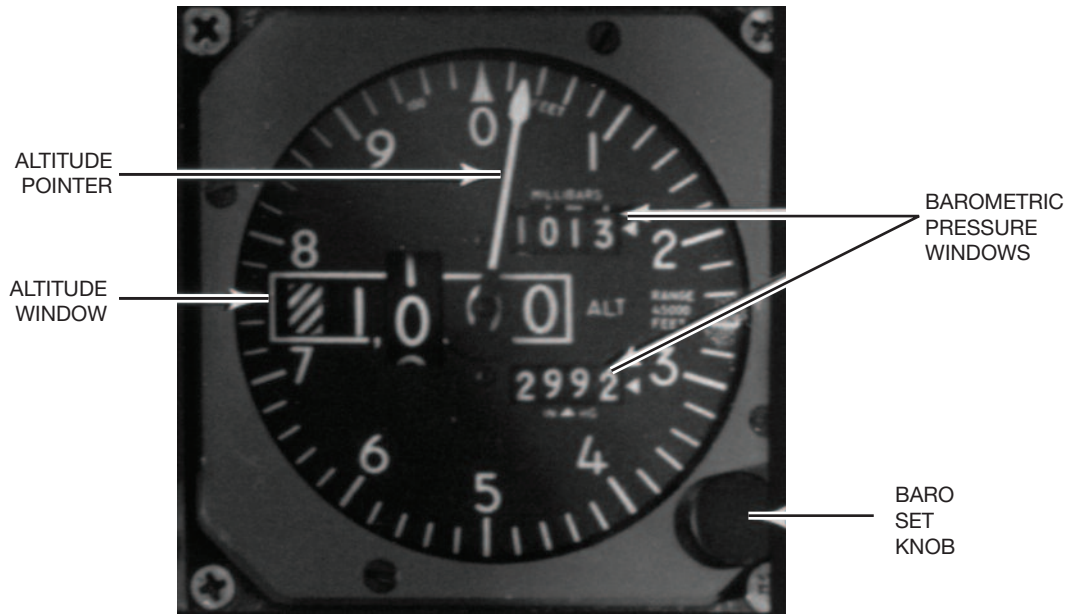
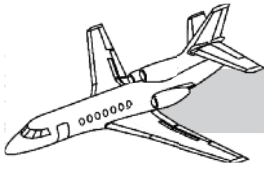

Figure 16-8. Copilot Altimeter

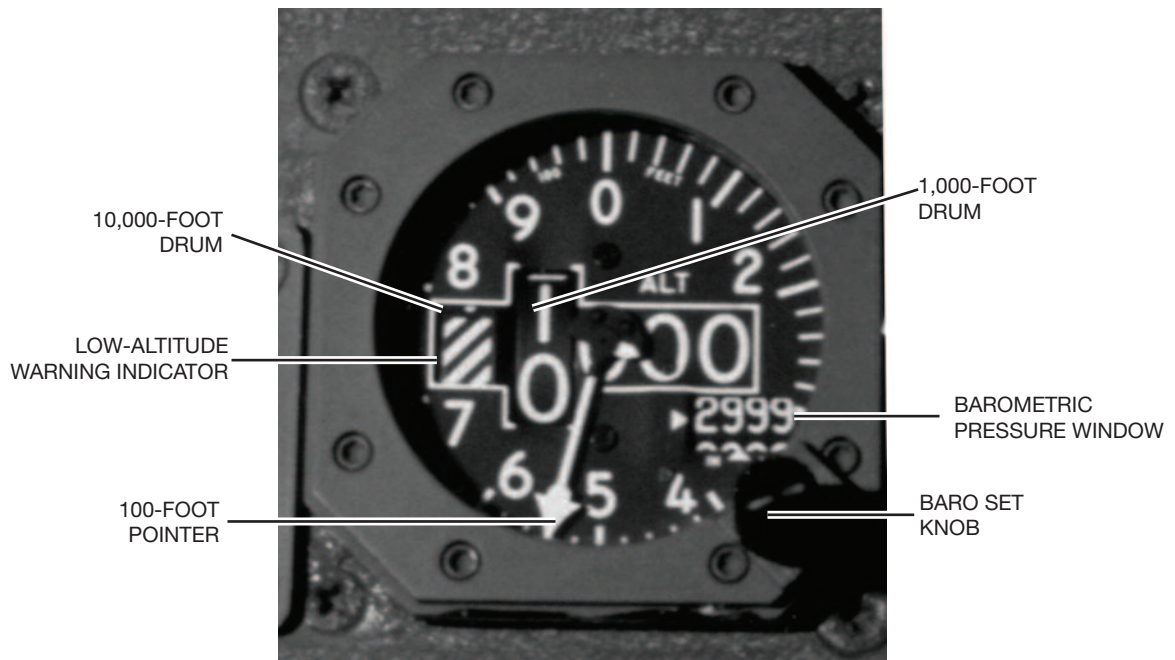
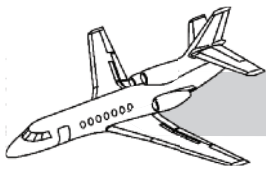

Figure 16-9. Emergency Altimeter



Altitude Alerter

The altitude alerter (Figure 16-10) provides the pilot with both visual and aural warnings that the aircraft is deviating from a preselected altitude. The alerter receives corrected altitude data from the pilot altimeter.

An altitude is selected by using the altitude set knob. As the aircraft approaches within 1,000 feet of the selected altitude, the audible warning sounds for two seconds and the alert light comes on.

The light goes out when the aircraft reaches 300 feet from the preset altitude and remains off within this range (± 300 feet). When the aircraft departs the ± 300 foot range, the audible warning sounds for two seconds and the alert light comes on. The alert light can be turned off at any time by pressing the light itself or by setting another altitude in the window.

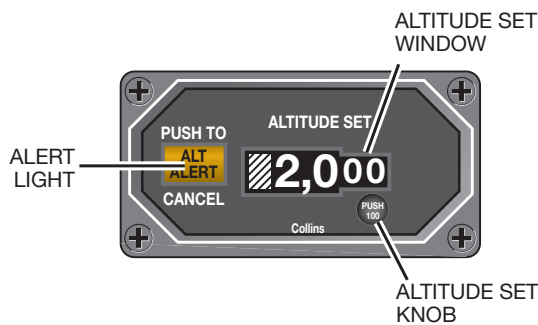

Figure 16-10. Altitude Alerter

VERTICAL SPEED INDICATORS (IVSI)

The pilot and copilot instrument panels are equipped with identical vertical speed indicators, which are supplied static pressure directly, in the single air data computer pitot-static system (Figure 16-11). The indicators are conventional in design and operation with a 6,000 feet-per-minute maximum vertical speed indication capability.

The pitot-static systems with dual air data computers usually have electrically vertical speed indicators. They are also used to display TCAS information to the crew and are the CRT-type indicators. These IVSIs are supplied signals from the air data computers (see Figures 16-2 and 16-3).



Figure 16-11. Vertical Speed Indicator

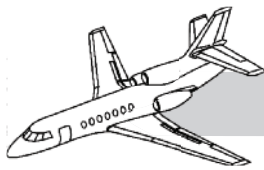

TRIPLE INDICATOR

The triple indicator (Figure 16-12) is used to monitor the performance of the cabin pressurization system. The instrument indicates cabin altitude, pressure differential between the interior and exterior of the cabin, and vertical velocity of the cabin altitude change.

Operation of cabin pressurization system is covered in Chapter 12, "Pressurization."

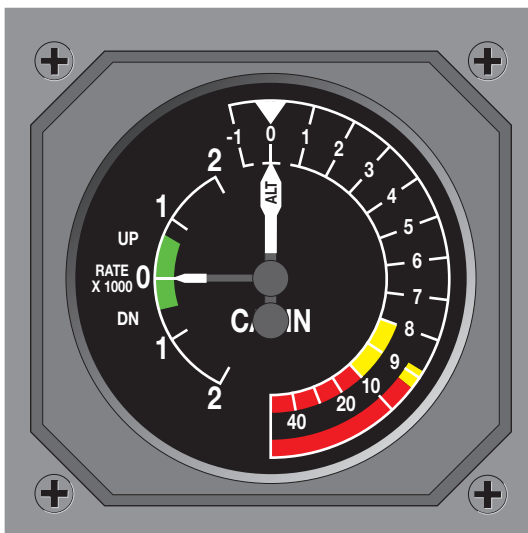

Figure 16-12. Triple Indicator

MISCELLANEOUS PITOT-STATIC DEVICES

265-Knot Contact Switch

The 265-knot contact switch is located on the copilot pitot-static system upstream of the dual isolation valves (see Figure 16-1). The switch operates in conjunction with the automatic control system of the wing slats. It is used to disarm the RH autoslat operation at 265 knots.

Operation of the wing slats is covered in Chapter 15, "Flight Controls."

160-Knot Contact Switch

The 160-knot contact switch is located downstream of the dual isolation valves (see Figure 16-1). The switch allows the landing gear warning horn to sound when the indicated airspeed is less than 160 knots, one throttle is retarded, and the gear is unsafe. Operation of the landing gear warning system is covered in Chapter 14, "Landing Gear and Brakes."

Artificial Feel System

Pitot-static inputs from the copilot pitot-static system are used by the aircraft's artificial feel system. The inputs are provided to the aileron and elevator Arthur Q units to vary the artificial forces applied to the controls. The elevator artificial feel receives pitot pressure from the No. 1 engine P_{T2} probe.

Operation of the artificial feel system is covered in Chapter 15, "Flight Controls."

PILOT PITOT-STATIC SYSTEM MALFUNCTION

A malfunction in the pilot pitot-static system is indicated by inaccurate airspeed, altitude, or vertical velocity indications on the pilot instruments.

In this situation, place the static selector in the EMERG position (Figure 16-13). Use the pilot instruments if indications return to normal, otherwise use copilot indicators.

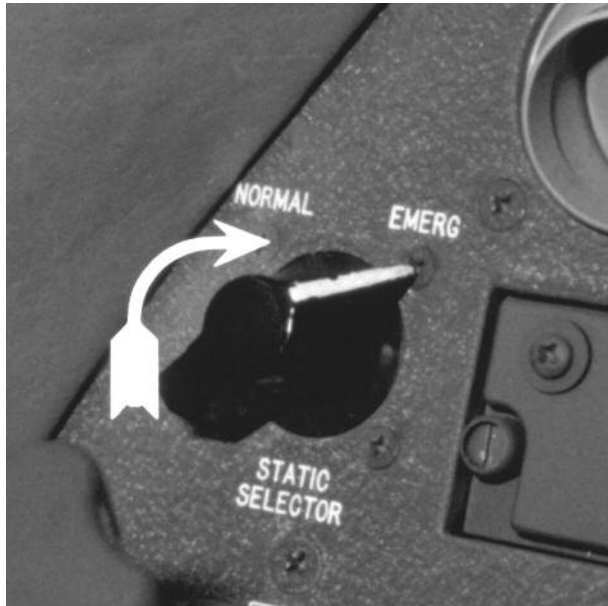
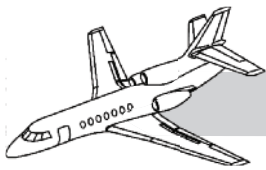

Figure 16-13. Pilot Static System Malfunction

COPILOT PITOT-STATIC SYSTEM MALFUNCTION

A malfunction in the copilot pitot-static system is indicated by inaccurate airspeed, altitude, or vertical velocity indications on the copilot instruments. In addition, the Q-UNIT warning light may come on.

Place the pitot-static selector in the PANEL ONLY position (Figure 16-14) and follow the Arthur Q unit inoperative procedures.

Keep in mind that placing the pitot-static selector in the PANEL ONLY position closes the dual isolation valves (see Figure 16-1). This renders the Arthur Q units inoperative. In addition, the cabin differential pressure indicator may be inoperative and the landing-gear-not-extended warning horn system can no longer be actuated at 160 knots or below.

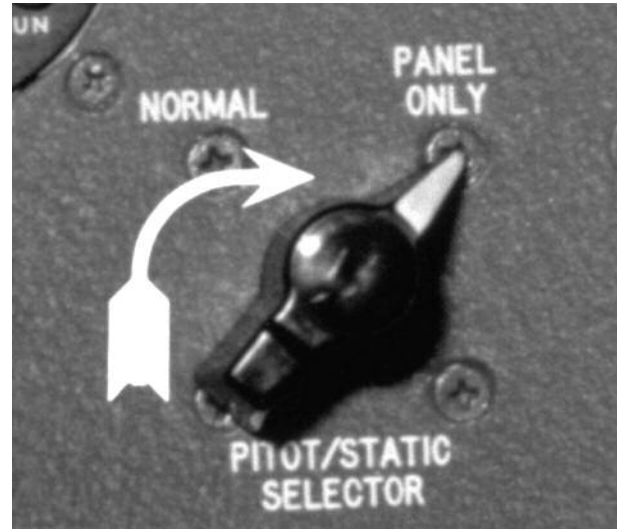

Figure 16-14. Copilot Pitot-Static System Malfunction

AIR DATA COMPUTER (ADC)

The pilot ADC is located in the left-hand electrical equipment rack behind the pilot seat (Figure 16-15). The copilot ADC is located in the right-hand electrical equipment rack, behind the copilot seat.

The computer receives raw pneumatic pressure inputs from the pitot-static systems and electrical signals from the TAT probe. These inputs are electrically corrected and sent to a number of systems and components (Figure 16-16).

The pilot ADC is referred to as ADC 1. The ADC 1 receives pitot-static pressure from the pilot system. The No. 1 ADC will normally supply electrical signals to operate the pilot Mach-airspeed indicator, altimeter, and IVSI. Also the No. 1 ADC will supply signals to the altitude alerter through the pilot altimeter, TAT-SAT-TAS indicator, Arthur Q unit monitoring, air data indicator light, V_{MO}/M_{MO} , slat IAS 1 contact, slat monitoring, Mach trim, and high-speed cruise-stop pitch-trim limiter.

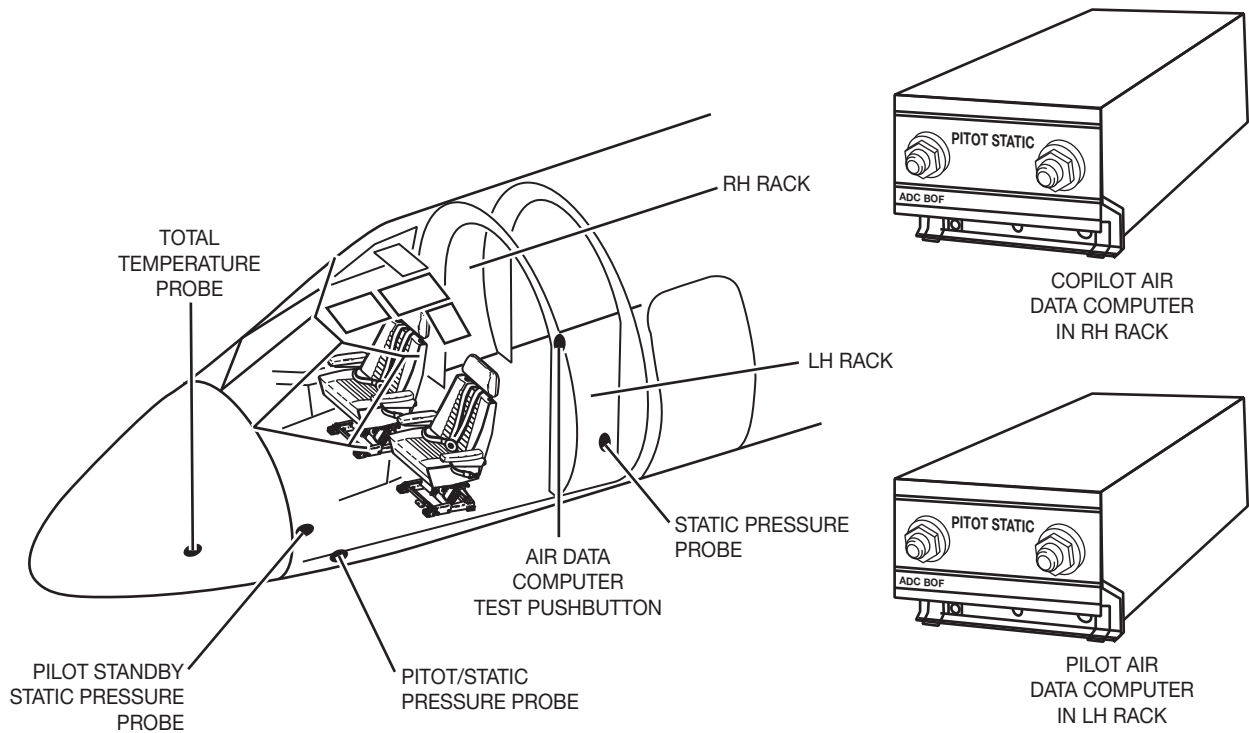
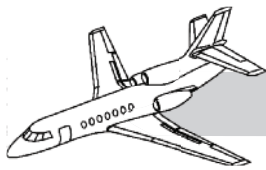

Figure 16-15. Air Data Computer

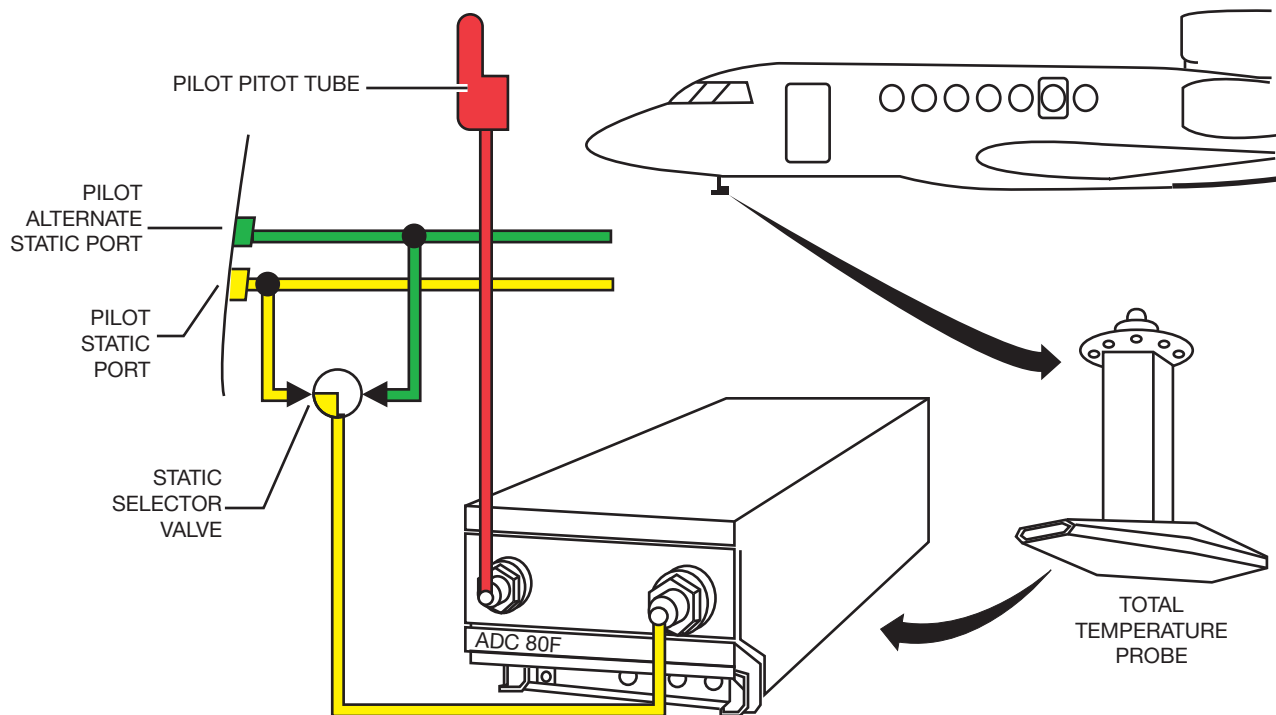
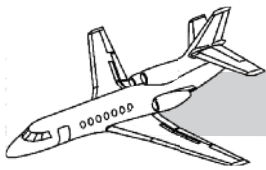

Figure 16-16. Central Air Data Computer—Inputs



The copilot ADC, when installed, is referred to as ADC 2. The No. 2 ADC is supplied pitot-static signals from the copilot pitot-static system. ADC 2 will supply electrical signals for the operation of the copilot altimeter, Mach-airspeed, IVSI, and landing gear 160 warning horn system. In this system, (see Figures 16-2 and 16-3), the No. 2 ADC can be selected to supply signals to the altitude alerter, V_{MO}/M_{MO} warning, total air temperature (TAT) indicator, Arthur Q Unit monitoring, and air data indicator light. In the system represented by Figure 16-3, the copilot ADC will supply signals, in addition to those just mentioned, to the IAS contactor LH slats, slat monitoring, dual flight guidance and autopilot, Mach trim, and high speed cruise stop for the pitch trim limiting.

AIR DATA WARNING SYSTEM

Outputs from the air data computer are monitored continuously by the air data warning system. Loss of signal validity causes the AIR DATA warning light on the master warning panel to come on (Figure 16-17).

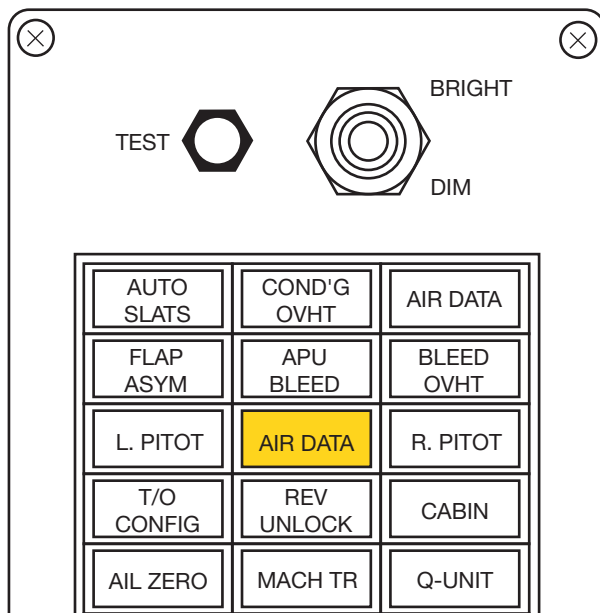

Figure 16-17. Air Data Warning System

AIR DATA COMPUTER FAILURE

Air data computer failure is indicated by illumination of the AIR DATA light on the master warning panel.

Several other indications are possible:

- Q UNIT and AUTO SLAT warning lights may come on.
- Overspeed warning horn may be activated.
- Total temperature indicator may be inoperative.
- Altimeter and ALT ALERT warning flags may come into view.

In addition, other systems using air data computer inputs may provide erroneous information.

In case of air data computer failure, disengage the autopilot and yaw damper systems and do not use the flight director system.

If the pilot altimeter is inoperative, use the standby, or copilot, altimeter. In addition, switch the transponder to ATC 2 if the copilot panel is equipped with an encoding altimeter. This will ensure proper altitude reporting to air traffic control facilities.

ELECTRONIC FLIGHT INSTRUMENT SYSTEM (EFIS)

GENERAL

Most Falcon 50s are equipped with Collins EFIS-85C(14)/86C(14) flight instrument display systems. The EFIS-85C uses 5-inch by 5-inch displays and the EFIS-86C uses 5-inch by 6-inch displays.

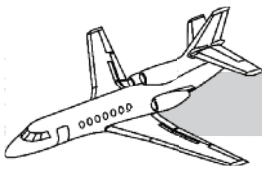

In the EFIS-86C system, attitude and navigation information is displayed on color CRTs (cathode ray tubes) which become an EADI (electronic ADI) and an EHSI (electronic HSI).

Additional information such as weather radar, NAVAID/waypoint location, airspeed, wind vectors, up to four formats of moving map displays, FCS (flight control system) mode annunciation, autopilot/yaw damper engage status, attitude comparator warning, CAT II excessive deviation, decision height, checklists, and diagnostic messages may also be displayed.

The system gives the pilot the capability to display information never before available, in the area of his central scan, by allowing him to select or deselect information depending on the regime of flight, and by providing the pilot a means of easily seeing the interrelationships of dynamically changing flight data.

The EFIS-86C installed on the Falcon 50 is a 5-tube system with dual CRTs on the pilot instrument panel for EADI and EHSI display, dual CRTs on the copilot instrument panel, and a center panel mounted multifunction flight display (MFD).

The EFIS system in this aircraft is used with the Collins FCS-85 flight control system which supplies signals to display pitch/steering commands for the command bars in the EADI.

The EFIS-86C system uses input data from the following sources:

- Navigation systems
- AHS (attitude heading system)
- Conventional vertical gyro, compass system, and longitudinal accelerometers
- Radio altimeter
- Air data system
- Angle-of-attack system
- Distance measuring system
- Flight control system
- Long-range navigation system
- Vertical navigation system
- Weather radar system
- Automatic direction finding system

The EFIS-86C system, in turn, uses these inputs to display V-bar steering commands and other navigational data for flight control purposes, as well as information of advisory nature.

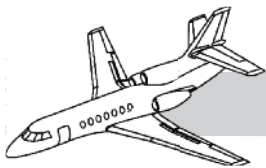

QUESTIONS

1. What static system supplies inputs to the pilot Mach-air-speed indicator when the static selector is placed in the EMERG position?
 - A. Pilot static system
 - B. Copilot static system
 - C. Pilot alternate static system
 - D. Dual isolation system
2. What three systems are affected when the dual isolation valves are closed?
 - A. Cabin pressurization indication system, altitude alerting system, Arthur Q system
 - B. Cabin pressurization indication system, landing gear warning system, Arthur Q system
 - C. Auto slat system, altitude alerting system, Arthur Q system
 - D. Cabin pressurization indication system, auto slat system, landing gear warning system
3. What is the static source for the standby altimeter?
 - A. Pilot static system
 - B. Copilot static system
 - C. Pilot alternate static system
 - D. Dual isolation system
4. Which altimeter normally provides the signal source for the altitude alerter?
 - A. Pilot altimeter
 - B. Copilot altimeter
 - C. Standby altimeter
 - D. Cabin altimeter
5. What is the normal static source for the pilot air data computer?
 - A. Pilot static system
 - B. Copilot static system
 - C. Pilot alternate static system
 - D. The central air data computer receives no direct static inputs.
6. Which of the following is a condition which may be associated with failure of ADC 1?
 - A. The copilot Mach-air-speed indicator fails.
 - B. The landing gear warning horn sounds.
 - C. The cabin pressurization fails.
 - D. The AUTO SLAT warning light comes on.
7. What action must be taken if inaccurate air-speed, altitude, or vertical velocity indications are noted on the pilot instruments?
 - A. Disengage the autopilot.
 - B. Move the static selector to EMERG.
 - C. Move the pitot-static selector to PANEL ONLY.
 - D. Move the static selector to EMERG and place the pitot-static selector to PANEL ONLY.
8. What additional indication may accompany a malfunction in the copilot pitot-static system?
 - A. Illumination of the AIR DATA light
 - B. Failure of the standby altimeter
 - C. Illumination of the Q UNIT light
 - D. Failure of the temperature indicator
9. What action must be taken if inaccurate air-speed, altitude, or vertical velocity indications are noted on the copilot instruments?
 - A. Disengage the autopilot and yaw dampers.
 - B. Move the static selector to EMERG and follow the air data computer failure procedures.
 - C. Move the pitot-static selector to the PANEL ONLY position and follow the Arthur Q unit inoperative procedures.
 - D. Disregard warnings from the altitude alerter system.

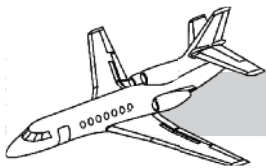

CHAPTER 17

MISCELLANEOUS SYSTEM

CONTENTS

	Page
INTRODUCTION.....	17-1
OXYGEN SYSTEM.....	17-1
General	17-1
Crew System	17-3
Passenger System	17-4
System Operation	17-6
QUESTIONS	17-8

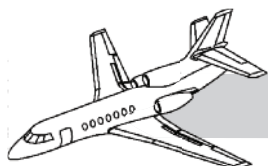

ILLUSTRATIONS

Figure	Title	Page
17-1	Oxygen System.....	17-2
17-2	Crew Oxygen System.....	17-3
17-3	Oxygen Controller and Pressure Gage.....	17-4
17-4	Oxygen System Control, Displays, and Functions.....	17-5
17-5	Passenger/Therapeutic Mask.....	17-5
17-6	Oxygen Cylinder Location and Indicators	17-7

TABLE

Table	Title	Page
17-1	Average Time of Useful Consciousness	17-6

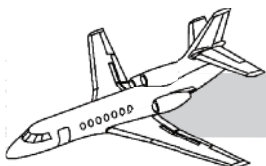

CHAPTER 17

MISCELLANEOUS SYSTEM

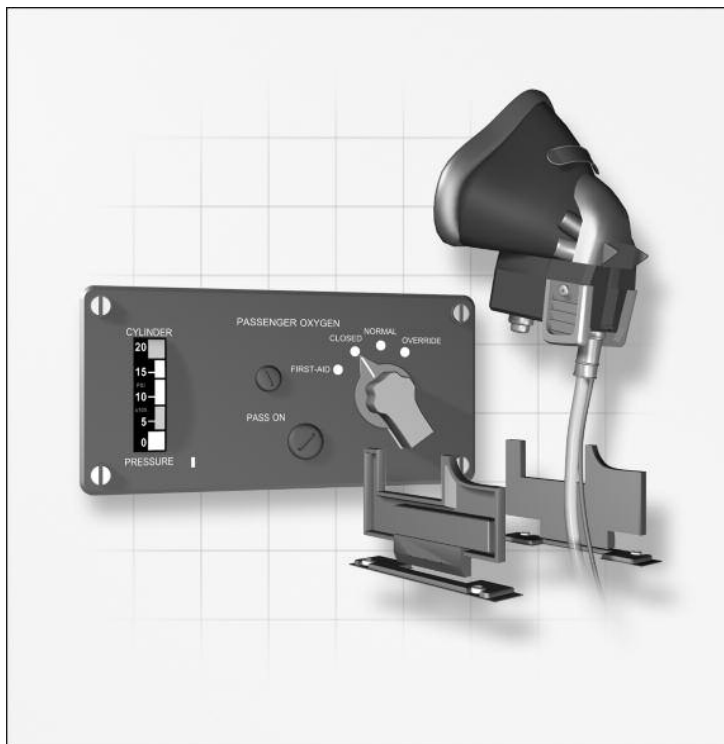

INTRODUCTION

The oxygen system is supplied by a single, high-pressure cylinder. Each crew position has a quick-donning mask with a built-in regulator and microphone. Passenger masks automatically drop out when pressurization is lost. They can receive two different pressures, depending on the altitude and the setting on a controller at the copilot station. Aircraft may be equipped with optional therapeutic outlets.

OXYGEN SYSTEM

GENERAL

The Falcon 50 has a maximum operating altitude of Flight Level 450. Therefore, the proper use of an oxygen system as shown in Figure 17-1 is mandatory. The aircraft contains a single cylinder with a capacity of 76 cu ft (2,150

liters) serviced to a pressure of 1,850 psi (126 bars). The high-pressure system supplies oxygen to both the crew and passenger systems.

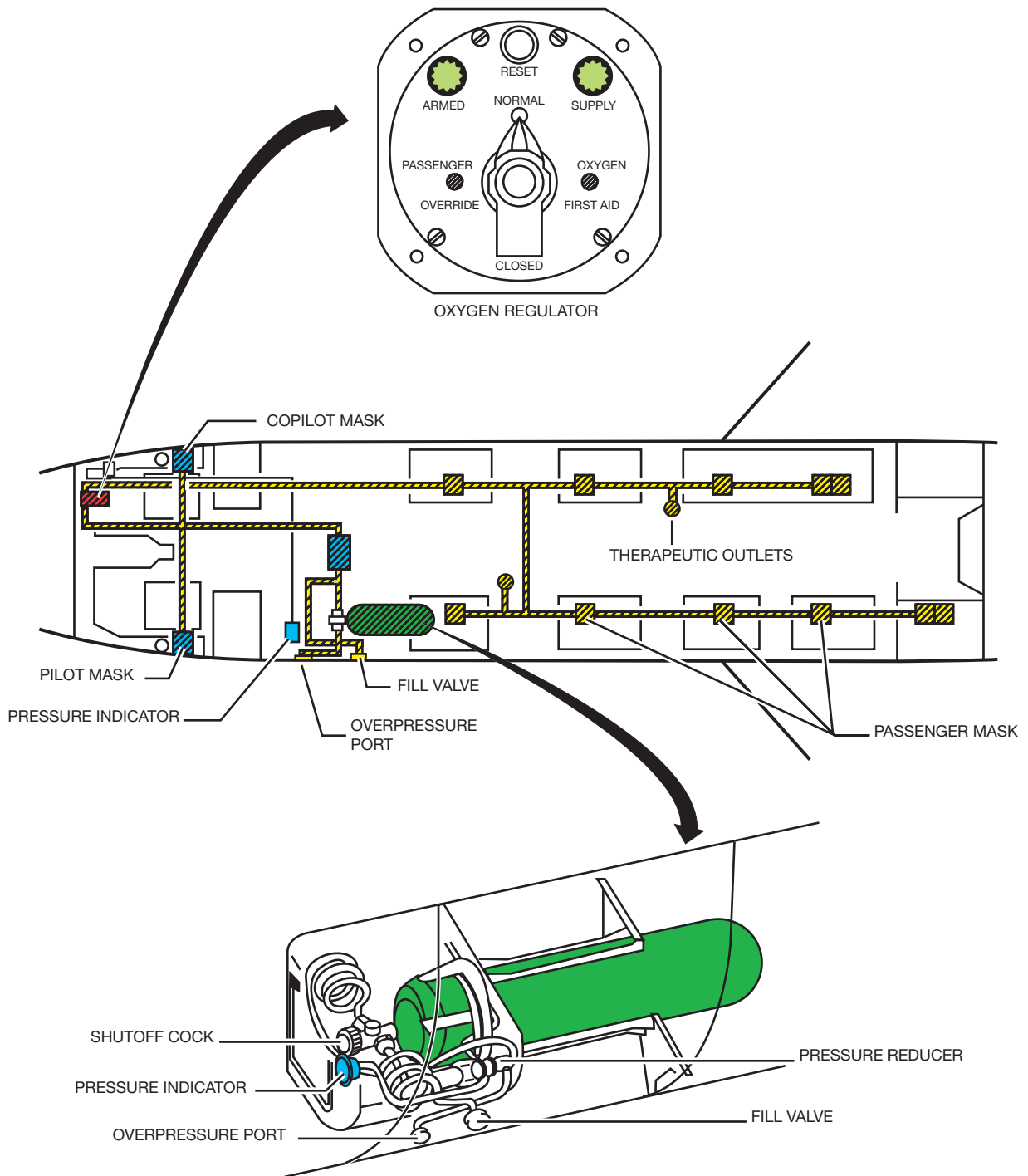
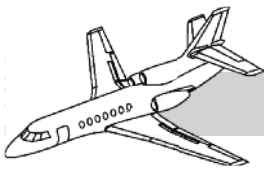
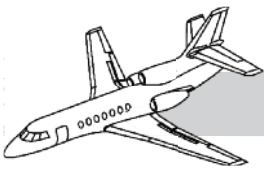

Figure 17-1. Oxygen System



CREW SYSTEM

In the cockpit are two crew masks and storage boxes, a gage showing the oxygen cylinder pressure, and a controller unit for the pressure in the passenger system.

Oxygen Mask Boxes

An oxygen mask box is installed on both the pilot and copilot consoles. When open, the center part of the mask regulator protrudes, enabling the pilot to quick-don the mask. The lower portion of the box also has receptacles for the oxygen hose and the microphone jack.

Crew Masks

The crew masks are classified as quick-donning because they can be put on using one hand in less than 5 seconds (Figure 17-2). Oxygen is supplied at a pressure of 70 psi, and the mask incorporates a flow regulator to supply either a diluted mixture or 100% pure oxygen. At 30,000 feet, the flow regulator automatically delivers 100% oxygen. At 33,000 feet, 100% oxygen is delivered under pressure. The system operates up to 45,000 feet. Built into the mask is an exhalation valve, a strap inflation control, and a test pushbutton. A microphone is also incorporated.

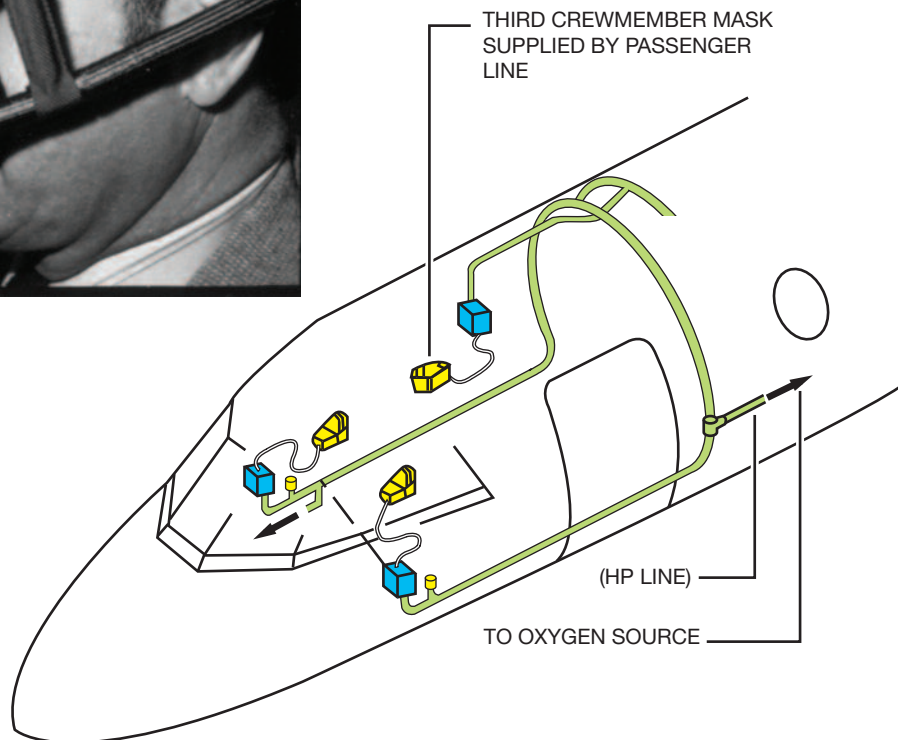
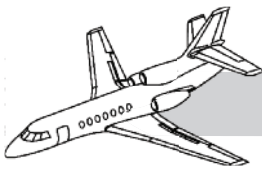

Figure 17-2. Crew Oxygen System



Pressure Gage

A small rectangular pressure gage is situated on the forward section of the copilot side console (Figure 17-3). It has a graduated scale between 0 and 2,000 psi. Below 250 psi, the scale is red, and above 2,000 psi, it is yellow. The red range indicates that the oxygen supply is low and, if oxygen use is required, a descent is necessary.

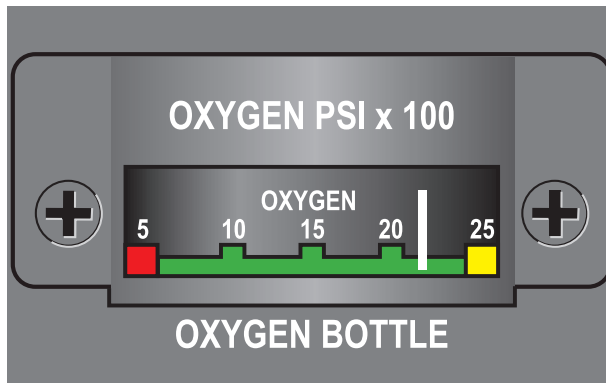

Figure 17-3. Oxygen Controller and Pressure Gage

Oxygen Controller and Pressure Gage

The yellow range indicates that the oxygen level is above the nominal capacity of 1,850 psi at 21° C or 2,000 psi at 48° C.

If there is a reading in the yellow range, the cylinder pressure should be monitored to prevent blowing out the overpressure protection.

PASSENGER SYSTEM

Oxygen Controller

The oxygen controller is located at the forward end of the copilot side console (Figure 17-3). It operates either the passenger masks or the therapeutic masks and is supplied from the regulator at 70 psi.

Between 11,500 and 18,250 ($\pm 1,000$) feet, the controller allows oxygen to be supplied at a pressure of 28 psi. At higher altitudes, over 18,250 feet, a pressure of 70 psi is supplied. Between the altitude of 11,500 and 18,250 feet, initial pressure is 70 psi for 10 seconds in order to release the masks, then it is automatically reduced to 28 psi.

The oxygen regulator has two indicators, a reset button, and a four-position control knob.

The ARMED indicator appears white when the control system is supplied.

The SUPPLY indicator is white when passenger oxygen is supplied.

The RESET button is pushed to desupply the control system.

There are four switch positions on the panel.

1. NORMAL

- The regulator is ready to operate-the control and distribution lines are not pressurized.
- During depressurization, the masks are deployed at 10,500 feet or 11,500 feet and oxygen is supplied at the proper pressure for altitude. The ARMED indicator is white; the SUPPLY indicator is partly white for low altitude and fully white for high altitude.

2. FIRST AID

- This switch position supplies 28 psi for connecting first aid masks to a plug not on the mask box.
- The ARMED indicator is not white, but the SUPPLY indicator is white.
- Automatic operation is the same as for normal operation.

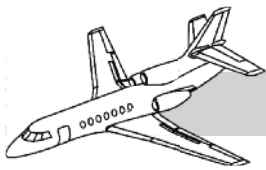

3. OVERRIDE

- The override position is used if the automatic system fails. It supplies only 70 psi of pressure. If 28 psi is necessary, switch to FIRST AID.
- Both indicators are white.

4. CLOSED

- This position is used if the passenger system is not to be supplied.
- The ARMED indicator is white.

The system can be switched off by moving the control selector to CLOSED as soon as cabin altitude is below 10,000 feet.

CAUTION

Do not press the RESET button when the system is functioning since bleeding the control chamber immediately stops the oxygen flow.

Figure 17-4 illustrates control positions, indications and functions.

Therapeutic Masks (Optional)

Therapeutic masks are an optional installation. If installed, they are like the passenger masks, as seen in Figure 17-5. When a passenger mask

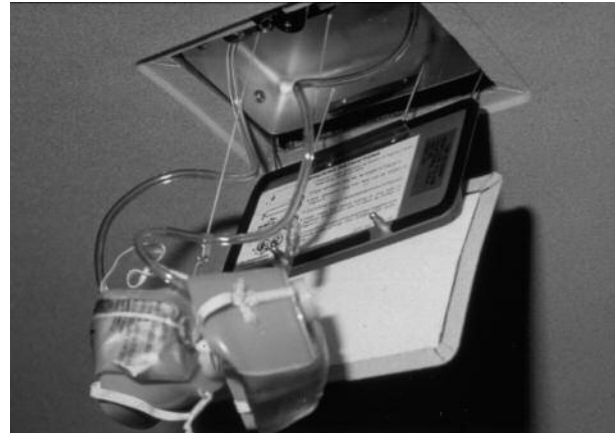

Figure 17-5. Passenger/Therapeutic Mask



CONTROL	DISPLAY	FUNCTIONS
<p>NORMAL</p>  <p>CLOSED</p>	<p>OCCLUDED</p> <p>ARMED SUPPLY</p> <p>ARMED SUPPLY</p> <p>OPENED</p>	<p>Normal flight—the regulator is ready to operate (control and distribution lines are not pressurized).</p> <p>Cabin depressurization—automatic opening of mask boxes.</p> <ul style="list-style-type: none"> • High cabin altitude—18,250 ft at 70 psi • Low cabin altitude—18,250 ft at 28 psi
 <p>FIRST AID</p>	<p>ARMED SUPPLY</p> <p>ARMED SUPPLY</p>	<p>Pressurization at 28 psi for connection of first aid mask to plug isolated from the mask boxes. This position does not disable automatic operation which is in standby (NORMAL).</p> <p>Cabin depressurization—automatic function is the same as for knob in NORMAL position.</p>
 <p>OVERRIDE</p>	<p>ARMED SUPPLY</p> <p>ARMED SUPPLY</p>	<p>Cabin depressurization—emergency manual control for supplying the mask boxes at 70 psi if automatic system fails. Switch to FIRST AID for 28 psi supply.</p>
 <p>CLOSED</p>	<p>ARMED SUPPLY</p> <p>ARMED SUPPLY</p>	<p>Either during shutdown of the passenger system if altitude is less than 10,000 ft.</p> <p>Or in a flight configuration when, for safety reasons, all oxygen must be spared for the crew.</p> <p>Following operation at 70 psi (following depressurization), the control knob must be reset to NORMAL and rearmed with the RESET pushbutton in order to be operational.</p>

Figure 17-4. Oxygen Cylinder Location and Indicators

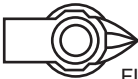
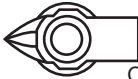

is deployed, the supply valve is closed until the mask is pulled, opening the valve. Flow to the passenger and/or therapeutic masks can be adjusted between 2 and 4 liters per minute.

SYSTEM OPERATION

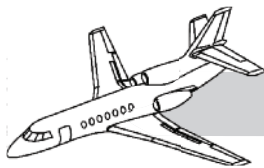
Filling the oxygen cylinder (Figure 17-6) through the servicing port is not authorized when passengers are aboard the aircraft.

Follow safety precautions commensurate with handling of high-pressure oxygen equipment. The isolation valve end and the ground cart valve must be moved slowly.

The aircraft flight determines the minimum pressure of the oxygen cylinder pressure. When checking the filling pressure on the pressure gage for the three flight described below, consider the temperature correction factors which are posted on the cylinder access door.

Minimum Oxygen Requirements

1. Flight without passengers-altitude below 10,000 feet.

A flight, without passengers, to be flown below 10,000 feet, has a minimum pressure of 650 psi in the oxygen cylinder, and at least 300 liters per crewmember. Takeoff is not authorized with a lower minimum amount.

2. Flight with two crewmembers, ten passengers-altitude not to exceed 41,000 feet.

When carrying ten passengers at an altitude not exceeding 41,000 feet, the cylinder carries a minimum pressure of 700 psi. That is sufficient to allow for an emergency descent from 41,000 feet down to 10,000 feet with all occupants using oxygen.

3. Flight above 41,000 feet.

When the flight is scheduled to go above 41,000 feet, the system is pressurized to 1,150 psi, regardless of the number of passengers. That allows for an emergency descent from 45,000 feet to 14,000 feet with all occupants using oxygen. It is also sufficient for 60 minutes at 14,000 feet with both crewmembers and one passenger using oxygen.

NOTE

Table 17-1 sets forth the average time of useful consciousness (time from onset of hypoxia until loss of effective performance) at various altitudes.

Table 17-1. AVERAGE TIME OF USEFUL CONSCIOUSNESS

Altitude	Average Time
45,000 feet	9 to 15 seconds
40,000 feet	15 to 20 seconds
35,000 feet	1/2 to 1 minute
30,000 feet	1 to 2 minutes
28,000 feet	2 1/2 to 3 minutes
25,000 feet	3 to 5 minutes
22,000 feet	5 to 10 minutes
12,000 feet to 18,000 feet.....	30 minutes or more

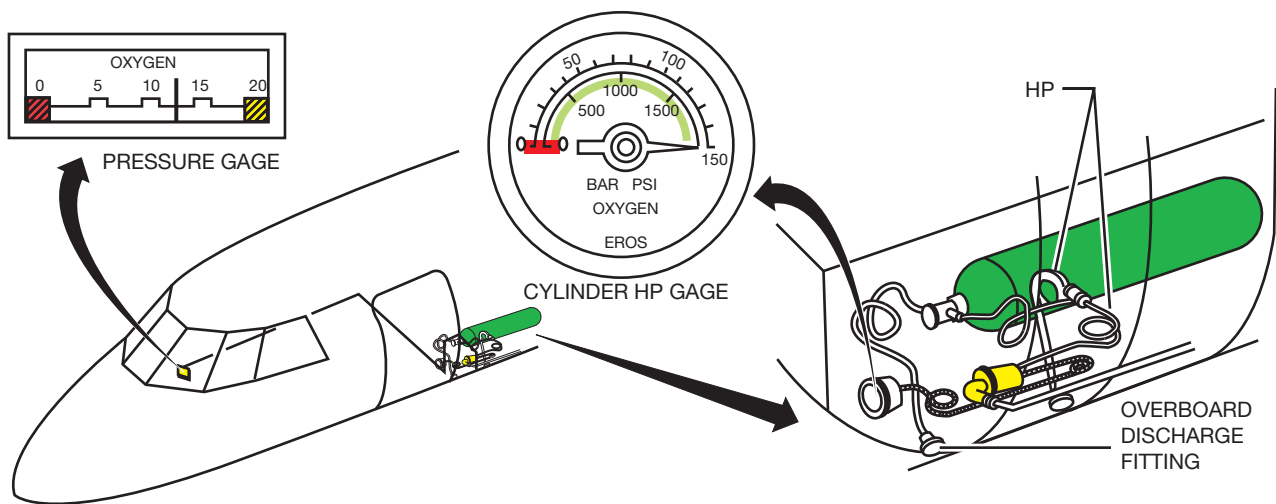
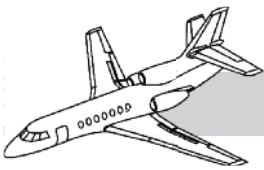
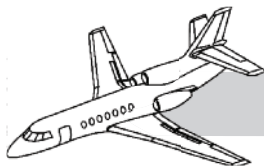
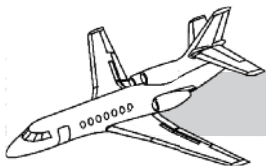

Figure 17-6. Oxygen Cylinder Location and Indicators



QUESTIONS

1. What does the oxygen controller operate?
 - A. Only the crew oxygen supply
 - B. Only the passenger and therapeutic masks, and at two different pressures
 - C. All oxygen masks are supplied by the controller.
 - D. Only the passenger masks at a constant pressure
2. SITUATION—THE AIRCRAFT IS AT 15,000 FEET. OXYGEN CONTROLLER IS SET TO NORMAL. RAPID DECOMPRESSION OCCURS.
 - A. The RESET button must be pushed before the masks will deploy.
 - B. The oxygen masks will deploy and the pressure will be a constant 70 psi.
 - C. The masks will not deploy below 18,000 feet.
 - D. An initial pressure of 70 psi will cause the masks to deploy and then oxygen will be supplied at 28 psi.
3. If, after the situation in Question No. 2, the oxygen system did not respond properly, what is the next action?
 - A. Select OVERRIDE. The masks will deploy and deliver 70 psi. Switching to FIRST AID will then deliver 28 psi.
 - B. Select CLOSED. The passenger system will not work, so conserve oxygen for crew use.
 - C. Select CLOSED, press the RESET button, and reposition the selector to NORMAL.
 - D. Since the proper response should have been no mask deployment, the masks must have deployed. Select CLOSED to conserve the oxygen supply.



WALKAROUND

The following section is a pictorial walkaround. It shows each item called out in the exterior power-off preflight inspection. The fold-out pages at the beginning and the end of the walkaround section should be unfolded before starting to read.

The general location photographs do not specify every checklist item. However, each item is portrayed on the large-scale photographs that follow.

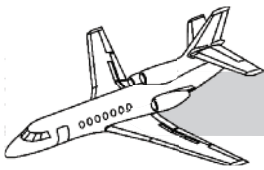

FALCON 50 PILOT TRAINING MANUAL

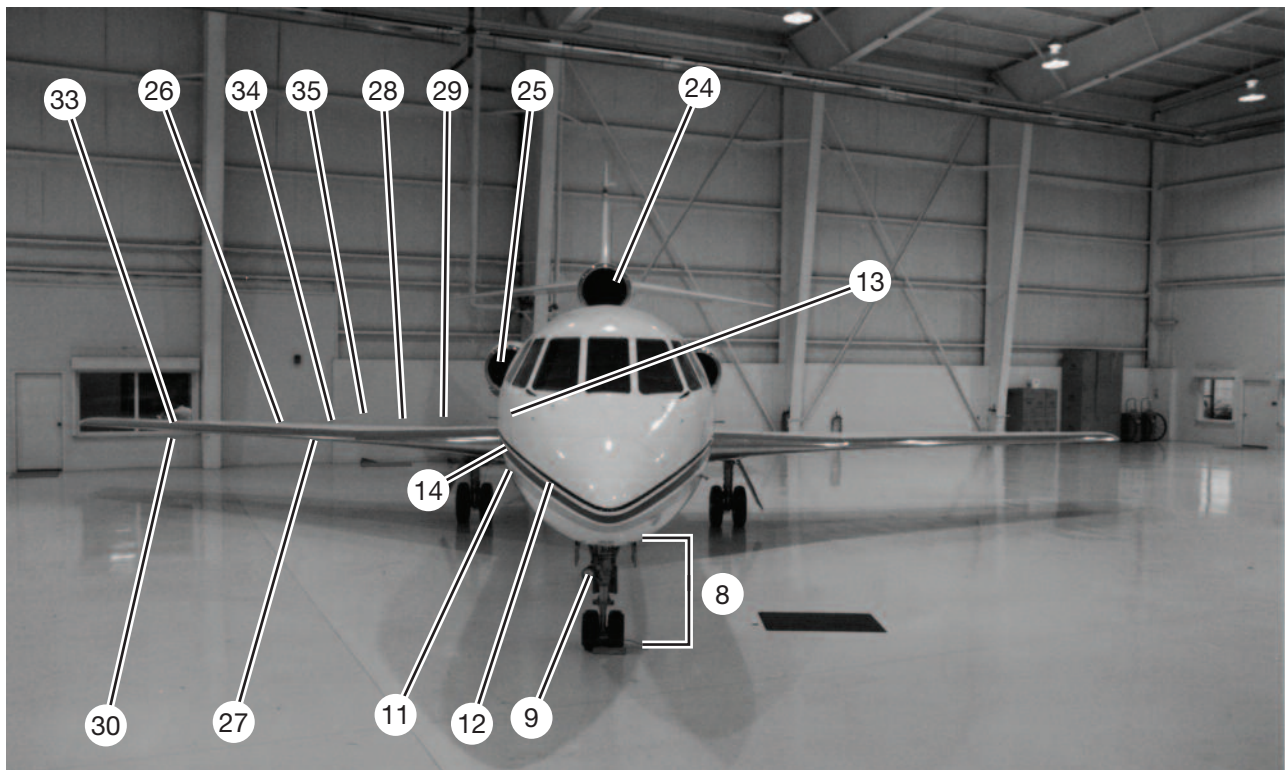
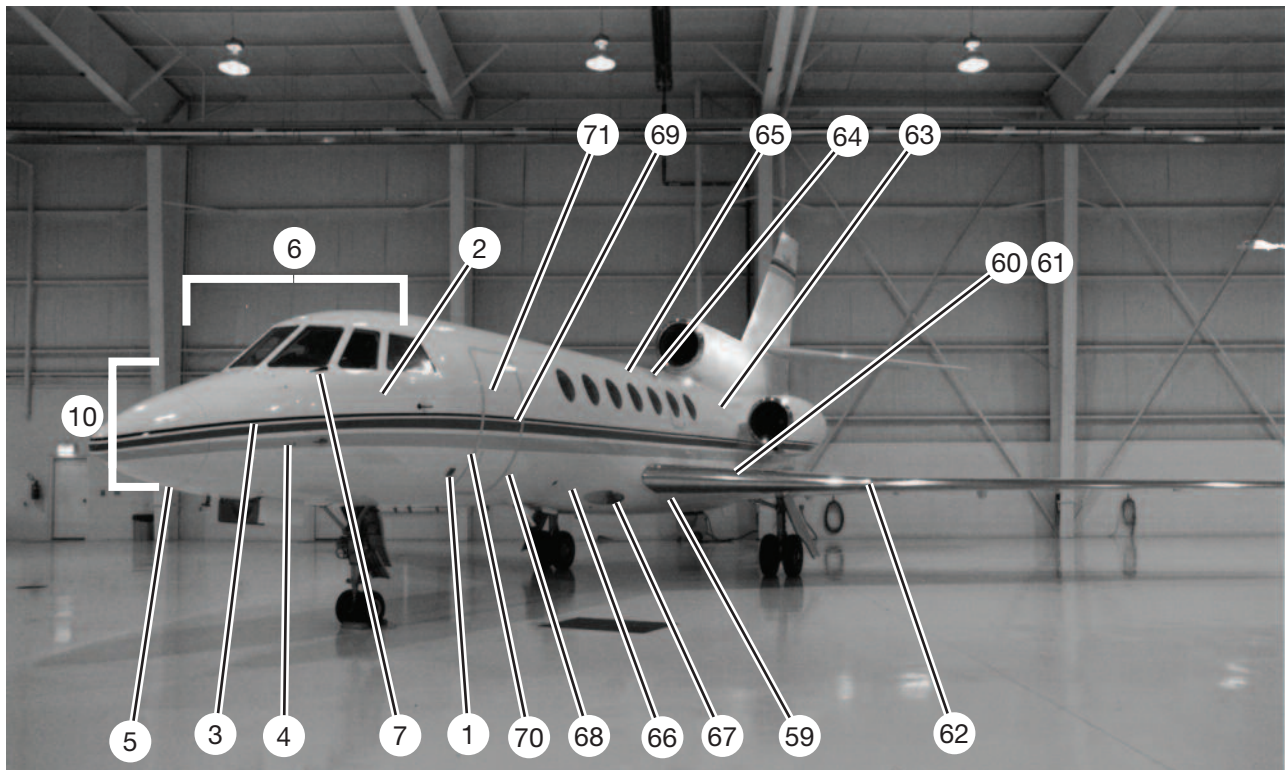

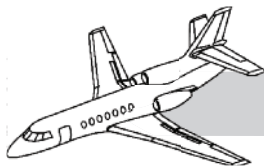

WALKAROUND INSPECTION



1. NORMAL STATIC PORTS COVER/CONDITION
—REMOVE/CLEAR

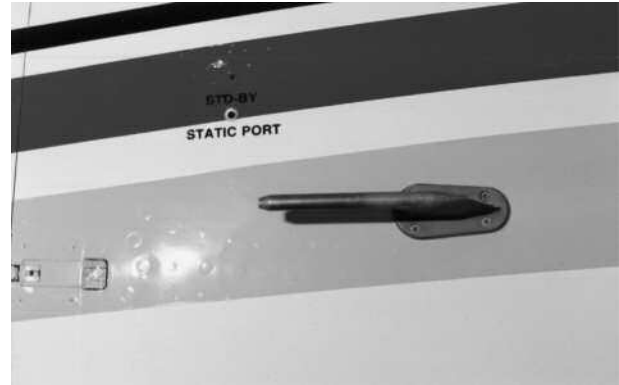

4. PILOT PITOT PROBE COVER/CONDITION
—REMOVE CHECK



2. STALL WARNING SENSOR COVER/CONDITION
—REMOVE/CHECK

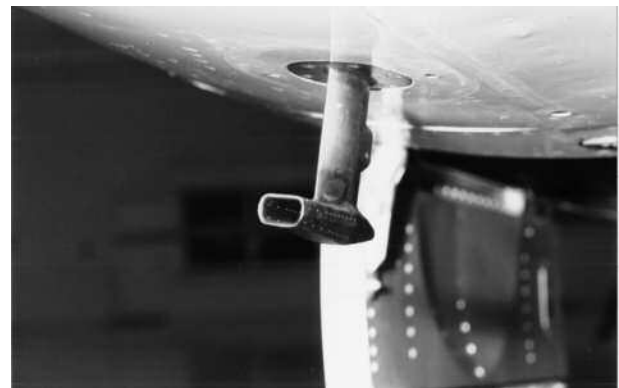

5. NORMAL STATIC PORTS COVER/CONDITION
—REMOVE CHECK

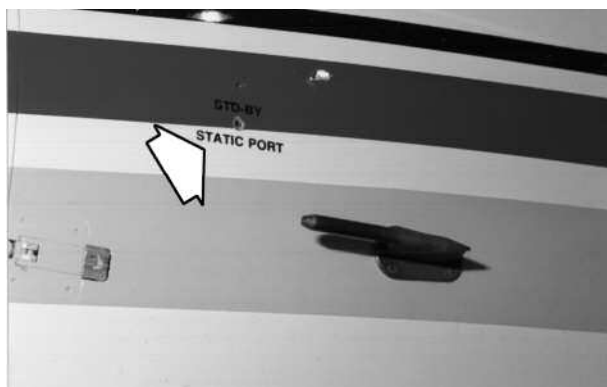

3. EMERGENCY STATIC PORTS COVER/CONDITION
—REMOVE/CLEAR



6. COCKPIT WINDOWS —CHECK/CLEAR
7. WINDSHIELD WIPERS—CHECK/STOWED

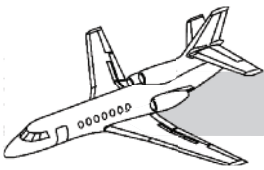

FALCON 50 PILOT TRAINING MANUAL



8. NOSE LANDING GEAR—CHECK



9. TAXI LIGHT—CHECK

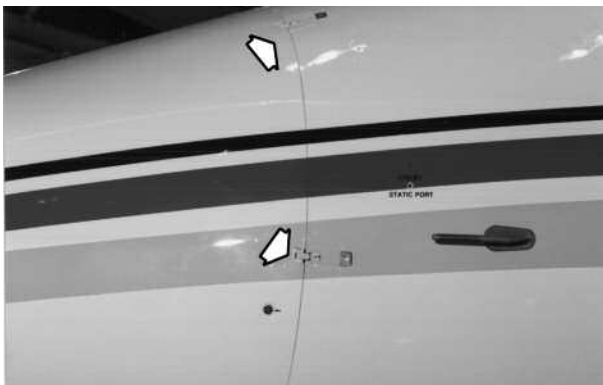

10. 8 NOSE CONE LATCHES—CHECK



- 11. COPILOT PITOT PROBE COVER/CONDITION
—REMOVE/CHECK
- 12. EMERGENCY STATIC PORTS COVER/CONDITION
—REMOVE/CLEAR



- 13. STALL WARNING SENSOR COVER/CONDITION
—REMOVE/CHECK



- 14. NORMAL STATIC PORTS COVER/CONDITION
—REMOVE/CLEAR

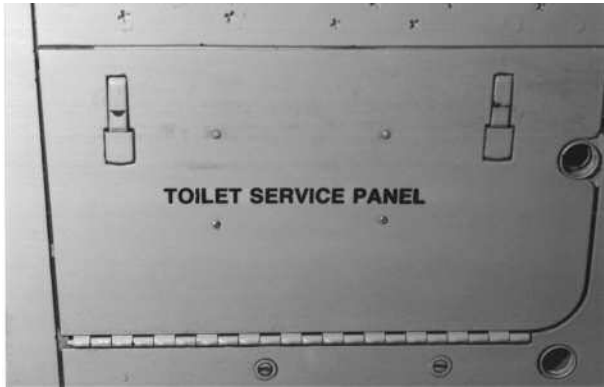
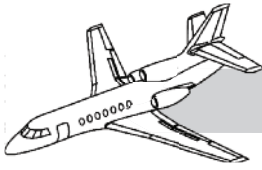

15. WASTE WATER DRAIN ACCESS DOOR
—CHECK/CLOSE

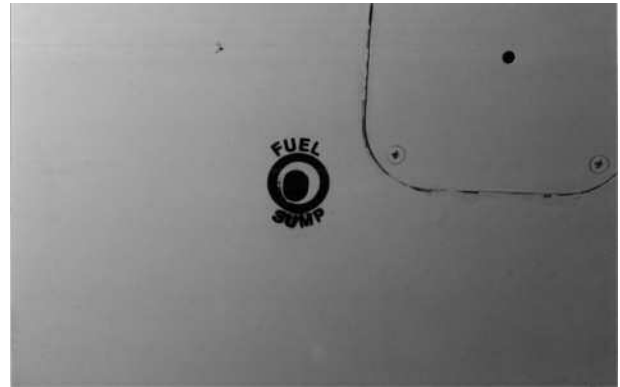

18. FUEL SUMP DRAINS—CHECK FOR LEAKS



16. ANGLE OF ATTACK TRANSMITTER
COVER/CONDITION—REMOVE/CHECK

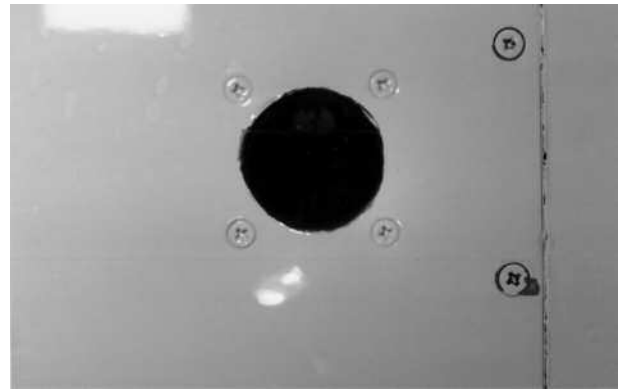

19. PARKING BRAKE ACCUMULATOR—CHECK



17. BELLY ANTI-COLLISION LIGHT—CHECK

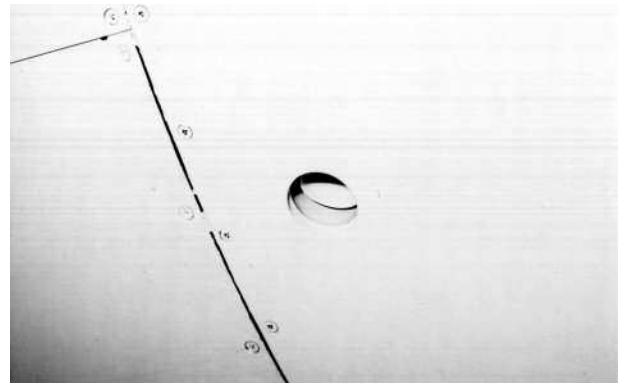

20. RIGHT WING VENT VALVE —CLEAR/NO LEAKS

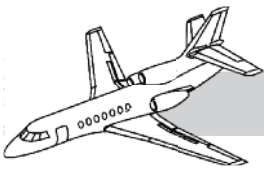

21. ANTENNAS—CHECK



24. CENTER ENGINE AIR INTAKE COVER/CONDITION
—REMOVE/CHECK



22. RH LANDING LIGHT—CHECK



25. RIGHT ENGINE AIR INTAKE COVER/CONDITION
—REMOVE/CHECK



23. RH EMERGENCY EXIT—CHECK



26. LEADING EDGE CONDITION —CHECK

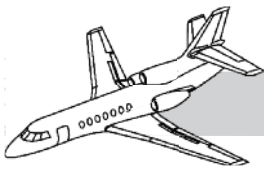

FALCON 50 PILOT TRAINING MANUAL



27. EMERGENCY EXIT LIGHT LEADING EDGE
CONDITION—CHECK

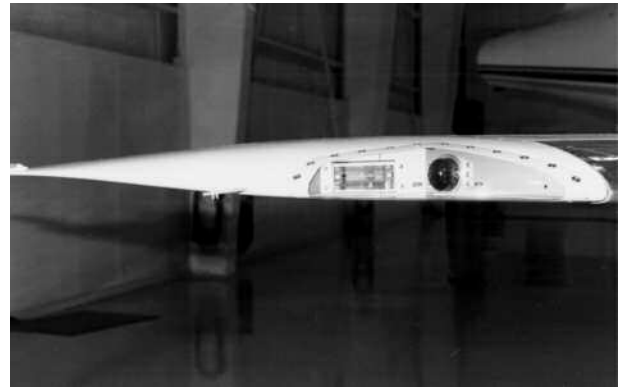

31. NAVIGATION/STROBE LIGHTS—CHECK

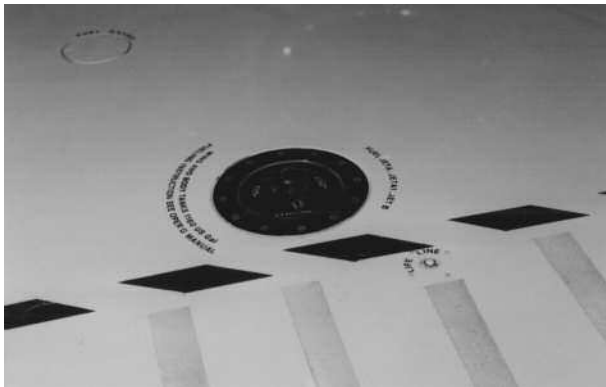

28. LIFE LINE PIN ATTACHMENT—CHECK
29. GRAVITY FUELING PLUG—CHECK



32. STATIC DISCHARGE—CHECK



30. WING CHECK FOR FUEL LEAKS—CHECK

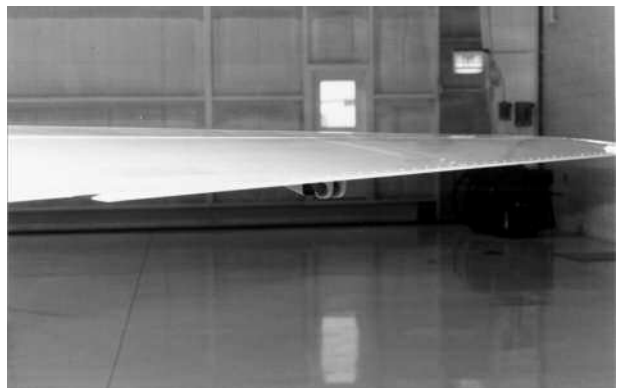

33. RIGHT AILERON —CHECK

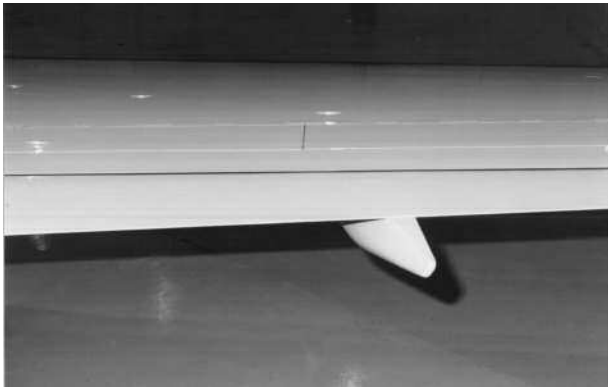
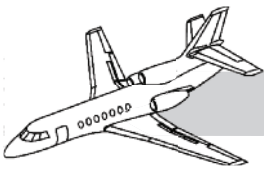

34. FLAPS—CHECK



37a. RIGHT ENGINE NACELLE AND PYLON—CHECK



35. AIRBRAKES—CHECK

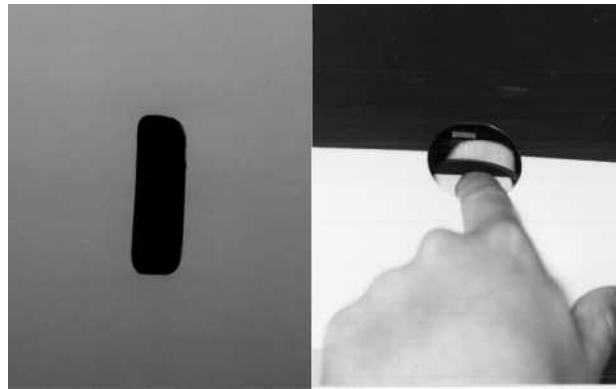

37b. RIGHT ENGINE OIL LEVEL AND FILTER PLUG—CHECK



36. RIGHT MAIN LANDING GEAR—CHECK

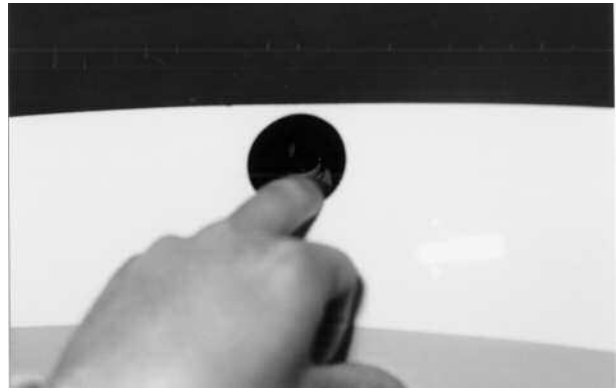

37c. RIGHT ENGINE FUEL FILTER PLUG—CHECK

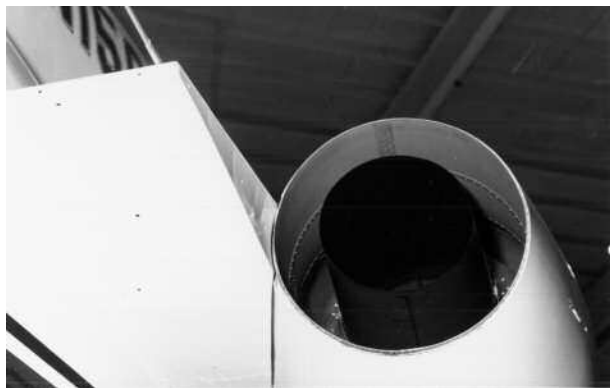
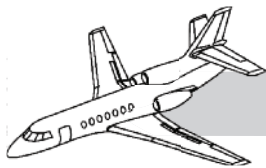

37d. RIGHT ENGINE TAIL CONE CONDITION—CHECK

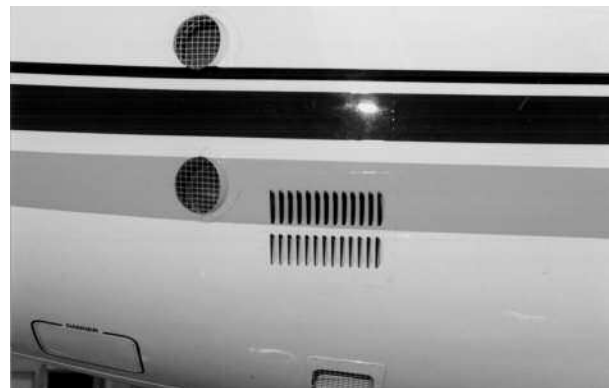

41. CREW/CABIN ECU INTAKES/EXITS—CHECK



38. SINGLE POINT REFUELING PANEL—CHECK



42. APU AIR INTAKE EXHAUST—CHECK

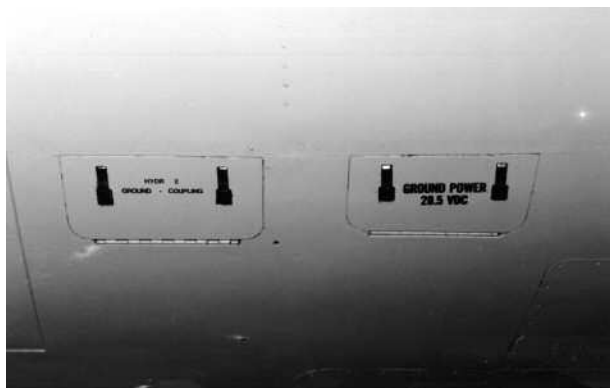

- 39. EXTERNAL POWER CONNECTOR ACCESS DOOR
—CLOSED/LATCHED (2)
- 40. HYDRAULIC 2 GROUND CONNECTION PANEL
—CLOSED/LATCHED (2)



43. AFT NAVIGATION LIGHT—CHECK

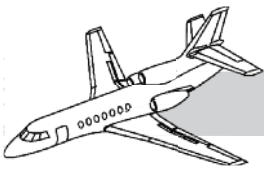

FALCON 50 PILOT TRAINING MANUAL



- 44a. CENTER ENGINE NACELLE AND EXHAUST—CHECK
- 44b. CENTER ENGINE COWLS—LOCKED



- 44e. CENTER ENGINE FUEL FILTER PLUG—CHECK



- 44c. CENTER ENGINE OIL LEVEL—CHECK

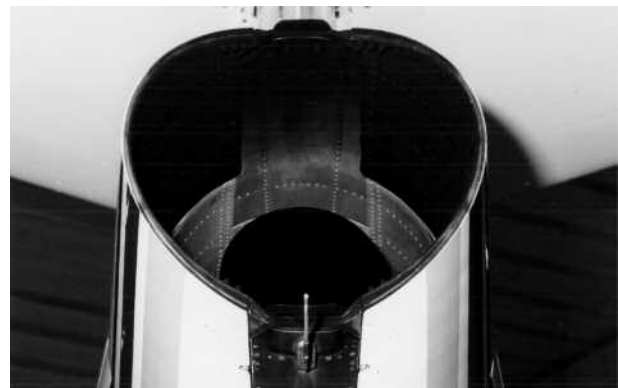

- 44f. THRUST REVERSER AND TAIL CONE—CHECK



- 44d. CENTER ENGINE OIL FILTER PLUG—CHECK



- 45a. HORIZONTAL STABILIZER—CHECK

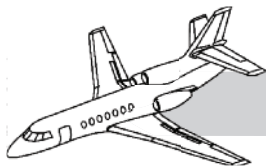

FALCON 50 PILOT TRAINING MANUAL



- 45b. HORIZONTAL STABILIZER—CHECK
- 46. VERTICAL FIN—CHECK

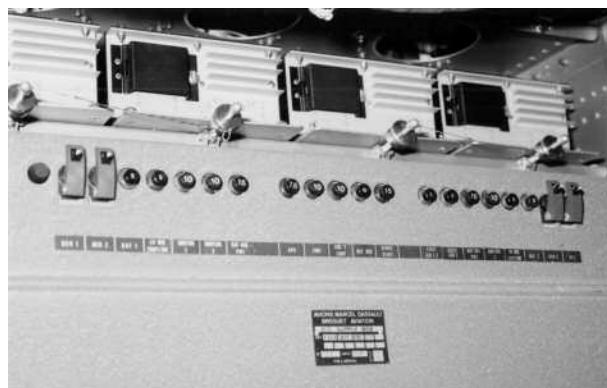

- 48b. REAR COMPARTMENT ELECTRICAL PANEL
—CHECK



- 47. APU/NO. 2 ENGINE VENT PORTS—CHECK



- 48c. REAR COMPARTMENT BATTERIES CONNECTED
—CHECK



- 48a. REAR COMPARTMENT—CHECK



- 48d. REAR COMPARTMENT HYDRAULIC RESERVOIRS
—CHECK

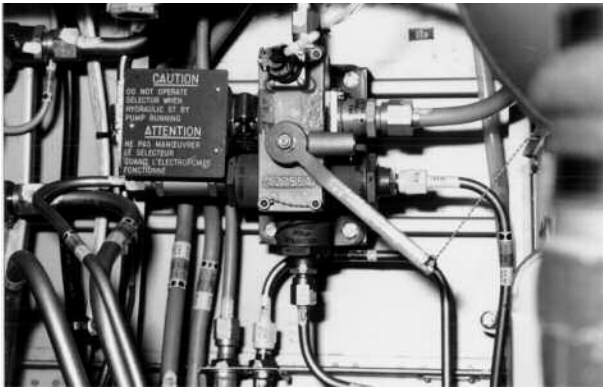
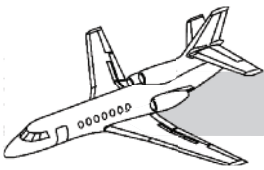

48e. REAR COMPARTMENT STANDBY PUMP SET TO "IN FLIGHT"—CHECK



48h. REAR COMPARTMENT DOOR CLOSED AND LATCHED—CHECK



48f. REAR COMPARTMENT ENGINE FIRE EXTINGUISHER—CHECK



49. FIRE EXTINGUISHER FRANGIBLE DISCS—CHECK



48g. REAR COMPARTMENT "S" DUCT DOOR CLOSED AND LATCHED—CHECK



50a. BAGGAGE COMPARTMENT AND WEIGHT PLACARD—CHECK

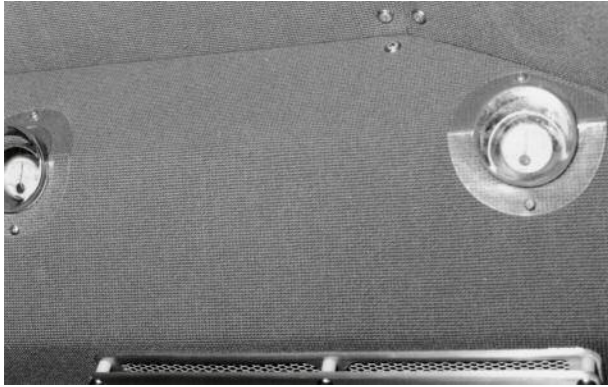
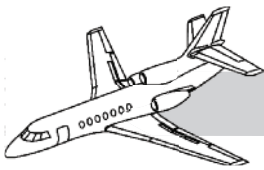

50b. BAGGAGE COMPARTMENT FIRE BOTTLE CHARGE—CHECK



52a. LEFT ENGINE NACELLE AND PYLON—CHECK
See Right Engine Nacelle and Pylon for checks



50c. BAGGAGE COMPARTMENT DOOR CLOSED AND LATCHED—CHECK



52b. LEFT ENGINE OIL LEVEL—CHECK

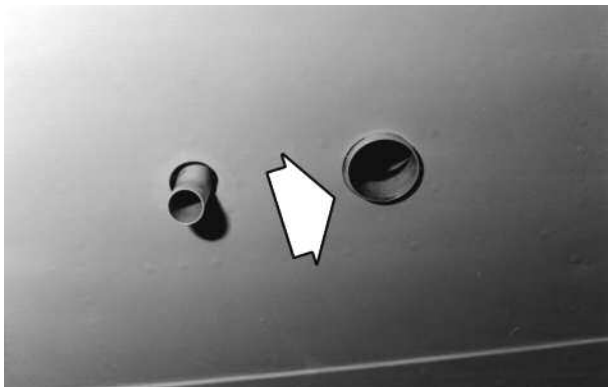

51. FEEDER TANK VENT VALVE
—CLEARED/NO LEAKS



52c. LEFT ENGINE FILTER PLUG—CHECK

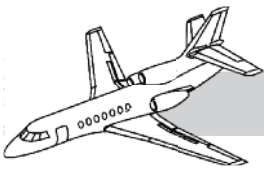

FALCON 50 PILOT TRAINING MANUAL

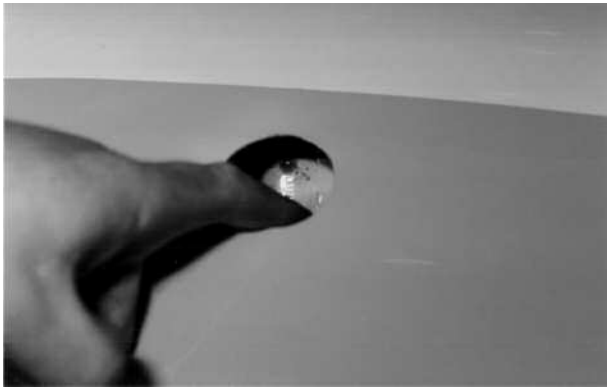

52d. LEFT ENGINE FUEL FILTER PLUG—CHECK

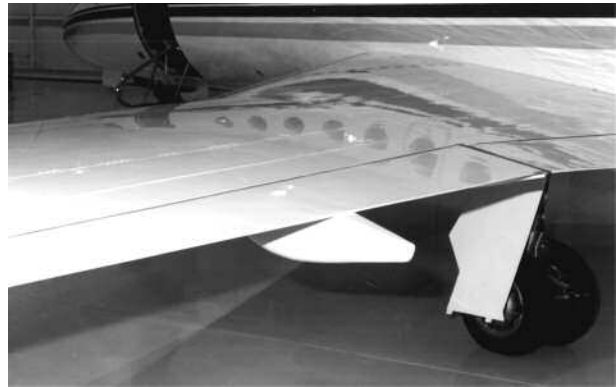

54. AIRBRAKES—CHECK
55. FLAPS—CHECK



52e. LEFT ENGINE TAIL CONE CONDITION—CHECK



56. LEFTAILERON—CHECK

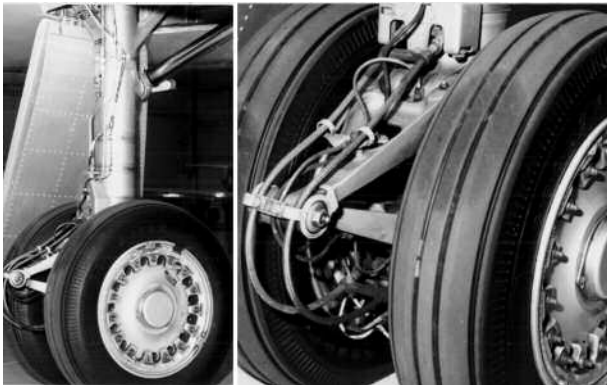

53. LEFT MAIN LANDING GEAR—CHECK
See Right Main Landing Gear for checks



57. STATIC DISCHARGERS—CHECK

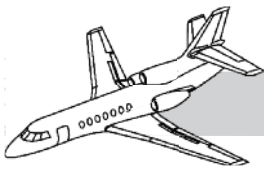

FALCON 50 PILOT TRAINING MANUAL

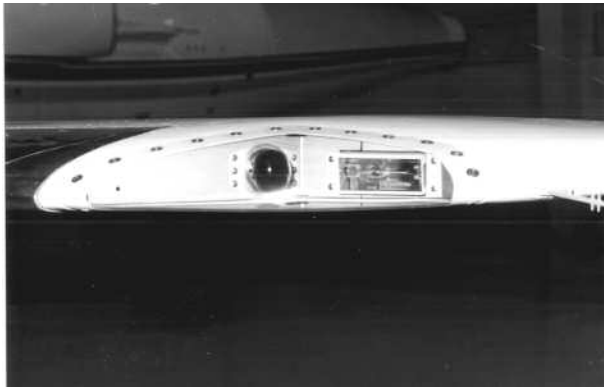

58. NAVIGATION/STROBE LIGHTS—CHECK



62. LEADING EDGE CONDITION—CHECK



59. WING CHECK FOR FUEL LEAKS—CHECK



63. LEFT ENGINE AIR INTAKE
COVER/CONDITION—REMOVE/CHECK

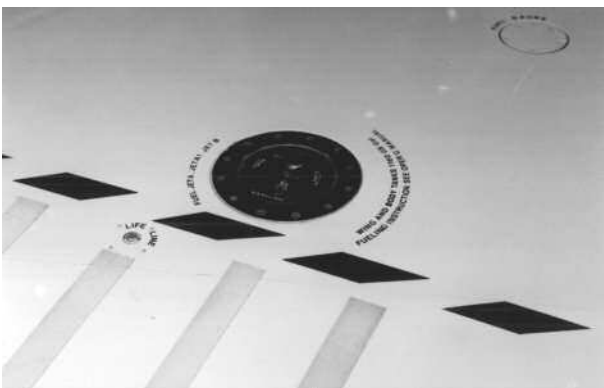

60. GRAVITY FUELING PLUG—CHECK
61. LIFE LINE PIP PIN ATTACHMENT—CHECK

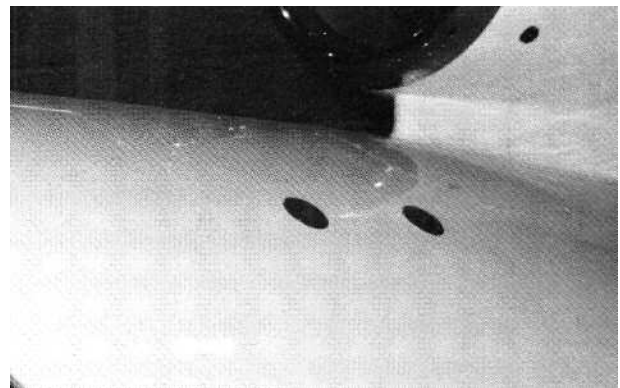

64. LADDER ATTACHMENT
HOLES (2)—CHECK/COVERS IN PLACE

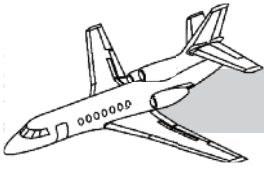

65. LH EMERGENCY EXIT—CHECK

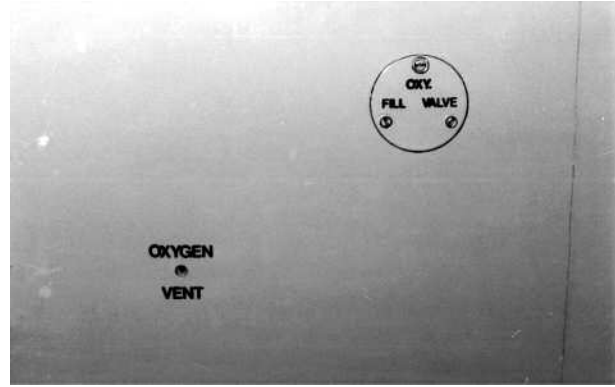

68. OXYGEN SYSTEM FILLER AND VENT—CHECK/CLEAR

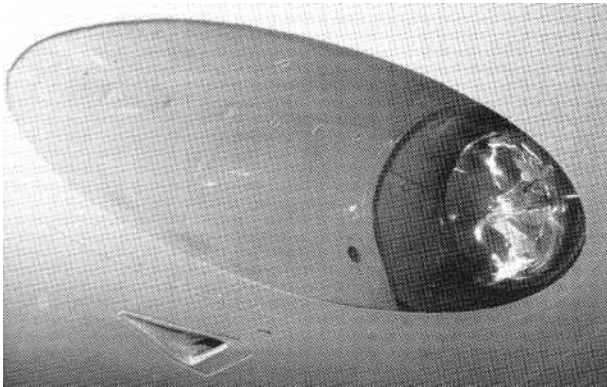

66. LH LANDING LIGHT—CHECK



69. OXYGEN VALVE AND PRESSURE—OPEN/CHECK

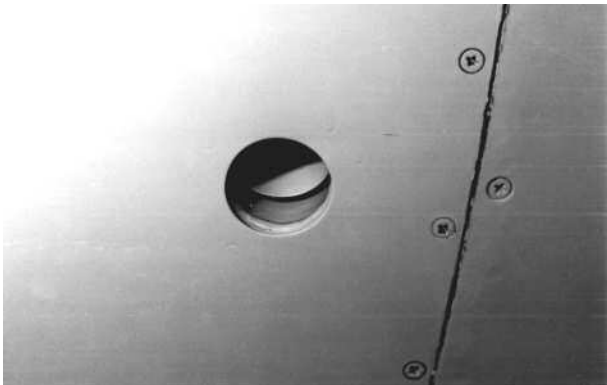

67. LEFT WING VENT VALVE—CHECK/NO LEAKS



70. MAIN CABIN DOOR SEAL—CHECK

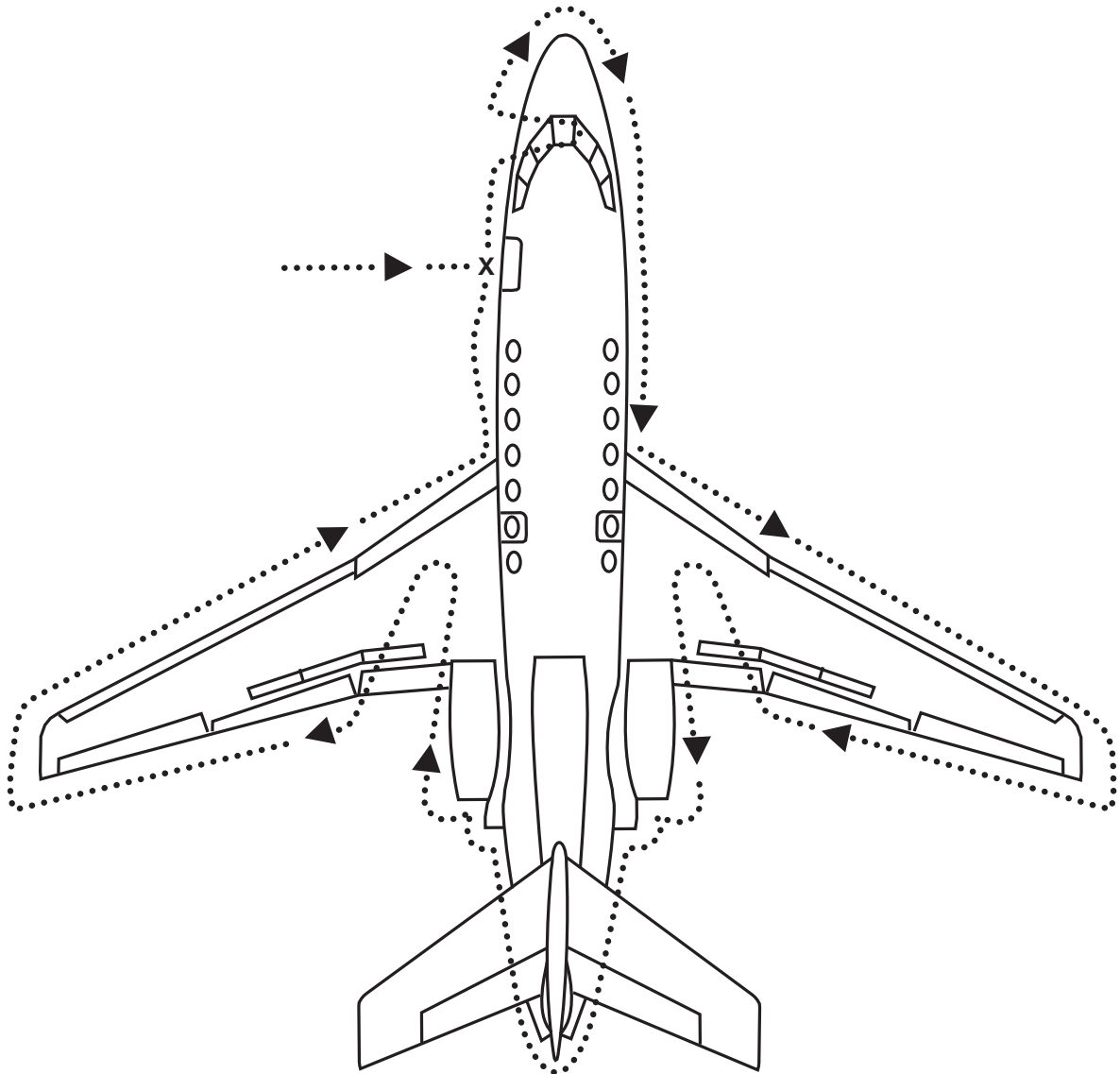
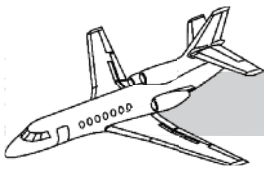

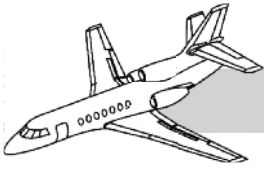

71a. MAIN CABIN DOOR—CHECK

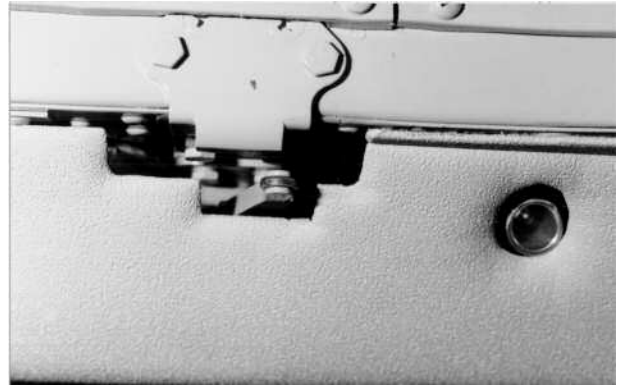

71c. MAIN CABIN DOOR—CHECK (CONT)



71b. MAIN CABIN DOOR—CHECK (CONT)



71d. MAIN CABIN DOOR—CHECK (CONT)

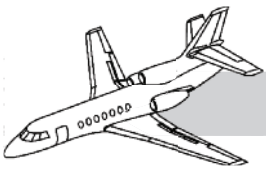

FALCON 50 PILOT TRAINING MANUAL

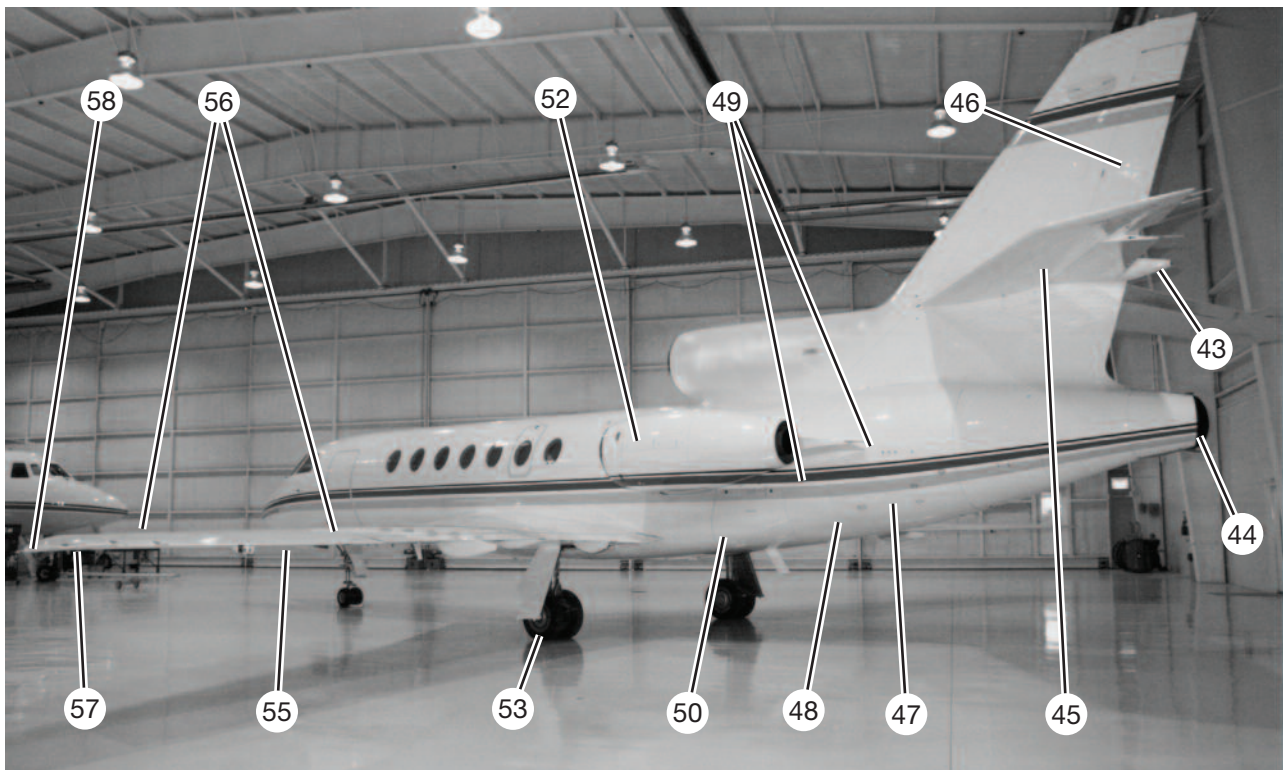
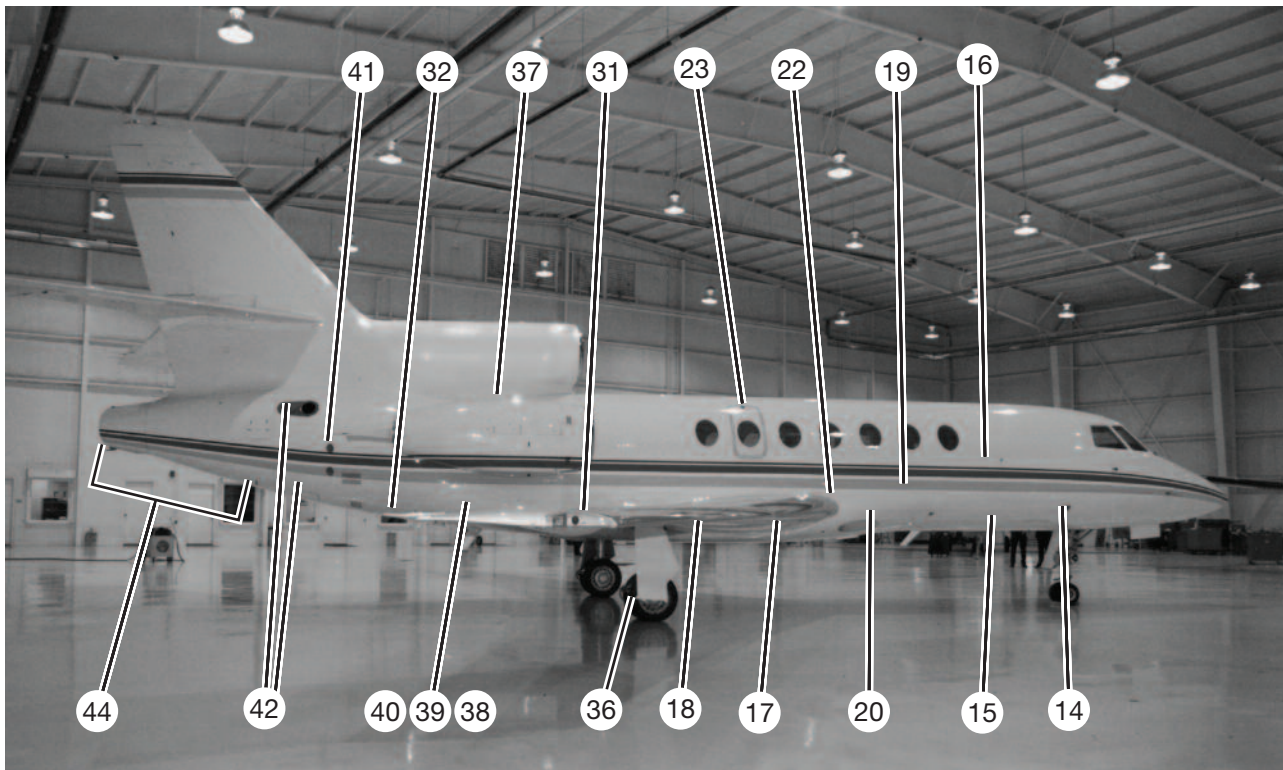

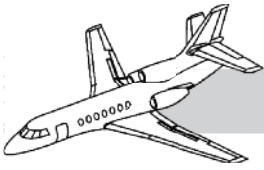

ANSWERS TO QUESTIONS

Chapter 2

1. C
2. C
3. B
4. B
5. C
6. D
7. B
8. D
9. B
10. D
11. A
12. D
13. C
14. B
15. C
16. D
17. D
18. B
19. B
20. D
21. B
22. C
23. C
24. C
25. D

Chapter 3

1. C
2. B
3. B
4. A
5. D
6. C
7. C
8. C

9. A
10. B
11. D
12. C
13. B
14. C

Chapter 4

1. B
2. A
3. A
4. D
5. B

Chapter 5

1. B
2. D
3. A
4. A
5. B
6. A
7. C

Chapter 6

1. D
2. B
3. D
4. A
5. B
6. D
7. C
8. C
9. C

Chapter 7

1. C
2. A

3. B
4. C
5. D
6. A
7. D
8. B
9. C
10. A

Chapter 8

1. C
2. A
3. B
4. D
5. B
6. C

Chapter 9

1. C
2. A
3. D
4. A
5. D
6. B
7. B
8. D

Chapter 10

1. D
2. C
3. C
4. B
5. C
6. D
7. C
8. A
9. B

Chapter 11

1. C

2. D
3. A
4. C
5. B

Chapter 12

1. C
2. B
3. A
4. D

Chapter 13

1. C
2. C
3. B
4. D
5. B

Chapter 14

1. C
2. A
3. C
4. C
5. A
6. B
7. A

Chapter 15

1. A
2. C
3. D
4. B
5. C

Chapter 16

1. C
2. B
3. A
4. A
5. A

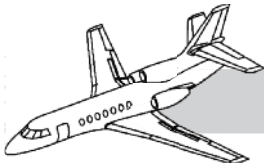

- 6. D
- 7. B
- 8. C
- 9. C

Chapter 17

- 1. B
- 2. D
- 3. A

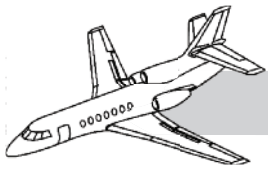

ANNUNCIATORS SECTION

The Annunciators Section presents a color representation of all the annunciator lights in the aircraft.

Please unfold page ANN-3 to the right and leave it open for ready reference as the annunciators are cited in the text.

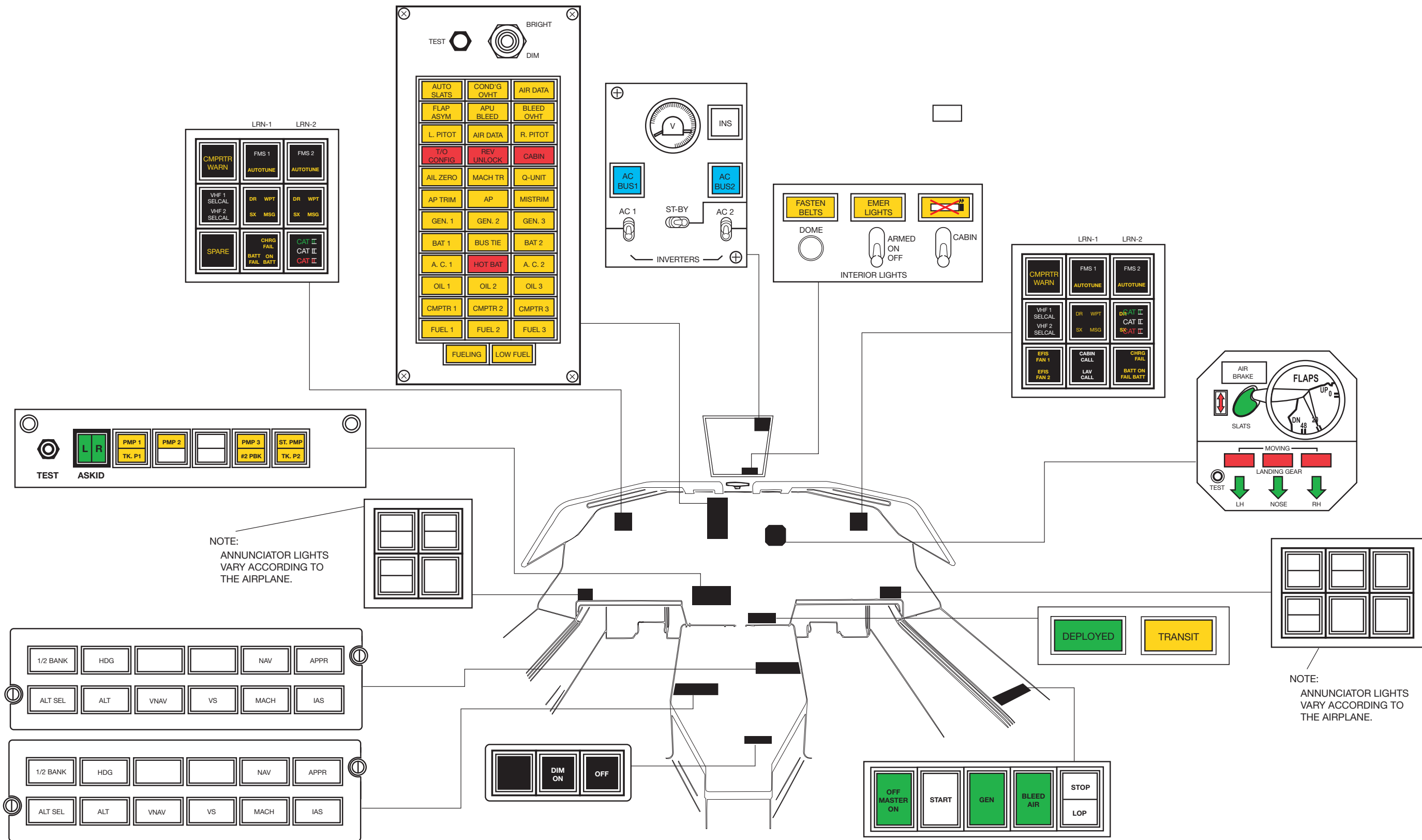
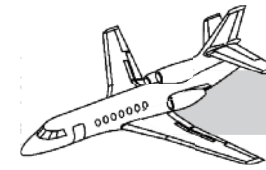
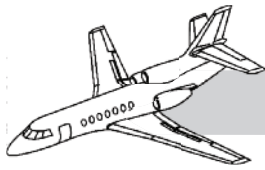

NOTE: ANNUNCIATOR LIGHTS VARY ACCORDING TO THE AIRPLANE.

NOTE: ANNUNCIATOR LIGHTS VARY ACCORDING TO THE AIRPLANE.

Figure ANN-1. Annunciators