



M O T O R S

TEC Electric Motors Ltd.





GENERAL INFORMATION

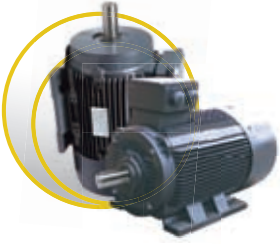

THREE PHASE-TECA/TECC TYPES-IE1/IE2



SINGLE PHASE-TPC/TCC TYPES



BRAKE MOTOR-TECA-BM TYPE

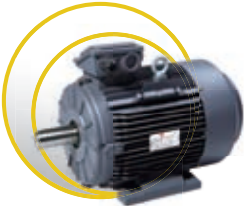

THREE PHASE MOTORS ECOL-IE1/IE2/IE3

TEC motors are designed for altitudes up to 1000m and ambient temperatures up to 40°C rated output will change at the % ratios given below for different altitudes and ambient temperatures.

ALTITUDE		Up to 1000m	1500m	2000m	2500m	3000m	3500m	4000m
Insulation Class	B	100	97	94	90	86	82	77
	F	100	98	95	91	87	83	78

AMBIENT TEMPERATURE		30°C	35°C	40m	45°C	50°C	55°C	60°C
Insulation Class	B	106	103	100	97	92	86	80
	F	105	102	100	97	93	87	82

TEC motors are wound to Class F insulation B rise.

FREQUENCY

TEC motors wound to 400V for 50Hz can be operated on 60Hz.
The ratios given below indicate changes in the given parameters.

60Hz application coefficients of 50Hz motor								
50Hz voltage	60Hz voltage	Rated Speed	Rated Power	Rated Torque	Rated Current	Starting Torque	Break down Torque	Starting Current
230V	230V	1.2	1	0.83	1	0.83	0.83	0.83
230V	265V	1.2	1.15	0.96	1	0.96	0.96	0.96
400V	400V	1.2	1	0.83	1	0.7	0.83	0.83
400V	460V	1.2	1.15	0.96	1	0.95	0.98	0.97

TEC reserves the right to alter any data given in this catalogue.



MOTORS



Motor Spare Part List "Exploded Drawing"

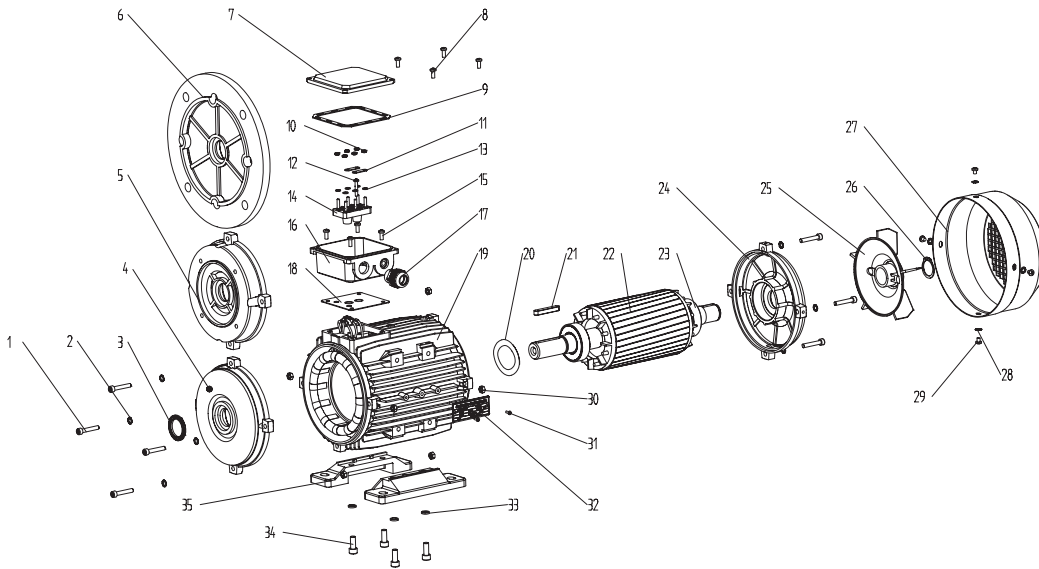

1. Screw
2. Washer
3. Oil seal
4. Drive end endshield
5. B14 flange
6. B5 flange
7. TB cover
8. TB fixing screws
9. TB upper gasket
10. Terminal board fixing nut
11. Terminal Links
12. Terminal pin
13. Terminal washer
14. Terminal block
15. TB fixing screws
16. TB base
17. Cable gland
18. TB bottom gasket
19. Stator
20. Thrust washer
21. Key
22. Rotor
23. Bearing
24. NDE endshield
25. Cooling fan
26. Fan circlip
27. Fan cowl
28. Fan cover fixing washer
29. Fan cover fixing screws
30. Endshield fixing nut
31. Rivet
32. Nameplate
33. Foot fixing washer
34. Foot fixing screws
35. Foot

This catalogue is for reference only, TEC Electric Motors reserves the right to change any content or information without prior notification, for critical none IEC dimensions please consult our sales office

Mountings and Positions

Mountings and positions for standard motors, according to IEC 60034-7, are defined by the codes mentioned in the following table.

	Standards			Frame Sizes
	CEI 2-14	IEC 60034-7		56-200
		Code I	Code II	
	B3	IM B3	IM 1001	Standard
	B3/B5	IM B35	IM 2001	Standard
	B5	IM B5	IM 3001	Standard
	B14	IM B14	IM 4001	Standard
	B8	IM B8	IM 1071	Upon request
	B6	IM B6	IM 1051	Upon request
	B7	IM B7	IM 1061	Upon request

	Standards			Frame Sizes
	CEI 2-14	IEC 60034-7		56-200
		Code I	Code II	
	V1	IM V1	IM 3011	Standard
	V3	IM V3	IM 3031	Upon request
	V5	IM V5	IM 1011	Upon request
	V6	IM V6	IM 1031	Upon request
	V1/V5	IM V15	IM 2011	Upon request

TECA aluminum housing bearing and seal data

Frame	Bearings		Oil Seals		※ Cable gland thread
	Drive End	Non-drive End	Drive End	Non-drive End	
56	6201 2RS	6201 2RS	12×22×5	12×22×5	M16
63	6201 2RS	6201 2RS	12×24×5	12×24×5	M16
71	6202 2RS	6202 2RS	15×25×7	15×25×7	M20
80	6204 2RS	6204 2RS	20×34×7	20×34×7	M20
90S	6205 2RS	6205(6204) 2RS ※	25×37×7	25×37×7(20×34×7) ※	M25
90L	6205 2RS	6205(6204) 2RS ※	25×37×7	25×37×7(20×34×7) ※	M25
100L	6206 2RS	6206 2RS	30×44×7	30×44×7	M25
112M	6306 2RS	6206(6306) 2RS	30×44×7	30×44×7	M25
132S	6308 2RS	6208(6308) 2RS	40×58×7	40×58×7	M32
132M/L	6308 2RS	6208(6308) 2RS	40×58×7	40×58×7	M32
160M	6309 2RS	6309 2RS	45×65×8	45×65×8	M32
160L	6309 2RS	6309 2RS	45×65×8	45×65×8	M32
180M	6311 2RS	6211 2RS	55×72×8	55×72×8	M32
180L	6311 2RS	6211 2RS	55×72×8	55×72×8	M32
200L	6312 2RS	6212 2RS	60×80×8	60×80×8	M40

※ Other standards are also available on request, the figures in brackets() are for the single phase motors

TECA

Series Aluminium Housing Three-Phase Multi-Mount Asynchronous Motor

TECA series Aluminum Housing 3 Phase Multi-mount motors up to 200 frame, utilising new automated production technology. The motors are manufactured to IEC Standard

Motors are :Easily maintained,light weight with high performance and low noise levels. The multi-mount design offers both O.E.M and stockist greater flexibility where terminal box position is important.



TECA Series **IE1** Efficiency Motors Technical Data (at 50Hz)

Model	Power (KW)	Current (A)			Current (A)			Current (A)			Speed (r/min)	Eff. (%)	Power Factor (CosΦ)	T _{st} /T _n (Times)	T _{max} /T _n (Times)	T _{min} /T _n (Times)	I _{st} /I _n (Times)	Noise dB(A)	W.T (Kg)
		220V	380V	660V	230V	400V	690V	240V	415V	720V									
TECA 561-2	0.09	0.66	0.38	0.22	0.62	0.36	0.21	0.60	0.35	0.20	2710	53	0.72	2.2	2.3	2	4	58	2.60
TECA 562-2	0.12	0.73	0.42	0.24	0.69	0.40	0.23	0.67	0.39	0.22	2700	61	0.72	2.2	2.3	2	4	58	3.00
TECA 563-2	0.18	1.00	0.58	0.33	0.95	0.55	0.32	0.92	0.53	0.31	2710	63	0.75	2.2	2.4	1.6	6	61	4.00
TECA 631-2	0.18	1.00	0.58	0.33	0.95	0.55	0.32	0.92	0.53	0.31	2710	63	0.75	2.2	2.4	1.6	6	61	4.00
TECA 632-2	0.25	1.29	0.75	0.43	1.23	0.71	0.41	1.19	0.69	0.40	2710	65	0.78	2.2	2.4	1.6	6	61	4.20
TECA 633-2	0.37	1.92	1.11	0.64	1.82	1.05	0.61	1.76	1.02	0.59	2710	65	0.78	2.2	2.4	1.6	6	62	4.70
TECA 711-2	0.37	1.76	1.02	0.59	1.67	0.97	0.56	1.61	0.93	0.54	2730	70	0.79	2.2	2.4	1.6	6	64	5.20
TECA 712-2	0.55	2.57	1.49	0.86	2.45	1.42	0.82	2.36	1.36	0.79	2760	71	0.79	2.2	2.4	1.6	6	64	6.00
TECA 713-2	0.75	3.33	1.93	1.11	3.18	1.83	1.06	3.06	1.77	1.02	2730	72	0.82	2.2	2.4	1.5	6	65	7.00
TECA 801-2	0.75	3.21	1.86	1.07	3.06	1.77	1.02	2.94	1.70	0.98	2770	73	0.84	2.2	2.4	1.5	6	67	8.70
TECA 802-2	1.1	4.56	2.64	1.52	4.35	2.51	1.45	4.18	2.42	1.39	2770	76.2	0.83	2.2	2.4	1.5	6	67	10.00
TECA 803-2	1.5	6.04	3.50	2.01	5.87	3.32	1.92	5.54	3.20	1.85	2800	78.5	0.83	2.2	2.4	1.5	6	70	11.20
TECA 90S-2	1.5	5.97	3.46	1.99	5.76	3.28	1.90	5.47	3.16	1.82	2840	78.5	0.84	2.2	2.4	1.5	6	72	12.00
TECA 90L1-2	2.2	8.39	4.85	2.80	8.0	4.61	2.66	7.69	4.45	2.56	2840	81	0.85	2.2	2.4	1.4	6	72	14.50
TECA 90L2-2	3	11.1	6.42	3.69	10.6	6.10	3.52	10.2	5.88	3.39	2840	82.6	0.86	2.2	2.4	1.4	6	74	15.00

TECA Series **IE1** Efficiency Motors Technical Data (at 50Hz)

Model	Power (KW)	Current (A)			Current (A)			Current (A)			Speed (r/min)	Eff. (%)	Power Factor (CosΦ)	T _{st} /T _n (Times)	T _{max} /T _n (Times)	T _{min} /T _n (Times)	I _{st} /I _n (Times)	Noise dB(A)	W.T (Kg)
		220V	380V	660V	230V	400V	690V	240V	415V	720V									
TECA 100L1-2	3	11	6.34	3.65	10.4	6.03	3.48	10	5.81	3.35	2840	82.6	0.87	2.2	2.3	1.4	7	76	20
TECA 100L2-2	4	14.3	8.3	4.78	13.7	7.88	4.55	13.1	7.6	4.38	2850	84.2	0.87	2.2	2.3	1.4	7.5	77	24
TECA 112M-2	4	14.3	8.3	4.78	13.7	7.88	4.55	13.1	7.6	4.38	2880	84.2	0.87	2.2	2.3	1.4	7.5	77	26
TECA 112L-2	5.5	19.1	11.1	6.38	18.2	10.5	6.08	17.5	10.1	5.85	2880	85.7	0.88	2.2	2.3	1.2	7.5	78	29.3
TECA 132S1-2	5.5	19.1	11.1	6.38	18.2	10.5	6.08	17.5	10.1	5.85	2900	85.7	0.88	2	2.2	1.2	7.5	80	38.4
TECA 132S2-2	7.5	25.7	14.9	8.57	24.5	14.1	8.16	23.6	13.6	7.86	2920	87	0.88	2	2.2	1.2	7.5	80	41.3
TECA 132M1-2	9.2	30.8	17.8	10.3	29.9	17.3	9.96	28.3	16.3	9.42	2930	88	0.89	2	2.2	1.2	7.5	81	48.2
TECA 132M2-2	11	36.3	21	12.1	34.6	20	11.5	33.3	19.2	11.1	2930	88.4	0.9	2	2.2	1.2	7.5	83	52.5
TECA 160M1-2	11	36.3	21	12.1	34.6	20	11.5	33.3	19.2	11.1	2940	88.4	0.9	2	2.2	1.2	7.5	86	76
TECA 160M2-2	15	48.4	28	16.1	46.1	26.6	15.4	44.4	25.7	14.8	2940	89.4	0.91	2	2.2	1.2	7.5	86	77.5
TECA 160L-2	18.5	59.3	34.3	19.8	56.5	32.6	18.8	54.3	31.4	18.1	2940	90	0.91	2	2.2	1.1	7.5	86	92
TECA 180M-2	22	71.3	41.3	23.8	68.2	39.2	22.6	65.3	37.8	21.8	2950	90	0.9	2	2.2	1.2	7.5	91	121
TECA 200L1-2	30	96	55.6	32.1	91.8	52.8	30.5	88	50.9	29.4	2950	91.2	0.9	2	2.2	1.2	7.5	94	144
TECA 200L2-2	37	117	67.9	39.2	112	64.5	37.2	108	62.2	35.9	2940	92	0.9	2	2.2	1.2	7.5	94	151
TECA 561-4	0.06	0.64	0.37	0.21	0.61	0.35	0.2	0.58	0.34	0.19	1360	50	0.56	2.3	2.4	2	4	50	2.9
TECA 562-4	0.09	0.82	0.47	0.27	0.78	0.45	0.26	0.75	0.43	0.25	1360	52	0.59	2.3	2.4	2	4	50	3.20
TECA 631-4	0.12	1	0.58	0.33	0.95	0.55	0.32	0.92	0.53	0.31	1360	52	0.64	2.2	2.4	2	4	52	3.7
TECA 632-4	0.18	1.28	0.74	0.43	1.21	0.7	0.4	1.17	0.67	0.39	1310	57	0.65	2.2	2.4	2	4	52	4.2
TECA 633-4	0.25	1.66	0.96	0.55	1.58	0.91	0.53	1.52	0.88	0.51	1340	60	0.66	2.2	2.2	2	4	54	5
TECA 711-4	0.25	1.52	0.88	0.51	1.45	0.84	0.48	1.39	0.81	0.46	1350	60	0.72	2.2	2.4	1.7	6	55	5
TECA 712-4	0.37	2.02	1.17	0.67	1.92	1.11	0.64	1.85	1.07	0.62	1370	65	0.74	2.2	2.4	1.7	6	55	5.8
TECA 713-4	0.55	2.92	1.69	0.97	2.78	1.6	0.93	2.67	1.55	0.89	1380	66	0.75	2.2	2.4	1.7	6	57	6.5
TECA 801-4	0.55	2.87	1.66	0.96	2.74	1.58	0.91	2.63	1.52	0.88	1370	67	0.75	2.2	2.4	1.7	6	58	8.1
TECA 802-4	0.75	3.5	2.03	1.17	3.34	1.93	1.11	3.21	1.86	1.07	1380	72	0.78	2.2	2.4	1.6	6	58	9.1
TECA 803-4	1.1	4.86	2.81	1.62	4.63	2.67	1.54	4.45	2.57	1.48	1390	76.2	0.78	2.2	2.4	1.6	6	60	11
TECA 90S-4	1.1	4.8	2.78	1.6	4.57	2.64	1.52	4.4	2.54	1.47	1400	76.2	0.79	2.2	2.4	1.6	6	61	11.7
TECA 90L1-4	1.5	6.27	3.63	2.09	5.97	3.45	1.99	5.75	3.32	1.92	1400	78.5	0.8	2.2	2.4	1.6	6	61	14.4
TECA 90L2-4	2.2	8.91	5.16	2.97	8.45	4.9	2.83	8.17	4.72	2.72	1400	81	0.8	2.2	2.4	1.5	7	63	17.6
TECA 100L1-4	2.2	8.8	5.09	2.93	8.38	4.84	2.79	8.07	4.66	2.69	1420	81	0.81	2.2	2.3	1.5	7	64	19.2
TECA 100L2-4	3	11.8	6.81	3.92	11.2	6.47	3.74	10.8	6.24	3.6	1420	82.6	0.81	2.2	2.3	1.5	7	64	22.5
TECA 100L3-4	4	15.2	8.8	5.07	14.2	8.36	4.83	13.9	8.06	4.65	1430	84.2	0.82	2.2	2.3	1.5	7	65	27.3
TECA 112M-4	4	15	8.7	5.01	14.3	8.26	4.77	13.8	7.96	4.59	1430	84.2	0.83	2.2	2.2	1.5	7	65	29
TECA 112L-4	5.5	20.3	11.7	6.76	19.3	11.2	6.44	18.6	10.8	6.2	1440	85.7	0.83	2.2	2.2	1.4	7	68	35.7
TECA 132S-4	5.5	20.1	11.6	6.68	19.1	11	6.37	18.4	10.6	6.13	1450	85.7	0.84	2.2	2.2	1.4	7	71	39
TECA 132M-4	7.5	26.6	15.4	8.87	25.4	14.6	8.45	24.4	14.1	8.13	1450	87	0.85	2.2	2.2	1.4	7	71	48.6
TECA 132L1-4	9.2	32.5	18.8	10.8	30.9	17.9	10.3	29.8	17.2	9.9	1460	87.5	0.85	2.2	2.2	1.4	7.5	74	56.5
TECA 132L2-4	11	38	22	12.7	36.2	20.9	12.1	34.8	20.1	11.6	1460	88.4	0.86	2.2	2.2	1.4	7.5	74	64

TECA Series IE1 Efficiency Motors Technical Data (at 50Hz)

Model	Power (KW)	Current (A)			Current (A)			Current (A)			Speed (r/min)	Eff. (%)	Power Factor (CosΦ)	T _{st} /T _n (Times)	T _{max} /T _n (Times)	T _{min} /T _n (Times)	I _{st} /I _n (Times)	Noise dB(A)	W.T (Kg)
		220V	380V	660V	230V	400V	690V	240V	415V	720V									
TECA 160M-4	11	37.5	21.7	12.5	35.8	20.6	11.9	34.4	19.9	11.5	1460	88.4	0.87	2.2	2.2	1.4	7	75	73.00
TECA 160L1-4	15	51.2	29.6	17.1	48.8	28.2	16.3	46.9	27.1	15.6	1460	88.4	0.87	2.2	2.2	1.4	7.5	75	88.50
TECA 160L2-4	18.5	63.1	36.5	21.0	60.1	34.7	20.0	57.9	33.5	19.3	1460	90.5	0.85	2.2	2.2	1.4	7.5	78	97.50
TECA 180M-4	18.5	62.4	36.1	20.8	59.7	34.3	19.8	57.2	33.1	19.1	1460	90.5	0.86	2.2	2.2	1.4	7.5	80	118.0
TECA 180L-4	22	73.8	42.7	24.7	70.6	40.6	23.4	67.7	39.1	22.6	1460	91	0.86	2.2	2.2	1.4	7.5	80	128.0
TECA 200L-4	30	99.5	57.6	33.2	95.1	54.7	31.6	91.2	52.7	30.4	1470	92	0.86	2.2	2.2	1.4	7.5	83	158.0
TECA 631-6	0.09	0.92	0.53	0.31	0.88	0.51	0.29	0.85	0.49	0.28	840	42	0.61	2	2	1.5	3.5	50	4.20
TECA 632-6	0.12	1.13	0.65	0.38	1.08	0.62	0.36	1.03	0.60	0.34	850	45	0.62	2	2	1.5	3.5	50	4.50
TECA 711-6	0.18	1.28	0.74	0.43	1.22	0.70	0.41	1.17	0.68	0.39	880	56	0.66	1.6	1.7	1.5	4	52	5.60
TECA 712-6	0.25	1.59	0.92	0.53	1.51	0.87	0.50	1.46	0.84	0.49	900	59	0.7	2.1	2.2	1.5	4	52	6.00
TECA 713-6	0.37	2.31	1.34	0.77	2.2	1.27	0.73	2.11	1.22	0.70	890	61	0.69	2	2.1	1.5	4	54	6.80
TECA 801-6	0.37	2.24	1.30	0.75	2.13	1.23	0.71	2.05	1.19	0.68	900	62	0.7	1.9	1.9	1.5	4	56	8.10
TECA 802-6	0.55	2.99	1.73	1.00	2.85	1.65	0.95	2.74	1.59	0.91	900	67	0.72	2	2.3	1.5	4	56	9.60
TECA 803-6	0.75	4.02	2.33	1.34	3.83	2.21	1.28	3.69	2.13	1.23	900	68	0.72	2	2.3	1.5	4	58	10.00
TECA 90S-6	0.75	3.96	2.29	1.32	3.77	2.18	1.26	3.63	2.10	1.21	920	69	0.72	2.2	2.2	1.5	5.5	59	11.30
TECA 90L1-6	1.1	5.49	3.18	1.83	5.23	3.02	1.74	5.03	2.91	1.68	925	72	0.73	2.2	2.2	1.3	5.5	59	14.40
TECA 90L2-6	1.5	7.09	4.11	2.36	6.76	3.90	2.25	6.50	3.76	2.17	925	74	0.75	2.2	2.2	1.3	5.5	60	15.50
TECA 100L1-6	1.5	7.00	4.05	2.33	6.67	3.85	2.22	6.42	3.71	2.14	945	74	0.76	2.2	2.2	1.3	6	61	18.80
TECA 100L2-6	2.2	9.87	5.71	3.29	9.40	5.43	3.13	9.04	5.23	3.01	950	77	0.76	2.2	2.2	1.3	6	63	19.80
TECA 112M-6	2.2	9.7	5.64	3.25	9.28	5.36	3.09	8.93	5.16	2.98	955	78	0.76	2.2	2.2	1.3	6	64	25.00
TECA 112L-6	3	12.9	7.49	4.31	12.3	7.12	4.11	11.9	6.86	3.95	950	79	0.77	2.2	2.2	1.3	6	64	30.00
TECA 132S-6	3	13.1	7.59	4.37	12.5	7.21	4.16	12.0	6.95	4.01	960	79	0.76	2	2	1.3	6.5	64	35.00
TECA 132M1-6	4	17.2	9.93	5.72	16.4	9.44	5.45	15.7	9.10	5.24	960	80.5	0.76	2	2	1.3	6.5	68	47.60
TECA 132M2-6	5.5	22.6	13.1	7.53	21.5	12.4	7.17	20.7	12.0	6.9	960	83	0.77	2	2	1.3	6.5	68	50.70
TECA 132L-6	7.5	30.1	17.4	10.0	28.7	16.5	9.55	27.6	15.9	9.2	960	85	0.77	2	2	1.3	6.5	68	47.60
TECA 160M-6	7.5	28.6	16.6	9.5	27.3	15.7	9.08	26.2	15.2	8.7	960	86	0.8	2	2.2	1.3	6.5	68	70.0
TECA 160L-6	11	41.8	24.2	13.9	39.8	23.0	13.3	38.3	22.1	12.8	960	87.5	0.79	2	2.2	1.2	6.5	73	87.0
TECA 180L-6	15	54.6	31.6	18.2	52.2	30.0	17.3	50.1	28.9	16.7	970	89	0.81	2	2.2	1.3	6.5	79	122.0
TECA 200L1-6	18.5	66.6	38.6	22.2	63.7	36.6	21.1	61.0	35.3	20.3	975	90	0.81	2	2.2	1.3	6.5	82	136.0
TECA 200L2-6	22	77.3	44.7	25.8	73.9	42.5	24.5	70.8	41.0	23.6	975	90	0.83	2	2.2	1.3	6.5	82	152.0
TECA 711-8	0.09	0.88	0.51	0.29	0.84	0.48	0.28	0.81	0.47	0.27	680	48	0.56	1.5	1.7	1.3	3	50	5.60
TECA 712-8	0.12	1.05	0.61	0.35	1.00	0.58	0.33	0.96	0.55	0.32	690	51	0.59	1.6	1.7	1.3	2.7	50	6.00
TECA 801-8	0.18	1.52	0.88	0.51	1.45	0.84	0.48	1.39	0.80	0.46	680	51	0.61	1.5	1.7	1.3	2.8	52	9.40
TECA 802-8	0.25	1.92	1.11	0.64	1.83	1.06	0.61	1.76	1.02	0.59	680	56	0.61	1.6	2	1.3	2.7	52	10.10
TECA 90S-8	0.37	2.45	1.42	0.82	2.33	1.35	0.78	2.24	1.30	0.75	680	63	0.63	1.6	1.8	1.3	2.8	56	12.50
TECA 90L-8	0.55	3.36	1.95	1.12	3.21	1.85	1.07	3.08	1.78	1.03	680	66	0.65	1.6	1.8	1.3	3	56	15.30
TECA 100L1-8	0.75	4.45	2.58	1.48	4.24	2.45	1.41	4.08	2.36	1.36	710	66	0.67	1.7	2.1	1.3	3.5	59	17.20
TECA 100L2-8	1.1	5.81	3.36	1.94	5.54	3.20	1.85	5.33	3.08	1.78	710	72	0.69	1.7	2.1	1.2	3.5	59	19.50
TECA 112M-8	1.5	7.82	4.53	2.61	7.45	4.30	2.48	7.17	4.15	2.39	710	74	0.68	1.8	2.1	1.2	4.2	61	25.50
TECA 132S-8	2.2	10.8	6.28	3.61	10.3	5.96	3.44	9.94	5.75	3.31	720	75	0.71	2	2	1.2	5.5	64	34.20
TECA 132M-8	3	14.0	8.11	4.67	13.3	7.70	4.45	12.8	7.43	4.28	720	77	0.73	2	2	1.2	5.5	64	40.00
TECA 160M1-8	4	18.0	10.4	5.99	17.1	9.89	5.71	16.5	9.53	5.49	730	80	0.73	1.9	2.1	1.2	6	68	59.00
TECA 160M2-8	5.5	23.4	13.5	7.79	22.3	12.9	7.42	21.4	12.4	7.14	720	83.5	0.74	2	2.2	1.2	6	68	69.00
TECA 160L-8	7.5	30.9	17.9	10.3	29.4	17.0	9.8	28.3	16.4	9.43	720	85	0.75	1.9	2.2	1.2	6	68	87.00
TECA 180L-8	11	45.2	26.2	15.1	43.6	25.1	14.5	41.5	24.0	13.8	715	87.4	0.73	1.9	2.2	1.2	6	78	125.0
TECA 200L-8	15	58.9	34.1	19.6	56.3	32.4	18.7	54.0	31.2	18.0	725	88.0	0.76	1.9	2.2	1.2	6	80	151.0

TECA-2 Series IE2 Efficiency Motors Technical Data (at 400V/50Hz)

Model	Power (KW)	Eff. (%)	Current (A)	Power Factor (CosΦ)	Speed (r/min)	T_{max}/T_n (Times)	T_{st}/T_n (Times)	I_{st}/I_n (Times)
TECA-2 801-2	0.75	77.4	1.75	0.80	2840	3.3	2.9	5.8
TECA-2 802-2	1.1	80	2.42	0.82	2850	3.6	3.5	6.8
TECA-2 90S-2	1.5	81.4	3.20	0.83	2850	3.6	3.5	6.9
TECA-2 90L-2	2.2	83.2	4.54	0.84	2860	4.1	4.1	7.9
TECA-2 100L-2	3	84.6	5.88	0.87	2880	3.4	3.4	7.8
TECA-2 112M-2	4	86	7.54	0.89	2890	3.3	2.7	7.5
TECA-2 132S1-2	5.5	87.2	10.2	0.89	2900	3	2.4	7.7
TECA-2 132S2-2	7.5	88.1	13.8	0.89	2910	3.2	2.6	8.4
TECA-2 160M1-2	11	89.4	19.9	0.89	2930	3.1	2.4	7.6
TECA-2 160M2-2	15	90.3	26.9	0.89	2930	3.2	2.6	8
TECA-2 160L-2	18.5	90.9	32.6	0.90	2940	3.5	3	9
TECA-2 180M-2	22	91.3	38.6	0.90	2950	3.5	2.6	8.5
TECA-2 200L1-2	30	92	52.3	0.90	2950	3.4	2.4	8
TECA-2 200L2-2	37	92.5	64.1	0.90	2950	3.5	2.5	8.5
TECA-2 802-4	0.75	79.6	1.79	0.76	1410	3	2.8	5.3
TECA-2 90S-4	1.1	81.4	2.50	0.78	1420	2.6	3.8	6.7
TECA-2 90L-4	1.5	82.8	3.31	0.79	1420	2.7	4	7.2
TECA-2 100L1-4	2.2	84.3	4.83	0.78	1440	3.6	3.6	7.4
TECA-2 100L2-4	3	85.5	6.33	0.80	1440	3.5	3.8	7.8
TECA-2 112M-4	4	86.6	8.23	0.81	1440	2.9	3.1	7.1
TECA-2 132S-4	5.5	87.9	10.9	0.83	1450	2.7	2.6	7.4
TECA-2 132M-4	7.5	88.7	14.5	0.84	1450	2.7	2.8	7.7
TECA-2 160M-4	11	89.8	21.6	0.82	1450	3.1	2.7	7.7
TECA-2 160L-4	15	90.6	28.4	0.84	1450	2.6	2.4	7.3
TECA-2 180M-4	18.5	91.4	34.4	0.85	1460	3.2	2.2	7.4
TECA-2 180L-4	22	91.7	40.3	0.86	1460	3.2	2.3	7.5
TECA-2 200L-4	30	92.3	55.2	0.86	1470	3.1	2.8	7.6
TECA-2 90S-6	0.75	76.0	2.01	0.71	925	3.1	3.1	4.7
TECA-2 90L-6	1.1	78.1	2.82	0.72	930	3.2	3.2	5
TECA-2 100L-6	1.5	80.0	3.71	0.73	940	2.9	3.1	5.9
TECA-2 112M-6	2.2	81.8	5.17	0.75	945	2.8	2.6	5.5
TECA-2 132S-6	3	83.3	6.84	0.76	960	2.7	2.2	5.7
TECA-2 132M1-6	4	84.6	8.86	0.77	960	2.7	2.4	6.2
TECA-2 132M2-6	5.5	86	12.0	0.77	960	2.7	2.6	6.7
TECA-2 160M-6	7.5	87.5	16.1	0.77	970	2.8	2	5.6
TECA-2 160L-6	11	89.0	22.9	0.78	970	2.8	2	5.8
TECA-2 180L-6	15	90.1	28.9	0.83	975	2.9	1.9	7.5
TECA-2 200L1-6	18.5	90.4	35.6	0.83	975	2.7	2.2	6.3
TECA-2 200L2-6	22	90.9	41.6	0.84	975	2.6	2.3	6.2

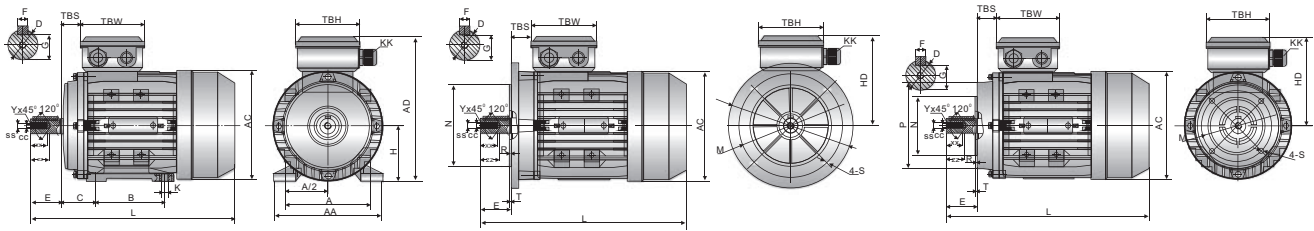

IMB3

IMB5

IMB14

Overall & Installation Dimensions

B3

Frame	H	A	B	C	D	E	F	G	K	AA	AC	L	LccL*	KK	TBS	TBW	TBH	SS	XX	ZZ	CC	Y
56	56	90	71	36	φ9	20	3	7.2	5.8×8.8	110	φ117	196	232	1-M16×1.5	14	88	88	M3	9	12	2.5	0.5
63	63	100	80	40	φ11	23	4	8.5	7×10	120	φ130	220	258	1-M16×1.5	14	94	94	M4	10	14	3.3	0.8
71**	71	112	90	45	φ14	30	5	11	7×10	132	φ147	241(255)	282(296)	1-M20×1.5	20	94	94	M5	12	17	4.2	0.8
80	80	125	100	50	φ19	40	6	15.5	10×13	160	φ163	290	339	1-M20×1.5	27	105	105	M6	16	21	5	1
90 S	90	140	100	56	φ24	50	8	20	10×13	175	φ183	312	361	1-M20×1.5	30	105	105	M8	19	25	6.8	1
90L1/L2	90	140	125	56	φ24	50	8	20	10×13	175	φ183	337/367	386/416	1-M20×1.5	30	105	105	M8	19	25	6.8	1
100**	100	160	140	63	φ28	60	8	24	12×15	198	φ205	369(387)	425(443)	2-M20×1.5	26	105	105	M10	22	30	8.5	1.5
112	112	190	140	70	φ28	60	8	24	12×15	220	φ229	395	463	2-M25×1.5	32	112	112	M10	22	30	8.5	1.5
132S	132	216	140	89	φ38	80	10	33	12×15	252	φ265	437	497	2-M25×1.5	38	112	112	M12	28	37	10.2	1.5
132M/L	132	216	178	89	φ38	80	10	33	12×15	252	φ265	475/501	535/561	2-M25×1.5	38	112	112	M12	28	37	10.2	1.5
160M/L	160	254	210/254	108	φ42	110	12	37	15×19	290	φ325	640	697	2-M32×1.5	64	143	143	M13	36	45	14.2	2
180M/L	180	279	241/279	121	φ48	110	14	42.5	15×25	340	φ368	730		2-M32×1.5	73	190	190	M14	36	45	14.2	2
200L	200	318	305	133	φ55	110	16	49	19×29	390	φ368	745		2-M40×1.5	85	190	190	M15	42	53	17.5	2

B5 Overall & Installation Dimensions

Frame	B5						B5R						D	E	F	G	KK	AC	HD	L	LccL*	TBS	TBW	TBH	SS	XX	ZZ	CC	Y
	M	N	P	T	R	S	M	N	P	T	R	S																	
56	φ100	φ80	φ120	3.0	0	φ7							φ9	20	3	7.2	1-M16×1.5	φ117	100	196	232	14	88	88	M3	9	12	2.5	0.5
63	φ115	φ95	φ140	3.0	0	φ10							φ11	23	4	8.5	1-M16×1.5	φ130	108	220	258	14	94	94	M4	10	14	3.3	0.8
71**	φ130	φ110	φ160	3.5	0	φ10	φ115	φ95	φ140	3.5	0	φ10	φ14	30	5	11	1-M20×1.5	φ147	115	241(255)	282(296)	20	94	94	M5	12	17	4.2	0.8
80	φ165	φ130	φ200	3.5	0	φ12	φ130	φ110	φ160	3.5	0	φ10	φ19	40	6	15.5	1-M20×1.5	φ163	133	290	339	27	105	105	M6	16	21	5	1
90 S	φ165	φ130	φ200	3.5	0	φ12	φ130	φ110	φ160	3.5	0	φ10	φ24	50	8	20	1-M20×1.5	φ183	139	312	361	30	105	105	M8	19	25	6.8	1
90L1/L2	φ165	φ130	φ200	3.5	0	φ12	φ130	φ110	φ160	3.5	0	φ10	φ24	50	8	20	1-M20×1.5	φ183	139	337/367	386/416	30	105	105	M8	19	25	6.8	1
100*	φ215	φ180	φ250	4.0	0	φ15	φ165	φ130	φ200	4.0	0	φ12	φ28	60	8	24	2-M20×1.5	φ205	152	369(387)	425(443)	26	105	105	M10	22	30	8.5	1.5
112	φ215	φ180	φ250	4.0	0	φ15	φ165	φ130	φ200	4.0	0	φ12	φ28	60	8	24	2-M25×1.5	φ229	167	395	463	32	112	112	M10	22	30	8.5	1.5
132S	φ265	φ230	φ300	4.0	0	φ15	φ215	φ180	φ250	4.0	0	φ15	φ38	80	10	33	2-M25×1.5	φ265	186	437	497	38	112	112	M12	28	37	10.2	1.5
132M/L	φ265	φ230	φ300	4.0	0	φ15	φ215	φ180	φ250	4.0	0	φ15	φ38	80	10	33	2-M25×1.5	φ265	186	475/501	535/561	38	112	112	M12	28	37	10.2	1.5
160M/L	φ300	φ250	φ350	5.0	0	φ19							φ42	110	12	37	2-M32×1.5	φ325	224	640	697	64	143	143	M13	36	45	14.2	2
180M/L	φ300	φ250	φ350	5.0	0	φ19							φ48	110	14	42.5	2-M32×1.5	φ368	260	730		73	190	190	M14	36	45	14.2	2
200L	φ350	φ300	φ400	5.0	0	φ19							φ55	110	16	49	2-M40×1.5	φ368	260	745		85	190	190	M15	42	53	17.5	2

B14 Overall & Installation Dimensions

Frame	B14						B14R						D	E	F	G	KK	AC	HD	L	LccL*	TBS	TBW	TBH	SS	XX	ZZ	CC	Y
	M	N	P	T	R	S	M	N	P	T	R	S																	
56	φ65	φ50	φ80	2.5	0	M6							φ9	20	3	7.2	1-M16×1.5	φ117	100	196	232	14	88	88	M3	9	12	2.5	0.5
63	φ75	φ60	φ90	2.5	0	M6	φ100	φ80	φ120	3.0	0	M6	φ11	23	4	8.5	1-M16×1.5	φ130	108	220	258	14	94	94	M4	10	14	3.3	0.8
71**	φ85	φ70	φ105	2.5	0	M6	φ115	φ95	φ140	3.0	0	M8	φ14	30	5	11	1-M20×1.5	φ147	115	241(255)	282(296)	20	94	94	M5	12	17	4.2	0.8
80	φ100	φ80	φ120	3.0	0	M6	φ130	φ110	φ160	3.5	0	M8	φ19	40	6	15.5	1-M20×1.5	φ163	133	290	339	27	105	105	M6	16	21	5.0	1.0
90 S	φ115	φ95	φ140	3.0	0	M8	φ130	φ110	φ160	3.5	0	M8	φ24	50	8	20	1-M20×1.5	φ183	139	312	361	30	105	105	M8	19	25	6.8	1.0
90L1/L2	φ115	φ95	φ140	3.0	0	M8	φ130	φ110	φ160	3.5	0	M8	φ24	50	8	20	1-M20×1.5	φ183	139	337/367	386/416	30	105	105	M8	19	25	6.8	1.0
100*	φ130	φ110	φ160	3.5	0	M8	φ165	φ130	φ200	3.5	0	M10	φ28	60	8	24	2-M20×1.5	φ205	152	369(387)	425(443)	26	105	105	M10	22	30	8.5	1.5
112	φ130	φ110	φ160	3.5	0	M8	φ165	φ130	φ200	3.5	0	M10	φ28	60	8	24	2-M25×1.5	φ229	167	395	463	32	112	112	M10	22	30	8.5	1.5
132S	φ165	φ130	φ200	4.0	0	M10	φ215	φ180	φ250	4.0	0	M12	φ38	80	10	33	2-M25×1.5	φ265	186	437	497	38	112	112	M12	28	37	10.2	1.5
132M/L	φ165	φ130	φ200	4.0	0	M10	φ215	φ180	φ250	4.0	0	M12	φ38	80	10	33	2-M25×1.5	φ265	186	475/501	535/561	38	112	112	M12	28	37	10.2	1.5
160M/L	φ215	φ180	φ250	4.0	0	M12							φ42	110	12	37	2-M32×1.5	φ325	224	640	697	64	143	143	M16	36	45	14.2	2.0

* for brake motors

** this frame size has two options, the rated output is for normal "L" size, and increased output is for the large "L" size (refer to the figures in the bracket("))

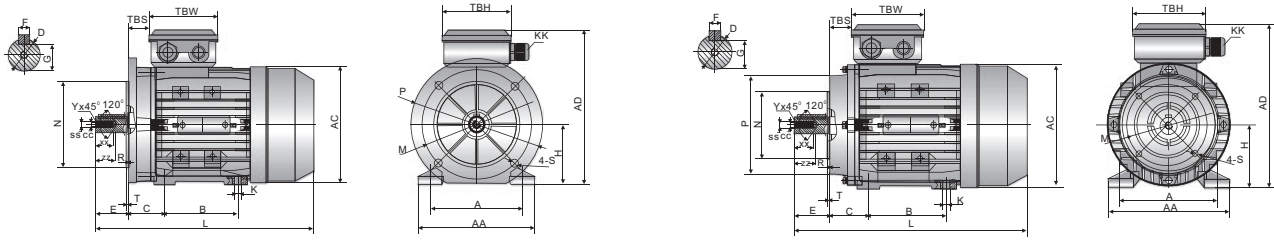

IMB35

IMB34

B35 Overall & Installation Dimensions

Frame	H	B35						B35R						A	B	C	D	E	F
		M	N	P	T	R	S	M	N	P	T	R	S						
56	56	φ100	φ80	φ120	3.0	0	φ7							90	71	36	φ9	20	3
63	63	φ115	φ95	φ140	3.0	0	φ10							100	80	40	φ11	23	4
71**	71	φ130	φ110	φ160	3.5	0	φ10	115	95	140	3.5	0	φ10	112	90	45	φ14	30	5
80	80	φ165	φ130	φ200	3.5	0	φ12	130	110	160	3.5	0	φ10	125	100	50	φ19	40	6
90 S	90	φ165	φ130	φ200	3.5	0	φ12	130	110	160	3.5	0	φ10	140	100	56	φ24	50	8
90L1/L2	90	φ165	φ130	φ200	3.5	0	φ12	130	110	160	3.5	0	φ10	140	125	56	φ24	50	8
100**	100	φ215	φ180	φ250	4.0	0	φ15	165	130	200	4.0	0	φ12	160	140	63	φ28	60	8
112	112	φ215	φ180	φ250	4.0	0	φ15	165	130	200	4.0	0	φ12	190	140	70	φ28	60	8
132S	132	φ265	φ230	φ300	4.0	0	φ15	215	180	250	4.0	0	φ15	216	140	89	φ38	80	10
132M/L	132	φ265	φ230	φ300	4.0	0	φ15	215	180	250	4.0	0	φ15	216	178	89	φ38	80	10
160M/L	160	φ300	φ250	φ350	5.0	0	φ19							254	210/254	108	φ42	110	12
180M/L	180	φ300	φ250	φ350	5.0	0	φ19							279	241/279	121	φ48	110	14
200L	200	φ350	φ300	φ400	5.0	0	φ19							318	305	133	φ55	110	16

Frame	G	K	KK	AA	AD	AC	L	Lccl*	TBS	TBW	TBH	SS	XX	ZZ	CC	Y
56	7.2	5.8×8.8	1-M16×1.5	110	156	φ117	196	232	14	88	88	M3	9	12	2.5	0.5
63	8.5	7×10	1-M16×1.5	120	171	φ130	220	258	14	94	94	M4	10	14	3.3	0.8
71**	11	7×10	1-M20×1.5	132	186	φ147	241(255)	282(296)	20	94	94	M5	12	17	4.2	0.8
80	15.5	10×13	1-M20×1.5	160	213	φ163	290	339	27	105	105	M6	16	21.0	5.0	1.0
90 S	20	10×13	1-M20×1.5	175	229	φ183	312	361	30	105	105	M8	19	25.0	6.8	1.0
90L1/L2	20	10×13	1-M20×1.5	175	229	φ183	337/367	386/416	30	105	105	M8	19	25.0	6.8	1.0
100**	24	12×15	2-M20×1.5	198	252	φ205	369(387)	425(443)	26	105	105	M10	22	30.0	8.5	1.5
112	24	12×15	2-M25×1.5	220	279	φ229	395	463	32	112	112	M10	22	30.0	8.5	1.5
132S	33	12×15	2-M25×1.5	252	318	φ265	437	497	38	112	112	M12	28	37.0	10.2	1.5
132M/L	33	12×15	2-M25×1.5	252	318	φ265	475/501	535/561	38	112	112	M12	28	37.0	10.2	1.5
160M/L	37	15×19	2-M32×1.5	290	384	φ325	640	697	64	143	143	M16	36	45.0	14.2	2.0
180M/L	42.5	15×25	2-M32×1.5	340	440	φ368	730		73	190	190	M16	36	45.0	14.2	2.0
200L	49	19×29	2-M40×1.5	390	460	φ368	745		85	190	190	M20	42	53.0	17.5	2.0

B34 Overall & Installation Dimensions

Frame	H	A	B	C	D	E	F	G	K	KK	B34					
											M	N	P	T	R	S
56	56	90	71	36	φ9	20	3	7.2	5.8×8.8	1-M16×1.5	φ65	φ50	φ80	2.5	0	M5
63	63	100	80	40	φ11	23	4	8.5	7×10	1-M16×1.5	φ75	φ60	φ90	2.5	0	M5
71**	71	112	90	45	φ14	30	5	11	7×10	1-M20×1.5	φ85	φ70	φ105	2.5	0	M6
80	80	125	100	50	φ19	40	6	15.5	10×13	1-M20×1.5	φ100	φ80	φ120	3.0	0	M6
90 S	90	140	100	56	φ24	50	8	20	10×13	1-M20×1.5	φ115	φ95	φ140	3.0	0	M8
90L1/L2	90	140	125	56	φ24	50	8	20	10×13	1-M20×1.5	φ115	φ95	φ140	3.0	0	M8
100**	100	160	140	63	φ28	60	8	24	12×15	2-M20×1.5	φ130	φ110	φ160	3.5	0	M8
112	112	190	140	70	φ28	60	8	24	12×15	2-M25×1.5	φ130	φ110	φ160	3.5	0	M8
132S	132	216	140	89	φ38	80	10	33	12×15	2-M25×1.5	φ165	φ130	φ200	4.0	0	M10
132M/L	132	216	178	89	φ38	80	10	33	12×15	2-M25×1.5	φ165	φ130	φ200	4.0	0	M10
160M/L	160	254	210/254	108	φ42	110	12	37	15×19	2-M32×1.5	φ215	φ180	φ250	4.0	0	M12

Frame	B34R						AC	AD	AA	L	Lccl*	TBS	TBW	TBH	SS	XX	ZZ	CC	Y
	M	N	P	T	R	S													
56							φ117	156	110	196	232	14	88	88	M3	9	12	2.5	0.5
63	φ100	φ80	φ120	3.0			φ130	171	120	220	258	14	94	94	M4	10	14	3.3	0.8
71**	φ115	φ95	φ140	3.0	0	M8	φ147	186	132	241(255)	282(296)	20	94	94	M5	12	17	4.2	0.8
80	φ130	φ110	φ160	3.5	0	M8	φ163	213	160	290	339	27	105	105	M6	16	21	5.0	1.0
90 S	φ130	φ110	φ160	3.5	0	M8	φ183	229	175	312	361	30	105	105	M8	19	25	6.8	1.0
90L1/L2	φ130	φ110	φ160	3.5	0	M8	φ183	229	175	337/367	386/416	30	105	105	M8	19	25	6.8	1.0
100**	φ165	φ130	φ200	3.5	0	M10	φ205	252	198	369(387)	425(443)	26	105	105	M10	22	30	8.5	1.5
112	φ165	φ130	φ200	3.5	0	M10	φ229	279	220	395	463	32	112	112	M10	22	30	8.5	1.5
132S	φ215	φ180	φ250	4.0	0	M12	φ265	318	252	437	497	38	112	112	M12	28	37	10.2	1.5
132M/L	φ215	φ180	φ250	4.0	0	M12	φ265	318	252	475/501	535/561	38	112	112	M12	28	37	10.2	1.5
160M/L							φ325	384	290	640	697	64	143	143	M16	36	45	14.2	2.0

TCC

Series Aluminium Housing Single-Phase Multi-Mount Asynchronous Motor-Dual Capacitors

TCC aluminum multi-mount single phase dual capacitor asynchronous motors are manufactured to the latest design. All motors conform to IEC standards and offer a comprehensive range up to 3.7KW an aesthetically pleasing design with the flexibility of a multi-mount terminal box and available in all mounting configurations including B14B and B5R. They are suitable for applications where starting torque requirements are 1.8-2.5 times F.L.T.

N.B.: it is recommended that single phase motors are not stop/started more than 15 times within a 1 hour period in order to allow safe discharge of capacitors.

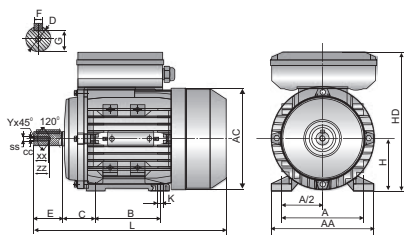

IMB3

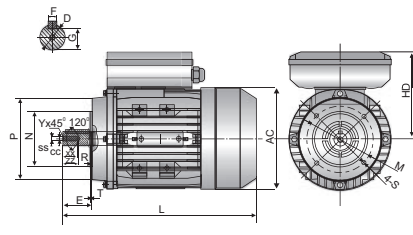

IMB14

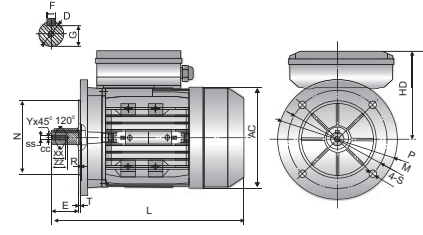

IMB5

Overall & Installation Dimensions

Frame Size	Mounting Dimensions																Overall Dimensions					Shaft End Screw Dimensions							
	A	B	C	D	E	F	G	H	K	IM B14						IM B5						AA	AC	AD	HD	L	SS	XX	ZZ
										M	N	P	R	S	T	M	N	P	R	S	T								
63	100	80	40	11	23	4	8.5	63	7X10	75	60	90	0	M5	2.5	115	95	140	0	φ 10	3.0	120	130	179	116	212	M4	10	15
71	112	90	45	14	30	5	11	71	7X10	85	70	105	0	M6	2.5	130	110	160	0	φ 10	3.5	132	145	194	123	255	M5	12	18
80	125	100	50	19	40	6	15.5	80	10X13	100	80	120	0	M6	3.0	165	130	200	0	φ 12	3.5	157	165	223	143	290	M6	16	22
90S	140	100	56	24	50	8	20	90	10X13	115	95	140	0	M8	3.0	165	130	200	0	φ 12	3.5	172	185	240	150	335	M8	20	25
90L	140	125	56	24	50	8	20	90	10X13	115	95	140	0	M8	3.0	165	130	200	0	φ 12	3.5	172	185	240	150	365	M8	20	25
100L	160	140	63	28	60	8	24	100	12X15	130	110	160	0	M8	3.5	215	180	250	0	φ 15	4.0	196	205	260	160	398/416	M10	22	28
112M	190	140	70	28	60	8	24	112	12X15	130	110	160	0	M8	3.5	215	180	250	0	φ 15	4.0	222	230	295	183	416	M10	22	28

Technical Data (at 110V/50Hz)

Model	Power (KW)	Current (A)	Speed (r/min)	Eff. (%)	Power Factor (Cosφ)	Rate Torque (N.M)	T _{st} /T _n (Times)	T _{max} /T _n (Times)	Starting Current (A)	Run Capacitor (μF/V)	Start Capacitor (μF/V)	Noise dB (A)	W.T (Kg)
		110V											
TCC 631-2	0.18	2.89	2710	63	0.9	0.63	1.8	1.6	16	30μF/250V	100μF/125V	70	4.2
TCC 632-2	0.25	3.95	2710	64	0.9	0.88	1.8	1.6	20	40μF/250V	100μF/125V	73	4.7
TCC 711-2	0.37	5.4	2780	67	0.93	1.27	2.0	1.8	30	40μF/250V	200μF/125V	75	5.3
TCC 712-2	0.55	7.68	2790	70	0.93	1.88	2.0	1.8	40	60μF/250V	300μF/125V	76	7.4
TCC 801-2	0.75	9.97	2800	72	0.95	2.56	2.5	1.8	60	80μF/250V	400μF/125V	76	9.5
TCC 802-2	1.1	14.04	2810	75	0.95	3.74	2.5	1.8	80	100μF/250V	600μF/125V	79	11.2
TCC 90S-2	1.5	18.89	2810	76	0.95	5.10	2.5	1.8	110	140μF/250V	800μF/125V	84	14
TCC 90L-2	2.2	27.34	2810	77	0.95	7.48	2.5	1.8	150	160μF/250V	1000μF/125V	84	17
TCC 100L-2	3	36.34	2830	79	0.95	10.13	2.5	1.7	220	180μF/250V	1400μF/125V	88	25
TCC 631-4	0.12	2.2	1350	55	0.9	0.86	2.5	1.6	12	30μF/250V	100μF/125V	64	4.1
TCC 632-4	0.18	3.25	1350	56	0.9	1.27	1.8	1.6	17	40μF/250V	100μF/125V	64	4.4
TCC 711-4	0.25	4.21	1380	60	0.9	1.73	1.8	1.7	20	40μF/250V	150μF/125V	66	5.9
TCC 712-4	0.37	5.93	1380	63	0.9	2.56	2.0	1.7	30	40μF/250V	200μF/125V	68	6.9
TCC 801-4	0.55	8.42	1400	66	0.9	3.75	2.0	1.8	40	70μF/250V	300μF/125V	71	9.6
TCC 802-4	0.75	10.98	1410	69	0.9	5.08	2.5	1.8	60	90μF/250V	400μF/125V	71	10.8
TCC 90S-4	1.1	14.73	1410	73	0.93	7.45	2.5	1.8	80	120μF/250V	600μF/125V	74	13.5
TCC 90L-4	1.5	19.81	1400	74	0.93	10.24	2.5	1.8	110	140μF/250V	800μF/125V	79	16.5
TCC 100L-4	2.2	28.3	1430	76	0.93	14.70	2.5	1.8	150	170μF/250V	1300μF/125V	79	24
TCC 100L2-4	3	38.09	1440	77	0.93	19.91	2.5	1.8	220	200μF/250V	1600μF/125V	83	30

Technical Data (at 230V/50Hz)

Model	Power (KW)	Current (A)	Speed (r/min)	Eff. (%)	Power Factor (Cosφ)	Rate Torque (N.M)	T _{st} /T _n (Times)	T _{max} /T _n (Times)	Starting Current (A)	Run Capacitor (μF/V)	Start Capacitor (μF/V)	Noise dB (A)	W.T (Kg)
		230V											
TCC 631-2	0.18	1.38	2710	63	0.9	0.63	2.5	1.6	8	10μF/450V	30μF/250V	70	3.9
TCC 632-2	0.25	1.89	2710	64	0.9	0.88	2.5	1.6	10	12μF/450V	40μF/250V	73	4.4
TCC 711-2	0.37	2.66	2780	65	0.93	1.27	2.5	1.8	15	12μF/450V	75μF/250V	75	6.1
TCC 712-2	0.55	3.78	2790	68	0.93	1.88	2.5	1.8	20	16μF/450V	100μF/250V	76	7
TCC 801-2	0.75	4.87	2800	72	0.93	2.56	2.5	1.8	30	20μF/450V	100μF/250V	76	9
TCC 802-2	1.1	7.04	2810	73	0.93	3.74	2.5	1.8	40	30μF/450V	150μF/250V	79	10.3
TCC 90S-2	1.5	9.48	2810	74	0.93	5.10	2.5	1.8	55	40μF/450V	200μF/300V	84	16.3
TCC 90L-2	2.2	13.57	2810	75	0.94	7.48	2.5	1.8	75	50μF/450V	250μF/300V	84	16.7
TCC 100L-2	3.0	17.83	2830	77	0.95	10.13	2.5	1.7	110	60μF/450V	400μF/300V	88	25
TCC 112M1-2	3.7	21.48	2850	78	0.96	12.40	2.5	1.7	140	60μF/450V	600μF/300V	90	33
TCC 112M2-2	4.0	22.18	2850	80	0.98	13.41	2.5	1.7	150	60μF/450V	600μF/300V	90	34.2
TCC 631-4	0.12	1.05	1350	55	0.9	0.85	2.5	1.6	6	10μF/450V	30μF/250V	64	4.1
TCC 632-4	0.18	1.55	1350	56	0.9	1.27	2.5	1.6	8.5	12μF/450V	40μF/250V	64	4.5
TCC 711-4	0.25	2.01	1380	60	0.9	1.73	2.5	1.7	10	12μF/450V	50μF/250V	66	5.9
TCC 712-4	0.37	2.84	1380	63	0.9	2.56	2.5	1.7	15	16μF/450V	75μF/250V	68	6.9
TCC 801-4	0.55	4.03	1400	66	0.9	3.75	2.5	1.8	20	20μF/450V	100μF/250V	71	9.6
TCC 802-4	0.75	5.25	1410	69	0.9	5.08	2.5	1.8	30	25μF/450V	100μF/250V	71	10.9
TCC 90S-4	1.1	7.24	1410	71	0.93	7.45	2.5	1.8	40	35μF/450V	150μF/250V	74	13.8
TCC 90L-4	1.5	9.61	1400	73	0.93	10.24	2.5	1.8	55	40μF/450V	200μF/300V	79	16.7
TCC 100L1-4	2.2	13.90	1430	74	0.93	14.70	2.5	1.8	75	50μF/450V	300μF/300V	79	22.8
TCC 100L2-4	3	18.70	1440	75	0.93	19.91	2.5	1.8	110	60μF/450V	500μF/300V	83	28.7
TCC 112M1-4	3.7	21.99	1440	77	0.95	24.55	2.5	1.7	140	60μF/450V	600μF/300V	86	31
TCC 112M2-4	4.0	22.41	1440	80	0.97	26.54	2.5	1.7	150	60μF/450V	600μF/300V	86	32.8

TPC

Series Aluminium Housing Single-Phase Multi-Mount Asynchronous Motor-Run Capacitor

The TPC Aluminum multi-mount single phase permanent capacitor asynchronous motor adopts the same frame configurations as the TCC range with smaller terminal box arrangement and high resistance rotor.

The TPC range is suitable for most fan and square law torque applications, This range is suitable for Triac speed control and offers starting torque of 0.5-0.9 times F.L.T.

N.B.: it is recommended that single phase motors are not stopped / started more than 15 times in 1 hour in order to allow safe discharge of capacitors.

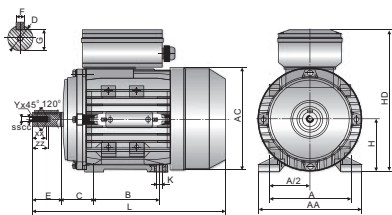

IMB3

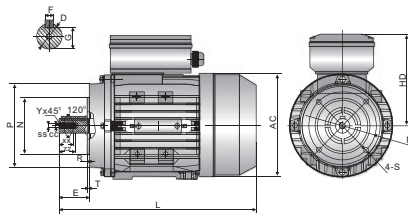

IMB14

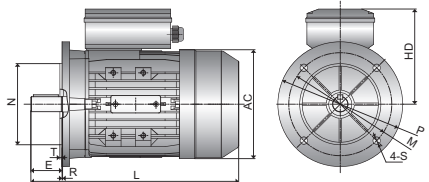

IMB5

Overall & Installation Dimensions

Frame Size	Mounting Dimensions																			Overall Dimensions					Shaft End Screw Dimensions				
	A	B	C	D	E	F	G	H	K	IM B14					IM B5														
										M	N	P	T	R	S	M	N	P	T	R	S	AA	AC	AD	HD	L	SS	XX	ZZ
56	90	71	36	φ9	20	3	7.2	56	5.8x8.8	φ65	φ50	φ80	2.5	0	M5	φ100	φ80	φ120	3.0	0	φ7	110	φ117	144	88	196	M3	9	12
63	100	80	40	φ11	23	4	8.5	63	7x10	φ75	φ60	φ90	2.5	0	M5	φ115	φ95	φ140	3.0	0	φ10	120	φ130	181	118	220	M4	10	14
71*	112	90	45	φ14	30	5	11	71	7x10	φ85	φ70	φ105	2.5	0	M6	φ130	φ110	φ160	3.5	0	φ10	132	φ147	196	125	241/255	M5	12	17
80	125	100	50	φ19	40	6	15.5	80	10x13	φ100	φ80	φ120	3.0	0	M6	φ165	φ130	φ200	3.5	0	φ12	160	φ163	226	146	290	M6	16	21
90S	140	100	56	φ24	50	8	20	90	10x13	φ115	φ95	φ140	3.0	0	M8	φ165	φ130	φ200	3.5	0	φ12	175	φ183	243	153	312	M8	19	25
90L	140	125	56	φ24	50	8	20	90	10x13	φ115	φ95	φ140	3.0	0	M8	φ165	φ130	φ200	3.5	0	φ12	175	φ183	243	153	337/367	M8	19	25
100L**	160	140	63	φ28	60	8	24	100	12x15	φ130	φ110	φ160	3.5	0	M8	φ215	φ180	φ250	4.0	0	φ15	198	φ205	265	165	369/387	M10	22	30

** This frame size has two housing sizes, the rated output is for normal "L" size, and increased output is for the large "L" size (refer to the figures in the bracket "()")

Technical Data (at 230V/50Hz)

Model	Power (KW)	Current (A)	Speed (r/min)	Eff. (%)	Power Factor (CosΦ)	T _{st} /T _n (Times)	T _{max} /T _n (Times)	Starting Current (A)	Run Capacitor (μF/V)	Noise dB(A)	W.T (Kg)
TPC 5612	0.09	0.80	2740	54	0.91	0.69	1.8	2.5	4μF/450V	67	2.8
TPC 5622	0.12	0.90	2760	60	0.93	0.69	1.8	3.5	6μF/450V	67	3.05
TPC 5632	0.18	1.40	2760	62	0.93	0.55	1.8	4.5	8μF/450V	70	3.5
TPC 6312	0.18	1.40	2760	62	0.93	0.55	1.8	4.5	8μF/450V	70	4.1
TPC 6322	0.25	1.70	2780	66	0.93	0.55	1.8	6	10μF/450V	70	4.5
TPC 6332	0.37	2.50	2780	67	0.93	0.45	1.65	8	12μF/450V	75	5.25
TPC 711-2	0.37	2.60	2640	66	0.94	0.72	1.65	8	14μF/450V	75	6.1
TPC 712-2	0.55	3.60	2760	71	0.95	0.7	1.8	14	20μF/450V	75	7.7
TPC 801-2	0.75	4.50	2735	73	0.98	0.68	1.75	16	25μF/450V	75	10.3
TPC 802-2	1.10	6.60	2720	74	0.98	0.65	1.8	23	35μF/450V	78	11.6
TPC 803-2	1.50	9.20	2730	74	0.98	0.65	1.8	31	50μF/450V	78	13.6
TPC 90S-2	1.50	8.50	2755	76	0.98	0.65	1.8	31	50μF/450V	80	14.6
TPC 90L-2	2.20	12.30	2765	77	0.98	0.65	1.8	51	70μF/450V	80	17.8
TPC 100L-2	3.00	16.90	2765	77	0.99	0.55	1.75	64	90μF/450V	83	23.7
TPC 5614	0.06	0.60	1360	50	0.94	0.75	1.75	2	4μF/450V	63	3.3
TPC 5624	0.09	0.80	1360	52	0.94	0.6	1.75	3	6μF/451V	63	3.6
TPC 5634	0.12	1.30	1370	52	0.92	0.6	1.75	3	8μF/452V	65	4.1
TPC 6314	0.12	1.30	1370	52	0.92	0.6	1.75	3	8μF/453V	65	4.45
TPC 6324	0.18	1.50	1370	54	0.94	0.6	1.6	4	10μF/450V	65	5.05
TPC 6334	0.25	2.00	1370	58	0.95	0.6	1.6	5	12μF/450V	65	5.4
TPC 711-4	0.25	2.00	1320	56	0.94	0.75	1.6	5	14μF/450V	65	6.2
TPC 712-4	0.37	2.90	1325	58	0.94	0.7	1.55	7	20μF/450V	68	7.3
TPC 801-4	0.55	3.90	1340	64	0.94	0.7	1.7	11	25μF/450V	73	10.1
TPC 802-4	0.75	5.30	1340	64	0.94	0.7	1.75	15	35μF/450V	73	11.4
TPC 90S-4	1.10	7.00	1355	72	0.95	0.68	1.8	22	50μF/450V	75	14.4
TPC 90L-4	1.50	9.30	1360	74	0.95	0.68	1.8	32	50μF/450V	78	17.5
TPC 100L1-4	2.20	12.60	1390	78	0.97	0.48	1.75	49	70μF/450V	80	24.5
TPC 100L2-4	3.00	16.50	1380	79	0.99	0.45	1.6	61	90μF/450V	80	32
TPC 6316	0.09	0.92	900	46	0.92	0.8	1.45	2	8μF/464V	63	5.1
TPC 6326	0.12	1.05	900	54	0.92	0.75	1.45	3	11μF/465V	63	6
TPC 7116	0.18	1.55	900	55	0.92	0.7	1.5	4	16μF/466V	68	6.3
TPC 7126	0.25	2.07	900	57	0.92	0.68	1.5	5	20μF/467V	68	7.6
TPC 8016	0.37	2.82	900	62	0.92	0.68	1.6	8	25μF/468V	68	9
TPC 8026	0.55	4.08	900	63	0.93	0.68	1.6	14	30μF/469V	70	11.6
TPC 90S6	0.75	5.20	900	66	0.95	0.65	1.6	16	40μF/470V	70	13.5
TPC 90L6	1.10	7.51	900	67	0.95	0.62	1.6	25	50μF/471V	70	16.2

TECA-BM

Series Aluminium Housing Three-Phase Multi-Mount Asynchronous Brake Motor With Squirrel Cage Rotor - Direct Current Brake



TEC brake-motor in the TECA-BM series utilises an asynchronous three-phase motor and an electromagnetic D.C brake Unit.

Features include reliability, operating safety, and quick braking time (connection and disconnection=5-80 milli seconds) they are suitable for a variety of applications, such as:

- Braking of loads or torques on the drive shaft
- Braking of rotating loads to reduce stopping time
- Braking operations to assist set-up precision
- Braking of machine parts, in accordance with safety standards

Technical Features

2 poles-3000rpm-50Hz
Brake motors have a ±6% tolerance on the supply voltage

Model	Power (KW)	Speed (r/min)	Eff. (%)	Power Factor (CosΦ)	Current (A)			T _{st} /T _n (Times)	T _{max} /T _n (Times)	T _{min} /T _n (Times)	I _{st} /I _n (Times)	Noise dB(A)
					230V	400V	690V					
TECA-BM 631-2	0.18	2710	63	0.75	0.95	0.55	0.32	2.2	2.4	1.6	6	61
TECA-BM 632-2	0.25	2710	65	0.78	1.23	0.71	0.41	2.2	2.4	1.6	6	61
TECA-BM 633-2	0.37	2710	65	0.78	1.82	1.05	0.61	2.2	2.4	1.6	6	62
TECA-BM 711-2	0.37	2730	70	0.79	1.67	0.97	0.56	2.2	2.4	1.6	6	64
TECA-BM 712-2	0.55	2760	71	0.79	2.45	1.42	0.82	2.2	2.4	1.6	6	64
TECA-BM 713-2	0.75	2730	72	0.82	3.18	1.83	1.06	2.2	2.4	1.5	6	65
TECA-BM 801-2	0.75	2770	73	0.84	3.06	1.77	1.02	2.2	2.4	1.5	6	67
TECA-BM 802-2	1.1	2770	76.2	0.83	4.35	2.51	1.45	2.2	2.4	1.5	6	67
TECA-BM 803-2	1.5	2800	78.5	0.83	5.87	3.32	1.92	2.2	2.4	1.5	6	70
TECA-BM 90S-2	1.5	2840	78.5	0.84	5.76	3.28	1.90	2.2	2.4	1.5	6	72
TECA-BM 90L1-2	2.2	2840	81	0.85	8.0	4.61	2.66	2.2	2.4	1.4	6	72
TECA-BM 90L2-2	3	2840	82.6	0.86	10.56	6.10	3.52	2.2	2.4	1.4	6	74
TECA-BM 100L1-2	3	2840	82.6	0.87	10.44	6.03	3.48	2.2	2.3	1.4	7	76
TECA-BM 100L2-2	4	2850	84.2	0.87	13.65	7.88	4.55	2.2	2.3	1.4	7.5	77
TECA-BM 112M-2	4	2880	84.2	0.87	13.65	7.88	4.55	2.2	2.3	1.4	7.5	77
TECA-BM 112L-2	5.5	2880	85.7	0.88	18.23	10.53	6.08	2.2	2.3	1.2	7.5	78
TECA-BM 132S1-2	5.5	2900	85.7	0.88	18.23	10.53	6.08	2	2.2	1.2	7.5	80
TECA-BM 132S2-2	7.5	2920	87	0.88	24.49	14.14	8.16	2	2.2	1.2	7.5	80
TECA-BM 132M1-2	9.2	2930	88	0.89	29.87	17.25	9.96	2	2.2	1.2	7.5	81
TECA-BM 132M2-2	11	2930	88.4	0.9	34.57	19.96	11.52	2	2.2	1.2	7.5	83
TECA-BM 160M1-2	11	2940	88.4	0.9	34.57	19.96	11.52	2	2.2	1.2	7.5	86
TECA-BM 160M2-2	15	2940	89.4	0.91	46.09	26.61	15.36	2	2.2	1.2	7.5	86
TECA-BM 160L-2	18.5	2940	90	0.91	56.47	32.6	18.82	2	2.2	1.1	7.5	86

Type	Brake Type K	Brake Torque Nm	Brake Rated Power W	J Brake Pd ² Kg m ²	No. of Starts/hr. Under No Load	Delayed Cut-in Time ★ Msec.	Quick Cut-in Time Msec.	Cut Out Time Msec.	Noise dB(A)
TECA-BM 63	K 1	5	15	0.00005	3000	45	20	10	62
TECA-BM 71	K 2	12	20	0.00014	3000	50	30	15	64
TECA-BM 80	K 3	16	25	0.00021	1300	55	30	15	67
TECA-BM 90S	K 4	20	30	0.00039	1100	65	40	15	72
●TECA-BM 90S	K 4 D	40	30	0.00078	1100	65	40	15	72
TECA-BM 90 L	K 4	20	30	0.00039	1100	65	40	15	72
●TECA-BM 90 L	K 4 D	40	30	0.00078	1100	65	40	15	72
TECA-BM 100 L	K 5	40	45	0.00104	900	75	45	20	76
●TECA-BM 100 L	K 6	60	50	0.00135	900	180	85	25	76
TECA-BM 112 MT	K 5	40	45	0.00104	880	75	45	20	77
TECA-BM 112 M	K 6	60	50	0.00135	880	180	85	25	78
TECA-BM 132 S	K 7	90	55	0.00219	480	200	95	50	80
●TECA-BM 132 S	K 7 D	180	55	0.00438	480	200	95	50	80
TECA-BM 132 M	K 7	90	55	0.00219	450	200	95	50	80
●TECA-BM 132 M	K 7 D	180	55	0.00438	480	200	95	50	80
TECA-BM 160 MT	K 7 D	180	55	0.00438	350	200	95	50	86
TECA-BM 160 L	K 8	200	60	0.00408	350	210	100	60	86
●TECA-BM 160 L	K 8 D	400	60	0.00816	350	210	100	60	86

● Motor with increased braking torque on request

★ On request, delayed brake cut in time for lifting equipment. We suggest double disk brake D for lifting equipment.

Technical Features

4 poles-1500rpm-50Hz
Brake motors have a ±6% tolerance on the supply voltage

Model	Power (KW)	Speed (r/min)	Eff. (%)	Power Factor (CosΦ)	Current (A)			T _{st} /T _n (Times)	T _{max} /T _n (Times)	T _{min} /T _n (Times)	I _{st} /I _n (Times)	Noise dB(A)
					230V	400V	690V					
TECA-BM 631-4	0.12	1350	57	0.64	0.82	0.47	0.27	2.2	2.4	1.7	6	52
TECA-BM 632-4	0.18	1350	59	0.65	1.17	0.68	0.39	2.2	2.4	1.7	6	52
TECA-BM 633-4	0.25	1350	60	0.66	1.58	0.91	0.53	2.2	2.4	1.7	6	54
TECA-BM 711-4	0.25	1350	60	0.72	1.45	0.84	0.48	2.2	2.4	1.7	6	55
TECA-BM 712-4	0.37	1370	65	0.74	1.92	1.11	0.64	2.2	2.4	1.7	6	55
TECA-BM 713-4	0.55	1380	66	0.75	2.78	1.60	0.93	2.2	2.4	1.7	6	57
TECA-BM 801-4	0.55	1370	67	0.75	2.74	1.58	0.91	2.2	2.4	1.7	6	58
TECA-BM 802-4	0.75	1380	72	0.78	3.34	1.93	1.11	2.2	2.4	1.6	6	58
TECA-BM 803-4	1.1	1390	76.2	0.78	4.63	2.67	1.54	2.2	2.4	1.6	6	60
TECA-BM 90S-4	1.1	1400	76.2	0.79	4.57	2.64	1.52	2.2	2.4	1.6	6	61
TECA-BM 90L-4	1.5	1400	78.5	0.8	5.97	3.45	1.99	2.2	2.4	1.6	6	61
TECA-BM 90L2-4	2.2	1400	81	0.8	8.45	4.90	2.83	2.2	2.4	1.5	7	63
TECA-BM 100L1-4	2.2	1420	81	0.81	8.38	4.84	2.79	2.2	2.3	1.5	7	64
TECA-BM 100L2-4	3	1420	82.6	0.81	11.21	6.47	3.74	2.2	2.3	1.5	7	64
TECA-BM 100L3-4	4	1430	84.2	0.82	14.18	8.36	4.83	2.2	2.3	1.5	7	65
TECA-BM 112M-4	4	1430	84.2	0.83	14.31	8.26	4.77	2.2	2.2	1.5	7	65
TECA-BM 112L-4	5.5	1440	85.7	0.83	19.33	11.16	6.44	2.2	2.2	1.4	7	68
TECA-BM 132S-4	5.5	1450	85.7	0.84	19.1	11.03	6.37	2.2	2.2	1.4	7	71
TECA-BM 132M-4	7.5	1450	87	0.85	25.35	14.64	8.45	2.2	2.2	1.4	7	71
TECA-BM 132L1-4	9.2	1460	87.5	0.85	30.92	17.85	10.31	2.2	2.2	1.4	7.5	74
TECA-BM 132L2-4	10	1460	88	0.85	33.42	19.3	11.14	2.2	2.2	1.4	7.5	74
TECA-BM 132L2-4	11	1460	88.4	0.86	36.17	20.88	12.06	2.2	2.2	1.4	7.5	74
TECA-BM 160M-4	11	1460	88.4	0.87	35.76	20.64	11.92	2.2	2.2	1.4	7	75
TECA-BM 160L-4	15	1460	88.4	0.87	48.76	28.15	16.25	2.2	2.2	1.4	7.5	75

Type	Brake Type K	Brake Torque Nm	Brake Rated Power W	J Brake Pd ² Kgm ²	No. of Starts/hr. Under No Load	Delayed Cut-in Time ★ Msec.	Quick Cut-in Time Msec.	Cut Out Time Msec.	Noise dB(A)
TECA-BM 63	K 1	5	15	0.00005	3000	45	20	10	52
TECA-BM 71	K 2	12	20	0.00014	3000	50	30	15	55
TECA-BM 80	K 3	16	25	0.00021	1300	55	30	15	58
TECA-BM 90S	K 4	20	30	0.00039	1100	65	40	15	61
●TECA-BM 90S	K 4 D	40	30	0.00078	1100	65	40	15	61
TECA-BM 90 L	K 4	20	30	0.00039	1100	65	40	15	63
●TECA-BM 90 L	K 4 D	40	30	0.00078	1100	65	40	15	63
TECA-BM 100 L	K 5	40	45	0.00104	900	75	45	20	64
●TECA-BM 100 L	K 6	60	50	0.00135	900	180	85	25	65
TECA-BM 112 MT	K 5	40	45	0.00104	880	75	45	20	65
TECA-BM 112 M	K 6	60	50	0.00135	880	180	85	25	65
TECA-BM 132 S	K 7	90	55	0.00219	480	200	95	50	71
●TECA-BM 132 S	K 7 D	180	55	0.00438	480	200	95	50	71
TECA-BM 132 M	K 7	90	55	0.00219	450	200	95	50	71
●TECA-BM 132 M	K 7 D	180	55	0.00438	480	200	95	50	71
TECA-BM 160 MT	K 7 D	180	55	0.00438	350	200	95	50	75
TECA-BM 160 L	K 8	200	60	0.00408	350	210	100	60	75
●TECA-BM 160 L	K 8 D	400	60	0.00816	350	210	100	60	75

● Motor with increased braking torque on request

★ On request, delayed brake cut in time for lifting equipment. We suggest double disk brake D for lifting equipment.

Technical Features

6 poles-1000rpm-50Hz
Brake motors have a ±6% tolerance on the supply voltage

Model	Power (KW)	Speed (r/min)	Eff. (%)	Power Factor (CosΦ)	Current (A)			T _{st} /T _n (Times)	T _{max} /T _n (Times)	T _{min} /T _n (Times)	I _{st} /I _n (Times)	Noise dB(A)
					230V	400V	690V					
TECA-BM 631-6	0.09	840	42	0.61	0.88	0.51	0.29	2	2	1.5	3.5	50
TECA-BM 632-6	0.12	850	45	0.62	1.08	0.62	0.36	2	2	1.5	3.5	50
TECA-BM 711-6	0.18	880	56	0.66	1.22	0.70	0.41	1.6	1.7	1.5	4	52
TECA-BM 712-6	0.25	900	59	0.7	1.51	0.87	0.50	2.1	2.2	1.5	4	52
TECA-BM 713-6	0.37	890	61	0.69	2.2	1.27	0.73	2	2.1	1.5	4	54
TECA-BM 801-6	0.37	900	62	0.7	2.13	1.23	0.71	1.9	1.9	1.5	4	56
TECA-BM 802-6	0.55	900	67	0.72	2.85	1.65	0.95	2	2.3	1.5	4	56
TECA-BM 803-6	0.75	900	68	0.72	3.83	2.21	1.28	2	2.3	1.5	4	58
TECA-BM 90S-6	0.75	920	69	0.72	3.77	2.18	1.26	2.2	2.2	1.5	5.5	59
TECA-BM 90L-6	1.1	925	72	0.73	5.23	3.02	1.74	2.2	2.2	1.3	5.5	59
TECA-BM 100L-6	1.5	945	74	0.76	6.67	3.85	2.22	2.2	2.2	1.3	6	61
TECA-BM 112M-6	2.2	955	78	0.76	9.28	5.36	3.09	2.2	2.2	1.3	6	64
TECA-BM 132S-6	3	960	79	0.76	12.49	7.21	4.16	2	2	1.3	6.5	64
TECA-BM 132M1-6	4	960	80.5	0.76	16.35	9.44	5.45	2	2	1.3	6.5	68
TECA-BM 132M2-6	5.5	960	83	0.77	21.51	12.42	7.17	2	2	1.3	6.5	68
TECA-BM 132L-6	7.5	960	85	0.77	28.65	16.54	9.55	2	2	1.3	6.5	68
TECA-BM 160M-6	7.5	960	86	0.8	27.25	15.73	9.08	2	2.2	1.3	6.5	68
TECA-BM 160L-6	11	960	87.5	0.79	39.78	22.97	13.26	2	2.2	1.2	6.5	73

Type	Brake Type K	Brake Torque Nm	Brake Rated Power W	J Brake Pd ² Kgm ²	No. of Starts/hr. Under No Load	Delayed Cut-in Time ★ Msec.	Quick Cut-in Time Msec.	Cut Out Time Msec.	Noise dB(A)
TECA-BM 63	K 1	5	15	0.00005	3000	45	20	10	50
TECA-BM 71	K 2	12	20	0.00014	3000	50	30	15	52
TECA-BM 80	K 3	16	25	0.00021	1300	55	30	15	56
TECA-BM 90S	K 4	20	30	0.00039	1100	65	40	15	59
●TECA-BM 90S	K 4 D	40	30	0.00078	1100	65	40	15	59
TECA-BM 90 L	K 4	20	30	0.00039	1100	65	40	15	59
●TECA-BM 90 L	K 4 D	40	30	0.00078	1100	65	40	15	59
TECA-BM 100 L	K 5	40	45	0.00104	900	75	45	20	61
●TECA-BM 100 L	K 6	60	50	0.00135	900	180	85	25	61
TECA-BM 112 MT	K 5	40	45	0.00104	880	75	45	20	64
TECA-BM 112 M	K 6	60	50	0.00135	880	180	85	25	64
TECA-BM 132 S	K 7	90	55	0.00219	480	200	95	50	64
●TECA-BM 132 S	K 7 D	180	55	0.00438	480	200	95	50	64
TECA-BM 132 M	K 7	90	55	0.00219	450	200	95	50	68
●TECA-BM 132 M	K 7 D	180	55	0.00438	480	200	95	50	68
TECA-BM 160 MT	K 7 D	180	55	0.00438	350	200	95	50	68
TECA-BM 160 L	K 8	200	60	0.00408	350	210	100	60	73
●TECA-BM 160 L	K 8 D	400	60	0.00816	350	210	100	60	73

● Motor with increased braking torque on request

★ On request, delayed brake cut in time for lifting equipment. We suggest double disk brake D for lifting equipment.

Technical Features

8 poles-750rpm-50Hz
Brake motors have a ±6% tolerance on the supply voltage

Model	Power (KW)	Speed (r/min)	Eff. (%)	Power Factor (CosΦ)	Current (A)			T _{st} /T _n (Times)	T _{max} /T _n (Times)	T _{min} /T _n (Times)	I _{st} /I _n (Times)	Noise dB(A)
					230V	400V	690V					
TECA-BM 711-8	0.09	680	48	0.56	0.84	0.48	0.28	1.5	1.7	1.3	3	50
TECA-BM 712-8	0.12	690	51	0.59	1.00	0.58	0.33	1.6	1.7	1.3	2.7	50
TECA-BM 801-8	0.18	680	51	0.61	1.45	0.84	0.48	1.5	1.7	1.3	2.8	52
TECA-BM 802-8	0.25	680	56	0.61	1.83	1.06	0.61	1.6	2	1.3	2.7	52
TECA-BM 90S-8	0.37	680	63	0.63	2.33	1.35	0.78	1.6	1.8	1.3	2.8	56
TECA-BM 90L-8	0.55	680	66	0.65	3.21	1.85	1.07	1.6	1.8	1.3	3	56
TECA-BM 100L1-8	0.75	710	66	0.67	4.24	2.45	1.41	1.7	2.1	1.3	3.5	59
TECA-BM 100L2-8	1.1	710	72	0.69	5.54	3.20	1.85	1.7	2.1	1.2	3.5	59
TECA-BM 112M-8	1.5	710	74	0.68	7.45	4.30	2.48	1.8	2.1	1.2	4.2	61
TECA-BM 132S-8	2.2	720	75	0.71	10.33	5.96	3.44	2	2	1.2	5.5	64
TECA-BM 132M-8	3	720	77	0.73	13.34	7.70	4.45	2	2	1.2	5.5	64
TECA-BM 160M1-8	4	730	80	0.73	17.12	9.89	5.71	1.9	2.1	1.2	6	68
TECA-BM 160M2-8	5.5	720	83.5	0.74	22.25	12.85	7.42	2	2.2	1.2	6	68
TECA-BM 160L-8	7.5	720	85	0.75	29.41	17.0	9.8	1.9	2.2	1.2	6	68

Type	Brake Type K	Brake Torque Nm	Brake Rated Power W	J Brake Pd ² Kgm ²	No. of Starts/hr. Under No Load	Delayed Cut-in Time ★ Msec.	Quick Cut-in Time Msec.	Cut Out Time Msec.	Noise dB(A)
63 TECA-BM	K 1	5	15	0.00005	3000	45	20	10	50
71 TECA-BM	K 2	12	20	0.00014	3000	50	30	15	50
80 TECA-BM	K 3	16	25	0.00021	1300	55	30	15	52
90 S TECA-BM	K 4	20	30	0.00039	1100	65	40	15	56
●90 S TECA-BM	K 4 D	40	30	0.00078	1100	65	40	15	56
90 L TECA-BM	K 4	20	30	0.00039	1100	65	40	15	56
●90 L TECA-BM	K 4 D	40	30	0.00078	1100	65	40	15	56
100 L TECA-BM	K 5	40	45	0.00104	900	75	45	20	59
●100 L TECA-BM	K 6	60	50	0.00135	900	180	85	25	59
112 MT TECA-BM	K 5	40	45	0.00104	880	75	45	20	61
112 M TECA-BM	K 6	60	50	0.00135	880	180	85	25	61
132 S TECA-BM	K 7	90	55	0.00219	480	200	95	50	64
●132 S TECA-BM	K 7 D	180	55	0.00438	480	200	95	50	64
132 M TECA-BM	K 7	90	55	0.00219	450	200	95	50	64
●132 M TECA-BM	K 7 D	180	55	0.00438	480	200	95	50	64
160 MT TECA-BM	K 7 D	180	55	0.00438	350	200	95	50	68
160 L TECA-BM	K 8	200	60	0.00408	350	210	100	60	68
●160 L TECA-BM	K 8 D	400	60	0.00816	350	210	100	60	68

● Motor with increased braking torque on request

★ On request, delayed brake cut in time for lifting equipment. We suggest double disk brake D for lifting equipment.

Direct Current Brake Series CC

OPERATING PRINCIPLE

The direct current brake is fed by means of an electronic circuit with diode bridge (rectifier) situated inside the terminal-box. When feeding the electromagnet (5), the movable anchor (4) is attracted towards the same, thus loading the braking torque springs (9) and allowing the disk (2), equipped with friction pad and fitted on the gear hub (6) to turn solely the motor shaft (1) by means of a key (7). By interrupting the feeding, the movable anchor (4), pushed by the braking torque springs (9), exerts a pressure upon the friction surface of the disk (2), thus causing it to stop.

ADJUSTMENT OF THE AIR GAP

The air gap (11) is the distance between the electromagnet (5) and the movable anchor (9).

The air gap has to be regularly checked, since due to the wear of the friction pad (2) it tends to increase.

Act on the brake adjusters (3) after loosening the screws (8) to bring the air gap to the required value.

Act on the ring nut (10) which acts on the braking torque springs (9) to adjust the braking torque.

Pls. contact our technical department for information on the air gap adjustment values.

HANDRELEASE WITH LEVER

Up on request a hand release with lever can be supplied.

In case of a current cutoff, acting on the lever (12), the release, connected to the movable anchor (4) overcomes the springs pressure, thus detaching the movable anchor from the disc friction packing (2) allowing the shaft to turn.

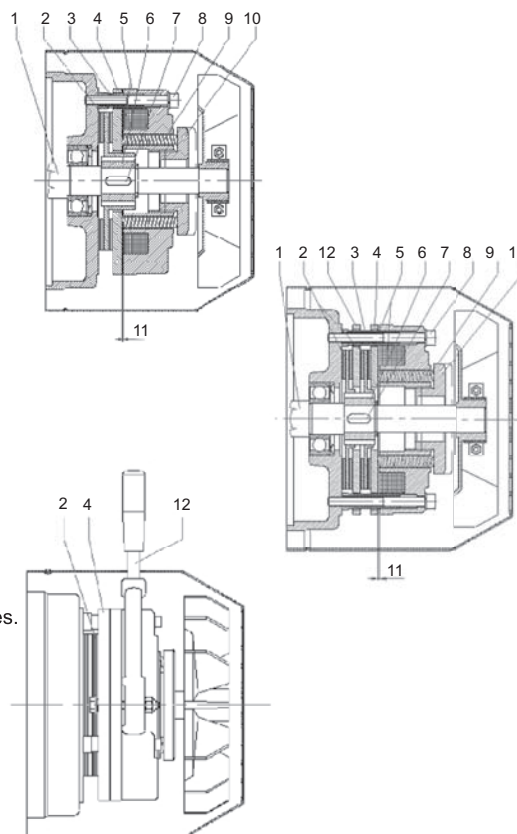

TECA-BM Brake Motors B3 63-160 Frame

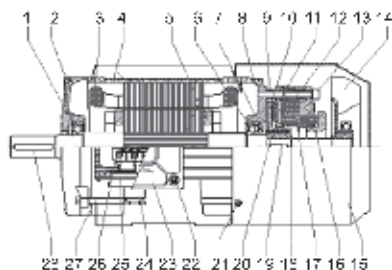

TECA-BM Brake Motors B5 63-160 Frame

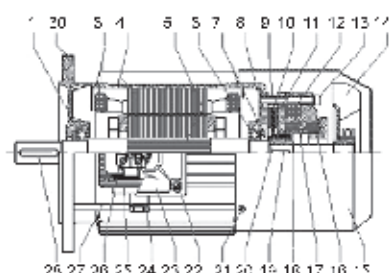

SPARE PARTS

1. Front bearing
2. Front shield
3. Winding
4. Frame with stator package
5. Shaft with rotor
6. Rear bearing
7. Spring
8. Rearshield
9. Adjusting bush
10. Brake disc
11. Moving anchor
12. Electromagnet coil with diode
13. Fixing screws for brake
14. Cooling fan
15. Fan cowl
16. Ring nut
17. Spring
18. See gearing
19. Key brake side
20. Toothed pinion
21. Fixing screw for fan cowl
22. Fixing screw for terminal-box
23. Terminal-box
24. Cable gland
25. Packing
26. Terminal-block
27. Tie-bolt
28. Shaft key
29. Fixing screw for shield

ASYNCHRONOUS THREE-PHASE BRAKE MOTORS with direct current 63~160 Type C FECCL Frame B3 Sizes 63~160, Type FC FECCL Frame B5 Sizes 63~160 Enclosed construction -External ventilation

MSC/MYC Series

Three/Single-Phase Aluminum Housing Saw Motors



MSC/MYC Series Motors Technical Data

Type	Power (KW)	Phase	V/Hz	Current (A)	Eff. (%)	Power Factor (CosΦ)	Speed (r/min)	T _{st} /T _n (Times)	T _{max} /T _n (Times)	I _{st} /I _n (Times)	Duty	Capacitor
MYC58A2	1.1	1	230/50	7.18	68	0.98	2770	0.35	1.7	5	S6-40%	25uF/450V
MYC58B2	1.5	1	230/50	9.51	70	0.98	2790	0.35	1.7	5	S6-40%	30uF/450V
MYC58C2	1.8	1	230/50	11.1	72	0.98	2790	0.32	1.7	5	S6-40%	30uF/450V
MYC63B2	2.2	1	230/50	13.2	74	0.98	2800	0.32	1.7	5	S6-40%	40uF/450V
MSC58A2	1.5	3	400/50	3.41	77.5	0.82	2750	3	3	6	S6-40%	
MSC58B2	2.2	3	400/50	4.76	78.5	0.85	2750	3	3	6	S6-40%	
MSC63A2	2.2	3	400/50	4.73	79	0.85	2800	2.4	2.2	6	S6-40%	
MSC63B2	3	3	400/50	6.37	80	0.85	2820	2.8	2.4	6.5	S6-40%	
MSC74A2	4	3	400/50	8.19	82	0.86	2850	3	3	7	S6-40%	
MSC81A2	5.5	3	400/50	10.5	85	0.89	2880	3	3	9	S1	
MSC81B2	7.5	3	400/50	14.1	86	0.89	2880	3	3	9	S1	
MSC93A2	5.5	3	400/50	10.1	87	0.90	2890	3	3	9	S1	
MSC93B2	7.5	3	400/50	13.6	87.5	0.91	2890	3	3	9	S1	

MSC/MYC Series Three/Single-Phase Aluminum Housing Saw Motors

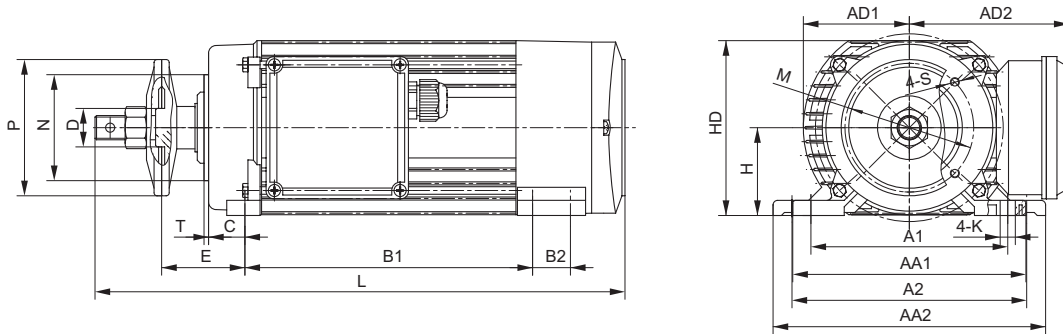

MSC/MYC Series Motors Overall & Installation Dimensions

Model	H	D	P	N	M	S	A1	A2	B1	B2	C	E	T	K	AA1	AA2	HD	AD1	AD2	L*
MYC58A2	58	25.4	90	70	85	M6	130	155	165	25	24	55	3	10	154	180	116	70	113	325
MYC58B2	58	25.4	90	70	85	M6	130	155	190	25	24	55	3	10	154	180	116	70	113	350
MYC58C2	58	25.4	90	70	85	M6	130	155	190	25	24	55	3	10	154	180	116	70	113	350
MYC63B2	63	25.4	90	80	100	M6	130	155	190	28	24	55	3	10	154	180	126	77	108	355
MSC58A2	58	25.4	90	70	85	M6	130	155	165	25	24	55	3	10	154	180	116	70	103	325
MSC58B2	58	25.4	90	70	85	M6	130	155	190	25	24	55	3	10	154	180	116	70	103	350
MSC63A2	63	25.4	90	80	100	M6	130	155	165	28	24	55	3	10	154	180	126	77	108	330
MSC63B2	63	25.4	90	80	100	M6	130	155	190	28	24	55	3	10	154	180	126	77	108	355
MSC74A2	74	30	110	95	115	M6	155	155	190	25	24	55	3	12	180	180	147	87	126	370
MSC81A2	81	40	158	110	130	M8	160	190	254	20	25	64	3.5	12	190	225	162	99	133	462
MSC81B2	81	40	158	110	130	M8	160	190	318	20	25	64	3.5	12	190	225	162	99	133	526
MSC93A2	93	40	158	110	130	M8	190	190	229	25	25	64	3.5	14	225	225	184	108	145	442
MSC93B2	93	40	158	110	130	M8	190	190	254	25	25	64	3.5	14	225	225	184	108	145	467

* Note: The size "L" With brake type is 30mm more

MSV/MYV Series

Three/Single-Phase Aluminum Housing Pad Mount Motors



MYV Series Technical Data (at 230V/50Hz)

Model	Power (KW)	Current (A)	Speed (r/min)	Eff. (%)	Power Factor (CosΦ)	T _{st} /T _n (Times)	T _{max} /T _n (Times)	Starting Current (A)	Run Capacitor (μF/V)	Noise dB(A)	W.T (Kg)
MYV711-2	0.37	2.60	2780	67	0.93	0.5	1.65	10	12μF/450V	75	5.6
MYV712-2	0.55	3.50	2790	73	0.95	0.5	1.8	15	16μF/450V	75	6.95
MYV713-2	0.75	4.50	2810	74	0.97	0.48	1.8	20	25μF/450V	75	8.15
MYV801-2	0.75	4.40	2810	74	0.98	0.4	1.8	19	25μF/450V	75	8.5
MYV802-2	1.1	6.30	2810	75	0.98	0.4	1.8	30	35μF/450V	78	11
MYV803-2	1.5	8.50	2810	77	0.98	0.33	1.8	40	40μF/450V	80	12.75
MYV90S-2	1.5	8.40	2820	77	0.98	0.33	1.72	35	45μF/450V	80	13.7
MYV90L-2	2.2	12.10	2850	78	0.98	0.29	1.8	61	60μF/450V	80	16.7
MYV100L-2	3	16.50	2860	79	0.99	0.28	1.8	73	80μF/450V	83	23.1
MYV711-4	0.25	1.80	1390	61	0.96	0.5	1.6	5	14μF/450V	65	5.8
MYV712-4	0.37	2.70	1390	62	0.96	0.5	1.6	8	16μF/450V	68	6.9
MYV713-4	0.55	3.70	1390	64	0.97	0.48	1.7	12	20μF/450V	70	8.25
MYV801-4	0.55	3.50	1410	64	0.98	0.37	1.8	13	25μF/450V	70	9.55
MYV802-4	0.75	4.70	1410	68	0.98	0.37	1.65	17	30μF/450V	70	10.45
MYV90S-4	1.1	6.30	1410	71	0.98	0.35	1.75	24	40μF/450V	73	13.1
MYV90L-4	1.5	8.50	1420	73	0.96	0.33	1.8	36	45μF/450V	75	16.45
MYV100L1-4	2.2	12.90	1440	77	0.96	0.32	1.8	57	80μF/450V	78	22.8
MYV711-6	0.18	1.49	920	57	0.92	0.45	1.5	4	16μF/450V	68	6.3
MYV712-6	0.25	2.00	920	59	0.92	0.45	1.5	5	20μF/450V	68	7.6
MYV801-6	0.37	2.78	920	63	0.92	0.35	1.6	8	20μF/450V	68	9
MYV802-6	0.55	3.90	920	66	0.93	0.35	1.6	14	25μF/450V	70	11.6
MYV90S-6	0.75	5.05	920	68	0.95	0.35	1.6	16	35μF/450V	70	13.5
MYV90L-6	1.1	7.30	920	69	0.95	0.35	1.6	25	50μF/450V	70	16.2

MSV Series Technical Data at 50Hz

Model	Power (KW)	Current (A)			Current (A)			Current (A)			Speed (r/min)	Eff. (%)	Power Factor (CosΦ)	T _{st} /T _n (Times)	T _{max} /T _n (Times)	I _{st} /I _n (Times)	Noise dB(A)	W.T (Kg)	Moment Of Inertia (Kg·M ²)	Rated Torque (N.M)
		220V	380V	660V	230V	400V	690V	240V	415V	720V										
MSV711-2	0.37	1.76	1.02	0.59	1.67	0.97	0.56	1.61	0.93	0.54	2730	70	0.79	2.2	2.4	6	64	5.6	0.00034	1.30
MSV712-2	0.55	2.57	1.49	0.86	2.45	1.42	0.82	2.36	1.36	0.79	2760	71	0.79	2.2	2.4	6	64	6.1	0.00042	1.90
MSV713-2	0.75	3.33	1.93	1.11	3.18	1.83	1.06	3.06	1.77	1.02	2730	72	0.82	2.2	2.4	6	65	7	0.00054	2.63
MSV801-2	0.75	3.21	1.86	1.07	3.06	1.77	1.02	2.94	1.70	0.98	2770	73	0.84	2.2	2.4	6	67	9.1	0.00083	2.59
MSV802-2	1.1	4.56	2.64	1.52	4.35	2.51	1.45	4.18	2.42	1.39	2770	76.2	0.83	2.2	2.4	6	67	10.2	0.00097	3.79
MSV803-2	1.5	6.04	3.50	2.01	5.87	3.32	1.92	5.54	3.20	1.85	2800	78.5	0.83	2.2	2.4	6	70	11.7	0.00125	5.12
MSV90S-2	1.5	5.97	3.46	1.99	5.76	3.28	1.90	5.47	3.16	1.82	2840	78.5	0.84	2.2	2.4	6	72	12	0.00136	5.05
MSV90L1-2	2.2	8.39	4.85	2.80	8.0	4.61	2.66	7.69	4.45	2.56	2840	81	0.85	2.2	2.4	6	72	15	0.0017	7.40
MSV90L2-2	3	11.08	6.42	3.69	10.56	6.10	3.52	10.16	5.88	3.39	2840	82.6	0.86	2.2	2.4	6	74	18.5	0.0021	10.09
MSV100L1-2	3	10.96	6.34	3.65	10.44	6.03	3.48	10.04	5.81	3.35	2840	82.6	0.87	2.2	2.3	7	76	22.3	0.0036	10.09
MSV100L2-2	4	14.33	8.30	4.78	13.65	7.88	4.55	13.14	7.60	4.38	2850	84.2	0.87	2.2	2.3	7.5	77	25.2	0.0044	13.41
MSV112M-2	4	14.33	8.30	4.78	13.65	7.88	4.55	13.14	7.60	4.38	2880	84.2	0.87	2.2	2.3	7.5	77	26.7	0.0054	13.27
MSV112L-2	5.5	19.14	11.08	6.38	18.23	10.53	6.08	17.54	10.15	5.85	2880	85.7	0.88	2.2	2.3	7.5	78	30.2	0.0068	18.25
MSV711-4	0.25	1.52	0.88	0.51	1.45	0.84	0.48	1.39	0.81	0.46	1350	60	0.72	2.2	2.4	6	55	5.4	0.00051	1.77
MSV712-4	0.37	2.02	1.17	0.67	1.92	1.11	0.64	1.85	1.07	0.62	1370	65	0.74	2.2	2.4	6	55	6.2	0.00081	2.58
MSV713-4	0.55	2.92	1.69	0.97	2.78	1.60	0.93	2.67	1.55	0.89	1380	66	0.75	2.2	2.4	6	57	7.3	0.00092	3.81
MSV801-4	0.55	2.87	1.66	0.96	2.74	1.58	0.91	2.63	1.52	0.88	1370	67	0.75	2.2	2.4	6	58	9	0.00128	3.84
MSV802-4	0.75	3.50	2.03	1.17	3.34	1.93	1.11	3.21	1.86	1.07	1380	72	0.78	2.2	2.4	6	58	10	0.0015	5.19
MSV803-4	1.1	4.86	2.81	1.62	4.63	2.67	1.54	4.45	2.57	1.48	1390	76.2	0.78	2.2	2.4	6	60	12.3	0.00184	7.56
MSV90S-4	1.1	4.80	2.78	1.60	4.57	2.64	1.52	4.40	2.54	1.47	1400	76.2	0.79	2.2	2.4	6	61	12.1	0.00221	7.51
MSV90L1-4	1.5	6.27	3.63	2.09	5.97	3.45	1.99	5.75	3.32	1.92	1400	78.5	0.8	2.2	2.4	6	61	14.6	0.00284	10.24
MSV90L2-4	2.2	8.91	5.16	2.97	8.45	4.90	2.83	8.17	4.72	2.72	1400	81	0.8	2.2	2.4	7	63	18.3	0.0037	15.02
MSV100L1-4	2.2	8.80	5.09	2.93	8.38	4.84	2.79	8.07	4.66	2.69	1420	81	0.81	2.2	2.3	7	64	21	0.0058	14.80
MSV100L2-4	3	11.77	6.81	3.92	11.21	6.47	3.74	10.79	6.24	3.60	1420	82.6	0.81	2.2	2.3	7	64	24.7	0.0073	20.19
MSV100L3-4	4	15.20	8.80	5.07	14.18	8.36	4.83	13.94	8.06	4.65	1430	84.2	0.82	2.2	2.3	7	65	29	0.0092	26.73
MSV112M-4	4	15.02	8.70	5.01	14.31	8.26	4.77	13.77	7.96	4.59	1430	84.2	0.83	2.2	2.2	7	65	30.5	0.0107	26.73
MSV112L-4	5.5	20.29	11.75	6.76	19.33	11.16	6.44	18.60	10.76	6.20	1440	85.7	0.83	2.2	2.2	7	68	34.8	0.013	36.49
MSV711-6	0.18	1.28	0.74	0.43	1.22	0.70	0.41	1.17	0.68	0.39	880	56	0.66	1.6	1.7	4	52	6	0.00083	1.95
MSV712-6	0.25	1.59	0.92	0.53	1.51	0.87	0.50	1.46	0.84	0.49	900	59	0.7	2.1	2.2	4	52	6.5	0.00095	2.65
MSV713-6	0.37	2.31	1.34	0.77	2.2	1.27	0.73	2.11	1.22	0.70	890	61	0.69	2	2.1	4	54	7.2	0.00114	3.97
MSV801-6	0.37	2.24	1.30	0.75	2.13	1.23	0.71	2.05	1.19	0.68	900	62	0.7	1.9	1.9	4	56	8.2	0.00153	3.93
MSV802-6	0.55	2.99	1.73	1.00	2.85	1.65	0.95	2.74	1.59	0.91	900	67	0.72	2	2.3	4	56	9.9	0.00232	5.84
MSV803-6	0.75	4.02	2.33	1.34	3.83	2.21	1.28	3.69	2.13	1.23	900	68	0.72	2	2.3	4	58	11.3	0.00286	7.96
MSV90S-6	0.75	3.96	2.29	1.32	3.77	2.18	1.26	3.63	2.10	1.21	920	69	0.72	2.2	2.2	5.5	59	11.7	0.00376	7.79
MSV90L1-6	1.1	5.49	3.18	1.83	5.23	3.02	1.74	5.03	2.91	1.68	925	72	0.73	2.2	2.2	5.5	59	15.1	0.00467	11.36
MSV90L2-6	1.5	7.19	4.16	2.40	6.88	3.97	2.29	6.59	3.81	2.20	930	73	0.75	2.2	2.2	6	61	18	0.00567	15.41
MSV100L1-6	1.5	7.00	4.05	2.33	6.67	3.85	2.22	6.42	3.71	2.14	945	74	0.76	2.2	2.2	6	61	19.1	0.0073	15.17
MSV100L2-6	2.2	9.87	5.71	3.29	9.40	5.44	3.13	9.04	5.23	3.01	950	77	0.76	2.2	2.2	6	63	23.4	0.0084	22.13
MSV112M-6	2.2	9.74	5.64	3.25	9.28	5.36	3.09	8.93	5.16	2.98	955	78	0.76	2.2	2.2	6	64	25.4	0.013	22.01
MSV112L-6	3	13.28	7.69	4.43	12.7	7.31	4.24	12.17	7.04	4.06	955	78	0.76	2.2	2.2	6	69	30	0.019	30.02

MSV/MYV Series Motors Overall & Installation Dimensions

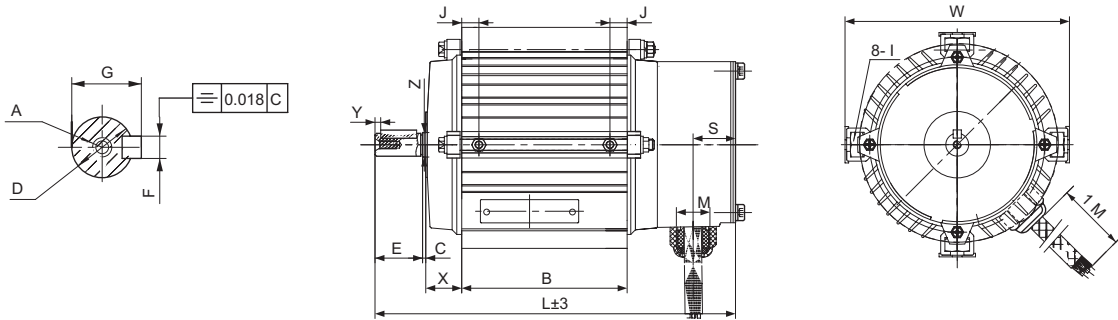

MYV Series Motors Overall & Installation Dimensions

Model	Power (KW)	A	B	C	D	E	F	G	Y	Z	W	I	J	L	X	M	S														
MYV711-2	0.37	M5X10	115	2	Φ14	30	5	16	4.5	Φ14.85	147	M10	11	235	26	M16	22														
MYV712-2	0.55		135											255																	
MYV713-2	0.75		155											275																	
MYV711-4	0.25		120											240																	
MYV712-4	0.37		140											260																	
MYV713-4	0.55		160											280																	
MYV711-6	0.18		135											255																	
MYV712-6	0.25		150											270																	
MYV801-2	0.75	M6X12	125	2	Φ19	40	6	21.5	7	Φ19.85	173	M12	13	267	30	M16	26														
MYV802-2	1.1		145											287																	
MYV803-2	1.5		165											307																	
MYV801-4	0.55		130											272																	
MYV802-4	0.75		145											287																	
MYV801-6	0.37		140											282																	
MYV802-6	0.55		165											307																	
MYV90S-2	1.5		150											320																	
MYV90L-2	2.2	180	350																												
MYV90S-4	1.1	M6X12	155	8	Φ24	50	8	27	4	Φ24.85	191	M12	13	325	35	M16	28														
MYV90L-4	1.5		185											355																	
MYV90S-6	0.75		155											325																	
MYV90L-6	1.1		195											365																	
MYV100L-2	3		M8X16											175				8	Φ28	60	8	31	4	Φ29.7	211	M12	13	356	27	M20	28
MYV100L-4	2.2													175														356			

MSV Series Motors Overall & Installation Dimensions

Model	Power (KW)	A	B	C	D	E	F	G	Y	Z	W	I	J	L	X	M	S
MSV711-2	0.37	M5X10	110	2	Φ14	30	5	16	4.5	Φ14.85	147	M10	11	230	26	M16	22
MSV712-2	0.55		125											245			
MSV713-2	0.75		140											260			
MSV711-4	0.25		110											230			
MSV712-4	0.37		125											245			
MSV713-4	0.55		145											265			
MSV711-6	0.18		125											245			
MSV712-6	0.25		135											255			
MSV713-6	0.37		155											275			
MSV801-2	0.75		M6X12											120			
MSV802-2	1.1	135		272													
MSV803-2	1.5	155		292													
MSV801-4	0.55	115		252													
MSV802-4	0.75	135		272													
MSV803-4	1.1	155		292													
MSV801-6	0.37	115		252													
MSV802-6	0.55	135		272													
MSV803-6	0.75	155		292													
MSV90S-2	1.5	M6X12		140	8	Φ24	50	8	27	4	Φ24.85	191	M12	13	310	35	M16
MSV90L1-2	2.2		170	340													
MSV90L2-2	3		200	370													
MSV90S-4	1.1		135	305													
MSV90L1-4	1.5		160	330													
MSV90L2-4	2.2		195	365													
MSV90S-6	0.75		135	305													
MSV90L1-6	1.1		170	340													
MSV90L2-6	1.5		200	370													
MSV100L1-2	3		M8X16	150											8		
MSV100L2-2	4	175		356													
MSV100L1-4	2.2	150		331													
MSV100L2-4	3	175		356													
MSV100L3-4	4	210		391													
MSV100L1-6	1.5	150		331													
MSV100L2-6	2.2	185		366													
MSV112M-2	4	M8X16		165	4	Φ28	60	8	31	4	Φ29.7	211	M12	13		337	28
MSV112L-2	5.5		190	362													
MSV112M-4	4		190	362													
MSV112L-4	5.5		220	392													
MSV112M-6	2.2		165	337													
MSV112L-6	3		200	372													

TECC

Series Three-Phase Induction Motors Cast Iron Housing

Multi-mount from 80 to 200 frame

• Frame size	H63~355
• Power	0.12~315KW
• Synchronous speed	3000; 1500; 1000; 750RPM
• Voltage	230/400V; 400/690V
• Frequency	50Hz、60Hz
• Protection class	IP55
• Insulation class	F
• Ambi temperature	-30~+40°C
• Altitude above sea level	≤1000m













- See Table 1 for the mounting arrangements and respective frame numbers
- See Table 2 for the bearings
- See Table 3-4 for the technical data
- See Table 5-8 for the types and mounting dimensions



Mounting Arrangements

The commonly used mounting arrangements and the corresponding frame numbers are shown in table 1

Table 1

Frame No.	Basic			Variations								
	B3	B5	B35	Based On B5			Based On B3			Based On B35		
				V1	V3	V5	V6	B6	B7	B8	V15	V36
												
H80~160	✓	✓	✓	✓	✓	✓	✓	✓	✓	✓	✓	✓
H180~225	✓	✓	✓	✓	—	—	—	—	—	—	—	—
H250~355	✓	—	✓	✓	—	—	—	—	—	—	—	—

Bearings

Table 2

Frame No.	Drive End		Non-drive End		Cable Glands
	2P	4,6,8P	2P	4, 6, 8P	
63	6201ZZ		6201ZZ		1*M20*1.5
71	6202ZZ		6201ZZ		1*M20*1.5
80	6204ZZ		6204ZZ		1*M20*1.5
90	6205ZZ		6205ZZ		1*M25*1.5
100	6206ZZ		6206ZZ		1*M25*1.5
112	6306ZZ		6306ZZ		2*M25*1.5
132	6308ZZ		6308ZZ		2*M32*1.5
160	6309C3		6309C3		2*M32*1.5
180	6311C3		6311C3		2*M40*1.5
200	6312C3		6312C3		2*M40*1.5
225	6313C3		6312C3		2*M40*1.5
250	6314C3		6313C3		2*M40*1.5
280	6314C3	6317C3	6314C3	6314C3	2*M63*1.5
315	6317C3	NU319	6317C3	6319C3	2*M63*1.5
355	6319C3	NU322	6319C3	6322C3	2*M63*1.5

T ECC Series Technical Data (at 400V)

Table 3

Model	Rated output (kW)	At full load				Locked current	Locked torque	Max torque	Net weight (kg)	Noise level dB(A)	
		Speed (r/min)	Current (A)	Eff. (%)	Power factor (cos φ)	Rated current	Rated torque	Rated torque		I	II
Synchronous Speed 3000r/min 50Hz											
63M1	0.18	2730	0.5	65	0.80	5.5	2.2	5	61	63	
63M2	0.25	2800	0.7	68	0.81						
71M1	0.37	2760	1.0	70		0.82	6.1	7.8	64	66	
71M2	0.55	2800	1.4	73							
80M1	0.75	2830	1.8	75	0.83	7	16	67	69		
80M2	1.1		2.5	77							
90S	1.5	2840	3.3	79	0.84	2.2	22	72	74		
90L	2.2		4.6	81							
100L	3	2860	6.0	83	0.87	7.5	33	76	78		
112M	4	2880	7.7	85	0.88						
132S1	5.5	2900	10.5	86		0.89	2.3	45	77	79	
132S2	7.5		14.1	87							
160M1	11	2930	20.3	88	0.90	2	117	86	88		
160M2	15		27.3	89							
160L	18.5		33	90							
180M	22	2940	39.2	90	0.91	7.1	180	89	91		
200L1	30	2950	52.8	91.2							
200L2	37		64.5	92	0.92	1.8	240	92	94		
225M	45	2970	78.2	92.3							
250M	55		95.4	92.5							
280S	75		129.3	93							
280M	90	152.2	93.8	0.91	2	309	94	96			
315S	110	185.6	94								
315M	132	221.6	94.5	0.92	1.8	1080	96	98			
315L1	160	265.4	94.6								
315L2	200	331.0	94.8	7.1	2.2	1160	99	101			
355M	250	411.6	95.3								
355L	315	517.0	95.6	0.92	1.6	1190	103	105			
							1760				
							1850				
Synchronous Speed 1500r/min 50Hz											
63M1	0.12	1320	0.4	57	0.72	4.4	2.1	5.2	52	57	
63M2	0.18		0.6	60	0.73						
71M1	0.25	1350	0.8	65	0.74	5.2	2.2	7	55	60	
71M2	0.37	1340	1.1	67	0.75						
80M1	0.55	1390	1.5	71	0.76	2.4	17	58	63		
80M2	0.75		2.0	73							
90S	1.1	1390	2.8	75	0.77	6	22	61	66		
90L	1.5		3.5	78	0.79						
100L1	2.2	1410	4.9	80	0.81	2.3	34	64	69		
100L2	3		6.5	82							
112M	4	1440	8.4	84	0.82	7	43	65	70		
132S	5.5	1440	11.3	85						0.83	
132M	7.5		14.8	87	0.84	2.3	68	71	76		
160M	11	21.5	88								
160L	15	1460	30.1	89	0.85	7.5	123	75	80		
180M	18.5	34.3	90.5								
180L	22	1470	40.6	91	0.86	2.2	144	76	80		
200L	30		54.7	92							
225S	37	1480	66.4	92.5	0.87	7.2	182	79	83		
225M	45		80.5	92.8							
250M	55		98.1	93							
280S	75	132.7	93.8	0.88	2.3	190	81	84			
280M	90	158.5	94.2								
315S	110	191.0	94.5	0.89	6.9	2.1	270	83	85		
315M	132	228.4	94.8								
315L1	160	273.4	94.9	0.90	2.2	284	86	89			
315L2	200	334.4	95								
355M	250	420.7	95.3	0.90	2.2	320	86	89			
355L	315	528.4	95.6								
							667				
							1000				
							1100				
							1160				
							1270				
							1700				
							1850				

T ECC Series Technical Data (at 400V)

Table 4

Model	Rated output (KW)	At full load				Locked current Rated current	Locked torque Rated torque	Max torque Rated torque	Net weight (kg)	Noise level dB(A)	
		Speed (r/min)	Current (A)	Eff. (%)	Power factor (cos φ)					I	II
Synchronous Speed 1000r/min 50Hz											
71M1	0.18	870	0.7	56	0.66	4.00	1.90	2.00	7	52	59
71M2	0.25	870	0.9	59	0.68				8		
80M1	0.37	890	1.3	62	0.70	4.70	1.90	2.00	17	54	61
80M2	0.55		1.7	65	0.72				19		
90S	0.75	910	2.2	69	0.73	5.50	2.00	2.00	23	57	64
90L	1.1		3.0	72					0.75		
100L	1.5	920	3.8	76	0.75	6.50	2.10	2.10	33	61	68
112M	2.2	940	5.3	79	0.76				45		
132S	3	960	7.0	81	0.77	6.50	2.10	2.10	63	69	76
132M1	4		9.3	82					73		
132M2	5.5	970	12.3	84	0.78	7.00	2.00	2.00	84	73	80
160M	7.5		16.4	86					119		
160L	11	970	23.3	87.5	0.81	7.00	2.00	2.00	147	76	82
180L	15		30.0	89.0					195		
200L1	18.5	980	36.6	90.0	0.83	7.00	2.10	2.10	220	76	82
200L2	22		42.5	90.0					250		
225M	30	980	56.3	91.5	0.84	7.00	2.00	2.00	292	78	84
250M	37		67.5	92					408		
280S	45	990	81.7	92.5	0.86	7.00	2.10	2.00	536	80	85
280M	55		99.5	92.8					595		
315S	75	990	134.6	93.5	0.87	7.00	2.00	2.00	990	85	90
315M	90		161.1	93.8					1080		
315L1	110	990	196.1	94.0	0.88	7.00	1.90	1.90	1150	92	96
315L2	132		232.5	94.2					1210		
355M1	160	990	227.7	94.5	0.88	7.00	1.90	1.90	1600	92	96
355M2	200		346.4	94.7					1700		
355L	250	990	432.1	94.9	0.88	7.00	1.90	1800			
Synchronous Speed 750r/min 50Hz											
80M1	0.18	630	0.9	51.0	0.61	3.30	1.90	1.90	17	52	60
80M2	0.25	640	1.1	54.0					19		
90S	0.37	660	1.4	62.0	0.67	4.00	1.80	1.80	23	56	64
90L	0.55		2.1	63.0					25		
100L1	0.75	690	2.3	71.0	0.69	5.00	1.80	1.80	33	59	67
100L2	1.1		3.2	73.0					38		
112M	1.5	680	4.2	75.0	0.69	5.00	1.80	1.80	50	61	69
132S	2.2	710	5.8	78.0	0.71	6.00	1.90	1.90	63	64	72
132M	3		7.5	79.0					79		
160M1	4	720	9.8	81.0	0.73	6.00	1.90	2.00	118	68	76
160M2	5.5		12.9	83.0					119		
160L	7.5	730	16.9	85.5	0.75	6.60	1.90	2.00	145	70	78
180L	11		23.9	87.5					184		
200L	15	730	32.4	88.0	0.76	6.60	1.90	2.00	250	73	80
225S	18.5		39.1	90.0					266		
225M	22	740	45.0	90.5	0.78	6.60	1.90	2.00	292	75	82
250M	30		63.4	91.0					405		
280S	37	740	73.9	91.5	0.79	6.60	1.90	2.00	520	76	83
280M	45		89.4	92.0					592		
315S	55	740	105.6	92.8	0.81	6.60	1.80	1.80	1000	82	88
315M	75		143.7	93.0					1100		
315L1	90	740	168.9	93.8	0.82	6.40	1.80	1.80	1160	90	95
315L2	110		206.0	94.0					1230		
355M1	132	740	248.0	93.7	0.82	6.40	1.80	1.80	1600	90	95
355M2	160		299.0	94.2					1700		
355L	200	740	368.1	94.5	0.83	6.40	1.80	1800			

T ECC Series Mounting Dimensions

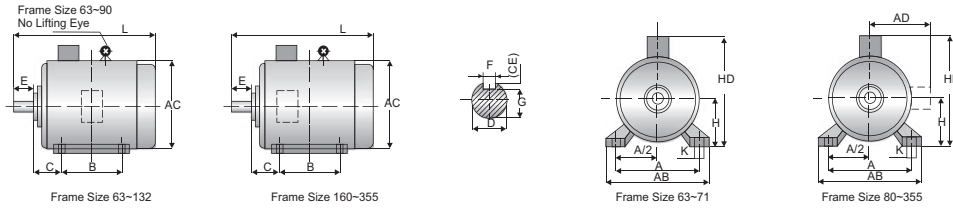

IM B3

Table 5

Frame No.	Poles	Mounting Dimensions & Tolerance											Frame Dimensions						
		A	A/2	B	C	D	E	F	G ¹⁾	H	K ²⁾	AB	AC	AD	HD	L			
63M	2,4	100	50	80	40	11	+0.008 -0.003	23	±0.26	4	8.5	63	7	135	130	70	180	230	
71M	2,4,6	112	56	90	45	14		30		5	11	71		150	145	80	195	255	
80M	2,4,6,8	125	62.5	100	50	19		40		6	15.5	80	+0.036 0	165	175	145	220	295	
90S				100	56	24		50	±0.31			20	10					320	
90L			140	70	125	56	24		50			20	90		180	195	155	250	345
100L			160	80	140	63	28	+0.009 -0.004	60		8	24	100		205	215	180	270	385
112M			190	95	140	70	28		60			24	112	0 -0.5	230	240	190	300	400
132S			216	108	140	89	38		80	±0.37		33	132		270	275	210	345	470
132M					178	89	38		80		10	33	132		270	275	210	345	510
160M			254	127	210	108	42	+0.018 +0.002	110		12	37	160	+0.430 0	320	330	255	420	615
160L					254	108	42		110		12	37	160		320	330	255	420	670
180M			279	139.5	241	121	48		110	±0.43	14	42.5	180		355	380	280	455	700
180L				279	121	48		110		14	42.5	180		355	380	280	455	740	
200L		318	159	305	133	55		110		16	49	200		395	420	305	505	770	
225S	4,8			286		60		140	±0.50	18	53		19					815	
225M	2	356	178	311	149	55		110	±0.43	16	49	225		435	470	335	560	820	
	4,6,8			311	149	60					53							845	
250M	2	406	203	349	168	65				18	58	250	0 -0.20	490	510	370	615	910	
	4,6,8			349	168	65				18	58	250	0 -1.0	490	510	370	615	910	
280S	2			368		75		140		20	67.5	280		550	580	410	680	985	
	4,6,8	457	228.5	368	190	75		140		20	67.5	280		550	580	410	680	985	
280M	2			419		65				18	58							1035	
	4,6,8	457	228.5	419	190	75				20	67.5							1035	
315S	2			406		65	+0.030 +0.011			18	58		+0.520 0					1185	
	4,6,8,10			406		80		170	±0.50	22	71							1215	
315M	2	508	254	457	216	65		140		18	58	315		635	645	530	845	1295	
	4,6,8,10			457	216	80		170		22	71			635	645	530	845	1325	
315L	2			508		65		140		18	58							1295	
	4,6,8,10			508		80		170		22	71							1325	
355M	2			560		75		140		20	67.5							1500	
	4,6,8,10			560		100	+0.035 +0.013	210		28	90	355		730	710	655	1010	1570	
355L	2	610	305	630	254	75	+0.030 +0.011	140		20	67.5							1500	
	4,6,8,10			630	254	100	+0.035 +0.013	210		28	90							1570	

T ECC Series Mounting Dimensions

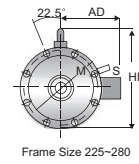
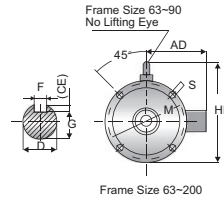
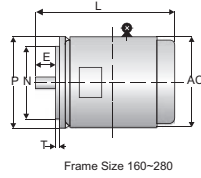
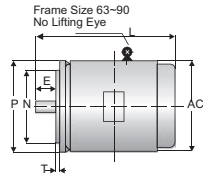

IM B5

Table 6

Frame No.	Poles	Mounting Dimensions & Tolerance											Frame Dimensions																	
		D	E	F	G ¹⁾	M	N	P ³⁾	R ⁴⁾	S	T	Holes No.	AC	AD	HF	L														
63M	2,4	11	23	4	8.5	115	95	140									130	70	130	230										
71M	2,4,6	14	30	5	11	130	110	160						10	3		145	80	145	255										
80M	2,4,6,8	19	40	6	15.5	165	130	200	±1.5	12	3.5	4	4	+0.360 0	0	0	175	145	185	295										
90S		24	50	8	20																215	180	250	±2.0	15	4	195	155	195	320
90L		28	60	8	24																215	180	250	±2.0	15	4	215	180	245	385
100L		38	80	10	33																265	230	300	±2.0	15	4	240	190	265	400
112M		42	110	12	37																300	250	350	±3.0	19	5	275	210	315	510
132S		48	140	14	42.5																350	300	400	±3.0	19	5	330	255	385	615
132M		55	170	16	49																400	350	450	±3.0	19	5	380	280	430	700
160M		65	200	18	58																450	400	500	±3.0	19	5	420	305	480	770
160L		75	230	20	67.5																500	450	550	±3.0	19	5	470	335	535	820
180M		85	260	22	76																550	500	600	±3.0	19	5	510	370	595	910
200L	96	290	24	85	600	550	650	±3.0	19	5	580	410	650	985																
225S	4,8	60	140	18	53																815									
225M	2	55	110	16	49	400	350	450									470	335	535	820										
	4,6,8	60			53																845									
250M	2	65		18	58												510	370	595	910										
	4,6,8	75			67.5																									
280S	2	75	140	±0.50	20	500	450	550	±4.0								580	410	650	985										
	4,6,8	85			67.5				±4.0																					
280M	2	85		18	58																	1035								
	4,6,8	95			67.5																									

T ECC Series Mounting Dimensions

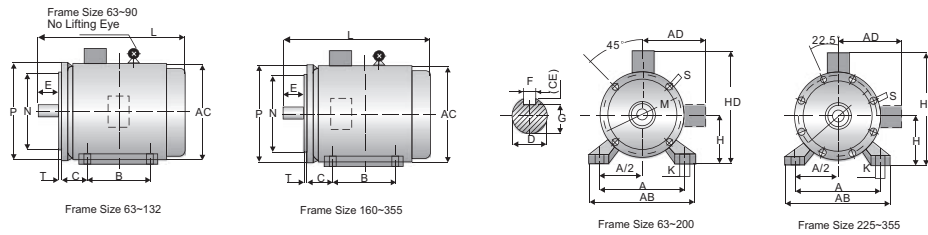

IM B35

Table 7

Frame No.	Poles	Mounting Dimensions & Tolerance																	Frame Dimensions									
		A	A/2	B	C	D		E	F	G ¹⁾		H	K ²⁾		M	N	P ³⁾	R ⁴⁾	S	T	Holes No.	AB	AC	AD	HD	L		
63M	2,4	100	50	80	40	11	^{+0.008} / _{-0.003}	23	± 0.260	4	8.5	63	7	115	95	± 0.013	140		10	± 0.36 / ₀	3	± 0.10	135	130	70	180	230	
71M	2,4,6	112	56	90	45	14	^{+0.008} / _{-0.003}	30	± 0.260	5	11	71		130	110	± 0.009	160						150	145	80	195	255	
80M	2,4,6,8	125	63	100	50	± 1.5	19	40	± 0.260	6	16	80	10	± 0.360 / ₀	165	130		200	± 1.5	12	3.5		165	175	145	220	295	
90S		140	70	100	56	24	^{+0.009} / _{-0.004}	50	± 0.310	8	20	90	12		165	130	± 0.014 / _{-0.011}	200		12			180	195	155	250	320	
90L		140	70	125	56	24	^{+0.009} / _{-0.004}	50	± 0.310	8	20	90	12		165	130	± 0.014 / _{-0.011}	200		12			180	195	155	250	345	
100L		160	80	140	63	28		60	± 0.310	8	24	100	12		215	180	± 0.014 / _{-0.011}	250			± 0.43 / ₀			205	215	180	270	385
112M		190	95	140	70	± 2.0		60	± 0.370	8	24	112	12	± 0.5	215	180	± 0.014 / _{-0.011}	250						230	240	190	300	400
132S		216	108	140	89	38		80	± 0.370	10	33	132	12		265	230	± 0.014 / _{-0.011}	300						270	275	210	345	470
132M		216	108	178	89	38		80	± 0.370	10	33	132	12		265	230	± 0.014 / _{-0.011}	300						270	275	210	345	510
160M		254	127	210	108	42	^{+0.018} / _{+0.002}	110	± 0.430	12	37	160	15		300	250	± 0.016 / _{-0.013}	350						320	330	255	420	615
160L		254	127	254	108	42	^{+0.018} / _{+0.002}	110	± 0.430	12	37	160	15		300	250	± 0.016 / _{-0.013}	350						320	330	255	420	670
180M		279	140	241	121	48	± 3.0	110	± 0.430	14	43	180	15		300	250	± 0.016 / _{-0.013}	350	± 3.0					355	380	280	455	700
180L	279	140	279	121	48	± 3.0	110	± 0.430	14	43	180	15		300	250	± 0.016 / _{-0.013}	350	± 3.0					355	380	280	455	740	
200L	318	159	305	133	55		110	± 0.430	16	49	200	15		350	300	± 0.016	400						395	420	305	505	770	
225S	4,8		286		60		140	± 0.500	18	53		19		400	350	± 0.018	450										815	
225M	2	356	178	149	55		110	± 0.430	16	53	225	19		400	350	± 0.018	450						435	470	335	560	820	
	4,6,8		311		60					49		19		400	350	± 0.018	450										845	
250M	2	406	203	168	65				18	58	250	19	± 1.0				400	0					490	510	370	615	910	
	4,6,8				65				18	58	250	19	± 1.0				400	0					490	510	370	615	910	
280S	2		368		75		140	± 0.500	20	68	280	24		500	450	± 0.020	550										985	
	4,6,8				75		140	± 0.500	20	68	280	24		500	450	± 0.020	550						550	580	410	680		
280M	2	457	229	190	65	^{+0.030} / _{+0.011}	140	± 0.500	18	58	280	24															1035	
	4,6,8,10				65	^{+0.030} / _{+0.011}	140	± 0.500	18	58	280	24															1035	
					75	^{+0.030} / _{+0.011}	140	± 0.500	20	68	280	24															1035	
315S	2		406		65	± 4.0	140	± 0.500	18	58		28															1185	
	4,6,8,10				65	± 4.0	140	± 0.500	18	58		28															1215	
					80	± 4.0	170	± 0.500	22	71		28															1295	
315M	2	508	254	216	65		140	± 0.500	18	58	315	28		600	550	± 0.022	660						635	645	530	845	1295	
	4,6,8,10				65		140	± 0.500	18	58	315	28		600	550	± 0.022	660						635	645	530	845	1325	
					80		170	± 0.500	22	71		28															1295	
315L	2		508		65		140	± 0.500	18	58		28															1295	
	4,6,8,10				65		140	± 0.500	18	58		28															1325	
					80		170	± 0.500	22	71		28															1325	
355M	2		560		75		140	± 0.500	20	68		28															1500	
	4,6,8,10				75		140	± 0.500	20	68		28															1570	
355L	2	610	305	254	100	^{+0.035} / _{+0.013}	210	± 0.500	28	90	355	28		740	680	± 0.025	800						730	710	655	1010	1570	
	4,6,8,10				75	^{+0.030} / _{+0.011}	140	± 0.500	20	68		28															1500	
					100	^{+0.035} / _{+0.013}	210	± 0.500	28	90		28															1570	

T ECC Series Mounting Dimensions

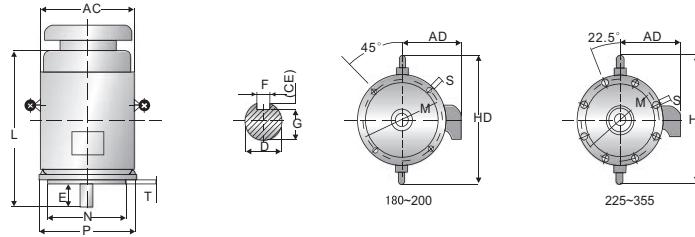

IM V1

Table 8

Frame No.	Poles	Mounting Dimensions & Tolerance													Frame Dimensions			
		D	E	F	G ¹⁾	M	N	P ³⁾	R ⁴⁾	S	T	Holes No.	AC	AD	HF	L		
180M	2,4,6,8	48	110	14	42.5	300	250	+0.016 -0.013	350	±3.0	0	-0.120	4	380	280	500	760	
180L		+0.018 +0.022															±0.430	0
200L	55			16	49	350	300	±0.016	400					420	305	550	840	
225S	4,8	60	140	±0.500	18	0	-0.043	53									905	
225M	2	55	110	±0.430	16			49									910	
	4,6,8	60						53									935	
250M	2	65	140	18	58	500	450	±0.020	550	19	5	0	0	510	370	650	1015	
	4,6,8																	
280S	2	75		20	0	-0.052	67.5										1110	
280M	4,6,8	75		18	0	-0.043	58							580	410	720	1150	
	2	65		20	0	-0.052	67.5			±4.0	+0.520 0							
315S	2	65	170	±0.500	18	0	-0.043	58				0	8				1280	
	4,6,8,10	80															22	0
315M	2	65	140		18	0	-0.043	58	600	550	±0.022	660		645	530	900	1310	
	4,6,8,10	80	170		22	0	-0.052	71									1430	
315L	2	65	140		18	0	-0.043	58			24	6					1310	
	4,6,8,10	80	170		22			71									1430	
355M	2	75	140		20			67.5									1640	
	4,6,8,10	95	+0.035 +0.013	170	25	0	-0.052	86	740	680	±0.025	800		710	655	1010	1670	
355L	2	75	+0.030 +0.011	140	20			67.5									1640	
	4,6,8,10	95	+0.035 +0.013	170	25			86									1670	

The note for: 1)The position tolerance for hole K is based on the axis of shaft extension.
 2)Dimension P is the maximum limit value.
 3)R is the distance from the matching surface of flange to the shoulder of shaft extension.

“ECOL” Motors

FEATURES

- Energy savings, high efficiency
- High starting torque, lower starting current
- Versatile and easy to modify design adapts to a variety of applications
- Option of integrated or removable feet
- Option of aluminum housing up to frame size 200
- Option of terminal box location (top, left or right)
- Option of IE2, IE3, MEPS High and Premium Efficiency for IEC standards + NEMA EPACT and Premium Efficiency
- Full use of the magnetization properties of cold rolled silicone steel in which the stator laminations are magnetized evenly to reduce temperature rise of the winding
- Dimensional interchangeability (same or shorter than many motors currently offered in the market)



APPLICATIONS

- Pumps
- Waste water treatment plants
- Air compressors, fans
- Gear reducers and power transmission
- Pulp and paper mills
- Steel mill
- Conveyors, elevators
- Material handling equipment
- Agricultural application
- Mining equipment
- Hydraulic equipment

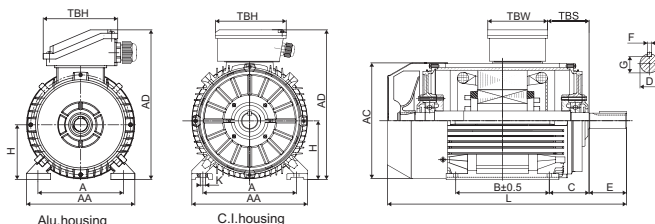

IM B3 Figure 1

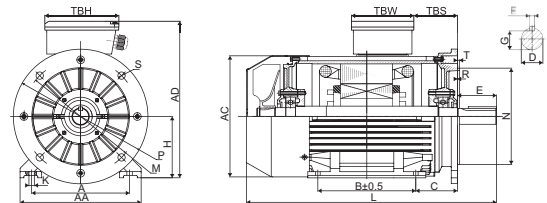

IM B35 Figure 2

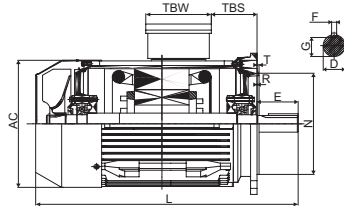
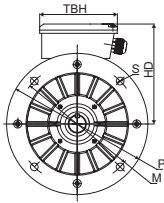

IM B5 Figure 3

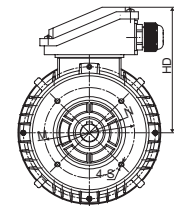
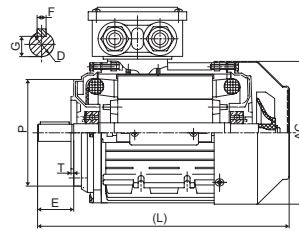

IM B14 Figure 4

Overall & Installation Dimensions

Frame	Foot Mounting				Shaft						General							
	H	A	B	C	D	E	F	G	K	AA	AD	HD	AC	L	TBS	TBW	TBH	
80	80	125	100	50	Φ19	40	6	15.5	Φ9	160	220	140	Φ158	280	16	97	97	
90S/L	90	140	100/125	56	Φ24	50	8	20	Φ10	175	240	150	Φ176	325/350	16	97	97	
100	100	160	140	63	Φ28	60	8	24	Φ12	200	265	165	Φ199	388	20	118	118	
112	112	190	140	70	Φ28	60	8	24	Φ12	230	291	179	Φ220	405	29	118	118	
132S/M	132	216	140/178	89	Φ38	80	10	33	Φ12	255	332	200	Φ259	467/505	29	118	118	
160M/L	160	254	210/254	108	Φ42	110	12	37	Φ15	314	402	242	Φ313	605/650	91	162	187	
180M/L	180	279	241/279	121	Φ48	110	14	42.5	Φ15	348	439	259	Φ360	687/725	160/180	162	187	
200L	200	318	305	133	Φ55	110	16	49	Φ19	388	497	297	Φ399	768	192	186	233	
225S	4,8	225	356	286	Φ60	140	18	53	Φ19	436	553	328	Φ465	814	190	186	233	
	2	225	356	311	Φ55	110	16	49	Φ19	436	553	328	Φ465	809	202	186	233	
225M	4,6,8	225	356	311	Φ60	140	18	53	Φ19	436	553	328	Φ465	839	202	186	233	
	2	250	406	349	Φ60	140	18	53	Φ24	484	616	366	Φ506	918	233	218	260	
250M	4,6,8	250	406	349	Φ65	140	18	58	Φ24	484	616	366	Φ506	918	233	218	260	
	2	280	457	368/419	Φ65	140	18	58	Φ24	557	668	388	Φ559	984/1035	265	218	260	
280S/M	4,6,8	280	457	368/419	Φ75	140	20	67.5	Φ24	557	668	388	Φ559	984/1035	265	218	260	
	2	315	508	406	Φ65	140	18	58	Φ28	630	840	525	Φ680	1160	130	350	430	
315S	4,6,8	315	508	406	Φ80	170	22	71	Φ28	630	840	525	Φ680	1190	130	350	430	
	2	315	508	457/508	Φ65	140	18	58	Φ28	630	840	525	Φ680	1310	130	350	430	
315M/L	4,6,8	315	508	457/508	Φ80	170	22	71	Φ28	630	840	525	Φ680	1340	130	350	430	
	2	355	610	560/630	Φ75	140	20	67.5	Φ28	740	920	565	Φ820	1770	180	350	430	
355M/L	4,6,8	355	610	560/630	Φ95	170	25	86	Φ28	740	920	565	Φ820	1840	180	350	430	

Frame	Bearings		Cable Gland	B5						B14						
	Drive End	Non-Drive End		N	M	P	S	T	R	N	M	P	S	T	R	
80	6204ZZ		1-M20×1.5	Φ130	Φ165	Φ198	4-Φ12	3.5	0	Φ80	Φ100	Φ118	M6	3	0	
90S/L	6205ZZ		1-M20×1.5	Φ130	Φ165	Φ198	4-Φ12	3.5	0	Φ95	Φ115	Φ138	M8	3	0	
100	6206ZZ		1-M20×1.5	Φ180	Φ215	Φ250	4-Φ15	4	0	Φ110	Φ130	Φ158	M8	3.5	0	
112	6306ZZ		2-M25×1.5	Φ180	Φ215	Φ250	4-Φ15	4	0	Φ110	Φ130	Φ158	M8	3.5	0	
132S/M	6308ZZ		2-M25×1.5	Φ230	Φ265	Φ300	4-Φ15	4	0	Φ130	Φ165	Φ198	M10	3.5	0	
160M/L	6309C3		2-M32×1.5	Φ250	Φ300	Φ350	4-Φ19	5	0						0	
180M/L	6311C3		2-M32×1.5	Φ250	Φ300	Φ350	4-Φ19	5	0						0	
200L	6312C3		2-M40×1.5	Φ300	Φ350	Φ400	4-Φ19	5	0						0	
225S	4,8	6313C3	2-M50×1.5	Φ350	Φ400	Φ450	8-Φ19	5	0						0	
225M	2			Φ350	Φ400	Φ450	8-Φ19	5	0							0
	4,6,8			Φ350	Φ400	Φ450	8-Φ19	5	0							0
250M	2	6314C3	2-M50×1.5	Φ400	Φ500	Φ550	8-Φ19	5	0						0	
	4,6,8			Φ400	Φ500	Φ550	8-Φ19	5	0						0	
280S/M	2	6316C3	2-M50×1.5	Φ400	Φ500	Φ550	8-Φ19	5	0						0	
	4,6,8			Φ400	Φ500	Φ550	8-Φ19	5	0						0	
315S/M/L	2	6314C3		2-M63×1.5	Φ550	Φ600	Φ660	8-Φ24	6	0					0	
	4,6,8	NU319	6319C3		Φ550	Φ600	Φ660	8-Φ24	6	0					0	
355M/L	2	6319C3		2-M63×1.5	Φ680	Φ740	Φ800	8-Φ24	6	0					0	
	4,6,8	NU322	6322C3		Φ680	Φ740	Φ800	8-Φ24	6	0					0	

IE1 Efficiency Motors Technical Data

Model	Power (KW)	Full Load Speed (r/min)	I _n 400V (A)	I _n 400V (A)	I _{st} /I _n (Times)	Eff. 100%FL (%)	Power Factor (CosΦ)	Full Load Torque (N.M)	T _{st} /T _n (Times)	T _{min} /T _n (Times)	T _{max} /T _n (Times)
2 Pole - 3000 rpm Synchronous Speed 50Hz											
TCA-1/TCC-1 801-2	0.75	2838	1.09	2.06	5	72.1	0.73	2.52	2.2	1.9	2.6
TCA-1/TCC-1 802-2	1.1	2836	1.54	2.90	5	75	0.73	3.70	2.2	1.8	2.6
TCA-1/TCC-1 90S-2	1.5	2842	1.98	3.79	5	77.2	0.74	5.04	2.2	1.8	2.5
TCA-1/TCC-1 90L-2	2.2	2835	2.39	5.04	5.5	79.7	0.79	7.41	2.2	1.8	2.5
TCA-1/TCC-1 100L-2	3	2841	2.97	6.56	5.5	81.5	0.81	10.08	2.3	1.9	2.6
TCA-1/TCC-1 112M-2	4	2900	3.88	8.58	6	83.1	0.81	13.17	2.4	1.9	2.6
TCA-1/TCC-1 132S1-2	5.5	2895	4.65	11.16	6	84.7	0.84	18.14	2.3	2	2.6
TCA-1/TCC-1 132S2-2	7.5	2900	5.98	14.81	6.4	86	0.85	24.70	2.3	2	2.7
TCA-1/TCC-1 160M1-2	11	2910	7.85	20.83	6.3	87.6	0.87	36.10	2.3	2	2.7
TCA-1/TCC-1 160M2-2	15	2908	10.57	28.06	6.8	88.7	0.87	49.26	2.3	2	2.7
TCA-1/TCC-1 160L-2	18.5	2912	11.69	33.60	7	89.3	0.89	60.67	2.3	2	2.7
TCA-1/TCC-1 180M-2	22	2920	13.81	39.69	7.2	89.9	0.89	71.95	2.3	2	2.6
TCA-1/TCC-1 200L1-2	30	2915	18.67	53.64	7	90.7	0.89	98.28	2.3	2	2.6
TCA-1/TCC-1 200L2-2	37	2920	22.90	65.80	7.2	91.2	0.89	121.00	2.3	2	2.7
TCC-1 225M-2	45	2920	26.21	78.70	7	91.7	0.90	147.16	2.3	2	2.7
TCC-1 250M-2	55	2930	35.47	97.85	7.8	92.2	0.88	179.25	2.2	1.9	2.5
TCC-1 280S-2	75	2930	45.66	131.22	7.8	92.7	0.89	244.44	2.1	1.9	2.5
TCC-1 280M-2	90	2930	51.68	155.21	7.7	93	0.90	293.32	2.1	1.9	2.5
TCC-1 315S-2	110	2940	62.97	189.09	7.7	93.3	0.90	357.29	2	1.8	2.3
TCC-1 315M-2	132	2940	71.12	223.93	7.6	93.5	0.91	428.74	2	1.8	2.3
TCC-1 315L1-2	160	2945	91.10	273.57	7.8	93.8	0.90	518.81	2	1.8	2.3
TCC-1 315L2-2	200	2945	120.08	345.07	7.9	94	0.89	648.51	2	1.8	2.3
TCC-1 355M-2	250	2945	142.04	426.54	7.8	94	0.90	810.64	2	1.8	2.3
TCC-1 355L-2	315	2945	189.13	543.48	7.8	94	0.89	1021.40	2	1.8	2.3
4 Pole - 1500 rpm Synchronous Speed 50Hz											
TCA-1/TCC-1 802-4	0.75	1410	1.03	2.00	5.4	72.1	0.75	5.08	2.2	1.9	2.6
TCA-1/TCC-1 90S-4	1.1	1415	1.32	2.71	5.3	75	0.78	7.42	2.2	1.8	2.6
TCA-1/TCC-1 90L-4	1.5	1410	1.74	3.60	5.5	77.2	0.78	10.16	2.2	1.8	2.5
TCA-1/TCC-1 100L1-4	2.2	1420	2.31	4.98	6	79.7	0.80	14.79	2.2	1.8	2.5
TCA-1/TCC-1 100L2-4	3	1420	3.08	6.64	6	81.5	0.80	20.17	2.3	1.9	2.6
TCA-1/TCC-1 112M-4	4	1425	3.74	8.47	6.3	83.1	0.82	26.81	2.4	1.9	2.6
TCA-1/TCC-1 132S-4	5.5	1420	4.85	11.29	6.5	84.7	0.83	36.99	2.3	2	2.6
TCA-1/TCC-1 132M-4	7.5	1420	5.98	14.81	6.4	86	0.85	50.44	2.3	2	2.7
TCA-1/TCC-1 160M-4	11	1430	8.61	21.32	6.8	87.6	0.85	73.46	2.3	2	2.7
TCA-1/TCC-1 160L-4	15	1435	10.06	27.74	6.7	88.7	0.88	99.82	2.3	2	2.7
TCA-1/TCC-1 180M-4	18.5	1435	12.32	33.98	7.2	89.3	0.88	123.11	2.3	2	2.7
TCA-1/TCC-1 180L-4	22	1450	15.29	40.60	7.3	89.9	0.87	144.89	2.3	2	2.6

IE1 Efficiency Motors Technical Data

Model	Power (KW)	Full Load Speed (r/min)	I _{nl} 400V (A)	I _n 400V (A)	I _{st} /I _n (Times)	Eff. 100%FL (%)	Power Factor (CosΦ)	Full Load Torque (N.M)	T _{st} /T _n (Times)	T _{min} /T _n (Times)	T _{max} /T _n (Times)
4 Pole - 1500 rpm Synchronous Speed 50Hz											
TCA-1/TCC-1 200L-4	30	1450	18.67	53.64	7.6	90.7	0.89	197.57	2.3	2	2.6
TCC-1 225S-4	37	1460	22.90	65.80	7.5	91.2	0.89	242.00	2.3	2	2.7
TCC-1 225M-4	45	1470	29.18	80.49	7.3	91.7	0.88	292.33	2.3	2	2.7
TCC-1 250M-4	55	1470	33.70	96.85	7.4	92.1	0.89	357.29	2.2	1.9	2.5
TCC-1 280S-4	75	1470	48.11	132.71	7.5	92.7	0.88	487.21	2.1	1.9	2.5
TCC-1 280M-4	90	1470	51.68	155.21	7.7	93	0.90	584.65	2.1	1.9	2.5
TCC-1 315S-4	110	1475	62.97	189.09	7.8	93.3	0.90	712.15	2	1.8	2.3
TCC-1 315M-4	132	1475	71.12	223.93	7.8	93.5	0.91	854.58	2	1.8	2.3
TCC-1 315L1-4	160	1475	85.93	270.56	7.9	93.8	0.91	1035.86	2	1.8	2.3
TCC-1 315L2-4	200	1475	113.63	341.23	7.7	94	0.90	1294.82	2	1.8	2.3
TCC-1 355M-4	250	1475	150.10	431.33	7.9	94	0.89	1618.52	2	1.8	2.3
TCC-1 355L-4	315	1475	178.97	537.44	7.8	94	0.90	2039.34	2	1.8	2.3
6 Pole - 1000 rpm Synchronous Speed 50Hz											
TCA-1/TCC-1 90S-6	0.75	930	1.16	2.15	5.3	70	0.72	7.70	2.2	1.9	2.6
TCA-1/TCC-1 90L-6	1.1	930	1.63	3.02	5	72.9	0.72	11.29	2.2	1.8	2.6
TCA-1/TCC-1 100L-6	1.5	935	2.09	3.94	4.9	75.2	0.73	15.32	2.2	1.8	2.5
TCA-1/TCC-1 112M-6	2.2	935	2.97	5.60	5.7	77.7	0.73	22.47	2.2	1.8	2.5
TCA-1/TCC-1 132S-6	3	935	3.95	7.44	6.3	79.7	0.73	30.64	2.3	1.9	2.6
TCA-1/TCC-1 132M1-6	4	940	5.01	9.59	6.2	81.4	0.74	40.64	2.4	1.9	2.6
TCA-1/TCC-1 132M2-6	5.5	940	6.34	12.57	6.8	83.1	0.76	55.87	2.3	2	2.6
TCA-1/TCC-1 160M-6	7.5	950	8.49	16.82	7	84.7	0.76	75.39	2.3	2	2.7
TCA-1/TCC-1 160L-6	11	955	11.43	23.56	7.3	86.4	0.78	109.99	2.3	2	2.7
TCA-1/TCC-1 180L-6	15	955	14.84	31.25	7.2	87.7	0.79	149.99	2.3	2	2.7
TCA-1/TCC-1 200L1-6	18.5	960	15.58	36.31	6.9	88.6	0.83	184.02	2.3	2	2.7
TCA-1/TCC-1 200L2-6	22	960	18.41	42.89	7.3	89.2	0.83	218.84	2.3	2	2.6
TCC-1 225M-6	30	970	24.82	57.84	7.4	90.2	0.83	295.34	2.3	2	2.6
TCC-1 250M-6	37	970	27.94	69.20	7.5	90.8	0.85	364.25	2.3	2	2.7
TCC-1 280S-6	45	975	32.26	82.63	7.7	91.4	0.86	440.74	2.3	2	2.7
TCC-1 280M1-6	55	975	37.40	99.29	7.7	91.9	0.87	538.68	2.2	1.9	2.5
TCC-1 315S-6	75	975	45.71	131.36	7.9	92.6	0.89	734.56	2.1	1.9	2.5
TCC-1 315M-6	90	975	51.74	155.37	8	92.9	0.90	881.47	2	1.8	2.3
TCC-1 315L1-6	110	975	62.97	189.09	7.7	93.3	0.90	1077.36	2	1.8	2.3
TCC-1 315L2-6	132	975	79.68	228.96	.8	93.5	0.89	1292.83	2	1.8	2.3
TCC-1 355M1-6	160	975	85.93	270.56	7.6	93.8	0.91	1567.06	2	1.8	2.3
TCC-1 355M2-6	200	975	113.63	341.23	7.8	94	0.90	1958.83	2	1.8	2.3
TCC-1 355L-6	250	975	150.10	431.33	7.8	94	0.89	2448.54	2	1.8	2.3

IE2 Efficiency Motors Technical Data

Model	Power (KW)	Full Load Speed (r/min)	I _m 400V (A)	I _n 400V (A)	I _m /I _n (Times)	Eff. 100%FL (%)	Power Factor (CosΦ)	Full Load Torque (N.M)	T _{st} /T _n (Times)	T _{min} /T _n (Times)	T _{max} /T _n (Times)
2 Pole - 3000 rpm Synchronous Speed 50Hz											
TCA-2/TCC-2 801-2	0.75	2848	0.96	1.86	6	77.4	0.75	2.51	2.7	2.1	2.8
TCA-2/TCC-2 802-2	1.1	2846	1.20	2.52	6.7	79.6	0.79	3.69	2.7	2.1	2.9
TCA-2/TCC-2 90S-2	1.5	2852	1.32	3.17	6.1	81.3	0.84	5.02	2.3	2	2.7
TCA-2/TCC-2 90L-2	2.2	2845	1.89	4.54	7	83.2	0.84	7.38	2.6	2.1	2.7
TCA-2/TCC-2 100L-2	3	2851	2.00	5.75	7.6	84.6	0.89	10.05	2.5	2	2.8
TCA-2/TCC-2 112M-2	4	2910	2.63	7.56	7.8	85.8	0.89	13.13	2.5	2	2.7
TCA-2/TCC-2 132S1-2	5.5	2905	3.57	10.25	7.8	87	0.89	18.08	2.4	2	2.9
TCA-2/TCC-2 132S2-2	7.5	2910	5.06	13.96	7.9	88.1	0.88	24.61	2.7	2	2.8
TCA-2/TCC-2 160M1-2	11	2920	6.57	19.73	7.9	89.4	0.90	35.97	2.2	2.1	3
TCA-2/TCC-2 160M2-2	15	2918	8.37	26.35	7.9	90.3	0.91	49.09	2.3	2.1	3
TCA-2/TCC-2 160L-2	18.5	2922	9.64	31.93	8	90.9	0.92	60.46	2.4	2.1	2.9
TCA-2/TCC-2 180M-2	22	2930	13.60	39.08	7.5	91.3	0.89	71.70	2.3	2	2.8
TCA-2/TCC-2 200L1-2	30	2925	19.39	53.49	6.7	92	0.88	97.94	2.4	2	2.7
TCA-2/TCC-2 200L2-2	37	2930	21.36	64.15	6.3	92.5	0.90	120.59	2.3	2	2.7
TCC-2 225M-2	45	2930	28.81	79.45	6.9	92.9	0.88	146.66	2.3	2	2.8
TCC-2 250M-2	55	2940	35.09	96.80	8	93.2	0.88	178.64	2.3	1.9	2.7
TCC-2 280S-2	75	2940	37.86	125.45	8	93.8	0.92	243.60	2.2	1.9	2.7
TCC-2 280M-2	90	2940	45.28	150.06	7.7	94.1	0.92	292.33	2.2	1.9	2.6
TCC-2 315S-2	110	2940	62.30	187.08	7.7	94.3	0.90	357.29	2	1.8	2.3
TCC-2 315M-2	132	2940	70.29	221.33	7.6	94.6	0.91	428.74	2	1.8	2.3
TCC-2 315L1-2	160	2945	90.14	270.68	7.8	94.8	0.90	518.81	2	1.8	2.3
TCC-2 315L2-2	200	2945	118.82	341.44	7.9	95	0.89	648.51	2	1.8	2.3
TCC-2 355M-2	250	2945	140.54	422.05	7.8	95	0.90	810.64	2	1.8	2.3
TCC-2 355L-2	315	2945	187.14	537.76	7.8	95	0.89	1021.40	2	1.8	2.3
4 Pole - 1500 rpm Synchronous Speed 50Hz											
TCA-2/TCC-2 802-4	0.75	1420	0.90	1.79	5.4	79.6	0.76	5.04	2.3	2.1	2.9
TCA-2/TCC-2 90S-4	1.1	1425	1.21	2.50	5.9	81.4	0.78	7.37	2.3	2.1	2.7
TCA-2/TCC-2 90L-4	1.5	1420	1.57	3.31	6.4	82.8	0.79	10.09	2.4	2	2.7
TCA-2/TCC-2 100L1-4	2.2	1430	2.03	4.59	6.6	84.3	0.82	14.69	2.4	2.1	2.9
TCA-2/TCC-2 100L2-4	3	1430	2.94	6.33	6.9	85.5	0.80	20.03	2.4	2	2.8
TCA-2/TCC-2 112M-4	4	1435	4.01	8.44	7.9	86.6	0.79	26.62	2.5	2	3
TCA-2/TCC-2 132S-4	5.5	1430	4.87	11.04	7.1	87.7	0.82	36.73	2.3	2	2.8
TCA-2/TCC-2 132M-4	7.5	1430	6.31	14.70	7.8	88.7	0.83	50.08	2.3	2	2.7
TCA-2/TCC-2 160M-4	11	1440	6.17	19.43	7.9	89.8	0.91	72.95	2.5	2.1	2.8
TCA-2/TCC-2 160L-4	15	1445	7.82	25.92	7.8	90.8	0.92	99.13	2.4	2.1	2.9
TCA-2/TCC-2 180M-4	18.5	1445	12.68	33.66	7.8	91.2	0.87	122.26	2.4	2.1	3
TCA-2/TCC-2 180L-4	22	1460	13.55	38.95	7.5	91.6	0.89	143.89	2.3	2	3

IE2 Efficiency Motors Technical Data

Model	Power (KW)	Full Load Speed (r/min)	I _{ni} 400V (A)	I _n 400V (A)	I _{sc} /I _n (Times)	Eff. 100%FL (%)	Power Factor (CosΦ)	Full Load Torque (N.M)	T _{st} /T _n (Times)	T _{min} /T _n (Times)	T _{max} /T _n (Times)
4 Pole - 1500 rpm Synchronous Speed 50Hz											
TCA-2/TCC-2 200L-4	30	1460	19.33	53.31	7.9	92.3	0.88	196.22	2.4	2	2.7
TCC-2 225S-4	37	1470	33.42	72.02	6.7	92.7	0.80	240.36	2.4	2	2.7
TCC-2 225M-4	45	1480	40.47	87.21	7	93.1	0.80	290.35	2.3	2	2.8
TCC-2 250M-4	55	1480	34.98	96.49	7.4	93.5	0.88	354.87	2.4	1.9	2.7
TCC-2 280S-4	75	1480	40.19	126.56	7.5	94	0.91	483.92	2.2	1.9	2.6
TCC-2 280M-4	90	1480	45.23	149.90	7.7	94.2	0.92	580.70	2.2	1.9	2.6
TCC-2 315S-4	110	1480	62.17	186.69	7.8	94.5	0.90	709.75	2	1.8	2.3
TCC-2 315M-4	132	1480	70.22	221.09	7.8	94.7	0.91	851.69	2	1.8	2.3
TCC-2 315L1-4	160	1480	84.93	267.43	7.9	94.9	0.91	1032.36	2	1.8	2.3
TCC-2 315L2-4	200	1480	112.32	337.29	7.7	95.1	0.90	1290.45	2	1.8	2.3
TCC-2 355M-4	250	1480	148.36	426.35	7.9	95.1	0.89	1613.06	2	1.8	2.3
TCC-2 355L-4	315	1480	176.90	531.23	7.8	95.1	0.90	2032.45	2	1.8	2.3
6 Pole - 1000 rpm Synchronous Speed 50Hz											
TCA-2/TCC-2 90S-6	0.75	935	0.95	1.88	6.2	75.9	0.76	7.66	2.2	2	2.7
TCA-2/TCC-2 90L-6	1.1	935	1.18	2.54	6	78.1	0.80	11.23	2.3	2.1	2.6
TCA-2/TCC-2 100L-6	1.5	940	1.46	3.31	5.8	79.8	0.82	15.24	2.3	2.1	2.7
TCA-2/TCC-2 112M-6	2.2	940	2.25	4.85	6.4	81.8	0.80	22.35	2.3	2.1	2.9
TCA-2/TCC-2 132S-6	3	940	2.69	6.26	6.3	83.3	0.83	30.48	2.4	2.2	2.8
TCA-2/TCC-2 132M1-6	4	945	3.39	8.12	6.2	84.6	0.84	40.42	2.5	2	2.8
TCA-2/TCC-2 132M2-6	5.5	945	4.97	11.26	6.8	86	0.82	55.58	2.3	1.9	2.8
TCA-2/TCC-2 160M-6	7.5	955	6.16	14.78	7	87.2	0.84	74.99	2.4	1.9	2.7
TCA-2/TCC-2 160L-6	11	960	8.50	21.06	7.3	88.7	0.85	109.42	2.5	2	2.8
TCA-2/TCC-2 180L-6	15	960	12.48	29.08	7.8	89.7	0.83	149.21	2.3	2.1	2.9
TCA-2/TCC-2 200L1-6	18.5	965	14.03	34.75	7.8	90.4	0.85	183.07	2.4	2.1	3.2
TCA-2/TCC-2 200L2-6	22	965	15.86	40.62	7.9	90.9	0.86	217.70	2.3	1.9	3.1
TCC-2 225M-6	30	975	22.43	55.56	7.9	91.7	0.85	293.82	2.2	1.9	2.7
TCC-2 250M-6	37	975	29.95	69.79	7.5	92.2	0.83	362.38	2.3	2.1	2.7
TCC-2 280S-6	45	980	31.81	81.48	7.2	92.7	0.86	438.49	2.3	2	2.8
TCC-2 280M1-6	55	980	38.71	99.15	7.7	93.1	0.86	535.93	2.2	1.9	2.7
TCC-2 315S-6	75	980	45.17	129.81	7.9	93.7	0.89	730.81	2.1	1.9	2.5
TCC-2 315M-6	90	980	51.13	153.56	8	94	0.90	876.98	2	1.8	2.3
TCC-2 315L1-6	110	980	62.30	187.08	7.7	94.3	0.90	1071.86	2	1.8	2.3
TCC-2 315L2-6	132	980	78.75	226.30	8	94.6	0.89	1286.23	2	1.8	2.3
TCC-2 355M1-6	160	980	85.02	267.71	7.6	94.8	0.91	1559.07	2	1.8	2.3
TCC-2 355M2-6	200	980	112.43	337.64	7.8	95	0.90	1948.84	2	1.8	2.3
TCC-2 355L-6	250	980	148.52	426.79	7.8	95	0.89	2436.05	2	1.8	2.3

IE3 Efficiency Motors Technical Data

Model	Power (KW)	Full Load Speed (r/min)	I _n 400V (A)	I _n 400V (A)	I _{st} /I _n (Times)	Eff. 100%FL (%)	Power Factor (CosΦ)	Full Load Torque (N.M)	T _{st} /T _n (Times)	T _{min} /T _n (Times)	T _{max} /T _n (Times)
2 Pole - 3000 rpm Synchronous Speed 50Hz											
TCA-3/TCC-3 801-2	0.75	2848	0.92	1.79	6	80.7	0.75	2.51	2.7	2.1	2.8
TCA-3/TCC-3 802-2	1.1	2846	1.15	2.43	6.7	82.7	0.79	3.69	2.7	2.1	2.9
TCA-3/TCC-3 90S-2	1.5	2852	1.28	3.06	6.1	84.2	0.84	5.02	2.3	2	2.7
TCA-3/TCC-3 90L-2	2.2	2845	1.83	4.40	7	85.9	0.84	7.38	2.6	2.1	2.7
TCA-3/TCC-3 100L-2	3	2851	1.94	5.59	7.6	87.1	0.89	10.05	2.5	2	2.8
TCA-3/TCC-3 112M-2	4	2910	2.56	7.36	7.8	88.1	0.89	13.13	2.5	2	2.7
TCA-3/TCC-3 132S1-2	5.5	2905	3.48	10.00	7.8	89.2	0.89	18.08	2.4	2	2.9
TCA-3/TCC-3 132S2-2	7.5	2910	4.95	13.65	7.9	90.1	0.88	24.61	2.7	2	2.8
TCA-3/TCC-3 160M1-2	11	2920	6.44	19.34	7.9	91.2	0.90	35.97	2.2	2.1	3
TCA-3/TCC-3 160M2-2	15	2918	8.22	25.89	7.9	91.9	0.91	49.09	2.3	2.1	3
TCA-3/TCC-3 160L-2	18.5	2922	9.48	31.41	8	92.4	0.92	60.46	2.4	2.1	2.9
TCA-3/TCC-3 180M-2	22	2930	13.39	38.49	7.5	92.7	0.89	71.70	2.3	2	2.8
TCA-3/TCC-3 200L1-2	30	2925	19.12	52.74	6.7	93.3	0.88	97.94	2.4	2	2.7
TCA-3/TCC-3 200L2-2	37	2930	21.09	63.33	6.3	93.7	0.90	120.59	2.3	2	2.7
TCC-3 225M-2	45	2930	28.47	78.52	6.9	94	0.88	146.66	2.3	2	2.8
TCC-3 250M-2	55	2940	34.68	95.67	8	94.3	0.88	178.64	2.3	1.9	2.7
TCC-3 280S-2	75	2940	37.50	124.26	8	94.7	0.92	243.60	2.2	1.9	2.7
TCC-3 280M-2	90	2940	44.85	148.64	7.7	95	0.92	292.33	2.2	1.9	2.6
TCC-3 315S-2	110	2940	61.71	185.31	7.7	95.2	0.90	357.29	2	1.8	2.3
TCC-3 315M-2	132	2940	69.70	219.47	7.6	95.4	0.91	428.74	2	1.8	2.3
TCC-3 315L1-2	160	2945	89.20	267.86	7.8	95.8	0.90	518.81	2	1.8	2.3
TCC-3 315L2-2	200	2945	117.82	338.58	7.9	95.8	0.89	648.51	2	1.8	2.3
TCC-3 355M-2	250	2945	139.37	418.53	7.8	95.8	0.90	810.64	2	1.8	2.3
TCC-3 355L-2	315	2945	185.57	533.27	7.8	95.8	0.89	1021.40	2	1.8	2.3
4 Pole - 1500 rpm Synchronous Speed 50Hz											
TCA-3/TCC-3 802-4	0.75	1420	0.87	1.73	5.4	82.5	0.76	5.04	2.3	2.1	2.9
TCA-3/TCC-3 90S-4	1.1	1425	1.17	2.42	5.9	84.1	0.78	7.37	2.3	2.1	2.7
TCA-3/TCC-3 90L-4	1.5	1420	1.53	3.21	6.4	85.3	0.79	10.09	2.4	2	2.7
TCA-3/TCC-3 100L1-4	2.2	1430	1.97	4.47	6.6	86.7	0.82	14.69	2.4	2.1	2.9
TCA-3/TCC-3 100L2-4	3	1430	2.86	6.17	6.9	87.7	0.80	20.03	2.4	2	2.8
TCA-3/TCC-3 112M-4	4	1435	3.92	8.25	7.9	88.6	0.79	26.62	2.5	2	3
TCA-3/TCC-3 132S-4	5.5	1430	4.77	10.81	7.1	89.6	0.82	36.73	2.3	2	2.8
TCA-3/TCC-3 132M-4	7.5	1430	6.19	14.43	7.8	90.4	0.83	50.08	2.3	2	2.7
TCA-3/TCC-3 160M-4	11	1440	6.06	19.09	7.9	91.4	0.91	72.95	2.5	2.1	2.8
TCA-3/TCC-3 160L-4	15	1445	7.71	25.55	7.8	92.1	0.92	99.13	2.4	2.1	2.9
TCA-3/TCC-3 180M-4	18.5	1445	12.49	33.15	7.8	92.6	0.87	122.26	2.4	2.1	3
TCA-3/TCC-3 180L-4	22	1460	13.35	38.37	7.5	93	0.89	143.89	2.3	2	3
TCA-3/TCC-3 200L-4	30	1460	19.06	52.57	7.9	93.6	0.88	196.22	2.4	2	2.7
TCC-3 225S-4	37	1470	32.99	71.09	6.7	93.9	0.80	240.36	2.4	2	2.7
TCC-3 225M-4	45	1480	39.99	86.19	7	94.2	0.80	290.35	2.3	2	2.8
TCC-3 250M-4	55	1480	34.57	95.36	7.4	94.6	0.88	354.87	2.4	1.9	2.7
TCC-3 280S-4	75	1480	39.77	125.22	7.5	95	0.91	483.92	2.2	1.9	2.6
TCC-3 280M-4	90	1480	44.76	148.32	7.7	95.2	0.92	580.70	2.2	1.9	2.6
TCC-3 315S-4	110	1480	61.58	184.92	7.8	95.4	0.90	709.75	2	1.8	2.3
TCC-3 315M-4	132	1480	69.56	219.01	7.8	95.6	0.91	851.69	2	1.8	2.3
TCC-3 315L1-4	160	1480	84.13	264.91	7.9	95.8	0.91	1032.36	2	1.8	2.3
TCC-3 315L2-4	200	1480	111.26	334.12	7.7	96	0.90	1290.45	2	1.8	2.3
TCC-3 355M-4	250	1480	146.97	422.35	7.9	96	0.89	1613.06	2	1.8	2.3
TCC-3 355L-4	315	1480	175.24	526.25	7.8	96	0.90	2032.45	2	1.8	2.3
6 Pole - 1000 rpm Synchronous Speed 50Hz											
TCA-3/TCC-3 90S-6	0.75	935	0.91	1.81	6.2	78.9	0.76	7.66	2.2	2	2.7
TCA-3/TCC-3 90L-6	1.1	935	1.14	2.45	6	81	0.80	11.23	2.3	2.1	2.6
TCA-3/TCC-3 100L-6	1.5	940	1.41	3.20	5.8	82.5	0.82	15.24	2.3	2.1	2.7
TCA-3/TCC-3 112M-6	2.2	940	2.18	4.71	6.4	84.3	0.80	22.35	2.3	2.1	2.9
TCA-3/TCC-3 132S-6	3	940	2.62	6.09	6.3	85.6	0.83	30.48	2.4	2.2	2.8
TCA-3/TCC-3 132M1-6	4	945	3.30	7.92	6.2	86.8	0.84	40.42	2.5	2	2.8
TCA-3/TCC-3 132M2-6	5.5	945	4.85	11.00	6.8	88	0.82	55.58	2.3	1.9	2.8
TCA-3/TCC-3 160M-6	7.5	955	6.03	14.46	7	89.1	0.84	74.99	2.4	1.9	2.7
TCA-3/TCC-3 160L-6	11	960	8.35	20.69	7.3	90.3	0.85	109.42	2.5	2	2.8
TCA-3/TCC-3 180L-6	15	960	12.27	28.60	7.8	91.2	0.83	149.21	2.3	2.1	2.9
TCA-3/TCC-3 200L1-6	18.5	965	13.83	34.26	7.8	91.7	0.85	183.07	2.4	2.1	3.2
TCA-3/TCC-3 200L2-6	22	965	15.64	40.05	7.9	92.2	0.86	217.70	2.3	1.9	3.1
TCC-3 225M-6	30	975	22.14	54.84	7.9	92.9	0.85	293.82	2.2	1.9	2.7
TCC-3 250M-6	37	975	29.59	68.97	7.5	93.3	0.83	362.38	2.3	2.1	2.7
TCC-3 280S-6	45	980	31.47	80.61	7.2	93.7	0.86	438.49	2.3	2	2.8
TCC-3 280M1-6	55	980	38.30	98.10	7.7	94.1	0.86	535.93	2.2	1.9	2.7
TCC-3 315S-6	75	980	44.74	128.58	7.9	94.6	0.89	730.81	2.1	1.9	2.5
TCC-3 315M-6	90	980	50.65	152.10	8	94.9	0.90	876.98	2	1.8	2.3
TCC-3 315L1-6	110	980	61.77	185.51	7.7	95.1	0.90	1071.86	2	1.8	2.3
TCC-3 315L2-6	132	980	78.09	224.40	.8	95.4	0.89	1286.23	2	1.8	2.3
TCC-3 355M1-6	160	980	84.31	265.47	7.6	95.6	0.91	1559.07	2	1.8	2.3
TCC-3 355M2-6	200	980	111.50	334.82	7.8	95.8	0.90	1948.84	2	1.8	2.3
TCC-3 355L-6	250	980	147.28	423.23	7.8	95.8	0.89	2436.05	2	1.8	2.3



EC Frame - NEMA EPACT Efficiency TEFC Motors Technical Data

Model	Power (KW)	60Hz						50Hz						I _{st} /I _n (Times)	T _{st} /T _n (Times)	T _{max} /T _n (Times)	T _{min} /T _n (Times)
		Full Load Speed (r/min)	I _n 460V (A)	I _a 460V (A)	Eff. 100%FL (%)	Power Factor (CosΦ)	Full Load Torque (N.M)	Full Load Speed (r/min)	I _n 460V (A)	I _a 460V (A)	Eff. 100%FL (%)	Power Factor (CosΦ)	Full Load Torque (N.M)				
801-2	0.75	3495	0.85	1.66	75.5	0.75	2.05	2848	0.96	1.86	77.4	0.75	2.51	6	2.7	2.1	2.8
802-2	1.1	3495	1.01	2.12	82.5	0.79	3.01	2846	1.20	2.52	79.6	0.79	3.69	6.7	2.7	2.1	2.9
90S-2	1.5	3510	1.11	2.67	84	0.84	4.08	2852	1.32	3.17	81.3	0.84	5.02	6.1	2.3	2	2.7
90L-2	2.2	3525	1.60	3.84	85.5	0.84	5.96	2845	1.89	4.54	83.2	0.84	7.38	7	2.6	2.1	2.7
100L-2	3	3540	1.68	4.84	87.5	0.89	8.09	2851	2.00	5.75	84.6	0.89	10.05	7.6	2.5	2	2.8
112M-2	4	3540	2.24	6.45	87.5	0.89	10.79	2910	2.63	7.56	85.8	0.89	13.13	7.8	2.5	2	2.7
132S1-2	5.5	3540	3.05	8.76	88.5	0.89	14.84	2905	3.57	10.25	87	0.89	18.08	7.8	2.4	2	2.9
132S2-2	7.5	3545	4.33	11.95	89.5	0.88	20.20	2910	5.06	13.96	88.1	0.88	24.61	7.9	2.7	2	2.8
160M1-2	11	3550	5.66	17.01	90.2	0.90	29.59	2920	6.57	19.73	89.4	0.90	35.97	7.9	2.2	2.1	3
160M2-2	15	3550	7.28	22.94	90.2	0.91	40.35	2918	8.37	26.35	90.3	0.91	49.09	7.9	2.3	2.1	3
160L-2	18.5	3550	8.37	27.74	91	0.92	49.76	2922	9.64	31.93	90.9	0.92	60.46	8	2.4	2.1	2.9
180M-2	22	3555	11.86	34.09	91	0.89	59.10	2930	13.60	39.08	91.3	0.89	71.70	7.5	2.3	2	2.8
200L1-2	30	3555	16.92	46.66	91.7	0.88	80.58	2925	19.39	53.49	92	0.88	97.94	6.7	2.4	2	2.7
200L2-2	37	3560	18.60	55.84	92.4	0.90	99.25	2930	21.36	64.15	92.5	0.90	120.59	6.3	2.3	2	2.7
225M-2	45	3560	25.02	69.01	93	0.88	120.71	2930	28.81	79.45	92.9	0.88	146.66	6.9	2.3	2	2.8
250M-2	55	3565	30.58	84.35	93	0.88	147.32	2940	35.09	96.80	93.2	0.88	178.64	8	2.3	1.9	2.7
250M2-2	75	3565	37.21	111.75	93.6	0.90	200.90	2940	42.70	128.24	93.8	0.90	243.60	8	2.3	1.9	2.7
280S-2	75	3565	32.99	109.32	93.6	0.92	200.90	2940	37.86	125.45	93.8	0.92	243.60	8	2.2	1.9	2.7
280M-2	90	3564	39.21	129.93	94.5	0.92	241.14	2940	45.28	150.06	94.1	0.92	292.33	7.7	2.2	1.9	2.6
280M2-2	110	3555	50.99	160.55	94.5	0.91	295.48	2940	58.76	185.03	94.3	0.91	357.29	7.7	2.2	1.9	2.6
315S-2	110	3555	54.06	162.34	94.5	0.90	295.48	2940	62.30	187.08	94.3	0.90	357.29	7.7	2	1.8	2.3
315M-2	132	3560	61.19	192.66	94.5	0.91	354.08	2940	70.29	221.33	94.6	0.91	428.74	7.6	2	1.8	2.3
315L1-2	160	3560	78.22	234.88	95	0.90	429.18	2945	90.14	270.68	94.8	0.90	518.81	7.8	2	1.8	2.3
315L2-2	200	3565	102.89	295.66	95.4	0.89	535.72	2945	118.82	341.44	95	0.89	648.51	7.9	2	1.8	2.3
355M-2	250	3565	121.70	365.46	95.4	0.90	669.66	2945	140.54	422.05	95	0.90	810.64	7.8	2	1.8	2.3
355L-2	315	3568	162.04	465.66	95.4	0.89	843.06	2945	187.14	537.76	95	0.89	1021.40	7.8	2	1.8	2.3
802-4	0.75	1705	0.76	1.50	82.5	0.76	4.20	1420	0.90	1.79	79.6	0.76	5.04	5.4	2.3	2.1	2.9
90S-4	1.1	1710	1.02	2.11	84	0.78	6.14	1425	1.21	2.50	81.4	0.78	7.37	5.9	2.3	2.1	2.7
90L-4	1.5	1710	1.35	2.84	84	0.79	8.38	1420	1.57	3.31	82.8	0.79	10.09	6.4	2.4	2	2.7
100L1-4	2.2	1710	1.70	3.85	87.5	0.82	12.29	1430	2.03	4.59	84.3	0.82	14.69	6.6	2.4	2.1	2.9
100L2-4	3	1715	2.50	5.38	87.5	0.80	16.70	1430	2.94	6.33	85.5	0.80	20.03	6.9	2.4	2	2.8
112M-4	4	1715	3.45	7.26	87.5	0.79	22.27	1435	4.01	8.44	86.6	0.79	26.62	7.9	2.5	2	3
132S-4	5.5	1720	4.15	9.41	89.5	0.82	30.54	1430	4.87	11.04	87.7	0.82	36.73	7.1	2.3	2	2.8
132M-4	7.5	1720	5.44	12.67	89.5	0.83	41.64	1430	6.31	14.70	88.7	0.83	50.08	7.8	2.3	2	2.7
160M-4	11	1730	5.30	16.67	91	0.91	60.72	1440	6.17	19.43	89.8	0.91	72.95	7.9	2.5	2.1	2.8
160L-4	15	1730	6.79	22.49	91	0.92	82.80	1445	7.82	25.92	90.8	0.92	99.13	7.8	2.4	2.1	2.9
180M-4	18.5	1730	10.88	28.89	92.4	0.87	102.12	1445	12.68	33.66	91.2	0.87	122.26	7.8	2.4	2.1	3
180L-4	22	1740	11.68	33.58	92.4	0.89	120.74	1460	13.55	38.95	91.6	0.89	143.89	7.5	2.3	2	3

EC Frame - NEMA EPACT Efficiency TEFC Motors Technical Data

Model	Power (KW)	60Hz						50Hz						I _{st} /I _n (Times)	T _{st} /T _n (Times)	T _{min} /T _n (Times)	T _{max} /T _n (Times)
		Full Load Speed (r/min)	I _n 460V (A)	I _n 460V (A)	Eff. 100%FL (%)	Power Factor (CosΦ)	Full Load Torque (N.M)	Full Load Speed (r/min)	I _n 400V (A)	I _n 400V (A)	Eff. 100%FL (%)	Power Factor (CosΦ)	Full Load Torque (N.M)				
225S-4	37	1745	28.96	62.42	93	0.80	202.48	1470	33.42	72.02	92.7	0.80	240.36	6.7	2.4	2	2.7
225M-4	45	1745	35.00	75.43	93.6	0.80	246.26	1480	40.47	87.21	93.1	0.80	290.35	7	2.3	2	2.8
250M-4	55	1750	30.22	83.37	94.1	0.88	300.12	1480	34.98	96.49	93.5	0.88	354.87	7.4	2.4	1.9	2.7
250M2-4	75	1755	36.86	110.68	94.5	0.90	408.09	1480	42.61	127.96	94	0.90	483.92	7.4	2.4	1.9	2.7
280S-4	75	1760	34.77	109.47	94.5	0.91	406.93	1480	40.19	126.56	94	0.91	483.92	7.5	2.2	1.9	2.6
280M-4	90	1760	39.21	129.93	94.5	0.92	488.32	1480	45.23	149.90	94.2	0.92	580.70	7.7	2.2	1.9	2.6
315S-4	110	1780	53.77	161.48	95	0.90	590.13	1480	62.17	186.69	94.5	0.90	709.75	7.8	2	1.8	2.3
315M-4	132	1780	60.87	191.65	95	0.91	708.15	1480	70.22	221.09	94.7	0.91	851.69	7.8	2	1.8	2.3
315L1-4	160	1781	73.78	232.30	95	0.91	857.88	1480	84.93	267.43	94.9	0.91	1032.36	7.9	2	1.8	2.3
315L2-4	200	1781	97.77	293.60	95	0.90	1072.35	1480	112.32	337.29	95.1	0.90	1290.45	7.7	2	1.8	2.3
355M-4	250	1782	128.61	369.57	95.4	0.89	1339.69	1480	148.36	426.35	95.1	0.89	1613.06	7.9	2	1.8	2.3
355L-4	315	1782	153.34	460.48	95.4	0.90	1688.01	1480	176.90	531.23	95.1	0.90	2032.45	7.8	2	1.8	2.3
90L-6	1.1	1120	0.94	2.02	85.5	0.80	9.38	935	1.18	2.54	78.1	0.80	11.23	6	2.3	2.1	2.6
100L-6	1.5	1120	1.17	2.65	86.5	0.82	12.79	940	1.46	3.31	79.8	0.82	15.24	5.8	2.3	2.1	2.7
112M-6	2.2	1130	1.83	3.94	87.5	0.80	18.59	940	2.25	4.85	81.8	0.80	22.35	6.4	2.3	2.1	2.9
132S-6	3	1130	2.22	5.18	87.5	0.83	25.35	940	2.69	6.26	83.3	0.83	30.48	6.3	2.4	2.2	2.8
132M1-6	4	1140	2.85	6.83	87.5	0.84	33.51	945	3.39	8.12	84.6	0.84	40.42	6.2	2.5	2	2.8
132M2-6	5.5	1140	4.15	9.41	89.5	0.82	46.07	945	4.97	11.26	86	0.82	55.58	6.8	2.3	1.9	2.8
160M-6	7.5	1140	5.22	12.52	89.5	0.84	62.82	955	6.16	14.78	87.2	0.84	74.99	7	2.4	1.9	2.7
160L-6	11	1145	7.27	18.01	90.2	0.85	91.74	960	8.50	21.06	88.7	0.85	109.42	7.3	2.5	2	2.8
180L-6	15	1145	10.79	25.15	90.2	0.83	125.10	960	12.48	29.08	89.7	0.83	149.21	7.8	2.3	2.1	2.9
200L1-6	18.5	1150	12.03	29.79	91.7	0.85	153.62	965	14.03	34.75	90.4	0.85	183.07	7.8	2.4	2.1	3.2
200L2-6	22	1150	13.67	35.01	91.7	0.86	182.68	965	15.86	40.62	90.9	0.86	217.70	7.9	2.3	1.9	3.1
225M-6	30	1150	19.23	47.63	93	0.85	249.11	975	22.43	55.56	91.7	0.85	293.82	7.9	2.2	1.9	2.7
250M-6	37	1150	25.82	60.16	93	0.83	307.24	975	29.95	69.79	92.2	0.83	362.38	7.5	2.3	2.1	2.7
250M2-6	45	1155	28.66	70.99	93.6	0.85	372.05	975	33.28	82.43	92.7	0.85	440.74	7.5	2.3	2.1	2.7
280S-6	45	1160	27.40	70.17	93.6	0.86	370.45	980	31.81	81.48	92.7	0.86	438.49	7.2	2.3	2	2.8
280M1-6	55	1160	33.48	85.76	93.6	0.86	452.77	980	38.71	99.15	93.1	0.86	535.93	7.7	2.2	1.9	2.7
280M2-6	75	1165	41.22	113.68	94.1	0.88	614.76	980	47.60	131.29	93.7	0.88	730.81	7.7	2.2	1.9	2.7
315S-6	75	1174	39.11	112.40	94.1	0.89	610.05	980	45.17	129.81	93.7	0.89	730.81	7.9	2.1	1.9	2.5
315M-6	90	1172	44.42	133.38	94.1	0.90	733.31	980	51.13	153.56	94	0.90	876.98	8	2	1.8	2.3
315L1-6	110	1176	53.77	161.48	95	0.90	893.22	980	62.30	187.08	94.3	0.90	1071.86	7.7	2	1.8	2.3
315L2-6	132	1178	68.19	195.95	95	0.89	1070.04	980	78.75	226.30	94.6	0.89	1286.23	.8	2	1.8	2.3
355M1-6	160	1180	73.78	232.30	95	0.91	1294.82	980	85.02	267.71	94.8	0.91	1559.07	7.6	2	1.8	2.3
355M2-6	200	1179	97.77	293.60	95	0.90	1619.90	980	112.43	337.64	95	0.90	1948.84	7.8	2	1.8	2.3
355L-6	250	1180	129.15	371.13	95	0.89	2023.16	980	148.52	426.79	95	0.89	2436.05	7.8	2	1.8	2.3

IEC Frame - NEMA Premium Efficiency TEFC Motors Technical Data

Model	Power (KW)	60Hz						50Hz						I _{st} /I _n (Times)	T _{st} /T _n (Times)	T _{min} /T _n (Times)	T _{max} /T _n (Times)
		Full Load Speed (r/min)	I _{nl} 460V (A)	I _{la} 460V (A)	Eff. 100% FL (%)	Power Factor (CosΦ)	Full Load Torque (N.M)	Full Load Speed (r/min)	I _{nl} 400V (A)	I _{la} 400V (A)	Eff. 100% FL (%)	Power Factor (CosΦ)	Full Load Torque (N.M)				
801-2	0.75	3495	0.84	1.63	77	0.75	2.05	2848	0.92	1.79	80.7	0.75	2.51	6	2.7	2.1	2.8
802-2	1.1	3495	0.99	2.08	84	0.79	3.01	2846	1.15	2.43	82.7	0.79	3.69	6.7	2.7	2.1	2.9
90S-2	1.5	3510	1.09	2.62	85.5	0.84	4.08	2852	1.28	3.06	84.2	0.84	5.02	6.1	2.3	2	2.7
90L-2	2.2	3525	1.58	3.80	86.5	0.84	5.96	2845	1.83	4.40	85.9	0.84	7.38	7	2.6	2.1	2.7
100L-2	3	3540	1.66	4.78	88.5	0.89	8.09	2851	1.94	5.59	87.1	0.89	10.05	7.6	2.5	2	2.8
112M-2	4	3540	2.22	6.37	88.5	0.89	10.79	2910	2.56	7.36	88.1	0.89	13.13	7.8	2.5	2	2.7
132S1-2	5.5	3540	3.02	8.67	89.5	0.89	14.84	2905	3.48	10.00	89.2	0.89	18.08	7.8	2.4	2	2.9
132S2-2	7.5	3545	4.30	11.86	90.2	0.88	20.20	2910	4.95	13.65	90.1	0.88	24.61	7.9	2.7	2	2.8
160M1-2	11	3550	5.61	16.86	91	0.90	29.59	2920	6.44	19.34	91.2	0.90	35.97	7.9	2.2	2.1	3
160M2-2	15	3550	7.22	22.74	91	0.91	40.35	2918	8.22	25.89	91.9	0.91	49.09	7.9	2.3	2.1	3
160L-2	18.5	3550	8.31	27.52	91.7	0.92	49.76	2922	9.48	31.41	92.4	0.92	60.46	8	2.4	2.1	2.9
180M-2	22	3555	11.77	33.83	91.7	0.89	59.10	2930	13.39	38.49	92.7	0.89	71.70	7.5	2.3	2	2.8
200L1-2	30	3555	16.79	46.31	92.4	0.88	80.58	2925	19.12	52.74	93.3	0.88	97.94	6.7	2.4	2	2.7
200L2-2	37	3560	18.48	55.48	93	0.90	99.25	2930	21.09	63.33	93.7	0.90	120.59	6.3	2.3	2	2.7
225M-2	45	3560	24.86	68.57	93.6	0.88	120.71	2930	28.47	78.52	94	0.88	146.66	6.9	2.3	2	2.8
250M-2	55	3565	30.39	83.81	93.6	0.88	147.32	2940	34.68	95.67	94.3	0.88	178.64	8	2.3	1.9	2.7
250M2-2	75	3565	37.01	111.15	94.1	0.90	200.90	2940	42.30	127.02	94.7	0.90	243.60	8	2.3	1.9	2.7
280S-2	75	3565	32.81	108.74	94.1	0.92	200.90	2940	37.50	124.26	94.7	0.92	243.60	8	2.2	1.9	2.7
280M-2	90	3564	39.00	129.25	95	0.92	241.14	2940	44.85	148.64	95	0.92	292.33	7.7	2.2	1.9	2.6
280M2-2	110	3555	50.72	159.71	95	0.91	295.48	2940	58.21	183.28	95.2	0.91	357.29	7.7	2.2	1.9	2.6
315S-2	110	3555	53.77	161.48	95	0.90	295.48	2940	61.71	185.31	95.2	0.90	357.29	7.7	2	1.8	2.3
315M-2	132	3560	60.87	191.65	95	0.91	354.08	2940	69.70	219.47	95.4	0.91	428.74	7.6	2	1.8	2.3
315L1-2	160	3560	77.89	233.90	95.4	0.90	429.18	2945	89.38	268.42	95.6	0.90	518.81	7.8	2	1.8	2.3
315L2-2	200	3565	102.46	294.42	95.8	0.89	535.72	2945	117.82	338.58	95.8	0.89	648.51	7.9	2	1.8	2.3
55M-2	250	3565	121.19	363.94	95.8	0.90	669.66	2945	139.37	418.53	95.8	0.90	810.64	7.8	2	1.8	2.3
355L-2	315	3568	161.37	463.71	95.8	0.89	843.06	2945	185.57	533.27	95.8	0.89	1021.40	7.8	2	1.8	2.3
802-4	0.75	1705	0.73	1.45	85.5	0.76	4.20	1420	0.87	1.73	82.5	0.76	5.04	5.4	2.3	2.1	2.9
90S-4	1.1	1710	0.99	2.05	86.5	0.78	6.14	1425	1.17	2.42	84.1	0.78	7.37	5.9	2.3	2.1	2.7
90L-4	1.5	1710	1.31	2.76	86.5	0.79	8.38	1420	1.53	3.21	85.3	0.79	10.09	6.4	2.4	2	2.7
100L1-4	2.2	1710	1.66	3.76	89.5	0.82	12.29	1430	1.97	4.47	86.7	0.82	14.69	6.6	2.4	2.1	2.9
100L2-4	3	1715	2.44	5.26	89.5	0.80	16.70	1430	2.86	6.17	87.7	0.80	20.03	6.9	2.4	2	2.8
112M-4	4	1715	3.37	7.10	89.5	0.79	22.27	1435	3.92	8.25	88.6	0.79	26.62	7.9	2.5	2	3
132S-4	5.5	1720	4.05	9.18	91.7	0.82	30.54	1430	4.77	10.81	89.6	0.82	36.73	7.1	2.3	2	2.8
132M-4	7.5	1720	5.31	12.37	91.7	0.83	41.64	1430	6.19	14.43	90.4	0.83	50.08	7.8	2.3	2	2.7
160M-4	11	1730	5.21	16.42	92.4	0.91	60.72	1440	6.06	19.09	91.4	0.91	72.95	7.9	2.5	2.1	2.8
160L-4	15	1730	6.64	22.00	93	0.92	82.80	1445	7.71	25.55	92.1	0.92	99.13	7.8	2.4	2.1	2.9
180M-4	18.5	1730	10.74	28.51	93.6	0.87	102.12	1445	12.49	33.15	92.6	0.87	122.26	7.8	2.4	2.1	3
180L-4	22	1740	11.54	33.15	93.6	0.89	120.74	1460	13.35	38.37	93	0.89	143.89	7.5	2.3	2	3
200L-4	30	1740	16.49	45.47	94.1	0.88	164.64	1460	19.06	52.57	93.6	0.88	196.22	7.9	2.4	2	2.7
225S-4	37	1745	28.50	61.43	94.5	0.80	202.48	1470	32.99	71.09	93.9	0.80	240.36	6.7	2.4	2	2.7
225M-4	45	1745	34.48	74.32	95	0.80	246.26	1480	39.99	86.19	94.2	0.80	290.35	7	2.3	2	2.8
250M-4	55	1750	29.81	82.23	95.4	0.88	300.12	1480	34.57	95.36	94.6	0.88	354.87	7.4	2.4	1.9	2.7
250M2-4	75	1755	36.51	109.64	95.4	0.90	408.09	1480	42.16	126.62	95	0.90	483.92	7.4	2.4	1.9	2.7
280S-4	75	1760	34.44	108.43	95.4	0.91	406.93	1480	39.77	125.22	95	0.91	483.92	7.5	2.2	1.9	2.6
280M-4	90	1760	38.84	128.71	95.4	0.92	488.32	1480	44.76	148.32	95.2	0.92	580.70	7.7	2.2	1.9	2.6
315S-4	110	1780	53.32	160.13	95.8	0.90	590.13	1480	61.58	184.92	95.4	0.90	709.75	7.8	2	1.8	2.3
315M-4	132	1780	60.36	190.05	95.8	0.91	708.15	1480	69.56	219.01	95.6	0.91	851.69	7.8	2	1.8	2.3
315L1-4	160	1781	72.86	229.40	96.2	0.91	857.88	1480	84.13	264.91	95.8	0.91	1032.36	7.9	2	1.8	2.3
315L2-4	200	1781	96.55	289.94	96.2	0.90	1072.35	1480	111.26	334.12	96	0.90	1290.45	7.7	2	1.8	2.3
355M-4	250	1782	127.54	366.50	96.2	0.89	1339.69	1480	146.97	422.35	96	0.89	1613.06	7.9	2	1.8	2.3
355L-4	315	1782	152.07	456.65	96.2	0.90	1688.01	1480	175.24	526.25	96	0.90	2032.45	7.8	2	1.8	2.3

IEC Frame - NEMA Premium Efficiency TEFC Motors Technical Data

Model	Power (KW)	60Hz						50Hz						I _{st} /I _n (Times)	T _{st} /T _n (Times)	T _{min} /T _n (Times)	T _{max} /T _n (Times)
		Full Load Speed (r/min)	I _n 460V (A)	I _n 460V (A)	Eff. 100% FL (%)	Power Factor (CosΦ)	Full Load Torque (N.M)	Full Load Speed (r/min)	I _n 400V (A)	I _n 400V (A)	Eff. 100% FL (%)	Power Factor (CosΦ)	Full Load Torque (N.M)				
90L-6	1.1	1120	0.92	1.97	87.5	0.80	9.38	935	1.14	2.45	81	0.80	11.23	6	2.3	2.1	2.6
100L-6	1.5	1120	1.14	2.59	88.5	0.82	12.79	940	1.41	3.20	82.5	0.82	15.24	5.8	2.3	2.1	2.7
112M-6	2.2	1130	1.79	3.86	89.5	0.80	18.59	940	2.18	4.71	84.3	0.80	22.35	6.4	2.3	2.1	2.9
132S-6	3	1130	2.18	5.07	89.5	0.83	25.35	940	2.62	6.09	85.6	0.83	30.48	6.3	2.4	2.2	2.8
132M1-6	4	1140	2.78	6.68	89.5	0.84	33.51	945	3.30	7.92	86.8	0.84	40.42	6.2	2.5	2	2.8
132M2-6	5.5	1140	4.08	9.25	91	0.82	46.07	945	4.85	11.00	88	0.82	55.58	6.8	2.3	1.9	2.8
160M-6	7.5	1140	5.13	12.32	91	0.84	62.82	955	6.03	14.46	89.1	0.84	74.99	7	2.4	1.9	2.7
160L-6	11	1145	7.15	17.71	91.7	0.85	91.74	960	8.35	20.69	90.3	0.85	109.42	7.3	2.5	2	2.8
180L-6	15	1145	10.61	24.74	91.7	0.83	125.10	960	12.27	28.60	91.2	0.83	149.21	7.8	2.3	2.1	2.9
200L1-6	18.5	1150	11.86	29.37	93	0.85	153.62	965	13.83	34.26	91.7	0.85	183.07	7.8	2.4	2.1	3.2
200L2-6	22	1150	13.48	34.53	93	0.86	182.68	965	15.64	40.05	92.2	0.86	217.70	7.9	2.3	1.9	3.1
225M-6	30	1150	19.01	47.08	94.1	0.85	249.11	975	22.14	54.84	92.9	0.85	293.82	7.9	2.2	1.9	2.7
250M-6	37	1150	25.52	59.46	94.1	0.83	307.24	975	29.59	68.97	93.3	0.83	362.38	7.5	2.3	2.1	2.7
250M2-6	45	1155	28.39	70.32	94.5	0.85	372.05	975	32.93	81.55	93.7	0.85	440.74	7.5	2.3	2.1	2.7
280S-6	45	1160	27.14	69.50	94.5	0.86	370.45	980	31.47	80.61	93.7	0.86	438.49	7.2	2.3	2	2.8
280M1-6	55	1160	33.17	84.94	94.5	0.86	452.77	980	38.30	98.10	94.1	0.86	535.93	7.7	2.2	1.9	2.7
280M2-6	75	1165	40.83	112.60	95	0.88	614.76	980	47.15	130.04	94.6	0.88	730.81	7.7	2.2	1.9	2.7
315S-6	75	1174	38.74	111.34	95	0.89	610.05	980	44.74	128.58	94.6	0.89	730.81	7.9	2.1	1.9	2.5
315M-6	90	1172	44.00	132.12	95	0.90	733.31	980	50.65	152.10	94.9	0.90	876.98	8	2	1.8	2.3
315L1-6	110	1176	53.32	160.13	95.8	0.90	893.22	980	61.77	185.51	95.1	0.90	1071.86	7.7	2	1.8	2.3
315L2-6	132	1178	67.62	194.32	95.8	0.89	1070.04	980	78.09	224.40	95.4	0.89	1286.23	8	2	1.8	2.3
355M1-6	160	1180	73.16	230.36	95.8	0.91	1294.82	980	84.31	265.47	95.6	0.91	1559.07	7.6	2	1.8	2.3
355M2-6	200	1179	96.95	291.15	95.8	0.90	1619.90	980	111.50	334.82	95.8	0.90	1948.84	7.8	2	1.8	2.3
355L-6	250	1180	128.07	368.03	95.8	0.89	2023.16	980	147.28	423.23	95.8	0.89	2436.05	7.8	2	1.8	2.3



TEC Electric Motors Ltd.

ADD:UNIT 1, BUILDING 341

RUSHOCK TRADING ESTATE

RUSHOCK DROITWICH WR9 0NR U.K

TEL:0044 (0)1299 252990

FAX:0044 (0)1299 250317