

NRL Reporter

March 2024



www.northernrayscorvetteclub.com

1972-2024

52 Years and Still Going Strong!





*NRL Looking Great – Wearing Red in Support of Heart Month
Plus wonderful paper goods drive for Itasca Food Pantry
Thank you all!*

2024 NRL OFFICERS
www.northernrayscorvetteclub.com

Northern Rays Ltd. (NRL) is a sanctioned club of the National Council of Corvette Clubs (NCCC). Its members are dedicated to the preservation and competition of the Chevrolet Corvette.

Meetings are held on the second Tuesday of the month at 7:30 pm at:

Real Time Sports
1120 W. Devon Ave.
Elk Grove Village, IL 60007

Membership in NRL is based on an applicant meeting the following requirements:

- 1) Be a Corvette Enthusiast at the time of Application.
- 2) Be at least 18 years old
- 3) Submitted the first year's NRL/NCCC New Member dues of \$75 Single/\$125 Couple, which includes an NRL club shirt. All members will also receive an NCCC membership card.
- 4) NRL/NCCC Renewal dues are \$45 Single/\$75 Couple.

The *Reporter* is published monthly by Northern Rays Limited. The content of this publication is based on source material believed to be accurate at the time of publication. NRL holds no legal responsibility for correctness or completeness of materials submitted for publication.

All inquiries concerning the *Reporter* Should be directed to the Publications Director. Advertising rates are listed on the back cover.

All items being submitted for inclusion in the *Reporter* must be received by the Publications Director no later than the last Tuesday of the month.

Address all club correspondence to Northern Rays Ltd., P.O. Box 455, Itasca, Illinois 60143.

Northern Rays Ltd. Is registered in the State of Illinois as a not-for-profit organization.

2024 Northern Rays Ltd.

PRESIDENT

Diane Wagner

[E-mail: wagnersminis@aol.com](mailto:wagnersminis@aol.com)

VICE PRESIDENT

Fred Marano

[E-mail: pilotdad13@aol.com](mailto:pilotdad13@aol.com)

NCCC GOVERNOR

Dan Wagner

[E-mail: wagnersminis@aol.com](mailto:wagnersminis@aol.com)

SECRETARY

Cindy Barbera

[E-mail: cbarbera@fquinncorp.com](mailto:cbarbera@fquinncorp.com)

TREASURER

Linda Fairlamb

[E-mail: ladyracer98@comcast.net](mailto:ladyracer98@comcast.net)

COMPETTION DIRECTOR

Linda Fairlamb

MEMBERSHIP DIRECTOR

Ed Frost

[E-mail: vette1999@gmail.com](mailto:vette1999@gmail.com)

PUBLICATIONS/WEBMASTER

Pat Lopardo

[E-mail: patsue5309@gmail.com](mailto:patsue5309@gmail.com)

SERGEANT-AT-ARMS

Santo Scafide

[E-mail: santo1963@ymail.com](mailto:santo1963@ymail.com)

Ed Wodniakowski

[E-mail: edw0647@aol.com](mailto:edw0647@aol.com)

PUBLIC RELATIONS

Elizabeth Ball

[E-mail: racerlady2004@gmail.com](mailto:racerlady2004@gmail.com)

HISTORIAN

Vern Fagerberg

[E-mail: IS1949@frontier.com](mailto:IS1949@frontier.com)

From the Office of the President

March 2024



It is so hard to believe that it's March already. It feels like April! We had the warmest February on record. 70's in February is just crazy, but I'll take it! I hope everyone is gearing up for another great year of corvette fun! Check out our events calendar that is in the monthly Reporter and on our new & improved website. Additional events will be added as plans are finalized.

Thank you again to everyone that donated products for our annual paper drive for the Itasca Food Pantry at our February membership meeting. We filled up the back of Ed's very large SUV. Awesome job everyone! February 17th, Linda put together a fun afternoon at the "Putt Shack" in Oakbrook. Followed up with dinner at a nice Italian restaurant. Thanks for putting this together. There are some great pictures on the web site. Check it out!

Upcoming March events include, a night out that the Improv comedy club in Schaumburg, and a Friday night fish fry in Barrington. Don't forget about the 2023 Midwest region party & awards banquet on April 6, 2024. This event is in Madison WI. NRL will have a great representation of awards. Fred Marano for over 200 points, Dan Wagner for men's 5th place, Diane Wagner for ladies 2nd place and Linda Fairlamb ladies 1st place! NRL has never had 1-2 punch before. Also, our club came in 3rd place for the region. Consider joining us at this event. It's a fun evening. Registration for the National Convention in Joplin, MO opened on February 1st. This is an awesome event with everything from great conversations with other corvette owners, to judged car shows, auto crossing, drag races, rallyes, valve cover racing, funkhanas, evening entertainment, and tours. Consider attending, you will be glad you did!



Hope you can join us for our next membership meeting on March 12th, 2023 at Real Time Sports in Elk Grove Village, IL. Pizza at 7, meeting starts at 7:30. Until then.....

Happy Motoring and remember to Save the Wave.

Diane Wagner

President

Northern Rays LTD.



Northern Rays Corvette Club General Membership Meeting
Date: Tuesday, February 13th, 2024
By: Cindy Barbera

Meeting Location - Real Time Sports, Elk Grove Village, IL
- Pizza was served at 7:00 p.m.
Meeting called to order at 7:30 p.m. by Diane Wagner

President's Report – Diane Wagner – Last month's meeting minutes were reviewed with motion for approval by Mike Baumer and seconded by Ed Frost.

The paper drive for the Itasca Food Pantry was a huge success. Thank you all for your participation. Mark & Judy Jackson former members joined the meeting to say hello and catch up with friends. Bob Q. (guest) attended the meeting patiently considering joining. Mike Piecyk attended the meeting and joined the club.

Events held this past month:

- It was one of the coldest days in January and yet we still had fun at the Murder Mystery dinner held at the Double Tree in Arlington Heights.

Vice President's Report – Fred Marano –

- No member's birthdays in February
- Upcoming outings:
 - February 17th Putt Shack 16 attending. Dinner at Positano Ristorante – Oak Brook Terrace
 - March 9th Improv Comedy Club – Tickets still available. Dinner before the show.
 - April 20th Spring Fling Dinner – Angelos Restaurant – Elmhurst.
 - Fish Fry Suggestions?
 - May 19th Hawk Chevrolet Car Show Swap Meet

Parliamentarian Report: - Linda Fairlamb

- Nothing to Report

Governor's Report – Dan Wagner

- New Membership cards have been mailed. Will be attending the Governor's meeting.

Secretary Report – Cindy Barbera

- Nothing to report.

Treasurer's Report – Linda Fairlamb –

- We have money!

Competition Report – Linda Fairlamb

- April 6th MWR 2023 Awards Banquet

- May 13th NCCC National Convention Joplin MO – Online registration begins on February 1st.
- Midwest Region Fundraiser Autocross – Rantoul Il May 25th – 27th - Volunteers are appreciated.

Public Relations Report – Elizabeth Ball –

- Carlos Mencia at the Schaumburg Improv Comedy Club on March 9th at 7:00pm Tickets still available.

Membership Report – Ed Frost

- Suggested to have a few of our corvette business cards in your corvette for any new potential members.

Publications Report – Pat Lopardo – February Reporter was issued on 2/9/24.

Web Master Report – Pat Lopardo - 253 people have visited the website since Jan 25th.

Sergeant at Arms Report – Santo S. & Ed W. – One Corvette

- 10 min. brake:

Raffles coordinated by:

Dan Wagner for the 50/50 – tickets \$1 each or six for \$5

Tom Novak for General Raffle – tickets \$4 each or 3 for \$10

Raffle prizes: Window Thermometer- Tom N.- Espresso Martini – Ed Frost. Corvette Magazine – Fred M.

Chocolate Heat Candy- Linda D. Valentine Mystery Bag– Mike B. Corvette Coffee Mug – Mike Piecyk

Card Holder with Gas Card – Les -Corvette Magazine – Elaine Valentine Mystery Basket – Kim S.

Winner this week for the 50/50:

- Elaine Meyer won the 50/50 Cash Prize of \$53.00

Your contributions and ticket purchases support NRL and our pizza sharing at each meeting. Thank You!

The meeting was adjourned at 8:30pm. motion by Kim Scafide and second by Fred Marano.

Next Meeting March 12, 2024



Deb Murphy - NCCC President

NCCC President's Message

March 2024

It's March and we are quickly moving into a busy competition season. Each club has more sanctions and a new set up for competition – Speed and Non Speed. Non Speed events include rallies, funkhanas, concours and car shows. Points are accumulated separate from autocross events for a chance at a national award. If your club has not tried to host one of these events, give it a try. Rene has been working to get more events! If you need help, he is always ready to help.

Convention registration is open! Joplin MO and the host club is looking forward to have our organization there. We get to have a car show and events downtown! You can get a look at Route 66 too or there is a Showboat ride on the schedule too. I'm looking forward to exploring Joplin since I have never been there.

The National Corvette Museum is gearing up for the BASH in April. If you have not made your reservations, things fill up fast. Chevrolet and the Corvette Plant always try to have sessions to update everyone on what is going on. NCCC will have a booth so if you are planning on attending, please stop by to see us.

Our next national meeting in St. Louis is in May just before convention. Everyone is welcome to attend the meetings. It is a good way visit with members from other regions.

Deb Murphy
NCCC President



Planning!
General Raffle Donors – 2024 NRL Meetings

Sign Up Today & Thank You!
 Your contributions help us share the fun and also enjoy Pizza at each meeting.

January	Santo & Kim S.	Linda D.	Fred & Elaine M.
February	Mark & Cindy B.	Fred & Sue M.	Tom & Leann
March	Dan & Diane W.	Tom & Leann	Fred & Elaine M.
April	Fred & Elaine M.	Ed & Sue F.	
May	Ed & Terry W.	Santo & Kim S.	Linda D.
June	Tim & Rose B.	Linda F.	
July	Mike & Katy B.		
August	Fred & Sue M.	Elizabeth B.	
September	Ed & Terry W.	Tim & Rose B.	Linda D.
October	Linda F.	Elizabeth B.	
November			
<i>December – Special Holiday Meeting</i>			

Thank you for all your Support!



Happy Birthday



March 2024 Birthdays

<i>Lori Gochheim</i>	<i>March 14</i>
<i>Chris Moores</i>	<i>March 23</i>
<i>Rose Bruin</i>	<i>March 26</i>
<i>Dan Wagner</i>	<i>March 26</i>
<i>Ed Frost</i>	<i>March 30</i>

*Fun Times at Putt Shack and
Dinner at Positano's in Oak Brook!*

**Congrats to Elizabeth and Chris #1
Special Thanks to Linda F. for coordinating a great night!
*Great Time had by All!***



2024 Planning / Events

Northern Rays Ltd.

Dates	Event	Key Contact
Sat, Mar. 9 th	Improv Comedy Club Outing Schaumburg location (Woodfield Mall) 7pm show	Elizabeth B.
Tues., Mar. 12 th	Monthly Club Meeting Meeting at: Real Time Sports on Devon Ave. in Elk Grove, IL & Zoom	Diane W & Fred M. & Sue L.
Friday March 22	Annual Fish Fry Dinner – Location - TBD	Fred M.
Sat. Apr. 6th	MWR 2023 Awards Banquet, Madison, WI	Linda F & Dan & Diane W.
Tues. April 9 th	Monthly Club Meeting Meeting at: Real Time Sports on Devon Ave. in Elk Grove, IL & Zoom	Diane W & Fred M. & Sue L.
Apr 13 th & 14 th	South Bend, IN – Tire Rack Autocross	Linda F.
Sat, Apr. 20th	SPRING FLING DINNER @ ANGELOS Elmhurst, IL	Santo S.
Sun, Apr. 21 st	RALLYE – MILAN, IL	
May 13th – 19th	NCCC National Convention (Monday thru Saturday) Joplin, MO (Registration begins January 15th)	Linda F.
Tues, May 14 th	Monthly Club Meeting Meeting at: Real Time Sports on Devon Ave. in Elk Grove, IL & Zoom	Diane W & Fred M. & Sue L.
Sun. May 19 th	Hawk Chevrolet Joliet - Car Show & Swap Meet	
Sat-Mon May 25-27th	Midwest Region Fundrasier Autocross in Rantoul IL	Linda F.
June 8 th & 9 th	Sanctioned Rallyes in WI both days	
June 8 th or 9 th	Poker Run	Fred M / ?
Tues, June 11 th	Monthly Club Meeting Meeting at: Real Time Sports on Devon Ave. in Elk Grove, IL & Zoom	Diane W & Fred M. & Sue L.
Jun 15th & 16th	NRL AUTOCROSS WEEKEND Rantoul, IL- NEED WORKERS	Linda F. & Dan W
Jun 22 nd & 23 rd	Madison, WI Autocross	
June 29 th & 30 th	Columbus, WI Autocross	
Thurs, July 4th	NILES PARADE Major Fundraiser! & Afterparty at Ski's house	Linda F. & Ski

NRL Virtual Event!

Make a Donation Online to the Northern Illinois Food Bank or a Food Bank of your choice!
Let your heart  and your pocket-book lead you!

2024 Planning / Events Northern Rays Ltd.

Sat. Jul 6 th	Rallye – MO (Route 66 CC)	
Tues, Jul 9 th	Monthly Club Meeting Meeting at: Real Time Sports on Devon Ave. in Elk Grove, IL & Zoom	Diane W & Fred M. & Sue L.
July 13 th or 14 th	Poker Run ?	Fred M / ?
Jul 20 th & 21 st	Columbus, WI Autocross	
Jul 27 th & 28 th	Quincy, IL - Autocross	
Aug 3 rd & 4 th	Madison, WI – Autocross	
August 10 th & 11 th	Crystal Lake, IL - Autocross	
Tues, Aug 13 th	Monthly Club Meeting Meeting at: Real Time Sports on Devon Ave. in Elk Grove, IL & Zoom	Diane W & Fred M. & Sue L.
Aug 25 th	Davenport, IA - Autocross	
Sat, Sept. 7 th	Bloomington Parade	Ed Frost
Tues, Sept. 10 th	Monthly Club Meeting Meeting at: Real Time Sports on Devon Ave. in Elk Grove, IL & Zoom	Diane W & Fred M. & Sue L.
Sep 21 st & 22 nd	Columbus, WI - Autocross	
Oct 5 th & 6 th	Pekin, IL – Autocross NRL Co-Sponsor	Linda F. & Dan W
Tues, Oct. 8 th	Monthly Club Meeting Food Drive / Itasca Food Bank Meeting at: Real Time Sports on Devon Ave. in Elk Grove, IL & Zoom	Diane W & Fred M. & Sue L.
Oct. 12 th or 13 th	Poker Run	Fred M / ?
Oct 19 th & 20 th	Crystal Lake, IL – Autocross NRL Co-Sponsor	Linda F. & Dan W
Tues, Nov. 12 th	Monthly Club Meeting Meeting at: Real Time Sports on Devon Ave. in Elk Grove, IL & Zoom	Diane W & Fred M. & Sue L.
Sat. Dec 7 th	NRL Christmas Dinner at Villagio's	Ed, Sue & Kim
Tues, Dec. 10 th	Monthly Club Meeting Meeting at: Real Time Sports on Devon Ave. in Elk Grove, IL & Zoom	Diane W & Fred M. & Sue L.

NRL Virtual Event!

**Make a Donation Online to the Northern Illinois Food Bank or a Food Bank of your choice!
Let your heart  and your pocket-book lead you!**



MW-465-N02

Midwest Region Party & Awards Banquet

Hosted by Mad City Vettes ~ 2023 Club Champions
Saturday, April 6, 2024 ~Marriot Madison West~ 5:00-Midnight
1313 John Q. Hammons Drive in Middleton, WI 53562 (west side of Madison)
Directions, Map and Hotel Reservation information on next page
Cocktails at 5:00 pm ~ Dinner at 6:30 pm

Complimentary Beverages:
Spotted Cow Draft Beer, White and Red Wines
Soft Drinks, Iced Tea, Water, Coffee
Beverages Available for Purchase:
Mixed Drinks and Bottles of other Beer Brands

Recognitions and Awards Presentations at 7:30
Bar will be open thru Dinner, closed during the Awards Presentations
and then reopen for the rest of the evening with last call at 11:45

Meal Choices
Roasted Chicken Breast with special sauce
Grilled Flat Iron Steak with red wine sauce
Seared Salmon with lemon cream sauce
All meals come with a salad, potato, vegetables, rolls, dessert,
coffee and/or iced tea
Anyone with dietary issues and would like to
request a special meal should contact Joan Thomas

Registration and Payment must be RECEIVED by March 27, 2024
Please register as soon as possible. Contact Joan Thomas with any questions
815-494-5985 or teamthomas525@gmail.com

✂-----✂-----✂-----✂-----✂-----✂-----**PLEASE PRINT**-----✂-----✂-----✂-----✂-----✂-----✂

Full Name: _____ Club _____ @ \$50.00
Circle Meal Choice: Chicken Steak Salmon

Full Name: _____ Club _____ @ \$50.00
Circle Meal Choice: Chicken Steak Salmon

Party Registration Check should be made payable to Mad City Vettes in the amount of \$ _____
Mail Registration and check to: Mad City Vettes
c/o Joan Thomas
5681 Oak Village Drive
Roscoe, IL 61073-7009

Event Location: Marriot Madison West Hotel
1313 John Q. Hammons Drive, Middleton, Wisconsin 53562
Local phone number is 608-831-2000 (Rate ~ \$131.00+ 13.50% tax)

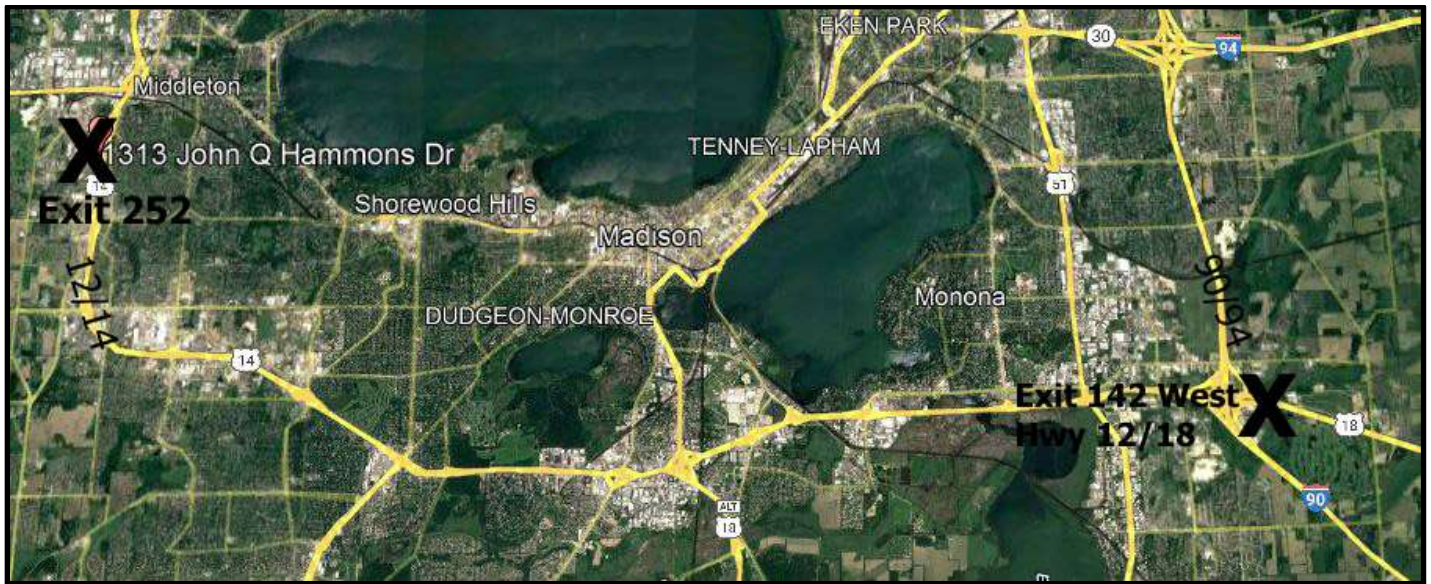

**Book Hotel Reservation early!
Block ends March 19, 2024**

Marriot Madison West

10 Run of House Rooms have been blocked
In the name of "Midwest Region"
Run of House means whatever is available.

Call 888-745-2032 or click on this link

<https://www.marriott.com/event-reservations/reservation-link.mi?id=1700159530488&key=GRP&app=resvlink>

Rate is \$131.00 plus 13.50% tax.

The Marriot is waiving the \$10.00 parking fee for overnight guests.

Contact Joan if you have trouble booking a room.



April at Tire Rack 14 Low Speed Events



Saturday, April 13, 2024

Low Speed 1 – MW-351-001
Low Speed 2 – MW-109-001
Low Speed 3 – MW-109-002
Low Speed 4 – MW 109-003
Low Speed 5 – MW 109-004
Low Speed 6 – MW 109-005
Low Speed 7 – MW 575-001

Sunday, April 14, 2024

Low Speed 8 --- MW 378-002
Low Speed 9 --- MW 109-006
Low Speed 10 – MW 109-007
Low Speed 11 – MW 109-008
Low Speed 12 – MW 109-009
Low Speed 13 – MW 109-010
Low Speed 14 – MW 378-001



Hosting Clubs:

Windy City Corvettes (MW 351)
Chicago Crossroads (MW 575)
Corvette Club of Illinois (MW 109)

Corvette Cruisers of Illinois (MW 378)

Governor:

Dave Heinemann 708-638-0199 email: windyz06@aol.com

Event Fees:

All Entrants -- \$120 (all 14 events)
All Entrants – Sat. \$60, Sun. \$60
All Entrants -- per Event (\$10)

Pre-register by April 6, 2024 : \$100 for all events, Sat. \$50, Sun. \$50. Use link below

<https://corvettesnccc.org/NCCCOOnlineRegistration/Programs/Registration.php?eventId=167>

Send payment to:

Windy City Corvettes
PO Box 353
Orland Park, IL 60462-0353
Attn: Tire Rack Autocross

Make check payable to Windy City Corvettes

- Lunch provided both days in lieu of awards.
- Participants may be asked to work.
- Contact phone day of event:
Ken Linderborg 708-828-5922
email: klinderborg2000@yahoo.com before event

Numbers will be assigned by Registration per assigned number list and available numbers. MWR members requesting numbers other than those assigned by registration will be charged per MWR Rules.

Location:

TIRE RACK[®]

.com

*** Note that Tire Rack is
in the Eastern Time Zone**

7101 Vorden Parkway,
South Bend, IN 46628
www.tirerack.com

Saturday, April 13, 2024

Registration/Tech: 8:30 to 9:45 am ET*

Drivers Meeting: 10:00 am

1st car on course following Driver's Meeting

Events: 1, 2, 3, 4, 5, 6, 7

Sunday, April 14, 2024

Registration/Tech: 7:30 to 8:45 am ET*

Drivers Meeting: 9:00 am

1st Car on course following Driver's Meeting

Events: 8, 9, 10, 11, 12, 13, 14

Event Chairpersons:

Saturday Overall Ken Linderborg, Phone 708-828-5922

Sunday Overall Marty Linderborg, Phone 708-828-5922

Track Info:

No alcoholic beverages are allowed.

ALL EVENTS ARE CLOSED EXHAUST

Non-NCCC members are not covered by NCCC insurance

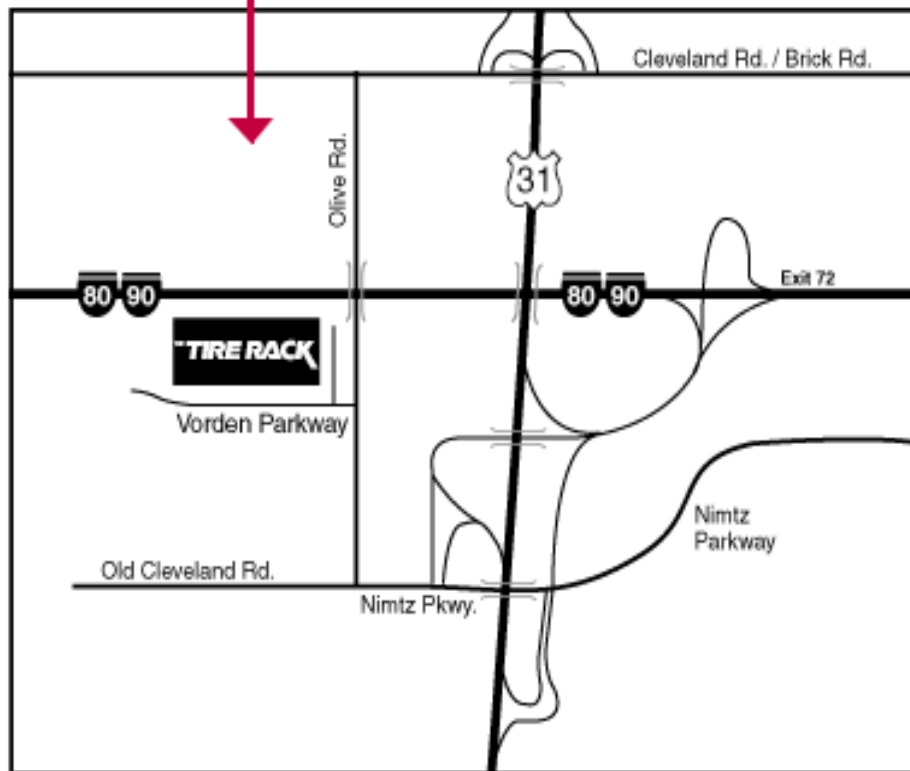
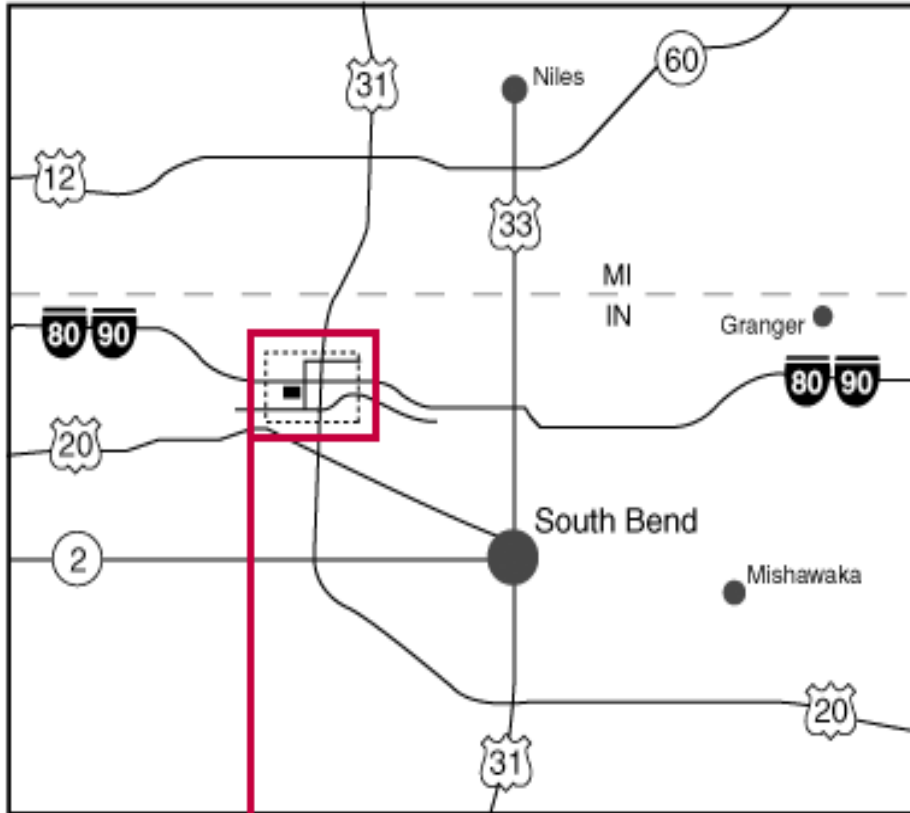

Midwest Region Registration Form for Speed Events.

Date: April 13 & 14 2024

Sanctions: MW351-001, MW575-001, MW109-001-010, MW378-001-002

Location: Tire Rack, 7101 Vorden Parkway, South Bend, IN



Low Speed Autocross Sat. Sun Weekend

Driver #1 Name: _____ Registration Use Only> DL NCCC #

NCCC Number: _____ Assigned Number: _____

Driver #2 Name: _____ Registration Use Only> DL NCCC #

NCCC Number: _____ Assigned Number: _____

E-mail address: _____

Address, if not as in the NCCC Database.

Street: _____ City: _____ State: __ Zip Code: _____

Emergency Contact Information, if not at event:

Name: _____ Relationship: _____ Phone: _____

Car Information:

Stock Transmission Y N circle answer

Stock Drive Axle Ratio Y N circle answer

Requested Class: _____

Engine Displacement and Factory Rated HP: _____

NOTE: All entrants MUST truthfully complete the registration form. All Entrants MUST sign the RELEASE AND WAIVER OF LIABILITY, ASSUMPTION OF RISK AND INDEMNITY AGREEMENT and any release documents required by NCCC. Entrants younger than eighteen (18) years must have a parent or legal guardian present and submit a properly completed PARENTAL CONSENT, RELEASE AND WAIVER OF LIABILITY, ASSUMPTION OF RISK, AND INDEMNITY AGREEMENT and a MINOR'S ASSUMPTION OF RISK ACKNOWLEDGMENT; and any release documents required by NCCC. All Entrants MUST show a Driver's License at registration. NCCC members must show proof of membership at registration.

Numbers will be assigned by Registration per assigned number list and available numbers. MWR members requesting numbers other than those assigned by registration will be charged per MWR Rules

Non-NCCC members are not covered by NCCC insurance



AREA HOTELS

Less than 15 Minutes from Tire Rack

TIRE RACK
.com

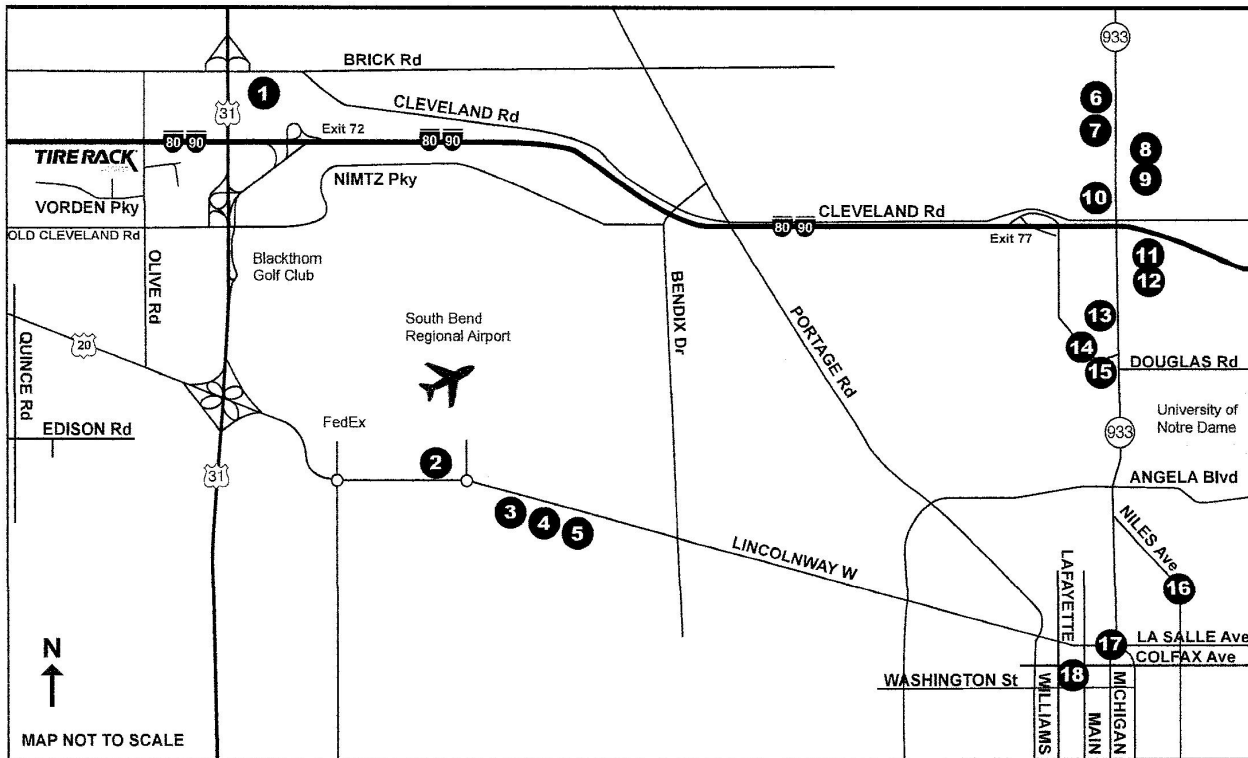

1	Super 8 Motel	4124 Ameritech Drive	574-243-0200
2	Airport Inn & Suites	23040 US 20 West	574-233-3131
3	Sleep Inn	4134 Lincolnway West	574-232-3200
4	Quality Inn & Suites	4124 Lincolnway West	574-288-3800
5	Candlewood Suites	3916 Lincolnway West	574-968-1072
6	Hampton Inn & Suites	52709 Indiana State Route 933	574-277-9373
7	Suburban Extended Stay Hotel	52825 Indiana State Route 933	574-968-4737
8	Staybridge Suites	52860 Indiana State Route 933	574-968-7440
9	Waterford Estates Lodge	52890 Indiana State Route 933	574-272-5220
10	Comfort Suites*	52939 Indiana State Route 933	574-272-1500
11	Motel 6	236 Dixie Way North	574-404-2004
12	Holiday Inn Express	120 Dixie Way North	574-968-8080
13	Quality Inn	215 Dixie Way South	574-277-3211
14	Hilton Garden Inn	53995 Indiana State Route 933	574-232-7700
15	Inn at St. Mary's*	53993 Indiana State Route 933	574-232-4000
16	Residence Inn by Marriott	716 N. Niles Ave	574-289-5555
17	DoubleTree By Hilton	123 N. St Joseph St	574-234-2000
18	Magnuson Grand Hotel	213 W. Washington St	574-232-3941

*Request Tire Rack Corporate Rate - Availability Limited



Joplin, Missouri
May 13 - 19

2024 Convention Tentative Schedule

- Mon, May 13 1:00-5:00 Early Registration/Tech Inspection
1:00-5:00 Corvette Mall setup
- Tues, May 14 9:00-5:00 Registration/Tech Inspection
9:00-5:00 Corvette Mall
6:00-9:00 Hospitality Room
6:00-9:00 Welcome Party @ La Quinta -Pizza, Hospitality, live music by Eastbound
- Wed, May 15 8:00-11:30 Rallye
9:30-1:30 Cruise-Route 66 West. Narrated drive on Rt 66 West including one of the Cars movie inspiration towns and a picture of your car on Rainbow Bridge. Lunch stop (price not included)
9:30-1:30 Cruise-Route 66 East. Narrated drive on Rt 66 East, stopping at a reconstructed 1920's village, and a picture of your car at an old gas station. Lunch stop (not included)
11:00-4:00 Corvette Mall
1:00-4:00 Hospitality Room
2:00-4:30 Funkhana @ Holiday Inn
6:00-10:00 National Awards Banquet @ Downstream Casino. Live music by Rich McCready, country singer/songwriter
- Thur, May 16 8:00-12:00 Judged Concours downtown
9:00-11:30 Downtown Scavenger Hunt. Like a Rallye, but on foot. Answer questions and find information in 4 blocks of Main Street (near Concours)
9:30-1:30 Cruise-Route 66 West-Same as Wednesday
9:30-1:30 Cruise- Route 66 East-Same as Wednesday
12:00-3:00 Corvette Mall
1:00-3:00 Hospitality Room
4:00-8:00 Peoples Choice Car Show- Joplin will block off 4 blocks of Main Street for Car Show. Road Crew band from Nashville and more-big street party!
4:30-7:00 Valve Cover Races downtown
- Fri, May 17 8:00-11:00 Poker Run
8:00-5:00 Drags at Smokin' Mo-Kan-1/4 mile track in great condition, long shutdown area

9:00-5:00 Cruise-Branson Belle Showboat. Classic riverboat cruise with 3 course meal and entertainment. Drive your car or ride a bus (extra cost) Bus ride includes Country Music Boulevard.

12:00-6:00 Corvette Mall

1:00-5:00 Hospitality Room

Pool party @ La Quinta. Hillbilly Theme, grab your straw hat and Corn cob pipe, get ready for some photo ops with a few of our props and have a great time. Live music by Pete & Dave, meal and beverages included.

Sat, May 18 8:00-4:00 Autocross @ Crowder Truck pad, Neosho

9:00-12:30 Paint N Sip. At Holiday Inn Hospitality room. Create your own masterpiece led by a talented and witty artist. Canvas and supplies provided to paint a Rt66/Corvette theme just for us!

9:00-2:30 Bus Tour-Crystal Bridges Art Museum/Frank Lloyd House. American art and exhibitions in beautiful 120-acre setting, tour Frank Lloyd Wright house.

Lunch stop (not included)

1:00-6:00 Corvette Mall

1:00-6:00 Hospitality

Sun, May 19 9:00-11:00 Awards Ceremony. Collect your awards and trophies, HAVE A SAFE TRIP HOME

Please bring a walkie-talkie for driving tours.



2024 NCCC CONVENTION #65

*******SAVE THE DATE*******

Illinois NCRS 2024 Road Tour

3 Day – 2 Night Trip

Friday Sept. 20 to Sunday Sept. 22

*From Naperville, Illinois to Galena, Illinois to
The Amana Colonies, Iowa*

One night in Galena, One night in Amana, Iowa.

Join us for all or any part of this road tour



DAY 1: Galena, Illinois



Visit Historic Galena,
Trolley Tours, Shopping,
Restaurants, Museums.

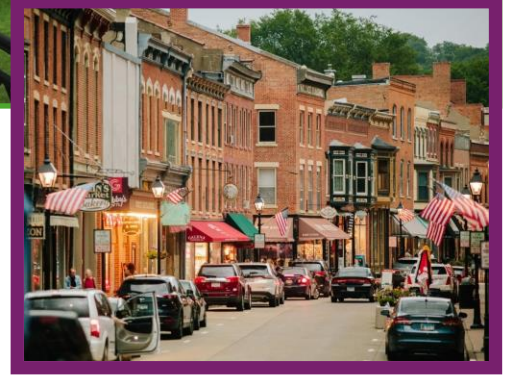

DAY 2: The Amana Colonies, Amana Illinois



The seven Villages
of Amana are a
tourist attraction
known for the
German Heritage,
restaurants and
shops.



The Colonies were
listed as a
National Historic
Landmark in 1965



*******MORE INFORMATION TO COME*******



Adventure at GREAT AMERICA

Three Chicago Area Clubs Host a Corvette Soiree at the Great America Theme Park

They called it the "Great Corvettes Weekend at Great America," and hundreds of Corvette owners from all over the Midwest responded to the invitation from Chicago host clubs. The Chicago Corvette Club, Northern Rays, and the North Shore Corvette Club really put their heads and shoulders together in running this second annual festival of fiberglass last September.

A well-spaced series of activities dotted the weekend schedule, keeping enthusiastic guests busy but also providing sufficient free time for the many rides and amusements offered at the spectacular Great America Theme Parks. Launching the event was a Saturday morning concours sponsored by the Chicago Corvette Club. Concours judging took most of the morning, and the afternoon was event-free so guests could test their courage on rides like the Turn of the Century, Willard's Whizzer, and the Tidal Wave. (These rides make you wonder about their designers and builders — people who make good money — inventing new forms of stress for the human system.)

Most of the survivors of the afternoon activity, including special guests **CN** Editor Ken Wechselberger and Corvette Chief Engineer Dave McLellan, turned out for the early evening

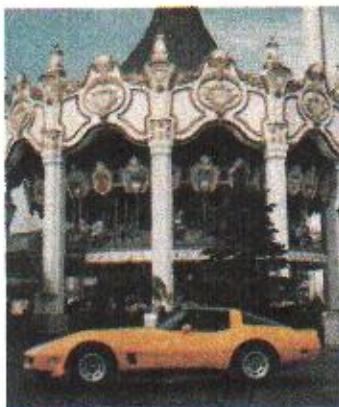

concours awards presentation. For the second consecutive year, noted TV-Radio personality Wolfman Jack served as master of ceremonies for the presentation. (Always wondered what caused Mrs. Jack to name her baby Wolfman.)

With the awards presentation out of the way, activity shifted to the Lincolnshire Resort, located just 15 minutes from Great America. Both the Lincolnshire Resort and the Great America Theme Park are Marriott enterprises, and both are on Interstate-94, the main north-south connection between Chicago and Milwaukee. Very convenient for "foreign" guests, not familiar with the local territory.

The main event of the evening was a party held in the Lincolnshire Ballroom. This gathering was a fundraising event for the Spina Bifida Association of America, the beneficiary of charity efforts of the National Council of Corvette Clubs. Festivities were highlighted by Dave McLellan's slide presentation which featured a detailed account of the engineering developments of the 1980 and future Corvettes.

Sunday got off to a flying start with a pair of performance events — a Funkhana sponsored by the Northern Rays Corvette Club, and a Gymkhana,



staged by the North Shore Corvette Club. These events took place simultaneously, side by side, in the huge parking lot adjoining the Great America family fun facility. Hundreds of non-Corvette people who were visiting the park turned out as spectators for the performance events.

Guests at Great America on this special weekend were treated to a pleasant surprise. As they wandered about the grounds sampling the selection of 125 rides and amusements, they encountered a series of cars on display that showed the entire production history of Corvette from 1953 to 1980. Display cars were dispersed throughout the park, enabling visitors to get a good view of them without any crowd congestion problems. Ken Wechselberger arranged to have a gleaming yellow 1980 Corvette and the brand new turbo 'Vette Idea Car driven to Great America to be part of this enormous display. These two vehicles attracted a lot of spectator interest. In fact, a few persistent souls who were really excited about the 1980 and the turbo were successful in negotiating test drives in the vehicles.

Overall, the special events of the Great Corvettes Weekend and the entertainment at the Great America Theme Park were a "just right" combination to provide a highly enjoyable outing for both participating Corvette owners and the added non-Corvette crowd of well over a thousand. According to park management officials, the two Great Corvette Weekends staged over the last couple of years have been very successful in terms of promoting attendance among the general public.

As you'd expect, a large scale event like this requires thorough organization and cooperation on the part of clubs, park officials, the resort management, and all of the other parties involved. To outside observers, it was obvious that the sponsoring clubs worked very well together in every phase of planning and operation. And the extra effort that members of all three clubs put into the up-front task

of contacting suppliers and manufacturers for donations for raffle and door prizes was one of the keys to the success of the Spina Bifida fund raising effort.

Much of the credit for making the Great Corvettes Weekend a truly great event must be given to the small core

of hard-working people who were largely responsible for planning and staging the event. On the club side of things, Laurie Manning, NCCC Governor for the Chicago Corvette Club, and Chuck Poulson, President of the Northern Rays Corvette club, provided the event with a first-rate leadership team. Laurie was the planning and promotional arm of the duo. And Poulson was the main man responsible for the painstaking task of first locating all the needed vehicles and then coordinating the total car display that reflected the complete history of the Corvette automobile.

Marriott Great America interests were energetically represented by Scott Frantell, Manager of Sales, and Margie Gillis, Group Sales Manager, who served as event coordinator. It was obvious that these folks spent a lot of time and money promoting the event. As we approached the Chicago area, we began to hear an ongoing series of radio commercials calling listener attention to the event. Later, after checking in at the Lincolnshire resort, we got a similar Great Corvette, Great America promotional message via television.

It seems that the solid working relationship between the three Chicago Clubs and the Great America people is trend-setting. A second Great America facility near San Jose, Calif. recently sponsored a similar event in cooperation with local clubs. West Coast sources indicate that the event was very successful.

We have often heard cries of frustration from club members who have come up against a wall in their attempts to develop something new in the way of club activities. The Chicago area clubs have proven (and the Great America people support this view) that staging a club event as a promotional tool for an existing crowd-attracting facility can be mutually beneficial. Fun, too.

Wolfman Jack handled the awards presentation



Great America and a Great Corvette — 1980 Vintage



Dave McLellan and his sons chat with Dave Lynch, Wisconsin Chevy Dealer



The people who made it all happen take time to pose with three of the characters who roam the park



Corvette News photographer Steve Smith ends up a trophy winner... for the very first time



One of the vintage 'Vettes on display in the park

the
Demon awaits you...



at *Marriott's*
GREAT AMERICA

GREAT CORVETTES

September 20 & 21

Sponsored by: The Chicago Corvette Club and
Northern Rays, Ltd. Corvette Club

- Concours (Sept. 20)
- Corvette Corral
- Gymkhana (Sept. 21)
- Outstanding Corvette Models on Display Inside the Park

SPECIAL GREAT AMERICA
ADMISSION
\$8.00 per person

REGULAR ADMISSION
\$10.95 \$9.95
(12 & over) (Ages 1-11)
plus \$5.00

FOR TICKET & EVENT INFORMATION VISIT

© 2014

FOR SALE: 1968 427/390 Corvette S/N 194678S405403



Two-owner 37k mile matching numbers original unrestored (except paint & white convertible top) M20 4-speed transmission, 3:08 posi rear end, transistor ignition, power steering, power brakes, tinted windows, telescopic steering, head rests, AM/FM stereo radio (included). Ordered in October 1967 and delivered to original owner December 20, 1967. Purchased by the second-owner on June 27, 1977. Car is offered with its tank sticker, Protect-O-Plate, owner's manual, service records.

Has never been presented for judging.

\$50,000

***Selling on behalf of owner's estate:
Ed Wodniakowski #3850
edwilncrs@aol.com***

Trivia

February Trivia Answer - 2024



What is the top speed of a 2024 Corvette Z06 ?

The 2024 Chevrolet Corvette Z06 has a top speed of 195 miles per hour. It can go from zero to 60 mph in 2.6 seconds.

Hint : It is really fast!

Trivia

MARCH 2024

Trivia Question

In what year was the ignition lock move from the dash to the steering column?



Hint: The New York Mets won the World Series that year.

March 2024 – Tech Tip

By Pat Lopardo



How to replace the cabin air filter on a C6 Corvette

2005-2013

The cabin filter is under the hood on the passenger side of the vehicle above the battery. Remove the housing panel by unclipping the 3 clips below the weather seal.

Lift the springs and remove the hatch. Pull gently on each side of the filter. It is a tight fit, but it will gradually work its way out

.
Then install the new filter with the air flow arrow pointing down. Be careful with the clips. If you drop one try to find it as there are no replacements for them.

When I replaced mine, I was surprised how dirty it was. There were leaves and paper stuck to the old filter.

The AC Delco part number is CF139

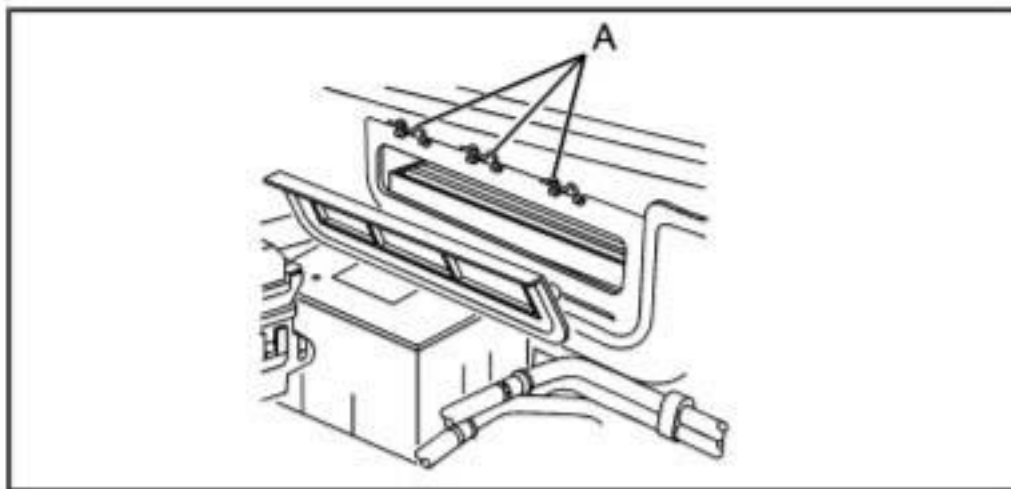

Our Meeting Place



Real Time Sports bar located in Elk Grove Village is a sports bar like you have never seen before. With 50 HD TVs and a 20 foot jumbo screen, we offer all sports games minute by minute. Unbelievable food and awesome drink specials keep our customers coming back for more. We look forward to seeing you soon!

Real Time Sports Bar
Tel: 847-534-5000
1120 W Devon Ave
Elk Grove Village, IL 60007

Advertising in the *NRL REPORTER*

Advertising in the *Reporter* is very simple. First you choose the size and space which best suits your needs and pocketbook and then how long a period you want your ad to run.

Once those decisions have been made, you will need to choose the design of your ad.

If you already have an ad in another publication, we can simply reproduce it for inclusion in the *Reporter*. Or, you may want to use your business card, which works just as well.

If you wish to create a new ad, we can assist you with your design at no additional charge.

Ad Size	One Month	Three Months	Six Months	One Year
1/8 Page (Business card size)	\$2.50	\$7.00	\$13.00	\$25.00
1/4 Page	\$5.00	\$15.00	\$25.00	\$45.00
1/2 Page	\$10.00	\$30.00	\$50.00	\$90.00
3/4 Page	\$15.00	\$45.00	\$75.00	\$140.00
Full Page	\$20.00	\$60.00	\$90.00	\$175.00

Note: The *NRL Reporter* is posted on the *NRL Website* at www.northernrayscorvette.com
That means your ad will reach a bigger audience.



Original Owner: A Trendy Hairstyle Helped This Chicago-Area Corvette Buff Buy a '72 LS5 Coupe in Cash

Santo Scafide sent me a link to an article about Frank Pope's 72 Corvette LS5 that he bought new. It is a great article that Hagerty posted on their website.

Here is the link:

<https://www.hagerty.com/media/car-profiles/original-owner-a-trendy-hairstyle-helped-this-chicago-area-corvette-buff-buy-a-72-ls5-coupe-in-cash/>



There is a link to this article on the NRL Facebook site. Dan Maroney posted the link. Just click on the link.

THE END

