

Technical sheet

# **MHT 10230**

Telehandlers



Capacities	Metric
Max. capacity	23000 kg
Max. lift height	9.65 m
Max. reach	5.80 m
Weight and dimensions	
l2 - Overall length of fork carriage	6.99 m
b1 - Overall width	2.85 m
h17 - Overall height	3.05 m
y - Wheelbase	3.90 m
m4 - Ground clearance	0.49 m
b4 - Overall cab width	0.93 m
a4 - Tilt-up angle	12 °
a5 - Tilt-down angle	105 °
Wa1 - Frame outer turning radius	5.40 m
Unladen weight (with forks)	29300 kg
Standard forks	1800 x 200 x 110
Performances	
Lifting	42 s
Lowering	37 s
Telescope extension	18 s
Retracting the telescope	18 s
Scoop	11 s
Dump	11 s
Engine	
Brand	Mercedes
Environmental standards	Stage IV / Tier 4 Final
Model	OM 934 LA. E4-3
Number of cylinders - Capacity	4 - 5100 cm <sup>3</sup>
Power	176 hp / 129 kW
Max. torque	750 Nm at 1600 rpm
Laden drawbar pull	18500 daN
Transmission	
Type	Hydrostatic
Number of gears (forward/reverse)	2/2
Max. speed of travel (may vary according to the applicable regulation)	25 km/h
Parking brake	Automatic negative parking brake
Service brake	Hydraulic
Hydraulics	
Type of pump	Variable Flow
Hydraulic flow rate - Pressure	205 l/min - 350 bar
Tank capacities	
Engine oil	21 l
Hydraulic oil	290 l
Fuel	315 l
AdBlue® Diesel Exhaust Fluid (DEF)	63 l
Noise & vibration	
Noise at driving position (LpA)	80 dB(A)
Noise to environment (LwA)	107 dB(A)
Vibration on hands/arms	<2.5 m/s <sup>2</sup>
Miscellaneous	
Steering wheels / Driving wheels	4 / 4
Safety	Standard EN 15000 Cab ROPS - FOPS Level 2
Controls	JSM

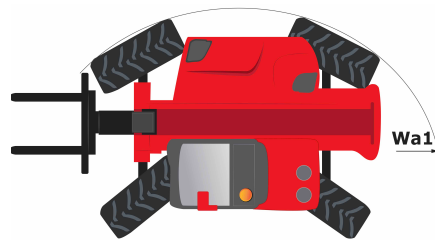
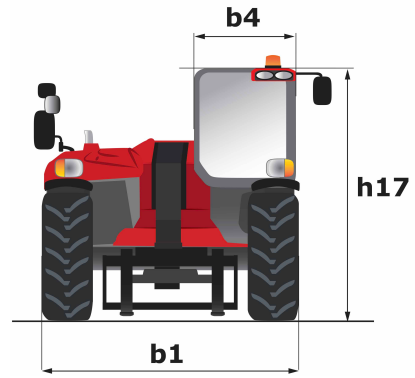
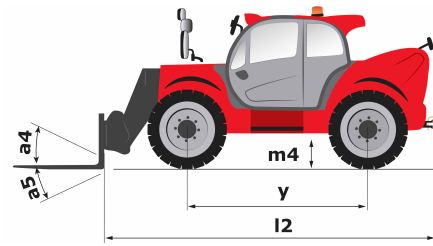

# Load chart

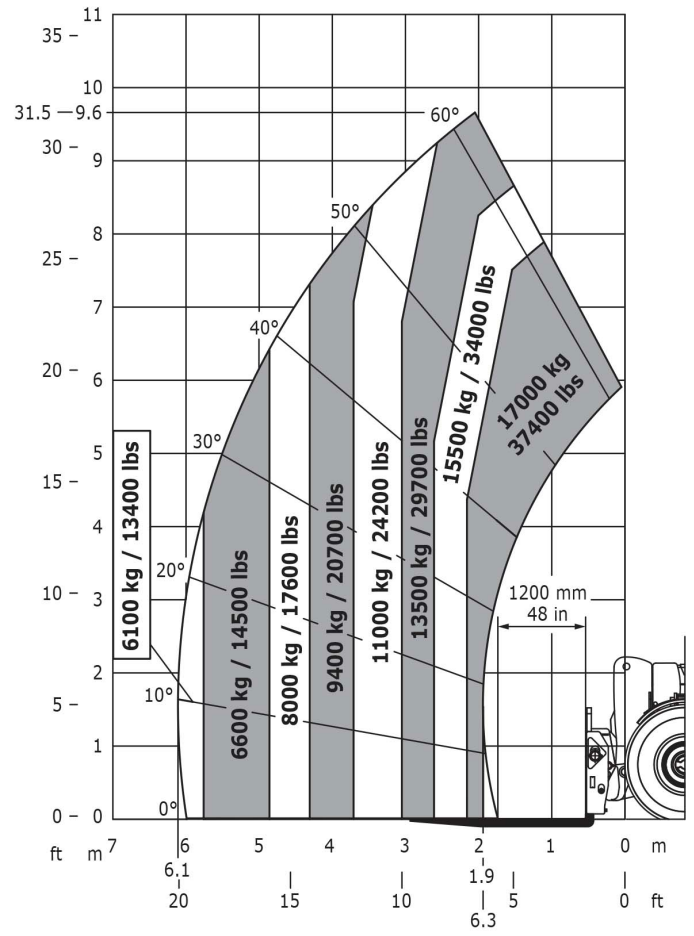
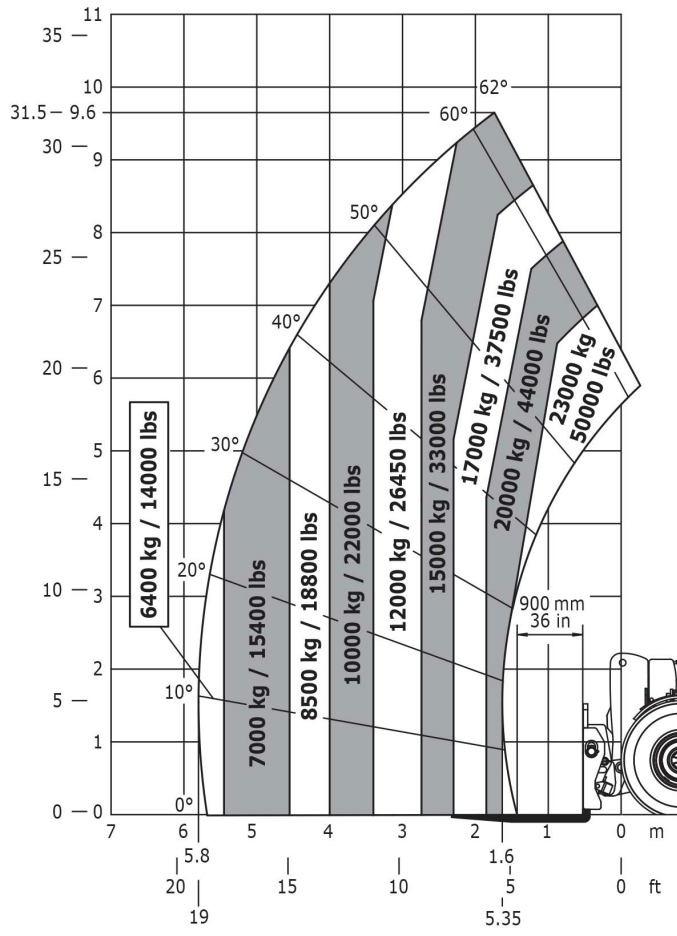

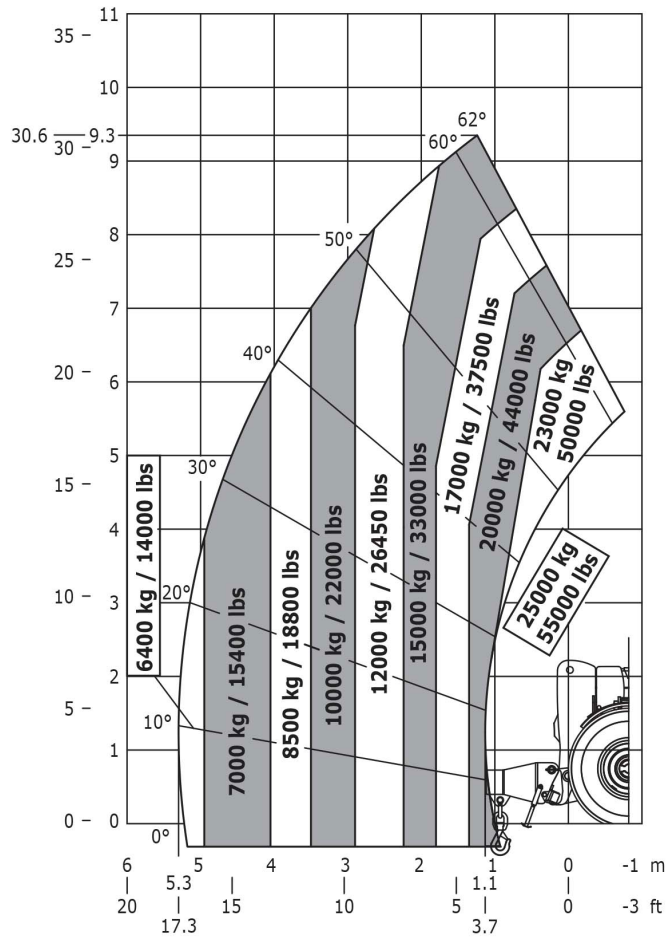

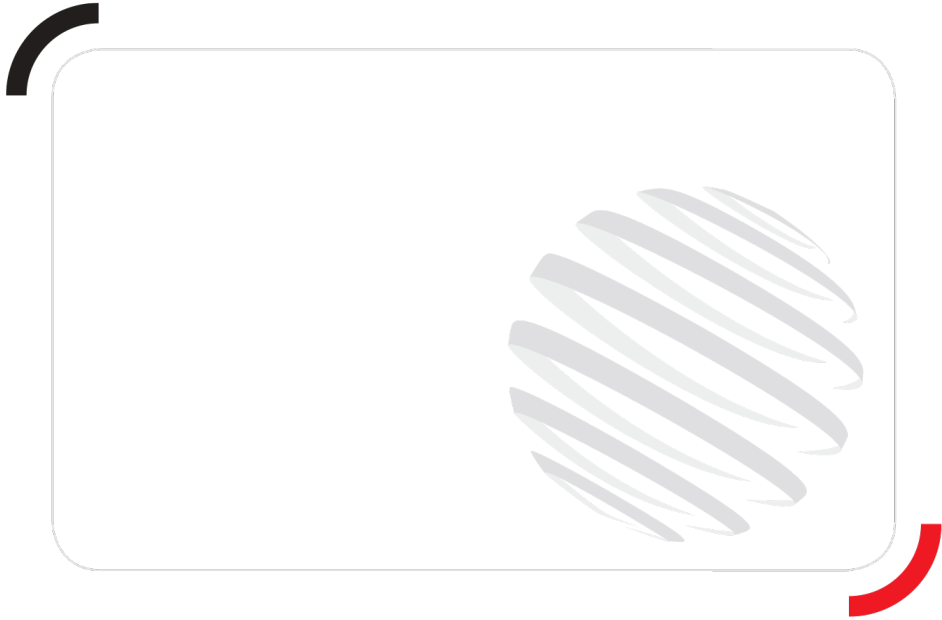

Siège Social  
430 rue de l'Aubinière - 44150 Ancenis Cedex - France  
Tel: +33(0)2 40 09 10 11 - Fax: +33 (0)2 40 09 10 97  
[www.manitou.com](http://www.manitou.com)



This brochure describes versions and configuration options for Manitou products which may be fitted with different equipment. The equipment described in this brochure may be standard, optional or not available depending on version. Manitou reserves the right to change the specifications shown and described at any time and without prior warning. The manufacturer is not liable for the specifications given. For more information, contact your Manitou dealer. Non-contractual document. Product descriptions may differ from actual products. List of specifications is not comprehensive. The logos and visual identity of the company are the property of Manitou and may not be used without authorisation. All rights reserved. The photos and diagrams contained in this brochure are provided for information only.

MANITOU BF SA - Limited company with board of directors - Share capital: 39,547,824 euros - 857 802 508 RCS Nantes