



TURBOFARMER 50.8 - 45.11

Merlo's factories in San Defendente di Cervasca (Cuneo) cover an area of 300,000 m² (with 220,000 m² indoor facilities)



1. Merlo SpA main offices
2. Final assembly lines
3. Lines for assembling components and cabs
4. Moulding of technopolymers
5. Automated storing and shipping centre
6. Machines plus attachments shipping centre
7. Final quality control
8. Technological centre
9. Steel and structural assembly lines centre
10. 3M attachments
11. CFRM (Training & Research Centre)

The Merlo Group

N° 1 for technology and safety

The Merlo brand has always been synonymous with advanced technology in the telehandler field and our history, since 1964, is hallmarked by experience based on determination and passion. The development of complex products, from the idea to the result, from design to sales, means being able to propose orientations for the most competitive markets. The outcome of our efforts are compact, easy to handle telehandlers ensuring incomparable operating performance, comfort, efficiency and safety. At Agritechnica 2013, three important awards were received that clearly demonstrate the technological and innovative superiority of our products:

- Turbofarmer 42.7 Hybrid: Gold Medal for innovation at Agritechnica.
- Turbofarmer II: Machine of the year 2014 in the “handling and logistics” category.
- Multifarmer: Selected as a “milestone” in agriculture.

The new modular Medium Duty and Compact Turbofarmer range was named «Machine of the Year» 2015 at Sima 2015 in the handling and logistics sector.

- Over 1.100 employees
- Surface area of 300,000 m² of which 220,000 m² are indoors
- 90% exports
- 600 dealers all over the world
- 8% of turnover invested in Research & Development
- 54 manufacturing robots



Automated boom bending workstation

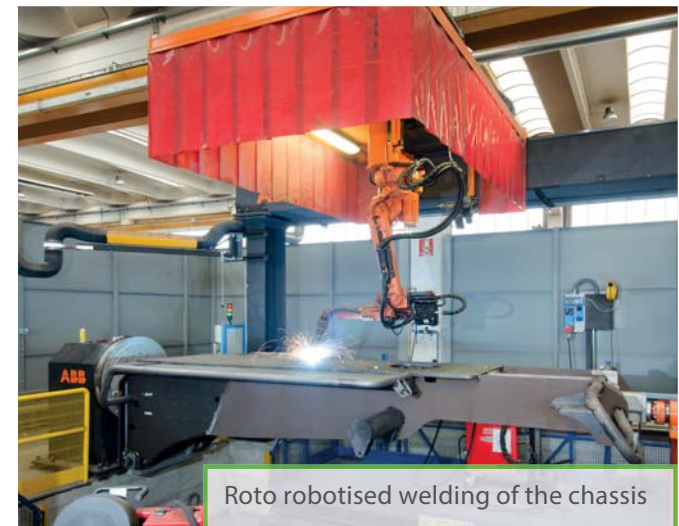

Roto robotised welding of the chassis

Merlo, the inventor of the telehandler and its application in agriculture, presents the new Heavy Duty range



New Merlo Heavy Duty range

The telehandler in agriculture according to Merlo

We were the first to launch a range of telehandlers dedicated to agriculture in 1996.

Today, we proudly present the new generation developed on the strength of experience acquired in 50 years of operations.

- + **Safety**
 - ➔ Cab compliant with ROPS and FOPS level II standards**
 - ➔ M CDC Dynamic load control as standard
 - ➔ Tilt correction as standard
- + **Comfort**
 - ➔ Largest cab in its category
 - ➔ Suspended cab, a unique and patented solution
- + **Efficiency**
 - ➔ -18% consumption with standard EPD
- + **Performance**
 - ➔ Engines 122 HP without particulate filter and 156 HP*
 - ➔ Rear differential lock as standard
- + **Versatility**
 - ➔ Mechanical PTO
 - ➔ Rear hydraulic distributor

* The most powerful machine in its category

** EN ISO 3449/2008, protection level II (highest protection level provided by the norm and equivalent to the fall of a 227 kg object from 5.22 metres)



- **Merlo CDC** system (Dynamic Load Control) as standard
- **EPD -18%** consumption
- **CS suspended cab** the only one in its category
- **Levelling** of the **chassis** for greater **safety**

New Merlo Heavy Duty Family

Concentrated technology

Comfort

- Largest cab on the market 1010 mm
- "CS" cab with one of a kind hydro-pneumatic suspensions

Hydraulic system options

- Load sensing + Flow Sharing pump as standard
- 120 HP version with electronic joystick
- 156 HP version with electronic joystick

Efficiency – Powertrain

- Tier 4 Interim Engines - 122 HP and 156 HP
- 122HP version with Merlo 2-speed hydrostatic transmission
- 156HP version with CVTronic transmission as standard
- EPD – Eco Power Drive – as standard on all versions

Innovative Merlo systems

- Chassis tilt correction as standard
- Tac-Lock rapid coupling of the attachments
- Rear differential lock as standard

Lifting capacity

- Booms from 8 to 11 metres
- Capacities ranging from 4,5 to 5 tons

Safety

- M CDC Merlo dynamic load control
- Cab compliant with FOPS/ROPS

Towing versatility

- Tow hook up to 20 tonnes
- Drawbar
- Hydraulic connections (4 opt.)
- Trailer braking (Pneu/Hydr.)

Versatility in the field

- Mechanical PTO
- Speed 540/1000 that can be selected from cab



The Turbofarmer Heavy Duty range

A version for every requirement

		TF 50.8 T-120	TF 50.8 T-CS-156 CVTRONIC	TF 45.11 T-120	TF 45.11 T-CS-156 CVTRONIC
ENGINE	122 - Tier 4 Interim	X		X	
	156 - Tier 4 Interim		X		X
NEW CAB	Steady	X		X	
	Suspended		X		X
EPD	Eco Power Drive	X	X	X	X
CHASSIS	Levelling	X	X	X	X
SUSPENSIONS	BSS - Boom Suspension System	optional	optional	optional	optional
HYDRAULIC	Load-Sensing + Flow Sharing	X	X	X	X
TRANSMISSION	2 speeds	X		X	
	M CVTronic		X		X
SAFETY	CDC + 8.5" display + automatic attachment recognition	X	X	X	X
INVERTER	Dual Shuttle (Joystick + steering wheel)	X	X	X	X
JOYSTICK	Electronic joystick	X	X	X	X

Broad product offering:

- Available in **2 models** and **4 different** versions

Comfort:

- **Suspended cab** for maximum comfort

- **BSS** boom suspension system

Technological Innovations:

- **CVTronic** + torque + productivity

- **Chassis tilt correction** as standard

Versatility and productivity:

- **PTO** optional
- **2 engines available - 122 HP or 156 HP**
- **2 boom lengths - 8 and 11 m**
- **2 capacities - 4,5 and 5 ton**

Engines & Transmissions

Higher performance and lower consumption

- ➔ The Turbofarmer “Heavy duty” range is equipped with two Tier 4 Interim engines: 90 kW/122 and 115 kW/156 HP
- ➔ Merlo hydrostatic transmission with **EPD (Eco Power Drive) as standard**
- ➔ As always Merlo telehandlers are equipped with hydrostatic transmissions for improved precision, safety and ease of use. The EPD can reduce fuel consumption by 18% giving a real yearly saving.
- ➔ The EPD Top has a “Speed control” **2** button that allows to save the movement speed of the machine and keep it constant. The Eco function, ideal for yard handling operations, limits the motor's rpm, thereby obtaining further savings.
- ➔ In operations with the PTO (optional), the potentiometer **1** allows to set the revs in correspondence with the attachment used (540/1000). The system keeps the revs within the threshold, ensuring the correct rpm for which the attachment is intended, maximizing the performance and productivity of the machine.
- ➔ The self-accelerating Joystick is adopted as standard, through which more speed of the boom's hydraulic movements is possible, thereby optimizing performance. The system activates beyond the threshold of 20% of the joystick's movements.



Reduction in consumption

Merlo CVTronic technology + EPD

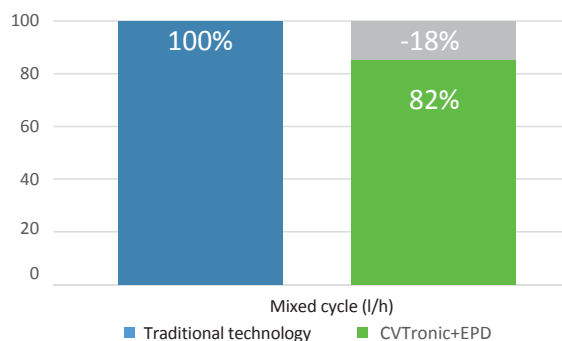

- With the **EPD** system **consumption is reduced by 18%** compared to traditional technologies
- **Speed Control** and **ECO** management as standard with EPD Plus and EPD Top
- **Rpm** management
- Tier 4 Interim **90 kW/122 HP** or **115 kW/156 HP** engines
- **Self-accelerating system** with joystick

Merlo CVTronic

Merlo's own continuous variable transmission version

The CVTronic transmission follows Merlo's traditions in the hydrostatic field and ensures smooth acceleration without interrupting torque from 0 to 40 km/h.

The transmission comprises two axial piston hydrostatic engines powered by the electronically-controlled hydraulic pump. At low work speeds, they function in conjunction to provide maximum torque, with an increase of + 12% with respect to conventional hydrostatic transmissions.

During transport, the second hydrostatic engine is automatically disengaged from the control system and the oil from the pump powers the main hydrostatic engine that pushes the Turbocharger to maximum speed.

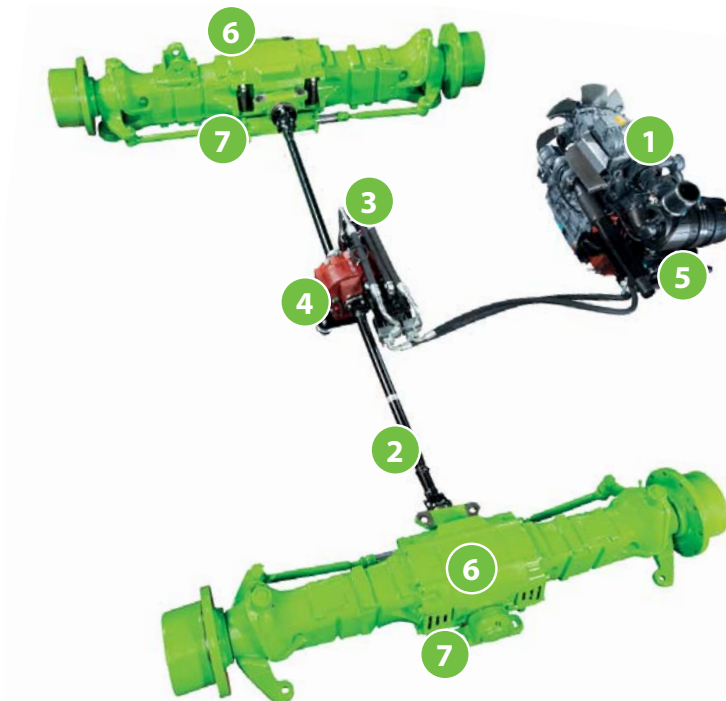

TURBOFARMER

1. Tier 4 Interim Engine
2. Transmission shaft
3. Hydrostatic engine
4. CVTronic transmission
5. Hydrostatic pump
6. Merlo axles
7. Dry disc brakes and parking brake

- **+12% torque** at **low speeds** vs conventional hydrostatic transmissions
- **Accelerations** from 0-40 km/h, smooth and progressive **without interruptions** for a gear change
- **-18% consumption** thanks to the **EPD** system
- **Separate hydraulic and hydrostatic systems**



6

Largest cab in the category

1. Merlo CDC: the patented Merlo safety system that provides new standards of safety.
2. New Joystick with reverse shuttle (duplicated on steering wheel); ergonomic and easy to use.
3. New display makes it possible to display a great deal of useful information for the operator.
4. New air conditioning system in line with automotive standards for fast and effective heating/cooling.
5. Inching-Control: the dedicated pedal provides calibrated movements of the machine.
6. Curved windscreen: maximum visibility and safety in work at height.
7. Differential lock.
8. Drawer.

1

3

4

4

8

2

5

7

Comfort record

World exclusive cab with suspensions

[Pressurized cab]

The new cab was developed to ensure record-breaking comfort for our users.

At 1010 mm, it is the largest in its category, yet even acoustic and thermal comfort involved detailed design; the cab is also pressurised to prevent dust entering the cockpit. The air conditioning system is completely new and was developed based on automotive standards, halving the warm-up and cool-down times, guaranteeing an optimal temperature in all conditions. The new Merlo cab can now reach an internal temperature of 22°C

with an external temperature of 43 °C and full sunlight and an internal temperature of 26°C with an external condition of -15 °C and no solar irradiation. The inlet vent is located on the side of the cab away from potential sources of dust and dirt. Inside, there are 8 vents (three for defrosting the windscreen) for optimal conditioning comfort.

A cab with suspension system is also available - a feature that only Merlo offers in the telehandler field: the pneumatic suspensions provide the best comfort in its class.

AIR-CONDITIONING SYSTEM



The air flow is distributed evenly inside the compartment and reaches all areas

- 1010 mm wide
- The cab is the largest in its category
- New A/C system
- Suspended cab "CS" for maximum comfort

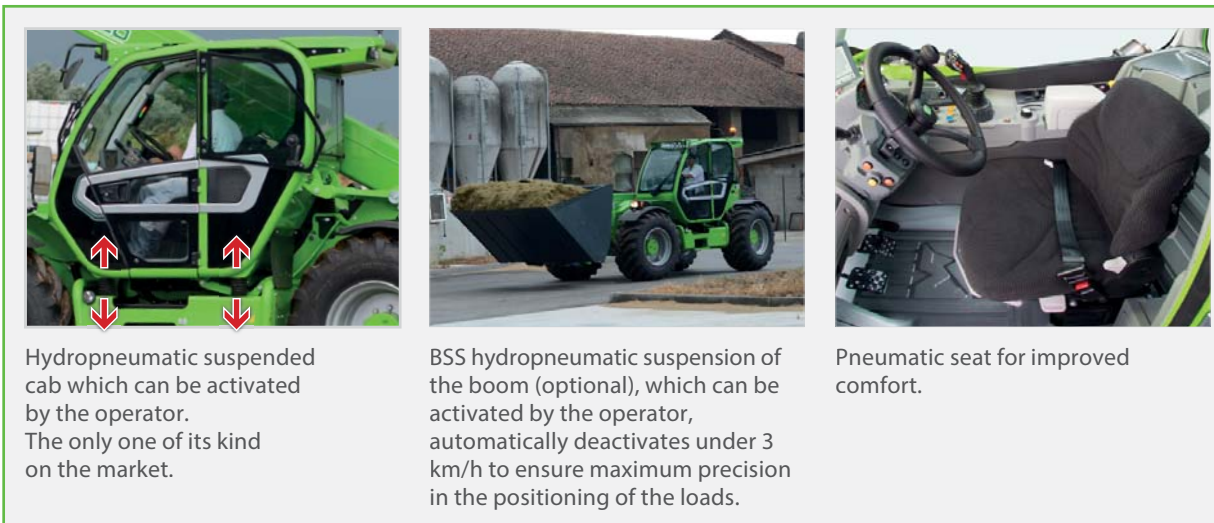

Hydropneumatic suspended cab which can be activated by the operator. The only one of its kind on the market.

BSS hydropneumatic suspension of the boom (optional), which can be activated by the operator, automatically deactivates under 3 km/h to ensure maximum precision in the positioning of the loads.

Pneumatic seat for improved comfort.



CDC as standard on the entire range safety before everything else!



MERLO DYNAMIC LOAD CONTROL

1. with attachment in use
2. Work area
3. Load positioning (in work area)
4. Load detection menu
5. Operating parameters
6. Work information
7. Stability index



The MDC system verifies the conditions of longitudinal stability in real time and provides the operator with an indication of the percentage of usage of the maximum stability condition. Maximum safety.



MANUAL RECOGNITION OF THE ATTACHMENT

A special selector switch allows to configure the type of attachment used manually or automatically. Distance values that can be selected are:

- 0.5-0.6 metres
- 1.5 metres
- 4 metres

- A.** Manual recognition selector
- B.** Control for managing the M CDC screens

Merlo Dynamic Load Control

Safety as standard for everyone

The Merlo Group considers safety as an absolutely essential value and this is why it invented the M CDC system. The objective is to allow every operator to work in total safety by fully exploiting the potential of the telehandler and the attachment used.

The Merlo CDC system means that the Turbofarmer automatically recognises the attachment fitted and consequently calibrates its performance in relation to specific load charts.

The operator can check at any time the dynamic equilibrium of the vehicle, thanks to the led on the screen or the traffic light on the front upright.

For manoeuvres that may give rise to a telehandler stability risk, the M CDC system will block the boom and prevent any further movements that may worsen the situation.



Rear video camera (optional)

Automatic attachment recognition



Sensor on the attachment.



Sensor on the carriage.

- **Safety** beyond even EN15000 standards



- **Automatic attachment*** recognition

- **8.5" display** in cab

- **ROPS and FOPS protection**, no impact on comfort

** Valid for attachments built in Merlo factories and fitted with the M CDC sensor



Boom handling:
speed and precision

Merlo precision and technology

Being unique is our trademark

Merlo produces the booms mounted on its telehandlers in-house and has developed unique technologies to make them strong yet lightweight, protect handling mechanisms against accidental blows and allow users to position the load in the most precise manner possible.

- ✓ Boom sheet metal welded on the boom's neutral bending axis
- ✓ Cartridge extension system and hydraulic hoses protected inside the boom, thanks to a patented solution that is easy to access if maintenance is needed
- ✓ Tac-Lock: hydraulic attachment clamping system from the cab
- ✓ Levelling: system for correcting tilt, built into the chassis, allowing the operator to correct ground slopes and work in complete safety



- **Lighter** but **stronger** booms: robotised welding on the neutral axis, area with less strain
- **Extension mechanism** well-protected inside the boom
- **Chassis** levelling

One telehandler, a multitude of applications



PTO coupling selector



Towing hooks & PTOs

Telescopic versatility

We are determined to ensure that Merlo telehandlers are increasingly multi-purpose in order to maximise return on investment for our clients. The new Turbofarmer range takes this concept to even higher limits. As well as conventional handling, logistics and maintenance applications typical of telehandlers, the new Turbofarmers allow you to use them even for towing, thanks to the towing hook type-approved for 21 tons and the pneumatic and hydraulic trailer braking system.

For tasks with towed attachments requiring PTOs, both versions of 122 HP and 156 HP are available with a mechanical PTO to allow operations with *unifeed* mixer trucks, rotary balers, seeders and sprayers.



- **Mechanical PTO 540/1000** that can be selected from cab
- Net power at the PTO **110 HP** and **135 HP** depending on the engines used
- **Towing hook of 21 tons** with pneumatic and hydraulic braking
- **Rear hydraulic connections**
- **Braking system**, hydraulic or pneumatic

Axles and brakes, effective and efficient

Real benefits

Our Turbofarmer "Heavy Duty" telehandlers are equipped with planetary axles designed, engineered and manufactured in-house to ensure maximum strength, excellent steering and ground clearance the "best in its class", 450 mm, with 440/80-24 and 490 mm 600/55-26.5 (optional).

All of our Turbofarmer "HD" telehandlers are equipped with 4 dry disc brakes that allow for consistent reduction of friction and, thus, fuel consumption in comparison to oil bath discs.

The parking brake is automatically engaged when the engine is switched off.

The operator can also engage it at will when the engine is running for stationary work on slopes.

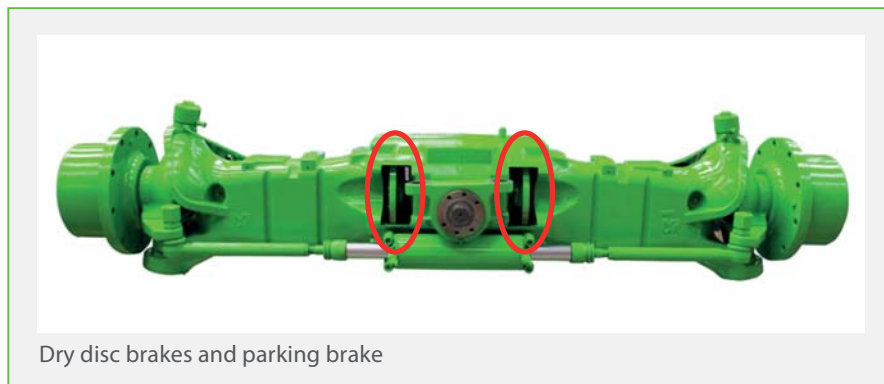

THREE STEERING MODES:

FRONT WHEEL STEERING MODE



FOUR WHEEL COORDINATED STEERING



CRAB STEERING



- Axles **conceived, designed and produced** in-house by Merlo
- Up to **490 mm clearance** off the ground, the best in its category
- **Three steering modes**
- **Dry brakes to reduce friction and consumption**
- Automatic **parking brake** system for when the engine switches off

From the idea to development of multi-applicability

More efficiency and productivity thanks to Merlo

Merlo adopts simple and effective guidelines in the evolution of the product. From conception to development, everything is studied, designed and created in the Group's plants. This simple "rule" also applies to attachments. Backed by years of experience, Merlo's technicians have developed a wide range of attachments, divided by type and load capacity. This standard makes it possible to adapt tested and interchangeable production attachment to allow for targeted uses, with the intention of facilitating work and reducing its execution times.

BALE FORKS



MANURE FORK WITH CLAW

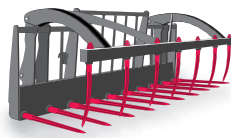

GRIPPERS FOR BALES

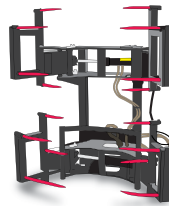

MULTI-PURPOSE LOADER WITH CLAW

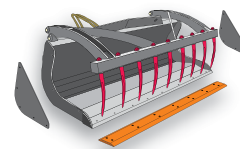

LOADERS

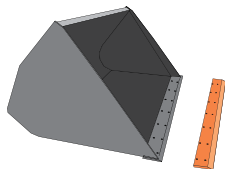

HOOKS/LIFTING BOOMS



GRIPPERS FOR WRAPPED BALES

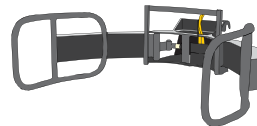

PLATFORMS



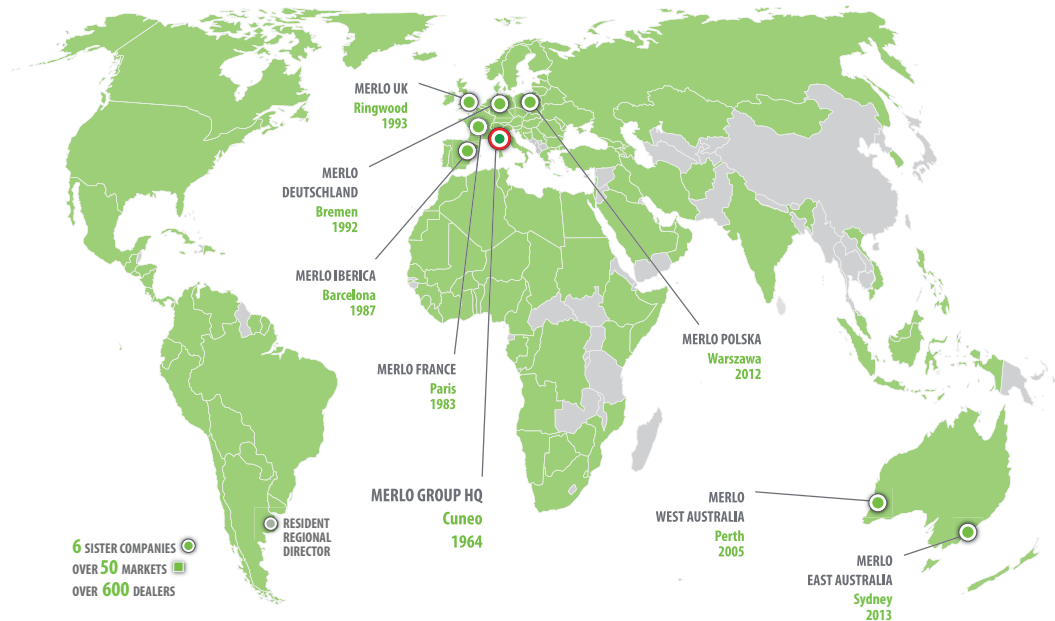

TRAINING CENTRE

The Merlo Training and Research Centre (CFRM) has made safety training and instruction in the use of the machine its mission. The CFRM provides training courses for operators of person-carrying overhead platform, forklift trucks, telehandlers, cranes, earth-moving machinery, agricultural and forestry tractors, snow ploughs and urban cleaning vehicles.



Countries where Merlo is a market leader



MOVIMATICA MERLO INFOMOBILITY

Is the new system, conceived and built within the Merlo Group, for managing vehicles: it enables GPS radio-localisation in real time, monitoring operation and use, receive and manage malfunction or burglar alarms and also send commands for handling events via the internet.

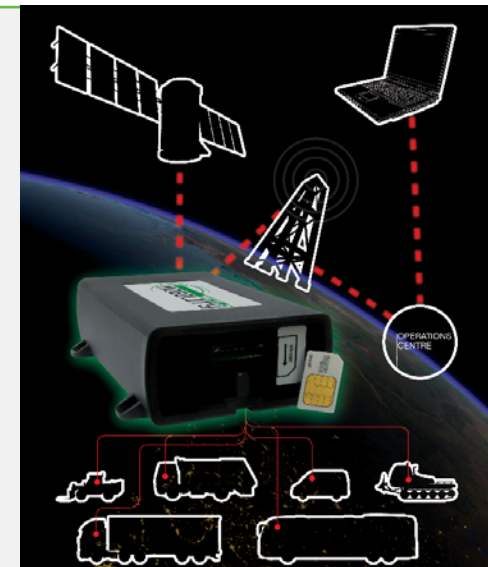

THE MERLO WORLD

In a globalised world, **the customer always comes first!**

From excellent products to excellent service. In 2008, Merlo has adapted its production process to meet the needs of the ISO 9001 quality control system. The process is perfected and improved continuously.

At the same time, the foundations have been laid to put the Customer first, implementing investments aimed at Services such as Financing, Training Assistance, Spare parts and Telematic Means such as remote diagnostics, thanks to the Merlo Mobility project.

Automatic spare parts warehouse	2011	2014
Storage volume	1000 m ³	10.000 m ³
Filling	100%	85%
Percentage of codes managed	50%	86%
Percentage of Lines managed	65%	94%
Pick-up time	90"	30"
Number of codes	8.000	17.000

NEW PARTS CENTRE

The new spare parts warehouse covers an area of 7,000 m², with storage capacity for of 10,000 m³ for a total of 20,000 different codes. Furthermore, it can automatically manage 94% of the order lines that are processed daily, with an average withdrawal time of 30" per line.

The first fill per order line is over 99% with delivery times for urgent orders within 24 hours.



Order processing and shipment area

TECHNICAL INFORMATION	TF 50.8 T-120	TF 50.8 T-CS-156 CVTRONIC	TF 45.11 T-120	TF 45.11 T-CS-156 CVTRONIC
Total unladen mass, without forks (kg)	9050	9350	9450	9750
Maximum capacity (kg)	5000	5000	4500	4500
Lifting height (m)	7,8	7,8	10,6	10,6
Maximum reach (m)	4,2	4,2	7	7
Maximum operating height (m)	7,8	7,8	9	9
Maximum operating reach (m)	1.4	1.4	1,9	1,9
Capacity at maximum height (kg)	5000	5000	3500	3500
Capacity at maximum reach (kg)	1600	1600	650	650
Turbo motor (displacement/cylinders)	3.6/4	4.0/4	3.6/4	4.0/4
Tier 4 Interim motor power (kW/CV)	90/122	115/156	90/122	115/156
Maximum speed (km/h)	40	40	40	40
BSS hydro-pneumatic boom suspension	○	○	○	○
Fuel tank (l)	150	150	150	150
Hydraulic gear pump (bar-l/min)	-	-	-	-
Hydraulic Load-Sensing pump (bar-l/min)	210/150	210/150	210/150	210/150
Flow Sharing Distributor -	●	●	●	●
Hydraulic oil tank (l)	96	96	96	96
FOPS (ISO 3449) and ROPS (ISO 3471) cab	●	●	●	●
Electromechanical joystick	-	-	-	-
Electronic joystick	●	●	●	●
Hydrostatic transmission	●	●	●	●
Differential lock (A+P - P)	A ○ - P ●	A ○ - P ●	A ○ - P ●	A ○ - P ●
Dual Control Reverse Shuttle (joystick/steering wheel)	●	●	●	●
Inching Control progress control from pedal	●	●	●	●
Permanent four-wheel drive	●	●	●	●
Four-wheel steering	●	●	●	●
Automatic parking brake (when the engine switches off)	●	●	●	●
Work headlights on cab (2 A + 2 P)	●	●	●	●
LED work headlights on cab	○	○	○	○
Change of speed	2 speeds	CVTronic	2 speeds	CVTronic
"CS" Suspended cab	-	●	-	●
Tilting chassis (tilt correction)	●	●	●	●
EPD Eco Power Drive	EPD Top	EPD Top	EPD Top	EPD Top
Mechanical PTO (540/1000)	○	○	○	○
M CDC Dynamic Load Control	●	●	●	●
Standard tyres	440/80 R24	440/80 R24	440/80 R24	440/80 R24
Type approval as an agricultural tractor	○	○	○	○

● As standard. ○ On request.

TECHNICAL INFORMATION



TF 50.8 WITH FORKS

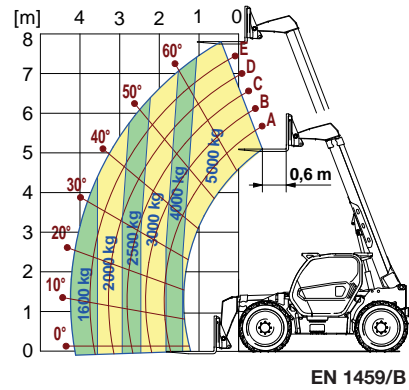

TF 45.11 WITH FORKS

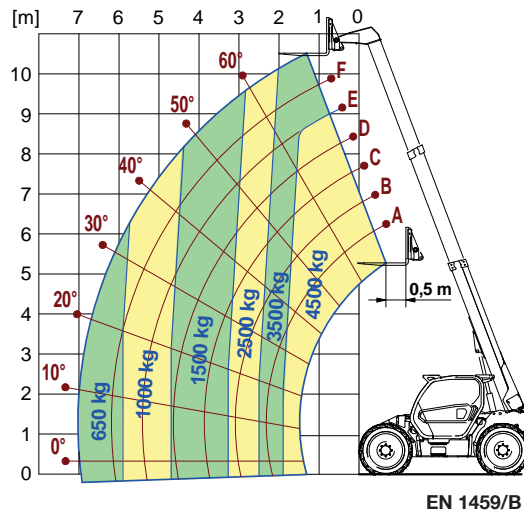

TURBOFARMER 50.8 DIMENSIONS

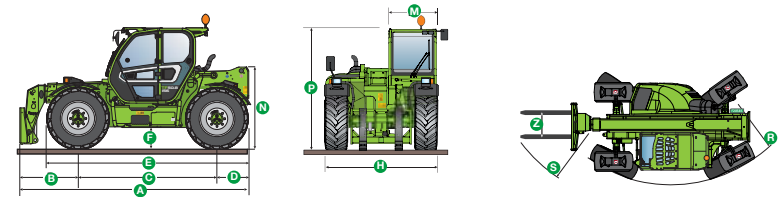

A (mm)	4835	M (mm)	1010
B (mm)	1220	N (mm)	1630
C (mm)	2920	P (mm)	2525*
D (mm)	670	R (mm)	4080
E (mm)	4240	S (mm)	4970
F (mm)	450	Z (mm)	850
H (mm)	2350	Tires 440/80 R24	

* CS models 2585 mm

TURBOFARMER 45.11 DIMENSIONS

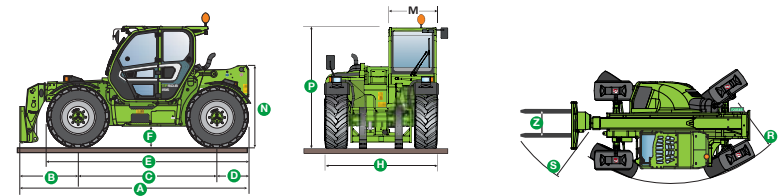

A (mm)	4970	M (mm)	1010
B (mm)	1380	N (mm)	1630
C (mm)	2920	P (mm)	2525*
D (mm)	670	R (mm)	4080
E (mm)	4240	S (mm)	5050
F (mm)	450	Z (mm)	850
H (mm)	2350	Tires 440/80 R24	

* CS models 2585 mm

OVER 50 YEARS OF CONSTANT COMMITMENT TO WORKING TOGETHER WITH YOU

- 1964** - Establishment of the Merlo Group
- 1966** - DM and DBM: the first dumper and the first self-loading concrete mixer
- 1981** - SM: the world's first telescopic handler
- 1987** - Panoramic: the world's first telehandler with side engine
- 1991** - Roto: the world's first telehandler with rotating turret
- 1996** - Turbofarmer: the first telehandler in Europe type-approved as an agricultural tractor
- 1998** - P20.6: the ultra-compact telehandlers
- 2000** - Multifarmer: the first agricultural tractor with telescopic boom
- 2001** - MM: the first forestry attachment-carrier
- 2010** - Hybrid: the first diesel/electric hybrid telehandler
- 2012** - Modular: a new concept of telescopic handler
- 2013** - Three important awards at the Agritechnica in Hanover:
 - Hybrid 42.7: gold medal for technological innovation
 - Turbofarmer II range: "machine of the year 2014"
 - Multifarmer 40.9: "a milestone in agricultural machinery"
- 2015** - New modular Medium Duty and Compact Turbofarmer named "machine of the year" 2015 at Sima in Paris



MERLO S.P.A.

Via Nazionale, 9 - 12010 S. Defendente di Cervasca - Cuneo - Italia

Tel. +39 0171 614111 - Fax +39 0171 684101

www.merlo.com - info@merlo.com

The Telehandlers outlined in this documentation can be equipped with optional or special accessories that are not included in standard equipment but only on request.

In certain countries, not all models or attachments may be available because of market or regulatory restrictions.

Technical data and information are up-to-date at the time of printing this documentation. Merlo reserves the right to make modifications arising from natural technological evolution without any obligation on its part.

Your trusted Merlo Dealer will be delighted to provide you with all updates concerning our products and services.