



LEHRY VALVES

Where flow and pressure meets quality



CERTIFICATE

The Certification Body of TÜV SÜD South Asia Private Limited certifies that

Lehry Instrumentation & Valves Pvt. Ltd
New No. 78 / Old No. 51 Sembudoss Street, Parrys Chennai- 600001, Tamilnadu, INDIA

has implemented a Quality Management System in accordance with **ISO 9001:2015** For Scope of

Marketing and Sales of Ball, Gate, Globe, Check, Butterfly valves, Strainer and Accessories for Over Head Tank Level Controller and Automatic Meter reading, Trading of Instruments Like Pressure & Temperature Gauge, Flow meters, Transmitters and Electrical Control System

The certificate is valid from **2016-01-28** until **2021-01-27** Subject to successful completion of annual periodic audits. Further certifications regarding the future of this certificate may be obtained by contacting the certifier on body.

Certificate Registration No: **99 100 15933**
Date of Initial certification : **2016-01-28**

TÜV SÜD South Asia Pvt. Ltd. - TÜV SÜD House - Salt Lake - Kolkata (East) - Kolkata - 700172 - Westbengal - India

ISO Certificate

CERTIFICATE OF COMPLIANCE

Certificate Number: 20190627-EX28043
Report Reference: EX28043-20190416
Issue Date: 2019-JUNE-27

Issued to: **LEHRY INSTRUMENTATION & VALVES PVT LTD**
NO 78 (OLD NO 51) SEMBUDOSS STREET I, PARRYS P.O BOX NO 1596 CHENNAI, TAMIL NADU 600001 INDIA

This certificate confirms that representative samples of **Butterfly Valves**
Butterfly valve: LIV-BFV-DI-DFM-006, LIV-BFV-DI-DFM-001

Have been investigated by UL in accordance with the Standard(s) indicated on this Certificate.

Standard(s) for Safety: **UL 1091 - Standard for Butterfly Valves for Fire Protection Service**

Additional Information: See the UL Online Certifications Directory at <https://qpl.uspscpector.com> for additional information.

This Certificate of Compliance does not provide authorization to apply the UL Mark. Only the UL Follow-Up Services Procedure provides authorization to apply the UL Mark.

Only those products bearing the UL Mark should be considered as being UL Certified and covered under UL's Follow-Up Services.

Look for the UL Certification Mark on the product.

Page 1 of 1

UL Certificate

bsi.  By Royal Charter

Certificate of Constancy of Performance

This is to certify that: **Lehry Instrumentation and Valves PVT Ltd**
78/51, Sembudoss Street Parrys, Chennai Tamilnadu 600001 India

Holds Certificate Number: **0086-CPR-661898**

In respect of: **EN 331:1998+A1:2010 Manually operated ball valves and closed bottom taper plug valves for gas installations in buildings.**

In compliance with Regulation 305/2011/EU or the European Parliament and of the Council of 9 March 2011 (The Construction Products Regulation or CPR), this certificate applies to the above construction product. This certificate attests that all the provisions concerning the assessment and verification of constancy of performance described in Annex ZA of the above standard(s) under system 1 are applied and that the product fulfils (products fulfil) all the prescribed requirements set out above. This certificate remains valid as long as the test methods and/or factory production control requirements included in the harmonised standard(s), used to assess the performance of the declared essential characteristics, do not change and the product(s), and the manufacturing conditions in the plant(s) are not modified significantly.

For and on behalf of BSI, a notified Body for the above Regulation (Notified Body Number 0086): 
Chris Lewis - Certification Director, Product Certification

First issued: 2018-10-31
Latest Issue: 2018-10-31

Page: 1 of 2

...making excellence a habit[®]

CE Certificate for Gas Services

NSF International
789 N. Dixboro Road, Ann Arbor, MI 48105 USA

RECOGNIZES

Lehry Instrumentation and Valves Pvt Ltd.
India

AS COMPLYING WITH NSF/ANSI 61, 372 AND ALL APPLICABLE REQUIREMENTS. PRODUCTS APPEARING IN THE NSF OFFICIAL LISTING ARE AUTHORIZED TO BEAR THE NSF MARK.

January 10, 2019
Certificate# CU453870 - 01

Theresa Bellish
General Manager, Water Systems

NSF Certificate for Drinking Water

FM APPROVED

Certificate of Compliance

This certificate is issued for the following:
MODEL LIV-BV-LERS-003 BRASS BALL TYPE VALVES

Prepared for:
Lehry Instrumentation & Valves PVT. LTD.
New No.78/Old No.51 Sembudoss Street, P.O.No.1596 Chennai 600001 India

FM Approvals Class: 1140
Approval Identification: 0003054064 Approval Granted: November 24, 2014

To verify the availability of the Approved product, please refer to www.approvalguide.com

Said Approval is subject to satisfactory field performance, continuing Surveillance Audits, and strict conformity to the construction as shown in the Approval Guide, an online resource of FM Approvals.

Richard B. Dume
Manager, Fire Protection
FM Approvals
1151 Boston-Providence Turnpike
Newwood, MA 02062

Member of the FM Global Group

FM Certificates for Fire Fighting Range

BUREAU OF INDIAN STANDARDS

Type/Size/Grade/Variety and Brand Name for CML No. 9534789

Date: 06/06/2018

Brand Name: LEHRY - LP

Type/Size/Grade/Variety: Flanges, wafer short type, regulating type. Nominal pressure and size PN 1.0 DN 40-500mm, class 125. Flangeless, wafer short, Tight shut-off, Manually operated, Class 125, PN 1.0 DN 40-300 mm. Flangeless, Wafer neckless, light shut-off, Manually operated, Class 150, PN 1.0 DN 350-600mm, Class 150, PN 1.0 DN 350-600mm

*** END OF REPORT ***

Developed By: NTC Page 1 of 1

BUREAU OF INDIAN STANDARDS

Type/Size/Grade/Variety and Brand Name for CML No. 9988630

Date: 17/06/2018

Brand Name: LEHRY - LP

Type/Size/Grade/Variety: SWING CHECK TYPE REFLEXION-RETURN VALVES FOR WATER WORKS PURPOSES WITH DOUBLE FLANGED ENDS CONSTRUCTION OF BODY WITHOUT BYPASS ARRANGEMENT, IN PRESSURE RATING (i.e. SIZE) FROM 50mm (2") & INCLUDING 300mm SWING CHECK TYPE REFLEXION-RETURN VALVES FOR WATER PURPOSES WITH DOUBLE FLANGED END CONSTRUCTION OF BODY WITH BYPASS ARRANGEMENT, IN PRESSURE RATING (i.e. SIZE) FROM 50mm (2") & INCLUDING 300mm.

*** END OF REPORT ***

Developed By: NTC Page 1 of 1

BUREAU OF INDIAN STANDARDS

Type/Size/Grade/Variety and Brand Name for CML No. 9994625

Date: 17/06/2018

Brand Name: LEHRY - LP

Type/Size/Grade/Variety: Non rising stem type Cast Iron Steam Valve for Water Work Purposes for size 30mm upto and including 300mm, Preferred Body Dimension (PD) Nominal Pressure Rating (PN) 1.1, 1.6 and size 350 to upto and including 600mm PN 1.6 without by-pass arrangement

*** END OF REPORT ***

Developed By: NTC Page 1 of 1

BIS Certificates for water Services

INTRODUCTION

Lehry Instrumentation And Valves Pvt. Ltd., has been a part of the Industrial and Infrastructure Industry for 69 years now, very soon entering into the seventh decade of our expertise. The company was founded in the year 1950 under the name LEHRY Brothers, that started off as Importers of Building Construction Products. It has stood Primary as distributors for many years for market renowned brands and gained expertise through constant learning and product feedback from customers.

In the year 2006, under the new Directorship of Our Managing Director Mr ABBAS LEHRY and his vision to take the company to greater heights, Lehry made a bold strategic move into the manufacturing segment, under a New Brand Name LEHRY VALVES. Guided by years of experience in the industrial and Infrastructure segment, the MD paved the way for the company and introduced newer better developed products suited for the fields of Plumbing, FireFighting and HVAC, making sure the products always had an edge over the others and were in tandem with current technological advancements and code requirements in its respective fields.

In the year 2016, the Management decided to bring in international standards into the country that would owe to better health governance, and became the first INDIAN manufacturing company to produce lead free products, and ever since have been advocating campaigns country wide for local codes and manufactures to adapt, for a safer healthier tomorrow. The LEHRY management believes that manufactures have a social responsibility and have to take the big leap forward towards producing sustainable and **GREEN** Products.

By the year 2019, Lehry expanded rapidly into Major Metropolitan Cities Pan India and are manufacturing products both National-ly and Internationally. With constant investments in R&D, LEHRY VALVES is able to keep up with market demands and also is able to be an effective solution provider for its wide range of clients.

LEHRY VALVES has strived to design and Introduce many products into the market that have helped in abundance with water conservation, water flow & pressure control, and water distribution applications such as sophisticated Wireless Water Metering & Monitoring Systems, Automatic Control Valves, Automatic Overhead and Pump Controlling Systems, etc.,

LEHRY VALVES now also bears many certifications such as NSF approval implying products are compliant for safe drinking water, FM & UL approval for Firefighting, CE Approval for GAS Application etc and has gained the approval of many renowned clients from Private, Government and Industrial Sectors and also renowned consultants PAN India. By the constant support of our peers, loyal clients and colleagues, LEHRY VALVES will continue to grow at a faster pace with continued social and economic contributions for the Country and the World.

Some of our Prestigious Clientele



LEHRY VALVES
Where flow and pressure meets quality

www.lehryvalves.com

SL.No.	PARTICULARS	PAGE No
1.	Lead Free Ball Valve / Forged Brass Ball Valve / Forged Brass Bib Cock	01
2.	Butterfly Valve with ISI / NSF / FM & UL Mark	02
3.	Brass & PP Strainer / Y-Type Strainer & T-Type Strainer	03
4.	Brass Check Valve/ Dual Plate Check Valve / Reflux Valve / Silence Check Valve	04
5.	Sluice Valve with ISI Mark / Air Release Valve / Foot Valve / Ball Type NRV & Foot Valves	05
6.	Automatic Over Head Tank Controlling Systems	06
7.	Water Meter AMR Systems	07
8.	Water Hammer Arrestors	08
9.	Pressure Reducing Valves	09
10.	Automatic Control Valve	10 & 11
11.	Singlejet, Multijet & Multijet Vertical Type Water Meters	12
12.	Volumetric & Irrigation Water Meters	13
13.	Woltmann Type Water Meters	14
14.	Electromagnetic Flow Meters	15
15.	Ex-Stem Ball Valve with Strainer, Balancing Valve Screwed & Flanged	16
16.	Pr. Independednt Balancing & Control Valve	17
17.	Dynamic Flow Automatic Balancing valve	17
18.	Electrical 2 / 3 / 4 Way Control Valve Screwed	17
19.	FCU Valve Package Unit, UL & FM Approved Swing Check Valve	18
20.	UL & FM OS&Y Type Gate Valve Flanged End	19
21.	UL & FM NRS Type Gate Valve Flanged End	19
22.	Vertical Type Post Indicator Valve	19

LEAD FREE BRASS BALL VALVE

LEHRY MAKE Lead Free Brass Ball Valve Screwed End, which is recommended for Green Building Certification. Suitable for domestic water services. Also it has FM approved for Fire Fighting applications.

Features :

- Flat lever handle with decromet Plating for Anti Rust.
- Body Lead Free Brass as per C46500 standard
- Minimum and maximum working temperatures : -20°C to 120°C in absence of steam.
- Threads ISO 228 (equivalent to DIN EN ISO 228 and BS EN ISO 228).

Specification :

- Body & Bonnet : Lead free brass (C46500)
- Ball 1/4" - 1" : Lead free brass (C46500)
1 1/4" - 2" : Stainless Steel
- Stem 1/2" - 3/4" : Lead free brass (C46500)
1" - 2" : Brass as per (C36000)
- Handle : Steel with Decromet plate to prevent corrosion.
- Seat : PTFE
- Size : DN 8 to 50 (1/4" - 2")
- Pressure Rating : 1/4" - 1" : PN 30

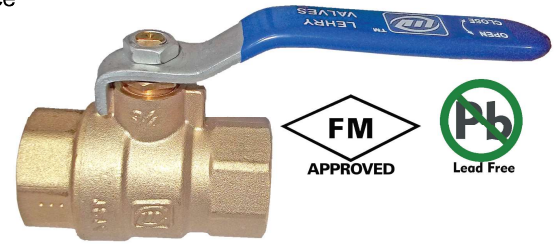

LIV-BLV-LFBS-003

Typical Chemical Composition of Lead Freer Brass Valves									
Standard C46500		Cu	Pb	Ni	Sn	Fe	As	Zn	Impure
	Min%		59	0.2	-	1.0	0.1	0.02	Balance
Max %		62	0.2	-	1.0	0.1	0.06	Balance	0.4

FORGED BRASS BALL VALVE

LEHRY MAKE Forged Brass Ball Valve Screwed End, Suitable for domestic water services, heating, air-conditioning plants and compressed air systems

Features :

- Flat lever handle with decromet Plating for Anti Rust.
- Body in nickel-plated brass as per CW617N standard.
- Minimum and maximum working temperatures: -20°C to 120°C in absence of steam.
- Threads ISO 228 (equivalent to DIN EN ISO 228 and BS EN ISO 228).

Specification :

- Body & Bonnet : Brass with Nickel Plated CW617N
- Ball : 58-2A Brass with Hard Chrome Plated
- Stem : 58-2A Brass
- Seat : PTFE
- Handle : Steel Decromet Plate to prevent Corrosion
- Size : DN 8 to 100 (1/4" - 4")
- Pressure Rating : 1/4" - 1" : PN 30
1 1/4" - 2" : PN 25
2 1/2" - 4" : PN 16



LIV-BLV-BS-001

Typical Chemical Composition of Brass Valves								
Standard CW617N		Cu	Pb	Ni	Sn	Fe	Al	Zn
	Min. %		57.0	1.6	0.0	0.0	0.0	0.00
Max. %		59.0	2.5	0.3	0.3	0.3	0.05	Balance

BRASS BIB COCK

LEHRY MAKE Forged Brass Bib Cock Screwed End, Suitable for domestic water services.

Features :

- Male Threads.
- Body in nickel-plated brass, Hose connecton in Brass.
- Minimum and maximum working temperatures: -20°C to 120°C in absence of steam.
- Threads ISO 228 (equivalent to DIN EN ISO 228 and BS EN ISO 228).

Specification :

- Body & Bonnet : Brass with Nickel Plated Hpb57-3
- Handle : Q235
- Seat : PTFE
- Ends : Female / Female Threads



LIV-BC-BS-001

LEHRY MAKE Butterfly Valves with default extended neck are most suitable for various sectors In the Plumbing applications. These Valves can be integrated with a consistent range of actuators to create complete automation packages.

Features :

- No pins between shaft and disk connection; this eliminates the possibility of electrolytic corrosion
- Low Torque design contributing to excellent low actuator torque selection
- Self lubricated plain bearings for both drive and non-drive end shaft ensures minimum bearing friction torque
- Adaptability to use between companion flanges for all flange standards suitable for wafer style body
- Extended stem design for insulated lines. eg. Solar & HVAC application
- Excellent adaptability for actuator mounting through standardized ISO 5211 flange mounting pad for actuator fitment.
- Butterfly valve Manufacturing standards IS as per IS 13095, UL, FM & NSF as per AWWA C 504.

Specification :

- | | | | |
|-------------|----------------------------|------------|--------------------------------|
| • Body | : Cast Iron / Ductile Iron | • Disc | : SGI / DI / CF8 / CF8M |
| • Seal | : EPDM | • Pressure | : PN16 / PN 25 / PN 40 |
| • Operation | : LEVER / Gear | • Size | : DN 50mm to 600mm (2" to 24") |



LIV-BFV-CI-CF8-003 / 004
PN16



LIV-BFV-DI-DI-003
PN16

LIV-BFV-DI-DI-026
PN25

LIV-BFV-CI-CF8-021
PN40



LIV-BFV-DI-DFM-001 / 006
PN20

Electrical Actuator

Electrical Actuator Butterfly Valve offers single phase quarter turn for automation purpose application. It is also used in OHT automatic control System

- Manual Override Option
- Rotation 0° ~ 90° (Optional 0° ~ 270°)
- Standard NO/NC Feed Back Option in all models
- Option for modulating 4~20mA or 0~10 V DC input & output signal

Technical Specification :

- | | |
|-----------------------|--|
| • Enclosure | : Aluminium alloy, Weather proof IP 67 |
| • Power Supply | : 24V AC/DC or 1Ph 110/220 V AC 50/ 60 Hz or
: 3Ph 380/400/415/440 V AC 50/ 60 Hz |
| • Limit Switch | : 1 x SPDT (220V AC, 10 A) for each Open/ Close |
| • Ambient Temperature | : -20°C ~ +70°C |
| • Manual Override | : Wrench type mechanical manual override,
: Declutching mechanism, operated by hand wheel
: Auto declutching handwheel mechanism |
| • Output Torque (Nm) | : 30, 50, 80, 100, 150, 200, 300, 500, 600, 800, 1200, 1500, 2000, 3000, 4000, 5000 |



LIV-ELA-BFV-CI-CF8-003
PN16

LIV-ELA-BFV-DI-DFM-006
PN20

Optional :

- Tamper Switch / Limit Switch For Lever Operated & Gear Operated Butterfly Valve And Lock out for all Butterfly Valves



BRASS & PP Y-TYPE STRAINER



LEHRY MAKE Brass Y-Type Strainer & Screen Filter Screwed End, Suitable for Domestic Water Services, heating and Air Conditioning Plants. Brass Body F/F Threads & PP M/M Threads

Features :

- Robust Forged design
- Screwed bonnet
- Large Screening are Make the Strainer Efficient in Performance
- Available in various mesh size

Specification :

• Body & End Adaptor	: Brass CW617N, Glass Reinforced PP
• Ring	: NBR
• Mesh	: Stainless Steel AISI 304
• Working Temp.	: (-)20°C to 110°C
• Mesh 3/8" - 1"	: 400µm
11/4 - 2"	: 500µm
21/2" - 4"	: 600µm
• Threads	: ISO - 228/1 DIN / BS STD.
• Size	: DN 15 to 100 (1/2" to 4")
• Pressure Rating 3/8" - 2"	: PN 20
21/2" - 4"	: PN 16

Filtering Element	
80 Mesh	
120 Mesh	
150 Mesh	



LIV-STR-BS-001



LIV-SCF-121Y

Y- TYPE STRAINER

LEHRY MAKE CI Y-Type Strainer with Drain Plug for Plumbing, Fire Fighting, HVAC, Utilities & industrial application.. We are also Manufacturing "**MS - Fabricated Strainer**"

Features :

- Single piece Cast body
- Strainers equipped with bolted cover flange for easy maintenance
- Large Screening are area for efficiency in performance
- Low pressure drop across value
- Drain plug as standard for easy maintenance

Specification :

• Body	: C.I IS 210 Gr. FG200 / IS2062 / MS Fabricated
	: CS - ASTM A 216 Gr. WCB
	: SS 304 / 316 - ASTM A 351 Gr. CF8 / CF8M
• Screen	: SS (AISI 304 / 316)
• Ends	: Screwed & Flanged (STD BS / DIN / IS)
• Pressure	: 16 Bar / 150# / 300#.
• Size	: DN 50 to 600 (2" - 24") & Above MS Fabricate Strainer



LIV-STR-CI-FE-002



LIV-STR-MS-FE-012

T- TYPE STRAINER

LEHRY MAKE T-Type Strainer for various application such as Plumbing, Fire Fighting, Utilities, Etc. . We are also manufacturing "**MS' fabricated "T" strainer.**"

Features :

- One pice Cast body
- Strainers equipped with bolted cover flange for easy maintenance
- Large Screening are Make the Strainer Efficient in Performance
- Low pressure drop across value

Specification :

• Body	: C.I IS 210 Gr. FG200 / IS2062 / MS Fabricated
	: CS - ASTM A 216 Gr. WCB
	: SS 304 / 316 - ASTM A 351 Gr. CF8 / CF8M
• Screen	: SS (AISI 304 / 316)
• Ends	: Flanged Flanged (STD BS / DIN / IS)
• Pressure	: 16 Bar / 150# / 300#.
• Size	: DN 50 to 600 (2" - 24") & Above MS Fabricate Stariner



LIV-STR-CI-FE-002



LIV-STR-MS-FE-013

LEHRY MAKE Forged Brass Body CW617N Pencil Slim Design Check Valve Screwed End, Female x Female. Suitable for domestic water services, heating and air-conditioning plants, compressed air systems.

Features :

- Forged Brass CW617N Slim design
- Polyoxymethylene Seat Minimizes scale formation
- Aerodynamic Seat Providing Pressure Loss
- Spring Loaded for Horizontal / Vertical Installation.
- Threaded to (F) BSP BS 21 / I SO 228.

Specification:

- Body : Forged Brass CW617N
- Spring : AISI 302
- Seat : NBR
- Ends : Threads ISO 228
- Size : DN 15 - 50 (1/2" - 2")
- Temp Rating : (-)10°C to 80°C
- Pressure Range BTP : PN 16



LIV-NRV-BS-001 / LIV-NRV-BS-OEM

DUAL PLATE CHECK VALVE

LEHRY MAKE Dual Plate Check valve is an all purpose non return valve that is much stronger, lighter in weight and smaller in size as compared to conventional swing check valve or lift check valve. This design has twin advantages of minimum water hammer and non slam simultaneously.

Specification :

- Body : CI / CF8 / CF8M / WCB
- Plate : DI / CF8 / CF8M
- Seal : Nitrile / EPDM
- Spring : SS 304
- Temp Rating : (-)10°C to 80°C
- Pressure : PN 16
- Size : DN 40 - 600 (1-1/2" to 24")



LIV-NRV-CI-CF8-004

REFLUX VALVE

LEHRY MAKE Cast Iron Swing Check Type Reflux Valve are strictly manufactured as per 15:5312 Part-I. & DI Swing Check Valve FM Approved for Fire Fighting. These Valves are generally used to maintain flow of water in only one direction and stop the return flow of water. Rigid and sturdy design with minimum head loss

Specifications :

- Body / Cover : C.I IS 210 Gr. FG200
- Seat : GM
- Manufacturing Std : IS 5312 (Part - I)
- End Connection : Flanged Ends to IS 1538 (Part - 4 to 6)
- Inspection and Testing Std : IS 5312 (Part - I)
- Pressure rating : PN 10 / PN 16
- Size : DN 50 to 350 (2" to 14")

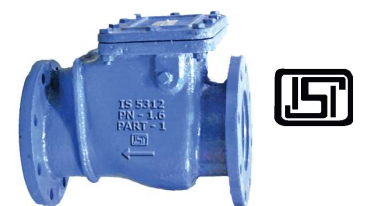

LIV-RFV-CI-001

SILENCE CHECK VALVE

LEHRY MAKE Cast Iron Silence Check Valve Flanged End. This Silence Check Valve represents the best combination of hydraulic efficiency, robustness, sealing and price for use with clear liquids : pumping, circulation, supply, general pipeline networks.

Specifications :

- Body : Cast Iron (A 210 Fg 200) / DI
- Closing System : Closing System: Cast Iron Shaft Bronze(≤300mm)
- Spring : Stainless Steel
- Working Pressure : PN16 / 25 Bar
- Size : 50MM - 300MM



LIV-ACV-SCV-DI-FE-001

SLUICE VALVE

LEHRY MAKE Sluice Valve / OS & Y Type Gate Valve Widely accepted by Municipal Corporations, Irrigation authorities, Water supply authorities, Nuclear Power Corporation and other Government and Industrial users. They are designed as per latest editions of IS Standard bearing ISI mark (for Non Rising Spindle Sluice Valves) Suitable for water works, efficient / sewage treatment plants, & FM Approved for Fire Fighting.

Basic Features :

- Rigid and sturdy design
- Minimum head loss across valve
- Low Torque operation due to excellent finish on spindle thread leads to low friction and smooth operation.

Specifications :

- Body / Bonnet / Wedge : C.I. IS 210 Gr. FG200
- Discring / Seat : GM
- Spindle : SS 410
- Manufacturing Std : IS 14846
- End Connection : Flanged Ends to IS 1538 (Part - 4 & 6)
- Size : DN 50 to 1200 (2" to 48")
- Pressure Rating 2" - 48" : PN 16



LIV-SLV-DI-P3-001 / 002

AIR RELEASE VALVE

LEHRY MAKE Air Release Valve provide longer service life and cost effective maintenance. With Brass / Cast Iron / Ductile iron Body, MS cover and cowl it has a pressure rating of PN 10 / 16 & 25. Is ideally suited for turbid / clean water supply lines

Specification:

- Types : Tamper Proof
- Body cover : DI / C.I IS 210 GR. FG 200 / Brass
- Seat : Neoprene / Nitrile
- Ball : Neoprene coated timber
- End connections: Screwed to BSP
: Flanged Ends to ASME B – 16.1 125# / 16.5 150#
- Pressure rating : PN 10 (Brass) / PN 16 (CI) & PN 25 (DI)
- Size : DN 10 - 25 (3/8" - 1") (Brass) / DN 50 to 300 (2" - 12") (CI / DI)



LIV-ARV-BS-001

LIV-ARV-CI-005 For PN16
LIV-ARV-DI-006 For PN25

FOOT VALVE

LEHRY MAKE Brass foot valves Screwed End. The purpose of a foot valve is to maintain pump prime between pump cycles. A strainer prevents debris from entering the piping system. Foot valves are designed to minimize headloss and optimize pumping efficiency.

Specification :

- Body : Brass (CW617N)
- Mesh : SS.304
- Seat : Brass EN 12164
- Spring : SS.304
- Temp Rating : -10'C -80'C
- Pressure : PN 10 Bar
- Size : DN 15 - 50 (1/2" to 2")



LIV-FOV-BS-001

BALL TYPE CHECK VALVE & FOOT VALVE

LEHRY MAKE Cast Iron Ball Type Check Valves & Foot valves Screwed End. This Ball in designed the path of the valves moves freely and promptly reacts to the On & Off of the pump prevent hammering greatly increasing pump efficiency

Specification :

- Body & Cover : Cast Iron
- Ball & Seat : Nitrile Rubber
- Pressure : PN 16 (Size 25 - 125mm)
: PN 10 (Size 150 - 300mm)
: PN 6 (Size 350mm)
- Size : DN 15 - 50 (1/2" to 2") Screwed to BSP (F)
: DN 40 - 350 (1-1/2" to 14") Flanged to BS10 Table-E)



LIV-NRV-CI-FE-001

LIV-BFT-CI-001

LIV-NRV-CI-SE-001

Automatic Pump Cum Over Head Tank Level Controlling System

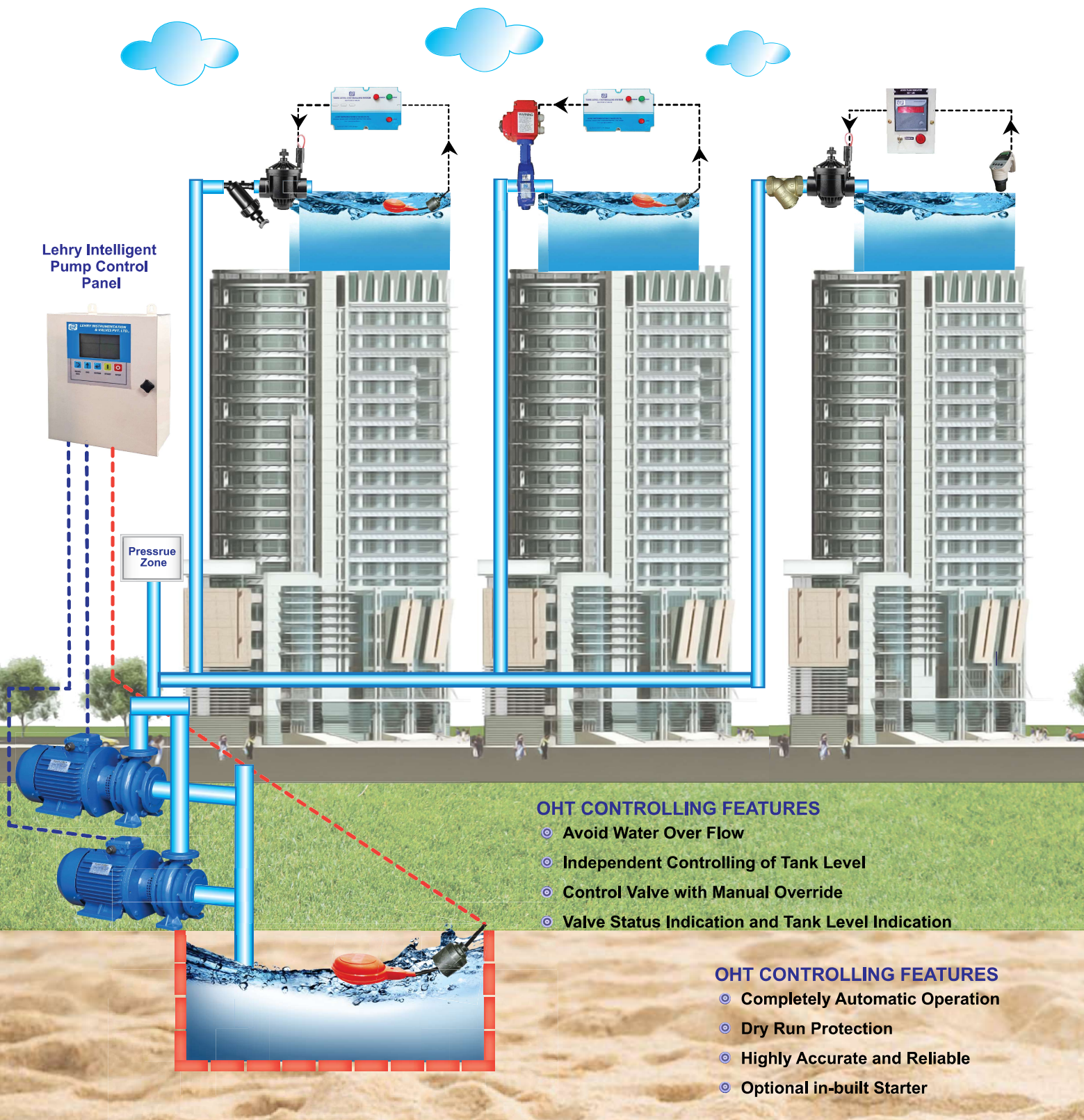

OHT CONTROLLING FEATURES

- ⦿ Avoid Water Over Flow
- ⦿ Independent Controlling of Tank Level
- ⦿ Control Valve with Manual Override
- ⦿ Valve Status Indication and Tank Level Indication

OHT CONTROLLING FEATURES

- ⦿ Completely Automatic Operation
- ⦿ Dry Run Protection
- ⦿ Highly Accurate and Reliable
- ⦿ Optional in-built Starter

GODREJ PALM GROVE
CHENNAI



BRIGADE
GROUP

TVS Emerald Haven Realty

HunterDouglas®

KG
Signature
city
MOGAPPAIR

Tech
Mahindra
KOBELCO®

aqualily by Mahindra
LIFESPACES
Mahindra World City, Chennai

Logix Group
Blossomcounty
the greener side of life



DSR
Eden Greens
Just off Sarajour Road



Opaline
Living life, water style





AMR SYSTEMS for Water, Gas & Electricity

Types :

1. Wired Systems
2. Wireless Systems
 - Wifi & GSM

Flexible, smart, efficient :

Smart and innovative technologies for capturing, analysing and processing meter data have long been standard in water and energy measurement. Municipal utilities, industrial companies, property companies and metering services are increasingly relying on time-saving and cost-saving remote meter reading via wired systems, and wireless radio systems or modern smart metering measurement systems.

As a LEHRY customer you have access to an innovative portfolio containing wired Metering systems and wireless metering solution as well as electronic hardware and professional software packages for commissioning and reading your water consumption

Focusing on quality and efficiency, our engineers have developed intelligent systems from flexible measurement technology and high-performance remote reading technology to be the perfect solution for all of your utility Management needs.

LEHRY have meters with modern communication interfaces which enable integration into Wired or Wifi systems. We also offer smart solutions to integrate conventional, pulse-based meters, enabling the meters to be integrated into AMRS turning every meter into a smart meter.

FIXED WIRELESS SYSTEMS
Efficient fixed network wireless system for remote meter reading and monitoring

WIRELESS SYSTEM
System for remote meter reading and monitoring via internet with data transfer via Wifi and online meter administration



Benefits of AMR systems:

- Efficient reading process
- Shorter intervals
- Increase data quality and improved data management
- Ability to monitor consumption
- Visualization of savings potential
- Alerts - No flow, Low flow, High flow, Tamper Etc.
- A green solution

The advantages of WIRELESS for the utility

- Meter reading Through Wifi or Wired
- Real time readings
- Secure data collection system
- Billing Facility for better cash flow
- Measure to optimise consumption
- Resource conservation and environmental protection

The advantages of WIRELESS for the Customers

- Secure - no third party entering the house
- Reliable - no meter reading mistakes
- Paperless
- E-mail updates and Application Managements
- Return Utility , Monitoring capability, user friendly dash board

OUR CLIENTS



LEHRY VALVES
Where flow and pressure meets quality

LEHRY WATER HAMMER ARRESTORS

What is Water Hammer?

The noise from banging pipes is caused by shocks of high speed water flowing in the piping system when a fixture is suddenly closed. Sudden stoppage of the water (a non-compressible liquid) flowing at a given pressure and velocity causes a surge or spike of water and is called water hammer. When this occurs, a pressure wave travels back through the piping until it finds a point of relief. The LIV-WHA Water Hammer Arrestors are designed to eliminate this effect.

Dishwashers, clothes washers, fast closing positive shutoff valves incorporated in the system all contribute to creating water shock which is not only annoying but damaging to pipes and appliances. The Lehry Water Hammer Arrestors (LIV-WHA) incorporate a pre-charged, permanent sealed air chamber to absorb the shock. The sealed chamber prevents the loss of air to the water and assures long and trouble-free life.

Features:

- BSP solid hex brass adapter or solder end connection for easy installation
- Approved for installation with no access panel requirement
- May be installed in new or existing plumbing systems with a standard pipe tee vertically, horizontally installed
- Maintenance free – piston is the only moving part
- Air pre-load is 60psi (4.2 bar)
- Factory air charged and permanently sealed

Specifications:

- Body : Copper / SS.304
- Threaded Adapter : CW602N DZR Brass
- Piston : Teflon
- O-ring : EPDM
- Sizes : Copper : 1/2" - 2" (15 - 50mm)
Stainless Steel : 1/2" - 10" (15 - 250mm)

Compliance



LIV-WHA-SS

Pressure : PN.20 Bar
Temperature : -73°C to 149°C



LIV-WHA

Pressure : PN.10.3 Bar
Temperature : -0.5°C to 82°C

Sizing Placement :

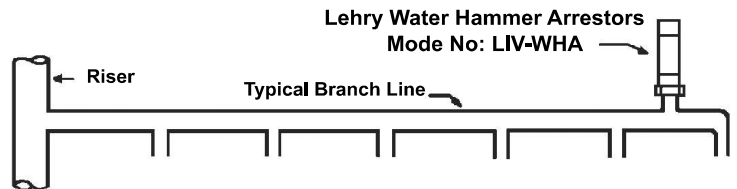
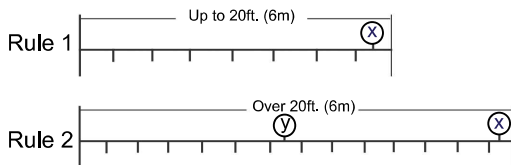

Fixture units sizing information

FIXTURE	Type Of Supply Control	Weight in Fixture - Units					
		Public			Private		
		Total	C.W. (Cold Water)	H.W. (Hot Water)	Total	C.W. (Cold Water)	H.W. (Hot Water)
Water Closet 1.66 PF	Flush Valve	8	8	-	5	5	-
Water Closet 1.66 PF	Flush Tank	5	5	-	2.5	2.5	-
Pedestal Urinal 1.06 PF	Flush Valve	4	4	-	-	-	-
Stall or Wall Urinal	Flush Valve 1.06 PF	4	4	-	-	-	-
Stall or Wall Urinal	Flush Tank 1.06 PF	2	2	-	-	-	-
Lavatory	Faucet	2	1 1/2	1 1/2	1	1	1
Bath tub	Faucet	4	2	3	2	1 1/2	1 1/2
Shower Head	Mixing Valve	4	2	3	2	1	2
Bathroom Group	Flush Valve Closet	-	-	-	8	8	3
Bathroom Group	Flush Valve Closet	-	-	-	6	6	3
Separate Shower	Mixing Valve	-	-	-	2	1	2
Service Sink	Faucet	3	3	3	-	-	-
Laundry Tubs (1-3)	Faucet	-	-	-	3	3	3
Combination Fixture	Faucet	-	-	-	3	3	3

As shown, it has been established that the preferred location for the water hammer arrestor is at the end of the branch line between the last two fixtures served.

The location of the water hammer arrestor shown above applies to branch lines that do not exceed 20 ft. (6m) in length, from the start of the horizontal branch line to the last fixture supply on this branch line. When the branch line exceeds the 20 ft. (6m) length, an additional water hammer arrestor should be used. This practice is best defined by two rules which have been established to cover the placement of water hammer arrestors.

Sizing and Selection Table for Copper

Item Code	Size	A (I.D.)	B (H.D.)	C (Hex)	Weight (Kg)	Fixture Units	PDI Standard
LIV-WHA-A15mm	1/2" 15mm	14.5	129	21	0.115	1 - 3	AA
LIV-WHA-15mm	1/2" 15mm	14.5	151	21	0.17	1 - 11	A
LIV-WHA-20mm	3/4" 20mm	19.5	185	27	0.248	12 - 32	B
LIV-WHA-25mm	1" 25mm	25	221.5	34	0.409	33 - 60	C
LIV-WHA-32mm	1 1/4" 32mm	33	259	43	0.755	61 - 113	D
LIV-WHA-40mm	1 1/2" 40mm	39	283	49	0.940	114 - 154	E
LIV-WHA-50mm	2" 50mm	51	328	61	1.14	155 - 330	F

Sizing and Selection Table for SS

Item Code	Connection Size		Dimension (MM)			Fixture Units	PDI Standard	Pipe Line Size	Weight (KG)
	Inch	MM	A	B	C				
LIV-WHA-SS-AA-15MM	1/2"	15	83	92	42	1 - 5	AA	15	2.12
LIV-WHA-SS-A-15MM	1/2"	15	83	92	42	1 - 11	A	15 - 40	2.12
LIV-WHA-SS-A-20MM	3/4"	20	83	92	42	1 - 11	A	50	2.58
LIV-WHA-SS-B-25MM	1"	25	83	102	52	12 - 32	B	65	3.68
LIV-WHA-SS-C-25MM	1"	25	83	112	62	33 - 60	C	80	3.20
LIV-WHA-SS-D-25MM	1"	25	83	132	82	61 - 113	D	100	5.20
LIV-WHA-SS-E-25MM	1"	25	83	169	119	114 - 154	E	125	8.04
	1"	2	83	172	122	114 - 154	E	150	10.97
LIV-WHA-SS-F-25MM	1"	25	83	172	122	155 - 330	F	200	14.77
	1"	25	83	172	122	155 - 330	F	250	23.47

LEHRY PRESSURE REDUCING VALVE

Lehry Make Forged Brass Min PRV Screwed End & Direct Activated Pressure Reducing Valve with Inbuilt Strainer Internal Balancing Line SDT Pilot Diaphragm Operated Screwed for Water Line with Inbuilt Strainer

Functions:

- Pressure reducing valves are installed in residential water systems to reduce and stabilise inlet pressure from the water mains supply which is generally too high and variable for domestic appliances to function properly.
- These valves can also be used to control inlet pressure to domestic hot water storage

Features:

- Max. Inlet Pressure : 16 Bar
- Connection : Screwed End (BSP)
- Media : Water, Gas, Air & Oil



LIV-PRV-M-BS-002



LIV-PRV-CF8-SE-008

Technical Details :

SL	Parts Description	Materials
1	Pressure Gauge	Upon Request
2	End Cover	ASTMA 351Gr. CF8/ CF8M
3	O-Ring	NBR
4	O-Ring	NBR
5	Plug	SS.304
6	Sealing Spacer	NBR
7	Piston Shaft	SS.304
8	Body	ASTMA 351Gr. CF8/ CF8M
9	Diaphragm	NBR
10	Spring	Steel
11	Spring Cover	Aluminum
12	Adjusting Stem	SS.304
13	Strainer	SS.304

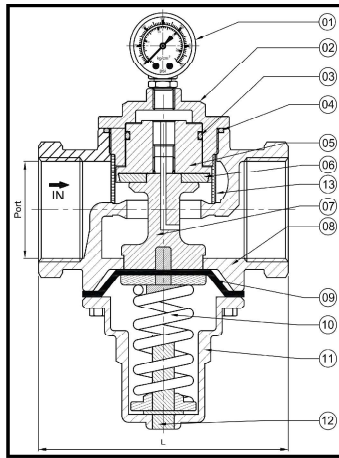

Pressure Adjutment Range :-
1.5 ~ 6 Bar

1 ~ 5 Bar & 4 ~ 9 Bar

Temperature
Upto 70°C

Upto 85°C

Dimensions (All Dimensions are in mm)

Valve Size		Tolerance: ±3	PORT
MM	Inch	L	
15	1/2"	61	1/2" BSP
20	3/4"	71	3/4" BSP
25	1"	81	1" BSP
32	1.1/4"	90.5	1.1/4" BSP
40	1.1/2"	110.5	1.1/2" BSP
50	2"	115	2" BSP

SL	Parts Description	Materials
1	Body	CW617N
2	Bonnet	PA66+GF30%
3	Screw	Steel with Zinc Plated
4	Diaphragm	NBR
5	Spring	Stainless Steel
6	Sealing Spacer	NBR
7	Piston Shaft	SS.304

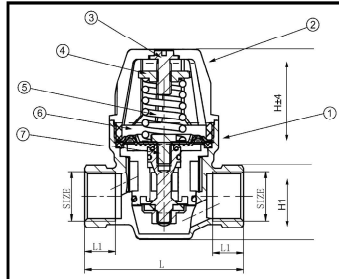

Size		L	L1	L2	H	H1
Inch	mm					
1/2	15	68	12	7	60	18
3/4	20	68	13	7	60	18

Cavitation :

The cavitation diagram shows three operating zones of the Redubar pressure reducing valve plotted against the upstream and downstream pressures, namely :

C zone : normal duty, no cavitation

B zone: medium duty, risk of cavitation

A zone: heavy duty, the pressure reducing valve shows cavitation.

Continuous operation in the red cavitation zone could cause rapid damage of the internal parts.

If the pressure reducing valve is to operate in the red zone, contact the Technical Department of Lehry Instrumentation & Valves Pvt. Ltd.,

Recommendation :

- Pressure Gauge not Provided along with Product to be Bought Separately
- Pressure Gauge 2" Dial, Range : 0 -10Kg/Cm² : 1/8" BSP Bottom Entry.
- PRV is provided with SS Cap.

CAVITATION DIAGRAM

A) Cavitation Zone B) Transition Zone C) Work Zone

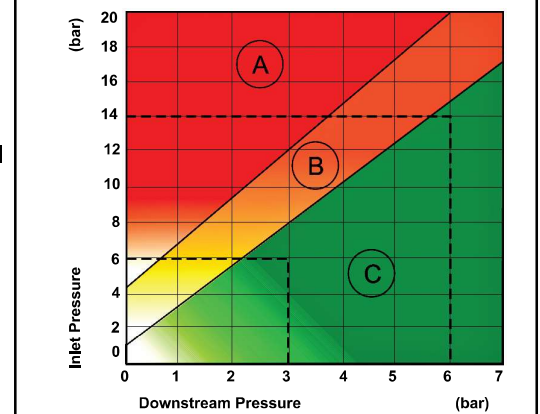

LEHRY AUTOMATIC CONTROL VALVE

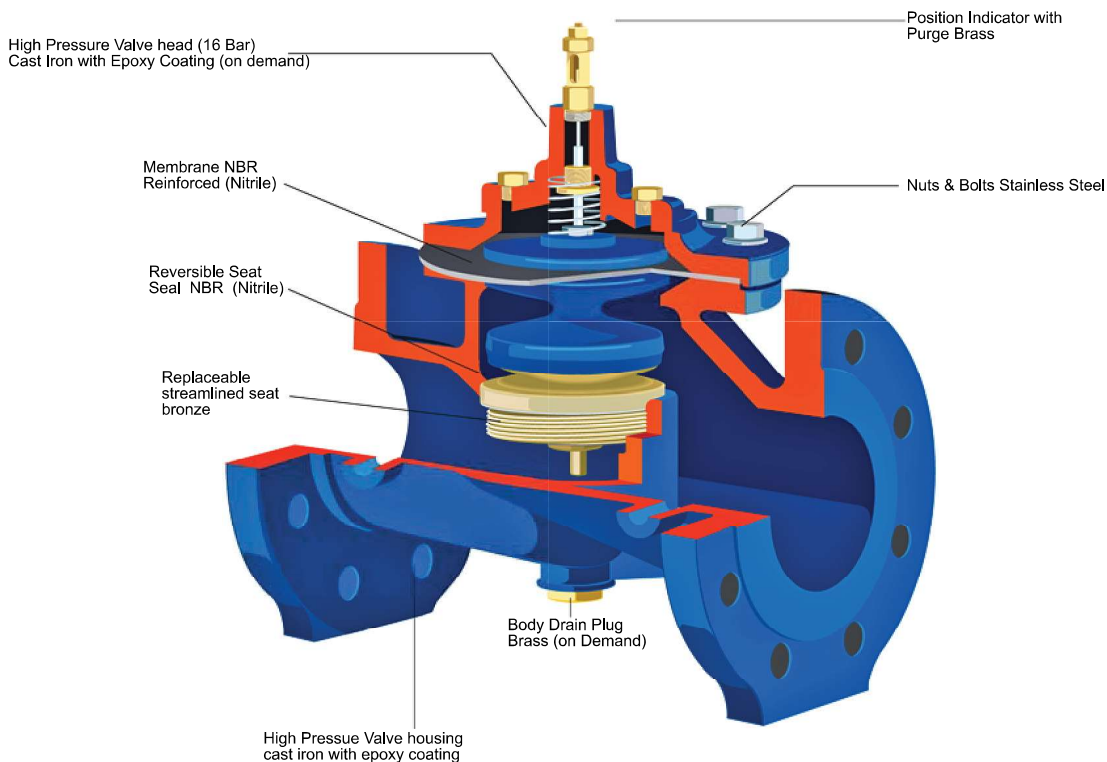

MAIN VALVE

LEHRY Sustaining or Backpressure Control Valve shall be a pilot operated diaphragm valve designed to permit flow when upstream pressure is above the adjustable setpoint of the control pilot, and throttle toward closed when upstream pressure falls below the adjustable setpoint.

Description & Materials

Technical Specification	Part Name	Material	Part Name	Material
Design Standard : BS EN 1567 Face to Face : EN558-1	Body	DI	Diaphragm	Nylon + EPDM
	Spring	SS	O-Ring	EPDM
Flange Drilling : EN1092-2 / ANSI	Seat	NBR	Guide Bush	Brass
	Stem	Bronze	Coating	Epoxy resin

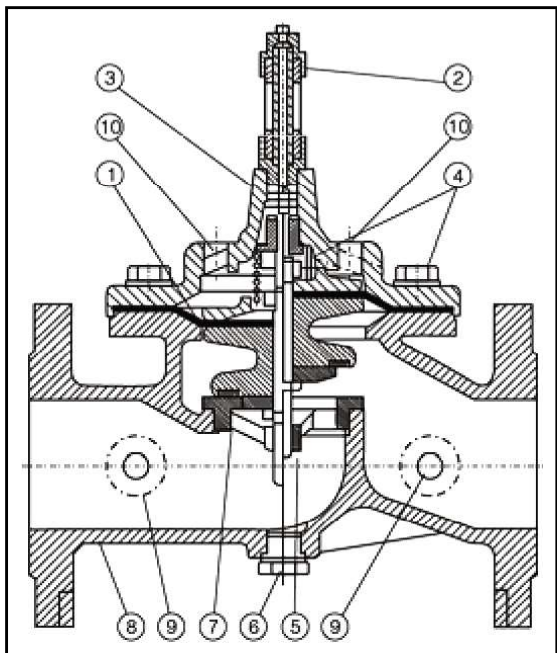

Basic Information of

Medium	Standards	Connection
Medium : Water Temo: - 90°C	Design Standards BS EN 1567	Face to Face EN 558-1
Pressure Range: PN16, PN25 ANSI - 150/300#	Test Standard EN 1226-1	Flange Drilling EN 1092-2 / ANSI - 150 & 300#

Material Parts

Part No	Name	Material
1	Membrane	Reinforced NBR
2	Drain Cock on top cap	Brass
3	(PN 16) High Pressure to cap	Cast iron
4	Nuts, Bolts Screws	Stainless Steel
5	Replaceable streamlined seat	Bronze
6	Body drain plug	Brass
7	Reversible seat seal	NBR
8	High Pressure Body	Cast iron
9 & 10	Holes for Pressure Gauges	

Cavitation Guide Chart

After Selecting the valve size, locate inlet and outlet pressure on this chart. If the intersection point falls in the shade area, cavitation can occur. Operation of valves continuously in the cavitation zone should be avoided.

Anti - Cavitation Chart

The Anti-Cavitation mold is designed for application where there is a high potential for damage from cavitation, which provides optimum internal pressure control through a unique anti-cavitation trim design.

Relieving the damage of cavitation with multi-stage pressure reducing.

Operating Pressure

PN.16 Flanged = 17 Bar
150# Flanged = 25 Bar

Operating Temperature

EPDM: 80°C

Pilot System

1.5 - 6 Bar (Low)
6 - 12 Bar (Standard)
12 - 18 Bar (High)

Tubing & Fittings

Copper / Brass (Standard)

Cavitation Chart

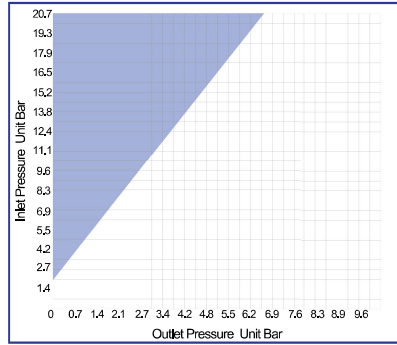

Flow Criteria

DN	Mini (M ³ /h)	Maxi (M ³ /h)
40	0.5	20
50	0.5	36
65	1.15	45
80	1.15	45
100	3.45	92
125	9.15	165
150	9.15	165
200	13.7	365
250	24.7	715
300	50.6	1001.2

Head Loss Chart

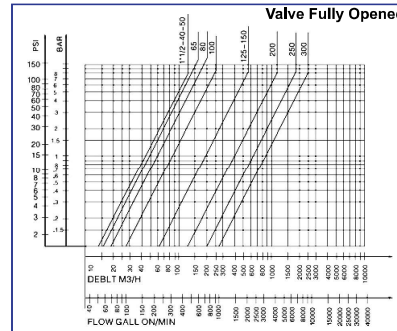

KV Value

Valve Size	M ³ /h	L/s
40-50	45.6	12.6
65	48.33	13.43
80	55.4	1.39
100	86.6	24.05
125	194.66	54.07
150	194.66	54.07
200	397.5	110.41
250	900	249.9
300	919.4	255.4

KV: 15°C, 1 bar, (m³/h)

Quantity of flow (in m³/h) of water at 15°C Passing through a device creating a head loss of 1bar

AUTOMATIC CONTROL VALVE VARIOUS OPTIONS

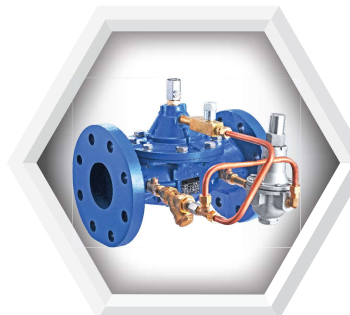

Pressure Reducing Valve

When the pressure before the valve fluctuations or flow changes, it can make the pipeline within the high-pressure water automatically reduced to a stable low-pressure water, and the pressure relief valve outlet pressure within a certain range can be adjusted

LIV-ACV-PRV-DI-FE-001/002

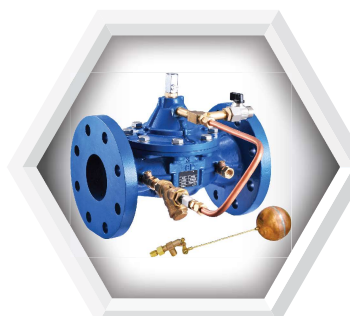

Pressure Relief Valve

1. Installed in the pipeline, adjust, set and maintain the upstream pressure of the pipeline
2. Installed in the pipeline bypass, relief function

LIV-ACV-PSV-DI-FE-001/002



Float Control Valve

The float valve is composed of the main valve of the hydraulic control valve and the adjustable float ball valve, and the liquid level can be adjusted in an appropriate amount. Once the adjustment is completed, the height of the liquid surface is always maintained.

LIV-ACV-FLV-DI-FE-001



Hydraulic Check Valve

Adjust the opening and closing speed of the valve to prevent back-flow of water in the pipe

LIV-ACV-HCV-DI-FE-001

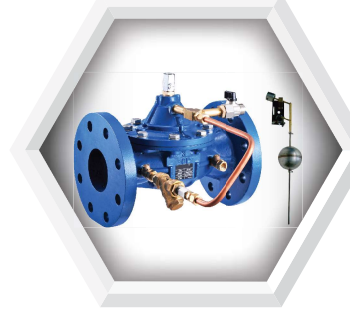

On/Off Float Control Valve

On/Off Float Control Valve Mechanical 2 Position Float Operated, is designed to open fully or close drip-tight as commanded by the Float Control Pilot

LIV-ACV-OFV-DI-FE-001

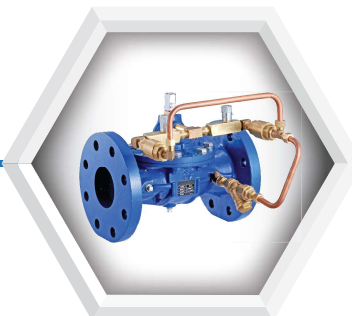

LEHRY MAKE Single Jet Water Meter, Anti Tamper Magnetic type, hermatically Sealed Totalizer, Dry Dial Straight Reading type Retrofittable Pulse Wire Output.

Features :

- Small,light Weight
- Dry-dial, magnetic drive, Anti Tamper Magnetic type, protected against external magnetic tampering
- Vacuum-sealed register, frost resistant, keeps clear reading for life of meter
- Available for cold water 0~50°C and hot water 90°C ;
- 360° Rotating dial
- Register can be rotated in any direction for convenient reading;
- The meters conform to ISO4064 Standard Class B
- Brass body can be painted or nickel coated. (Plastic body - optional)

Working Condition :

- Water temperature≤50°C, Hot water meters≤90°C
- Water pressure16bar
- ΔP ≤ 0.1MPa

Material Specification :

- Body : Brass
- Filter : Polypropylene



LIV-WM-BS-MJ-001 / 002

MULTI JET WATER METERS

LEHRY MAKE Multi Jet Water Meter, Anti Tamper Magnetic type, hermatically Sealed Totalizer, Dry Dial Straight Reading type Retrofittable Pulse Wire

Features :

- Dry-dial, magnetic drive,
- Anti-tampermagnetic type, protected against external magnetic tampering
- Vacuum-sealed register, frost resistant, keeps clear reading for life of meter
- Available for cold water 0~50°C and Hot water 90°C
- Remote transmission device can be added upon request sensors, such as Reed Switch, can be supplied upon request
- Pulse output shall be 1L/Pulse, 10L/Pulse Standard 1L/ Pulse can be requested
- The meters conform to ISO4064 Standard Class B
- Brass body shall be epoxy painted.

Working Condition :

- Water temperature≤50°C, Hot water meters≤90°C
- Water pressure16bar
- ΔP≤0.1MPa(Qs)
- ΔP≤0.063MPa(Q3)

Material Specification :

- Body : Brass
- Filter : Polypropylene



LIV-WM-BS-MJ-001 / 002

MULTIJET VERTICAL TYPE WATER METER

LEHRY MAKE Multi Jet VERTICAL TYPE Water Meter, Anti Tamper Magnetic type, hermatically Sealed Totalizer, Dry Dial Straight Reading type Retrofittable Pulse Wire.

Features :

- Dry-dial, magnetic drive,
- Anti-tampermagnetic type, protected against external magnetic tampering
- Vacuum-sealed register, frost resistant, keeps clear reading for long time
- Available for cold water 0~50°C
- Brass body can be epoxy painted.



LIV-WM-CI-MJ-002

VOLUMETRIC WATER METER

LEHRY MAKE Volumetric Water Meter, Brass Body Screwed End, liquid sealed register, gives clear reading for Life of meter, Retrofittable Pulse Wire

Features :

- Rugged and intelligently conceived
- Counter with protected rollers
- Body made from high quality brass CW617N
- Working Temperature 50°C
- Operating Pressure PN16
- Display range 0.02 to 9.999 m³
- Assured accuracy in Horizontal and Vertically installed position
- With Integrated tamperproof check valve
- Retrofittable with pulser 0.5l/Pulse (DN 40 5l/Pulse)
- Sizes of volumetric meters 1/2" & 3/4" Standard available Upto 40mm on request
- Compliance to ISO 4064 and MID 2004/22/EC Class C



LIV-WM-BS-VM-001

Working Condition :

- Water temperature ≤ 50°C
- Water pressure 16bar

Accuracy

From minimum flow-rate (q_{min}), to transitional flow-rate (q_t), exclusive: ±5%, Class C

Material Specification :

- Body : Brass
- Check Valve : Polypropylene

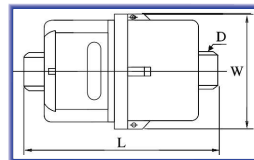

Error Curve

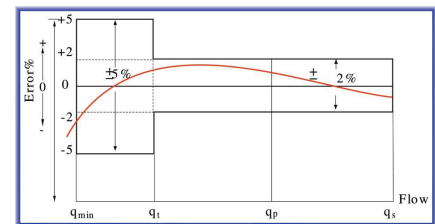

Head Losses Curve

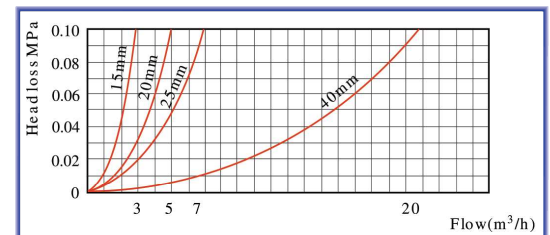

Dimensions And Weight with Adaptor Coupling

Size (mm)	Length (mm) L	Width (mm) W	Height (mm) H	Connecting	Weight (Kg)
				Threaded D	
15	115	85	90	G 3/4" B	1.1
20	130	86	90	G 1" B	1.8
25	175	112	106	G 1 1/4" B	2.5
40	300	175	152	G 2" B	4

IRRIGATION WATER METER

LEHRY MAKE WI Irrigation Woltmann Type Water Meter, Having Magnetic drive, Hermetically Sealed Totalizer retrofittable for pulse output, suitable for Load water upto 30% for use in waste water & ETP Plants

Strongly loaded water, for example in agriculture, wastewater treatment plants, or sewage works requires especially robust meters that are also working reliably under difficult conditions. Our irrigation meters achieve this by having their measuring insert arranged in the upper part of the pipe where, in flowing water, usually only few suspended particles are found. The meter can easily handle a load ratio of up to 30%. We recommend an addition of external filters in front of the meter for very strong load.

Features :

- Dry-dial, Vacuum sealed register, frost resistant, magnetic drive
- Liquid sealed, equipped with a suitable pressure compensating device, mechanical drive
- Keeps clear reading for life of water
- Removable measuring unit, easy installation and maintenance
- Anti-friction bearing type, used for low quality water
- Very high flow capacity, very low head loss
- Long service life more than 15 years
- Installment vertical or horizontal for load water upto 30.1. of total flow area.
- The meters conform to ISO4064 Standard Class B.



LIV-WM-WI-001

Working Condition :

- Water temperature ≤ 50°C, Hot water meters ≤ 90°C
- Water pressure 16bar

LEHRY MAKE W Woltmann Type Bulk Water Meter Flanged End, Removable Mechanism type, Magnetically Coupled having dry dial hermatically Sealed Totalizer, retrofittable for Pulse Output ad conforming to ISO-4064 Class - B

Features :

- Dry-dial, magnetic drive;
- Vacuum sealed register, frost resistant, keeps clear reading for long time;
- Removable measuring unit, easy installation and maintenance;
- Measuring high flowrate with low head loss;
- Remote transmission device can be added upon request; Many kinds of sensors, such as Reed Switch, Hall and Weagand can be supplied upon request Pulse output may be 10I/pulse, 100I/pulse, 1000I/pulse ;
- The meters conform to ISO4064 Standard Class B.



LIV-WM-WL-001 / 002

Working Condition :

- Water temperature $\leq 50^{\circ}\text{C}$, Hot water meters $\leq 90^{\circ}\text{C}$
- Water pressure 16bar
- $\Delta P \leq 0.1\text{MPa}$

Accuracy :

From minimum flow-rate (q_{min}) inclusive, to transitional flow-rate (q_t), exclusive: $\pm 5\%$
 From transitional flow-rate (q_t) inclusive, to overload flow-rate (q_s), exclusive: $\pm 2\%$ (Hot water meter: $\pm 3\%$)

Erore Curve

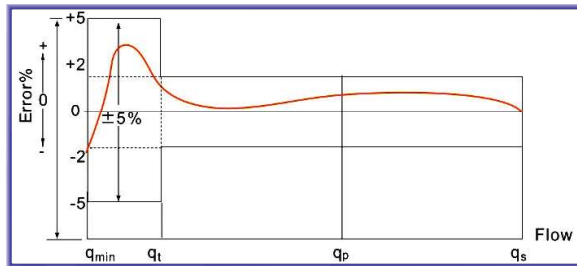

Head Loss Curve

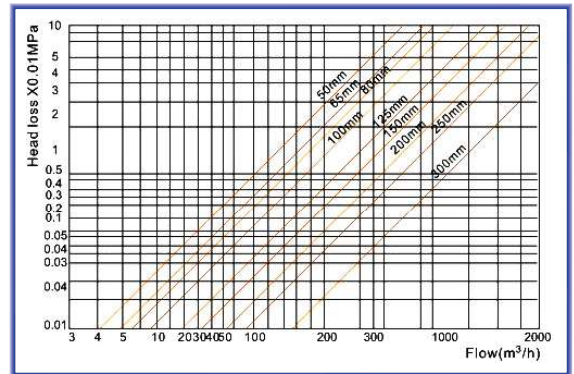

Dimension

(All Dimension are in mm)

Size		Length	Hight	Outer	Bolt Circle Diameter D2	Connection Bolt n-Md	Weight Kg
mm	inch	L	H	Diameter D1			
50	2	200	247	165	125	4-M16	12
65	2 ½	200	260	185	145	4-M16	13
80	3	225	265	200	160	8-M16	15
100	4	250	272	220	180	8-M16	19
125	5	250	295	250	210	8-M16	23
150	6	300	302	285	240	8-M20	30
200	8	350	359	340	295	8-M20(1.0Mpa)	42
						12-M20(1.6Mpa)	
250	10	450	470	395	350	12-M20(1.0Mpa)	94
				405	355	12-M24(1.6Mpa)	
300	12	500	492	445	400	12-M20(1.0Mpa)	97
				460	410	12-M24(1.6Mpa)	

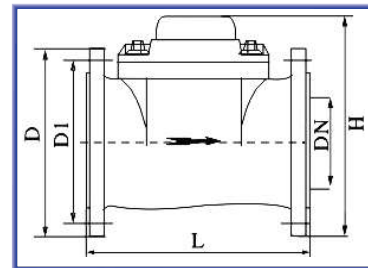

Main Technical Data

Size		Class of measurement	Maximum Flow (Qs)	Nominal Flow (Qp)	Transitional Flow (Qt)	Minimum flow (Qmin)	Minimum Reading (min).	Maximum Reading (max).
mm	inch		m³/h			m³		
50	2	B	30	15	3	0.45	0.002	9999999
65	2 ½	B	50	25	5	0.75	0.002	9999999
80	3	B	80	40	8	1.2	0.002	9999999
100	4	B	120	60	12	1.8	0.002	9999999
125	5	B	200	100	20	3	0.02	9999999
150	6	B	300	150	30	4.5	0.02	9999999
200	8	B	500	250	50	7.5	0.02	9999999
250	10	B	800	400	80	12	0.02	9999999
300	12	B	1200	600	120	18	0.02	9999999

Operation principle

LEHRY MAKE Electromagnetic flow meter operation principle is based on measuring electromotive force induced in electrically conductive liquid when it moves in magnetic field. The magnetic field is furnished in the flow sensor's inner channel by a special electromagnetic system

Inductive electromotive force (EMP) E is proportional to the mean flow velocity v , distance between the electrodes (which is equal to the sensor's inner diameter), and magnetic field strength ,

$$E = v \times d \times B \times k$$

where k linear factor. B and d are constants for MFT of a given standard size.

The value of electromotive force (EMP) is independent of liquid temperature and viscosity, Considering the formula for inductive EMP, flow rate Q is calculated as follows:

$$Q = \frac{\pi \times d^2}{4} \times v = \frac{\pi \times d}{4 \times K \times B} \times E$$

Volume V of the liquid passed through the flow sensor during the time interval T is calculated by the formula

Application :-

- water abstraction
- water treatment;
- water distribution network
- custody transfer flow meters
- irrigation
- waste water treatment
- filtration plants
- industrial water applications
- acids, alkalis, alkaline solutions, reagents
- paper pulps
- liquid foods
- Heat meter for calculate energy of liquid
- BTU meter.

Feature & Option

- Power supply : Battery operated/ 24V dc/230V AC
- Available in sizes from DN 10 to 300 mm (3/8" - 12")
- High grade stainless steel, titanium, or tantalum measuring electrodes
- Suitable for direct burial and constant flooding;
- Easy commissioning, automatic uploading of calibration values and settings
- High accuracy and stability of measurement
- High resistance to external action
- Connection type - wafer (DN 10, 15 mm), flanged (DN 20-1000 mm), threaded (DN 15; DN 32; DN 50; DN 80;)
- Full pipe detection, Bidirectional flow measurement
- Suitable formounting on polymer pipes
- Graphic backlit LCD Display, Inbuilt and remote Display option
- Integrability into automatic industrial control systems



LIV-EMF-CF8M-STFE-001

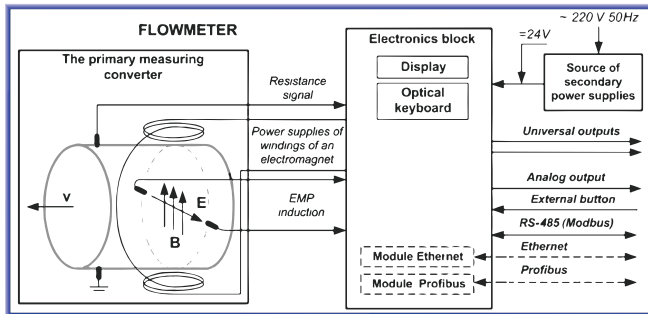

Technical Data Sheet

- Design Material
- Flange : Carbon steel / Stainless steel
- Housing: Carbon steel / Stainless steel
- Lining : PTFE / Rubber
- Electrode: stainless steel, titanium, tantalum, etc

Technical Specification:-

- Nominal diameter of the pipeline, DN : 10 TO 1000 mm
- Accuracy : 0.25% /0.5%
- Repeatability : 0.2
- Maximum pipeline pressure : 25 bar / 40 bar on request
- Minimum conductivity : 1 μ S/cm
- Fluid temperature range : -10 to 100/150 $^{\circ}$ C
- Ambient temperature range : -25 to 70 $^{\circ}$ C
- Protection : IP-67/ EX
- Power supply : Battery operated
: 24v dc & 230 v ac

Outputs

- 4-20 mA analog output;
- Pulse outputs
- RS-485 interface
- HIGH & Low alarm output

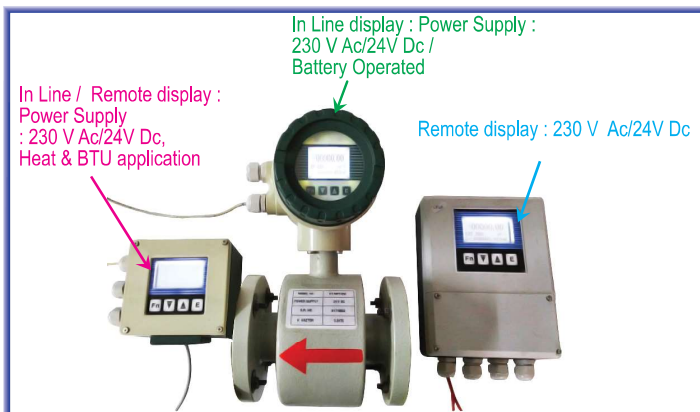

Sl	Name of Parameter	Value												
1	Nominal Diameter	10	15	20	25	32	40	50	65	80	100	150	200	300
2	Maximal Velocity of flow in the pipeline, V , m/s	10												
3	Maximal measurable volumetric flow rate, Q_{max} , m^3/h	2.5	6.3	10	16	25	40	63	100	160	250	630	1000	2500

LEHRY MAKE Extended Stem Type Brass Ball Valve with Strainer Screwed End. Suitable for domestic water services, heating, air-conditioning plants and compressed air systems

Features :

- Female/Female threads.
- Flat lever handle with decromet Plating for Anti Rust.
- Body in nickel-plated brass.
- Minimum and maximum working temperatures: -20°C to 120°C in absence of steam.
- Threads ISO 228 (equivalent to DIN EN ISO 228 and BS EN ISO 228).



LIV-BLV+STR-BS-002

Specification :

- Available Size : DN 15 to 50 (1/2" - 2")
- Pressure Rating 1/2" - 1" : PN 30
- 1 1/4" - 2" : PN 25

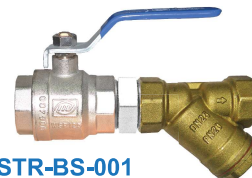

LIV-BLV+STR-BS-001

BALANCING VALVE

Lehry Static Balancing Valve & Double Regulating Commissioning Valve are installed in the pipework of hot water central heating systems and cooling systems and serve to achieve a hydronic balance between the various circuits of the system.

Features :

- One valve for all 5 functions:
 - ◆ presetting, ◆ measuring, ◆ isolating, ◆ filling, ◆ draining
- Accurate valve opening indicator, accurate to 1% of full valve opening
- The best cut-off function
- Lock opening - reliable memory function
- Ideal flow regulation characteristics, relative flow and relative opening are linearly related;



LIV-BAV-BZ-001

Specification :

- Available Size : DN 15 to 50 (1/2" - 2") - Screwed
- : DN 65 to 500 & Above (2-1/2" - 20") - Flanged
- Pressure Rating : PN 25 - Screwed (Brass)
- : PN 20 - Flanged (Ductile Iron)
- : PN 16 - Flanged (Cast Iron)
- Temperature : -10°C to 120°C
- Body & Stem : Brass / Cast Iron / Ductile Iron / WCB
- Sealing : EPDM



LIV-BAV-CI-002

FLOW Chart

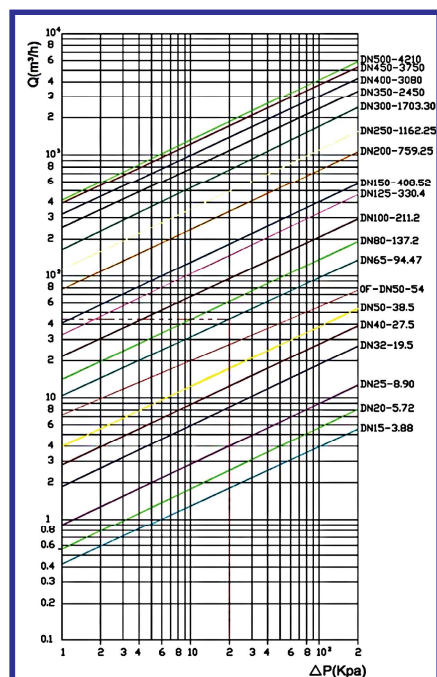

As shown in the left, it is the flow chart of Static balancing valve DN15-DN500 when the valve is full open.

For example:

When the LIV-BAV-CI-002 is full open, the Q max is about 45m³/h.

$\Delta P = 20\text{kPa}$

FLOW Co-Efficient Value (KV)

Turn	DN50	DN65	DN80	DN100	DN125	DN150	DN200	DN250	DN300	DN350	DN400	DN450	DN500
1	7.40	13.60	14.04	17.60	24.43	30.15	61.52	93.35	77.84	58.67	79.04	71.58	111.27
2	15.80	31.17	28.24	38.70	40.42	50.84	114.27	177.64	180.75	94.05	135.62	150.09	234.51
3	26.70	48.10	42.78	57.30	64.45	70.45	158.44	247.53	244.12	167.18	209.12	240.67	307.44
4	36.90	59.80	62.08	76.50	89.60	93.93	194.06	295.25	309.35	237.79	292.31	329.78	362.50
5	46.20	68.35	82.97	99.30	116.92	122.20	228.97	345.49	353.48	322.44	387.21	446.03	402.51
6	54.00	76.07	103.73	132.50	166.10	149.16	295.88	480.61	408.11	421.79	490.08	590.43	455.27
7	82.61	119.93	167.50	206.71	182.19	375.28	599.27	566.22	557.08	595.60	762.09	762.09	521.47
8	87.84	127.67	190.20	243.57	223.49	452.07	705.34	742.04	704.52	734.44	910.58	910.58	656.80
9	94.47	137.31	211.20	272.85	288.33	526.00	809.04	867.56	871.73	911.75	1294.09	1294.09	809.53
10	-	-	-	307.07	326.57	589.74	916.65	1002.31	1175.55	1153.86	1657.80	1657.80	967.13
11	-	-	-	330.22	372.26	651.03	1006.79	1146.01	1396.09	1407.24	1985.72	1985.72	1162.83
12	-	-	-	-	408.32	708.91	1081.64	1290.26	1697.82	1779.88	2329.01	2329.01	1409.23
13	-	-	-	-	-	759.21	1162.44	1408.81	1917.54	2056.43	2807.31	2807.31	1629.55
14	-	-	-	-	-	-	-	1514.31	2012.05	2377.50	2774.08	2774.08	1894.87
15	-	-	-	-	-	-	-	1619.95	2118.69	2601.18	2887.43	2887.43	2143.69
16	-	-	-	-	-	-	-	1703.45	2211.72	2671.07	3015.55	3015.55	2557.11
17	-	-	-	-	-	-	-	-	2298.74	2764.54	3147.26	3147.26	2894.62
18	-	-	-	-	-	-	-	-	2372.07	2876.41	3251.94	3251.94	3187.54
19	-	-	-	-	-	-	-	-	2450.00	2946.23	3351.62	3351.62	3496.25
20	-	-	-	-	-	-	-	-	-	3011.63	3449.50	3449.50	3725.41
21	-	-	-	-	-	-	-	-	-	3080.00	3558.67	3558.67	3886.75
22	-	-	-	-	-	-	-	-	-	-	3657.72	3657.72	3978.05
23	-	-	-	-	-	-	-	-	-	-	3750.00	3750.00	4051.66
24	-	-	-	-	-	-	-	-	-	-	-	-	4123.87
25	-	-	-	-	-	-	-	-	-	-	-	-	4210.00

PR. INDEPENDENT BALANCING & CONTROL VAL.

LEHRY MAKE Pressure Independent Balancing & Control Valve and the actuator are designed for terminal equipment in PAU,AHU,MAU system and for terminal equipment such as plate heat exchanger in heating system

Features :

- Equal percentage flow characteristic
- Fault auto-detection and alarm function
- The range with auto-detect function
- The regulator valve core is designed straight travel and provided.
Three actuator, such as Modulating Floating point and ON/OFF type

Specification :

- Body & Bonnet : Brass - Screwed (DN15 - DN40)
: Ductile Iron - Flanged (DN40 - DN250)
- Valve Stem : Brass - Screwed
: Stainless Steel 410- Flanged
- Balancing Valve Core : Brass - Screwed
: Stainless Steel 304- Flanged
- Actuator : LIV-AC1000 Electric Actuator - Screwed, LIV-AC05 Electric Actuator - Flanged



LIV-PIBC-BS-LA-SE-001

LIV-PIBC-BS-LA-FE-002

DYNAMIC FLOW AUTOMATIC BALANCING VALVE

LEHRY MAKE DYNAMIC FLOW AUTOMATIC BALANCING VALVE is mainly used for solving problem of hydraulic disorder in flow pipe. It can keep flow in the pipe constant when pressure fluctuate in operating differential pressure.

Features :

- Dynamic Balancing: Constant flow is achieved through the valve cartridge's auto-adjustment of the opening rate when ΔP of the system fluctuates
- Precision calibrated valve plug keeps the flow deviation no greater than $\pm 5\%$
- The flow rate is factory preset multiple ΔP ranges available for each size

Technical Specification :

- Working Temperature : 0 ~ 110°C
- Working Pressure : PN16 / PN 25
- Fluid Medium : Water / Ethylene Glycol
- Connection : Screwed / Wafer / Flanged
- Materials : 1) Body : Brass / Ductile Iron
2) Core : Brass / Stainless Steel
3) O-Ring : EPDM



LIV-DFBV-BS-P5-SE-001



LIV-DFBV-DI-P5-WT-001



LIV-DFBV-DI-P5-FE-001

ELECTRICAL 2/3/4 - WAY CONTROL VALVE

LEHRY MAKE Electrical Two-way / Three Way / Four Way Control Valves LRV061-Series heating valve is a temperature controlled valve for air conditioning environments.

Features :

- Regulator valve core is designed for straight travel through Oblique seat design
- Actuators two Model Modulating and On Off.
- Predetermined Constant Flow Balancing is achieved through the valve Auto Adjustable Capsule to allow Constant flow during pressure fluctuation
- Hydraulic Imbalance In the Pipe, it will keep the flow constant even when there is Pressure Fluctuation at the Inlet and outlet of the valve
- Control valve Actuator models compatible with Lehry, Oventrop, Danfoss, Honeywell and Watts 2 Way on off or modulation Valve or PICVs

Technical Specification :

- Dimensions : DN15-DN25 (Screwed)
- Working Temperature : 5 ~ 95°C (Water / Water + Glycol)
- Working Pressure : PN16
- Materials : 1) Body : Forged Brass (HPb59-1)
2) O-Ring : Nitrile Rubber
2) Stem : Stainless Steel (1Cr18Ni9)

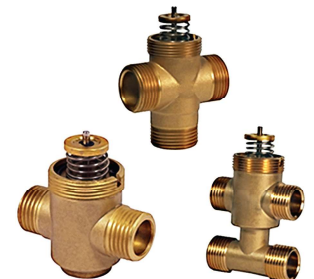

LIV-E2CV-BS-MA-SE-001
LIV-E2CV-BS-ONFA-SE-001

Control valve Actuator models compatible with **Lehry, Oventrop, Danfoss, Honeywell and Watts** On off and Modulating control, electromotive or Electrothermal Actuators with connect suitable to M30 X 1.5

LEHRY MAKE FAN COIL UNIT Valve Packages is used for the isolation, flushing, draining and bleeding of the supply and return pipe installed in the flow direction in front of the fitting or the succeeding sections of the system.

Features :

- Available in DN20 & DN25
- Integral union joints for easy alignment and tightening
- Extended T-handle isolation valves,
- Full bore isolating valve for supply, return and bypass
- Strainer is integrated with drain cock for easy maintenance
- Flexible hoses of length 280mm suitable for the site conditions, provided as a standard accessory
- Special thermal insulation boxes provided as a standard accessory
- Test plugs provided to check the flow rate and temperature
- 230V on/off actuator with valve

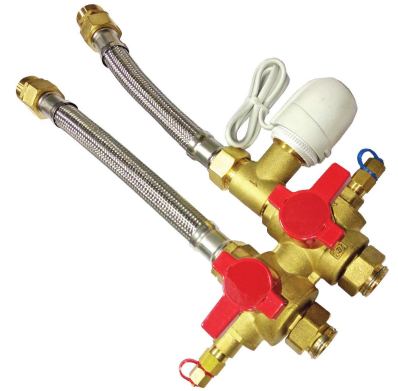

LIV-FCU-BS-001

Specification :

- Body & Bonnet : Brass (CW617N)
- O-Ring : EPDM
- Pressure : 16 Bar
- Temperature : -10 to 120°C
- Actuator : 230V - On/Off Type



Thermal Insulation :

Benefits

- Manufacturing Specially for the FCU Valves Package

Functions of Fan Coil Unit / Installation Example

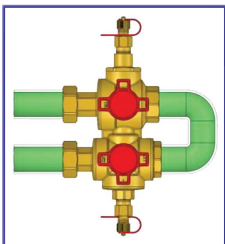

Normal Service Condition

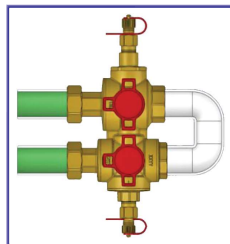

Maintenance State

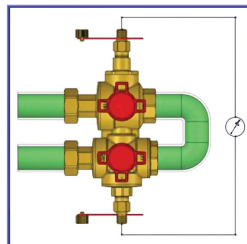

Differential Pressure Detection



Clean/Replace filter

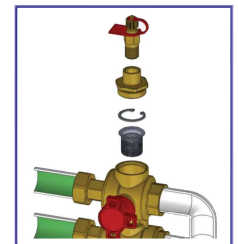

Reassembly filter circlip and bonnet

Design Features:

Lehry FCU Valve Package Control **Honeywell**, **Danfoss**, **WATTS** and **OVERPOP** On/Off Pressure Independent Balancing Control Valve . Without Thermal insulation please check with your sales representative regarding the various options.

UL & FM APPROVED SWING CHECK VALVE

LEHRY MAKE UL & FM Approved SWING CHECK VALVE FLANGED END & GROOVED END are suitable for water, oil & Gas are Coated with Epoxy resin.

Features :

- Body, Bonnet, and wedge made of high strength ductile iron per ASTM A536 65-45-12.
- Interior and exterior of the valves are fusion bond epoxy coated.
- Packing is constructed of high quality graphite.
- Wedge nuts are made of AISI 304 stainless steel.
- Flanged ends are in accordance with ANSI B16.1, Class 125 Or ASME/ANSI B16.42 Class 150.

Specification :

- Design Standard : AWWA C508
- Max. Working Pressure: PN 20 Bar (Max. Test Pressure : PN 30Bar)
- Application : Indoor and Outdoor Use
- Face to Face Standard : ASME B16.10
- Electrostatic spraying Both Inside & Outside of the Body



LIV-CHK-DI-DFM-001

LIV-CHK-DI-DFM-002

UL & FM - OS&Y TYPE GATE VALVE

LEHRY MAKE UL & FM Approved OS&Y Type Gate Valve Flanged End, Grooved End & One Side Flanged End & other Side Grooved End are suitable for water are Coated with Epoxy resin

Features :

- Body, Bonnet, and wedge made of high strength Ductile Iron per ASTM A536 65-45-12.
- Interior and exterior of the valves are fusion bond epoxy coated.
- Each valve is equipped with a hand-wheel that indicates direction of opening.
- Operating stems are made of Stainless steel.
- Wedge nuts are made of AISI 304 stainless steel.
- Flanged ends are in accordance with ANSI B16.1, Class 125 or ASME/ANSI B16.42 Class 150

Specification :

- Design Standard : AWWA C509
- Max. Working Pressure: PN 16 Bar (Max. Test Pressure : PN 24Bar) & PN 20 Bar (Max. Test Pressure : PN 30Bar) for Both Side Flanged End, Others One side Flange & Grooved End for PN16 Bar
- Face to Face Standard : ASME B16.10
- Electrostatic spraying Both Inside & Outside of the Body
- Materials : 1) Disc : EPDM + DI
: 2) Sealing Ring : EPDM
: 3) Packing : Graphite
: 4) Gasket : C94500



UL & FM - NRS TYPE GATE VALVE

LEHRY MAKE UL & FM Approved Non Rising Type Gate Valve Flanged End, Grooved End & One Side Flanged End & other Side Grooved End are suitable for water are Coated with Epoxy resin

Features :

- Body, Bonnet, and wedge made of high strength Ductile Iron per ASTM A536 65-45-12.
- Interior and exterior of the valves are fusion bond epoxy coated.
- Each valve is equipped with a hand-wheel that indicates direction of opening.
- Operating stems are made of Stainless steel.
- Wedge nuts are made of AISI 304 stainless steel.
- Flanged ends are in accordance with ANSI B16.1, Class 125 or ASME/ANSI B16.42 Class 150

Specification :

- Design Standard : AWWA C515
- Max. Working Pressure: PN 16 Bar (Max. Test Pressure : PN 24Bar) & PN 20 Bar (Max. Test Pressure : PN 30Bar) for Both Side Flanged End, Others One side Flange & Grooved End for PN16 Bar
- Face to Face Standard : ASME B16.10
- Electrostatic spraying Both Inside & Outside of the Body
- Materials : 1) Disc : EPDM + DI
: 2) Steam : SS.304
: 3) Plug : Forged Brass C94500
: 4) Gasket : EPDM



VERTICAL TYPE POST INDICATOR VALVE

LEHRY MAKE NON-FM Approved Cast Iron Vertical Posts are designed to operate the control valve of an automatic fire sprinkler system.

Features :

- Indicates if the valve is in the open or shut position.
- The indicator post provides a means to operate a buried or otherwise inaccessible valve.
- The adjustment range of the indicator post is 34.5" to suit the deeper buried valve and can be easily adjusted in the field.
- The wrench handle fits over a "U" bracket on the barrel, and may be fixed with a padlock to secure the operation wrench to the barrel.
- OPEN and SHUT targets can be easily adjusted to fit exactly in the viewing window.
- Internally and externally spray epoxy painted RAL3000





CORPORATE OFFICE

LEHRY INSTRUMENTATION & VALVES PVT. LTD.,

“LEHRY CHAMBERS” : New No. 78 / Old No. 51, Sembudoss Street, P.B No. 1506, Parrys, Chennai - 600 001.

Ph: 044 - 25226995, 25225185, 25226187, 25231715, 42163823

Email : info@lehry.com / Website : www.lehryvalves.com / www.lehry.com

MANUFACTURING UNIT

Ahmedabad Plot No :129, B/h. Kashiram Textile Mill, Narol Road, Ahmedabad 382 405

Jalandhar Wariana Ind. Complex, Sangal Sohal Road, Jalandhar - 144 013

China Xudou Industrial Zone, Qinggang, Yuhuan, Zhejiang 317606, China

WAREHOUSE ADDRESS

Chennai CMDA Iron & Steel Market, 90-B, Sathangadu Village, Thiruvottiyur, Chennai - 600 019

LIVE STUDIO ADDRESS :

Chennai Spencer Plaza, Phase - III, Ground Floor, Shop No. G-132, 768-769, Anna Salai, Chennai, - 600002
Phone : 044 - 48558001 / 48558002

OFFICES

Hyderabad Plot No:22,Jupiter Colony, Near AOC gate, Vikramapuri, Karkhana, Secundrabad - 500015
Phone : 040 – 64569782/40038409, Email : hyderabad@lehry.com

Mumbai 37/38,1st floor Empire Building, Dr.DN Road, Fort, Mumbai-400001
Phone : 02222071055, Email : mumbai@lehryvalves.com

Kolkata 2/F Temple Street, Kolkata - 700 072
Phone : +919681580886 Email : kolkata@lehryvalves.com

Vishakapatnam 7-5-1/24 Prince Apartment, Kquality complex, RK Beach Road, Vishakapatnam,
Andhra Pradesh 530003. Phone : +918247834432 Email : inshiya@lehryvalves.com

UAE PO Box: 150620 – Industrial Area No: 5, Warehouse No – 1 & 5, Sharjah, U.A.E.
Phone : +971 (6) 542 4300. Email : uae@lehryvalves.com

SRILANKA **Lehry Valves & Automation.** 441 / 3A Thimbiriasyaya Road, Longdon Hill,
Colombo – 05, Sri Lanka. PH: 011 – 2583175, Email: zakyu@lehryvalves.com