

MEN'S ARTISTIC GYMNASTICS



CODE OF POINTS 2025-2028

Approved by the FIG Executive Committee, on February 2024
Date of publication: 01st July 2024

ACKNOWLEDGEMENTS

President	Arturs MICKEVICS	LAT
1 st Vice-president	Jeff THOMSON	CAN
2 nd Vice-president	Andrew TOMBS	GBR
Member	Yoon Soo HAN	KOR
Member	Julio MARCOS FELIPE	ESP
Member	Dmitrii ANDREEV	RUS
Member	Butch ZUNICH	USA
Athletes' Representative	Aljaz PEGAN	SLO
Elaboration and layout	FIG Office	

ABBREVIATIONS

MTC	- Men's Technical Committee
OG	- Olympic Games
WC	- World Championships
TR	- Technical Regulations
COP	- Code of Points
FX	- Floor Exercise
PH	- Pommel Horse
SR	- Rings
VT	- Vault
PB	- Parallel Bars
HB	- Horizontal Bar
DV	- Difficulty Value(s) A, B, C, D, E, F, G, H, etc...
CV	- Connection Value
EG	- Element Group
NR	- Non-recognition
ND	- Neutral deduction



ACKNOWLEDGEMENTS	2
ABBREVIATIONS	2

PART I - Regulations Governing Competition Participants _____ 5

Section 1 - Purpose	5
Article 1	5
Section 2 - Regulations governing Gymnasts	5
Article 2.1 Rights of Gymnasts	5
Article 2.2 Responsibilities of the Gymnast	6
Article 2.3 Duties of the Gymnast.	6
Articles 2.4 Penalties.	7
Article 2.5 Gymnasts' Oath	7
Section 3 - Regulations for coaches	8
Article 3.1 Rights of the Coaches	8
Article 3.2 Responsibilities of the Coaches to:	8
Article 3.3 Penalties - Behavior of the coach	8
Article 3.4 Inquiries	9
Article 3.5 Coaches' Oath	9
Section 4 - Regulations for the Technical Committee	9
Article 4.1 The President of the MTC.	9
Article 4.2 The MTC Members	10
Section 5 - Regulations and Structure of Judges' Panel.....	10
Article 5.1 Responsibilities	10
Article 5.2 Rights	10
Article 5.3 Composition of the Judges' Panel	11
Article 5.4 Function of the Judges' Panel.	11
Article 5.5 Functions of the Time Judges, Line Judges.	12
Article 5.5.2 Functions of the Secretaries.	12
Article 5.6 Seating Arrangements	12
Article 5.7 Judge's Oath (FIG TR 7.12)	12
Article 5.8 MAG Naming of New Elements	12

PART II - Evaluation of exercises _____ 13

Section 6 - The Evaluation of Competition Exercises.....	13
Article 6.1 General Rules	13
Article 6.2 - Determination of the Final Score	13
Article 6.3 - Short exercise	13
Section 7 - Regulations Governing the D-score.....	14
Article 7.1 Difficulty Value (DV)	14
Article 7.2 Element Group and Dismount Requirements	14
Article 7.3 Connection Points	14
Article 7.4 Evaluation by the D-Jury	14
Article 7.5 Repetition	15
Article 7.6 D-Jury Evaluation	15
Section 8 - Regulations Governing E-score	16



Article 8.1 Description of Exercise Presentation	16
Article 8.2 Calculation of E-Jury deductions	16
Article 8.3 Instructions for the Gymnast	16
Section 9 - Technical Directives	16
Article 9.1 Evaluation by the E-Jury.	16
Article 9.2 Determination of Execution and Technical Errors.	17
Article 9.3 Expectations for Exercise Construction	19
Article 9.4 E-Jury deductions	20

PART III APPARATUS **22**

Section 10 Floor Exercise	23
Article 10.1 Exercise description	24
Article 10.2 Content and Construction	24
Article 10.3 Specific Deductions for Floor Exercise.	26
Section 11 Pommels Horse	53
Article 11.1: Exercise description	54
Article 11.2: Content and Construction	54
Article 11.3 Specific Deductions for Pommel horse	60
Section 12 Rings	73
Article 12.1 Exercise description	74
Article 12.2 Content and Construction	74
Article 12.3 Specific Deductions for Rings	76
Section 13 Vault	94
Article 13.1 Description of a Vault	95
Article 13.2 Content and construction	95
Article 13.3 Table of Specific Errors and Deductions for Vault	97
Section 14 Parallel Bars	107
Article 14.1 Exercise Description	108
Article 14.2 Content and Construction	108
Article 14.3 Specific Deductions for Parallel Bars	110
Section 15 Horizontal Bar	127
Article 15.1 Exercise description	128
Article 15.2 Content and Construction	128
Article 15.3 Specific Deductions for Horizontal Bar	131

PART IV – Appendices **149**

Appendix A	150
Additional Explanations & Interpretations	150



REGULATIONS GOVERNING COMPETITION PARTICIPANTS

Section 1 - Purpose

Article 1

The primary purpose of the Code of Points is to:

1. Provide an objective means of evaluating gymnastics exercises at all levels of regional, national, and international competitions.
2. Standardize the judging of the four phases of FIG official competitions: Qualifications, Team Final, All-Around Final and Apparatus Finals.
3. Assure the identification of the best gymnast in any competition.
4. Guide coaches and gymnasts in the composition of competition exercises.
5. Provide information about the source of other technical information and regulations frequently needed at competitions by judges, coaches, and gymnasts.

Section 2 - Regulations governing Gymnasts

Article 2.1 Rights of Gymnasts

General

The gymnast is guaranteed the right to:

- a) Have their performance judged correctly, fairly, and in accordance with the stipulations of the Code of Points.
- b) Receive in writing the evaluation of the difficulty rating for a submitted new vault or element within a reasonable time prior to the start of the competition.
- c) Have their score publicly displayed immediately following his performance or in accordance with the specific regulations governing that competition.
- d) Repeat their entire exercise, if the exercise has been interrupted for reasons beyond his control or responsibility with permission of the Superior Jury.
- e) Briefly leave the competition hall for personal reasons and that such a request not be unreasonably denied with permission, based on the directives of the competition or from the Superior Jury President.
NOTE: The competition may not be delayed through his absence.
- f) Receive through their delegation leader the correct result output, showing all his scores received in the competition.

Apparatus

The gymnast is guaranteed the right to:

- a) Have identical apparatus and mats in the training halls, warm up hall and on the competition podium that conforms to the specifications and norms for FIG official competitions.
- b) Use of mandatory additional 10 cm soft mats on top of the existing basic landing mats (20 cm) for Rings, Vault and Horizontal Bar.
- c) Be assisted to the hanging position by a coach or gymnast for the start of their exercise on Rings and Horizontal Bar.
- d) Have one spotter present at Rings and Horizontal Bar.
- e) Rest or recuperate in the allowable time following a fall from the apparatus.
- f) Speak with their coach during the allowable time available to him following a fall from the apparatus and between the first and second vaults.
- g) Request permission to raise the Horizontal Bar to accommodate their height.
- h) Repeat the entire exercise (Rings or Horizontal Bar only) without deduction at the end of the rotation with approval by the D-Jury, if the gymnast shows a significantly torn hand-guard (grip) causing a fall or exercise interruption.

Warm-up

In Qualifications, All-Around Final Team Final and Apparatus Finals.

- Each competing gymnast (including substitute of injured gymnast) is entitled to a 50 sec. touch warm-up period immediately prior to the competition on the podium on all apparatus in accordance with the Technical Regulations that govern that competition.

NOTES:

- In the Qualifications or Team Final, for preparation of any apparatus prior to an exercise (during the touch warm-up and competition), any FOP accredited person from the federation of the gymnasts may assist. In the All-Around or Apparatus Finals, a maximum of three people (the competing gymnast, coach, and 1 other FOP accredited person) may be on the podium to prepare the apparatus.
- The end of the warm-up period is identified by an audible signal. If a gymnast is mentally and physically prepared to vault or is still on the apparatus at that time, they may complete the element or sequence started. Following the warm-up period or during the “competition pause”, the apparatus may be prepared, but not used.
- Timing related to all exercises (start of exercise and exercise duration) will be done in 1 second increments.
- There will be a conspicuous signal from the D1 judge (at official FIG competitions, a green light) 30 seconds before their exercise is expected to begin.
- In Qualification and Team Final the entire warm-up time belongs to the team. The team must pay attention to the time elapsed so that the last gymnast receives a warm-up.
- In mixed-groups the warm-up time belongs personally to the gymnast. The order of warm up should be the same as the order of competition.

Article 2.2 Responsibilities of the Gymnast

- a) To know the Code of Points and conduct himself accordingly.
- b) To submit, or have their coach submit, a written request at least 24 hours before podium training to the Superior Jury President to assess the difficulty of a new element.
- c) To submit, or have their coach submit, a written request at least 24 hours before podium training to the Superior Jury President to raise the Horizontal Bar; or to submit such requests in accordance with the Technical Regulations that govern that competition.

Article 2.3 Duties of the Gymnast.

General

- a) To present himself raising 1 or 2 arms and thereby acknowledge the D1 judge at the commencement of his exercise and to acknowledge the same judge at the conclusion of his exercise.
- b) To begin the exercise within 30 seconds of the green light or signal from D1 judge (*on all apparatus*).
- c) To remount within 30 seconds after a fall (the timing starts when the gymnast is on his feet after the fall). In this time the gymnast can recuperate, re-chalk, confer with his coach and remount. If a gymnast intentionally remains off of his feet, in order to avoid the 30 second from starting (resting, adjusting grips, receiving chalk from coach, delaying the competition without justification, etc.), then the following rule may be applied from Article 2.4.e: “Other undisciplined or abusive behaviour - 0.3 from the Final Score by the D1 Judge”
- d) To leave the podium immediately after the conclusion of their exercise.
- e) To refrain from changing the height of any apparatus, unless permission has been granted.
- f) To refrain from speaking with active judges during the competition.
- g) To refrain from delaying the competition, remaining on the podium for too long, remounting the podium on completion of his exercise, and from otherwise abusing his rights or infringing on those of any other participant.
- h) To refrain from any other undisciplined or abusive behavior or infringing on those of any other participant (i.e. marking the floor carpet with magnesium, damaging any apparatus surface or parts during preparation for his exercise or removing springs from the spring board, spraying pommel horse or vault table with water or other substance. These violations will be treated as apparatus related violations, and will be deducted as large errors with 0.5 points).
- i) To notify the Superior Jury, if a necessity arises to leave the competition hall. The Competition may not be delayed through his absence. To leave the supplementary mats in position (for landing) during the entire exercise.
- j) To participate in the respective Award Ceremony dressed according to FIG Protocol.

Competition Attire

- a) They must wear long gymnastics pants and socks on Pommel Horse, Rings, Parallel Bars and Horizontal Bar. Long gymnastics pants, socks and/or slippers that are black or the darker shades of blue, brown or green are not permitted.
- b) They have the option of wearing short pants with or without socks or long gymnastics pants with socks on Floor Exercise and Vault.
- c) The wearing of a gymnastics singlet on all apparatus is compulsory.
- d) They have the option of wearing of gymnastic footwear and / or socks.
- e) They must wear the bib number supplied by the organizing committee.
- f) They must wear a national identification or emblem on their singlet in accordance with the most recent FIG Rules Competition Clothing and Advertising.
- g) They must wear only those logos, advertising and sponsorship identifiers that are permitted in the most recent FIG Rules Competition



Clothing and Advertising.

- h) The competition attire must be identical for members from the same federation in the Qualifications and Team Final Competitions. In the Qualifications individual gymnasts from the same federation (without a team) may wear different competition attires.
- i) Gymnast must refrain from wearing compression sleeves during competition. Handguards, body bandages, and wrist wraps are permitted; they must be securely fastened, in good repair and should not detract from the aesthetics of the performance. Skin-colored bandages are recommended.

Articles 2.4 Penalties.

- a) The normal penalty for a violation of the rules and expectations presented in Article 2 and Article 3 are considered medium errors of 0.30 points for behavioral violations and large errors of 0.50 points for apparatus related violations.
- b) A few other possibilities for penalties also exist and these are outlined below.
- c) Unless otherwise indicated these penalties are always applied by the D1 judge to the Final Score for that exercise.
- d) In extreme cases, the gymnast or coach may be expelled from the competition hall in addition to suffering the specified penalty.
- e) Violations and the associated penalties are:

Articles 2.4.1. Table of Violations and Penalties.

Violation	Penalty
Behaviour Related Violations	
Any attire violations (Art. 2.3).	0.30 from the Final Score (once for a competition session) Applied by the Superior Jury President.
Non respect of the official warm up time.	0.30 from the Final Score by the D1 judge.
Not acknowledging the D1 judge before or after the exercise.	0.30 for each time from the Final Score by the D1 judge.
Exceeding 30 sec. before commencing exercise.	0.30 from the Final Score by the D1 judge.
Exceeding 60 sec. before commencing exercise.	Exercise is terminated.
Exceeding 30 sec. before continuing after a fall.	0.30 from the Final Score by the D1 judge.
Exceeding 60 sec. before continuing after a fall.	Exercise is terminated at the fall
Remounting podium after the exercise.	0.30 from the Final Score by the D1 judge.
Other undisciplined or abusive behavior.	0.30 from the Final Score by the D1 judge.
Apparatus Related Violations	
Non-permitted presence of spotter.	0.50 from the Final Score by the D1 judge.
Incorrect use of magnesium and/ or damaging apparatus, including spraying (excluded PB).	0.50 from the Final Score by the D1 judge.
Illegal use of supplementary mats or non-use where required.	0.50 from the Final Score by the D1 judge.
Coach moving supplementary mats during the exercise.	0.50 from the Final Score by the D1 judge.
Changing the height of the apparatus without permission.	0.50 from the Final Score by the D1 judge.
Re-arrangement or removal of springs from the springboard.	0.50 from the Final Score by the D1 judge.
Other Individual Violations	
Absent from the competition area without permission, failure to return and complete the competition.	Disqualification from remainder of competition (By Superior Jury).
Absent from Victory Ceremony.	Result and Final Score is annulled for team and individual purposes (By Superior Jury).
Performing without signal or green light.	Final Score = 0 points.
Team Violations	
Team gymnast(s) compete in wrong order on an apparatus.	1.00 from the Team's Total Score on the applicable apparatus (By the Superior Jury President).
Non respect of the official warm up time.	1.00 from the Team's Total Score each time (By the Superior Jury President)
Violations of attire regulations that apply to Team Competition.	1.00 from the Team's Total Score, once per competition (By the Superior Jury President).

Article 2.5 Gymnasts' Oath

"In the name of all gymnasts, I promise that we shall take part in this World Championships (or any other official FIG Event) respecting and abiding by the rules which govern them, committing ourselves to a sport without doping and without drugs, in the true spirit of sportsmanship, for the glory of sport and the honour of the gymnasts."



Section 3 - Regulations for coaches

Article 3.1 Rights of the Coaches

The coach is guaranteed the right to:

- a) Assist the gymnast or team under his care in submitting written requests related to the raising of apparatus and the rating of a new vault or element.
- b) Assist the gymnast or team under their care on the podium during the warm up period on all apparatus.
- c) Help the gymnast or team prepare the apparatus for competition. Preparation of any apparatus may be performed by coaches for the upcoming rotation upon completion of the final exercise in the current rotation and publication of the last gymnast's score on that apparatus.
- d) Lift the gymnast to a hanging position on the Rings and Horizontal Bar.
- e) Be present on the podium after the green light is lit to remove the springboard on Parallel Bars.
- f) Be present at Rings and Horizontal Bar during the gymnast's exercise for reasons of safety.
- g) Assist or advise the gymnast during the thirty seconds after a fall on all apparatus and between the first and second vault.
- h) Have their gymnast's score publicly displayed immediately following their performance or in accordance with the specific regulations governing that competition.
- i) Be present at all apparatus to help in case of injuries or defects of the apparatus.
- j) Inquire to Superior Jury concerning the evaluation of the content of the exercise of the gymnast (see Art. 3.4).
- k) Request to Superior Jury a review of the Time and Line deductions.

Article 3.2 Responsibilities of the Coaches to:

- a) Know the Code of Points and conduct themselves accordingly.
- b) Submit the competition order and other information required in accordance with the Code of Points and/or the FIG Technical Regulations that govern that competition.
- c) Refrain from changing the height of any apparatus or adding, rearranging or removing springs from the springboard.
- d) Refrain from delaying the competition, obstructing the view of the judges and from otherwise abusing or interfering with the rights of any other participant.
- e) Refrain from speaking to the gymnast or from assisting in any other way (give signals, shouts, cheers or similar) during his performance.
- f) Refrain from engaging in discussions with active judges and/or other persons outside of the field of play during the competition (exception: team doctor, delegation leader).
- g) Refrain from any other undisciplined or abusive behavior.
- h) Conduct themselves in a fair and sportsmanlike manner at all times during the competition and Award Ceremony.

NOTE: See Deductions for Violations and Unsportsmanlike Behavior.

Number of Coaches permitted in the field of play:	
Qualifications and Team Final Competition	
- Complete teams	1 or 2 coaches
- Nations with individuals	1 coach
All - Around Competition and Apparatus Finals Competition for	
- Each gymnast	1 coach

Article 3.3 Penalties - Behavior of the coach

By the Superior Jury President	For FIG Official and Registered Competitions
Behavior of Coach with no direct impact on the result/performance of the gymnast/team	
Unsportsmanlike conduct (valid for all phases of the competition).	1st time, Yellow card for coach (warning).
	2nd time, Red card for coach and removal of coach from the competition.*
Other flagrant, undisciplined and abusive behaviour (valid for all phases of the competition).	Immediate Red card for coach and removal of coach from the competition.*



Behaviour of Coach with direct impact on the result/performance of the gymnast/team

Unsportsmanlike conduct, i.e. unexcused delay or interruption of competition, speaking to active judges during the competition except to D1 judge (inquiry only permitted), speaking directly to the gymnast, by giving signals, shouts (cheers) or similar during the exercise, etc.	1st time -0.50 (from gymnast/team at event) and Yellow card for coach (warning) if coach speaks to active judges.
	1st time -1.00 (from gymnast/team at event) and Yellow card for coach (warning) if coach speaks aggressively to active judges.
	2nd time – 1.00 (from gymnast/team at event), Red card for coach and removal of coach from the competition floor.*
Other flagrant, undisciplined and abusive behaviour, i.e. incorrect presence of unauthorized persons in inner circle during competition, etc.	-1.00 (from gymnast/team at event), immediate Red card for coach and removal of coach from the competition floor.*

Note: If one of the two coaches from a team is dismissed from the competition inner circle, it is possible to replace that coach with another coach **one time** during the entire competition.

1st offense = yellow card.

2nd offense = red card, at which time the coach is excluded from the rest of the competition phases.

* if there is only one coach, then the coach would remain in the competition but would not be eligible for accreditation at the next World Championships, Olympic Games.

Article 3.4 Inquiries

Please refer to FIG TR (FIG Technical Regulations).

Article 3.5 Coaches' Oath

"In the name of all Coaches and other members of the athlete's entourage, I promise that we shall commit ourselves to ensuring that the spirit of sportsmanship and ethics is fully adhered to and upheld in accordance with the fundamental principles of Olympism. We shall commit ourselves to educating the gymnasts to adhere to fair play and drug free sport and to respect all FIG Rules governing the World Championships."

Section 4 - Regulations for the Technical Committee

Article 4.1 The President of the MTC.

The **President of the Men's Technical Committee** or his representative will serve as Superior Jury President. Their responsibilities and those of the Superior Jury include:

- a) The overall technical direction of the competition as outlined in the FIG Technical Regulations.
- b) To call and chair all judges' meetings and instruction sessions.
- c) To apply the stipulations of the Judges' Regulations applying to that competition.
- d) To deal with requests for evaluation of new elements, raising the Horizontal Bar, leaving the competition area, and other issues that may arise. Such decisions are normally made by the Men's Technical Committee.
- e) To make sure that the time schedule published in the Work plan is respected.
- f) To control the work of the Apparatus Supervisors and intervene if deemed necessary. Except in case of an inquiry, time or line revision, generally no change of score is allowed after the score has been flashed on the score board.
- g) To deal with inquiries as outlined herein.
- h) In cooperation with the members of the Superior Jury, to issue warnings to or replace any person acting in any judging capacity who is considered to be unsatisfactory or to have broken their oath.
- i) To conduct a video analysis (post competition) with the TC to determine errors in judgment and to submit the results of the Judges evaluation to the GEF (Gymnastics Ethics Foundation) Disciplinary Commission.
- j) To supervise the checking of the apparatus measurement specifications according to the FIG Apparatus Norms.
- k) In unusual or special circumstances may nominate a judge to the competition.
- l) To submit a report to the FIG Executive Committee, which must be sent to the FIG Secretary General as soon as possible, but no later than 30 days after the event, which contains the following:
 - General remarks about the competition including special occurrences and conclusions for the future.
 - Detailed analyses of the judges' performance including proposals for rewarding the best judges and sanctions against the judges who fail to meet expectations within 3 months.
 - Detailed list of all interventions (score changes before and after publication).
 - Technical analyses of the D-scores.



Article 4.2 The MTC Members

During each phase of the competition, the members of the Men's Technical Committee or their representatives will serve as members of the Superior Jury and Apparatus Supervisors.

Their responsibilities include:

- a) To participate in the direction of the judges' meetings and instruction sessions and guide the judges to perform the correct work on their respective apparatus.
- b) To apply the Judges' Regulations control with fairness, consistency and completely in accordance with the currently valid regulations and criteria.
- c) To record the entire exercise content in symbol notation.
- d) To calculate the D and E Scores (control scores) for the purpose of evaluation of the D and E Juries.
- e) To control the total evaluation and the final score for each exercise.
- f) To check the apparatus used at training, warm-up and competition with the FIG Apparatus Norms.

Section 5 - Regulations and Structure of Judges' Panel

Article 5.1 Responsibilities

Every judge is fully and solely responsible for their own scores. All members of the Judges' Panel have the responsibility to:

- a) Have thorough knowledge of:
 - the FIG Technical Regulations,
 - the Code of Points,
 - the FIG Judges' Rules,
 - any other technical information necessary to carry out their duties during a competition.
- b) Have extensive knowledge in contemporary gymnastics and to understand the intent, purpose, interpretation, and application of each rule.
- c) Attend all scheduled instruction sessions and meetings of judges before the respective Competition (extraordinary exceptions, which were unavoidable, will be decided by the FIG MTC).
- d) Adhere to any special organisational or judging related instruction given by the governing authorities (i.e. Scoring system instructions).
- e) Participation in podium training is not mandatory for all judges unless indicated in the directives of the competition.
- f) Be thoroughly prepared for all apparatus
- g) Be capable of fulfilling the various necessary duties, which include:
 - Correctly completing any required score sheets.
 - Using any necessary computer equipment.
 - Facilitate the efficient running of the competition.
- h) Be well prepared, rested, vigilant, and punctually present at least one hour before the start of competition or according to the instructions from the Work plan.
- i) Wear the FIG prescribed competition uniform dark blue suit, white shirt with tie, except competitions, where the uniform is supplied by the Organizing Committee.

During the competition judges must:

- a) Behave at all times in a professional manner and exemplify non-partisan ethical behaviour.
- b) Fulfill the functions outlined as specified in Article 5.4.
- c) Evaluate each exercise accurately, consistently, quickly, objectively and fairly.
- d) Maintain a record of their personal scores.
- e) Remain in own assigned seat (except with the consent of D1 judge) and refrain from having contact or discussions with gymnasts, coaches, delegation leaders or other judges.

Penalties for inappropriate evaluation and behaviour by judges will be in accordance with the current version of the FIG Judges' Rules and/or the FIG TR that apply to that competition.

Article 5.2 Rights

In case of an intervention by the Superior Jury, the Judge has the right to explain their score and to agree (or not) to a change. In case of disagreement the Judge may be overruled by the Superior Jury and shall be informed accordingly.

In case of arbitrary action taken against a judge, they have the right to file an appeal:

- a) To the Superior Jury, if the action was initiated by the Apparatus Supervisor or
- b) To the Jury of Appeal, if the action was initiated by the Superior Jury.



Article 5.3 Composition of the Judges' Panel

Article 5.3.1 The Judges' Panel

For the official FIG Competitions, World Championships and Olympic Games, the Judges' Panel will consist of a D-Jury and an E-Jury.

- The D Judges are drawn and appointed by the FIG Technical Committee in accordance with the most current FIG Technical Regulations
- E Judges and supplementary positions will be drawn under the authority of the TC in accordance with the current FIG Technical Regulations or Judges' Rules that govern that competition.

- The structure of the Judges' Panel for the various types of competitions should be as follows:

WCH and OG	Other Events
<u>9 Judges:</u> 2 D Judges 7 E Judges	Please refer to FIG General Judges' Rules

Article 5.3.2 Line and Time judges:

- 2 line judges for Floor Exercise,
- 1 line judge for Vault,
- 1 time judge for Floor Exercise,

Modifications to the Judges' Panels are possible for other international competitions and for national and local competitions.

Article 5.4 Function of the Judges' Panel.

Article 5.4.1 Functions of the D-Jury.

- a) D Judges record the entire exercise content in symbol notation, evaluate independently, without bias and then jointly determine the D-score content. Discussion is permitted.
- b) The D-Jury enters the D-score into the computer.
- c) The D-score content includes:
 - The value of elements (difficulty value) according to the table of elements.
 - The connection value, based on special rules for each apparatus.
 - The number and the value of Element Group Requirements executed.

Function of The D1 judge:

- a) To serve as liaison between the Judges' Panel and the Apparatus Supervisor. The Apparatus Supervisor will then consult when necessary with the Superior Jury.
- b) To coordinate the work of the Time Judges, Line Judges and Secretaries.
- c) To ensure the efficient running of the apparatus including the control of warm up time.
- d) To display the green light or other conspicuous signal to notify the gymnasts they must begin their exercise within thirty seconds.
- e) To ensure that neutral deductions for time, line, behaviour faults are taken from the Final Score before being released.
- f) To ensure the correct penalties for a short exercise are applied.
- g) To ensure the following deductions are applied for:
 - Failure to present before and after the exercise.
 - Performance of an invalid "0" vault.
 - Assistance during the: Vault, Exercise and Dismounts.

Function of the D-Jury after the Competition:

Will submit a written competition report, as directed by the TC President with the following information:

- Forms listing violations, ambiguities and questionable decisions with the number and name of the gymnast.
- The content of all exercises to the President of the Men's Technical Committee and the Apparatus Supervisor in the Superior Jury in one of the official FIG languages within 2 weeks of the competition.

Article 5.4.2 Functions of the E-Jury

- a) They must observe the exercises attentively, evaluate the faults and apply the corresponding deductions correctly, independently and without consulting the other judges.
- b) They must record the deductions for:
 - General Faults.
 - Technical compositional errors.
 - Positional Errors.
- c) They must complete the score slip with a legible signature or enter their deductions into the computer.
- d) They must be able to provide a personal written record of their evaluation of all exercises.

Article 5.5 Functions of the Time Judges, Line Judges.

Article 5.5.1 The Time and Line Judges

The Time and Line Judges are drawn from among the Brevet judges to serve as:

Line judges to:

- Determine on Floor and VT stepping outside of the border marking and to acknowledge the fault by raising a red flag.
- Inform the D1 judge of any violation and deduction and sign and submit the appropriate written record.
- On Vault control the number of vaults executed during warm up.

Time judges are required to:

- Time the duration of the exercise (FX).
- On FX give an audible signal to the gymnast at completion of 60 and 70 seconds.
- Inform the D1 judge of any violation and deduction and sign and submit the appropriate written record.
- For time violations where there is no computer input, the time judge must record the exact amount of time over the time limit.

Article 5.5.2 Functions of the Secretaries.

The Secretaries need to have COP and computer knowledge. They are usually appointed by the Organizing Committee. Under the supervision of the D1 judge, they are responsible for the accuracy of all entries into the computers:

- Adherence to the correct order of the teams and gymnasts.
- Operating the green and red lights.
- Correct releasing of the Final Score.
- Time the duration of the fall period.
- Press the start button to show the green light is lit and show gymnast the exercise can commence.

Article 5.6 Seating Arrangements

The judges will be seated at a location and distance from the apparatus which permits an unobstructed view of the total performance and which permits them to fulfill all of their evaluation duties.

- D Judges must be in line with the centre of the apparatus.
- The Time Judge sits by the Judges' Panel (either side).
- The line judges at FX must sit at opposite corners and observe the 2 lines closest to them.
- The line judge at Vault must sit at the far end of the landing area.
- The placement of the E-Jury will be clockwise around the apparatus beginning from the left of the D-Jury, or judges are placed in a straight line the D2, E1, E2 and E3 will be seated to the left of the D1 in that order and Secretary, E7, E6, E5 and E4 will sit to the right in that order

Variations in the seating arrangement are possible depending on the conditions available in the competition hall.

Article 5.7 Judge's Oath (FIG TR 7.12)

At the World Championships, and other important international events, juries and judges pledge to respect the terms of the Judges' Oath:

"In the name of all the judges and officials, I promise that we shall officiate in these World Championships (or any other official FIG Event) with complete impartiality, respecting and abiding by the rules which govern them, in the true spirit of sportsmanship."

Article 5.8 MAG Naming of New Elements

- Performed internationally for the first time at an official FIG Group 1, 2 or 3 competition (with or without an official FIG TD present)
- C value or higher and performed for value without a fall.
- Difficulty value and name will only be confirmed following a TC analysis of the performance
- If more than one gymnast at the same competition performs the same new element, the element will be named after all gymnasts.
- The Federation of the gymnast has the responsibility to submit a video of the proposed new element to the FIG TC President as soon as possible after the competition. In addition, the competition TD must submit the official video, original video and drawing submitted by the coach (if available), and all details about the provisional evaluation given at the competition, to the FIG TC President as soon as possible.



Section 6 - The Evaluation of Competition Exercises

Article 6.1 General Rules

- Two separate scores, "D" and "E", will be calculated on all apparatus.
 - The D-Jury determine the D-score, the content of an exercise, and the E-Jury the E-score, i.e. the exercise presentation related to compositional requirements, technique and body position.
 - D-score content will include by addition :
 - The additional difficulty value of 8 elements, the best 7, but maximum 4 elements for the same Element Group, inside the best counting plus the value of the dismount. If the judge needs to choose the counting 7 elements from elements which have the same value but belong to different Element Groups, he must determine them to the benefit of the gymnast.

Example 1:

I	I	II	III	III	III	III	II	II	IV
A	B	B	B	B	B	C	E	C	D
	B		B	B	B	C	E	C	D

Example 2 : Floor

II	II	I	I	IV	II	III	II	IV	III
A	D	B	D	B	D	D	D	D	D
	D	B	D		D	D	D	D	D

In bold letters counting element

- The connections value, based on special rules on different apparatus.
- Element Group Requirements Value, performed among the 8 counting elements.
- E-score, will start from 10 points and will evaluate by deductions applied in tenths of a point:
 - The total deductions for aesthetic and execution errors.
 - The total deductions for technical and compositional errors.
 - The highest and the lowest sums of total deductions applied in tenths of a point for execution, aesthetic, technical and compositional errors are eliminated. The average remaining sums is subtracted from the 10 points in order to determine the Final E-Score.

The E-score is calculated as follows:

- 7 E-score deductions: average the middle 3
- 5 E-score deductions: average the middle 3
- 4 E-score deductions: average the middle 2
- 3 E-score deductions: average the 3
- 2 E-score deductions: average the 2

Article 6.2 - Determination of the Final Score

- The Final Score of an exercise will be established by the addition of the D-Score and Final E-scores.
 - The rules governing the evaluation of the exercises and the determination of the Final Score are identical for all sessions of optional competition (Qualifications, Team Final, All-Around Final, Apparatus Finals) except for Vault, where special rules in Qualifications and in Apparatus Finals apply (see Section 13).
 - The All-Around Score is the sum of the Final Scores obtained on the six exercises.
 - The Team's Total Score is calculated in accordance with the current FIG Technical Regulations that govern that competition.
- Qualification for, and participation in, the Team Final, the All-Around Final, and the Apparatus Finals will occur in accordance with the current FIG Technical Regulations that govern that competition.
 - The Final Score is normally calculated by the competition scoring personnel, but must be confirmed by the Apparatus Supervisor before it is displayed.
 - At official FIG competitions, the single D-score from the D-Jury and the Final E-score will be displayed. Each individual E-score of the E-Jury will appear on the main results form. At all other competitions, the D-score, E-score and the Final Score must be displayed.

Article 6.3 - Short exercise

For exercise presentation, the gymnast may earn a maximum E-Score of 10.00 points. The D-Jury will take the appropriate neutral deduction (ND) for a short exercise from the Final Score.

Number of elements	Neutral Deduction (ND)
8	0
7	0
6	0
5	3.0
4	4.0
3	5.0
2	6.0
1	7.0
0	10.0

Section 7 - Regulations Governing the D-score

Article 7.1 Difficulty Value (DV)

1. On Floor Exercise, Pommel Horse, Rings, Parallel Bars, and Horizontal Bar, the following difficulty values will count in all competitions:

Difficulty	A	B	C	D	E	F	G	H	I	J
Value	0.10	0.20	0.30	0.40	0.50	0.60	0.70	0.80	0.90	1.00

2. To the extent possible, only single elements are included in the Difficulty Tables. Each element is given a unique difficulty value and a unique Code Identification Number.
3. Elements that are not listed in the Difficulty Tables must be submitted for a difficulty rating to the Superior Jury President 24 hours in advance of podium training at official FIG Competitions. Provisional difficulty ratings may be given by Technical Authorities at other international, national, and local competitions.
4. An element (or element with the same Code Identification Number) may be repeated but such repeated element may not contribute towards the D-score. See additional regulations restricting repetition for Pommel Horse and Rings in Section 11 and 12.
5. Elements that no longer appear in the Code are considered elements without difficulty value.

Article 7.2 Element Group and Dismount Requirements

1. With this evaluation category, the judge evaluates those required movement patterns which, in addition to the gymnast's personal inclinations and technical abilities, are intended to enhance the variety of movement in the construction of an exercise.
2. Each apparatus, except for Floor Exercise has three Element Groups designated as I, II, III, and a Dismount Group designated as IV. Floor Exercise has four Element Groups.
3. In his exercise, the gymnast must include at least one element from each of the three Element Groups, and four for Floor Exercise.
4. An element may meet the Element Group requirement only for the Element Group under which it is located in the Difficulty Tables.
5. Each Element Group requirement fulfilled by D or higher element (inside the 7 (8 on Floor) counting elements) is awarded with 0.5 points by the D-Jury.
6. Each Element Group requirement fulfilled by A, B, C, is awarded with 0.3 points by the D-Jury (except EG I for All Apparatus where any element awarded with 0.5 points)
7. Every exercise must end with a dismount listed under the Dismount Element Group and land on the feet first. (see Section 10 and 13 for specific regulations for Floor Exercise and Vault).
8. Regarding Dismount element group requirements, the following rule will be applied:
 - Dismount element group value equals the Difficulty value of the dismount. (e.g. F dismount gets 0.6 for Difficulty Value and 0.6 as Element group value)
9. Stick landing after the dismount, min C (also Vaults with saltos) will be awarded with 0.1 bonus by the D-Jury, except the Pommel Horse

Article 7.3 Connection Points

1. This evaluation factor provides the D-Jury with the possibility of rewarding special connections. These connection points serve to differentiate the exercises which contain special connections between elements, as described on each apparatus.
2. Connection Points may be awarded only for directly connected recognized high value elements performed without a large error.

Article 7.4 Evaluation by the D-Jury

1. The D-Jury is responsible for evaluating the content of the exercise and determining the correct D-score on each apparatus as defined in Sections 10 to 15. Except in the circumstances defined in Article 7.4 the D-Jury is obligated to recognize and credit each element that is correctly performed.
2. The gymnast is expected to include in his exercise only elements that he can perform with complete safety and with a high degree of aesthetic and technical mastery. Very poorly performed elements will not be recognized by the D-Jury and will be deducted by the E-Jury.
3. Each element is defined to the perfect end position or as being performed with perfection.
4. An element that is not recognized by the D-Jury will receive no value.
5. An element will not be recognized by the D-Jury if it deviates significantly from the prescribed execution. An element will not be recognized or credited for reasons including, but not necessarily restricted to, the following:
 - a) If, on Floor Exercise, the element is performed beginning outside of the floor area (see Section 10 Art. 10.2.1.3a).
 - b) If, on Vault, the gymnast performs an invalid Vault as defined in Section 13.
 - c) If on Horizontal Bar, an element is performed with or from feet on the bar (see Section 15).
 - d) If a hold or strength element with straddled legs not listed in the difficulty tables is performed on any apparatus.
 - e) If the element is so altered in performance that it can no longer lay any claim to its identification number or value (see



also Appendix A.3.i), for example:

- i. A strength element performed almost entirely with swing or vice versa.
 - ii. A straight position element performed with a distinct tuck or pike or vice versa. In such cases an element is normally given the value of the element as performed.
 - iii. A strength element normally performed with legs together is performed with legs straddled.
 - iv. A strength hold element performed with significantly bent arms.
 - v. An element in or to handstand on Rings that is controlled with the legs or feet against the cables.
- f) If the element has been completed with the assistance of a spotter.
 - g) If the gymnast falls on or from the apparatus during an element, or alters, or interrupts it in some other manner.
 - h) If the gymnast falls on or from the apparatus during an element without having reached an end position that permits continuation with at least a swing.
 - i) If a strength hold element or a simple hold element is not held.
 - j) If a press or pull out comes from a strength hold element which has not been recognized or credited for any reason.
 - k) If a twisting element on most apparatus is performed with an over or under rotation of $> 90^\circ$ or if a swinging element is performed with a deviation from the perfect end position of $> 45^\circ$ (see also Appendix A.3.i). In some circumstances, an under rotation of $> 90^\circ$ may result in the recognition of a lower value for the vault/element by the D-Jury.
 - l) If, on Pommel Horse, elements in cross support or in side support deviate from the correct support orientation by 45° for the greater portion of the element.
 - m) If strength hold positions or simple hold positions on any apparatus deviate from the correct horizontal body, arm, or leg position by 45°
6. In all cases, the D-Jury is to make decisions based on gymnastics sense and to decide in the interests of the sport of gymnastics.
 7. Elements performed so poorly that they are not recognized by the D-Jury will normally be severely deducted by the E-Jury as well.
 8. The elements with the highest difficulty values will be counted first in cases of Special Repetition.

Article 7.5 Repetition

1. An exercise may not be repeated unless the gymnast has to interrupt his exercise for reasons outside of his control.
2. If the gymnast falls on or from the apparatus, he may choose to continue with his exercise from the fall or to repeat the missed element for credit and continue from there. (See Article 9.2.5).
3. No element (same Code Identification Number) may be repeated for difficulty credit or for Connection Points. This applies also to elements repeated in connections (exceptions: certain Pommel Horse elements and circles that increase in value if performed twice in special combinations, and Rings - see Section 11 and 12).
4. If the difficulty of an element is not recognized for any reason, then that element can also not meet an Element Group Requirement.

Article 7.6 D-Jury Evaluation

Gymnast's Actions	D-Jury evaluation
Errors leading to non-recognition (see Article 7.4 and 9.4)	Non-recognition of the Difficulty
Assistance by spotter in completion of element	Non-recognition of the Difficulty
Not holding	Non-recognition of the Difficulty
Repeated element	Permitted but given no value
Pushing with feet for dismount or other non-legitimate dismount	Non-recognition of the element and dismount element group requirement
Other prohibited elements	No recognition of the element



Section 8 - Regulations Governing E-score

Article 8.1 Description of Exercise Presentation

1. The Exercise Presentation consists of only those factors that constitute the essence of a contemporary gymnastics performance and the absence of which results in deductions by the E-Jury. These factors are:
 - a) The technical, compositional (general expectations for exercise construction) aesthetic and execution.
2. The Exercise Presentation has a maximum value of 10.0 points.

Article 8.2 Calculation of E-Jury deductions

1. The judges of the E-Jury, will judge an exercise and determine the deductions independently and do so within 20 seconds of the completion of the exercise.

Each performance is evaluated with reference to expectations of perfect performance. All deviations from this expectation are deducted.

- a) Deductions for errors in aesthetic and execution, technique and composition are summed to a maximum of 10.0 points for Exercise Presentation.

Article 8.3 Instructions for the Gymnast

1. The gymnast must include in his exercise only elements that he can perform with complete safety and with a high degree of aesthetic and technical mastery. The responsibility for his safety rests entirely with him. The E-Jury is required to deduct very rigorously for any aesthetic, execution, composition and technical errors.
2. The gymnast must never attempt to increase the difficulty or the D-score at the expense of aesthetic and technical execution.
3. All mounts must commence from the basic stand position, from a short run (only Parallel Bars and Horizontal Bar), or from a still hang. Pre-elements or intermediate elements may not precede the mount. This rule does not apply to Vault where the specific rules stated for that apparatus apply.
4. Dismounts from all apparatus, as well as the conclusion on Floor Exercise and Vault, must end in a standing position with the legs together. With the exception of Floor Exercise, pushing from the apparatus with the feet in order to execute the dismount is not permitted.

Section 9 - Technical Directives

Article 9.1 Evaluation by the E-Jury.

1. The E-Jury is responsible for evaluating all of the aesthetic, execution and technical performance aspects of an exercise as well as its compliance with the composition (exercise construction expectations) for that apparatus. In each case the E-Jury is to demand that elements be performed with perfection and to perfect end positions (see also Appendix A.2).
2. The E-Jury is not to concern at all with the difficulty of an exercise. The judge is obligated to deduct equally severely for any error of the same magnitude regardless of the difficulty of the element or the connection.
3. Judges of the E-Jury (and the D-Jury) must remain up-to-date with contemporary gymnastics, must know at all times what the most contemporary performance expectation for an element should be, and must know how standards are changing as the sport evolves. In this context they must also know what is possible, what is reasonable to expect, what is an exception, and what is a special effect (see also Appendix A.4).
4. The E-Jury must understand to refrain from deducting when some elements, which otherwise have no errors, are performed for a special effect or a special purpose. For example:

On Horizontal Bar, a giant swing is often modified in preparation for release elements and dismounts. These should not be deducted for not passing through a handstand unless they are unnecessary or so extreme as to violate aesthetic, execution and technical expectations.
5. If for any reason a judge of the E-Jury cannot reach a decision, the judge must give the benefit of the doubt to the gymnast.
6. The E-Jury is obligated to deduct twice for two distinctly different errors in an element, i.e. if the element has both a technical and an aesthetic execution error. For example a Stützkehre on Parallel Bars may receive both deductions for angular deviation and for bent knees.



Article 9.2 Determination of Execution and Technical Errors.

- Each element is defined to the perfect end position or as being performed with perfection. (Refer to *APPENDICES*).
- All deviations from correct performance are considered execution or technical errors and must be evaluated accordingly by the judges. The amount of the deduction for small, medium, or large errors is determined by the degree of deviation from the correct performance. The same deduction is applied each time for the same severity of bending, whether it be the arms, legs, or the body.
- The following deductions will apply for each and every discernible aesthetic or technical deviation from the expected perfect performance. These deductions must be taken regardless of the difficulty of the element or exercise.

Small Error	0.1
Medium Error	0.3
Large Error	0.5
Fall	1.0

a) Small errors: (deduction = 0.1)

- Any minor or slight deviation from the perfect end position and from perfect technical execution.
- Any minor adjustments to hand, foot, or body position.
- Any other minor violations against aesthetic and technical performance expectations.

b) Medium errors: (deduction = 0.3)

- Any distinct or significant deviation from the perfect end position and from perfect technical execution.
- Any distinct or significant adjustments to hand, foot, or body position.
- Any other distinct or significant violation against aesthetic and technical performance expectations.

c) Large errors: (deduction = 0.5)

- Any major or severe deviation from the perfect end position and from perfect technical execution.
- Any major or severe adjustments to hand, foot, or body position.
- Any full intermediate swing.
Any other major or severe violations against aesthetic and technical performance expectations.

Falls and spotter assistance: (deduction = 1.0 p.)

- Any fall on or from the apparatus during an element without having reached an end position that permits continuation with at least a swing (i.e. a distinct hang phase on Horizontal Bar or a distinct support phase on Pommel Horse after the element in question) or that otherwise fails to display a momentary control of the element during landing or re-grasp.
 - 1.0 is the maximum deduction for an element with a fall, and including all steps, touches, or support on the floor or mat leading up to the fall. Other execution deductions incurred for the element (height, landing extension, insufficient twist) still apply.
 - Any assistance by a spotter that contributes to the completion of an element.
- On all apparatus at the end of the exercise, if a gymnast does not perform a dismount, but lands intentionally on the feet, no deduction for a fall will be considered.
 - After a fall on or from the apparatus, the exercise may be continued within 30 seconds and the gymnast may use a necessary number of elements or movements to return to his starting position but all of these elements and movements must be performed with perfect execution. He is permitted to repeat the missed element for credit, except if the fall occurred during a dismount (except Pommel Horse) or a Vault.
 - Execution errors such as bent knees, bent arms, bad posture or body position, poor rhythm, poor amplitude, etc. are listed in Articles 9.2 and 9.3 and are always deducted according to the degree of error or deviation from what is considered perfect performance.
 - Execution errors such as bending the arms, legs or body are categorized as follows:

Small error	Medium error	Large error
Slight bending	Strong bending	Extreme bending

For better differentiation apply the following angular deviation principles:

Mistake	Angular deviation	Deduction
Slight bending	>0° - 45°	-0.10
Strong bending	>45° - 90°	-0.30
Extreme bending	>90°	-0.50 + NR

The only exceptions:

- Parallel Bars, bending of the legs before horizontal during the swing action of a Moy or any giant swing element AND after Bhavsar type of elements.
- Horizontal Bar, bending of the legs during swing action AND bending of the arms during the regrasp after flight elements



The Code of Points gives specific deductions for these exceptions.

8. During hold positions and strength presses, the arms (and where relevant the body) must be straight throughout the execution of the element. If the arms and/or body bend at any point the deduction is:

Mistake	Angular deviation	Deduction
Small	0° - 15°	-0.10
Medium	>15° - 30°	-0.30
Large	>30° - 45°	-0.50
Large	>45°	-0.50 + NR

9. For strength hold or simple hold positions on any apparatus, angular deviations from the perfect hold position define the magnitude of the technical error and the corresponding technical deduction:

Examples:

Small error	Medium error	Large error
>5°-20°	>20° - 45°	> 45° NR

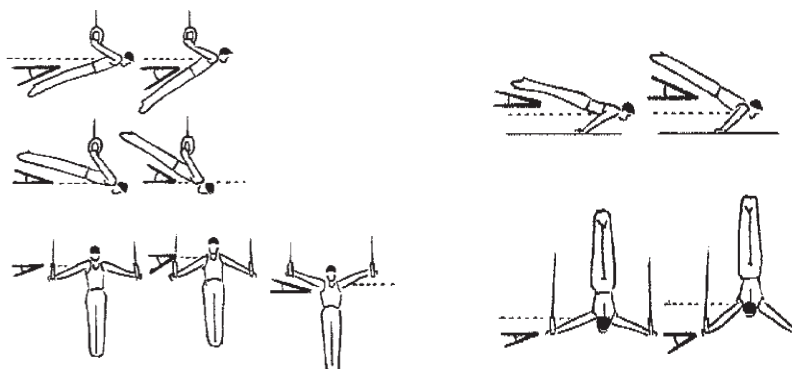

10. A press from a static strength element that did not have its difficulty recognized for any reason will also not have its difficulty recognized. The subsequent strength part may be recognised if technical requirements have been fulfilled.
11. If the preceding strength hold element has received a deduction for incorrect position, then the same deduction up to a maximum of 0.30 points applies again to a press from that strength hold element if it is determined that the press has been simplified thereby. This interpretation is intended only for circumstances where a high position or a technically poor hold makes the subsequent press easier (i.e. not for presses from faulty L sits, false grips, or for time of hold positions). This deduction only applies to a high angle deduction being applied to both elements connected by strength.
12. Technical deductions for angular deviation from the perfect end position can also apply to swinging skills. In most cases the perfect end position is defined as a perfect handstand, or during Pommel Horse circles, as a perfect cross support or perfect side support position. For swinging elements the following applies:
- On Floor Exercise, Pommel Horse, Rings, Parallel Bars and Horizontal Bar, swing elements are often expected to be performed through rather than to an exact handstand otherwise the rhythm of an exercise might be interrupted. For that reason a small angular deviation of up to 15° from an exact handstand is permitted up to the conclusion of the element. A small deduction is taken if the deviation from the handstand is from >15° to 30°.
 - On Pommel Horse, circles and most elements must be performed in, from, or to within 15° of a perfect cross or side support position. The appropriate angular deviation deduction is taken each time the error occurs during an exercise. This means that the E-Jury would deduct for each skewed circle, whereas the D-Jury would not recognize the element if it deviates from the correct support orientation more than 45° for the greater portion of the element.
13. During swing elements which pass through or end in handstand (see additional rule Art. 15.2 for Horizontal Bar), deviations from the correct position will be penalized as follows:
- up to 15° No deduction.
 - >15° to 30° Small error.
 - >30° to 45° Medium error.
 - > 45° Large error and non-recognition (D-Jury).

Note: Deviations in end positions for swinging elements of >45° (or for twisting elements, of >90°) will receive a large deduction from the E-Jury and will not be recognized by the D-Jury. However, in some cases, it may be possible for an element with incomplete twist to be recognized as a lower value element in accordance with the amount of twist correctly completed.

14. On Rings, during swings to a hold position or strength presses, the shoulders and/or body may not rise above the perfect hold position. If the shoulders and/or body rise above the perfect hold position, the deduction is:

>5° - 20°	Small error.
>20° to 45°	Medium error.
>45°	Large error and non-recognition (D-Jury)

15. All hold elements must be held for a minimum of 2 seconds measured from the moment that a complete stop position has been reached. Elements that are not held will receive large deduction and will not be recognized by the D-Jury.

2 seconds	no deduction.
Less 2 seconds	medium error.
No stop	large error and non-recognition.

16. Deductions for poor landings are listed in Article 9.4. A correct landing is a prepared landing, not one which happens by luck to end in a standing position. An element should be performed with such excellent technique that the gymnast has fully completed it and has had time to reduce rotation and/or extend the body prior to landing.

17. Landings & Dismounts on the Feet without Deduction.

For safety reasons a gymnast may land or dismount with their feet apart (enough to properly join their heels together) upon landing from any salto. This distance can also be defined as 10cm. If the feet are more than 10cm apart there will be a 0.1 or 0.3 deduction taken, even if the heels are brought together after the initial. The gymnast must complete the landing by bringing his heels together without lifting and moving the front of his feet. This is done by raising the heels off the mat and joining them together without lifting the front of the feet. The arms must also be in complete control with no unnecessary swings.

Action (Without steps, hops, or arm swings)	Result
Landing with feet slightly apart and gymnast lifts heels and joins both heels together without lifting and moving the front of his feet	No deduction
Landing with feet slightly apart or less than shoulder width apart and gymnast picks up a foot moving both feet together, OR does not join both feet together by lifting only the heels	-0.10 deduction for landing with feet apart
Landing with feet more than shoulder width apart, AND gymnast picks up one foot moving both feet together, OR does not join both feet together	-0.30 deduction for landing with feet apart

Note:

- All other execution deductions (those while in the flight phase of a salto or for lack of extension before landing) must always be considered in addition to the landing requirements noted above.

18. During landings a small step is defined as a maximum of 'one foot' distance between the feet or distance of the hop. Any greater distance than this would be a large step or hop and attract a medium deduction.

19. A low landing is defined as the hips below the knees, which should be deducted 0.5 for technical error.

20. Additional technical deductions are listed in Article 9.4 and specifically for each apparatus in the appropriate Chapter.

Article 9.3 Expectations for Exercise Construction

1. The expectations for exercise construction are those aspects of an exercise that define the essence of our expectations and understanding of a gymnastics performance on each apparatus; such things as using the full floor area; swinging without stops; no repetition; etc. These are specifically defined for each apparatus in the appropriate chapter.

2. Exercise construction errors include, but are not restricted to, the following:

- a) Large separation of legs (medium error = **-0.30** p. E-Jury):
 - i. The gymnast may not perform elements with a separation of legs that serves no useful purpose or that detracts from the aesthetics of a performance. For example, on Parallel Bars a Stützkehre or a pirouette may not be performed with legs apart; on Horizontal Bar and Rings, elements may not be performed with a back-forward separation of the legs; on Rings, crosses, swallows, and handstands may not be performed with a separation of the legs; etc. Most elements permitted or required to be performed with separated legs are listed in the Difficulty Tables.
- b) Repetition of elements
 - i. Repeating of elements is permitted, but they cannot receive credit for difficulty or connection points. However, they are evaluated normally by the E-Jury.
- c) Layaways, empty and intermediate swings (medium or large error = **-0.30** or **-0.50** by the E-Jury):



- i. An empty swing is a swing at the end of which no element is performed or no new support or hang position or grip is achieved (medium error by the E-Jury).
 - ii. An intermediate swing is two successive empty swings (large error by the E-Jury).
 - iii. Layaways are back swings in support or in upper arm support that simply reverse direction and swing back down in or to a lower hang or support position (also if accompanied by a grip change) (medium error by the E-Jury).
- d) Lowering of Legs during any element to handstand or hold parts. The table below shows the deductions to be taken for lowering of the legs:

Action		Angle Deviation from original position
E-Jury	D-Jury	
- 0.1	-	0°-15°
- 0.3	-	>15°-30°
- 0.5	-	>30°-45°
- 0.5	- non-recognition	>45° NR

Article 9.4 E-Jury deductions

These deductions are to be applied on all apparatus and Floor Exercise by the E-Jury when the corresponding error is made. See Sections 10 to 15 for additional errors and deductions specific to each apparatus.







Error	Small 0.10	Medium 0.30	Large 0.50
Deductions for aesthetic and execution errors			
Non-distinct positions (tuck, pike, straight).	●	●	
Adjust or correct hand or grip position each time.	●		
Walking in handstand or hopping (each step or hop).	●		
Touching apparatus or floor with legs or feet.	●		
Hitting apparatus or floor.			●
Gymnast touched but not assisted by spotter during an exercise.		●	
Interruption of exercise without fall.			●
Bent arms, bent legs or legs apart.	●	●	●
Poor posture or body position or postural corrections in end positions.	●	●	
Saltos with knees or legs apart.	≤ shoulder width	> shoulder width	
Legs apart on landing.	≤ shoulder width	> shoulder width	
Unsteadiness, minor adjustment of feet, or excessive arm swings on landing.	●		
Loss of balance during any landing with no fall or hand support. (Maximum -1.0 total for steps and hops).	Slight imbalance, small step or small hop, 0.1 per step	Large step or large hop or touching the mat with 1 or 2 hands	
Fall or support with 1 or 2 hands during any landing.			-1.00
Fall during any landing without feet contacting mat first.			-1.00 and non-recognition by the D-Jury
Atypical straddle.		●	
Other aesthetic errors.	●	●	●



Error	Small 0.10	Medium 0.30	Large 0.50
Deductions for Technical errors			
Deviations in swings to or through handstand or in circle elements.	>15° - 30°	>30° - 45°	>45° and NR
Angular deviations from perfect hold positions.	>5° - 20°	>20° - 45°	>45° and NR
Press from poorly held positions.	deductions equivalent to those for the hold position are repeated (max. -0.30)		
Incomplete twists.	up to 30°	>30° - 60°	>60° - 90° >90° and NR
Lack of height or amplitude on salto and flight elements.	●	●	
Additional or intermediate hand support.	●		
Strength with swing and vice versa. (SEE RINGS)	●	●	●
Duration of hold parts (2 sec.).		less 2 sec.	no stop and NR
Interruption in upward movement.	●	●	
Lowering of legs on any element to handstand or hold parts.	0 - 15°	>15°-30°	>30° - 45° >45° NR.
Unsteadiness in or fall from handstand.	●	swing or big disturbance	
Fall from or onto apparatus.			-1.00
Intermediate swing or layaway.		half or layaway	full
Assistance by spotter in the completion of an element.			-1.00 and NR
Lack of extension in preparation for landing.	●	●	
Other technical errors.	●	●	●





- Floor Exercise	
- Pommel Horse	
- Rings	
- Vault	
- Parallel Bars	
- Horizontal Bar	

Section 10

Floor Exercise

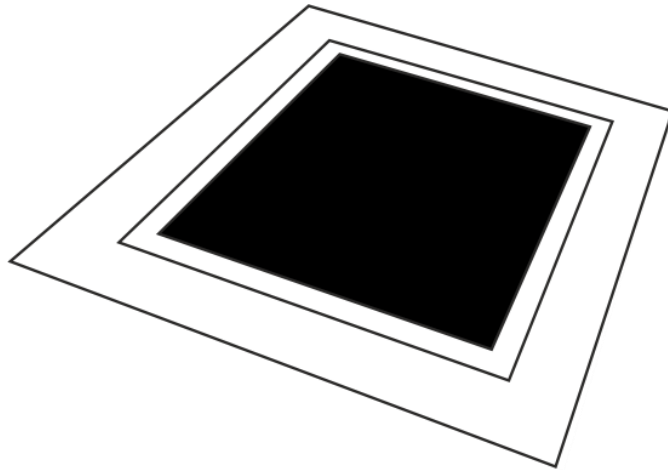

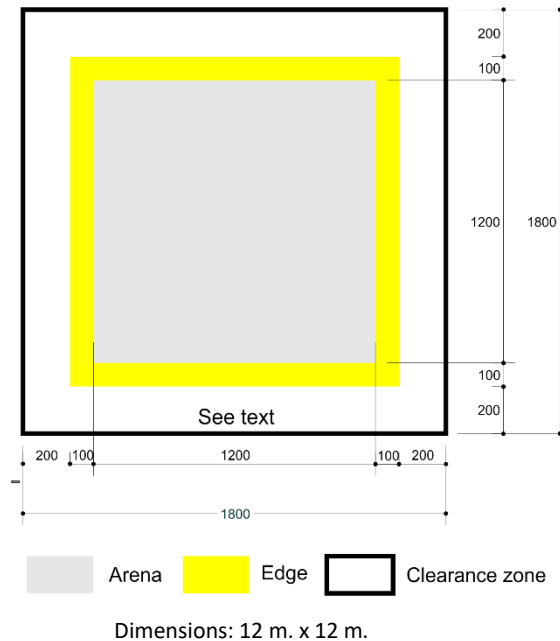

Article 10.1 Exercise description

A Floor Exercise is composed predominantly of acrobatic elements combined with other gymnastic elements such as strength, balance, flexibility, handstands, and choreographic combinations, all forming a harmonious rhythmic exercise, performed utilizing the majority of the floor exercise area (12 m x 12 m).

Article 10.2 Content and Construction

Article 10.2.1 Information about Exercise Presentation

1. The gymnast must begin his exercise within the floor area, from a still stand legs together. The exercise and evaluation begins with the first movement of the feet of the gymnast.
2. Additional execution and exercise construction expectations are :
 - a) The exercise must occur entirely within the floor area. Elements initiated outside of the floor area will be evaluated in the normal fashion by the E-Jury, but will not be recognized by the D-Jury.
 - i. The space available for Floor Exercise is delineated by boundary lines or color separations. Lines are considered to be a part of the floor area. The gymnast may step onto the line, but not over the line or on the outside color.
 - ii. Going outside of the marked floor area will be controlled by 2 line judges who sit diagonally opposite each other near the FX area unless otherwise indicated in the competition directives. Each Line Judge observes the 2 boundary lines nearest him if seated on the field of play. When line violations occur, the Line Judge must advise the D1 judge of the deduction, using the following criteria:
 - Landing or touching with one foot or one hand outside the floor area = **-0.10**.
 - Touching with feet, hands, foot and hand, or with any other part of the body, outside of the floor area = **-0.30**.
 - Landing directly outside the floor area = **-0.30**.
 - Elements initiated outside the floor area have no value. The D1 judge will ensure the appropriate deduction is taken from the Final score.
 - iii. If the gymnast has stepped outside of the floor area, any steps required to return back into the floor area are not deducted.
 - b) The duration of the Floor Exercise is a maximum of 70 seconds, which will be verified by a Time Judge. There is no minimum time. The Time Judge will give an audible warning signal at 60 seconds and again at 70 seconds to indicate the maximum time limit has been reached. The time is measured from the first movement of the feet of the gymnast through to the dismount, which must end in a still standing position, with legs together. If the exercise exceeds the maximum allowable time, the Time Judge must notify the D1 judge, who ensure the corresponding deduction is taken from the Final Score.

- c) The full floor area must be used. There is no limit to the total number of times a diagonal may be used for acrobatic elements. However, the same diagonal may not be used more than 2 times in a row. If a gymnast does use the same diagonal 2 times in a row they must then use a side-line to an unused corner of the Floor.
- Side line is < 12 m. (Direction A-B, B-C, C-D, D-A)
 - Diagonal is any other acrobatic line
- In addition, the gymnast must go to and or from, each corner of the floor. If the final tumbling pass takes the gymnasts towards an unused corner, this will fulfil the requirement for that corner having been utilized. Failure to go to and/or from each corner, as defined, will result in a 0.3 neutral deduction taken by the D1 judge once during an exercise. Using the same diagonal 3 times in a row, in violation of the requirement stated above, will result in a 0.3 neutral deduction taken by the D1 judge once during an exercise.
- d) Pauses of two seconds or longer before acrobatic series or elements are not permitted. Simple movements of the arms are included in the definition of a pause and therefore the two seconds begins the moment the gymnast comes to a stand.
- e) Each acrobatic element or series must end in a visibly controlled landing and stop before continuing to any other type of element. Uncontrolled momentary landings during such transitions are not permitted.
- f) The exercise must end with an acrobatic element that lands with both feet together.
- g) A gymnast must not use simple steps to arrive in the corner. Simple steps occur when a gymnast repositions himself on the floor area without any choreography (turning ≥ 180 degree, jumping, lifting leg above horizontal during step, etc.).
- h) The deduction for aesthetic and execution errors in the saltos is per element not for every salto included in the element.
3. For a full list of errors and deductions governing Exercise Presentation, see Section 9 and the summary of deductions in Articles 9.4 and 10.3.

Article 10.2.2 Information about the D-score

1. The Element Groups (EG) are :

- I. Non-acrobatic elements.
- II. Acrobatic elements forward.
- III. Acrobatic elements backward
- IV. Single salto forward and/or backward with 1 or more turns.

2. The dismount cannot be from Element Group I.

3. A multiple salto element is required in the exercise (as the dismount for Seniors) and must be inside the 8 counting elements.

4. Information about Difficulty and elements group :

- a) Acrobatic elements can be connected, but retain their independent values.
- b) All Arabian elements are in the group of acrobatic elements backward, Example Arabian double front $\frac{1}{2}$ = same as double back $\frac{1}{1}$ (D value).

5. Information about connections (CV).

- D or higher + B or C = +0.1, D or higher + D or higher = +0.2.
- Connections can be awarded on both sides of one element.
- For connection bonus, all elements must be inside the 8 counting elements.
- No connection will be given for counter saltos (example Double salto bwd. $\frac{1}{1}$ to salto fwd. $\frac{1}{1}$).
- No connection bonus will be given for directly connected single saltos with turns (example: salto bwd. with $\frac{5}{2}$ turns to salto fwd. $\frac{1}{1}$ turn)
- If a gymnast completes two or more elements for connection bonus, and receives a large deduction for any reason, then no connection bonus will be awarded for that particular connection.

6. Additional information and regulations:

- a) One and a half salto elements with reception by, and then spring from the hands, are not permitted.
- b) Salto rollouts and jumps to prone position are not permitted for value.
- c) All permitted elements that finish with a rollout or finish in front support position are listed in the Difficulty Tables. For safety reasons, no new such elements are permitted.
- d) Unless otherwise indicated in the Difficulty Tables, circle and flair elements have the same value and identification number. Wende swings with legs apart are not permitted.
- e) Unlisted strength holds with straddled legs are not permitted.
- f) Elements involving two strength parts for one Code value require a stop position in both strength parts to receive the listed value, a lower value will be awarded if a stop occurs for only one of the strength parts. Example: Manna (1 s.) and press handstand (no stop) = C value for the Manna.
- g) All circles/flairs begin and end in front support.
- h) No extra elements may be added before or after element I.82 for an increase in value.



In principle only acrobatic elements can be awarded more than a D value.

- i) All Japanese handstands require closing of the legs and requires the head to be within one hand thickness of the floor.
- j) If a gymnast steps or lowers his legs and touches the floor while pressing to handstand, no value will be given for the press. However, they may still receive credit for the handstand if held for the minimum time required.
- k) Clarification concerning several acrobatic skills cannot be devalued if performed partly in a tuck position, for example salto forward straight with double turn, gymnasts can receive credit for the double turn if the bending occurs in the second turn but would be deducted for the Non-distinct positions (tuck, pike, straight). Article 9.4.
- l) Roundoff with 1/4 turn to land facing forward (Tinsica) is not permitted. Otherwise the next element will not be recognized.
- m) The gymnasts must show a balance element on one leg, from elements listed in the Code of Points, element 1.61 or 62. May be performed outside of the counting 8 elements.

7. Special repetitions:

- a) A maximum of 1 strength elements (including strength handstands) may be performed in an exercise for content value. Elements I.1 to I.48 are considered to be strength elements, except:
 - Element I.19 - Handstand (2 sec).
 - Element I.31 - ½ or 1/1 turn in handstand or to handstand.
- b) A maximum of 1 circle, flair or Russian elements may be performed in an exercise for difficulty value.

8. For a further list of regulations governing non-recognition of elements, and other aspects of the D-score, see Section 7 and the summary of deductions in Article 7.6.

Article 10.3 Specific Deductions for Floor Exercise.







D-Jury

Error	Small 0.10	Medium 0.30	Large 0.50
Exercise longer than 70 sec.	≤ 2 sec.	>2 - 5 sec.	> 5 sec.
Landing or touching with one foot or one hand outside the floor area.	●		
Touching with feet, hands, foot and hand or with any other part of the body outside of the floor area.		●	
Landing directly outside the floor area.		●	
No pass to and/or from each corner.		●	
Using same diagonal more than 2 times in a row.		● (once in the exercise)	
No multiple salto element (Dismount for seniors)		●	
No balance on one leg		●	
Elements initiated outside the floor area.	No value		

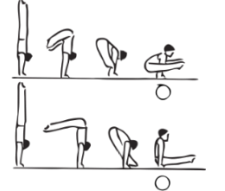

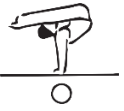
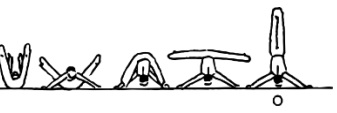
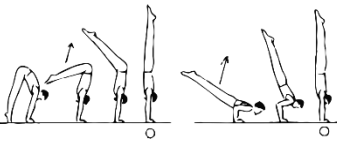
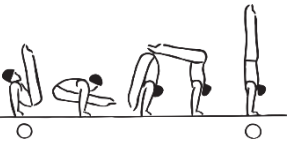
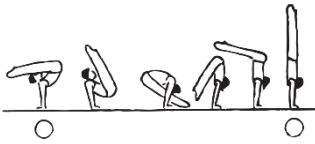

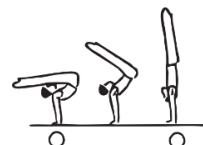

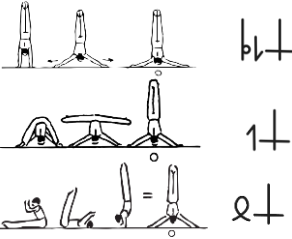
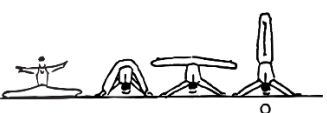



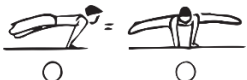

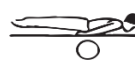

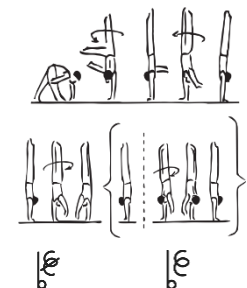

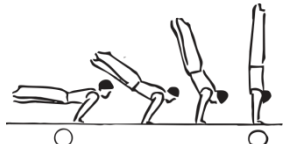
E-Jury

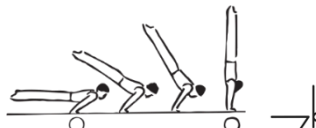
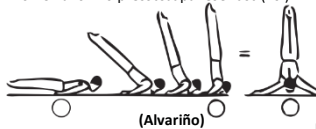
Error	Small 0.10	Medium 0.30	Large 0.50
Insufficient height in acrobatic elements.	●	●	
Lack of flexibility during static elements.	●	●	
Roll-out elements without hand support.		On back of hands	Without support
Pause 2 sec. or more before element or acrobatic series.	●		
Uncontrolled momentary landings (also in transitions).	●	●	●
Simple steps or transitions to arrive to the corners.	●		
Jump to prone landing after salto			●
Deviation from plane of movement.	●	●	











A = 0,1	B = 0,2	C = 0,3	D = 0,4	E = 0,5	F = 0,6 G = 0,7 H = 0,8
EG I: Non-acrobatic Elements					
<p>1. From hdst. lower to L-sit or strad. L-sit (2 s.).</p>  <p>b > b L</p>	<p>2. V-sit (2 s.).</p>  <p>N</p>	<p>3. V-sit with legs horizontal. (2 s.). (Manna)</p>  <p>T</p>	<p>4.</p>	<p>5.</p>	<p>6.</p>
<p>7. From stand, Swiss press to hdst. (2 s.).</p>  <p>> b</p>	<p>8. Piked body, str. arm or str. body, bent arm press to hdst. with legs together (2 s.).</p>  <p>Γ b ^ b</p>	<p>9. V-sit (2 s) and press to hdst. (2 s.). Also final phase with straddle.</p>  <p>N b</p>	<p>10. Manna (2 s.) and press to hdst. (2 s.). Also final phase with straddle.</p>  <p>T b</p>	<p>11.</p>	<p>12.</p>
<p>13. Rock to hdst. from prone position (2 s.).</p>  <p>∠ b</p>	<p>14. Press from split, L-sit strad. or front sup. (2 s.).</p>  <p>⊥ b > b ∠ b</p>	<p>15.</p>	<p>16. From Manna (2 s.), turn over (dislocation) to handstand (2 s.).</p>  <p>T ↑ b</p>	<p>17.</p>	<p>18.</p>
<p>19. Handstand (2 s.).</p>  <p>b</p>	<p>20. Press or lower or swing to Japanese hdst. (2 s.).</p>  <p>b ⊥ ⊥ ⊥ ⊔ ⊥</p>	<p>21. From split press to Japanese handstand (2 s.).</p>  <p>⊥ ⊥</p>	<p>22.</p>	<p>23.</p>	<p>24.</p>

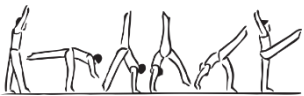

A = 0,1	B = 0,2	C = 0,3	D = 0,4	E = 0,5	F = 0,6 G = 0,7 H = 0,8
EG I: Non-acrobatic Elements EG I: Non-acrobatic Elements					
25. Support lever, legs straddle (2 s.).  	26.	27. Support lever (2 s.). / Swallow (2 s.).    	28.	29.	30.
31. ½ or 1/1 turn in handstand or to handstand.  	32. From straddled support lever (2 s.) press hdst. (2 s.)  	33.	34. From support scale 2 s. press handstand (2 s.).  From Swallow 2s. press to Japanese hdst. (2s.).  (Alvaríño) 	35.	36.
37. From L-sit, etc., turn over bwd. to stand.  	38.	39.	40.	41.	42.
43.	44. Endo roll to handstand (2 s.).  * 	45. Endo roll piked to handstand (2 s.). Also final phase with straddle.  * 	46.	47.	48.

* Does not need to come from handstand to be recognised

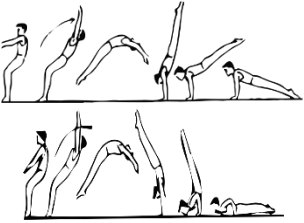

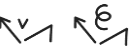
A = 0,1	B = 0,2	C = 0,3	D = 0,4	E = 0,5	F = 0,6 G = 0,7 H = 0,8
EG I: Non-acrobatic Elements					
49. Forward walkover.  	50.	51.	52.	53.	54.
55. Cross or side split (stop required).  	56.	57.	58.	59.	60.
61. Any standing scale (2 s.).   	62. Any standing scale with 180° straddle, no hand hold (2 s.).  	63.	64.	65.	66.
67. Jump bwd. to front support.  	68. ump bwd. with pike-stretch or with 1/1 turn to front support (Endo)  	69.	70.	71.	72.





A = 0,1	B = 0,2	C = 0,3	D = 0,4	E = 0,5	F = 0,6 G = 0,7 H = 0,8
EG I: Non-acrobatic Elements					
<p>73. Butterfly.</p>  <p style="text-align: center;">B</p>	<p>74. Butterfly with 1/1 twist fwd. or bwd. (Tong Fei)</p>  <p style="text-align: center;">Bϕ</p>	<p>75. Butterfly with 2/1 twist.</p>  <p style="text-align: center;">Bϕ</p>	<p>76.</p>	<p>77.</p>	<p>78.</p>
<p>79. 1 circle or flair.</p>  <p style="text-align: center;">ff</p>	<p>80. Circles or flair to handstand.</p>  <p style="text-align: center;">fb</p>	<p>81. Flair or circle to hdst. continue to flair or circle. (Gogoladze)</p>  <p style="text-align: center;">fbf</p>	<p>82. Flair hopping with 360° t. bwd. thr. hdst and back to flair (2 hops).</p>  <p style="text-align: center;">f\uparrowbf</p>	<p>83.</p>	<p>84.</p>
<p>85.</p>	<p>86. Lower from hdst. to flair or circle.</p>  <p style="text-align: center;">bf</p>	<p>87.</p>	<p>88.</p>	<p>89.</p>	<p>90.</p>
<p>91. Flair with 1/2 spindle.</p>  <p style="text-align: center;">fϕ</p>	<p>92. Flair with 1/1 spindle (in 2 circles).</p>  <p style="text-align: center;">fϕ</p>	<p>93. Flair with >270 spindle (in 2 circles) directly to handstand.</p>  <p style="text-align: center;">fϕb</p>	<p>94.</p>	<p>95.</p>	<p>96.</p>



A = 0,1	B = 0,2	C = 0,3	D = 0,4	E = 0,5	F = 0,6 G = 0,7 H = 0,8
EG I: Non-acrobatic Elements					
97.	98. Flair with ½ spindle to handstand.  fφb	99.	100. Flair with > 270° spindle (in 2 circles) directly to handstand and continue to circle or flair.  fφbf	101.	102.
103. Russian wendeswing with 360° or 540°.  r	104. Russian wendeswing with 720° or 900°.  rr	105. Russian wendeswing with 1080° or more. (Fedorchenko)  rrr	106.	107.	108.
109. Roll bwd. through hdst. with ½ t.  qb	110.  qbε	111.	112.	113.	114.
115.	116.	117.	118.	119.	120.

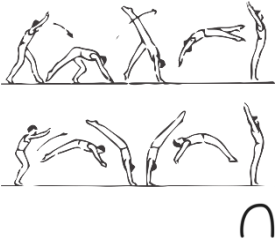
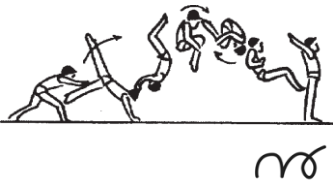
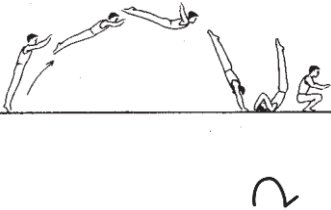

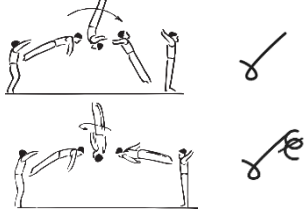
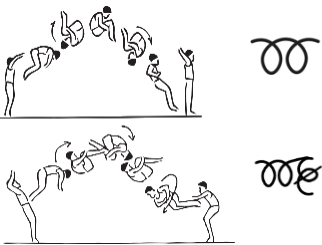
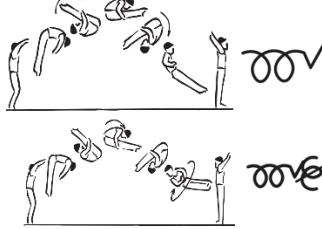







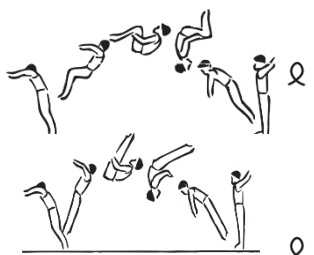
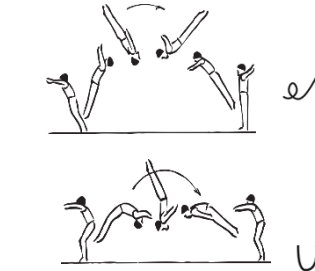

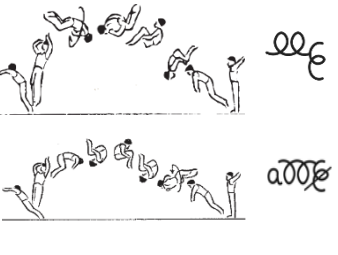
A = 0,1	B = 0,2	C = 0,3	D = 0,4	E = 0,5	F = 0,6 G = 0,7 H = 0,8
EG II: Acrobatic elements forward					
<p>1. Forward handspring or flierspring.</p> 	2.	3.	<p>4. Handspring salto fwd. tuck. (Morandi)</p> 	5.	6.
<p>7. Dive roll.</p> 	8.	9.	10.	11.	12.
<p>13. Salto fwd. tucked or piked, also with 1/2 t.</p> 	<p>14. Salto fwd. stretched, also with 1/2 t.</p> 	15.	<p>16. Double salto fwd. tucked, also with 1/2 t.</p> 	<p>17. Double salto fwd. piked, also with 1/2 t.</p> 	18.
19.	20.	21.	22.	23.	24.

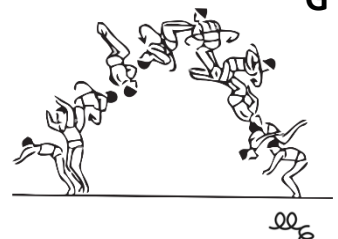
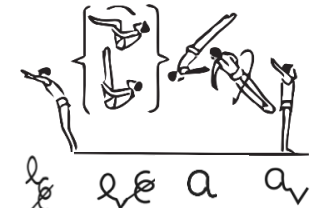
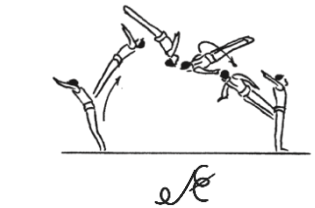
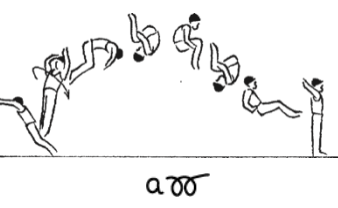

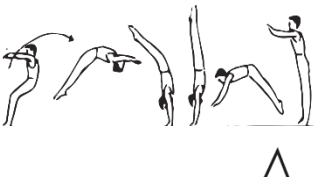
A = 0,1	B = 0,2	C = 0,3	D = 0,4	E = 0,5	F = 0,6 G = 0,7 H = 0,8
EG II: Acrobatic elements forward					
25.	26.	27.	28.	29.	30.
31.	32.	33.	34.	35.	36.
37.	38. Salto fwd. t. or p. to front support. 	39.	40.	41. Double salto fwd. tucked with 1/1 turn. 	42. Double salto fwd. tucked with 3/2 turn. (Zapata) 
43.	44.	45.	46. Jump fwd. with 1/2 t. to dbl. salto bwd. Tuck (Deferr) 	47.	48. Double salto fwd. stretched with 3/2 turn. (Zapata 2) 

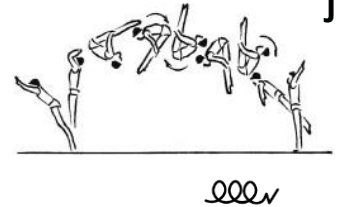

A = 0,1	B = 0,2	C = 0,3	D = 0,4	E = 0,5	F = 0,6 G = 0,7 H = 0,8 I = 0,9 J = 1.0
EG III: Acrobatic elements backward					
<p>1. Salto backwards tucked or piked.</p> 	<p>2. Salto backwards str. or Tempo salto bwd.</p> 	<p>3. Double salto bwd. tucked.</p> 	<p>4. Double salto bwd. t. with 1/1 t. Also Arabian double salto tuck with 1/2 t. (Tsukahara)</p> 	<p>5. Double salto bwd. tucked with 2/1 t. or double salto bwd t. with 3/2 t. or salto bwd. str. 3/2 to fwd. salto tucked.</p>  <p>Also (Korosteljev)</p>	<p>6. Double salto bwd. tucked with 3/1 t. (Ri Jong Song)</p> 
<p>7. Salto backwards tucked or piked w. 1/2 t. or Arabian tucked or piked.</p> 	<p>8. Salto backwards str. w. 1/2 t.</p> 	<p>9.</p>	<p>10. Arabian jump bwd. to double salto fwd tucked</p> 	<p>11. Arabian jump bwd. to double salto fwd piked, also with 1/2 turn</p> 	<p>12. Double salto bwd. tucked with 5/2 t.</p> 
<p>13. Back handspring.</p> 	<p>14.</p>	<p>15.</p> 	<p>16. Double salto bwd. piked.</p> 	<p>17.</p>	<p>18. Triple salto bwd. tucked. (Liukin)</p> 
<p>19.</p>	<p>20.</p>	<p>21.</p>	<p>22.</p>	<p>23.</p>	<p>24. Triple salto bwd. piked. (Nagornyy)</p> 



A = 0,1	B = 0,2	C = 0,3	D = 0,4	E = 0,5	F = 0,6 G = 0,7 H = 0,8
EG III: Acrobatic elements backward					
25.	26.	27.	28.	29.	30.
31. Jump bwd. with ½ t. to roll fwd.  an	32.	33.	34.	35. Double salto straddled with 1/1 t. (Lou Yun)  Ly	36. Arabian Jump bwd. to dbl. salto fwd. str. (Tamayo)  aoo
37.	38.	39.	40.	41. Salto bwd. str. with 1/1 t and salto bwd piked.  ee	42. Salto bwd. str. with 2/1 t and salto bwd piked. (Kolyvanov)  ee
43.	44.	45.	46.	47. Double salto bwd. stretched and with ½ t.   ee	48. Double salto bwd. str. with 3/2 t. or Arabian Jump bwd. to dbl. salto fwd. str. with 1/1 t.  Also Hypolito  aoo



A = 0,1	B = 0,2	C = 0,3	D = 0,4	E = 0,5	F = 0,6 G = 0,7 H = 0,8
EG III: Acrobatic elements backward					
49.	50.	51.	52.	53.	54. Double salto bwd. stretched with 1/1 t. or Arabian jump bwd. to dbl. salto fwd. str. with 1/2 t.  Also Penev 
55.	56.	57.	58.	59.	60. Double salto bwd. str. with 2/1 t.  G 
61.	62.	63.	64.	65.	66. Double salto bwd. str. with 5/2 t.  H 
67.	68.	69.	70.	71.	72. Double salto bwd. str. with 3/1 t. (Shirai 3)  I 

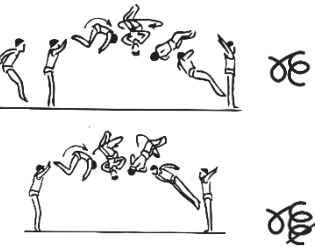
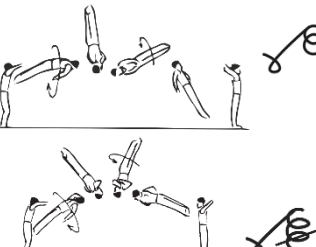
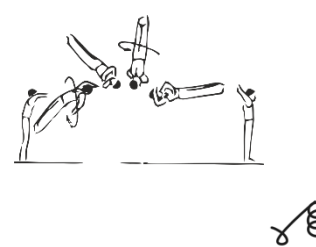
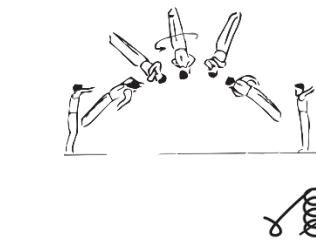
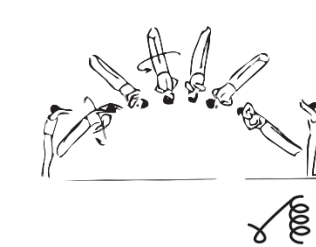
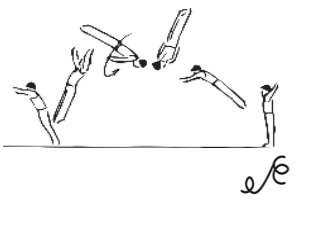
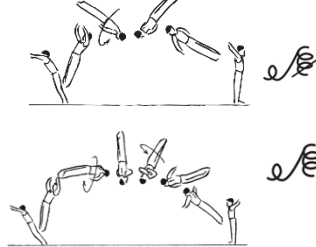
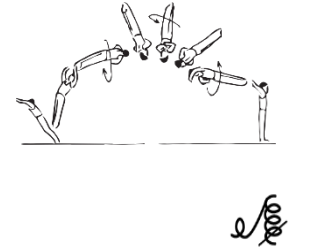
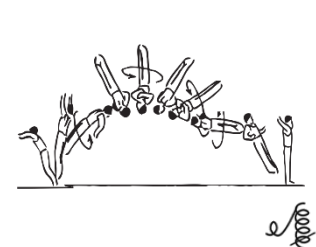
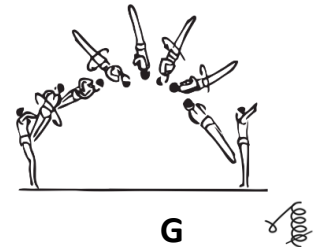
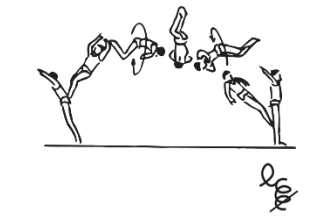
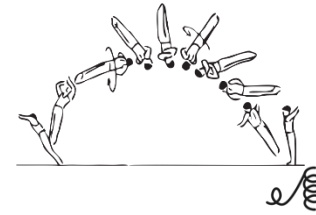
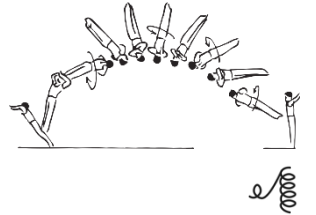

A = 0,1	B = 0,2	C = 0,3	D = 0,4	E = 0,5	F = 0,6 G = 0,7 H = 0,8
EG IV: Single salto forward and backward with 1 or more turns.					
1.	2. Salto fwd. tucked with 1/1 t., also with 3/2 t. 	3. Salto fwd. str. with 1/1 t., also with 3/2 t. 	4. Salto fwd. str. with 2/1 t. 	5. Salto fwd. str. with 5/2 t. 	6. Salto fwd. str. with 3/1 t. (Shirai 2) 
7.	8. Salto backwards str. w. 1/1 t. 	9. Salto bwd. str. with 3/2 t. or 2/1 t. 	10. Salto bwd. str. with 5/2 t. 	11. Salto bwd. str. with 7/2 t. (González) 	36. Salto fwd. str. with 7/2 t. (Goshima) 
13.	14. Salto backwards tucked w. 3/2 t. 	15.	16.	17.	18.
19.	20.	21.	22. Salto bwd. str. with 3/1 t. 	23.	24. Salto bwd. str. with 4/1 t. (Shirai / Nguyen) 



Section 11

Pommels Horse

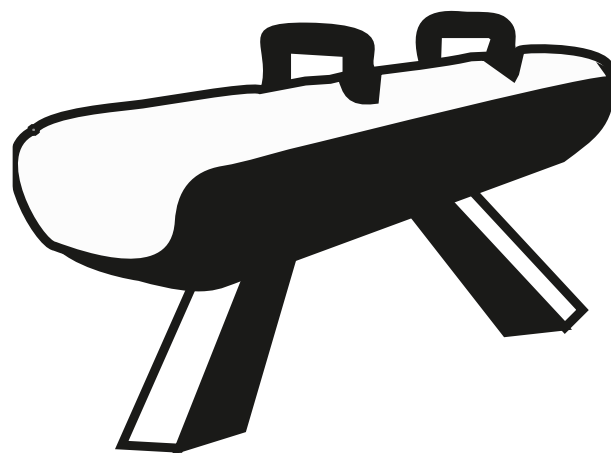

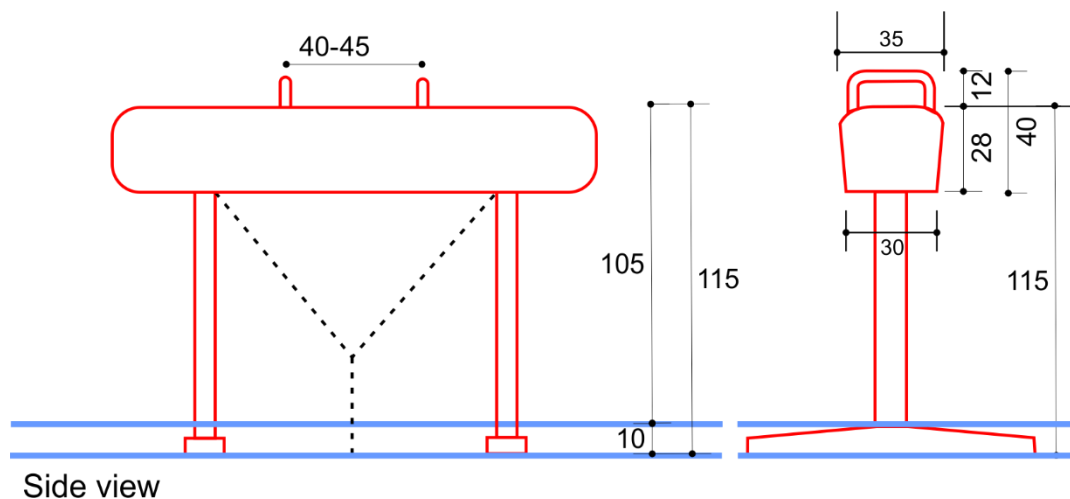

Height: 105 cm from top of mat, 115 cm from the floor.

Article 11.1: Exercise description

A contemporary Pommel Horse exercise is characterized by a variety of support positions on all parts of the horse, permitting different types of circular swings with legs apart and together, single leg swings and/or scissors, and swings through the handstand position with or without turns. All elements must be executed with swing and without the slightest interruption of the exercise. Strength and hold elements are not permitted.

Article 11.2: Content and Construction

Article 11.2.1 Information about Exercise Presentation

1. The gymnast must start his exercise from a standing position. An approach step or hop is permitted. The evaluation begins the moment the gymnast's feet leave the floor.
2. Additional execution, technical and exercise construction expectations are:
 - a) The exercise must consist exclusively of swings without visible pauses or visible use of strength.
 - b) Oblique positions during flair and circle work are not permitted. Circles and flairs may be performed only in cross support or in side support positions. Furthermore, all turning elements must begin and end in either cross support or side support.
 - c) Ideally circles and flairs must be performed with complete extension. Lack of amplitude in body position is deducted as an individual deduction on for each element. Hip breaks during individual elements in an exercise should be deducted as separate technical errors on each circle or flair.
 - d) Wendeswings must be performed with legs together. Legs apart during Wendeswings are considered as an execution error (Art 9.4.) and must be deducted for each full turn.
 - e) During scissors and single leg swings, the gymnast must demonstrate a significant elevation and a large separation of the legs.

This table describe deductions applicable before, during and after elements with single legs swings and/or scissors

Amplitude	Deduction
Above shoulder line	0.0
Between shoulder and horizontal line.	-0.10
Lower horizontal line.	-0.30



- f) Handstand elements must be achieved with completely straight arms and without any interruption of swing or obvious use of strength.
- g) In flair or circle to handstand dismounts and elements returning to flairs or circles, execution deductions for hesitation, strength, bent arms, lowering of the hips, and unsteadiness must be considered on the rise to the handstand, within the pirouette, the lower from the handstand, and the extension of the flairs or circles upon completion of the element. There is no deduction for bending of the hips on the rise to handstand.
- h) A simple handstand dismount, or one that includes a turn of at least 270° from the side support, must cross the body of the horse, should land in cross stand facing along the long axis of the horse and adjacent to the last hand support position. If these requirements are not met the dismount will be considered as atypical and be deducted **-0.30** for turning problems. (Art 9.4.)
- i) Expectations for scissor to handstand elements:
 - The gymnast is expected to swing to handstand without strength or hesitation, with hips straight throughout.
 - A scissor to handstand with pronounced hip bend and strength should receive one deduction from the E-Jury.



- Scissors to handstands demonstrating lowering of the hips or legs will be deducted by the E-Jury.
 - All scissors to handstand require the legs to close.
 - j) Clarifications concerning evaluation for all Scissor to handstand performed with hand(s) stepping errors:
 - Step down off pommel with one hand with return to the single pommel = credit by D-Jury and **-0.30** + other execution errors (E-Jury) for uncontrolled handstand support.
 - Step down off pommel with one hand with no return to the single pommel = credit by D-Jury and -0.5 + other execution errors (E-Jury) for uncontrolled handstand support.
 - Step down off pommel with two hands = no value (D-Jury) and **-0.50** or **-1.00** (dependent on continuance of exercise or fall) + other execution errors (E-Jury).
 - k) All dismounts other than handstand dismounts must be executed with the body at a minimum angle of 30° above the shoulder horizontal line before landing. For angles lower than 30°, deductions will be applied according to the specific errors and deductions table for pommel horse, Art. 11.3.
 - l) If a gymnast believes he did not receive value for his dismount, he may repeat any dismount for value (one time only) within 30 seconds of completing the original attempt. If the original dismount received a large deduction, and the dismount is repeated, the large deduction must be increased to **-1.00** by the E-Jury.
3. For a full list of errors and deductions governing Exercise Presentation, see Section 9 and the summary of deductions in Articles 9.4 and 11.3.

Article 11.2.2 Information about the D-score

1. The Element Groups (EG) are:

- I. Single leg swings and scissors.
- II. Circle and flairs, with and/or without spindles and handstands, Kehrs wings, Russian wendeswings, flops and combined elements.
- III. Travel type elements, including Tong Fei, Wu Guonian, Roth and Traveling Spindles.
- IV. Dismounts.

2. Additional information and regulations:

a) General

- a.1) Unless otherwise indicated, all circle elements (including travels, spindle and wenderswing), begin and end in front support.
- a.2) Unless otherwise indicated, each element is defined as occurring within one structure and ending when a new structure is initiated, as follows (Exception: the combined series provision):
 - i. A hop element ends at the completion of the hop or series of hops.
 - ii. A circle or flair element ends when it changes to the other.
 - iii. A spindle element ends when the spindle action stops.
 - iv. A front support element (wendeswing) ends when the wende action stops.
 - v. Travel elements in cross support end when the travel action or the cross support position is either interrupted by a circle or some other element or is ended in some other way.
 - vi. Russian wendeswing travel elements end when the travel action or Russian wendeswing action interrupted by additional or intermediate support or ended in some other way.
 - vii. For difficulty recognition purposes, travelling elements can be considered finished as soon as the travel is completed.
 - viii. Magyar and Sivado may share a common circle connecting them and receive D+D difficulty. To receive credit for an A value circle between the two travels, the A value circle must be completed fully from front support to front support.
 - ix. III.46 (Moguilny) and III.52 (Belenki) may begin from cross support (also facing out) minus 90° on first turn AND final turn, with travel from one end to the other.
- a.4) For all travel in side support start position 1-2 and final position 4-5 considered as enough to fulfill requirements.
- a.5) In order to further simplify the rules regarding falls, all listed elements in EGII and EGIII, require a listed CoP element afterwards for value. The only exception would be a swing forward with both legs (half circle) and finishing the circle with one leg, followed by simple leg swing or scissor.
For example: On one pommel: L, L, S, S finishing the circle with one leg, followed by simple leg swing or scissor. D-Jury action: E value element and element without value if a fall occurs, no partial difficulty can be awarded. In the case of a fall after starting the subsequent element, the previous element will receive credit.
- a.6) All Sohn and Bezugo type elements from a stand (and not from a circle element) will be valued two letters lower than the value from the listed element in the Code of Points. Sohn and Bezugo are defined from support on two pommels 360° turn to finish in front support on two pommels. If gymnast does not finish with hands on both pommels, there is no credit awarded for these specific elements.
- a.7) A Russian Wendeswing to a dismount beginning in cross support facing out must complete Russian(s) as listed



before the Wende to receive full dismount value.

- a.8) A Wu Guonian requires a minimum 360° of body turn to be completed with two hands between the pommels. After Wu Guonian the gymnast might add any listed elements in the CoP (R180, R360, etc).
- a.9) No additional elements may be added to increase the value of these elements:
- Kehre fwd., reverse Stöckli, kehre fwd. (III.46, Moguilny).
 - Kehre bwd., kehre fwd., kehre bwd. (III.52, Belenki).
- a.10) Clarification concerning the start position for travels backward in cross support: the gymnast is allowed to start these elements in rear support on the end of the horse facing out with both hands on the leather.
- a.11) All travels with spindle should be started from the additional circle in appropriate position.
- a.12) In the case of the Mikulak style elements, where the gymnast supports themselves with their leg before completing the element, the element will not be recognized and receive 0.5 deduction for interruption of exercise without a fall.

b) Circles

- b.1) All basic circles in cross and side support (also on one pommel) may end with a ¼ turn without changing the structure or value of the element.
- b.2) Step up to pommel, with or without ¼ turn, is B value Circle with or without ¼ turn on one pommel, and counts as start to flop sequence (Element II.8).

c) Handstand

- c.1) There is no upgrade in value for turning within a handstand from scissors.
- c.2) There is no upgrade in value for the performance of turning within a handstand (from circles or flairs) solely on the pommels. Turning within a handstand requires a majority use of the leather.
- c.3) When performing a 3/3 travel during a handstand (within an exercise or dismount), “support” with one hand must be shown on both ends of the horse to receive the 3/3 upgrade in value. There is no upgrade in value for additional turning, within a handstand from circles or flairs (indicated in the table below)
- c.4) Increases in Value for Handstands from circle or flairs:

1. Circle or flair handstand dismounts

	Handstand		
	“B”	“C”	“D”
w/450° (or more) turn OR 3/3 travel*	C	D	E
w/450° (or more) turn AND 3/3 travel*	D	E	F

*3/3 travel requires minimum 270° turn.

2. Circle or Flair Handstand and lower to circle/flair

	Handstand		
	“B”	“C”	“D”
Lower to circle/ flair	C	D	E
w/360° (or more) turn OR 3/3 travel*	D	E	F
w/360° (or more) turn AND 3/3 travel	E	F	G

*3/3 travel requires minimum 180° turn.

- c.5) Swing with strength and/or lowering of the hips or legs in achieving handstands from a scissor or from circles or flairs (including dismounts) will receive the value for the element and element group (D-Jury) with E-Jury deductions. However, if there is a large error, no recognition will be given for the handstand or dismount. In the case of a large deduction, the gymnast will receive a **-0.50** deduction and only deductions for aesthetic errors (legs, feet, bent arms, touch horse, etc.). No deductions for strength or angle will be applied.



c.6) A scissor to handstand should be performed with a straight body and a continuous upwards movement. If the gymnast moves directly to a position with an extreme hip bend (>90°) the element will not be recognized.

If a leg or legs move between the pommels at any stage this would also lead to non-recognition.

c.7) All scissors through handstand on one pommel require a change of arm or pommel to receive value.

c.8) All scissors through handstand on one pommel require a leg change (like double scissor) to receive value.

d) Combined elements

d.1) It is possible to combine certain elements on a single pommel. There are two types of such combined elements listed in the Element Group II:

- III.46 (Moguilny) and III.52 (Belenki) may begin from cross support (also facing out) minus 90° on first turn AND final turn, with travel from one end to the other. The DSA may only appear at the end of the sequence.
- Bertoncej and Davtyan may only appear at beginning of the sequence.

The following examples illustrate this rule:

- DSB + DSB + DSA = D value flop.
 - Circle on one pommel + DSB + DSB + DSA = E value flop
 - Bertoncej + Circle on one pommel + DSB = E value flop
- Only one such flop sequence may be used in an exercise for value.

ii. Combined sequences on one pommel of circle and/or Stöckli A or B, Bertoncej and Davtyan with Russian wendeswings. The circle and/or Stöckli B, (Bertoncej and Davtyan must precede) can either precede or follow the Russian wendeswings and must appear as 2 consecutive circle elements to be part of a two-flop Combined Sequence. The DSA may only appear at the end of the sequence. Only one of these combined sequences may be used during an exercise.

Russian	Flop	
	1	2
R18 or R27 (B)	+	D
R36 or R54 (C)	+	E
R72 or R90 (D)	+	F
R108 (E)	+	G

Bertoncej/ Davtyan + Circle on pommel	Russian		
	+	R18 or R27 (B)	E
	+	R36 or R54 (C)	F
	+	R72 or R90 (D)	G
+	R108 (E)	H	

iii. In any case when a combined element is involved, the gymnast will not have the right to make use of the same element three times in direct succession.

iv. Flop and combined elements must be separated by minimum one circle with one hand off of the one pommel

v. A DSB is considered finished in side support frontways on one pommel.

d.2) No other double elements will be credited for higher value.

For example: 2 circles or 2 DSB's in any position receive credit only for the first circle or DSB and no value or recognition for the second.

d.3) DSA requires ¼ turn in and ¼ out.

e) Spindles

e.1) Spindles in EG II in cross or side support with legs together or flair must be performed within a maximum 2 circles (3 front support positions after the original start position for D value.

e.2) There are two D value 1/1 Spindles (EG II) in the Code of Points:

- II.28 Any side support pommel between hands 1/1 spindle with legs straddle inside max. 2 circles.
- II.34 Any cross or side support 1/1 spindle within max. 2 circles (Magyar).

Both may be performed in the same exercise.

f) Dismounts

f.1) Pommel Horse is the only apparatus where a dismount may be repeated (one time only) if the gymnast determines he may not have received credit because of a fall or a large deduction. This must be done within the allowable time. If the gymnast steps off the podium (this includes the stairs), the exercise is terminated.

f.2) In the case of a repeated dismount, the gymnast has 30 seconds to remount the horse and perform any type of dismount of his choice for value and EG IV.

Examples of repeating a PH dismount are:



Example 1

Action	Gymnast	D-Jury evaluation	E-Jury evaluation
Stöckli to handstand 270° t. 3/3 dismount attempt	Falls while attempting the handstand	No value or EG IV	-1.00 and any deductions prior to the action of falling
Repeated Stöckli to handstand 270° t. 3/3 dismount within the time permitted.	Successfully repeats Stöckli to handstand 270° t. 3/3 with -0.0 deduction	D value (0.4) and +0.4 EG IV	-0.0

Example 2

Action	Gymnast	D-Jury evaluation	E-Jury evaluation
Stöckli to Handstand 450° t. 3/3 dismount attempt	Lowers legs with large deviation then completes dismount	No value or EG IV	-0.50 (lowering legs) and any aesthetic deductions
Repeated Stöckli to handstand 450° t. 3/3 dismount within the time permitted.	Successfully repeats Stöckli to handstand 450° t. 3/3 with -0.0 deduction	E value (0.5) and +0.5 EG IV	The -0.5 (lowering legs) must be changed to -1.0 for a fall plus any deductions viewed on the second attempt.

Example 3

Action	Gymnast	D-Jury evaluation	E-Jury evaluation
Russian 1080° dismount attempt	Falls at 900°	No value	-1.00 and any deductions prior to the action of falling
Repeated Russian 1080° dismount within the time permitted.	Successfully repeats Russian 1080° dismount with -0.1 leg separation	C value (0.3) and +0.3 EG IV	-0.10 for leg separation

In Example 3, the judge cannot always determine if the first Russians are a dismount attempt.

3. Special repetitions:

- a) A maximum of two (3/3) cross support travels (forwards and/ or backwards) are permitted during the exercise. This rule applies to the following six travels ONLY:
- III.33 Travel forward in cross support with support on leather, pommel, pommel, leather (3/3) (1-2-4-5)
 - III.34 Any other travel forward in cross support to other end (3/3) (Magyar)
 - III.35 Travel forward in cross support over both pommels (also with hop) (Driggs).
 - III.39 Travel backward in cross support with support on leather, pommel, pommel, leather (3/3) (5-4-2-1).
 - III.40 Any other travel backward in cross support to other end (3/3) (Sivado).
 - III.41 Travel backward in cross support over both pommels (also with hop) (Kurbanoc/Reid).
- b) A maximum of two Russian Wendeswings are permitted for value in an exercise, including the dismount. For Pommel Horse these special repetition rules are wider, any 2nd Russian Wenderswing element on the end including dismount or 2nd Russian Wenderswing element between pommels considered as repetition. The following examples illustrate this rule:
- Russian on the end 1080° + Russian 720° to wende = No value + B value
 - Russian between pommels 720° + Russian between pommels 1080° = No value + E value.
 - Russian between pommels 360° + Russian on the end 1080° + Russian 360° to wende = C value + no value + A value (dismount is counted first).
- Excluded from the rule are flop/ Russian combinations on one pommel.
- c) A maximum of 2 handstand elements are permitted for value in an exercise from circles, flairs, or scissors (not including the dismount).
- d) A maximum of two (3/3) Russian Wendeswings travel elements are permitted for value in an exercise. This rule applies to the following travels ONLY:
- III. 57 From support on 1 pommel, Russian Wendeswings forward to other end without support on or between the pommels (side to side support, side to cross support) (Tong Fei).
 - III.58 From support on end, Russian Wendeswings forward to other end without support on or between the pommels (side to side support, side to cross, cross to side, cross to cross).
 - III.59 On the leather, from cross support, Russian Wendeswings with 360° or 540° over both pommels (Vammen).



- III.64 From support 1-2, 3/3 travel in Russian type Wendeswings with 630° or more turning.
 - III.65 Any 3/3 travel in Russian type Wendeswings with 720° or more turning (Wu Guyonian).
 - III.70 Any Russian Wendeswings with 360° and 3/3 travel (Roth).
- e) A maximum of two 3/3 travel with Spindle elements are permitted for value in an exercise. This rule applies to the following travels ONLY:
- III.17 From an end side travel with 2 x ½ spindle to other end.
 - III.22 Any travel forward 3/3 with ½ spindle from one pommel over the other pommel (Nin Reyes/Titov).
 - III.23 Travel 3/3 over both pommels with ½ spindle (Nin Reyes 2/Keiha 2).
 - III.29 Any 3/3 cross support travel in flair with 1/1 Spindle inside 2 circles (Urzica 2/Burkhart).
- f) A maximum of two full Spindle elements are permitted for value in an exercise. This rule applies to the following spindle ONLY:
- II.28 Any side support 1/1 spindle with legs straddle inside maximum 2 circles.
 - II.29 Any side support 1/1 spindle with hand support to the other side and return (maximum 2 flairs or circles) (Eichorn).
 - II.30 Side support, 1/1 spindle with both pommels between the hands (flair or circle) (Keikha 1/Keikha 5).
 - II.34 Any 1/1 spindle within maximum 2 circles on the end (Maygar).
 - II.35 1/1 spindle with legs straddle or together on the pommels inside maximum 2 circles (Berki).
 - II.36 Cross support, 1/1 spindle with hands between the pommels maximum 2 circles
- g) A maximum of two Bezugo and/or Sohn type elements, including combined and Handstands.
- h) A maximum of 4 elements in flairs are permitted for value (not including the dismount).
- i) Busnari type elements: an exercise cannot include more than one variation of the same type of the element. In this case the elements with the highest difficulty value will be counted.
- j) Travel elements: an exercise cannot include more than one variation of the same type of the element. In this case the elements with the highest difficulty value will be counted. This rule applies to the following travels ONLY:
- i. 3/3 Russian Wendeswings travel elements:
 - III.64 From support 1-2, 3/3 travel in Russian type wendeswing with 630° or more turning.
 - III.65 Any 3/3 travel in Russian type wendeswing with 720° or more turning (Wu Guyonian).
 - III.70 Any Russian wendeswing with 360° t. and 3/3 travel (Roth).
 - ii. Tong Fei style travel elements:
 - III.57 From support on 1 pommel, Russian wendeswing fwd. to other end without support on or between the pommels (side to side support, side to cross support).
 - III.58 From support on end, Russian wendeswing fwd. to other end without support on or between the pommels (side to side, side to cross, cross to side, cross to cross) (Tong Fei).
 - III.59 On the leather, from cross support, Russian wendeswing with 360° or more over both pommels (Vammen)
 - iii. Nin Reyes style travel elements:
 - III.22 Travel fwd. 3/3 with ½ Spindle from one pommel over the other pommel (Nin Reyes).
 - III.23 Travel fwd. 3/3 over both pommels with ½ Spindle (Nin Reyes 2).

For example:

 - Nin Reyes (III.22) + Nin Reyes 2 (III.23). D jury action: Rep + E value
 - Nin Reyes (III.22) + Keikha 4 (III.23). D jury action: D Value + E value
 - Titov (III.22) + Nin Reyes 2 (III.23). D jury action: D Value + E value

4. For a further list of regulations governing non-recognition of elements and other aspects of the D-score, see Section 7 and the summary of deductions in Article 7.6.









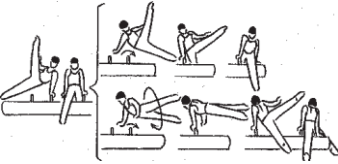

Article 11.3 Specific Deductions for Pommel horse

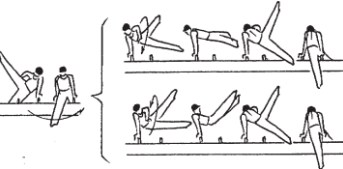



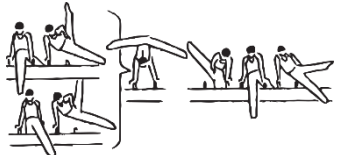
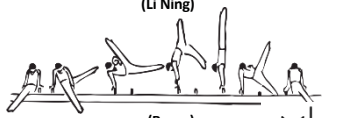







E-Jury

Error	Small 0.10	Medium 0.30	Large 0.50
Lack of amplitude in scissors and single leg swings.	●	●	
Handstand with visible strength	●	●	● NR.
Pausing or stopping in handstand.	●	●	● NR.
Hip breaks during circles or flairs.	●	●	
Lack of body ext. in circles or flairs. Each element	●		
Legs apart during elements	0° - 30°	>30° - 60°	>60° - 90°
Angular deviations in cross support circles and travels. Each element	>15° - 30°	>30° - 45°	>45° NR.
Landing obliquely or not facing the long axis of the horse.	● Deviation >45	● Deviation 90°	
Non handstand dismounts, body position under 30° over shoulder horizontal line.		●	
Scissor to handstand with hip bend.	●	●	● NR.
Scissors to handstand without closing the legs.	≤ Shoulder width	> Shoulder width	
Extra ½ swing on mount without a leg changing sides.		●	
Unsteadiness in the handstand dismount, turning problems.	●	●	
Lowering of legs on elements to a handstand (from original position)	0 - 15°	>15° - 30°	>30° - 45° >45° NR

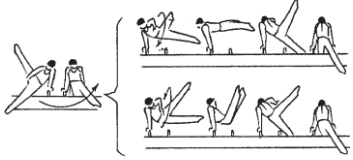



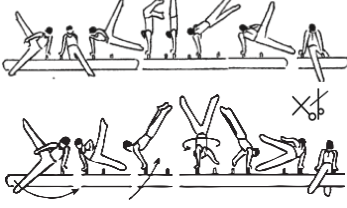

A = 0,1	B = 0,2	C = 0,3	D = 0,4	E = 0,5	F = 0,6 G = 0,7 H = 0,8
EG I: Single leg swings and scissors					
<p>1. Scissor forward.</p>  <p style="text-align: center;">X</p>	<p>2. Scissor forward with travel sideways (also with 1/2 t.)</p>  <p style="text-align: center;">X → X →</p>	<p>3. Scissor fwd. with hop sideways from one end to the other (3/3).</p>  <p style="text-align: center;">X ↻</p>	<p>4.</p>	<p>5.</p>	<p>6.</p>
<p>7. Scissor forward with ¼ t.</p>  <p style="text-align: center;">X ↻</p>	<p>8. Double scissor fwd. (¼ t. fwd. a. ¼ t. bwd.).</p>  <p style="text-align: center;">X ↻</p>	<p>9. Double scissor fwd. (¼ t. fwd. a. ¼ t. bwd.) with travel sideways.</p>  <p style="text-align: center;">X ↻ →</p>	<p>10. Double scissor forward sideways from one end to the other (3/3).</p> <p style="text-align: center;">(Mikulak)</p>  <p style="text-align: center;">X ↻ ↻</p>	<p>11.</p>	<p>12.</p>
<p>13.</p>	<p>14.</p>	<p>15. Double Scissor fwd. with travel sideways through handstand.</p> <p style="text-align: center;">(Stepanyan)</p>  <p style="text-align: center;">X ↻</p>	<p>16.</p>	<p>17.</p>	<p>18.</p>
<p>19.</p>	<p>20. Leg cut or undercut bwd. through handstand and lower to support with straddle legs.</p>  <p style="text-align: center;">X ↻</p>	<p>21.</p>	<p>22. Scissor fwd. with ¼ t. through handstand on 1 pommel, lower to support with straddle legs on the other arm (with legs changing)</p> <p style="text-align: center;">(Li Ning)</p>  <p style="text-align: center;">(Bryan)</p>  <p style="text-align: center;">X ↻</p>	<p>23.</p>	<p>24.</p>



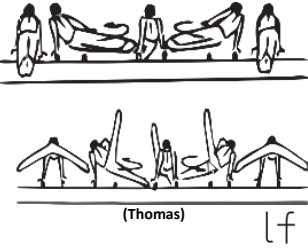

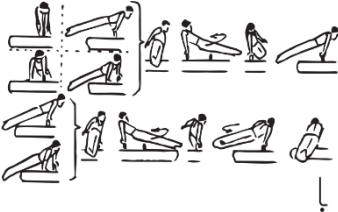
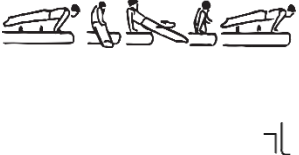







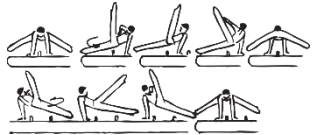

A = 0,1	B = 0,2	C = 0,3	D = 0,4	E = 0,5	F = 0,6 G = 0,7 H = 0,8
EG I: Single leg swings and scissors					
<p>25. Scissor backward.</p>  	<p>26. Scissor bwd. with travel sideways (also with ¼ t.).</p>   	<p>27. Scissor bwd. with hop sideways from one end to the other (1-2 to 4-5).</p>  	<p>28.</p>	<p>29.</p>	<p>30.</p>
<p>31. Scissor backward with ¼ turn.</p>  	<p>32. Double scissor bwd. (¼ t. fwd. a. ¼ t. bwd).</p>  	<p>33.</p>	<p>34.</p>	<p>35.</p>	<p>36.</p>
<p>37.</p>	<p>38.</p>	<p>39. Swing bwd. w. ¼ t. through handstand on 1 pommel (also with ¼ t. after), lower to support with straddle legs (with legs changing)</p>   	<p>40.</p>	<p>41.</p>	<p>42.</p>
<p>43.</p>	<p>44.</p>	<p>45.</p>	<p>46.</p>	<p>47.</p>	<p>48.</p>

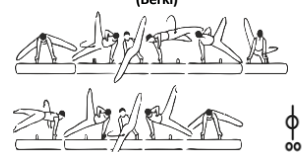







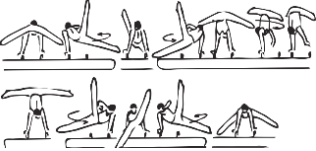
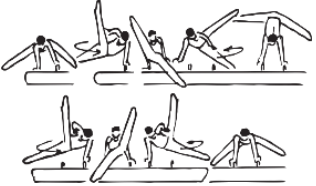

A = 0,1	B = 0,2	C = 0,3	D = 0,4	E = 0,5	F = 0,6 G = 0,7 H = 0,8
EG II: Circle and flairs, with and/or without spindles and handstands, Kehrs wings, Russian wendeswings, flops and combined elements					
<p>1. Any circle or flair in side support.</p>  <p>(Thomas) lf</p>	<p>2. Circle in side support outside pommels or between the pommels.</p>  <p>lf</p>	<p>3.</p>	<p>4.</p>	<p>5.</p>	<p>6.</p>
<p>7. Circles in cross support frontways on end.</p>  <p>rl</p>	<p>8. Circles in cross support on 1 pommel (from or to ¼ t. fwd.).</p>  <p>lf</p>	<p>9.</p>	<p>10.</p>	<p>11.</p>	<p>12.</p>
<p>13. Circles in cross support rearways on end.</p>  <p>rl</p>	<p>14. Circles in cross support between the pommels.</p>  <p>lf</p>	<p>15.</p>	<p>16.</p>	<p>17.</p>	<p>18.</p>
<p>19.</p>	<p>20.</p>	<p>21.</p>	<p>22.</p>	<p>23.</p>	<p>24.</p>

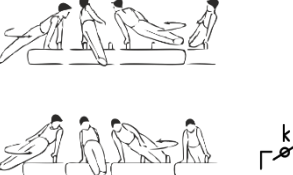





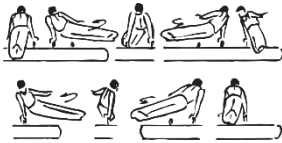

A = 0,1	B = 0,2	C = 0,3	D = 0,4	E = 0,5	F = 0,6 G = 0,7 H = 0,8
EG II: Circle and flairs, with and/or without spindles and handstands, Kehrswings, Russian wendeswings, flops and combined elements					
<p>25. Any ¼ spindle</p> 	<p>26. Any ½ spindle</p>  <p>(Keikha 2)</p>	<p>27.</p>	<p>28. Any side support pommel between hands 1/1 spindle w. legs straddle inside max. 2 circles.</p> 	<p>29. Any side support 1/1 spindle with hand support to the other side and return (max. 2 flairs or circles)</p> <p>(Eichorn)</p> 	<p>30. Any 1/1 spindle with both pommels between the hands (flair or circle).</p> <p>(Keikha 1)</p>  <p>(Keikha 5)</p> 
<p>31.</p>	<p>32.</p>	<p>33.</p>	<p>34. Any 1/1 spindle within max. 2 circles on the end.</p> <p>(Magyar)</p> 	<p>35. 1/1 spindle w. legs straddle or together on the pommels inside max. 2 circles.</p> <p>(Berki)</p> 	<p>36. Cross support, 1/1 spindle with hands between the pommels max. 2 circles.</p> 
<p>37.</p>	<p>38. Direct Stöckli A (DSA) on the pommels or pommel between hands.</p>  <p>S_a</p>	<p>39.</p>	<p>40. Direct Stöckli A (DSA) outside pommels.</p> <p>(Keikha 3)</p>  <p>S_a</p> <p>(Keikha 6)</p>  <p>f_{Sa}</p>	<p>41.</p>	<p>42.</p>
<p>43.</p>	<p>44. Direct Stöckli B (DSB).</p>  <p>S</p>	<p>45.</p>	<p>46.</p>	<p>47.</p>	<p>48.</p>

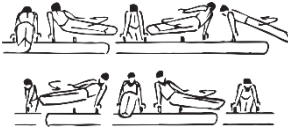





A = 0,1	B = 0,2	C = 0,3	D = 0,4	E = 0,5	F = 0,6 G = 0,7 H = 0,8
EG II: Circle and flairs, with and/or without spindles and handstands, Kehrs wings, Russian wendings, flops and combined elements					
49.	50.	51. Flair or circle through handstand (with or without $\frac{1}{2}$ t.) and lower to flair or circle. (Tippelt)  flf	52. Flair with hop travel bwd. through handstand and lower to circles or flairs  flf	53.	54. Reverse Stöckli, DSA or pommel circle straddle through handstand, 3/3 travel (fwd.- bwd), 360° turn to flairs. (Busnari)  Sabe f
55. Double rear (kehr).  k	56. Kehr with 270° t. on 1 p. (Sohn technique) from cross to side support.  k	57. Kehr with 270° t. on 1 pommel (Sohn technique) from side to cross support. (Bertoncelj)  k	58. Kehr with 1/1 turn on 1 pommel. (Sohn)  k	59.	60.
61.	62. Direct Tramlot.  k	63.	64.	65.	66.
67.	68. Reverse Stöckli 180° (or 270° from one pommel) turn in one circle.  R	69. Reverse Stöckli with 270° t. (Bezugo technique) from 2 pommels to cross support on 1 pommel (Davtyan)  R	70.	71. Reverse Stöckli with 360° t. on 1 pommel. (Bezugo)  R	72.



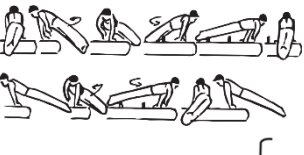



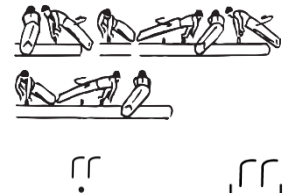
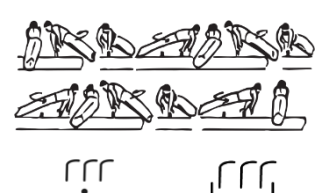



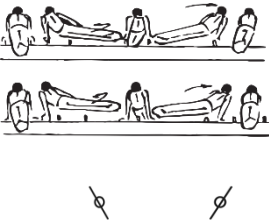
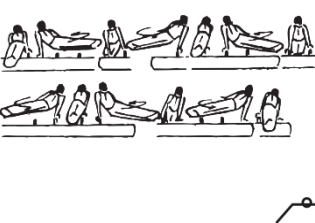
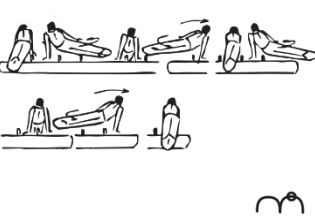

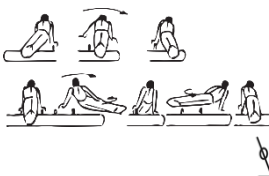
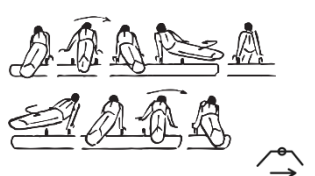
A = 0,1	B = 0,2	C = 0,3	D = 0,4	E = 0,5	F = 0,6 G = 0,7 H = 0,8
EG II: Circle and flairs, with and/or without spindles and handstands, Kehrs wings, Russian wendeswings, flops and combined elements					
<p>73. Schwabenflank.</p>  <p style="text-align: right;">C_S</p>	<p>74. Czechkehre on the pommels or pommel between hands.</p>  <p style="text-align: right;">C</p>	<p>75.</p>	<p>76. Czechkehre outside pommels (Pinheiro)</p>  <p style="text-align: right;">C</p>	<p>77.</p>	<p>78.</p>
<p>79. Wendeswing fwd. with 1/2 t. to support fwd. on the end, from side support using 1 or 2 pommels.</p>  <p style="text-align: right;">W</p>	<p>80.</p>	<p>81.</p>	<p>82.</p>	<p>83.</p>	<p>84.</p>
<p>85. Russian wendeswing with 180° or 270°.</p>  <p style="text-align: right;">R</p>	<p>86.</p>	<p>87.</p>	<p>88.</p>	<p>89.</p>	<p>90.</p>
<p>91. Russian wendeswing with 360° or 540°.</p>  <p style="text-align: right;">R</p>	<p>92. Russian wendeswing with 720° or 900°.</p>  <p style="text-align: right;">RR</p>	<p>93. Russian wendeswing with 1080° or more.</p>  <p style="text-align: right;">RRR</p>	<p>94.</p>	<p>95.</p>	<p>96.</p>

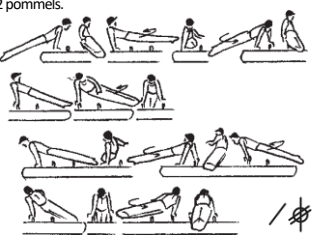
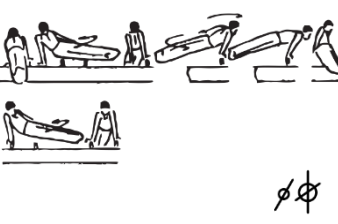
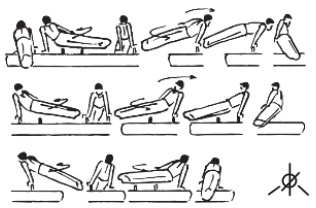

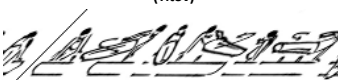







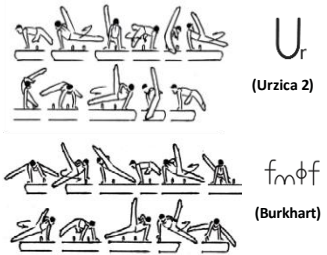

A = 0,1	B = 0,2	C = 0,3	D = 0,4	E = 0,5	F = 0,6 G = 0,7 H = 0,8
EG II: Circle and flairs, with and/or without spindles and handstands, Kehrswings, Russian wendeswings, flops and combined elements					
<p>97. On the leather, Russian wendeswing with 180° or 270° also with travel.</p> 	98.	99.	100.	101.	102.
<p>103. On the leather, Russian wendeswing with 360° or 540°.</p> 	<p>104. On the leather, Russian wendeswing with 720° or 900°.</p> 	<p>105. On the leather, Russian wendeswing with 1080° or more.</p> 	106.	107.	108.
109.	<p>110. Russian wendeswing with 180° or 270° on 1 pommel or between the pommels.</p> 	<p>111. Russian wendeswing with 360° or 540° on 1 pommel or between the pommels.</p> 	<p>112. 720° or 900° Russian wendeswing on 1 pommel or between the pommels.</p> 	<p>113. 1080° Russian wendeswing or more on 1 pommel or between the pommels.</p> 	114.
115.	116.	117.	118.	119.	120.

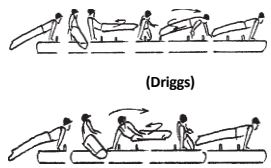



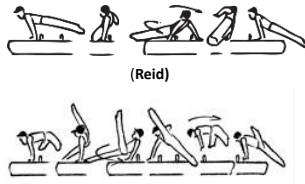



A = 0,1	B = 0,2	C = 0,3	D = 0,4	E = 0,5	F = 0,6 G = 0,7 H = 0,8
EG III: Travel type elements, including, Tong Fei, Wu Guonian, Roth and Traveling Spindles					
<p>1. Circles with any travel in side support (1/3) (also with ¼ t.).</p> 	<p>2. Circles with any travel in side support (3/3).</p> 	<p>3. Any travel in side support (3/3), hands between pommels.</p> 	<p>4. Any travel in side support (3/3) over both pommels (also with hop).</p> 	<p>5.</p>	<p>6.</p>
<p>7.</p>	<p>8. Circles with any hop travel in side support (1/3)</p> 	<p>9. Circles with any hop travel 2x in side support (3/3).</p> 	<p>10.</p>	<p>11. From side support beside the pommel, travel hop over 2 pommels to support fwd on other end (1-1 to 5-5). (Yamawaki)</p> 	<p>12.</p>
<p>13.</p>	<p>14. Travel fwd. or bwd. with ¼ spindle to side support on 2 pommels.</p> 	<p>15. All travels with ½ spindle in side support.</p> 	<p>16.</p>	<p>17. From an end side travel with 2x ¼ spindle to other end.</p> 	<p>18.</p>
<p>19.</p>	<p>20.</p>	<p>21.</p>	<p>22. Any travel fwd. 3/3 with ¼ Spindle from one pommel over the other pommel. (Nin Reyes)  (Titov)  NR </p>	<p>23. Travel 3/3 over both pommels with ¼ Spindle. (Nin Reyes 2)  (Keikha 4)  NR₂ </p>	<p>24.</p>





A = 0,1	B = 0,2	C = 0,3	D = 0,4	E = 0,5	F = 0,6 G = 0,7 H = 0,8
EG III: Travel type elements, including, Tong Fei, Wu Guonian, Roth and Traveling Spindles					
25.	26.	27.	28.	29. Any 3/3 travel in flairs with 1/1 Spindle inside 2 circles.  U _r (Urzica 2) f _m φf (Burkhardt)	30.
31.	32. Travel fwd. in cross support (1/2 or 2/3). 	33. Travel fwd. in cross support with support on leather, pommel, pommel, leather (3/3) (1-2-4-5). 	34. Any other travel fwd. in cross support to other end (3/3). (Magyar) 	35. Travel forward in cross support over both pommels (also with hop). (Driggs) 	36.
37. Travel bwd. in cross support from one horse part or pommel to another (½). 	38. Travel bwd. in cross support (1/2 or 2/3). 	39. Travel bwd. in cross sup with support on leather, pommel, pommel, leather (3/3) (5-4-2-1). 	40. Any other travel bwd. in cross support to other end (3/3). (Sivado) 	41. Travel backward in cross support over both pommels (also with hop). (Kurbanov) (Reid) 	42.
43.	44.	45.	46. Kehre fwd., reverse Stöckli, kehre fwd. (Moguilny)  Mo	47.	48.











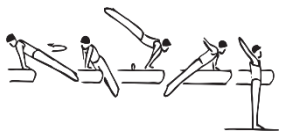
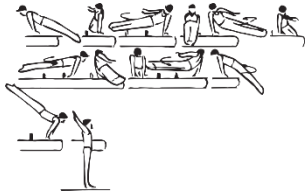
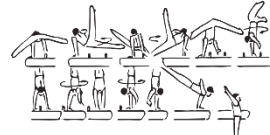

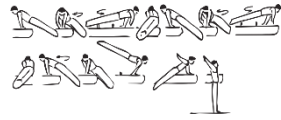
A = 0,1	B = 0,2	C = 0,3	D = 0,4	E = 0,5	F = 0,6 G = 0,7 H = 0,8
EG III: Travel type elements, including, Tong Fei, Wu Guonian, Roth and Traveling Spindles					
49.	50.	51.	52. Kehre bwd., kehre fwd., kehre bwd. (Belenki)  Be	53.	54.
55.	56.	57. From support on 1 pommel, Russian wendeswing fwd. to other end without support on or between the pommels (side to side support, side to cross support).  Tf	58. From support on end, Russian wendeswing fwd. to other end without support on or between the pommels (side to side, side to cross, cross to side, cross to cross). (Tong Fei)  Tf	59. On the leather, from cross support, Russian wendeswing with 360° or more-over both pommels. (Vammen)  V	60.
61.	62.	63.	64. From support 1-2, 3/3 travel in Russian type wendeswing with 630° or more turning.  Wu	65. Any 3/3 travel in Russian type wendeswing with 720° or more turning. (Wu Guonian)  Wu	66.
67.	68.	69.	70. Any Russian wendeswing with 360° t. and 3/3 travel. (Roth)  Ro	71.	72.

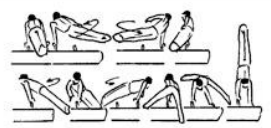

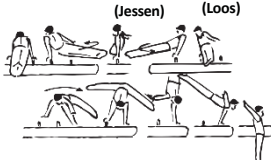
A = 0,1	B = 0,2	C = 0,3	D = 0,4	E = 0,5	F = 0,6 G = 0,7 H = 0,8
EG III: Travel type elements, including, Tong Fei, Wu Guonian, Roth and Traveling Spindles					
73.	74.	75. Reverse Stöckli from cross support on end to the far pommel (Romero)  Rm	76. Reverse Stöckli from cross support on one end to the other. (Abu Alsoud)  R	77.	78.
79.	80.	81.	82.	83.	84.
85.	86.	87.	88.	89.	90.
91.	92.	93.	94.	95.	96.

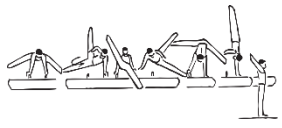

A = 0,1	B = 0,2	C = 0,3	D = 0,4	E = 0,5	F = 0,6 G = 0,7 H = 0,8
EG IV: Dismounts					
<p>1. Wende from circle (also from Russian wendeswing 180° or 270°)</p>  <p style="text-align: right;">↗</p>	<p>2. Chaguinian to wende.</p>  <p style="text-align: right;">Cg</p>	<p>3.</p>	<p>4. From side support on end, circle or flair to handstand and travel 3/3 with 450° or more turn. (Kolyvanov)</p>  <p style="text-align: right;">fLe</p>	<p>5. DSA to handstand 3/3 with 450° or more turn.</p>  <p style="text-align: right;">S_aLe Le RLe</p>	<p>6.</p>
<p>7. On the end, Russian wendeswing with 360° or 540°</p>  <p style="text-align: right;">↗</p>	<p>8. On the end, Russian wendeswing with 720° or 900°.</p>  <p style="text-align: right;">↗↗</p>	<p>9. On the end, Russian wendeswing with 1080° or more.</p>  <p style="text-align: right;">↗↗↗</p>	<p>10. From pommels, circle with 1/4 turn to Russian wenderswing 270° on one pommel to handstand. (Dolidze)</p>  <p style="text-align: right;">kRb</p>	<p>11.</p>	<p>12.</p>
<p>13. From side support wendeswing fwd. with ½ t. to support followed by wende.</p>  <p style="text-align: right;">W↗</p>	<p>14.</p>	<p>15. DSA, reverse Stöckli or circle on one pommel through handstand.</p>  <p style="text-align: right;">S_ab b Rb</p>	<p>16. DSA with hop bwd. through handstand on other end. (Jessen) (Loos)</p>  <p style="text-align: right;">S_ab</p>	<p>17.</p>	<p>18.</p>
<p>19.</p>	<p>20. Circle or flair through handstand (also with ¼ t. with or without travel).</p>  <p style="text-align: right;">fb b</p>	<p>21. Circle or flair with hop travel bwd. through handstand.</p>  <p style="text-align: right;">fb →</p>	<p>22. 180° Russian from one end of the horse to the other end through handstand to dismount (Pellerin)</p>  <p style="text-align: right;">c b</p>	<p>23.</p>	<p>24.</p>

Section 12

Rings

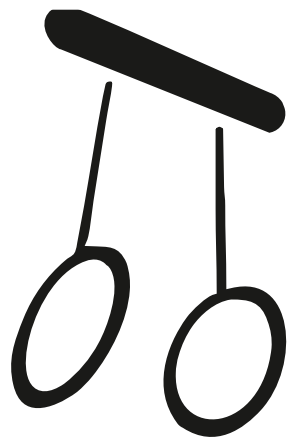

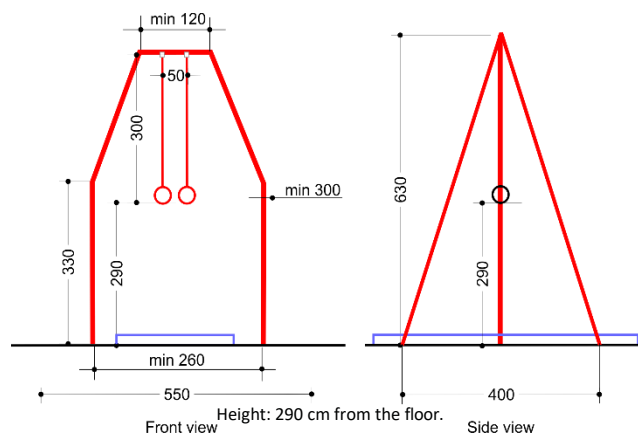

Article 12.1 Exercise description

An exercise on the Rings is composed of swing, strength and hold parts in approximately equal portions. These parts and combinations are executed in a hang, to or through a support, and to or through the handstand position. Contemporary Rings exercises are characterized by transitions between elements of swing and strength or the reverse where execution with straight arms should predominate.

Article 12.2 Content and Construction

Article 12.2.1 Information about Exercise Presentation

- From a still stand, the gymnast must jump or be assisted to a still hang on the Rings with legs together and with good form. The evaluation begins the moment his feet leave the floor. The coach is not permitted to give the gymnast an initial swing.
- An exercise must start in a hang position with arms and body vertical and straight. The gymnast must NOT bend their arms in moving to the first element unless specifically needed for the element completion.

Example: Cast up and underswing backward may be started with bent arms at any time during an exercise.
- Straight arms must be used whenever the nature of the element permits. Elements that can be performed with bent arms are described in the element tables. A gymnast may only bend their arms during a transition between elements when necessary to properly perform the next element.
- During swings to a hold position or strength presses, the shoulders and/or body may not rise above the perfect hold position $>5^\circ$. The angle is defined from the bottom of the Rings to middle of the shoulder. This deduction is different from the deduction for final hold position.

Example: Uprise bwd to cross at 25° and lower to hold position at $10^\circ = 0.3 + 0.1$ deduction.
- Back swings in support that do not lead to a value part but simply reverse direction and swing back down in or to a lower hang position will be deducted.

Example: Kip to support, swing back to layaway to front uprise.
- Compositional errors with deductions of 0.3.

Example: Honma to support then lift to L sit OR straddle L sit to L sit.
Honma to support then lower backward to inverted hang
- The hold of non-listed parts for more than 2 seconds, will be deducted each time.

Examples include: inverted pike, dorsal and inverted hang.
- Additional Technical, aesthetic and execution aspects in the exercise construction expectations are:
 - Hold positions must be reached directly, with straight arms, and without need for postural corrections.
 - A false grip (over grip) for strength holds is not permitted. A false grip is performed when the wrists are bent in order to gain an advantage in performing a strength element, deduction -0.1 each time.

No false grip, is performed with straight wrists with or without the fingers of the hands wrapped around the Rings.
Note: The position of the Rings in the hands (with straight wrists and open hands) does not change the evaluation
 - For strength elements to handstand with bent arms, where the necessary technique requires minimal touching of the straps with the lower arms, no deduction should be taken for contact with the straps (Elements II.25 and II.26 only with bent arms).
- For a full list of errors and deductions governing Exercise Presentation, see Section 9 and the summary of deductions in Articles 9.4 and 12.3.

Article 12.2.2 Information about the D-score

- The Element Groups (EG) are:
 - Kip and swing elements & swings through or to handstand (2 sec.).
 - Strength elements and hold elements (2 sec.).
 - Swing to Strength hold elements (2 sec.).
 - Dismounts.
- One Swing to handstand element (2 s. hold) is required in the exercise and must be inside 8 counting elements.
- Repeated elements (same Code Identification Number)
 - Repeated elements cannot contribute to the D-score. On Rings, this rule is extended so that not more than 3 elements from groups II and/or III can be presented in direct succession. The 4th and subsequent elements from



Group II and/or III of the same sequence will be considered as repetition, and not recognized by the D-Jury.

- b) If the gymnast decides to execute more elements from Element Groups II and/or III, in order to be recognized by the D-Jury, he must perform at least a B value swing element from elements Group I (except any kind of kip/back kip, or element in the same Code box) between the first sequence of maximum 3, and another element or sequence from Element Groups II and/or III. This swing element of at least a B value must be recognised and among the 8 best.
- c) All elements performed from EGII or EGIII contribute to this rule whether they are inside the counting eight (8) elements or not, even if the element is not recognised due to poor technical execution.

4. Special repetitions:

- a) Repeated elements (same Code Identification Number) cannot contribute to the D-score. On Rings, this rule is extended so that a maximum of 1 final strength position in each EG may be recognized for difficulty. Thus, for example only two cross type elements (regular, L cross, or V cross) or support scale type elements (regular or straddled) are permitted in an exercise for difficulty value (one in Group II and one in Group III).
- b) Basic support positions, i.e. L sit and V sit are not included in the special repetition rule as they are deemed to be different strength elements. It is possible to perform uprise forward to L sit and uprise forward to V sit. However, it would not be possible to perform more than one final strength position in each element group, i.e. Kip to L sit and uprise to L sit.

5. Additional information and regulations:

- a) Strength holds positions that deviate from the correct body, arm or leg position by greater than 45° will not be recognized. Examples: Cross with shoulder angle >45°, support scale with hip bend of >45°.
- b) Strength presses and lifts which follow a previous hold element and end in a 2 second hold position are recognized only if the preceding hold part has been recognized and if a stop position is shown.
- c) Swing elements that lead to strength hold elements which must reverse direction (i.e. front uprise to Swallow; front uprise to inverted cross and so on ...) will be counted as two elements.
- d) All V hold positions (2 sec.) must be performed with legs vertical.
- e) Elements with crossing of the cables or to "Li Ning" hanging position are not permitted, being deducted as composition errors.
- f) For juniors, elements which include saltos backward in hang are not permitted.
- g) A dorsal hang to Cross is not an acceptable entry position to elevate its value (or any other strength element). If the cross is performed directly from a dorsal hang, it will retain its independent Code of Points value of C.
- h) Where a gymnast performs either a Yamawaki or Jonasson element directly to a swing to a held handstand then the element will be upgraded by one letter. The swing to handstand must be within the counting 8 elements.
 - Jonasson swing to handstand = D + C
 - Yamawaki, Jonasson, swing to handstand = B + D + C

Article 12.2.3 Element Performance applicable to D & E score

1. All hold positions must be held for a minimum of 2 seconds. A hold is achieved when the whole body reaches a static position including the shoulders and feet. A hold part will not be recognized by the D-Jury for Difficulty and/or Element Group requirement if no stop is shown.
2. Jonasson/Yamawaki type elements should be performed with continuous movement and with shoulders above Ring height. If a clear support phase is shown the element will not be recognized and receive 0.5 deduction. In this case, the element cannot be split into Honma and roll forward to hang. These elements performed either with an interruption (medium) or slowly (small) will be recognized but deducted accordingly.
3. During swings to a hold position or during strength presses, the shoulders and/or the body may not rise above the perfect hold position >5°. If the deviation from perfect position is greater than 45° the element will not be recognized and receive 0.5 deduction. In this case, the final hold position CAN be recognized if performed to the technical requirements.

Example:

- From cross press above 45° to swallow will receive a 0.5 deduction and a D value for the swallow if performance criteria is fulfilled.
 - Salto fwd. to cross with an entry position above 45° will receive a 0.5 deduction and a C value for the cross if performance criteria is fulfilled.
4. During swings to handstands or swing to a hold positions, the lowering of legs, from the initial entry position, of greater than 45° will lead to non-recognition and receive 0.5 deduction.
 5. A strength press from hang must be performed slowly, with straight arms and a straight body to avoid deduction or classification as swing to strength. The press should start in a hang position with arms and body vertical and straight. If an arm bend or body bend of greater than 45° is shown the element will not be recognized and receive 0.5 deduction. See Article 9.2.4.8 for other angular deductions
 6. A Swallow should be performed in a horizontal position, with a perfectly straight body and with the middle of the shoulders in line with the bottom of the Rings. The arms should be wide and with no contact to the upper body. Touching of the arms will lead to a small deduction, clear support of the body with the arms a medium deduction.
 7. A support scale will be recognized if the shoulder is completely above the top of Rings. The body should be in a perfectly straight horizontal position. The position of the arms, i.e. slightly wide or hands turned out does not define the value of the element.



8. Nakayama type elements must be performed slowly and pass through a complete hanging scale rearwards to prevent execution deductions and potential non-recognition
9. When performing a press from one hold position to another hold position the expectation is to see a distinct movement of the body (more than a body width). If the press does not commence from a perfect position the element will be subject to execution deductions. If there is a minimal body movement only the final hold element will be recognized.
Example:
 - Hanging scale rearwards press to swallow
 - Swallow press to support scale
10. Kip type elements are swinging elements that should be initiated from a deep fold, followed by a clear dynamic swing action. A kip element, i.e. element III 47, performed with minimal fold and use of strength rather than swing will be deducted.
11. Slow roll type elements i.e. Azarian, must be performed with a consistently slow roll and with a straight body throughout. Any variation will lead to E-Jury deductions and potentially non-recognition.
12. For a further list of regulations governing non-recognition of elements and other aspects of the D-score, see Section 7 and the summary of deductions in Article 7.6.

Article 12.2.4 Bending of the Arms

If a swing to strength element is performed with an excessive arm bend (>90°) a deduction of 0.5 will be applied. This error will also lead to non-recognition of the element.

The final hold part will be recognised if it fulfils the technical requirements.

Example, back uprise to straddle support scale with excessive arm bend will not be recognised but the final straddle support scale can be awarded an A value.

Article 12.3 Specific Deductions for Rings



D-Jury

Error	Small 0.10	Medium 0.30	Large 0.50
No swing to handstand.		●	

E-Jury

Error	Small 0.10	Medium 0.30	Large 0.50
Legs apart or other poor execution during jump or lift to Rings.		●	
Pre-swing before start of exercise.		●	
Coach gives gymnast an initial swing.	●		
Layaway on the back swing.		●	
Slow, interruption or support phase during Jonasson and Yamawaki	●	●	● NR
Hold of a non-listed part for 2 s. or more.	each time		
Compositional errors.		●	
False grip (over grip) during strength holds (each time).	●		
Bent arms during swing to strength hold parts or to establish hold position.	●	●	●
Bent arms during hold and press to strength hold elements.	●	●	●
Touching cables or straps with arms, feet or other parts of body		●	
Supporting or balancing with feet or legs on cables.			●NR
Fall from handstand.			●NR
Excessive swing of cables.	per element		
Press to strength from preceding high hold position.	●	●	
Touching or support of arms against body during Swallow	●	●	
Swing with strength	●	●	

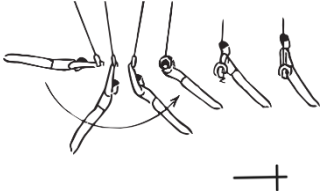
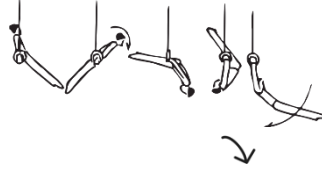
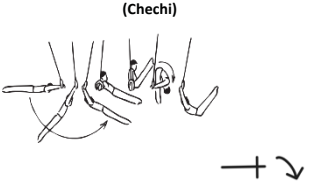
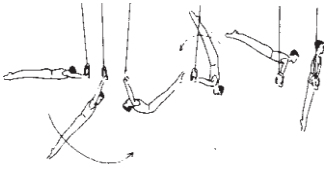
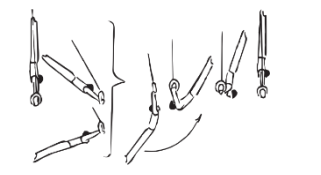
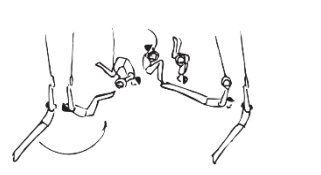

A = 0,1	B = 0,2	C = 0,3	D = 0,4	E = 0,5	F = 0,6 G = 0,7 H = 0,8
EG I: Kip and swing elements & swings through or to handstand					
1. Uprise fwd. to support. 	2.	3.	4.	5.	6.
7. From any support scale, swallow or swing bwd in support, roll forward to bwd swing in hang. 	8. Uprise fwd and counter salto fwd. to bwd swing in hang. (Chechi) 	9.	10.	11.	12.
13.	14.	15.	16.	17.	18.
19. From hang, felge upward to support. 	20. Swing fwd. through hdst. 	21. Tucked double salto bwd. to hang (Guczoghy) 	22. Piked or straight double salto bwd. to hang. (O'Neill) 	23.	24.

● Prohibited for juniors.

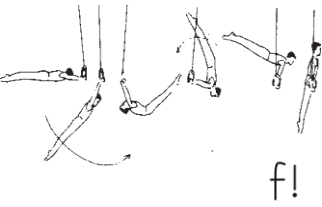
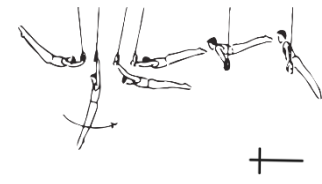
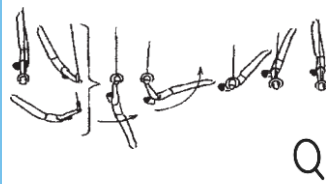
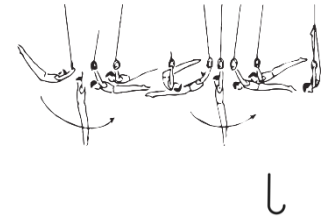
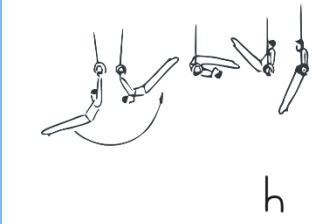
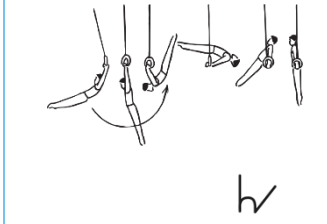
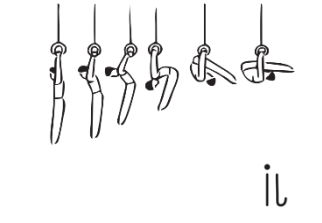
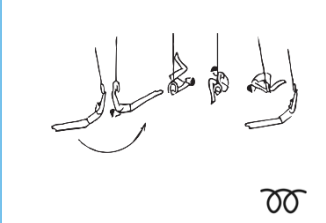
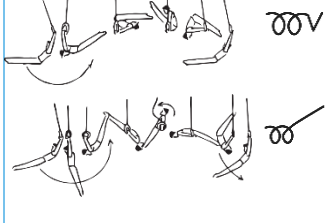

A = 0,1	B = 0,2	C = 0,3	D = 0,4	E = 0,5	F = 0,6 G = 0,7 H = 0,8
EG I: Kip and swing elements & swings through or to handstand					
25. Dislocate bwd. piked or straight.  f!	26.	27.	28.	29.	30.
31. Uprise bwd. to support.  +	32. Uprise bwd. str. through handstand.  Q	33.	34.	35.	36.
37. Inlocate piked or straight.  L	38. Backward swing to salto fwd. piked to support (Honma)  h	39. Honma straight.  h	40.	41.	42.
43. Slow inlocate from hang.  il	44. Double salto fwd. tucked to hang. (Yamawaki)  oo	45. Double salto fwd. piked or straight to hang. (Jonasson)  oo	46.	47.	48.



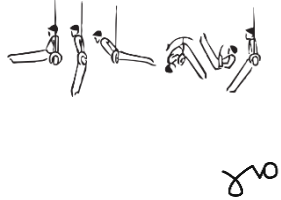
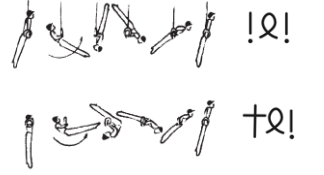

A = 0,1	B = 0,2	C = 0,3	D = 0,4	E = 0,5	F = 0,6 G = 0,7 H = 0,8
EG I: Kip and swing elements & swings through or to handstand					
49. Kip to support. 	50.	51.	52.	53.	54.
55. Back kip with bent arms to support. 	56. Back kip to support. 	57.	58.	59.	60.
61. Fwd. swing to swing bwd. in hang. 	62.	63. Bwd. swing, salto piked to support. 	64.	65.	66.
67. From support or cross, fclge bwd. piked or straight with bent arms to support. 	68.	69.	70.	71.	72.

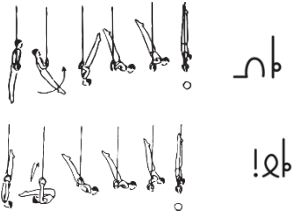
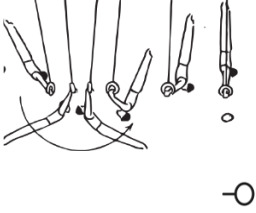
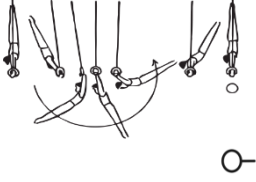
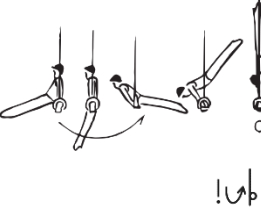
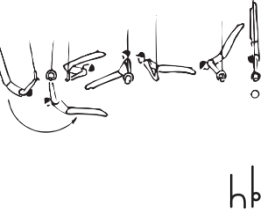
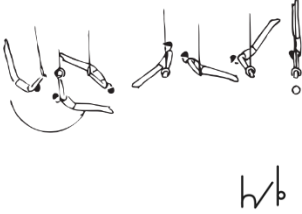

A = 0,1	B = 0,2	C = 0,3	D = 0,4	E = 0,5	F = 0,6 G = 0,7 H = 0,8
EG I: Kip and swing elements & swings through or to handstand					
73.	74. Back kip or roll bwd str. with bent arms to handstand (2 s.). 	75. Swing bwd. or giant swing bwd to handstand (2 s.). 	76.	77.	78.
79.	80.	81. Uprise bwd. or giant swing fwd to handstand (2 s.). 	82.	83.	84.
85.	86. From support swing bwd. to handstand (2 s.). 	87. Honma and swing bwd. to handstand (2 s.). 	88. Honma str. and swing bwd. to handstand (2 s.). 	89.	90.
91.	92.	93.	94.	95.	96.

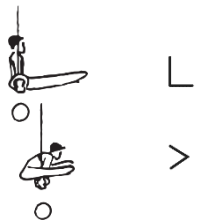

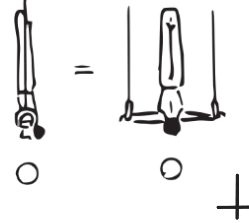
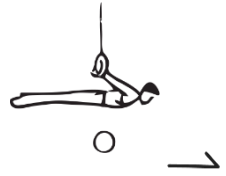
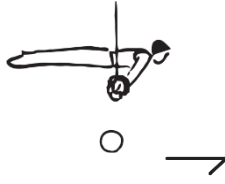
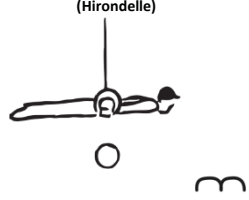
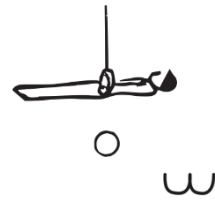
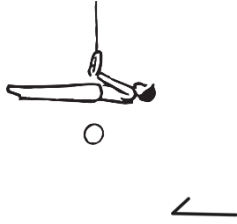
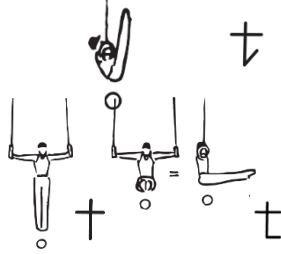
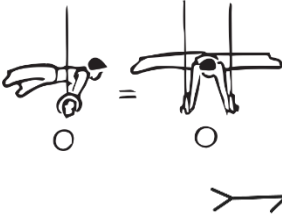
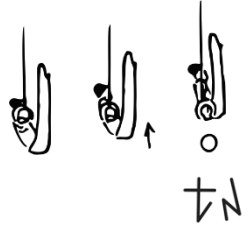
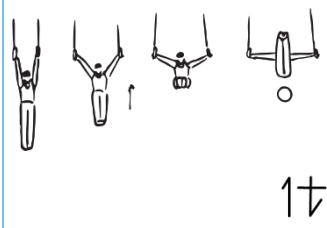
A = 0,1	B = 0,2	C = 0,3	D = 0,4	E = 0,5	F = 0,6 G = 0,7 H = 0,8
EG II: Strength elements and hold elements (2 sec.)					
1. L-sit (2 s.) or straddled L-sit (2 s.). 	2. V-sit (2 s.). 	3.	4. Inverted cross (2 s.) 	5.	6.
7. Hanging scale rearways (back lever) (2 s.). 	8.	9. Support scale (planche)(2 s.). 	10. Support scale at ring height (swallow or maltese cross) (2 s.). (Hirondelle) 	11. Inverted swallow (2 s.). 	12.
13. Hanging scale frontways (front lever) (2 s.). 	14..	15. Any cross (2 s.) or V cross (2 s.). 	16.	17.	18.
19. Support scale straddled (2 s.). 	20.	21.	22. V Cross, press to V-sit (2 sec.). (Tsukahara 3) 	23. Vertical pull up with str. arms to V-cross (2 s.). (Colak) 	24.



A = 0,1	B = 0,2	C = 0,3	D = 0,4	E = 0,5	F = 0,6 G = 0,7 H = 0,8
EG II: Strength elements and hold elements (2 sec.)					
25. Press to hdst. with bent body and bent arms (2 s) - Also straddle legs.	26. Press to hdst. with str. body a. bent arms or b. body. a. str. arms, or fr. strad. sup. lever (2 s.). - Also straddle legs.	27. Press to hdst. with str. body and str. arms from support or support scale (2 s.). 	28. Press to hdst. with str. body and str. arms from swallow (2 s.). 	29.	30.
31. Slow roll fwd. piked with bent arms, to support. 	32. Slow roll fwd. straight with bent arms, to support. 	33.	34.	35.	36.
37.	38. Slow roll bwd. slowly and straight. body to L sit (2 s.). 	39. Slow roll fwd. straight to cross or L-cross (2 s.). 	40.	41.	42.
43.	44.	45.	46.	47.	48.

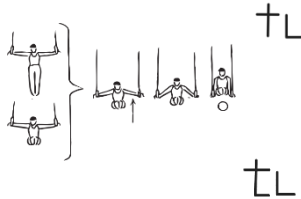
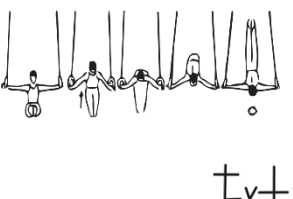
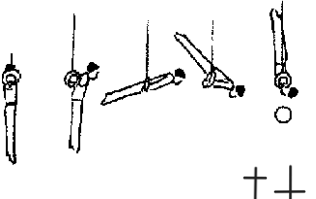
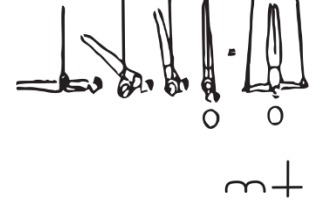
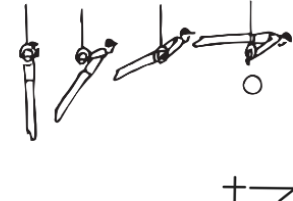
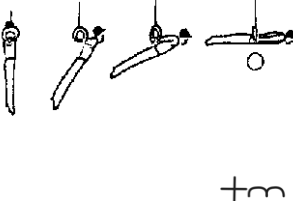
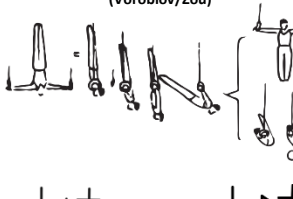
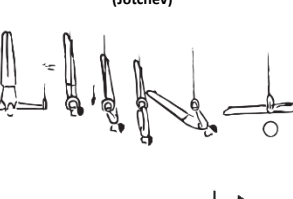

A = 0,1	B = 0,2	C = 0,3	D = 0,4	E = 0,5	F = 0,6 G = 0,7 H = 0,8
EG II: Strength elements and hold elements (2 sec.)					
73.	74.	75. From cross or L-cross, press to L-sit (2 s.). 	76.	77. From L-cross, press to inverted cross (2 s.). 	78. From cross, press with straight body to inverted cross (2 s.). 
79.	80.	81.	82.	83.	84. From swallow, press to inverted cross (2 s.). 
85.	86.	87.	88. From cross, press to planche without first going to support (2 s.). 	89. From cross, press to swallow (2 s.). 	90.
91.	92.	93.	94. From inverted cross lower slowly to inverted hang and felge bwd. slowly to cross (2 s.) (Vorobiov/Zou) 	95. From inverted cross lower slowly to inverted hang and felge bwd. slowly to swallow (2 s.) (Jotchev) 	96.

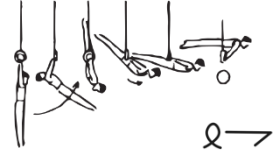
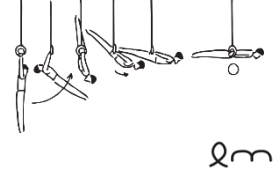
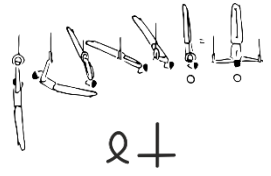
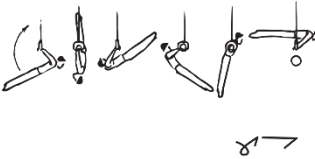
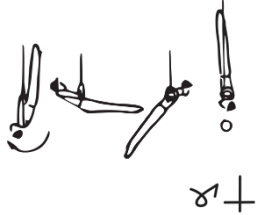
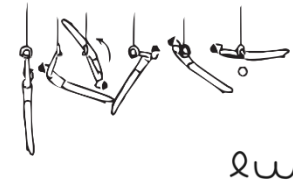

A = 0,1	B = 0,2	C = 0,3	D = 0,4	E = 0,5	F = 0,6 G = 0,7 H = 0,8
EG II: Strength elements and hold elements (2 sec.)					
97.	98.	99.	100.	101. Roll bwd. slowly with str. arms and body to free sup. scale (2 s.). 	102.
103.	104.	105.	106.	107. Slow Roll bwd. with str. body to swallow (2 s.). 	108. Roll backward slowly with straight arms and body to inverted cross through swallow. (Simonov) 
109.	110.	111.	112.	113.	114.
115.	116.	117.	118. Slow roll fwd. with straight body through cross and press to support scale without first going to support (2 s.). (Ng Kiu Chung 2) 	119. Slow roll fwd. with straight body through cross to inverted cross (2 s.). (Wynn) 	120. Azarian to inverted Swallow (2 s.). (Tulloch) 

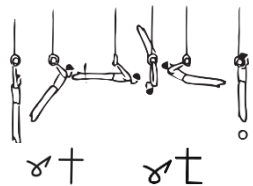
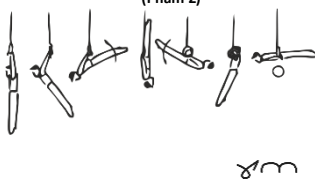
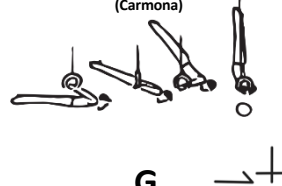
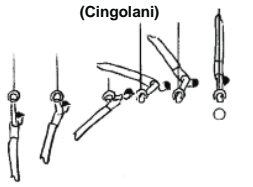
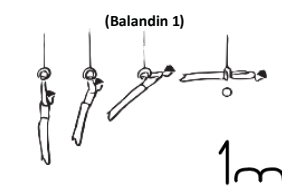
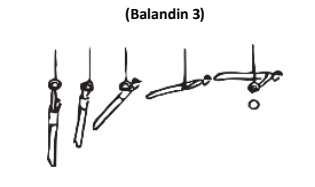
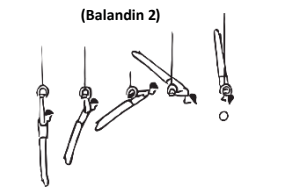

A = 0,1	B = 0,2	C = 0,3	D = 0,4	E = 0,5	F = 0,6 G = 0,7 H = 0,8
EG II: Strength elements and hold elements (2 sec.)					
121.	122.	123.	124. Slow roll fwd. with str. body to Cross or L-Cross (2 s.), also from inverted hang. (Davtyan) 	125. Slow roll forward with straight body through cross to swallow (2 sec.) wrong (Pham 2) 	126. Through hang rearways press and straight body to inverted cross (2 s.) (Carmona) 
127.	128.	129.	130. From hang vertical pull up support and press to hdst. with straight body and straight arms. (Cingolani) 	131.	132. From hang vertical pull up to swallow (2 s.). (Balandin 1) 
133.	134.	135.	136.	137. From hang vertical pull up thr. swallow to sup. scale (2 s.). (Balandin 3) 	138. From hang vertical pull up to inv. cross (2 s.). (Balandin 2) 
139.	140.	141.	142.	143.	144.





A = 0,1	B = 0,2	C = 0,3	D = 0,4	E = 0,5	F = 0,6 G = 0,7 H = 0,8
EG III: Swing to Strength hold elements (2 sec.)					
1.	2. Uprise fwd. to L-sit, (2 s.). +L	3. Uprise fwd. to V-sit (2 s.). +N	4.	5.	6.
7.	8. Kip to L-sit (2 s.). NL	9. Kip to V-sit (2 s.). NL	10.	11.	12.
13.	14. Honma to L-sit (2 s.). hL	15. Honma to V-sit (2 s.). (Garcia) hN	16. Honma to cross / L-cross (2 s.). ht ht	17. Honma to V cross (2 s.). (Tanaka) ht	18.
19.	20.	21.	22. Bwd. swing, salto fwd p. to cross or L-cross (2s.). st st	23.	24.

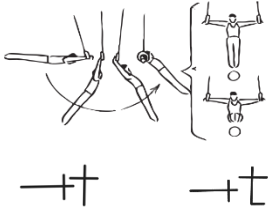
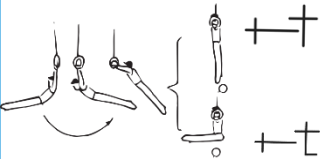
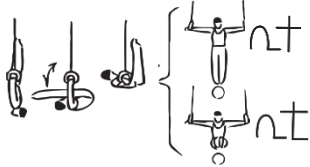
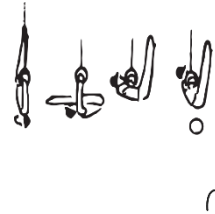
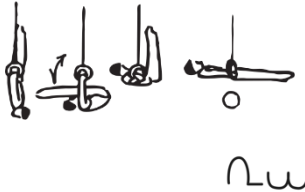
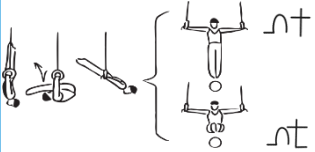
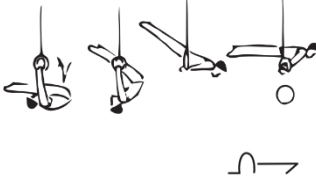
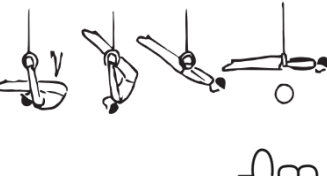

A = 0,1	B = 0,2	C = 0,3	D = 0,4	E = 0,5	F = 0,6 G = 0,7 H = 0,8
EG III: Swing to Strength hold elements (2 sec.)					
25.	26.	27. Uprise fwd. to cross or L-cross (2 s.). 	28.	29.	30.
31.	32.	33. Uprise bwd. to cross or L-cross (2 s.). 	34.	35.	36.
37.	38.	39. Kip to cross, or L-cross (2 s.). 	40. Kip to V cross (2 s.). (Molinari) 	41.	42. Kip to inverted swallow (2 s.). 
43.	44.	45. Back kip to cross or L-cross (2 s.). 	46. Back kip to support scale (2 s.). 	47. Back kip to swallow (2 s.). 	48.

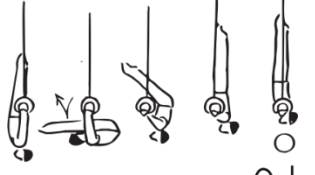

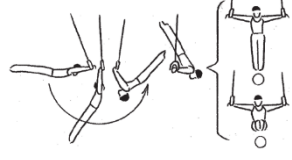
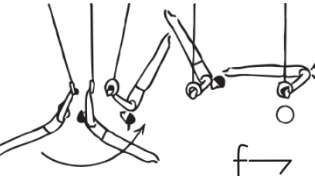
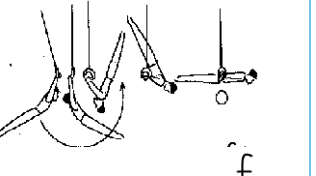
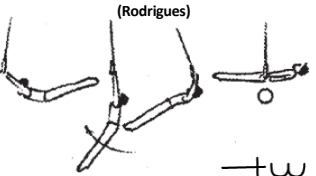
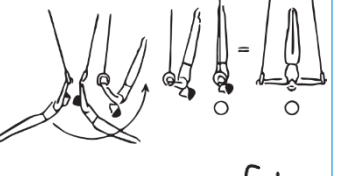
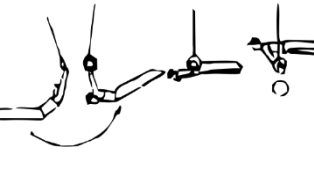
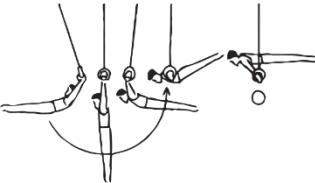
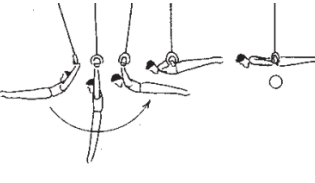
A = 0,1	B = 0,2	C = 0,3	D = 0,4	E = 0,5	F = 0,6 G = 0,7 H = 0,8
EG III: Swing to Strength hold elements (2 sec.)					
49.	50. Felge upward to support with straddled legs supported above the rings (2 s.).  f>	51.	52.	53. Back kip to inverted cross (2 s.).  f+	54.
55.	56. Felge upward to support scale straddled (2 s.).  f>	57. Felge upward to cross or L-cross (2 s.).  ft ft	58. Felge upward to support scale (2 s.).  f>	59. Felge upward to Swallow (2 s.).  fm	60. Uprise forward. to inverted swallow (2 s.).  (Rodrigues) +w
61.	62.	63.	64.	65. Felge upward to invert. cross (2 s.).  ft	66.
67.	68. Uprise bwd. to support scale straddled (2 s.).  +>	69.	70. Uprise bwd. to support scale (2 s.).  +>	71. Uprise bwd. to sup. scale at ring height (2 s.).  +3	72.



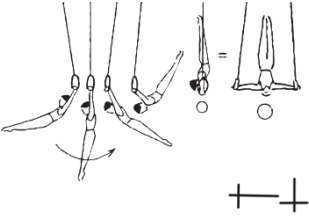
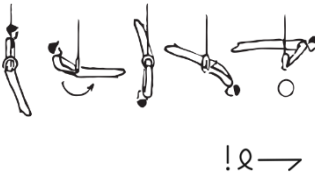



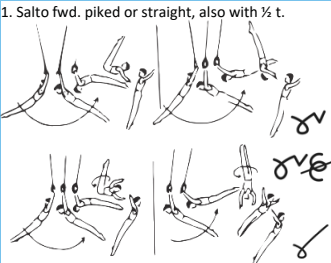
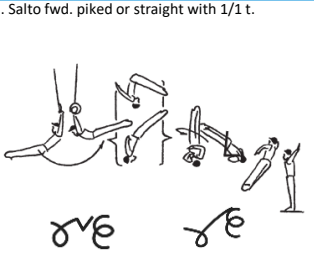
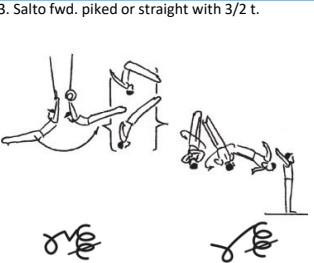
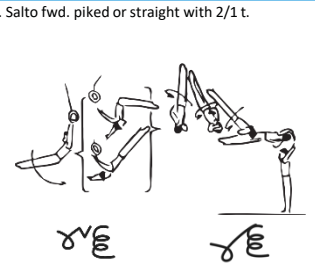
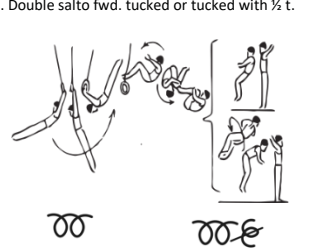
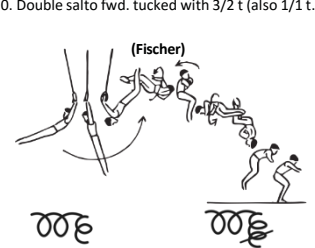
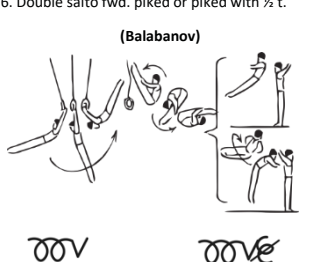
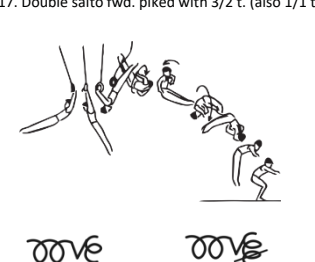

A = 0,1	B = 0,2	C = 0,3	D = 0,4	E = 0,5	F = 0,6 G = 0,7 H = 0,8
EG III: Swing to Strength hold elements (2 sec.)					
73.	74.	75.	76.	77. Uprise bwd. to inverted cross (2 s.). 	78.
79.	80.	81.	82. Felge bwd. straight to free sup. scale. (2 s.) 	83.	84.
85.	86.	87.	88.	89.	90.
91.	92.	93.	94.	95.	96.

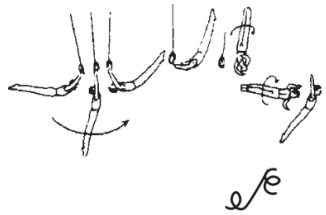
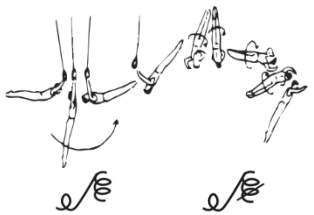
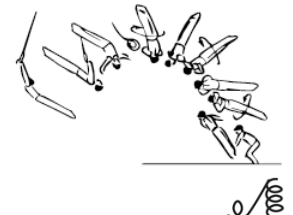

A = 0,1	B = 0,2	C = 0,3	D = 0,4	E = 0,5	F = 0,6 G = 0,7 H = 0,8
EG IV: Dismounts					
1. Salto fwd. piked or straight, also with ½ t. 	2. Salto fwd. piked or straight with 1/1 t. 	3. Salto fwd. piked or straight with 3/2 t. 	4. Salto fwd. piked or straight with 2/1 t. 	5.	6.
7.	8.	9. Double salto fwd. tucked or tucked with ½ t. 	10. Double salto fwd. tucked with 3/2 t. (also 1/1 t.) 	11.	12.
13.	14.	15.	16. Double salto fwd. piked or piked with ½ t. 	17. Double salto fwd. piked with 3/2 t. (also 1/1 t.). 	18.
19.	20.	21.	22.	23.	24.

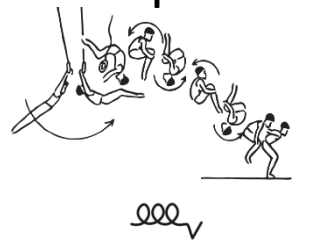

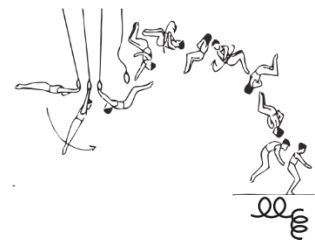
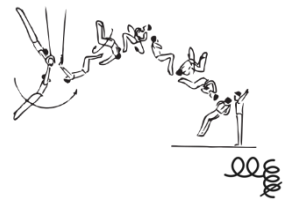
A = 0,1	B = 0,2	C = 0,3	D = 0,4	E = 0,5	F = 0,6 G = 0,7 H = 0,8
EG IV: Dismounts					
25. Salto bwd. piked or straight also with $\frac{1}{2}$. 	26. Salto bwd. straight with 1/1 t. 	27. Salto bwd. straight with 2/1 t. or 3/2 t. 	28.	29. Salto bwd. straight with 3/1 t. 	30.
31.	32. Double salto bwd. tucked or piked. 	33. Double salto bwd. straight. 	34.	35.	36. Triple salto bwd. tucked. G 
37.	38.	39.	40.	41.	42. Triple salto bwd. piked. I 
43.	44.	45. Double salto bwd. t. with $\frac{1}{2}$ or 1/1 t.  Double salto bwd. t. with 3/2 t. 	46.	47. Double salto bwd. t. with 2/1 t. 	48. Double salto bwd. t. with 5/2 t. 

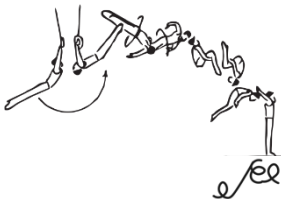
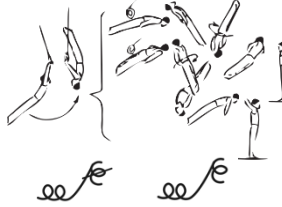
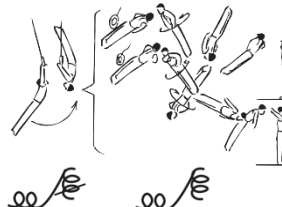

A = 0,1	B = 0,2	C = 0,3	D = 0,4	E = 0,5	F = 0,6 G = 0,7 H = 0,8
EG IV: Dismounts					
49.	50.	51. Salto bwd. str. with 1/1 t. and salto t. 	52. Double salto bwd. straight with 1/2 or 1/1 t. 	53.	54. Double salto bwd. straight with 3/2 or 2/1 t. 
55.	56.	57.	58.	69.	60.
61.	62.	63.	64.	65.	66.
67.	68.	69.	70.	71.	72.



Section 13

Vault

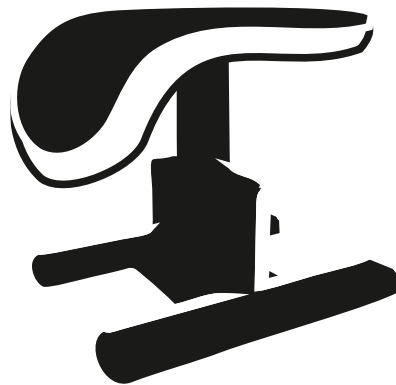

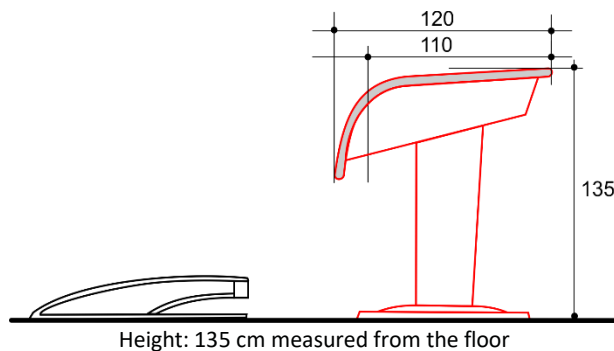

Article 13.1 Description of a Vault

The gymnast must perform one vault except in Qualifications for Vault Finals and in Vault Finals, where he must show two vaults from different Vault Groups. Each vault begins with a run and a takeoff from both feet (with or without a round off) to the vault board with legs together and is executed with a brief support phase on the table with two hands. The vault may contain single or multiple turns around the two axes of the body. After the first vault, the gymnast returns without delay to the starting position and, at the signal of the D1 judge, performs his second vault.

Article 13.2 Content and construction

Article 13.2.1 Information about Vault Presentation

1. The gymnast must begin vault from a still stand with legs together, at a maximum distance of 25 meters measured from the front edge of the table to the inner side of the block attached to the end of the vault run up mat. The vault begins with the first step or hop of the gymnast, but the evaluation begins the moment his feet contact the vaulting board. The length of the approach must be marked on or alongside the approach lane.
2. The vault ends with a landing behind the table in a standing position with legs together facing either towards or away from the table (frontways or rearways).
3. The gymnast may take-off only forwards or backwards and with legs together. The only element that may be performed before the vaulting board is a round off. For such vaults, the use of the vaulting board safety "collar" is mandatory and must be provided by the competition organizer. For round off entry vaults, the gymnast may use one official handy-mat provided only by the organizer.
4. Vaults with saltos during the first flight phase and vaults with straddled legs during the second flight phase are neither listed nor permitted.
5. The gymnast must show the intended body position (tucked, piked, or straight) in a distinct and unmistakable manner. Indistinct body positions are deducted by the E-Jury and may result in recognition as a lower value vault by the D-Jury.
6. Basis for the Evaluation by the E-Jury:
 - a) 1st flight phase: from the spring board up to support with two hands on the table.
 - b) Support phase: from the moment of contact on the table to the point when the hands leave the table.
 - c) 2nd flight phase: including the push off from the table up to the point of preparation for landing.
 - d) Landing phase: from the preparation for landing to the final standing position.
 - e) The E-Jury must take the deductions phase by phase.

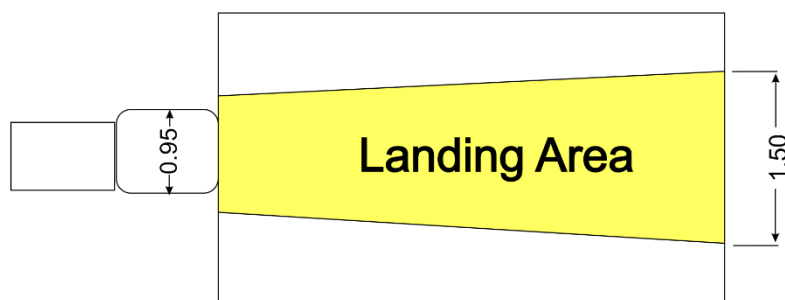
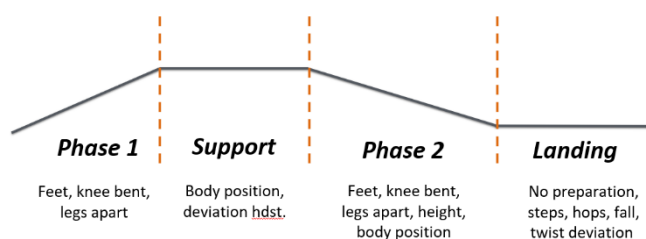

7. Landing Rules:

- a) The gymnast must land with both feet within an area marked left and right of the extended centre line of the table as described in the following drawing.

These lines must be clearly marked on the landing mat. Stepping on the line, but not over the line, is permitted.

The mat containing the marked landing zone for alignment must be securely fastened so that it cannot shift during competition.

- b) Twisting during vaults must be completed before landing. Incomplete twists result in the appropriate deduction, and if incomplete by 90° or more, will result in non-recognition by the D-Jury and in recognition as a vault with a lower Difficulty Value.
 - c) There will be no line deduction if a gymnast travels past the end of the landing mat. Normal line deductions will be taken if they step or hop outside of the Landing zone marking strips prior to moving off the end of the mat.
8. In the 2nd flight phase, the gymnast must show a conspicuous rise in height of his center of gravity at the moment of hand push-off.
9. All Vaults must display a distinct opening phase in preparation for landing. A landing that is not prepared is a sign of an error in technique and will usually result in a technical execution deduction as well as a landing deduction.
10. For a full list of errors and deductions governing Vault presentation see, Section 9 and the summary of deductions in Articles 9.4 and 13.3.

Article 13.2.2 Information about the D-score

1. The gymnast must show one vault in Qualifications, Team Final and the All-Around Final. In the Qualification for Vault Final and in Vault Finals he must show two vaults, which must be from different Vault Groups.

Group I	Single salto vaults with complex twists.
Group II	Handspring salto vaults with or without simple twists, and all double salto fwd.
Group III	Handspring sideways and Tsukahara vaults with or without simple twists, and all double salto bwd.
Group IV	Round off entry and single salto vaults with complex twists.
Group V	Round off entry vaults with or without simple twists, and all double salto fwd. or bwd.

2. Each vault is listed, numbered, and given a value in the Difficulty Tables within its Group. The following general principles apply:

- a) Cuervo vaults have the same value as equivalent Handspring Salto vaults with twists.
- b) Kasamatsu vaults have the same value as the equivalent Tsukahara vaults.
- c) Yurchenko vaults have the same value as the analogous Tsukahara or Kasamatsu vaults.
- d) Unless otherwise indicated, round off entry vaults with ½ turn to the table have a value of 0.20 more than the analogous forward approach vaults.
- e) Unless otherwise indicated, round off entry vaults with ¾ or 1/1 turn to the table have a value of 0.60 more than the analogous Tsukahara vaults.

3. Each vault is given a unique Difficulty Value based on its complexity.

4. Prior to the execution of each vault, the appropriate vault number, as assigned in the Code of Points must be displayed for the D-Jury. This function is performed by the gymnast, or an assistant, with the aid of a flashboard and is not penalized in the case of error.

Example: #319 - The #3 designates the vault group; the #19 designates the vault number within that vault group.

5. The gymnast must show the intended body position (tucked, piked, or straight) in a distinct and unmistakable manner. Non-distinct body positions may result in non-recognition by the D-Jury or recognition as a vault with a lower Difficulty Value. (see the body position definitions in Appendix A Section 3). The gymnast must display the vault number for the vault that he can do, not the one he hopes to do. This warning applies especially for the recognition of straight and piked positions.

6. The placement mat may be used for round off entry vaults only, and is optional.

7. The vault is invalid (0.00 point from the D-Jury and the E-Jury) when:

- a) The vault is executed without a support phase, i.e., neither hand or only one hand touches the table.
- b) Failure to use the safety collar for round off entry vaults.
- c) The vault is so poorly executed that the intended vault cannot be recognized, or the gymnast pushes from the table with his/ her feet.
- d) Spotting assistance during the vault.
- e) The gymnast does not land with his feet first. This means that at least one foot must contact the landing mat before any other part of the body.
- f) The gymnast lands intentionally in a side stand.
- g) The gymnast performs a prohibited vault (straddled legs in the second flight phase, salto in the first flight phase, prohibited pre-element before the vaulting board, etc.).
- h) The first vault is repeated for the second vault in Qualification for Vault Final or in Vault Final.

A video review by D-Jury and Apparatus Supervisor will automatically occur for every vault receiving an Invalid "0" Score. All E Juryjudges enter their deductions after every vault performed. The D Jury will notify them in the case of a "0" vault and advise them of the method to present a "0" E-score.



8. For Vaults performed with a Round off 1/2 turn in the first flight, it is possible to be deducted for insufficient turn. Normal deductions will be taken as per the table of errors for incomplete twist. In extreme cases if the lack of turn is greater than 90° from the correct position, the Vault will be recognized as a Yurchenko style Vault.
9. During the 30 second warm up, each gymnast is permitted 2 Vaults (maximum). This applies during any phase of the competition where the warm up is occurring on the podium. The gymnast is entitled to their 2 warm up Vaults even if the 30 second warm up time has expired.
- The Line Judge will be responsible for ensuring that the 2 Vault maximum is respected. Failure to respect the 2 Vault maximum rule will result in a neutral deduction of 0.3 taken from the first Vault.
10. In **Qualifications, Team Final, and All-Around Final**:
- One vault must be performed.
 - In Qualification, the 1st vault score counts toward the Team and/ or All-Around Total.
- For Qualifications and in the Apparatus Final**, each gymnast must perform two different vaults which must be from different Vault Groups **In Qualifications and in the Apparatus Final**, the average score of the 2 vaults will determine the Final score for the gymnast.
11. Additional run approaches are permitted as follows, with deduction of 1.00 for empty run (if gymnasts has not touched the springboard or apparatus).
- When 1 vault is required, a second run approach is permitted with deduction. Third approach not permitted.
 - When 2 vaults are required, a third run approach is permitted with deduction. Fourth approach not permitted.

Article 13.3 Table of Specific Errors and Deductions for Vault

D-Jury

Error	Small 0.10	Medium 0.30	Large 0.50
Landing or touching with one foot or one hand outside the landing area.	-0.10 from the Final score		
Touching with feet, hands, foot and hand or with any other part of the body outside of the landing area.	-0.30 from the Final score		
Landing directly outside the landing area.	-0.30 from the Final score		
Exceeding 25 meter run for Vault.	-0.50 from the Final score by the D1 judge		
Illegal or invalid vaults.	Score of 0,00 for the vault		
Failure to use vault board safety collar for round off entry vaults.	Score of 0,00 for the vault		
Repeating 1 st vault in Qualifications or in Vault-Final.	Score of 0,00 for the vault		
Repeating a vault from the same group in Qualifications or in Vault- Final.	-2.00 points deduction for the 2nd vault		
More than 2 Vaults performed during the warm up	-0.30 from the first Vault if two Vaults performed - Qualifications and Apparatus Finals		
Additional run approach.	-1.00 point deduction for the vault concerned		

E-Jury

Error	Small 0.10	Medium 0.30	Large 0.50
Execution errors in 1 st flight.	●	●	●
Technical errors in 1 st flight.	●	●	●
Passing the handstand position not through the vertical.	●	●	●
Execution errors in 2nd flight.	●	●	●
Technical errors in 2nd flight.	●	●	●
Insufficient height, no conspicuous rise of the body.	●	●	●
Lack of extension in preparation for landing.	●	●	
Low landing positions with hips below the knees.			●





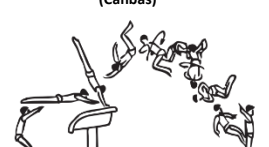









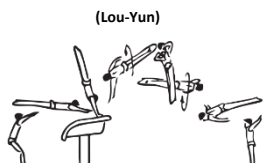

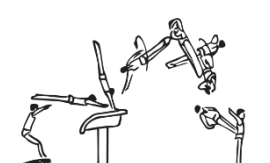

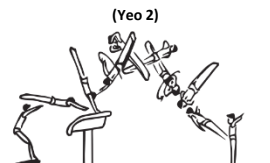













FIG MAG Vault Value Table 2025-2028

#	Value	EGI	#	Value	EG II	#	Value	EGIII	#	Value	EGIV	#	Value	EGV
101	3.2	Hdspr. tucked 1/1t.(Cuervo t.w.1/2t.)	201	1.6	Handspring	301	1.6	Hdspr. sw. 1/4t.	401	1.6	Rou. off, hdspr. bwd.	501	1.8	Rou. off, 1/2t. hdspr.
102	3.6	Hdspr. tucked 3/2t.(Kroll)	202	1.8	Hdspr. 1/2t.	302	1.8	Hdspr. 3/4t.	402	1.8	Rou. off, hdspr. bwd. 1/2t.	502	2.0	Rou. off, 1/2t. hdspr. 1/2t.
103	4.0	Hdspr. tucked 2/1t.(Canbas)	203	2.0	Hdspr. 1/1t.	303	2.0	Hdspr. sw. 5/4t.	403	2.0	Rou. off, hdspr. bwd. 1/1t.	503	2.2	Rou. off, 1/2t. hdspr. 1/1t.
107	3.6	Hdspr. piked 1/1t.	204	2.2	Hdspr. 3/2t.	307	2.2	Tsuk. Tucked.(Tsukahara)	407	2.2	Rou. off, tucked salto.(Yurchenko)	504	2.6	Rou. off, 1/2t. tucked.
108	4.0	Hdspr. piked 3/2t.	205	2.4	Hdspr. 2/1t.	308	2.4	Tsuk. piked.	408	2.4	Yur. tucked 1/2t.	505	3.0	Rou. off, 1/2t. tucked. 1/2t.
113	4.0	Hdspr. str. 1/2t.(Cuervo str.)	206	2.6	Hdspr. 5/2t.(Tsygnkov)	309	2.4	Tsuk. tucked 1/2t.	409	2.8	Yur. tucked 1/1t.	507	3.0	Rou. off, 1/2t. piked.
114	4.4	Hdspr. str. 1/1t.(Cuervo str.1/2t.)	207	2.4	Hdspr. tucked.	313	3.2	Tsuk. str.	410	3.2	Yur. tucked 3/2t.	508	3.4	Rou. off, 1/2t. piked. 1/2t.(Namov)
115	4.8	Hdspr. str. 3/2t.(Lou Yun)	213	2.8	Hdspr. piked.	314	3.6	Tsuk. str. 1/2t.	411	3.6	Yur. tucked 2/1t.	509	3.8	Rou. off, 1/2t. str.
116	5.2	Hdspr. str. 2/1t.(Cuervo str.3/2t.)	219	3.6	Hdspr. str.	319	5.2	Tsuk. dbl. tucked.(Yeo)	413	2.4	Yur. piked.	510	4.2	Rou. off, 1/2t. str. 1/2t.(Hutcheon)
117	5.6	Hdspr. str. 5/2t.(Yeo 2)	225	5.2	Hdspr. dbl. salto.(Roche)	320	5.6	Tsuk. dbl. piked.(Lu Yu Fu)	414	3.2	Yur. str.	511	4.6	Rou. off, 1/2t. str. 1/1t.
118	6.0	Hdspr. str. 3/1t.(Yang Hak Seon)	226	5.6	Roche 1/2t.(Dragulescu)	321	6.0	Tsuk. dbl. 1/1t.(Ri Se Gwang)	415	3.6	Yur. str. 1/2t.	512	5.0	Rou. off, 1/2t. str. 3/2t.
119	2.8	Tsuk. tucked 1/1t.(Kasamatsu)	228	5.6	Hdspr. 1/2t. bwd.(Zimmerman)				416	4.0	Yur. str. 1/1t.	513	5.4	Rou. off, 1/2t. str. 2/1t.
120	3.2	Tsuk. tucked 3/2t.	231	5.6	Hdspr. dbl. piked.(Blanik)				417	4.4	Yur. str. 3/2t.	514	5.8	Rou. off, 1/2t. str. 5/2t.(Li Xiao Peng)
121	3.6	Tsuk. tucked 2/1 t.(Barbieri)	232	6.0	Dragulescu piked.(Ri Se Gwang2)				418	4.8	Yur. str. 2/1t.	519	5.4	Rou. off, 1/2t. dbl. salto.
122	4.0	Tsuk. tucked 5/2 t.							419	5.2	Yur. str. 5/2t.(Shewfelt)			
125	4.0	Tsuk. str. 1/1 t.							420	5.6	Yur. str. 3/1t.(Shirai-KIM, Hee HOON)			
126	4.4	Tsuk. str. 3/2 t.							421	6.0	Yur. str. 7/2t.(Shirai 2)			
127	4.8	Tsuk. str. 2/1 t.(Akopian)							425	5.2	Yur. dbl. tucked.(Melissanidis)			
131	5.2	Tsuk. str. 5/2 t.(Driggs)							426	5.6	Yur. dbl. piked.(Yang Wei)			
132	5.6	Tsuk. str. 3/1 t.(Lopez)												
133	6.0	Tsuk. str. 7/2 t.(Yonekura)												
138	2.8	Hdspr. tucked. 1/2t.(Cuervo t.)												
144	3.2	Hdspr. piked. 1/2t.(Cuervo p.)												







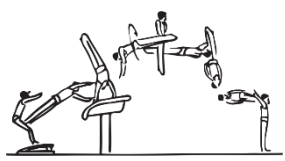

EG I: Single salto vaults with complex twists

<p>101. HdSpr. fwd. and salto fwd. t. w. 1/1 t. (Cuervot. w. ½ t.).</p>  <p>3.2 </p>	<p>102. HdSpr. fwd. and salto fwd. t. w. 3/2 t. (Kroll) (Cuervo t. w. 1/1 t.).</p>  <p>3.6 </p>	<p>103. HdSpr. fwd. and salto fwd. t. w. 2/1 t. (or Cuervo t. w. 3/2 t.).</p>  <p>4.0 </p>	<p>104.</p>	<p>105.</p>	<p>106.</p>
<p>107. HdSpr. fwd. and salto fwd. p. w. 1/1 t. (Cuervo p. w. ½ t.).</p>  <p>3.6' </p>	<p>108. HdSpr. fwd. and salto fwd. p. w. 3/2 t. (Cuervo p. w. 1/1 t.).</p>  <p>4.0 </p>	<p>109.</p>	<p>110.</p>	<p>111.</p>	<p>112.</p>
<p>113. HdSpr. fwd. and salto fwd. str. w. ½ t. (Cuervo str.).</p>  <p>4.0 </p>	<p>114. HdSpr. fwd. and salto fwd. str. w. 1/1 t. (Cuervo str. ½ t.).</p>  <p>4.4 </p>	<p>115. HdSpr. fwd. and salto fwd. str. w. 3/2 t. (Lou-Yun) (Cuervo str. w. 1/1 t.).</p>  <p>4.8 </p>	<p>116. HdSpr. fwd. and salto fwd. str. w. 2/1 t. (Cuervo str. 3/2 t.).</p>  <p>5.2 </p>	<p>117. Handspring fwd. and salto fwd. str. w. 5/2 t. (Yeo 2)</p>  <p>5.6 </p>	<p>118. Handspring fwd. and salto fwd. str. w. 3/1 t. (Yang Hak Seon)</p>  <p>6.0 </p>
<p>119. HdSpr. sw. w. ¼ t. a. salto fwd. t. w. ½ t. or Tsuk. t. w. 1/1 t. (Kasamatsu)</p>  <p>2.8 </p>	<p>120. Tsukahara t. w. 3/2 t. or Kasamatsu t. ½ t.</p>  <p>3.2 </p>	<p>121. Tsukahara t. with 2/1 t. (Barbieri)</p>  <p>3.6 </p>	<p>122. Tsukahara t. with 5/2 t. (Shirai 3)</p>  <p>4.0 </p>	<p>123.</p>	<p>124.</p>











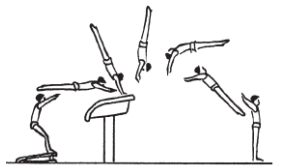

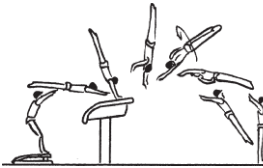
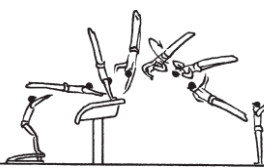
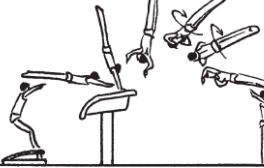
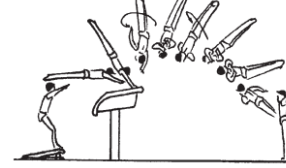

EG I: Single salto vaults with complex twists

<p>125. Tsukahara str. w. 1/1 t. or Kasamatsu str.</p>  <p>4.0 <i>XeE</i></p>	<p>126. Kasamatsu str. with 1/2 t. or Tsukahara str. w. 3/2 t.</p>  <p>4.4 <i>XeE</i></p>	<p>127. Kasamatsu str. w. 1/1 t. or Tsukahara str. w. 2/1 t</p> <p>(Akopian)</p>  <p>4.8 <i>XeE</i></p>	<p>128.</p>	<p>129.</p>	<p>130.</p>
<p>131. Kasamatsu str. with 3/2 t.</p> <p>(Driggs)</p>  <p>5.2 <i>XeE</i></p>	<p>132. Kasamatsu str. with 2/1 t.</p> <p>(López)</p>  <p>5.6 <i>XeE</i></p>	<p>133. Kasamatsu str. with 5/2 t. or Tsukahara str. with 7/2 t.</p> <p>(Yonekura)</p>  <p>6.0 <i>XeE</i></p>	<p>134.</p>	<p>135.</p>	<p>136.</p>
<p>137.</p>	<p>138. Hdsp. fwd. and salto fwd. t. w. 1/2 t. (or Cuervo t.)</p>  <p>2.8 <i>ve</i></p>	<p>139.</p>	<p>140.</p>	<p>141.</p>	<p>142.</p>
<p>143.</p>	<p>144. Hdsp. fwd. and salto fwd. p. w. 1/2 t. (Cuervo p.)</p>  <p>3.2 <i>ve</i></p>	<p>145.</p>	<p>146.</p>	<p>147.</p>	<p>148.</p>

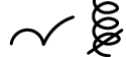



EG II: Handspring salto vaults with or without simple twists, and all double salto fwd.

<p>201. Forward handspring.</p> 	<p>202. Forward handspring with 1/2 t.</p> 	<p>203. Forward handspring with 1/1 t.</p> 	<p>204. Forward handspring with 3/2 t.</p> 	<p>205. Forward handspring with 2/1 t.</p> 	<p>206. Forward handspring with 5/2 t. (Tsygankov)</p> 
<p>1.6</p> 	<p>1.8</p> 	<p>2.0</p> 	<p>2.2</p> 	<p>2.4</p> 	<p>2.6</p> 
<p>207. Handspring fwd. and salto fwd. tucked.</p> 	<p>208.</p>	<p>209.</p>	<p>210.</p>	<p>211.</p>	<p>212.</p>
<p>213. Handspring fwd. and salto fwd. piked.</p> 	<p>214.</p>	<p>215.</p>	<p>216.</p>	<p>217.</p>	<p>218.</p>
<p>219. Handspring fwd. and salto fwd. str.</p> 	<p>220.</p>	<p>221.</p>	<p>222.</p>	<p>223.</p>	<p>224.</p>
<p>3.6</p> 					





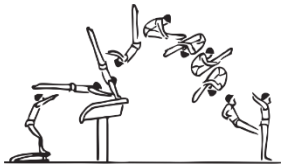
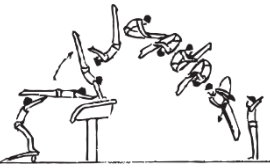



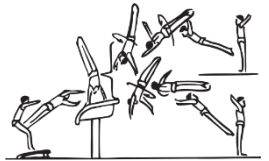
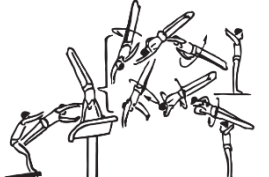

EG II: Handspring salto vaults with or without simple twists, and all double salto fwd.

<p>225. Handspring fwd. and dbl. salto fwd. t. (Roche)</p>  <p>5.2</p>	<p>226. Roche with ½ turn. (Dragulescu)</p>  <p>5.6</p>	<p>227.</p>	<p>228. Handspring fwd. and salto fwd. t. w. ½ t. and salto bwd. t. (Zimmerman)</p>  <p>5.6</p>	<p>229.</p>	<p>230.</p>
<p>231. Handspring fwd. and dbl. salto fwd. piked. (Blanik)</p>  <p>5.6</p>	<p>232. Dragulescu piked. (RI Se Gwang 2)</p>  <p>6.0</p>	<p>233.</p>	<p>234.</p>	<p>235.</p>	<p>236.</p>
<p>237.</p>	<p>238.</p>	<p>239.</p>	<p>240.</p>	<p>241.</p>	<p>242.</p>
<p>243.</p>	<p>244.</p>	<p>245.</p>	<p>246.</p>	<p>247.</p>	<p>248.</p>

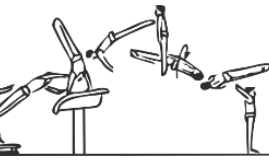















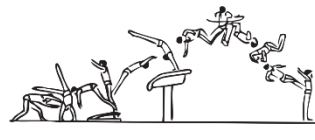

EG III: Handspring sideways and Tsukahara vaults with or without simple twists, and all double salto bwd.

<p>301. Handspring sw. with ¼ t.</p>  <p>1.6 <i>α</i></p>	<p>302. Handspring sw. with 3/4 t.</p>  <p>1.8 <i>αε</i></p>	<p>303. Handspring sw. with 5/4 t.</p>  <p>2.0 <i>αεε</i></p>	<p>304.</p>	<p>305.</p>	<p>306.</p>
<p>307. Handspring sw. w. ¼ t. a. salto bwd. t. (Tsukahara)</p>  <p>2.2 <i>αε</i></p>	<p>308. Tsukahara piked.</p>  <p>2.4 <i>αεν</i></p>	<p>309. Tsukahara t. with ¼ t.</p>  <p>2.4 <i>αεε</i></p>	<p>310.</p>	<p>311.</p>	<p>312.</p>
<p>313. Tsukahara straight.</p>  <p>3.2 <i>αελ</i></p>	<p>314. Tsukahara str. with ¼ t.</p>  <p>3.6 <i>αελε</i></p>		<p>316.</p>	<p>317.</p>	<p>318.</p>
<p>319. Tsukahara with salto bwd. t. (Yeo)</p>  <p>5.2 <i>αεεε</i></p>	<p>320. Tsukahara with salto bwd. piked. (Lu Yu Fu)</p>  <p>5.6 <i>αεεν</i></p>	<p>321. Double Tsukahara with 1/1 twist. (Ri Se Gwang)</p>  <p>6.0 <i>αεεεε</i></p>	<p>322.</p>	<p>323.</p>	<p>324.</p>





EG IV: Round off entry and single salto vaults with complex twists.

401. Round off, handspring bwd.  1.6 λn	402. Round off, handspring bwd. with 1/2 turn.  1.8 $\lambda n e$	403. Round off, handspring bwd. with 1/1 turn.  2.0 $\lambda n e$	404.	405.	406.
407. Round off, hdspr. bwd. and salto bwd. t. (Yurchenko)  2.2 $\lambda n e$	408. Yurchenko t. with 1/2 t.  2.4 $\lambda n e e$	409. Yurchenko t. with 1/1 t.  2.8 $\lambda n e e$	410. Yurchenko t. with 3/2 t.  3.2 $\lambda n e e e$	411. Yurchenko t. with 2/1 t.  3.6 $\lambda n e e e$	412.
413. Yurchenko piked.  2.4 $\lambda n e v$	414. Yurchenko straight.  3.2 $\lambda n e l$	415. Yurchenko straight with 1/2 t.  3.6 $\lambda n e l e$	416. Yurchenko straight with 1/1 t.  4.0 $\lambda n e l e$	417. Yurchenko straight with 3/2 t.  4.4 $\lambda n e l e e$	418. Yurchenko straight with 2/1 t.  4.8 $\lambda n e l e e$
419. Yurchenko straight with 5/2 t. (Shewfelt)  5.2 $\lambda n e l e e e e$	420. Yurchenko Straight 3/1 t. (Shirai - KIM Hee Hoon)  5.6 $\lambda n e l e e e$	421. Yurchenko Straight 7/2 t. (Shirai 2)  6.0 $\lambda n e l e e e e e$	422.	423.	424.



























EG IV: Round off entry and single salto vaults with complex twists.

<p>425. Yurchenko and salto bwd. tucked. (Melissanidis)</p>  <p>5.2 knee</p>	<p>426. Melissanidis piked. (Yang Wei)</p>  <p>5.6 knee</p>	<p>427.</p>	<p>428.</p>	<p>429.</p>	<p>430.</p>
<p>431.</p>	<p>432.</p>	<p>433.</p>	<p>434.</p>	<p>435.</p>	<p>436.</p>
<p>437.</p>	<p>438.</p>	<p>439.</p>	<p>440.</p>	<p>441.</p>	<p>442.</p>
<p>443.</p>	<p>444.</p>	<p>445.</p>	<p>446.</p>	<p>447.</p>	<p>448.</p>



EG V: Round off entry vaults with or without simple twists, and all double salto fwd. or bwd.

<p>501. Round off, ½ t. and handspring fwd.</p>  <p>1.8 λen</p>	<p>502. Round off, ½ t. and hdspr. fwd. with ½ t.</p>  <p>2.0 λene</p>	<p>503. Round off, ½ t. and hdspr. fwd. with 1/1 t.</p>  <p>2.2 λene</p>	<p>504. Round off, ½ t. and hdspr. fwd. and salto fwd. tucked.</p>  <p>2.6 λenσ</p>	<p>505. Round off, ½ t. and hdspr. fwd. and salto fwd. tucked with ½ t.</p>  <p>3.0 λenσe</p>	<p>506.</p> 
<p>507. Round off, ½ t. a. hdspr. fwd. and salto fwd. p.</p>  <p>3.0 λenσv</p>	<p>508. Round off, ½ t. and hdspr. fwd. and salto fwd. p. with ½ t. (Nemov)</p>  <p>3.4 λenσve</p>	<p>509. Round off, ½ t. and hdspr. fwd. and salto fwd. str.</p>  <p>3.8 λeneλ</p>	<p>510. Round off, ½ t. and hdspr. fwd. and salto fwd. str. with ½ t. (Hutcheon)</p>  <p>4.2 λeneλe</p>	<p>511. Round off, ½ t. and hdspr. fwd. and salto fwd. str. with 1/1 t.</p>  <p>4.6 λeneλe</p>	<p>512. Round off, ½ t. and hdspr. fwd. and salto fwd. straight with 3/2 t.</p>  <p>5.0 λeneλe</p>
<p>513. Round off, ½ t. and hdspr. fwd. and salto fwd. straight with 2/1 t.</p>  <p>5.4 λeneλe</p>	<p>514. Round off, ½ t. and hdspr. fwd. and salto fwd. str. with 5/2 t. (Li Xiao Peng)</p>  <p>5.8 λeneλe</p>	<p>515.</p> 	<p>516.</p> 	<p>517.</p> 	<p>518.</p> 
<p>519. Round off, ½ t. a. hdspr. fwd. and double salto fwd. tucked.</p>  <p>5.4 λenσσ</p>	<p>520.</p> 	<p>521.</p> 	<p>522.</p> 	<p>523.</p> 	<p>524.</p> 



Section 14

Parallel Bars

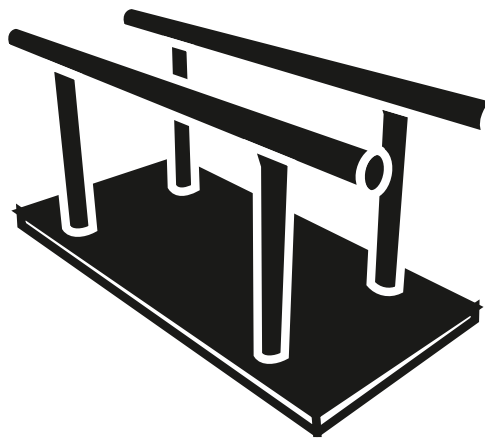

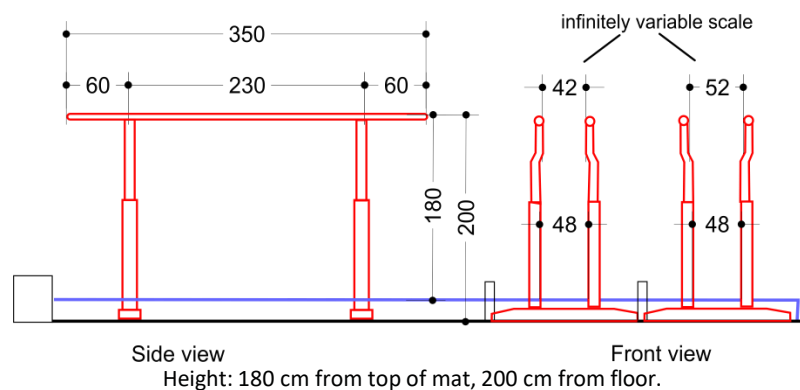

Article 14.1 Exercise Description

A contemporary Parallel Bar exercise consists predominantly of swing and flight elements selected from all available Element Groups and performed with continuous transitions through various hang and support positions in such a way as to reflect the full potential of the apparatus.

Article 14.2 Content and Construction

Article 14.2.1 Information about Exercise Presentation

1. The gymnast must initiate his Parallel Bar mount or his run-up from a still stand with legs together. The exercise begins the moment the feet leave the ground. Swinging with one leg or stepping into the mount is not permitted. The feet must leave the ground simultaneously.
2. A vaulting board placed at the height of the regulation landing mats is permitted for the mount.
3. Pre-elements are not permitted. This means that any element that rotates more than 180° around any body axis may not be performed prior to grasping the rail or rails with the hands.
4. Additional execution and exercise construction expectations are:
 - a) Back swings in support or upper arm hang that do not lead to at least a value part but simply reverse direction and swing back down in or to a lower hang or support position are deducted, i.e:
 - Back swing in upper arm hang, layaway to glide kip.
 - Back swing in support, layaway to front uprise.
 - Back swing in support, layaway to hang.
 - Back swing in support to handstand (also with 2 sec), layaway to upper arm hang, hang or support.
 - Glide kip to upper arm hang or to momentary support and lay back to upper arm hang.
 - From handstand, lower to shoulder roll forward.

After swing to handstand, next element must continue in same direction (1/2 turn, Gatson, Healy, etc)
 - b) No extra support is allowed during elements with turns on one arm support. Elements such as giant swing with turn, backward uprise with turn, forward uprise with full turn, Felge elements with turn, etc. will be considered finished where the extra support occurs.
 - c) All elements in hang followed by kips must be executed with straight legs.
 - d) The following elements or groups of elements are not permitted:
 - Strength and hold elements that are not listed in the difficulty tables.
 - Saltos and dismounts from side hang on one bar.
 - Saltos with reception in upper arms and/or bent arms support for juniors.
 - e) Elements performed to one bar (Chiarlo, Piasecky, etc..) must be executed to a handstand with hands slightly apart. A slight deviation of the shoulders/body is permitted because of the unnatural hand position. Deductions will be taken for excessive hand separation and/or body deviation.
 - f) On all Moy and Giant bwd. swings, legs may not bend until body is horizontal.
 - g) The deduction for lack of extension before regrasping after saltos means the extension (opening) should be at horizontal (bar height).
 - h) A front uprise should be performed with the back horizontal with the bars, an angle of up to 45° to horizontal will have a small deduction and below 45° a medium deduction.
 - i) A front uprise to L sit can be deducted for lack of amplitude in the uprise, 0.1 or 0.3.
 - j) For elements that are defined as finishing in a handstand, such as Diamidov, the gymnast must clearly show the handstand position (with straight arms) before proceeding into elements such as long hang or upper arm support. Otherwise the element may not be recognized.
5. For a full list of errors and deductions governing Exercise Presentation, see Section 9 and the summary of deductions in Articles 9.4 and 14.3.

Article 14.2.2 Information about the D-score

1. The Element Groups (EG) are:

- I. Elements starting in upper arm position.
- II. Elements in support or through support on 2 bars.
- III. Long swings in hang on 1 or 2 bars and underswings.
- IV. Dismounts.

2. Information on difficulty value:

- a) For elements which include turns, the turns are not recognized as part of the element if the turn happens after the handstand position or after a hop to handstand. Examples: Felge with inlocation and hop to handstand with turn or giant swing half turn with hop to handstand followed by turns.
- b) Unless otherwise indicated, elements that deliberately regrasp in bent arm support are considered to have the same identification number and value as elements which regrasp in upper arm hang. However, elements that are initiated from bent arm support are considered to have the same identification number and value as elements from or through support.

Unless otherwise indicated in the difficulty tables, elements performed from or to unusual or rotated grip positions (supinated or pronated) have the same identification number and value as analogous elements performed from or to the usual grip position.

3. Additional information and regulations:

- a) Many swinging elements lead, to or are defined to, a handstand on one or two rails. The handstands from swing need not be held, but the element must be performed in a manner that convincingly demonstrates that the handstand position could have been held if so desired.
- b) Special rule: Elements to one bar in cross support have the same value as done to two bars, except they increase by one value more when connected to Healy type elements (each Healy element also increases by one value) hold is allowed in the one bar handstand.
- c) Elements to one bar upgrade the value if is connected to Healy type elements, but only if the Healy element is executed without large deduction.
- d) No straddle element to one bar can receive an increase in difficulty value, i.e. Tippelt, Arican, etc.
- e) How to evaluate Makuts type elements with a pause or stop during the first part of the element:

Performance	D-Jury	E-Jury
Pause after first part of element	Give value	-0.10 for Pausing or Stopping in Handstand
One second hold after first part of element (less than 2 seconds)	Give value	-0.30 for Pausing or Stopping in Handstand
Two second hold after first part of element	No value	-0.50 for Pausing or Stopping in Handstand

For example: Makuts to handstand with less than a one second hold after the $\frac{3}{4}$ Diamidov and then $\frac{3}{4}$ Healy = E value and 0.1 for pausing or stopping in handstand.

- f) All Healy must have 360° turns to be recognized as a Healy type element, beginning from two or one bar crossways. Note: A $\frac{3}{4}$ Healy, from sideways position, is a B value and same box as Element I.62.
- g) Performance expectation of Bhavsar. This element should be performed to regrasp with an open shoulder angle and straight body at horizontal. If the gymnast regrasps with a body position of more than 45° from horizontal and/or a 90° angle in the shoulder, no value will be given and a single large deduction will be taken.
Healy and Makuts type turns and salto forward to support type elements, with an extreme arm bend (greater than 90 degrees.) upon catching, will not be recognized for value.
- i) A double salto forward with a $\frac{1}{2}$ turn may be performed for value with either a late turn or an early turn on the $\frac{1}{2}$ twist.
- j) Tippelt performance expectations. The Tippelt is considered a swing element and as such must be performed with continuous movement. The legs must rise upon regrasp to the handstand position with no dropping of the legs or visible use of strength. Dropping of the legs, interruption in the upward movement or visible use of strength can result in execution deductions and possible non-recognition of the element.
- k) Performance expectations of Felge elements with turns. Felge with full turn, III.114, should be performed direct to handstand and without an additional hand placement. Felge with half turn, included in III.113 should be performed with max only one placement before arriving in completed handstand. If the Felge is performed with two or more hand placements it will be valued as III.112 Felge with quarter turn.



4. Special repetitions:

- a) Elements with saltos: an exercise can not include more than one body/regrasp position variation of the same element (within the same EG). In this case the element with the highest difficulty value will be counted for difficulty.

Some examples:

- Morisue tuck or Morisue pike.
- Belle tuck or Belle pike.
- 5/4 Salto fwd straddled to up. arm hang or to bent arm support or directly to hang.

For clarification, the following elements collectively are included I.53, I.54, III.70, III.71, III.77 and III.83 in this rule.

- b) Maximum two Giant Swings through handstand (III.21, III.22, III.29, III.30, III.42, III.46, III.48).
 c) Maximum two Felge Swings through handstand (III.112, III.113, III.114, III.120, III.125, III.126, III.136, III.137, III.143).
 d) Maximum two front uprise through handstand st style elements (I.5, I.6, I.11, I.12, I.15, I.17, I.18)

5. For a further list of regulations governing non-recognition of elements and other aspects of the D-score, see Section 7 and the summary of deductions in Articles 9.4 and 14.3.

Article 14.3 Specific Deductions for Parallel Bars

D-Jury

Error	Deduction
Non respect of the official warm up time (50").	-0.30 from the Final Score (D1 judge) for individual competition or -1.00 from Team's Total Score for team competition.

E-Jury





Error	Small 0.10	Medium 0.30	Large 0.50
One leg step or swing on mount.		●	
Layaway on the back swing.		●	
Not controlled momentary handstand positions on 1 or 2 rails.	●		
Elements Chiarlo type, excessive hand separation and/or body deviation (each).	●	●	●
Pre-element.			●
Lack of extension at horizontal or uncontrolled regrasping after saltos.	●	●	●
Stepping or hand adjustments in handstand.	● each time		
Moy and giants, bent legs before horizontal body.	●	●	
After Bhavsar or similar horizontal regrasping elements to hang glide kip with bent legs.		●	



A = 0,1	B = 0,2	C = 0,3	D = 0,4	E = 0,5	F = 0,6 G = 0,7 H = 0,8
EG I: Elements starting in upper arm position					
1. Forward uprise to support. +	2. Fwd. uprise and straddle cut bwd to handstand. +> p	3. Fwd. uprise and straddle cut bwd to hang. +> i	4.	5. Fwd. uprise with 1/2 t. to handstand. +S	6. Fwd. uprise with Stützkehr 3/4 t. or 1/4 t. to handstand followed by a kip on one rail +B
7. Fwd. uprise with 1/4 t. to hang on 1 rail. +↑ o	8. Roll bwd. with 1/2 t. from upper arm hang or Fwd. uprise to Kato hop to support. (Watanabe) +Ka +e	9.	10.	11. Fwd. uprise to Makuts to upper arm. +Mk	12. Fwd. uprise to Makuts to support. (Tsolakidis 1) G +Mk
13.	14. Roll bwd. to handstand with straight arms. + p	15. Back toss from upper arm with 1/4 turn to one rail (Kovtun) + p	16.	17. Fwd. uprise with 1/1 t. to handstand. (Richards) + d	18. Fwd. uprise with 3/2 t. to handstand. (Tsolakidis 2) + d
19.	20. Salto bwd. with straddled. cut to upper arm hang. + o	21. Roll bwd. with straddled cut to support. + o	22.	23.	24. Roll bwd. with salto bwd. tuck to upper arm hang. (Dimitrenko) + o

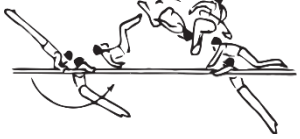

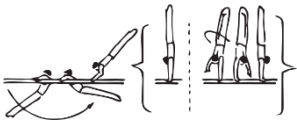
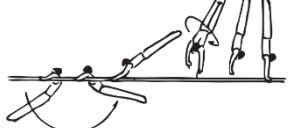
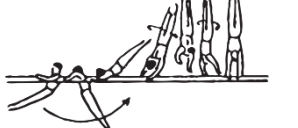

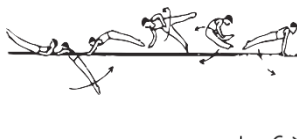

● Prohibited for juniors.



A = 0,1	B = 0,2	C = 0,3	D = 0,4	E = 0,5	F = 0,6 G = 0,7 H = 0,8
EG I: Elements starting in upper arm position					
25.	26.	27.	28.	29.	30. Roll bwd. with salto bwd. pike to upper arm hang (Li Xiaopeng)  G ● G
31.	32.	33.	34. Roll bwd. with ½ t. tuck to upper arm hang. (Harada)  ● + 2	35. Roll bwd. with ½ t. tuck to hang. (Dalton)  + 2 i	36.
37.	38. Bwd. uprise to handstand (or with ½ t).  + b e	39. Bwd. uprise with ½ t. hop to handstand.  + 2 b	40. Bwd. uprise with ½ t. hop to handstand on 1 rail.  + 2 b	41.	42.
43.	44. Bwd. uprise with ½ t. and straddle cut bwd. to upper arm hang.  + e >	45. Bwd. uprise with ½ t. a. straddled cut bwd. to support.  + e >	46.	47.	48.

● Prohibited for junior

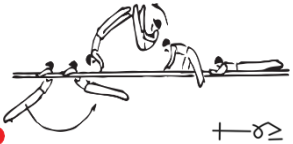
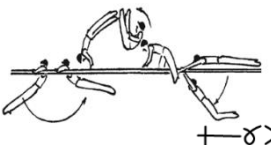

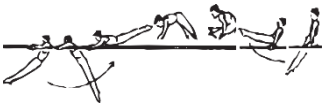
A = 0,1	B = 0,2	C = 0,3	D = 0,4	E = 0,5	F = 0,6 G = 0,7 H = 0,8
EG I: Elements starting in upper arm position					
49.	50. Bwd. uprise with ½ t. to support.	51. Bwd. uprise and 5/4 salto fwd. t. to upper arm hang (Yamawaki)	52. Bwd. uprise and salto fwd. pike or straight to support.	53.	54. Bwd. uprise and double salto fwd. tuck to upper arm hang.
	 + ⊕	 ● + ⊘ + ⊘ ^v	 + ⊘		 ● + ⊘⊘
55.	56.	57.	58.	59. Bwd. uprise and 5/4 salto fwd. straddled to upper arm hang. (Pakhniuk 1)	60. Bwd. uprise and 5/4 salto fwd. straddled to hang. (Pakhniuk 2)
				 ● + ⊘ ≥	 + ⊘ > i
61. Bwd. uprise and straddled cut or flank over to support. bent arm.	62. Bwd. uprise and straddled cut or flank over to support straight arm.	63.	64.	65.	66.
 + > 7	 + >				
67.	68.	69.	70.	71.	

Prohibited for juniors.

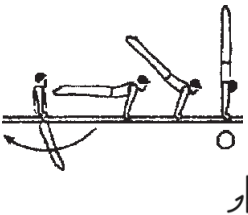
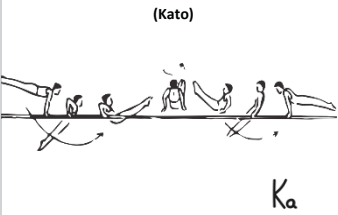
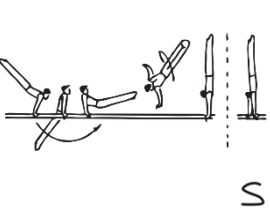
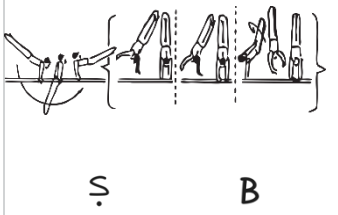
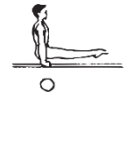
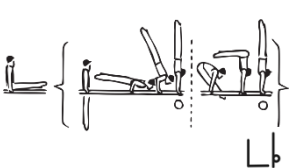
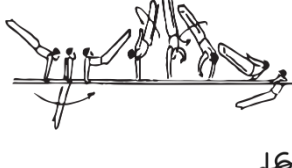
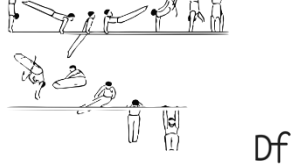
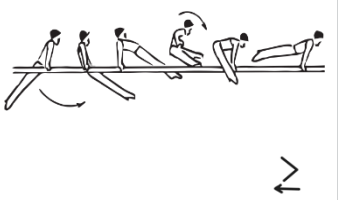
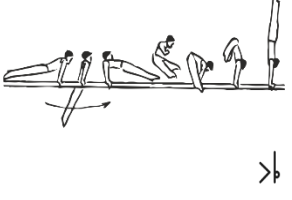
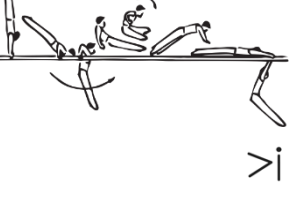
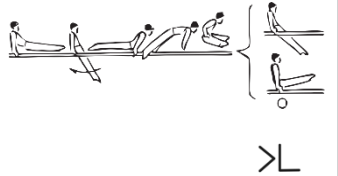

A = 0,1	B = 0,2	C = 0,3	D = 0,4	E = 0,5	F = 0,6 G = 0,7 H = 0,8
EG II: Elements in support or through support on 2 bars					
<p>1. Any swing to handstand</p>  <p style="text-align: center;">jb</p>	<p>2. Bent arm swing fwd. to hop ½ t. to support. (Kato)</p>  <p style="text-align: center;">Ka</p>	<p>3. Stützkehr fwd. to handstand (to 1 or 2 bars).</p>  <p style="text-align: center;">S</p>	<p>4. Stützkehr fwd. to handstand (1 rail (also with additional ¼ or ½ turn to handstand) (Bilozherchev - Peters) (Dimic)</p>  <p style="text-align: center;">S B</p>	5.	6.
<p>7. Any L-sit on 1 or 2 rails (2 s.)</p>  <p style="text-align: center;">L</p>	<p>8. Any press with bent arm straight. body, or str. arm bent. body to handstand., on 1 or 2 rails (2 s.) also straddled</p>  <p style="text-align: center;">Lb</p>	<p>9. Diamidov and ½ turn to upper arms. (Salazar)</p>  <p style="text-align: center;">de</p>	<p>10. ¼ Diamidov and rear vault to side hang on 1 bar. (De Freitas)</p>  <p style="text-align: center;">Df</p>	11.	12.
<p>13. Straddle cut bwd. to support.</p>  <p style="text-align: center;">></p>	<p>14. Straddle cut bwd. to handstand.</p>  <p style="text-align: center;">>b</p>	<p>15. Straddle cut bwd. directly to hang (Babos)</p>  <p style="text-align: center;">>i</p>	16.	17.	18.
<p>19. Straddle cut fwd. to support or L-sit (2 s.)</p>  <p style="text-align: center;">>L</p>	20.	21.	22.	23.	24.

● Prohibited for juniors.





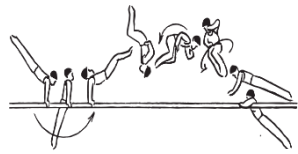

A = 0,1	B = 0,2	C = 0,3	D = 0,4	E = 0,5	F = 0,6 G = 0,7 H = 0,8
EG II: Elements in support or through support on 2 bars					
25.	26.	27. Swing fwd. with 1/1 t. on 1 arm to handstand. (Diamidov) d d	28. Diamidov with ¼ or ½ t. to handstand. de	29.	30.
31.	32. Swing fwd. with 1/1 t. to upper arm hang. (Carminucci) Se	33. Makuts to upper arm hang or ¼ Diamidov ¼ Healy to support. Mk	34. Swing forward with 5/4 t. on one arm through handstand. and Healy to upper arm. Z	35. ¼ Diamidov & ¼ Healy on the other hand to support (Makuts) Mk	36. Swing forward with 5/4 t. on one arm through handstand. and Healy to support. (Zonderland) Z
37.	38. Swing fwd. to handstand, hop to support. (Carballo) Ca	39. Salto bwd to handstand. Also to one rail. e	40. Salto backward with straddle cut to support. e/	41.	42.
43.	44.	45. Salto bwd. with ½ t. to upper arm hang. (Toumilovich) ● Tu	46. Salto bwd to handstand 1 rail (<u>connected to Healy type element</u>). (Rumbutis) e	47. Double salto tuck to upper arm hang. (Morisue) ● ee	48. Double salto pike to up. arm hang. (Huang Liping) ● ee

Prohibited for juniors.



A = 0,1	B = 0,2	C = 0,3	D = 0,4	E = 0,5	F = 0,6 G = 0,7 H = 0,8
EG II: Elements in support or through support on 2 bars					
49.	50.	51.	52.	53. 3/2 salto bwd. with 1/2 t. to upper arm hang. (Suarez)  ● Su	54. Double salto backwards with half turn to upper arm. (Kuavita)  ● G ll e
55.	56. Handstand. with 1/4 t. and fall back to support with 1/4 t.  k	57. Handstand. with 1/4 t. and fall back to support with 1/4 t. (Brändström)  k	58.	59.	60.
61.	62. Stützkehr bwd. to support.  b	63. Stützkehr bwd. through handstand. to support. (Novikov)  b k	64.	65.	66.
67.	68.	69. Stützkehr bwd. with straddle cut bwd. to support  b >	70.	71.	72.

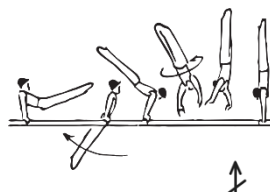
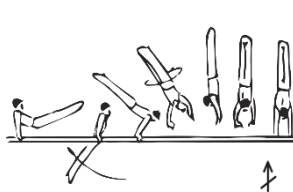
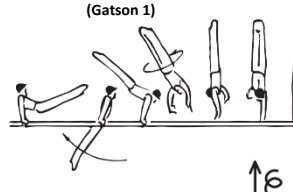
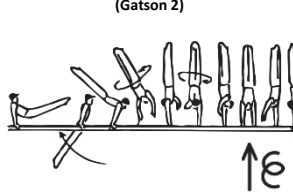
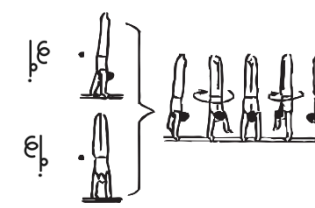
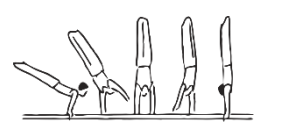
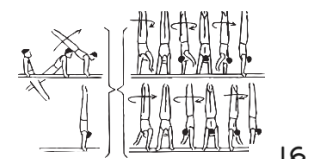

A = 0,1	B = 0,2	C = 0,3	D = 0,4	E = 0,5	F = 0,6 G = 0,7 H = 0,8
EG II: Elements in support or through support on 2 bars					
73. Healy to upper arm hang (also from handstand on 1 rail).	74. Following a swing element (min. B) to handstand, handstand on 1 rail, Healy to upper arm hang.	75. Healy to support (also from handstand on 1 rail).	76. Following a swing element (min. B) to handstand on 1 rail, Healy (360° or more) to support.	77..	78.
	 Min. B	 (Healy)			
b	b	h	h		
79.	80..	81. Swing bwd. with ½ t. hop to handstand.	82. Swing bwd. with ¾ t. hop to handstand.	83. Swing bwd. with 1/1 t. hop to handstand.	84. Gatson 1 with ¼ t to handstand on 1 rail and ¼ t. handstand on 2 rails.
				 (Gatson 1)	 (Gatson 2)
		↑	↑	↑ε	↑ε
85.	86. From handstand on 1 rail, ½ or ¾ t. fwd. or bwd. in handstand.	87.	88.	89.	90.
					
	ε				
91. Any handstand . with ½ turn. (also with 2 s.)	92. Any 1/1 pirouette in handstand on 2 rails.	93.	94.	95.	96.
					
ε	ε				







● Prohibited for juniors.

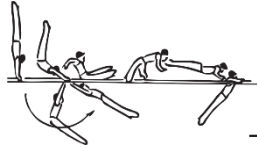

A = 0,1	B = 0,2	C = 0,3	D = 0,4	E = 0,5	F = 0,6 G = 0,7 H = 0,8
EG II: Elements in support or through support on 2 bars					
97.	98.	99. From handstand, salto fwd to support or from handstand with rotated grip, inlocate to support. (Carballo 2) C ₂	100.	101. 5/4 salto fwd. straddle directly to hang. (Lee Chul Hon/Sasaki) δ>i	102.
103.	104. 5/4 salto fwd. tuck or pike to upper arm hang. ● δv	105. Salto fwd to support. δv	106. 5/4 salto fwd. straddled to upper arm hang. ● δ≥	107. 5/4 salto fwd. straddled to bent arm support. ● δ>!	
109.	110.	111. Salto fwd. piked to hang. Γδv i	112.	113. Double salto fwd. tuck to upper arm hang. ● ∞	114. Double salto fwd. pike to upper arm hang. ● ∞v
115.	116.	117. 5/4 salto fwd. straight to upper arm hang ● δ/	118.	119. Salto fwd. with 1/1 t. to upper arm hang. (Urzica) ● Ur	120.

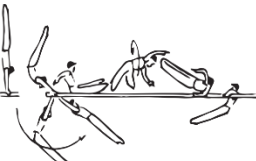
● Prohibited for juniors.

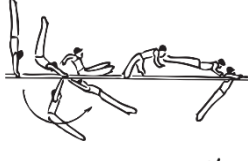
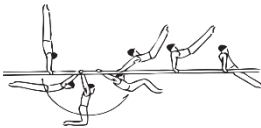
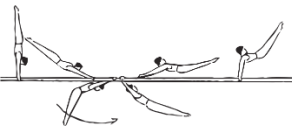
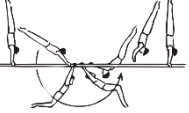

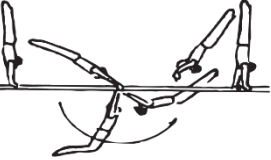



A = 0,1	B = 0,2	C = 0,3	D = 0,4	E = 0,5	F = 0,6 G = 0,7 H = 0,8
EG III: Long swings in hang on 1 or 2 bars and Underswings					
1.	2.	3. Swing forward, straddle cut backward, and regrasp with straight body at horizontal to bent and upper arm.  T	4. Moy piked with straddle bwd to handstand (Tippelt)  T	5. Swing forward, straddle cut backward, and regrasp with straight body at horizontal. (Bhavsar)  Bv	6.
7.	8. Moy piked with straddled, cut bwd. and 1/2 t. to upper arm hang (also legs together).  Mε	9. Moy piked with 1/1 t. to upper arm hang. (Nolet)  Mε	10. Moy and salto fwd. tuck, pike, or straddled, to upper arm hang. (Giraldo)  Mσ Mσ'	11.	12.
13.	14. Moy to support bent legs (also without grip release).  Mz	15. Moy to support straddled legs (also without grip release). (Moy)  M	16.	17..	18.
19.	20.	21. Giant swing bwd. to handstand or with inlocation fwd. (also with 1/4 or 1/2 turn and to one rail). (Kenmotsu)  O (Wells)  Oε	22. Giant swing bwd. to handstand on one rail (connected to Healy type element). (Piasecky)  O	23.	24.

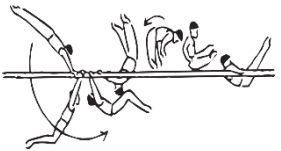
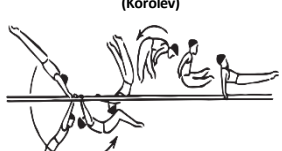
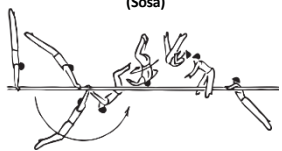
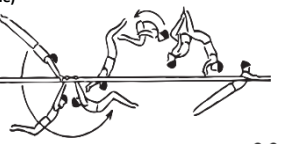
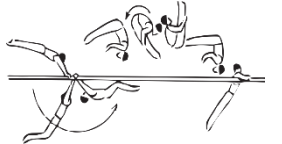

A = 0,1	B = 0,2	C = 0,3	D = 0,4	E = 0,5	F = 0,6 G = 0,7 H = 0,8
EG III: Long swings in hang on 1 or 2 bars and Underswings					
25.	26.	27.	28.	29. Giant swing bwd. with Diamidov to handstand, also to one rail. Od	30. Giant swing Diamidov with ¼ or ½ t. to handstand. Ode
31.	32.	33.	34.	35.	36.
37.	38. Swing down with salto bwd. straight to hang Oi	39. Giant swing bwd. with ¼ t. to upper arm hang. (Gushiken) Oe	40. Giant swing bwd. with ½ t. to support. (Marinitch) Ma	41.	42. Giant swing. bwd. with Diamidov to handstand to one rail (connected to Healy type element). Od
43.	44.	45.	46. Giant swing bwd. with Makuts to upper hang. (Dauser) Ok	47.	48. Giant swing bwd. with Makuts. (Baumann) Ok

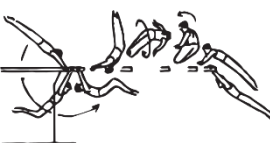
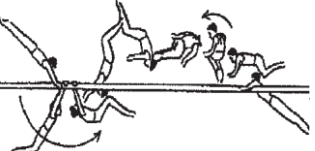

A = 0,1	B = 0,2	C = 0,3	D = 0,4	E = 0,5	F = 0,6 G = 0,7 H = 0,8
EG III: Long swings in hang on 1 or 2 bars and Underswings					
49.	50. Giant swing bwd. with straddled cut to upperadddedarm hang  ● O ₂	51.	52. Giant swing bwd. with straddle cut to support or bent arms support. (Korolev)  ● O>	53. Giant swing bwd. with ½ t. and straddled cut bwd. to upper arms. (Sosa)  ● So	54.
55.	56.	57.	58.	59. From giant. sw. bwd., double salto tuck to upper arm hang. (Belle)  ● Be ○○○	60. Belle pike.  ● Bev ○○○
61.	62.	63.	64.	65.	66. Belle with 1/1 turn.  ● H Q
67.	68.	69. Giant swing bwd. and salto with ½ t. to hang on the end. (Chartrand)  ch ●	70. Giant swing bwd. and salto with ½ t. to upper arm hang.  ● O ₂	71. Giant swing bwd. and salto with ½ t. to hang.  ● O ₂ i	72. Giant swing bwd. with ½ t. and 3/2 salto fwd to upp arm hang. (Tanaka)  ● G T _α

● Prohibited for juniors.





A = 0,1	B = 0,2	C = 0,3	D = 0,4	E = 0,5	F = 0,6 G = 0,7 H = 0,8
EG III: Long swings in hang on 1 or 2 bars and Underswings					
73. Glide kip. C	74. Glide kip with ½ t. to support. C <i>i</i>	75. Glide kip bwd. to handstand. C <i>1</i> ^b	76.	77. Giant swing bwd. and salto with ½ t. to support. (Torres) O <i>2</i>	78. Giant swing backward with ½ t. and 3/2 salto forward piked to upper arm hang. (Esparza) ● H O <i>2</i> ^{ov}
79.	80. Glide kip to straddled cut bwd. handstand on 1 or 2 rail. C> ^b	81. Glide kip to straddled cut bwd. to hand. (Okubo) C> ⁱ	82.	83. Giant swing bwd. and salto with ½ str to upper arm hang (Fokin) ● O <i>2</i> ²	84.
85.	86. Glide kip one rail through L-sit straddled to handstand. C> ^b	87. Glide kip through L-sit piked to handstand. C <i>1</i> ^b	88. Glide kip through L-sit piked to handstand and hop with ¾ t. or more. C <i>1</i> L ^b	89.	90.
91.	92. Glide kip through V-sit and hop ½ turn to hang on other rail. (Li Donghua) C <i>1</i> ^b	93.	94.	95.	96.



A = 0,1	B = 0,2	C = 0,3	D = 0,4	E = 0,5	F = 0,6 G = 0,7 H = 0,8
EG III: Long swings in hang on 1 or 2 bars and Underswings					
97. Cast to upper arm hang. U	98. Cast to support. U!	99. Felge with 1/2 t. to upper arm hang. f	100. Felge with 1/2 t. to rear support. f!	101.	102.
103.	104. Cast with 1/2 t. to up. arm hang. UE	105. Cast with 1/2 t. to support. UE	106. Felge to handstand. Also to one rail or 1/4 t. (Cuherat - Celen) f fe	107. Felge with 1/2 or 1/4 t. to handstand. fe fe	108. Felge with 1/1 t. to handstand. (Teng Hai Bin) fe
109.	110. (Arican) U>	111. Cast to straddle cut backward to handstand. (Arican)	112.	113.	114. Felge with 5/4 t. to handstand. (Zhou Shixiong) G fe
115. Felge with travel to hang fi	116. Felge to support fi	117. Felge with immediate straddle cut to support. f>	118.	119. Felge to one rail handstand (connected to Healy type element). (Chiarlo) f	120. Felge through handstand to Makuts. (Yamamuro) G fMk



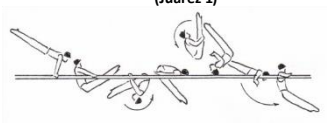
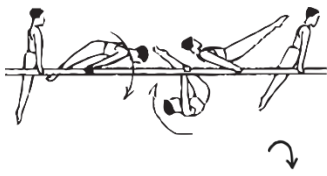
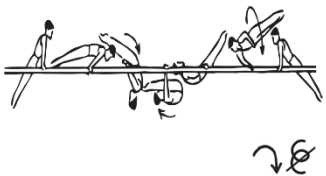
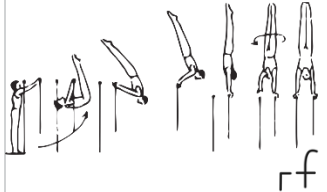
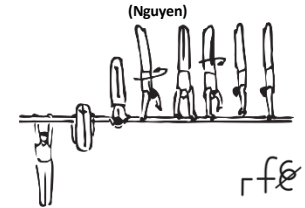
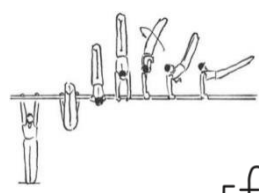



A = 0,1	B = 0,2	C = 0,3	D = 0,4	E = 0,5	F = 0,6 G = 0,7 H = 0,8
EG III: Long swings in hang on 1 or 2 bars and Underswings					
121.	122. Felge roll backward with tuck salto ½ to upper arm hang. (Gagnon)  ● Ga	123. Felge roll backward with straight salto ½ to upper arm hang. (Gagnon 2)  ● Ga ₂	124.	125. Felge with salto bwd tuck to upper arm hang. (Tejada)  ● fe	126. Felge with salto bwd p. to up. arm hang. (Juarez 1)  ● fev
127. Felge forward to support. 	128. Felge forward with ¼ t. to support. 	129.	130. Shoot up with ¼ t. to handstand.  rf	131. Shoot up with ½ or ¾ t. to handstand. (Nguyen)  rfe	132.
133.	134.	135.	136.	137. Shoot up to handstand and fall back to support with ¼ turn. (Malone)  rfh	138.
139.	140.	141.	142.	143.	144.

● Prohibited for juniors.

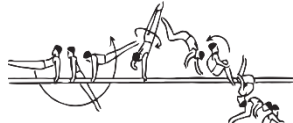
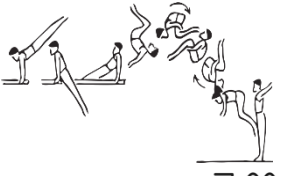
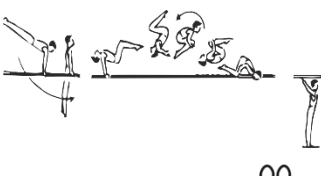
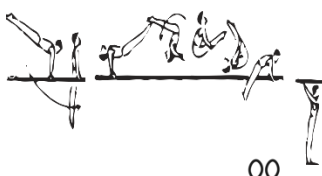
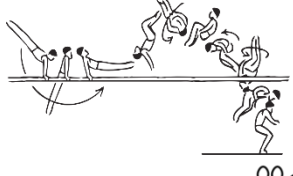

A = 0,1	B = 0,2	C = 0,3	D = 0,4	E = 0,5	F = 0,6 G = 0,7 H = 0,8
EG IV: Dismounts					
1. Salto fwd. piked or straight also with ½ t. 	2.	3.	4.	5. Double salto fwd. tuck. 	6. Double salto fwd. p. 
7.	8. Salto fwd. piked or straight with 1/1 	9. Salto fwd. piked or straight. 3/2 t. 	10. Salto fwd. piked or straight with 2/1 or 5/2 t. 	11. Double salto fwd. tuck with ½ t. or ¼ t. double salto bwd. 	12. Double salto fwd. tucked with 1/1 t. (Larduet) 
13.	14.	15. Double salto fwd. tuck from end. 	16.	17.	18. Double salto fwd. piked with ½ t. (Dalaloyan) 
19. Salto bwd. piked or straight, also with ½ t. 	20.	21. Salto bwd. piked or straight with 1/1 or 3/2 t. 	22. Salto bwd. straight with 2/1 t. (Kan) 	23.	24.

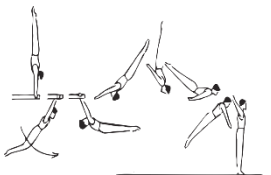
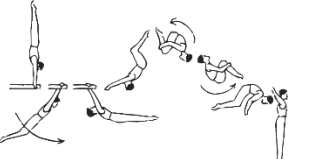
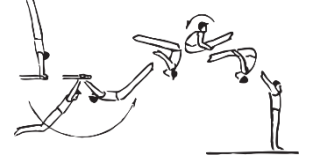

A = 0,1	B = 0,2	C = 0,3	D = 0,4	E = 0,5	F = 0,6 G = 0,7 H = 0,8
EG IV: Dismounts					
25.	26.	27.	28. High wende and salto bwd tuck or pike. (Roethlisberger)  E00 E00V	29.	30.
31.	32. Double salto bwd. tuck from end.  700	33. Double salto bwd. tuck.  00	34. Double salto bwd. pike.  00V	35.	36. Double salto bwd. t. with 1/1 t. (Hiroyuki Kato)  G 00E
37.	38.	39.	40. Double salto bwd. tucked with 1/2 t. or salto bwd. 1/2 tucked to salto fwd. tucked.  00E	41.	42.
43. From hang on end, salto bwd. straight.  7e/	44.	45. From hang on end, double salto bwd. Tuck.  000	46. From hang on end, double salto bwd. pike.  000V	47. From hang on end, double salto bwd. tuck with 1/1 or 1/2 t.  000E 000E	48. From hang on end, double salto bwd. tuck with 2/1 t.  000E



Section 15

Horizontal Bar

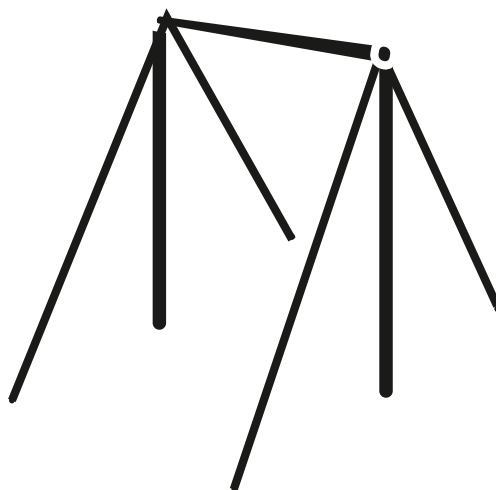

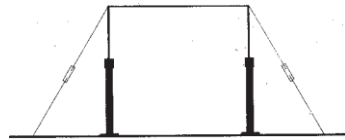

Height: 260 cm from top of mat, 280 cm from the floor.

Article 15.1 Exercise description

A contemporary Horizontal Bar Exercise must be a dynamic presentation that consists entirely of the fluid connection of swinging, turning, and flight elements alternating between elements performed near to and far from the bar in a variety of hand grips so as to demonstrate the full potential of the apparatus.

Article 15.2 Content and Construction

Article 15.2.1 Information about Exercise Presentation

1. The gymnast must jump or be assisted to a still or swinging hang on the Horizontal Bar from a still stand with legs together or from a short run, but always with good form. The evaluation begins from the moment the gymnast leaves the floor. A cast, consisting in a maximum of three swings, is permitted in order to begin an exercise without deduction. Additional swings will be deducted 0.3.
2. Other execution and exercise construction expectations are:
 - a) The exercise must consist entirely of swings without stops or pauses.
 - b) Deviations through handstands will be evaluated as follows :

Angle past handstand	Adlers, Stalders, endos, ½ turns, etc.	Turns to mixed or elgrip, quast, flying giant
0°-15°	= No deduction	= No deduction
>15°-30°	= 0.1	
>30°-60°	= 0.3	= 0.1
>60°-90°	= 0.5	=0.3
>90°	= 0.5 & NR	= 0.5 & NR

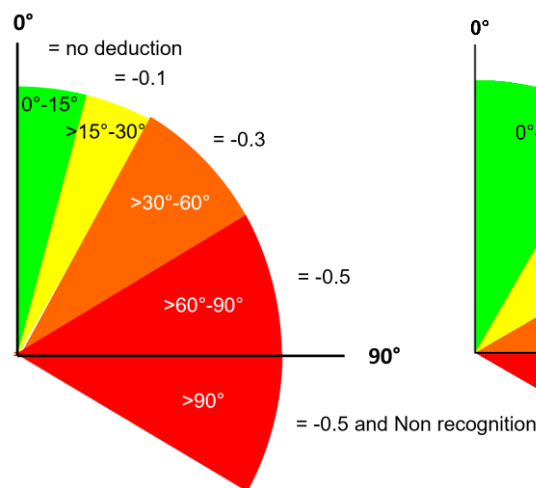

Adlers, Stalders, Endos, ½ turns, etc.

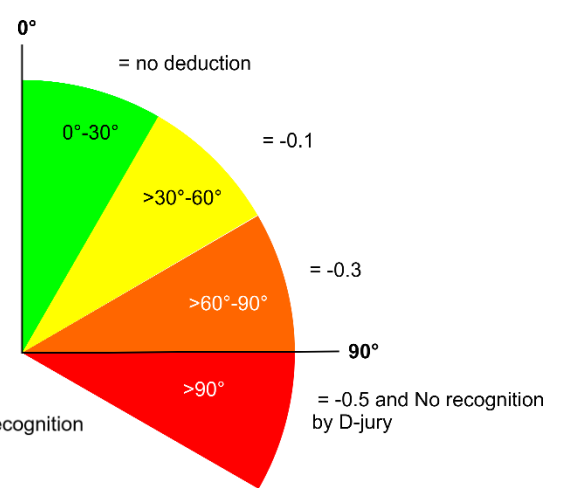

Turns to mixed or elgrip, quast, flying giant



- c) Flight elements must demonstrate a conspicuous rise of the body during the flight phase.
- d) Backward swings to handstand that simply reverse direction and swing back down in the reverse direction are deducted (composition errors) each time with 0,30 points.
- Specific examples of such layaways are:
- Following a kip cast or back uprise to handstand - layaway to giant swing bwd., Stalder, free hip, ½ turn to el-grip, etc.
 - Following a backward uprise to handstand and hop to overgrip - swing forward to giant swing bwd., Stalder, free hip, etc.
- (Also other angle deductions also need to be applied for missing the handstand position).
- e) Any flight element with salto over the bar requires a giant swing afterward or -0.3 (E-Jury deduction).
- f) For all Adler elements it is not required to enter from a handstand position.
3. For a full list of errors and deductions governing Exercise Presentation, see Section 9 and the summary of deductions in Articles 9.4 and 15.3.

Article 15.2.2 Information about the D-score

1. The Element Groups are (EG):
- I. Long hang swings with and without turns.
 - II. Flight elements.
 - III. In bar and Adler elements.
 - IV. Dismounts.

2. Information about Connections (CV).

Connection points can be awarded only in the following situations:

Flight		Flight		Connection points	Group I or III elements		Flight		Connection points
C value	+	D or higher value	=	0,10	D or higher value	+	D	=	0,10
or vice versa					or vice versa				
D	+	D	=	0,10	D or higher value	+	E or higher value	=	0,20
D or higher value	+	E or higher value	=	0,20	or vice versa				

Must be inside the 8 counting elements.

3. Additional information and regulations:

- Unless otherwise indicated, the value and identification numbers of elements listed in the Difficulty Tables are the same if performed from handstand, from a back swing, or from some other position.
- Unless otherwise indicated, elements have the same difficulty value and identification number when performed with the "wrong grip" or atypical grip positions.
- Elements that end in a double elgrip have one letter superior value than the same elements ending in one arm elgrip.
- Starting flight elements with any grip variation has the same value and identification number as starting or regripping with two hands.
- Unless otherwise indicated re-grasping with any grip variation has the same value and identification number as re-grasping with two hands
- All Endo, Stalder, Weiler and Kip Elements with turn are divided up in two Elements except Stalder Rybalko.

Example:

Endo + 1/1 turn to El-Grip = B + C Stalder + ½ turn to El-Grip = B + B

- Elements with hops to handstand, which include turns, must initiate the turn during the hop and must re-grasp with the second hand only after the turn has been completed. A re-grasp may occur initially with one hand and then the second hand as the turn is completed. A hop element is considered finished at the moment that both hands re-grasp the bar.

- Clarifications for giants with hop and turn (Quast and Rybalko style)

Quast:

- Visible hop and fluid turn, not turning on the supporting arm Giant swing bwd. with hop 3/2 turn (into el-grip = Rybalko):
- Prerequisite condition is both hands in mixed el-grip or el-grip in end position
- Visible hop and fluid turn, not turning on the supporting arm.
- Giant swing bwd. with hop 3/2 t. to one arm giant swing (Rybalko to one arm giant swing) is the same value and box as Rybalko to undergrip or mixed el-grip (Element I.51).
- A giant bwd. swing with hop and more than 3/2 turn is prohibited (2 or more turn)



- This rule also applies to all Stalder with hop 3/2 turn (into el-grip = Rybalko) type elements
 - i) Rybalko or Piatti from Stalder with legs together are not permitted.
 - j) Turning elements in one hand support position must be considered as finished at the moment the gymnast regrips the bar with the second hand.
 - k) Piatti style elements from the stoop circle (feet on bar) are not permitted.
4. Flight elements from el-grip and dismounts from el-grip or dorsal hang have the same value as elements performed in regular grip.
5. Special repetitions:
- a) A maximum of two Stoop Circle Rearward forward through handstand elements (Adler type) are permitted. In this case the elements with the highest difficulty value will be counted.
 - b) Elements with turns: an exercise cannot include more than one grip variation of the same element. In this case the elements with the highest difficulty value will be counted as consistent with the Special Repetition rules of the other apparatus. Some examples:
 - Rybalko in double el grip or Rybalko in mixed grip or Rybalko one hand grip.
 - c) Only two Tkatchev & Piatti, Kovacs, Gienger, Jäger, Markelov or Saltos fwd over the bar style flight elements are permitted. The gymnast may perform 5th flight if at least two flights are connected.
6. Regrasping Tkatchev ½ or Yamawaki ½ elements without sufficient turning and continuing to handstand (or directly connecting to a release element) will receive no value.
7. For an el-grip or Russian giant to be recognized directly after an Adler or turn to el-grip, the el-grip or Russian giant requires a swing over the bar in el-grip in order to receive a value.
8. A Zou Li Min executed with insufficient turning (greater than 90° deviation on first full twist) will not be recognized by the D-Jury and receive a -0.5 deduction by the E-Jury. This element may not be devalued to a Giant Swing Fwd. with one arm in undergrip (B value).
One arm giant swing fwd. with 1/1 t. to el-grip and 1/1 t. to undergrip (Zou Li Min, Element I.27) cannot be combined with any other element for an increase in value.
9. The Yamawaki element must be straight when passing through a vertical body position over the bar for no deductions. An excessive pike or a poor vertical position over the bar will be deducted, but bent body more than 45° will be recognized as a B value.
10. Flight elements always receive value if a distinct hang phase is shown before the gymnast falls.
11. Endo in el-grip through handstand. (Element III.99): For the recognition of this element the gymnast must start the element in el-grip handstand and must go over the top of the bar in el-grip at the end of the element
12. An El-grip giant swing (Element I.68) and Giant swing rearways fwd. (Russian giant, Element I.69) only require going over the top of the bar in el-grip to receive their listed value. No specific amount of a giant swing in el-grip is required in order for the element to be recognized.
Sequence examples:
- 1. Adler to 65° from handstand, swing in-elgrip through the bottom and over the top, swing in elgrip through the bottom and hop out to undergrip= value for Adler (and -0.5 angle deduction) and B value el-grip giant.
 - 2. Adler to handstand, swing in el-grip through the bottom and over the top into el-grip Endo, swing through the bottom in el-grip Endo, swing in el-grip through the bottom and hop out to undergrip = C value Adler, B value el-grip giant, C value el-grip Endo.
13. Flights elements with ½ turns to mixed el-grip must have more than 50% of the turn completed upon catching the bar in order to receive no deduction while continuing to back uprise to handstand. E-Jury deductions of small, medium, large should be applied for any insufficient turning upon catching the bar.
14. Stoop circle fwd. to straddle cut to hang or sup. (Element III.103)- Gymnast may enter at any angle from a giant swing or swing forward.
15. Regarding the performance expectations for the exit from the Czech giant: A simple stoop exit from dorsal hang followed by a stalder is permitted without an angular deviation deduction, but also does not receive any value
16. Endo, Stalder, Weiler and Adler Elements:
For recognition these elements must continue over the bar in the intended direction
17. Regarding the Tkatchev straight: the element must be performed with a straight body throughout the element until regripping the bar. If the gymnast bends his body greater than 45° as the feet passes over the bar, it will be recognized as a Tkatchev pike = C-value. If the gymnast bends his body after passing over the bar he will receive the D value, but would receive appropriate execution deductions.
18. For a further list of regulations governing non-recognition of elements and other aspects of the D-score, see Section 7 and the summary of deductions in Article 7.6.





Article 15.3 Specific Deductions for Horizontal Bar

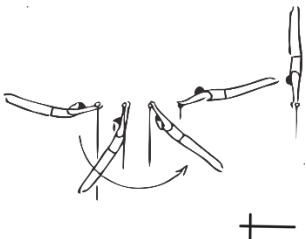
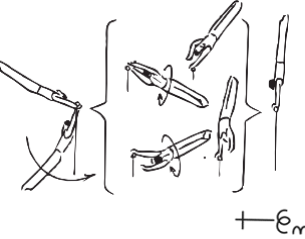
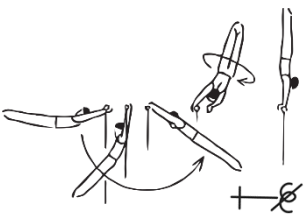
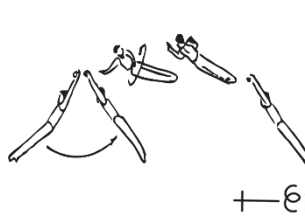
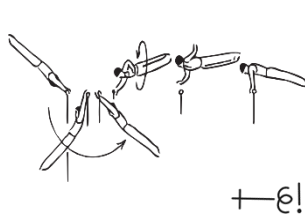
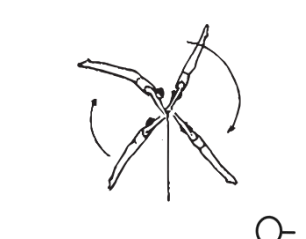
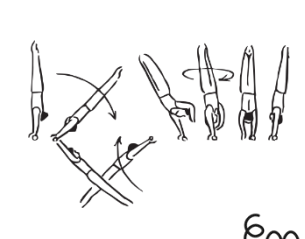
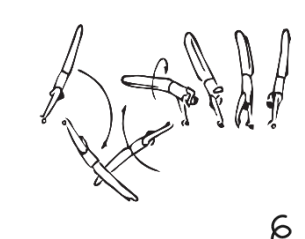

E-Jury

Error	Small 0.10	Medium 0.30	Large 0.50
Legs apart or other poor execution during jump or lift to Horizontal Bar.		●	
Lack of swing or pause in handstand or elsewhere.	●	●	
Low amplitude on flight elements.	●	●	
Deviation from plane of movement.	≤ 15°	>15°	
Layaway on the back swing.		●	
Illegal elements with or from feet on the bar.		●	
Bent arms on regrasping following flight elements.	●	●	
Bent knees during swing actions.	● each time	● each time	
Elements not continuing in their intended direction.		● NR	
Any flight element with salto over the bar without a giant swing afterward.		●	
Entry angle deviation from handstand in Endos, Stalders and Weilers.		●	
Additional swings in the beginning of exercise.		●	

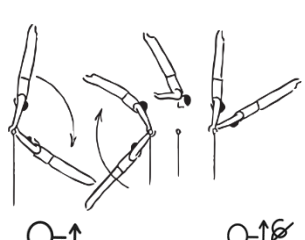
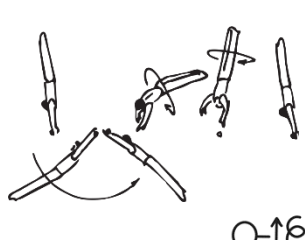

A = 0,1	B = 0,2	C = 0,3	D = 0,4	E = 0,5	F = 0,6 G = 0,7 H = 0,8
EG I: Long hang swings and turns					
1. Back uprise to handstand. 	2. Back uprise to hdst. with 1/1 turn also to mixt. 	3.	4.	5.	6.
7. Back uprise to handstand with 1/2 turn. 	8. Swing bwd. and pirouette to hang. 	9. Swing bwd. and pirouette to support. 	10.	11.	12.
13. Giant swing fwd. 	14. Giant swing fwd. with 1/1 turn in mixt grip. 	15. Giant swing fwd. with 1/1 turn in double elgrip. 	16.	17.	18.
19. Giant swing fwd. with 1/2 t. thr. hdst. 	20. Flying giant swing fwd. or with 1/2 turn. 	21. Flying giant swing fwd. with 1/1 t. 	22.	23.	24.

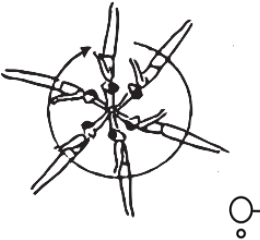
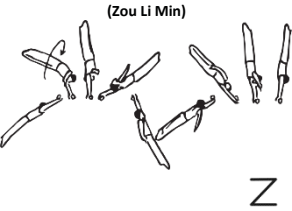
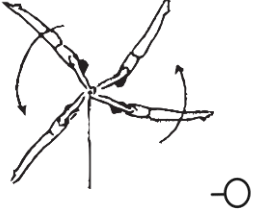

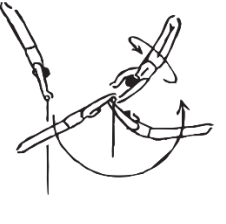
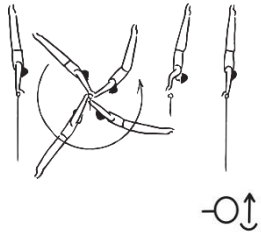
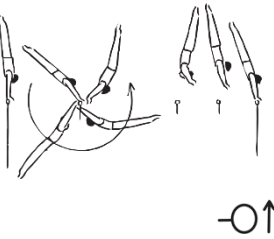
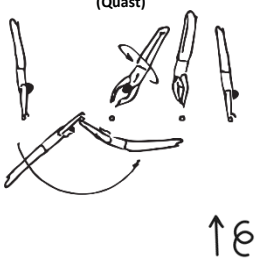
A = 0,1	B = 0,2	C = 0,3	D = 0,4	E = 0,5	F = 0,6 G = 0,7 H = 0,8
EG I: Long hang swings and turns					
25.	26. Giant swing fwd. with one arm in ungr. 	27. On one arm, giant swing fwd. w. 1/1 t. to el-grip and 1/1 t. (Zou Li Min) 	28.	29.	30.
31. Giant swing bwd. 	32 One arm giant swing bwd. 	33.	34.	35.	36.
37. Giant swing bwd. with 1/2 turn. 	39.	40.	41.	42.	43.
43. Giant swing bwd. with hop to undergrip. 	44. Flying giant swing bwd. 	45. Flying giant swing bwd. with 1/1 t. (Quast) 	46.	47.	48.

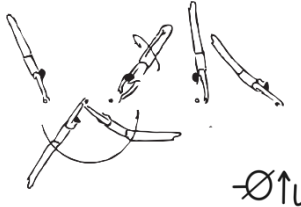
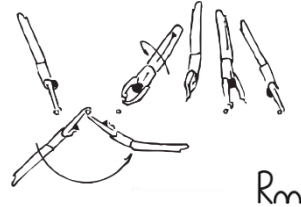
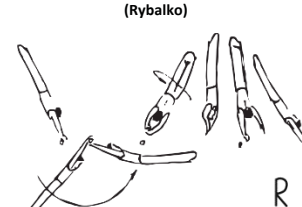
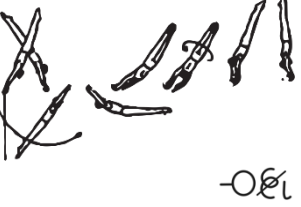
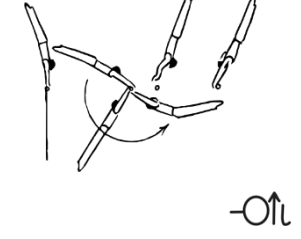
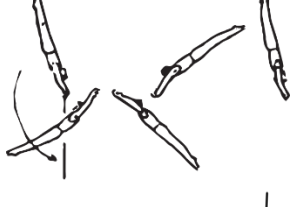
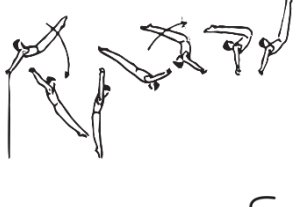
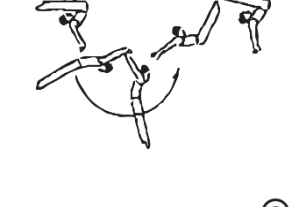

A = 0,1	B = 0,2	C = 0,3	D = 0,4	E = 0,5	F = 0,6 G = 0,7 H = 0,8
EG I: Long hang swings and turns					
49.	50. Giant swing bwd. with hop ½ t. to el-grip.  -Ø↑l	51. Giant swing bwd. with hop 3/2 t. to undergrip, mixed el-grip.  Rm	52. Giant swing bwd. with hop 3/2 t. to double el-grip (Rybalko)  R	53.	54.
55.	56.. Giant swing bwd. with ½ t. to el-grip.  -Ø½l	57.	58.	59.	60.
61.	62. Long swing fwd. with hop to el-grip.  -Ø↑l	63.	64.	65.	66.
67.	68. El-grip giant swing.  l	69. Giant swing rearways fwd. (Russian giant).  r	70. Giant swing rw. bwd. (Czech giant swing).  ©	71.	72.



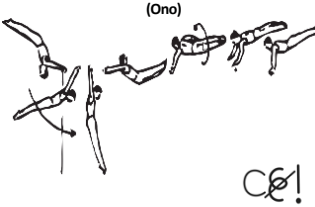
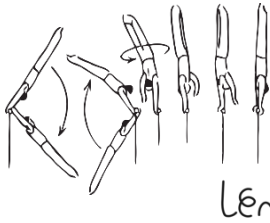
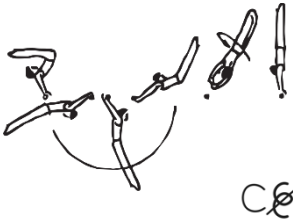

A = 0,1	B = 0,2	C = 0,3	D = 0,4	E = 0,5	F = 0,6 G = 0,7 H = 0,8
EG I: Long hang swings and turns					
73.	74. Steineman uprise w. ½ t. to support.  (Ono) CØ!	75. Elgrip giant swg. with 1/1 t. thr. hdst. in mx. gr.  Lem	76. Giant swing rw. bwd. (Czech giant swing) with ½ turn to fwd giant swing.  CØ	77.	78.
79.	80.	81.	82.	83.	84.
85.	86.	87.	88.	89.	90.
91.	92.	93.	94.	95.	96.





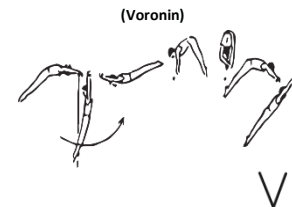
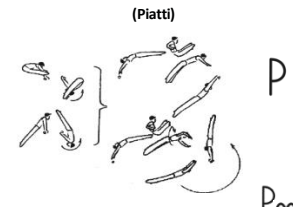
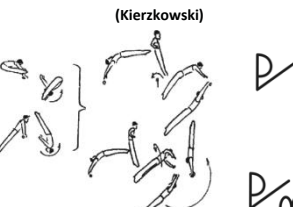
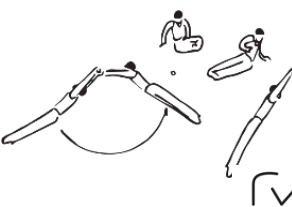

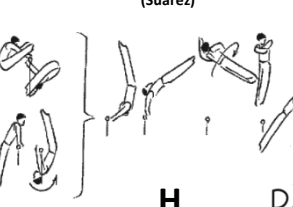
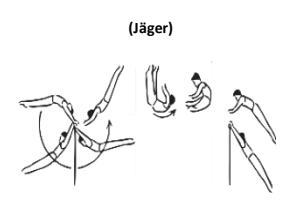
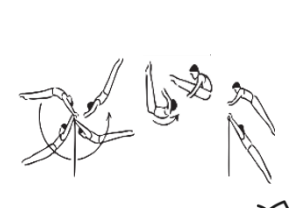
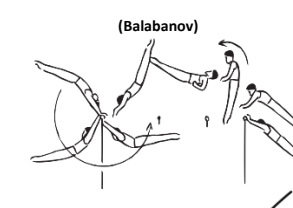
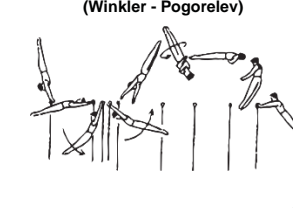
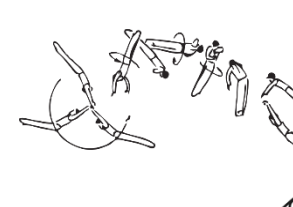



A = 0,1	B = 0,2	C = 0,3	D = 0,4	E = 0,5	F = 0,6 G = 0,7 H = 0,8
1.	2. Back uprise and straddle over to hang rw. 	3. Back uprise and strad. hecht with ½ t. to hang. also w. ½ t.  (Markelov) (Principi)	4.	5.	6. Back uprise and hecht straight with 3/2 t. to hang.  (Walstrom) G
7.	8.	9. Markelov str. with legs together .also with ½ t.  (Yamawaki) (Muñoz - Pozzo)	10.	11.	12.
13.	14.	15. Swing fwd. and vault bwd. strad. to hang, also with ½ t.  (Tkatchev) (Lynch) (Moznik)	16. Tkatchev straight, also with ½ t. to mix el-grip into back uprise to hdst.  (Moznik)	17.	18. Tkatchev straight with 1/1 t.  (Liukin) G
19.	20.	21. Swing fwd. and vault bwd. piked to hang, also with ½ t.  (Samiloglu)	22.	23. Tkatchev straddled ½ t. to double elgrip.  (Kulesza)	24.



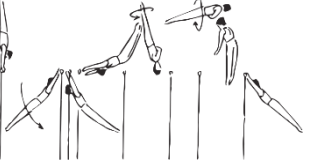

A = 0,1	B = 0,2	C = 0,3	D = 0,4	E = 0,5	F = 0,6 G = 0,7 H = 0,8
EG II: Flight elements					
25.	26. Back uprise and piked vault with ½ t. to hang. (Voronin)  V	27.	28. Stalder or free hip circle bwd to Tkatchev straddle, also with ½ t. (Piatti)  P P _m	29. Piatti straight. also with ½ t. to mix el-grip into back uprise to hdst. (Kierzkowski)  D D _m	30.
31.	32. Back uprise and rear vault with ¼ t. to hang.  V	33.	34. Piatti piked. also w. ½ t.  P _v	35.	36. Piatti straight with 1/1 turn. (Suarez)  H P _e
37.	38.	39. Swing bwd. And salto fwd t. or strad. to hg. Also from el-grip (Jäger)  J	40. Swing bwd. and salto fwd. p. to hg. also from el-grip.  J _v	41. Salto fwd. straight, also from el-grip. (Balabanov)  J	42. Salto fwd. straight with 1/1 t. also from el grip (Winkler - Pogorelev)  G J _e
43.	44.	45.	46.	47.	48. Salto fwd. stretched with 2/1 t. also from el grip.  H J _e



A = 0,1	B = 0,2	C = 0,3	D = 0,4	E = 0,5	F = 0,6 G = 0,7 H = 0,8
EG II: Flight elements					
49.	50.	51. Czech giant and vault bwd. strad. to hang.  cT	52. Swing fwd. and counter salto fwd. straddled to hang. (Xiao Ruizhi)  Tδ	53.	54.
55.	56.	57. Swing fwd. ½ t. to salto fwd. strad. to hang. (Deltchev)  G>	58. Swing fwd. and salto bwd. piked w. ½ t. to hang. (Gienger)  G cG (Sapronenko)	59.	60. Swing fwd. and salto bwd. w. 3/2 t. to hang. (Deff)  G Ge
61.	62.	63.	64.	65. Salto fwd, tuck over the bar, also from el-grip. (Gaylord)  oo	66. Gaylord with ½ t. (Pegan)  G ooε
67.	68.	69.	70.	71.	72. Gaylord with 1/1 t. (Koudinov)  H ooε

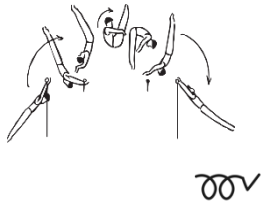
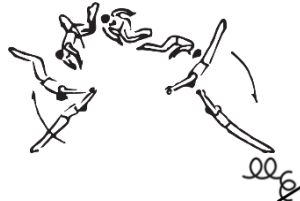

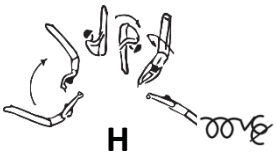
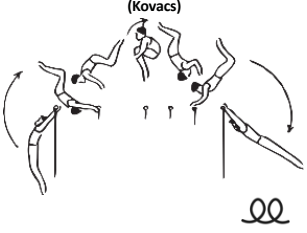
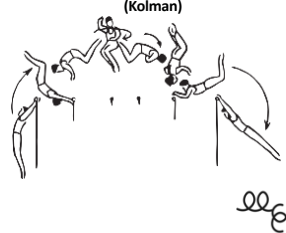
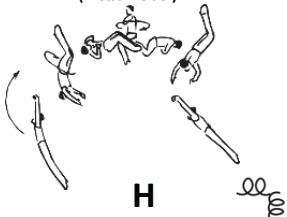
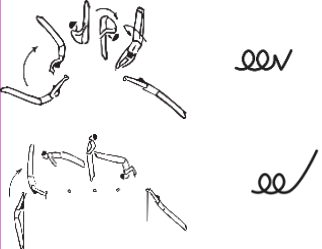
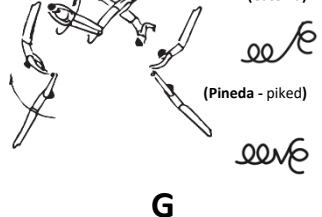
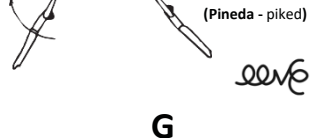

A = 0,1	B = 0,2	C = 0,3	D = 0,4	E = 0,5	F = 0,6 G = 0,7 H = 0,8
EG II: Flight elements					
73.	74.	75.	76.).	77.	78. Gaylord piked. 
79.	80.	81.	82. Salto bwd. ½ t. tucked over the bar. 	83. Salto bwd. ½ t. piked over the bar. (Gaylord 2) 	84. Pegan piked. (Maras) 
85.	86.	87.	88. Double salto bwd. t. over the bar. (Kovacs) 	89. Kovacs with 1/1 t. (Kolman) 	90. Kovacs with 2/1 t. (Bretschneider) 
91.	92.	93.	94.	95. Kovacs piked or straight. 	96. Kovacs straight or piked with 1/1 turn. (Cassina)  (Pineda - piked) 

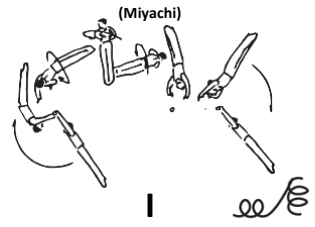
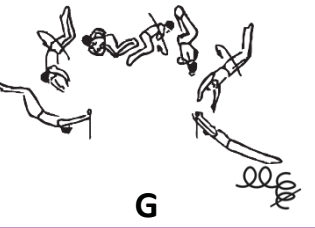



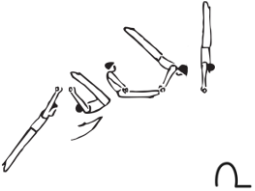



A = 0,1	B = 0,2	C = 0,3	D = 0,4	E = 0,5	F = 0,6 G = 0,7 H = 0,8
EG II: Flight elements					
97.	98.	99.	100.	101.	102. Kovacs straight with 2/1 turn.  <p>(Miyachi)</p> <p>I</p>
103.	104.	105.	106.	107.	108. Kovacs with 3/2 t. to mix grip.  <p>(Shaham)</p> <p>G</p>
109.	110.	111.	112.	113.	114.
115.	116.	117.	118.	119.	120.

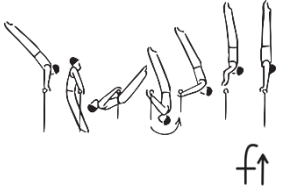
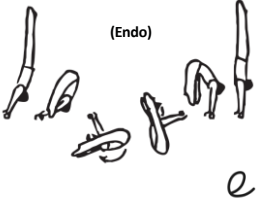

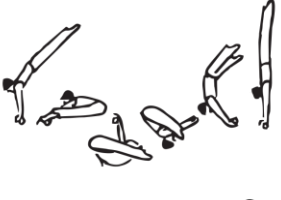

A = 0,1	B = 0,2	C = 0,3	D = 0,4	E = 0,5	F = 0,6 G = 0,7 H = 0,8
EG III: In bar and Adler elements					
1. <i>Kip to hdst. or from mixed grip to hdst</i> 	2.	3.	4.	5.	6.
7.	8. <i>From hdst., free hip circle fwd. thr. hdst.</i> (Weiler) 	9.	10.	11.	12.
13. <i>From hang or from support, free hip circle through handstand.</i> 	14.	15.	16.	17.	18.
19.	20.	21.	22.	23.	24.



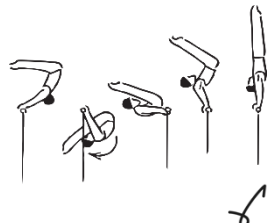

A = 0,1	B = 0,2	C = 0,3	D = 0,4	E = 0,5	F = 0,6 G = 0,7 H = 0,8
EG III: In bar and Adler elements					
25. From hang or from support, free hip circle hop to handstand. 	26.	27.	28.	29.	30.
31.	32. Free circle fwd. straddled thr. hdst.  (Endo) e	33. Free circle fwd. legs together thr. hdst.  ev	34.	35.	36.
37.	38. Free circle bwd. straddle thr. hdst.  s	39.	40. Stalder with hop 3/2 turn through hdst. in mix el-grip.  SR _m	41. Stalder with hop 3/2 turn through hdst. in el-grip.  SR	42.
43.	44.	45. Stalder legs together thr. hdst.  S _v	46.	47.	48.

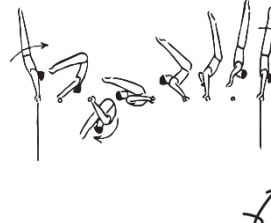

A = 0,1	B = 0,2	C = 0,3	D = 0,4	E = 0,5	F = 0,6 G = 0,7 H = 0,8
EG III: In bar and Adler elements					
49.	50.	51.	52.	53.	54.
55.	56. <i>Stalder with hop through hdst.</i>  S↑p	57. <i>Stalder legs together with hop through hdst.</i>  Sv↑U	58.	69.	60.
61.	62.	63. <i>Stoop circle rearward fwd. through hdst. (Adler).</i>  ♂	64. <i>Adler with 1/2 t. through hdst. in ovgr.</i>  ♂	65. <i>Adler and 1/1 t. through hdst. in ungr.</i>  (Fuentes) ♂	66.
67.	68.	69.	70. <i>Adler hop to hdst. in ungr. or ovgr. or mixed grip</i>  ♂	71.	72.

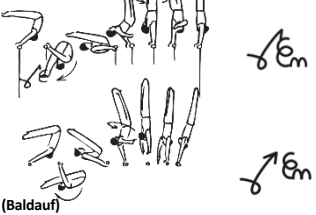

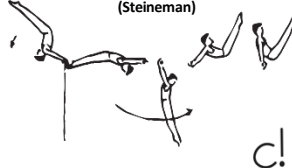
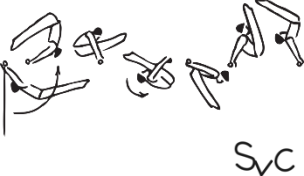
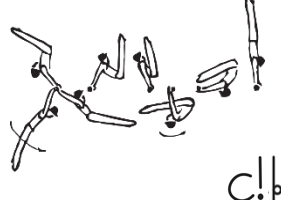
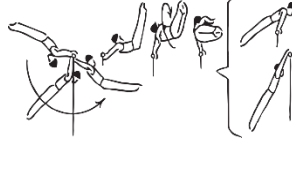
A = 0,1	B = 0,2	C = 0,3	D = 0,4	E = 0,5	F = 0,6 G = 0,7 H = 0,8
EG III: In bar and Adler elements					
73.	74.	75.	76. Adler and 1/1 t. thr. hdst. in mixed grip, also with hop 	77.	78.
79. Back toss to dorsal hang. 	80. From dorsal hang, uprise fwd. to support rw. (Steineman) 	81. Stoop in and free back toss to dorsal hang 	82.	83.	84.
85.	86.	87. Steineman uprise w. stoop or to hdst. (Köste) 	88.	89.	90.
91.	92. Steineman uprise w. flank bwd. to sup. or hang. 	93.	94.	95.	96.







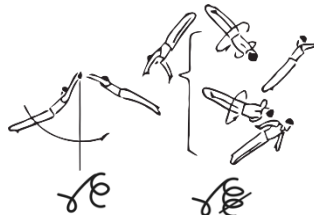
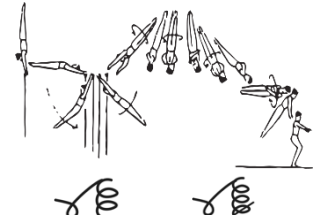
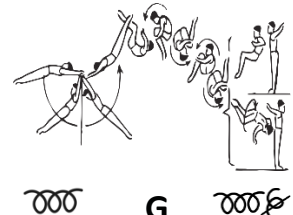
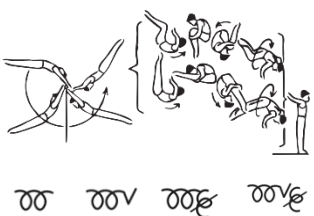
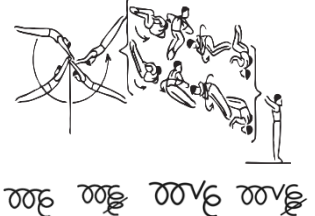
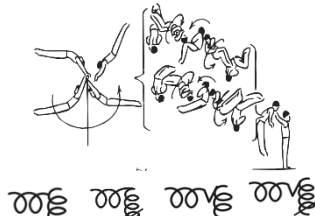
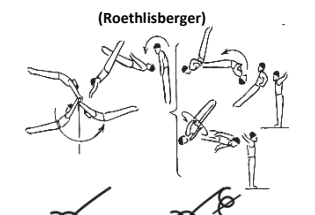
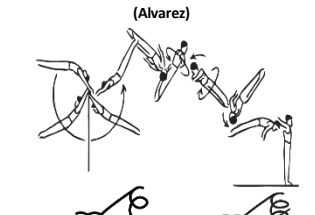
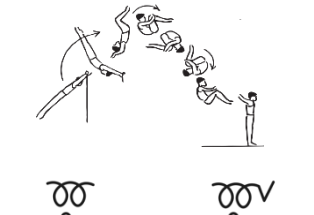
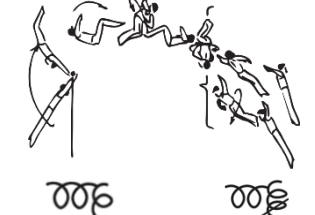



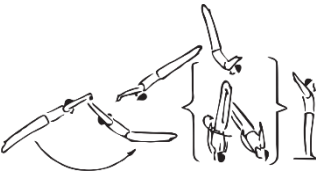
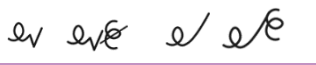
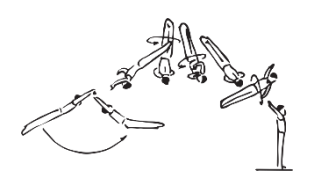

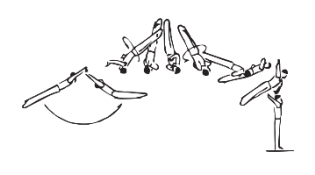

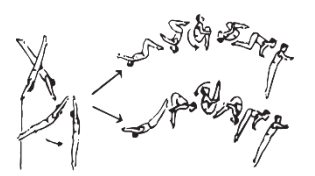

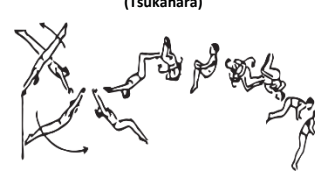

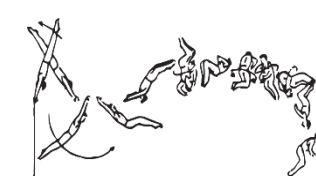



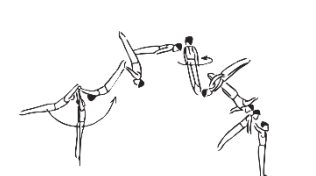

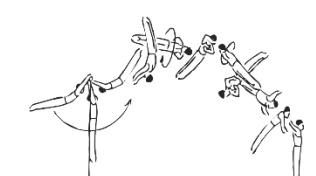
A = 0,1	B = 0,2	C = 0,3	D = 0,4	E = 0,5	F = 0,6 G = 0,7 H = 0,8
EG III: In bar and Adler elements					
97.	98.	99. Endo in el-grip thr. hdst. Le	100. Endo legs together in el-grip thr. hdst. Lev	101.	102.
103. Stoop circle fwd. to straddle cut to hang or sup. >i	104. Stoop circle fwd. to straddle cut through hdst. >p	105. Stoop circle fwd. to straddle cut with 1/2 t. (Carballo) >p	106. Carballo with 1/2 turn to mixed el-grip. (Quintero) >em	107. Quintero to el-grip. >e	108.
109.	110.	111.	112.	113.	114.
115.	116.	117.	118.	119.	120.

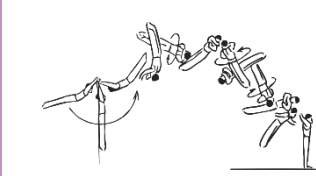

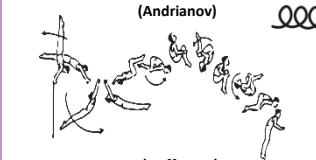





A = 0,1	B = 0,2	C = 0,3	D = 0,4	E = 0,5	F = 0,6 G = 0,7 H = 0,8
EG IV: Dismounts					
1. Salto fwd. piked or stretched, also with ½ t. 	2. Salto fwd. str. with 1/1 or 3/2 t. 	3. Salto fwd. str. with 2/1 or 5/2 t. 	4.	5.	6. Triple salto fwd. t. or with ½ t. (Rumbutis) 
7.	8.	9. Double salto fwd. t. or p. or with ½ turn. 	10. Double salto fwd. t. or p. with 1/1 or 3/2 t. 	11. Double salto fwd. t. or p. with 2/1 or 5/2 t. 	12.
13.	14.	15.	16. Double salto fwd. str. or with ½ t. over the bar (Roethlisberger) 	17.. Double salto fwd. str. with 1/1 or 3/2 t. (Alvarez) 	18.
19.	20.	21. Double salto fwd. t. or p. or with ½ turn over the bar. 	22. Dbl. salto fwd. t. or p. w. 1/1 or 3/2 t. over the bar. (Roethlisberger) 	23.	24.

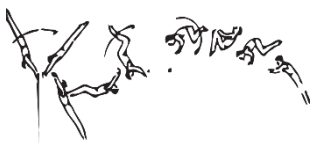

A = 0,1	B = 0,2	C = 0,3	D = 0,4	E = 0,5	F = 0,6 G = 0,7 H = 0,8
EG IV: Dismounts					
25. Salto bwd. piked or str. also with ½ or 1/1 t.  	26. Salto bwd. str. with 3/2 or 2/1 t.  	27. Salto bwd. str. with 5/2 or 3/1 t.  	28.	29.	30.
31.	32. Double salto bwd. tuck or pike.  	33. Double salto bwd. t. with 1/1 t. (Tsukahara)  	34. Double salto bwd. t. with 2/1 t.  	35.	36.
37.	38.	39. Double salto bwd. str.  	40. Double salto bwd. str. with 1/1 t.  	41. Double salto bwd. str. with 2/1 t. (Watanabe)  	42. Double salto bwd. str. with 3/1 t. (Fedorchenko)  
43.	44.	45.	46.	47.	48. Triple salto bwd. t. or over the bar. (Andrianov)   (Hoffmann)  

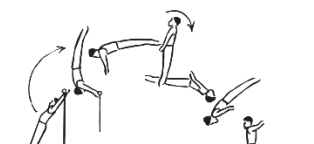
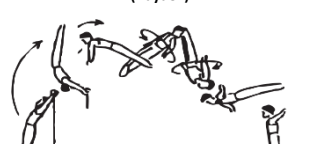
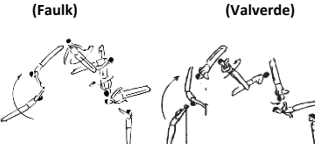
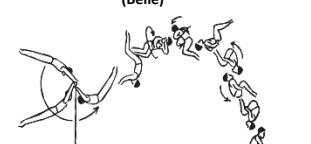
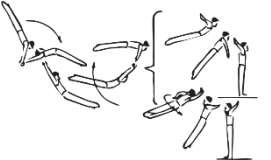
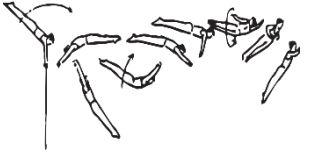

A = 0,1	B = 0,2	C = 0,3	D = 0,4	E = 0,5	F = 0,6 G = 0,7 H = 0,8
EG IV: Dismounts					
49.	50. Double salto bwd. t. over the bar.  oo	51. Doble salto bwd. t. with 1/1 t. over the bar.  ooe	52. Double salto bwd. t. with 2/1 t. over the bar  ooe	53.	54. Triple salto bwd. p.  G ooe
55.	56.	57. Double salto bwd. str over the bar.  oo	58. Double salto bwd. str. w. 1/1 t. over the bar. (Hayden)  oo	59. Double salto bwd str. w. 3/2 or 2/1 turn over the bar. (Faulk) (Valverde)  ooe	60. Triple salto bwd. t. with 1/1 t. (Belle)  G ooe
61. Hecht strad., hecht or hecht w. 1/2 t.  H He	62. Hecht w. 1/1 or 3/2 t.  He He	63.	64. Hecht w. 2/1 t.  He	65.	66.
67.	68.	69.	70.	71.	72.





Appendix A

Additional Explanations & Interpretations

1. The text in the difficulty tables supersedes the illustrations.

2. (See Art. 7.5.k) This rule is interpreted, in part, as follows:

- Twisting elements on all six apparatus will not be recognized if they are performed with a $>90^\circ$ twist short of or beyond the specifications for the intended element
- Swinging elements on all appropriate apparatus will not be recognized if they are completed $>45^\circ$ from the perfect or the prescribed end position. On the Parallel Bars, for example, a Stützkehre must be performed to at least 45° above horizontal to be recognized by the D-Jury.

3. (See Section 9.1.1) Being performed with perfection implies also that elements be performed with the specified body position. The following definitions will apply.

a) A perfect straight body position is one in which a line from the shoulders through the hips to the ankles is straight for static elements and straight or slightly bent forwards or backwards during dynamic elements. If the hip assumes a flexion of greater than 45° at any time during the element, it will be considered piked.

b) A perfect piked body position is one in which the knees are straight and the hips are bent at least 90° . Errors include a pike of less than 90° from the extended position and/or an additional bending of the knees. If the knees assume a flexion of greater than 45° at any time during the element, it will be considered tucked.

A perfect tuck position is one during which the hips are strongly bent and the bent knees are brought to the chest - a minimum 90° bend in each. Errors include a hip bend of less than 90° from the extended position and/or a knee bend of less than 90° .

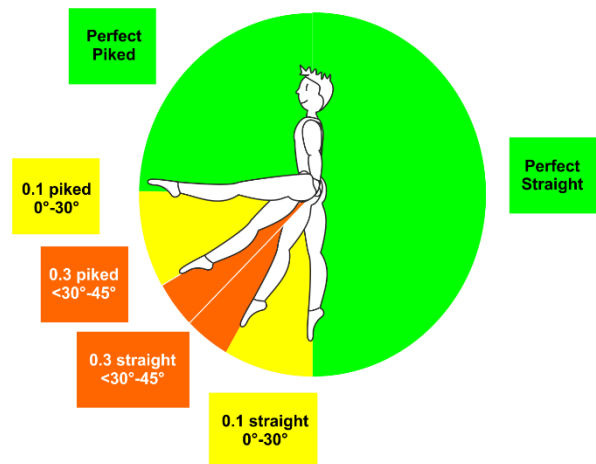

d) A straight position with a knee flexion of 90° is considered to be straight but with a large error. If this occurs during an element it will not be recognized by the D-Jury.

e) A straddled position must be shown with the maximum separation of the legs that the aesthetic and technical nature of the element allows.

f) Each of the salto positions - tucked, piked, straight, straddled is expected to be demonstrated so distinctly and conspicuously as to leave no doubt about the intent.

g) A regular handstand on all apparatus is one with the body perfectly aligned and without arch.

h) Strength holds on all affected apparatus require, depending on the element, the arms to be perfectly horizontal, and/or the body to be perfectly horizontal, and/or the legs to be perfectly horizontal.

i) Certain dynamic elements when poorly performed can be confused with other elements. Some typical examples include:

i. Twisting elements on all apparatus that under-turn by more than 90° .

ii. On Pommel Horse; cross support travels which are oblique by more than 45° versus travels in side support.

In all such cases, the gymnast is obligated to demonstrate the element he wishes to show in a distinct and unmistakable manner. Failure to do so will always result in a large deduction from the E-Jury and non-recognition by the D-Jury (or on Vault, recognition as the element and Group with the lower value).

j) Exceptions can be made if the correct technical execution of an element requires a modification of these definitions.

4. (See Section 9.1.4) This, along with Article 5.2.b is a most important directive for all judges especially with the stated expectation that all elements be performed to perfect end positions. The judge must at all times use his gymnastics knowledge and gymnastics sense. The following examples may be instructive.

a) It is possible to perform elements such as a Tkatchev to a handstand on Horizontal Bar but it is not yet a reasonable, nor perhaps a desirable, expectation. It is reasonable, however, to expect in all cases that the element be performed with technique of such excellence that the gymnast has had time to prepare for the re-grasp, that it occurs with straight arms, and that it permits continuation with a smooth full swing.

b) It is possible to perform a dislocate to handstand from inverted hang on Rings, but it would certainly be an exception. The deduction for not completing this element in handstand would not apply.

c) Some elements have a special purpose or effect and if such purpose is conspicuous and aesthetic it would be exempt from the usual amplitude requirements.

d) It is possible to perform a reverse Stützkehre on Parallel Bars through a handstand but that is essentially a different element (it is listed as such in the Difficulty Tables) and should not become the regular expectation for a reverse Stützkehre.

e) There exist a small number of elements (bent arm vs. straight arm press on several apparatus; amplitude on scales on Floor Exercise; V-sits vs. high V-sits (Manna) on several apparatus; planche vs. swallow on Rings) where intermediate positions make recognition for the D-Jury and evaluation difficult for the E-Jury. The gymnast is expected to show his intended position or performance so distinctly and conspicuously as to leave no doubt about the intent. Intermediate or non-distinct positions are always deducted by the E-Jury and may lead to non-recognition by the D-Jury.

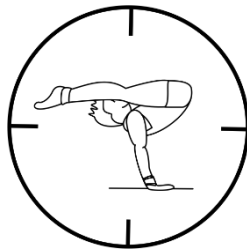

Perfect Manna



0.1 Deduction

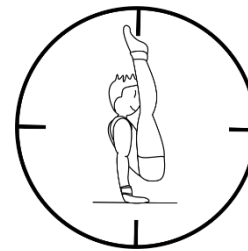

Perfect V-Sit

5.5) Parts of the pommel horse.

To assist in the definition of circles and travels in side support or cross support, the parts of the horse are defined according to the following diagrams.

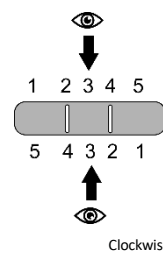
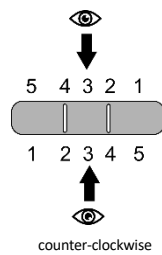

Elements in Side Support

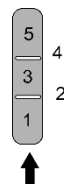

Elements in Cross Support

