



**ROYAL CANADIAN ARMY CADETS**

## **SILVER STAR INSTRUCTIONAL GUIDES**

(ENGLISH)

(Supersedes A-CR-CCP-703/PF-001 dated 2015-09-01)

Cette publication est disponible en français sous le numéro A-CR-CCP-703/PF-002.

**Issued on Authority of the Chief of the Defence Staff**

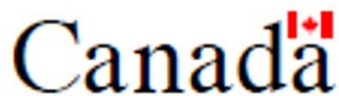



### NOTICE

This documentation has been reviewed by the technical authority and does not contain controlled goods. Disclosure notices and handling instructions originally received with the document shall continue to apply.

### AVIS

Cette documentation a été révisée par l'autorité technique et ne contient pas de marchandises contrôlées. Les avis de divulgation et les instructions de manutention reçues originalement doivent continuer de s'appliquer.



## **ROYAL CANADIAN ARMY CADETS**

**BOOK 1 OF 2**

# **SILVER STAR INSTRUCTIONAL GUIDES**

(ENGLISH)

(Supersedes A-CR-CCP-703/PF-001 dated 2015-09-01)

Cette publication est disponible en français sous le numéro A-CR-CCP-703/PF-002.

**Issued on Authority of the Chief of the Defence Staff**

**LIST OF EFFECTIVE PAGES**

Insert latest changed pages; dispose of superseded pages in accordance with applicable orders.

**NOTE**

On a changed page, the portion of the text affected by the latest change is indicated by a vertical line in the margin of the page. Changes to illustrations by miniature pointing hands, or black vertical lines.

Dates of issue for original and changed pages are:

Original .....	0 .....	2016-09-01	Change .....	3 .....
Change .....	1 .....		Change .....	4 .....
Change .....	2 .....		Change .....	5 .....

Zero in Change No. column indicates an original page. Total number of pages in this publication is 826, consisting of the following:

<b>Page No.</b>	<b>Change No.</b>	<b>Page No.</b>	<b>Change No.</b>
<b>BOOK 1</b>		3O-1 to 3O-48 .....	0
Cover page .....	0	3P-1 to 3P-52 .....	0
Title .....	0	3Q-1 to 3Q-2 .....	0
A to C .....	0	3R-1 to 3R-2 .....	0
i to x .....	0	3S-1 to 3S-2 .....	0
1-X01-1/2 .....	0	4-X04-1/2 .....	0
1-X01-1 to 1-X01-2 .....	0	4-X04-1 to 4-X04-2 .....	0
2-X02-1/2 .....	0	5-X05-1/2 .....	0
2-X02-1 to 2-X02-2 .....	0	5-X05-1 to 5-X05-2 .....	0
3-303-1/2 .....	0	6-306-1/2 .....	0
3-M303.01-1 to 3-M303.01-12.....	0	6-M306.01-1 to 6-M306.01-6.....	0
3-M303.02-1 to 3-M303.02-6.....	0	6-C306.01-1 to 6-C306.01-8.....	0
3-M303.03-1 to 3-M303.03-6.....	0	6-C306.02-1 to 6-C306.02-8.....	0
3-M303.04-1 to 3-M303.04-12.....	0	6-C306.03-1 to 6-C306.03-12.....	0
3-M303.05-1 to 3-M303.05-8.....	0	6A-1 to 6A-2 .....	0
3-M303.06-1 to 3-M303.06-6.....	0	6B-1 to 6B-2 .....	0
3-M303.07-1 to 3-M303.07-14.....	0	6C-1 to 6C-2 .....	0
3-C303.01-1 to 3-C303.01-14.....	0	6D-1 to 6D-2 .....	0
3-C303.02-1 to 3-C303.02-4.....	0	6E-1 to 6E-2 .....	0
3A-1 to 3A-2 .....	0	6F-1 to 6F-2 .....	0
3B-1 to 3B-2 .....	0	6G-1 to 6G-2 .....	0
3C-1 to 3C-2 .....	0	6H-1 to 6H-2 .....	0
3D-1 to 3D-2 .....	0	6I-1 to 6I-2 .....	0
3E-1 to 3E-4 .....	0	6J-1 to 6J-2 .....	0
3F-1 to 3F-4 .....	0	6K-1 to 6K-2 .....	0
3G-1 to 3G-2 .....	0	6L-1 to 6L-2 .....	0
3H-1 to 3H-2 .....	0	6M-1 to 6M-2 .....	0
3I-1 to 3I-2 .....	0	7-307-1/2 .....	0
3J-1 to 3J-50 .....	0	7-M307.01-1 to 7-M307.01-8.....	0
3K-1 to 3K-8 .....	0	7-M307.02-1 to 7-M307.02-8.....	0
3L-1 to 3L-28 .....	0	7-M307.03-1 to 7-M307.03-8.....	0
3M-1 to 3M-2 .....	0	7-C307.01-1 to 7-C307.01-2.....	0
3N-1 to 3N-10 .....	0	7-C307.02-1 to 7-C307.02-2.....	0





## LIST OF EFFECTIVE PAGES (CONT)

Page No.	Change No.	Page No.	Change No.
13A-1 to 13A-2 .....	0	15-325-1/2 .....	0
13B-1 to 13B-2 .....	0	15-M325.01-1 to 15-M325.01-12 .....	0
13C-1 to 13C-2 .....	0	15-M325.02-1 to 15-M325.02-14 .....	0
13D-1 to 13D-2 .....	0	15-M325.03-1 to 15-M325.03-10 .....	0
13E-1 to 13E-2 .....	0	15-C325.01-1 to 15-C325.01-18 .....	0
13F-1 to 13F-2 .....	0	15-C325.02-1 to 15-C325.02-8 .....	0
14-324-1/2 .....	0	15A-1 to 15A-2 .....	0
14-M324.01-1 to 14-M324.01-10 .....	0	15B-1 to 15B-2 .....	0
14-M324.02-1 to 14-M324.02-10 .....	0	15C-1 to 15C-2 .....	0
14-M324.03-1 to 14-M324.03-12 .....	0	15D-1 to 15D-2 .....	0
14-M324.04-1 to 14-M324.04-14 .....	0	15E-1 to 15E-2 .....	0
14-M324.05-1 to 14-M324.05-14 .....	0	15F-1 to 15F-6 .....	0
14-C324.01-1 to 14-C324.01-14 .....	0	15G-1 to 15G-4 .....	0
14-C324.02-1 to 14-C324.02-12 .....	0	15H-1 to 15H-2 .....	0
14-C324.03-1 to 14-C324.03-14 .....	0	15I-1 to 15I-2 .....	0
14-C324.04-1 to 14-C324.04-22 .....	0	15J-1 to 15J-6 .....	0
14-C324.05-1 to 14-C324.05-16 .....	0	16-326-1/2 .....	0
14A-1 to 14A-2 .....	0	16-M326.01-1 to 16-M326.01-10 .....	0
14B-1 to 14B-2 .....	0	16-M326.02A-1 to 16-M326.02A-38 .....	0
14C-1 to 14C-2 .....	0	16-M326.02B-1 to 16-M326.02B-32 .....	0
14D-1 to 14D-2 .....	0	16-M326.02C-1 to 16-M326.02C-24 .....	0
14E-1 to 14E-2 .....	0	16-M326.03-1 to 16-M326.03-12 .....	0
14F-1 to 14F-8 .....	0	16-M326.04-1 to 16-M326.04-12 .....	0
14G-1 to 14G-2 .....	0	16-M326.05-1 to 16-M326.05-14 .....	0
14H-1 to 14H-2 .....	0	16-M326.06-1 to 16-M326.06-16 .....	0
14I-1 to 14I-2 .....	0	16-M326.07-1 to 16-M326.07-8 .....	0
14J-1 to 14J-6 .....	0	16A-1 to 16A-6 .....	0

## FOREWORD AND PREFACE

1. **Issuing Authority.** This Instructional Guide (IG) A-CR-CCP-703/PF-001 was developed under the authority of the Director Cadets and Junior Canadian Rangers, and issued on the authority of the Chief of Defence Staff.
2. **Development.** Development of this IG was in accordance with the performance oriented concept of training outlined in the A-P9-050 Series, Canadian Forces Individual Training and Education System, with modifications to meet the needs of the Canadian Cadet Organization.
3. **Purpose of the IG.** The IG to be used by Royal Canadian Army Cadet Corps in conjunction with other resources to conduct the Silver Star Program. The IG provides instructors with the base means from which to deliver training. Individual IGs are to be reviewed in conjunction with the Lesson Specifications (LSs) found in A-CR-CCP-703/PG-001, *Royal Canadian Army Cadets – Silver Star – Qualification Standard and Plan*, Chapter 4, before instructing, so that each instructor can adequately plan for and prepare each lesson. Instructors may be required to develop instructional materials to support training in addition to any that may be provided, eg, posters, videos, handouts, models, etc, supplemental to training control and support documents. Suggested instructional activities are included in most IGs to maximize learning and fun. Instructors are also encouraged to modify and/or enhance the activities, as long as they continue to contribute to enabling objective achievement.
4. **Use of the IG.** Throughout these instructional guides, a series of information boxes are used to highlight information; they include:



Note to the Instructor.



Key information to pass along to cadets.



Refer to the following CF regulations and policies.

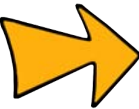

Points of interest or special instructions the instructor should pass along to cadets.

5. **Suggested Changes.** Suggested changes to this document may be sent directly to [cadetraining@canada.ca](mailto:cadetraining@canada.ca).

THIS PAGE INTENTIONALLY LEFT BLANK

## TABLE OF CONTENTS

## PAGE

## BOOK 1

<b>CHAPTER 1</b>	<b>PO X01 – PARTICIPATE IN CITIZENSHIP ACTIVITIES</b>	1-X01-1/2
<b>CHAPTER 2</b>	<b>PO X02 – PERFORM COMMUNITY SERVICE</b>	2-X02-1/2
<b>CHAPTER 3</b>	<b>PO 303 – PERFORM THE ROLE OF A TEAM LEADER</b>	3-303-1/2
Section 1	EO M303.01 – DEFINE THE ROLE OF A TEAM LEADER.....	3-M303.01-1
Section 2	EO M303.02 – PARTICIPATE IN A MENTORING RELATIONSHIP.....	3-M303.02-1
Section 3	EO M303.03 – PRACTICE SELF-ASSESSMENT.....	3-M303.03-1
Section 4	EO M303.04 – COMMUNICATE AS A TEAM LEADER.....	3-M303.04-1
Section 5	EO M303.05 – SUPERVISE CADETS.....	3-M303.05-1
Section 6	EO M303.06 – SOLVE PROBLEMS.....	3-M303.06-1
Section 7	EO M303.07 – LEAD CADETS THROUGH A LEADERSHIP ASSIGNMENT.....	3-M303.07-1
Section 8	EO C303.01 – LEAD A TEAM-BUILDING ACTIVITY.....	3-C303.01-1
Section 9	EO C303.02 – DELIVER A PRESENTATION ABOUT A LEADER.....	3-C303.02-1
Annex A	LEADERSHIP TEAM MODEL.....	3A-1
Annex B	EXPECTATIONS OF A SILVER STAR CADET.....	3B-1
Annex C	SELF-ASSESSMENT RUBRICS.....	3C-1
Annex D	COMMUNICATION PUZZLE.....	3D-1
Annex E	PROBLEM-SOLVING SCENARIOS.....	3E-1
Annex F	POSSIBLE YEAR THREE COMMON LEADERSHIP ASSIGNMENTS...	3F-1
Annex G	SAMPLE LEADERSHIP ASSIGNMENT.....	3G-1
Annex H	LEADERSHIP ASSIGNMENT FORMAT.....	3H-1
Annex I	AFTER-ASSIGNMENT REPORT AND ASSESSMENT RUBRIC.....	3I-1
Annex J	LEADERSHIP ASSIGNMENTS.....	3J-1
Annex K	SAMPLE STRETCHES.....	3K-1
Annex L	LEADERSHIP ASSIGNMENTS.....	3L-1
Annex M	LEADERSHIP ASSIGNMENT PLANNING GUIDE.....	3M-1
Annex N	LESSON ACTIVITIES.....	3N-1
Annex O	ENERGIZERS AND ICEBREAKERS.....	3O-1
Annex P	COMMUNICATION, PROBLEM-SOLVING AND TRUST-BUILDING.....	3P-1
Annex Q	TEAM-BUILDING PLANNING GUIDE.....	3Q-1
Annex R	SELF-ASSESSMENT FORM – LEAD A TEAM-BUILDING ACTIVITY....	3R-1
Annex S	OUTLINE FOR DELIVERING A PRESENTATION ABOUT A LEADER..	3S-1

## TABLE OF CONTENTS (Cont)

		<b>PAGE</b>
<b>CHAPTER 4</b>	<b>PO X04 – TRACK PARTICIPATION IN PHYSICAL ACTIVITIES</b>	4-X04-1/2
<b>CHAPTER 5</b>	<b>PO X05 – PARTICIPATE IN PHYSICAL ACTIVITIES</b>	5-X05-1/2
<b>CHAPTER 6</b>	<b>PO 306 – FIRE THE CADET AIR RIFLE DURING RECREATIONAL MARKSMANSHIP</b>	6-306-1/2
Section 1	EO M306.01 – PARTICIPATE IN A RECREATIONAL MARKSMANSHIP ACTIVITY.....	6-M306.01-1
Section 2	EO C306.01 – IDENTIFY CIVILIAN MARKSMANSHIP ORGANIZATIONS.....	6-C306.01-1
Section 3	EO C306.02 – CORRECT MARKSMANSHIP ERROR.....	6-C306.02-1
Section 4	EO C306.03 – ADOPT THE STANDING POSITION WITH THE CADET AIR RIFLE.....	6-C306.03-1
Annex A	CLASSIFICATION ACTIVITY.....	6A-1
Annex B	FUN ACTIVITIES – PYRAMID.....	6B-1
Annex C	FUN ACTIVITIES – SHOOTING STAR.....	6C-1
Annex D	FUN ACTIVITIES – BEACH BALL.....	6D-1
Annex E	FUN ACTIVITIES – BALLOONS.....	6E-1
Annex F	TIMED ACTIVITIES – CHASE THE DOTS.....	6F-1
Annex G	TIMED ACTIVITIES – SPEED GRID.....	6G-1
Annex H	TIMED ACTIVITIES – BEAT THE CLOCK.....	6H-1
Annex I	COMPETITIVE ACTIVITIES – CORPS MARKSMANSHIP COMPETITION.....	6I-1
Annex J	COMPETITIVE ACTIVITIES – LUNAR LAUNCH.....	6J-1
Annex K	MPI EXAMPLES.....	6K-1
Annex L	SIGHT ADJUSTMENT ACTIVITY.....	6L-1
Annex M	SIGHT ADJUSTMENT ACTIVITY ANSWER KEY.....	6M-1
<b>CHAPTER 7</b>	<b>PO 307 – SERVE IN AN ARMY CADET CORPS</b>	7-307-1/2
Section 1	EO M307.01 – IDENTIFY SILVER STAR TRAINING OPPORTUNITIES	7-M307.01-1
Section 2	EO M307.02 – IDENTIFY YEAR THREE CSTC TRAINING OPPORTUNITIES.....	7-M307.02-1
Section 3	EO M307.03 – RECOGNIZE THE PARTNERSHIP BETWEEN THE ARMY CADET LEAGUE OF CANADA (ACLC) AND THE DEPARTMENT OF NATIONAL DEFENCE (DND).....	7-M307.03-1
Section 4	EO C307.01 – PARTICIPATE IN A PRESENTATION GIVEN BY A GUEST SPEAKER FROM THE REGIONAL CADET SUPPORT UNIT..	7-C307.01-1
Section 5	EO C307.02 – PARTICIPATE IN A PRESENTATION GIVEN BY THE CADET LIAISON OFFICER.....	7-C307.02-1
Section 6	EO C307.03 – PARTICIPATE IN A PRESENTATION GIVEN BY A GUEST SPEAKER FROM THE ARMY CADET LEAGUE OF CANADA.	7-C307.03-1

## TABLE OF CONTENTS (Cont)

		<b>PAGE</b>
Annex A	FULL VALUE CONTRACT.....	7A-1
<b>CHAPTER 8</b>	<b>PO 308 – DIRECT A SQUAD PRIOR TO A PARADE</b>	8-308-1/2
Section 1	EO M308.01 – PREPARE A SQUAD FOR PARADE.....	8-M308.01-1
Section 2	EO M308.02 – DELIVER WORDS OF COMMAND.....	8-M308.02-1
Section 3	EO C308.01 – EXECUTE FLAG DRILL.....	8-C308.01-1
Section 4	EO C308.02 – DELIVER WORDS OF COMMAND.....	8-C308.02-1
Annex A	DRILL SEQUENCE HANDOUT (PREPARING A SQUAD FOR PARADE).....	8A-1
Annex B	AIDE-MÉMOIRE CARD.....	8B-1
<b>CHAPTER 9</b>	<b>PO 309 – INSTRUCT A LESSON</b>	9-309-1/2
Section 1	EO M309.01 – EXPLAIN THE PRINCIPLES OF INSTRUCTION.....	9-M309.01-1
Section 2	EO M309.02 – IDENTIFY METHODS OF INSTRUCTION.....	9-M309.02-1
Section 3	EO M309.03 – DESCRIBE EFFECTIVE-SPEAKING TECHNIQUES.....	9-M309.03-1
Section 4	EO M309.04 – DESCRIBE QUESTIONING TECHNIQUES.....	9-M309.04-1
Section 5	EO M309.05 – SELECT APPROPRIATE INSTRUCTIONAL AIDS.....	9-M309.05-1
Section 6	EO M309.06 – PLAN A LESSON.....	9-M309.06-1
Section 7	EO M309.07 – INSTRUCT A 15-MINUTE LESSON.....	9-M309.07-1
Section 8	EO C309.01 – DELIVER A ONE-MINUTE VERBAL PRESENTATION...	9-C309.01-1
Section 9	EO C309.02 – PLAN A LESSON.....	9-C309.02-1
Section 10	EO C309.03 – INSTRUCT A 15-MINUTE LESSON.....	9-C309.03-1
Section 11	EO C309.04 – IDENTIFY FORMATIONS FOR DRILL INSTRUCTION...	9-C309.04-1
Section 12	EO C309.05 – PLAN A DRILL LESSON.....	9-C309.05-1
Section 13	EO C309.06 – INSTRUCT A 15-MINUTE DRILL LESSON.....	9-C309.06-1
Annex A	PRINCIPLES OF INSTRUCTION INFORMATION SHEET.....	9A-1
Annex B	PRINCIPLES OF INSTRUCTION WORKSHEETS.....	9B-1
Annex C	METHODS OF INSTRUCTION.....	9C-1
Annex D	SELECT A METHOD OF INSTRUCTION.....	9D-1
Annex E	POSING QUESTIONS SEQUENCE.....	9E-1
Annex F	QUESTIONS HANDOUT.....	9F-1
Annex G	POSING QUESTIONS RUBRIC.....	9G-1
Annex H	POSING QUESTIONS CHECKLIST.....	9H-1
Annex I	COMMON INSTRUCTIONAL AIDS.....	9I-1
Annex J	INSTRUCTIONAL AIDS WORKSHEETS.....	9J-1
Annex K	LESSON SPECIFICATION AND INSTRUCTIONAL GUIDE HANDOUT	9K-1
Annex L	LESSON PLAN.....	9L-1
Annex M	PLAN A LESSON CHECKLIST.....	9M-1

**TABLE OF CONTENTS (Cont)**

	<b>PAGE</b>
Annex N	LIST OF APPROVED 15-MINUTE TOPICS..... 9N-1
Annex O	MODIFIED LESSON SPECIFICATIONS AND INSTRUCTIONAL GUIDES – TP 1 OF EO M104.01..... 9O-1
Annex P	MODIFIED LESSON SPECIFICATIONS AND INSTRUCTIONAL GUIDES – TP 1 OF EO M106.01..... 9P-1
Annex Q	MODIFIED LESSON SPECIFICATIONS AND INSTRUCTIONAL GUIDES – TP 4 OF EO M106.03..... 9Q-1
Annex R	MODIFIED LESSON SPECIFICATIONS AND INSTRUCTIONAL GUIDES – TP 1 OF EO M203.01..... 9R-1
Annex S	MODIFIED LESSON SPECIFICATIONS AND INSTRUCTIONAL GUIDES – TP 1 OF EO M107.02..... 9S-1
Annex T	MODIFIED LESSON SPECIFICATIONS AND INSTRUCTIONAL GUIDES – TP 1 OF EO M107.04..... 9T-1
Annex U	MODIFIED LESSON SPECIFICATIONS AND INSTRUCTIONAL GUIDES – TP 1 OF EO M222.02..... 9U-1
Annex V	MODIFIED LESSON SPECIFICATIONS AND INSTRUCTIONAL GUIDES – TP 1 OF EO M222.03..... 9V-1
Annex W	MODIFIED LESSON SPECIFICATIONS AND INSTRUCTIONAL GUIDES – TP 1 OF EO M122.01..... 9W-1
Annex X	MODIFIED LESSON SPECIFICATIONS AND INSTRUCTIONAL GUIDES – TP 1 OF EO M221.05..... 9X-1
Annex Y	MODIFIED LESSON SPECIFICATIONS AND INSTRUCTIONAL GUIDES – TP 1 OF EO M221.09..... 9Y-1
Annex Z	MODIFIED LESSON SPECIFICATIONS AND INSTRUCTIONAL GUIDES – TP 1 OF EO M122.05..... 9Z-1
Annex AA	MODIFIED LESSON SPECIFICATIONS AND INSTRUCTIONAL GUIDES – TP 1 OF EO M121.02..... 9AA-1
Annex AB	MODIFIED LESSON SPECIFICATIONS AND INSTRUCTIONAL GUIDES – TP 1 OF EO M222.02..... 9AB-1
Annex AC	INSTRUCTIONAL TECHNIQUES – ASSESSMENT FORM..... 9AC-1
Annex AD	LIST OF TOPICS..... 9AD-1
Annex AE	VERBAL PRESENTATION – FEEDBACK FORM..... 9AE-1
Annex AF	THE LESSON PLAN..... 9AF-1
Annex AG	DRILL LESSON PLAN..... 9AG-1
Annex AH	PLAN A DRILL LESSON CHECKLIST..... 9AH-1
Annex AI	LIST OF APPROVED 15-MINUTE DRILL TOPICS..... 9AI-1
Annex AJ	MODIFIED LESSON SPECIFICATIONS AND INSTRUCTIONAL GUIDES – TP 1 AND 2 OF EO M108.01..... 9AJ-1
Annex AK	MODIFIED LESSON SPECIFICATIONS AND INSTRUCTIONAL GUIDES – TP 1 AND 2 OF EO M108.01..... 9AK-1



**TABLE OF CONTENTS (Cont)**

		<b>PAGE</b>
Annex AL	MODIFIED LESSON SPECIFICATIONS AND INSTRUCTIONAL GUIDES – TP 1 OF EO M108.02.....	9AL-1
Annex AM	MODIFIED LESSON SPECIFICATIONS AND INSTRUCTIONAL GUIDES – TP 1 OF EO M108.02.....	9AM-1
Annex AN	MODIFIED LESSON SPECIFICATIONS AND INSTRUCTIONAL GUIDES – TP 1 OF EO M108.03.....	9AN-1
Annex AO	MODIFIED LESSON SPECIFICATIONS AND INSTRUCTIONAL GUIDES – TP 1 OF EO M108.03.....	9AO-1
Annex AP	MODIFIED LESSON SPECIFICATIONS AND INSTRUCTIONAL GUIDES – TP 1 OF EO M108.03.....	9AP-1
Annex AQ	DRILL INSTRUCTIONAL TECHNIQUES – ASSESSMENT FORM.....	9AQ-1
<b>CHAPTER 10</b>	<b>PO 311 – PARTICIPATE IN A RECREATIONAL SUMMER BIATHLON ACTIVITY</b>	10-311-1/2
Section 1	EO C311.01 – PRACTICE AIMING AND FIRING THE CADET AIR RIFLE FOLLOWING PHYSICAL ACTIVITY.....	10-C311.01-1
Section 2	EO C311.02 – PARTICIPATE IN A RECREATIONAL SUMMER BIATHLON ACTIVITY.....	10-C311.02-1
Annex A	SAMPLE STRETCHES.....	10A-1
Annex B	GUIDELINES TO CONDUCT A RECREATIONAL SUMMER BIATHLON ACTIVITY.....	10B-1
Annex C	BIATHLON SCORESHEET.....	10C-1
Annex D	COURSE CONTROL SHEET.....	10D-1
Annex E	RANGE RECORDING SHEET.....	10E-1
<b>BOOK 2</b>		
<b>CHAPTER 11</b>	<b>PO X20 – PARTICIPATE IN CAF FAMILIARIZATION</b>	11-X20-1/2
<b>CHAPTER 12</b>	<b>PO 321 – PERFORM THE DUTIES OF A TEAM LEADER ON A WEEKEND BIVOUAC EXERCISE</b>	12-321-1/2
Section 1	EO M321.01 – PERFORM THE DUTIES OF A TEAM LEADER IN THE FIELD.....	12-M321.01-1
Section 2	EO M321.02 – CONSTRUCT COMPONENTS OF A BIVOUAC SITE....	12-M321.02-1
Section 3	EO C321.01 – IDENTIFY METHODS OF WASTE DISPOSAL IN THE FIELD.....	12-C321.01-1
Section 4	EO C321.02 – IDENTIFY SAFETY CONSIDERATIONS WHEN TRAVELLING OVER SNOW AND ICE.....	12-C321.02-1
Section 5	EO C321.03 – CONSTRUCT FIELD AMENITIES.....	12-C321.03-1
Annex A	SAMPLE BIVOUAC SITE DIAGRAM HANDOUT.....	12A-1
Annex B	FIELD AMENITIES.....	12B-1

## TABLE OF CONTENTS (Cont)

		<b>PAGE</b>
<b>CHAPTER 13</b>	<b>PO 322 – PLOT LOCATION ON A TOPOGRAPHICAL MAP USING A GLOBAL POSITIONING SYSTEM RECEIVER</b>	13-322-1/2
Section 1	EO M322.01 – REVIEW RED STAR NAVIGATION.....	13-M322.01-1
Section 2	EO M322.02 – CALCULATE MAGNETIC DECLINATION.....	13-M322.02-1
Section 3	EO M322.03 – IDENTIFY COMPONENTS OF THE GLOBAL POSITIONING SYSTEM (GPS).....	13-M322.03-1
Section 4	EO M322.04 – IDENTIFY FEATURES OF A GLOBAL POSITIONING SYSTEM (GPS) RECEIVER.....	13-M322.04-1
Section 5	EO M322.05 – SET A MAP DATUM ON A GLOBAL POSITIONING SYSTEM (GPS) RECEIVER.....	13-M322.05-1
Section 6	EO M322.06 – IDENTIFY LOCATION USING A GLOBAL POSITIONING SYSTEM (GPS) RECEIVER.....	13-M322.06-1
Section 7	EO C322.01 – PRACTICE NAVIGATION AS A MEMBER OF A SMALL GROUP.....	13-C322.01-1
Section 8	EO C322.02 – IDENTIFY FACTORS THAT IMPACT NAVIGATION IN THE WINTER.....	13-C322.02-1
Section 9	EO C322.03 – IDENTIFY THE PRINCIPLES OF MAP-MAKING.....	13-C322.03-1
Section 10	EO C322.04 – DRAW A MAP OF AN AREA IN THE LOCAL TRAINING FACILITY.....	13-C322.04-1
Annex A	DECLINATION PROBLEM WORKSHEET.....	13A-1
Annex B	ANSWER KEY TO DECLINATION PROBLEM WORKSHEET.....	13B-1
Annex C	SIMULATED MAP DATUM.....	13C-1
Annex D	GRID OVERLAY.....	13D-1
Annex E	CANADIAN UTM ZONES.....	13E-1
Annex F	GRAPH PAPER.....	13F-1
<b>CHAPTER 14</b>	<b>PO 324 – SURVIVE WHEN LOST</b>	14-324-1/2
Section 1	EO M324.01 – CONSTRUCT AN IMPROVISED SHELTER.....	14-M324.01-1
Section 2	EO M324.02 – COLLECT DRINKING WATER.....	14-M324.02-1
Section 3	EO M324.03 – LIGHT A FIRE WITHOUT MATCHES.....	14-M324.03-1
Section 4	EO M324.04 – PREDICT WEATHER.....	14-M324.04-1
Section 5	EO M324.05 – DETERMINE WHEN TO SELF-RESCUE.....	14-M324.05-1
Section 6	EO C324.01 – IDENTIFY ANIMAL AND INSECT FOOD SOURCES.....	14-C324.01-1
Section 7	EO C324.02 – CONSTRUCT SNARES.....	14-C324.02-1
Section 8	EO C324.03 – CATCH A FISH.....	14-C324.03-1
Section 9	EO C324.04 – COLLECT EDIBLE PLANTS.....	14-C324.04-1
Section 10	EO C324.05 – PREPARE A MEAL FROM FIELD FOOD SOURCES.....	14-C324.05-1
Annex A	BOW AND DRILL.....	14A-1
Annex B	FIRE SAW.....	14B-1

## TABLE OF CONTENTS (Cont)

		<b>PAGE</b>
Annex C	FLINT AND STEEL.....	14C-1
Annex D	SUN AND GLASS.....	14D-1
Annex E	COMMON TYPES OF CLOUDS.....	14E-1
Annex F	COMMON HABITAT.....	14F-1
Annex G	INSECT NUTRITIONAL VALUE CHART.....	14G-1
Annex H	COMMON POISONOUS PLANTS.....	14H-1
Annex I	COMMON POISONOUS PLANTS.....	14I-1
Annex J	METHODS OF FIELD COOKING HANDOUT.....	14J-1
<b>CHAPTER 15</b>	<b>PO 325 – IDENTIFY THE COMPETENCIES OF AN OUTDOOR LEADER</b>	<b>15-325-1/2</b>
Section 1	EO M325.01 – PARTICIPATE IN A DISCUSSION ON ARMY CADET EXPEDITION TRAINING.....	15-M325.01-1
Section 2	EO M325.02 – LIST THE COMPETENCIES OF AN OUTDOOR LEADER (OL).....	15-M325.02-1
Section 3	EO M325.03 – DISCUSS SELF-AWARENESS AND PROFESSIONAL CONDUCT AS A COMPETENCY OF AN OUTDOOR LEADER (OL).....	15-M325.03-1
Section 4	EO C325.01 – COMMUNICATE DURING AN EXPEDITION.....	15-C325.01-1
Section 5	EO C325.02 – PARTICIPATE IN A PRESENTATION ON THE DUKE OF EDINBURGH AWARD PROGRAM.....	15-C325.02-1
Annex A	SCENARIO.....	15A-1
Annex B	INFORMATION CARD A.....	15B-1
Annex C	INFORMATION CARD B.....	15C-1
Annex D	INFORMATION CARD C.....	15D-1
Annex E	EXPERT ACTIVITY SHEET.....	15E-1
Annex F	COMPETENCIES OF AN OUTDOOR LEADER HANDOUT.....	15F-1
Annex G	HOMEWORK ASSIGNMENT.....	15G-1
Annex H	SCENARIO.....	15H-1
Annex I	PHONETIC ALPHABET AND PRONUNCIATION OF NUMBERS HANDOUT.....	15I-1
Annex J	RADIO COMMUNICATION EXERCISE.....	15J-1
<b>CHAPTER 16</b>	<b>PO 326 – PERFORM EXPEDITION SKILLS</b>	<b>16-326-1/2</b>
Section 1	EO M326.01 – PREPARE FOR EXPEDITION TRAINING.....	16-M326.01-1
Section 2	EO M326.02A – PADDLE A CANOE.....	16-M326.02A-1
Section 3	EO M326.02B – RIDE A MOUNTAIN BIKE.....	16-M326.02B-1
Section 4	EO M326.02C – HIKE ALONG A ROUTE.....	16-M326.02C-1
Section 5	EO M326.03 – PRACTICE ENVIRONMENTAL STEWARDSHIP AS A TEAM LEADER.....	16-M326.03-1

**TABLE OF CONTENTS (Cont)**

		<b>PAGE</b>
Section 6	EO M326.04 – NAVIGATE ALONG A ROUTE USING A MAP AND COMPASS.....	16-M326.04-1
Section 7	EO M326.05 – USE EXPEDITION EQUIPMENT.....	16-M326.05-1
Section 8	EO M326.06 – FOLLOW DAILY ROUTINE.....	16-M326.06-1
Section 9	EO M326.07 – RECORD ENTRIES IN A JOURNAL.....	16-M326.07-1
Annex A	SILVER STAR EXPEDITION JOURNAL.....	16A-1

**CHAPTER 1**

**PO X01 – PARTICIPATE IN CITIZENSHIP ACTIVITIES**





**COMMON TRAINING  
ALL TRAINING LEVELS  
INSTRUCTIONAL GUIDE  
CITIZENSHIP**



**PO X01 – PARTICIPATE IN CITIZENSHIP ACTIVITIES**

---

Total Time:

---

For the following EOs, refer to the lesson specifications located in A-CR-CCP-701/PG-001, *Royal Canadian Army Cadets Green Star Qualification Standard and Plan*:

- MX01.01A – Participate in a Citizenship Tour,
- MX01.01B – Attend a Presentation by a Community Organization,
- MX01.01C – Attend a Presentation by a Citizen-of-Interest,
- MX01.01D – Participate in the Canadian Citizenship Challenge,
- MX01.01E – Host a Citizenship Ceremony, and
- CX01.01 – Participate in Citizenship Activities.

For the following EOs, refer to the instructional guides located in A-CR-CCP-701/PF-001, *Royal Canadian Army Cadets Green Star Instructional Guides*:

- MX01.01F – Participate in an Election,
- MX01.01G – Participate in Heritage Minutes Video Activities, and
- MX01.01H – Participate in Citizenship Learning Stations.

THIS PAGE INTENTIONALLY LEFT BLANK



**CHAPTER 2**  
**PO X02 – PERFORM COMMUNITY SERVICE**





**COMMON TRAINING  
ALL TRAINING LEVELS  
INSTRUCTIONAL GUIDE  
COMMUNITY SERVICE**



**PO X02 – PERFORM COMMUNITY SERVICE**

---

Total Time:

---

For the following EOs, refer to the instructional guides located in A-CR-CCP-701/PF-001, *Royal Canadian Army Cadets Green Star Instructional Guides*:

- MX02.01 – Perform Community Service, and
- CX02.01 – Perform Community Service.

THIS PAGE INTENTIONALLY LEFT BLANK

**CHAPTER 3**

**PO 303 – PERFORM THE ROLE OF A TEAM LEADER**





**COMMON TRAINING  
SILVER STAR  
INSTRUCTIONAL GUIDE**



**SECTION 1**

**EO M303.01 – DEFINE THE ROLE OF A TEAM LEADER**

---

Total Time:

60 min

---

**PREPARATION**

---

**PRE-LESSON INSTRUCTIONS**

Resources needed for the delivery of this lesson are listed in the lesson specification located in A-CR-CCP-703/PG-001, Chapter 4. Specific uses for said resources are identified throughout the instructional guide within the TP for which they are required.

Review the lesson content and become familiar with the material prior to delivering the lesson.

Photocopy the handouts located at Annexes A and B for each cadet.

**PRE-LESSON ASSIGNMENT**

N/A.

**APPROACH**

An interactive lecture was chosen for this lesson to orient the cadets to the leadership team model, core leadership competencies and leadership opportunities for a Silver Star cadet.

---

**INTRODUCTION**

---

**REVIEW**

N/A.

**OBJECTIVES**

By the end of this lesson the cadet shall have defined the role of a team leader.

**IMPORTANCE**

It is important for cadets to define the role of a team leader so they understand how and where they fit within the leadership team model and within the leadership team at the corps. Being aware of the core leadership competencies, and the expectations within each of the competencies, may assist the cadets' developing leadership abilities while adapting to their developing role as a leader in their corps.

**Teaching Point 1****Explain the Leadership Team Model and the Position the Year Three Cadet Holds Within the Leadership Team**

Time: 10 min

Method: Interactive Lecture



Distribute the Leadership Team Model handout located at Annex A.

**LEADERSHIP TEAM MODEL**

Although leadership is usually thought of as an individual pursuit, in the Cadet Program, leadership is based on a team model.



The Leadership Team Model is a fluid model that is dependent on the situation to which it is applied. The personnel in each category of the model will change based on the activity/situation.

During year one, the cadet is expected to be a follower/team member. During year two, the cadet becomes a peer leader. In years three and four, the cadet moves up the model to become a team leader. In years five and beyond, the cadet becomes an activity leader.

The final level of the model is populated by the corps staff, who act as the activity managers.

As each cadet moves through the leadership team model, there are increased expectations of the cadet. Accordingly, there will be an increase in the cadet's leadership responsibilities.

Within the leadership team model, communication moves across each level, and up and down each level. Within this model, cadets on every level should be mentored by someone in the level above.

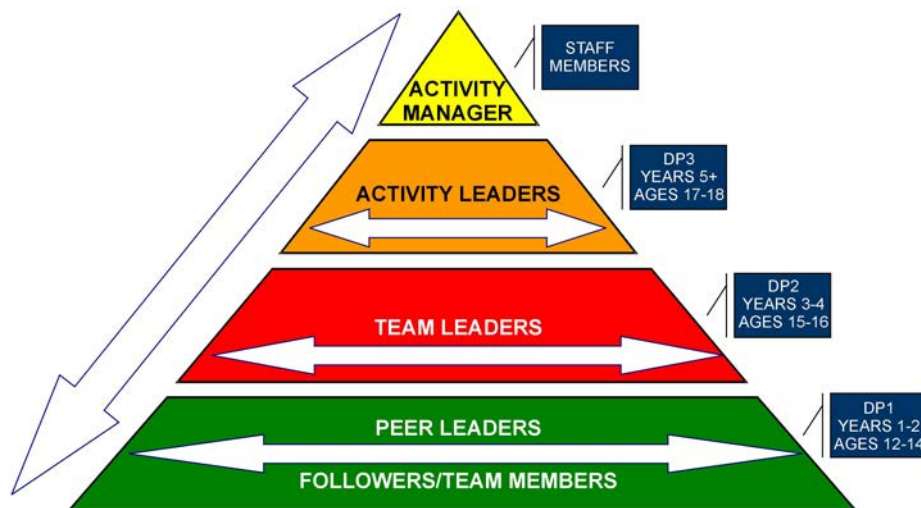
**THE LEADERSHIP TEAM MODEL**

*Director Cadets 3, 2008, Ottawa, ON: Department of National Defence*

Figure 3-1-1 Leadership Team Model



---

## CONFIRMATION OF TEACHING POINT 1

---

**QUESTIONS**

- Q1. The Cadet Program is based on what kind of leadership model?
- Q2. What is expected of the cadets in the bottom level of the leadership team model?
- Q3. As the cadet moves up the leadership model, what happens to their leadership responsibilities?

**ANTICIPATED ANSWERS**

- A1. The Cadet Program is based on a leadership team model.
- A2. Cadets are expected to be followers/team members and peer leaders.
- A3. Responsibilities increase as the cadet moves up the leadership team model.

---

**Teaching Point 2**
**Describe Core Leadership Competencies**

Time: 5 min

Method: Interactive Lecture



Distribute the Expectations of a Silver Star cadet handout located at Annex B.

**CORE LEADERSHIP COMPETENCIES**

To become an effective and capable leader in the Cadet Program, there are six areas where knowledge and skills should be demonstrated. These areas are called core leadership competencies. They include:

- intrapersonal management,
- interpersonal management,
- teamwork,
- effective communication,
- applied leadership, and
- mentorship.

---

## CONFIRMATION OF TEACHING POINT 2

---

**QUESTIONS**

- Q1. To become an effective and capable leader in the Cadet Program, there are six areas where knowledge and skills should be demonstrated. What are these called?
- Q2. List the six core leadership competencies.

**ANTICIPATED ANSWERS**

- A1. Core leadership competencies.

A2. The six core leadership competencies are:

- intrapersonal management,
- interpersonal management,
- teamwork,
- effective communication,
- applied leadership, and
- mentorship.

---

### Teaching Point 3

### Explain the Components of Intrapersonal Management

Time: 5 min

Method: Interactive Lecture

---



Have cadets follow along using the Expectations of a Silver Star cadet handout for TPs 3–8.

### COMPONENTS OF INTRAPERSONAL MANAGEMENT

Intrapersonal management is how cadets maintain control of themselves. There are five parts to intrapersonal management:

**Identifying and Satisfying Personal Needs.** Cadets should distinguish and accept responsibility for fulfilling their personal needs. Some examples of personal needs include filling basic needs like food and water, feeling safe, feeling like they belong, and having self-confidence. Once cadets know what needs they have, they should work toward satisfying them.

**Exercising Self-Control.** Cadets should practice self-restraint. It may be difficult but cadets should try not get too upset by situations in which they have no control. When cadets become irate or lose their temper, they give the power in the situation to someone else. If cadets keep their cool, better decisions are usually made.

**Exercising Self-Management.** Cadets should take charge of their own lives. Cadets need to be organized and direct themselves. Becoming independent (eg, being punctual, being dressed correctly, etc) is a natural part of becoming an adult.

**Pursuing Self-Improvement.** Cadets should strive for self-improvement. Always trying to be better than one was yesterday is a worthwhile goal. Whether one is a better cadet, better at school or a better friend, one should always strive for excellence.

**Establishing a Positive Identity.** Cadets should gain self-esteem. It is important to be proud of one's accomplishments. Knowing that one is a person that others look up to and want to spend time with, should make one feel proud of oneself.

---

### CONFIRMATION OF TEACHING POINT 3

---

### QUESTIONS

Q1. What is intrapersonal management?

Q2. What are the five components of intrapersonal management?

Q3. How may cadets exercise self-management?

### ANTICIPATED ANSWERS

A1. Intrapersonal management is how cadets control themselves.

A2. The five components of intrapersonal management are:

- identifying and satisfying personal needs;
- exercising self-control;
- exercising self-management;
- pursuing self-improvement; and
- establishing a positive identity.

A3. Cadets may exercise self-management by taking charge of their own lives.

---

### Teaching Point 4

### Explain the Components of Interpersonal Management

Time: 5 min

Method: Interactive Lecture

---

### COMPONENTS OF INTERPERSONAL MANAGEMENT

Interpersonal management is how cadets behave and along with others. There are three parts of interpersonal management:

**Interacting Positively Within the Cadet Community.** Cadets should work together with staff, parents, volunteers, etc in a respectful and helpful manner.

**Interacting Positively With Others.** Cadets should build positive social relationships by being supportive and encouraging while interacting with other cadets.

**Dealing With Interpersonal Conflict in a Respectful Way.** Cadets should resolve disagreements with others at the lowest possible level and come up with a mutually satisfactory solution where a “win-win” outcome is achieved.

---

### CONFIRMATION OF TEACHING POINT 4

---

### QUESTIONS

Q1. What is interpersonal management?

Q2. What are the three components of interpersonal management?

Q3. How should cadets resolve disagreements?

### ANTICIPATED ANSWERS

A1. Interpersonal management is how cadets behave and get along with others.

A2. The three components of interpersonal management are:

- interacting positively within the cadet community;
- interacting positively with others; and
- dealing with interpersonal conflict in a respectful way.

- A3. Cadets should resolve disagreements with others at the lowest possible level and come up with a mutually satisfactory solution where a “win-win” outcome is achieved.

---

**Teaching Point 5****Explain the Components of Teamwork**

Time: 5 min

Method: Interactive Lecture

---

**COMPONENTS OF TEAMWORK**

Teamwork is how cadets create effective and efficient action in a group of people. There are three parts of teamwork:

**Participating in the Stages of Team Development.** Cadets should take part in the stages of team development. The stages are forming, storming, norming, performing and adjourning.

**Displaying Positive Team Dynamics.** Cadets should demonstrate positive team dynamics by following the team leader, including all participants, encouraging team members, contributing to team morale and esprit de corps, contributing to the accomplishment of team goals, contributing to group decisions, trusting the team, supporting team members, appreciating team members, and celebrating team successes.

**Participating in Team-Building Activities.** Cadets should take part in team-building activities. These activities will build positive team dynamics and they allow cadets to practice leadership skills.

---

**CONFIRMATION OF TEACHING POINT 5**

---

**QUESTIONS**

- Q1. What is teamwork?
- Q2. What are the three components of teamwork?
- Q3. How may cadets display positive team dynamics?

**ANTICIPATED ANSWERS**

- A1. Teamwork is how cadets create effective and efficient action in a group of people.
- A2. The three components of teamwork are:
- participating in the stages of team development;
  - displaying positive team dynamics; and
  - participating in team-building activities.
- A3. Cadets may display positive team dynamics by following the team leader, including all participants, encouraging team members, contributing to team morale and esprit de corps, contributing to the accomplishment of team goals, contributing to group decisions, trusting the team, supporting team members, appreciating team members, and celebrating team successes.

---

**Teaching Point 6****Explain the Components of Effective Communication**

Time: 5 min

Method: Interactive Lecture

---

**COMPONENTS OF EFFECTIVE COMMUNICATION**

Effective communication is how cadets relay information successfully. There are three parts of effective communication:

**Receiving Information.** Cadets should be given or obtain instructions or facts. This information may be received verbally or in writing.

**Interpreting Information.** Cadets should comprehend the instructions or facts. To interpret information correctly, questions may be asked to the deliverer of the information to ensure clarity.

**Responding to Information.** Cadets should react to the instructions or facts. Responding to information may include passing on information to others, solving problems, etc.

---

**CONFIRMATION OF TEACHING POINT 6**

---

**QUESTIONS**

- Q1. What is effective communication?
- Q2. What are the three components of effective communication?
- Q3. In what ways may information be received?

**ANTICIPATED ANSWERS**

- A1. Effective communication is how cadets relay information successfully.
- A2. The three components of effective communication are:
- receiving information;
  - interpreting information; and
  - responding to information.
- A3. Information may be received verbally or in writing.
- 

**Teaching Point 7****Explain the Components of Applied Leadership**

Time: 5 min

Method: Interactive Lecture

---

**COMPONENTS OF APPLIED LEADERSHIP**

Applied leadership is how cadets practice influencing and managing others. There are six parts of applied leadership:

**Setting an Example for Others to Follow.** Cadets should establish themselves as a model for others. If cadets set an example in the core leadership competencies, others will want to imitate them.

**Participating in Leadership Assignments.** Cadets will take part in given tasks or jobs. This gives cadets chances to practice influencing and managing others. Some of these tasks or jobs will be evaluated by the

staff and some will not be evaluated. Cadets should practice reflection and self-assessment after leading each assignment.

**Conducting the Leadership Assignment While Supervising the Team.** Cadets will observe and guide a team while the leadership assignment is taking place. Supervising others is one of the responsibilities of a leader. Cadets will ensure the leadership assignment is conducted in a safe manner and completed as instructed by the staff.

**Leading Team-Building Activities.** Cadets should direct team-building or creative games. This gives cadets chances to practice influencing and managing others. Again, cadets should practice reflection and self-assessment after leading team-building activities.

**Debriefing the Team.** Cadets should review and discuss with the team the completion and outcome of a leadership assignment or a team-building activity. Cadets should practice effective communication while speaking to the team.

**Presenting an After-Assignment Report to Their Leader.** Cadets should review and discuss with their leader/supervisor the completion and outcome of a leadership assignment or a team-building activity. Cadets should practice effective communication while speaking to their leader/supervisor.

---

### CONFIRMATION OF TEACHING POINT 7

---

#### QUESTIONS

- Q1. What is applied leadership?
- Q2. What are the six components of applied leadership?
- Q3. Why is setting an example for others to follow important?

#### ANTICIPATED ANSWERS

- A1. Applied leadership is how cadets practice influencing and managing others.
- A2. The six components of applied leadership are:
- setting an example for others to follow;
  - participating in leadership assignments;
  - conducting the leadership assignment while supervising the team;
  - leading team-building activities;
  - debriefing the team; and
  - presenting an after-assignment report to their leader.
- A3. Setting an example for others to follow is important because if cadets establish themselves as a model, others will want to imitate them.

---

#### Teaching Point 8

#### Explain the Components of Mentorship

Time: 5 min

Method: Interactive Lecture

---

#### COMPONENTS OF MENTORSHIP

Mentorship is how cadets participate in a professional association between two people that focuses on self-development. There are two parts to mentorship:

**The Role of a Cadet Being Mentored.** Cadets will assume the role of a cadet being mentored. This is the trainee in the relationship. Cadets being mentored should enhance their knowledge and skills of leadership. Learning from the mentor's example will be an important element of the mentoring relationship.

**The Role of a Mentor.** Cadets will assume the role of a mentor. This is the advisor/guide in the relationship. Cadets mentoring should enhance their leadership abilities, coaching skills and communication skills. As a mentor, cadets may see things from a different perspective than the cadet being mentored.

### CONFIRMATION OF TEACHING POINT 8

#### QUESTIONS

- Q1. What is mentorship?
- Q2. What are the two components of mentorship?
- Q3. Who is the trainee in the mentoring relationship?

#### ANTICIPATED ANSWERS

- A1. Mentorship is how cadets participate in a professional association between two people that focuses on self-development.
- A2. The two components of mentorship are:
- the role of a cadet being mentored; and
  - the role of a mentor.
- A3. The trainee in the mentoring relationship is the cadet being mentored.

#### Teaching Point 9

#### Identify the Silver Star Team Leader Opportunities

Time: 5 min

Method: Interactive Lecture

#### SILVER STAR TEAM LEADER OPPORTUNITIES

In year three, cadets will have team leader opportunities. These include:

**Performing the Role of a Mentor.** Performing the role of a mentor may be as simple as partnering up with a year one cadet. This buddy system may help the year one cadet gain skills and knowledge about the corps and should assist the year three cadet in their leadership and communication skills.

**Completing a Leadership Assignment.** Each year three cadet will be given occasions in which they will complete a leadership assignment. These assignments may include classroom set ups, ensuring building clean up, or assisting with an expedition day. Some of the leadership assignments will be evaluated by the staff.

### CONFIRMATION OF TEACHING POINT 9

#### QUESTIONS

- Q1. What are the Silver Star training opportunities?
- Q2. What is one simple way to perform the role of a mentor?
- Q3. What are some examples of leadership assignments?

### **ANTICIPATED ANSWERS**

A1. The Silver Star training opportunities include:

- performing the role of a mentor; and
- completing a leadership assignment.

A2. One simple way to perform the role of a mentor is to use the buddy system.

A3. Some examples of leadership assignments include classroom set up, ensuring building clean up, or assisting with an expedition day.

---

### **END OF LESSON CONFIRMATION**

---

### **QUESTIONS**

Q1. What position does a Silver Star cadet hold in the leadership team model?

Q2. List the six core leadership competencies.

Q3. What are the Silver Star training opportunities?

### **ANTICIPATED ANSWERS**

A1. The Silver Star cadet holds the position of team leader.

A2. The six core leadership competencies are:

- intrapersonal management,
- interpersonal management,
- teamwork,
- effective communication,
- applied leadership, and
- mentorship.

A3. The Silver Star training opportunities include:

- performing the role of a mentor; and
- completing a leadership assignment.

---

### **CONCLUSION**

---

### **HOMEWORK/READING/PRACTICE**

N/A.

### **METHOD OF EVALUATION**

N/A.



**CLOSING STATEMENT**

Cadets should know and understand their role within the leadership team at the corps. When cadets know what is expected of them it is much easier for them to set and reach their goals. Higher expectations lead to greater results. Being aware of the core leadership competencies and the components for each may assist the cadets' developing leadership abilities while adapting to their developing role as a leader in their corps.

**INSTRUCTOR NOTES/REMARKS**

N/A.

---

**REFERENCES**

---

- C0-114 (ISBN 0-02-863656-2) Pell, A. R. (1999). *The Complete Idiot's Guide to Team Building*. Indianapolis, IN: Alpha Books.
- C0-115 (ISBN 0-7879-4059-3) van Linden, J. A., & Fertman, C. I. (1998). *Youth Leadership*. San Francisco, CA: Jossey-Bass Inc., Publishers.
- C0-240 (ISBN 0-934387-05-2) Collard, M. (2005). *No Props: Great Games With No Equipment*. Beverly, MA: Project Adventure, Inc.
- C0-245 (ISBN 1-58062-513-4) Adams, B. (2001). *The Everything Leadership Book*. Avon, MA: Adams Media.
- C0-256 (ISBN 0-7894-4863-7) Heller, R. (1999). *Achieving Excellence*. New York, NY: DK Publishing, Inc.
- C0-258 (ISBN 978-1-59869-450-5) Nigro, N. (2008). *The Everything Coaching and Mentoring Book*. (2<sup>nd</sup> ed.). Avon, MA: F+W Publications Company.
- C0-268 (ISBN 978-1-57542-265-7) MacGregor, M. S. (2008). *Teambuilding With Teens: Activities for Leadership, Decision Making and Group Success*. Minneapolis, MN: Free Spirit Publishing.
- C0-270 Maslow, A. H. (1943). A theory of human motivation. *Psychological Review*, Vol. 50, No. 4, pp. 370–396.
- C0-271 Farthing, D. (2001). *Peacebuilders 1: Conflict Resolution Youth Reference Guide*. Ottawa, ON: YouCAN.

THIS PAGE INTENTIONALLY LEFT BLANK



**COMMON TRAINING**  
**SILVER STAR**  
**INSTRUCTIONAL GUIDE**



**SECTION 2**

**EO M303.02 – PARTICIPATE IN A MENTORING RELATIONSHIP**

Total Time:

30 min

**PREPARATION**

**PRE-LESSON INSTRUCTIONS**

Resources needed for the delivery of this lesson are listed in the lesson specification located in A-CR-CCP-703/PG-001, Chapter 4. Specific uses for said resources are identified throughout the instructional guide within the TP for which they are required.

Review the lesson content and become familiar with the material prior to delivering the lesson.

Prepare questions for the group discussion.

**PRE-LESSON ASSIGNMENT**

N/A.

**APPROACH**

An interactive lecture was chosen for TP 1 to orient the cadets to the mentoring relationship, to generate interest and present basic material.

A group discussion was chosen for TP 2 as it allows the cadets to interact with their peers and share their knowledge, experiences, opinions and feelings about the mentoring relationship.

**INTRODUCTION**

**REVIEW**

N/A.

**OBJECTIVES**

By the end of this lesson the cadet shall be expected to participate in a mentoring relationship.

**IMPORTANCE**

It is important for cadets to participate in a mentoring relationship to assist in the development of their leadership abilities. The mentoring relationship expands leadership knowledge and skills of participants, enhances communication skills, resolves conflict and promotes constructive feedback, and should aid in the leadership development of all cadets.

**Teaching Point 1****Explain the Mentoring Relationship**

Time: 15 min

Method: Interactive Lecture



Begin the lesson by asking the cadets if they know what the word mentoring means. Do the cadets have any examples of mentoring?

**THE MENTORING RELATIONSHIP**

A mentoring relationship is a professional association between two people that focuses on self-development. One is the mentor; the other is the cadet being mentored. The mentor is the experienced and trusted advisor or guide; however, both individuals are expected to learn from the relationship.



The mentoring relationship for a year three cadet may be as simple as partnering up with a year one cadet. This buddy system may help the year one cadet gain skills and knowledge about the corps and should assist the year three cadet in their leadership and communication skills. A year three cadet may also be mentored by a year five cadet.

**Recognizing the Purpose of a Mentoring Relationship**

The purpose of the mentoring relationship is to share experiences between the mentor and the cadet being mentored, so the cadet being mentored is better prepared to move forward through the program with knowledge and confidence.

**Identifying the Benefits of Participating in a Mentoring Relationship**

The benefits of participating in a mentoring relationship are numerous. The basic benefit for a cadet being mentored is to show growth in skills and become a more independent and effective cadet. The most significant benefit for the mentor is the realization that they have inspired the cadet to perform at higher levels than the cadet would have without a mentor.

**Contributing to a Mentoring Match**

Contributing to a mentoring match means that both the mentor and the one being mentored will have some say with whom they are matched. The mentoring relationship is based on trust; ensure a long-term and valuable connection can be made with the person you choose.

**Being Open to New Things**

For a mentoring relationship to be successful, both individuals must be willing to try new things. Expanding your horizons and increasing your knowledge are foundations of the mentoring relationship. Being receptive to new ideas and experiences takes courage.

**Being Responsive to Suggestions and Constructive Criticism**

The cadet being mentored should be responsive to suggestions made by the mentor. The mentor should use constructive criticism and will attempt to provide feedback that will assist the cadet being mentored. This may include feedback that is positive in nature or feedback that assists in finding solutions for poor performance. The task of the cadet being mentored is to be receptive to recommendations being made.

### Providing Feedback to the Mentor

Mentoring is a two-way relationship, so it is important that the cadet being mentored provides feedback to the mentor. This feedback should be based on feelings, both positive and negative, and observations. If the cadet being mentored does not express their feelings to their mentor about the relationship, then progress may be hindered.

### Learning From the Mentor's Example

It is up to the mentor to set an example that the cadet being mentored would want to emulate. This example should be in all facets of the program (eg, drill, dress, deportment, leadership, academics, etc). The cadet being mentored should learn not only from the mentor's successes but from the mentor's failures.



It is important to remember that failure is not necessarily a negative thing. As long as cadets fail forward (learn from their mistakes) there is an advantage to any failure because a learning opportunity has been created.

### Participating in Mentoring Activities

To get the most benefit from a mentoring relationship, the cadet being mentored must be prepared to participate in some mentoring activities. These activities may include reflection, self-assessment, and discussions about successes, problems and failures. The mentor must also be prepared for each mentoring session. They need to have an agenda of what will be discussed and ensure that the discussions stay on track.

### Appreciating the Mentoring Relationship

An effective mentoring relationship must be respected by both people involved. Each person should have a high regard for the other in the relationship. Appreciating the other person for their effort, time and accomplishments will ensure a long-lasting and mutually beneficial partnership.

---

## CONFIRMATION OF TEACHING POINT 1

---

### QUESTIONS

- Q1. What is the basic benefit of a mentoring relationship for the cadet being mentored?
- Q2. Why should the mentor and the cadet being mentored be open to new things?
- Q3. What are some examples of mentoring activities?

### ANTICIPATED ANSWERS

- A1. The basic benefit is that the cadet being mentored will grow in their skills and become a more independent and more effective cadet.
- A2. The mentor and the cadet being mentored should be open to new things because each should wish to expand their horizons and increase their knowledge of the mentoring relationship. Being receptive to new ideas and experiences takes courage.
- A3. Mentoring activities may include reflection, self-assessment and discussions about successes, problems and failures.

**Teaching Point 2****Conduct a Group Discussion About Mentoring**

Time: 10 min

Method: Group Discussion

**BACKGROUND KNOWLEDGE**

The point of the group discussion is to draw information about the mentoring relationship from the group using the tips for answering/facilitating discussion and the suggested questions provided.



This group discussion focuses on self-reflection, self-assessment, recording in a journal, and mentoring sessions.

**GROUP DISCUSSION****TIPS FOR ANSWERING/FACILITATING DISCUSSION**

- Establish ground rules for discussion, eg, everyone should listen respectfully; don't interrupt; only one person speaks at a time; no one's ideas should be made fun of; you can disagree with ideas but not with the person; try to understand others as much as you hope they understand you; etc.
- Sit the group in a circle, making sure all cadets can be seen by everyone else.
- Ask questions that will provoke thought; in other words avoid questions with yes or no answers.
- Manage time by ensuring the cadets stay on topic.
- Listen and respond in a way that indicates you have heard and understood the cadet. This can be done by paraphrasing their ideas.
- Give the cadets time to respond to your questions.
- Ensure every cadet has an opportunity to participate. One option is to go around the group and have each cadet answer the question with a short answer. Cadets must also have the option to pass if they wish.
- Additional questions should be prepared ahead of time.

**SUGGESTED QUESTIONS**

Q1. What is self-reflection?

Q2. Why do you think self-reflection is useful when participating in a mentoring relationship? Give some examples when self-reflection may be used by the cadet being mentored. Give some examples when self-reflection may be used by the mentor.

Q3. What is self-assessment?

- Q4. Is there a difference between self-assessment and self-reflection?
- Q5. Why do you think self-assessment is useful when participating in a mentoring relationship? Give some examples when self-assessment may be used by the cadet being mentored. Give some examples when self-assessment may be used by the mentor.
- Q6. Why record in a journal?
- Q7. Is there a difference between recording in a journal, self-assessment and self-reflection?
- Q8. Why do you think recording in a journal is useful when participating in a mentoring relationship? Give some examples when recording in a journal may be used by the cadet being mentored. Give some examples when recording in a journal may be used by the mentor
- Q9. When a mentoring session takes place, what do you think it looks like?
- Q10. What does it sound like?
- Q11. What do you think a mentoring session feels like?



Other questions and answers will develop throughout the group discussion. The group discussion should not be limited to only those suggested.



Reinforce those answers given and comments made during the group discussion, ensuring the teaching point has been covered.

---

### CONFIRMATION OF TEACHING POINT 2

---

The cadets' participation in the group discussion will serve as confirmation of this TP.

---

### END OF LESSON CONFIRMATION

---

The cadets' participation in the group discussion will serve as confirmation of this lesson.

---

### CONCLUSION

---

#### HOMework/READING/PRACTICE

N/A.

#### METHOD OF EVALUATION

N/A.

#### CLOSING STATEMENT

Being mentored and mentoring others is one way to enhance skills and knowledge of leadership. The mentoring relationship develops trust and trust is the foundation of leadership. Using self-reflection, self-assessment, and recording in a journal are excellent methods to track advancement through the Cadet Program.

### **INSTRUCTOR NOTES/REMARKS**

After this lesson each year three cadet will choose at least one year one cadet to mentor. Each year three cadet will also be asked which year five cadet they would like to mentor them.

---

### **REFERENCES**

---

- C0-258 (ISBN 978-1-59869-450-5) Nigro, N. (2008). *The Everything Coaching and Mentoring Book*. (2<sup>nd</sup> ed.). Avon, MA: F+W Publications Company.
- C2-109 (ISBN 0-7872-6561-6) Sugarman, D., Doherty, K., Garvey, D., & Gass, M. (2000). *Reflective Learning: Theory and Practice*. Dubuque, IO: Kendall/Hunt Publishing Company.





**COMMON TRAINING**  
**SILVER STAR**  
**INSTRUCTIONAL GUIDE**



**SECTION 3**  
**EO M303.03 – PRACTICE SELF-ASSESSMENT**

---

Total Time:

30 min

---



---

**PREPARATION**

---

**PRE-LESSON INSTRUCTIONS**

Resources needed for the delivery of this lesson are listed in the lesson specification located in A-CR-CCP-703/PG-001, Chapter 4. Specific uses for said resources are identified throughout the instructional guide within the TP for which they are required.

Review the lesson content and become familiar with the material prior to delivering the lesson.

Photocopy handout located at Annex C for each cadet.

**PRE-LESSON ASSIGNMENT**

N/A.

**APPROACH**

An interactive lecture was chosen for TP 1 to define reflection and self-assessment.

An in-class activity was chosen for TP 2 as an interactive way to provoke thought, to stimulate an interest among cadets and to conduct self-assessments.

A group discussion was chosen for TP 3 as it allows the cadets to interact with their peers and share their knowledge, experiences, opinions and feelings about the benefits of seeking feedback and assistance.

---

**INTRODUCTION**

---

**REVIEW**

N/A.

**OBJECTIVES**

By the end of this lesson the cadet shall be expected to practice self-assessment.

**IMPORTANCE**

It is important for cadets to practice self-assessment as it is an excellent method to identify areas for self-improvement and assessment for learning. Self-assessment is a cornerstone of assessment for learning. It enables cadets and staff to ensure individual and program/organizational goals are being met.

**Teaching Point 1****Define Reflection and Self-Assessment**

Time: 5 min

Method: Interactive Lecture



Reflection and self-assessment will be used in many performance objectives of the Cadet Program to enable the cadet and their staff to track their development and progress of different skills and knowledge.

**Reflection.** Long and careful consideration. Reflection can take place at any time and does not necessarily have to be about oneself. Usually reflection takes place directly after an action is taken.

**Self-Assessment.** Assessment or evaluation of oneself, or one's actions, attitudes or performance. In order to perform self-assessment correctly, reflection about oneself must take place before the self-assessment.

**CONFIRMATION OF TEACHING POINT 1****QUESTIONS**

- Q1. Define reflection.
- Q2. Define self-assessment.
- Q3. In order to perform self-assessment correctly, when must reflection take place?

**ANTICIPATED ANSWERS**

- A1. Long and careful consideration.
- A2. Assessment or evaluation of oneself, or one's actions, attitudes or performance.
- A3. Reflection about oneself must take place before the self-assessment.

**Teaching Point 2****Have the Cadet Conduct Self-Assessment Activities**

Time: 10 min

Method: In-Class Activity



Reflection and self-assessment, in all their forms, are enhanced by providing context for each activity. The objective of this particular reflection and self-assessment is to have cadets find a baseline level of their core leadership qualities and their positive team dynamics.

Providing the time, environment and opportunity for reflection and self-assessment, allows the cadet to complete an assessment for learning and should be the spark that lights the fire of learning.

Ask cadets to reflect on their last three years in the program before completing the rubrics.

**ACTIVITY****OBJECTIVE**

The objective of this activity is to have cadets conduct self-assessment activities.

**RESOURCES**

- Self-assessment rubric for core leadership qualities, and
- Self-assessment rubric for positive team dynamics.

**ACTIVITY LAYOUT**

N/A.

**ACTIVITY INSTRUCTIONS**

1. Distribute the self-assessment rubrics located at Annex C to each cadet.
2. Explain that each cadet should reflect on each category on the rubric before completing it.
3. Give cadets eight minutes to complete the two rubrics.

**SAFETY**

N/A.

---

**CONFIRMATION OF TEACHING POINT 2**

---

The cadets' participation in the in-class activity will serve as the confirmation of this TP.

---

**Teaching Point 3****Conduct a Group Discussion on How and When to Seek Feedback and Assistance**

Time: 10 min

Method: Group Discussion

---

**BACKGROUND KNOWLEDGE**

---



The point of the group discussion is to draw the following information from the group using the tips for answering/facilitating discussion and the suggested questions provided.

Seeking feedback after self-assessment may be necessary. Feedback from others, in the form of advice, should give the cadet ideas to help improve performance.

Assistance after self-assessment may be necessary. Assistance from others, in the form of collaboration, should help the cadet improve performance.

Feedback and assistance should guide the cadet to ensure all goals, both personal (eg, improving PACER time) and professional (eg, becoming a better instructor), are being met.

---

## GROUP DISCUSSION

---



### TIPS FOR ANSWERING/FACILITATING DISCUSSION

- Establish ground rules for discussion, eg, everyone should listen respectfully; don't interrupt; only one person speaks at a time; no one's ideas should be made fun of; you can disagree with ideas but not with the person; try to understand others as much as you hope they understand you; etc.
- Sit the group in a circle, making sure all cadets can be seen by everyone else.
- Ask questions that will provoke thought; in other words avoid questions with yes or no answers.
- Manage time by ensuring the cadets stay on topic.
- Listen and respond in a way that indicates you have heard and understood the cadet. This can be done by paraphrasing their ideas.
- Give the cadets time to respond to your questions.
- Ensure every cadet has an opportunity to participate. One option is to go around the group and have each cadet answer the question with a short answer. Cadets must also have the option to pass if they wish.
- Additional questions should be prepared ahead of time.

### SUGGESTED QUESTIONS

- Q1. Should you seek feedback after completing self-assessment? Why or why not?
- Q2. When is a good time to seek feedback? Why?
- Q3. Should you seek assistance after completing self-assessment? Why or why not?
- Q4. When is a good time to seek assistance? What may seeking assistance look like?
- Q5. Is seeking assistance different than seeking feedback? If it is different, how is it different?



Other questions and answers will develop throughout the group discussion. The group discussion should not be limited to only those suggested.



Reinforce the answers given and comments made during the group discussion, ensuring the teaching point has been covered.

---

### CONFIRMATION OF TEACHING POINT 3

---

The cadets' participation in the group discussion will serve as the confirmation of this TP.

---

## END OF LESSON CONFIRMATION

---

The cadets' participation in the group discussion will serve as the confirmation of this lesson.



Advise cadets to take their self-assessment rubrics home and place them somewhere safe because they will need to look at these rubrics again to track their progress.

---

## CONCLUSION

---

### HOMEWORK/READING/PRACTICE

N/A.

### METHOD OF EVALUATION

N/A.

### CLOSING STATEMENT

Self-assessment is one method to help improve leadership skills. Regular practice of reflection and self-assessment will assist the cadet in measuring and tracking improvement of skills and knowledge. Self-assessment also helps cadets set, strive for and maintain goals.

### INSTRUCTOR NOTES/REMARKS

N/A.

---

## REFERENCES

---

- C0-237 (ISBN 0-19-541816-6) Barber, K. (Ed.). (2004). *Canadian Oxford Dictionary* (2<sup>nd</sup> ed.). Don Mills, ON: Oxford University Press Canada.
- C0-242 (ISBN 978-0-9682160-2-1) Gregory, K., Cameron, C., & Davies, A. (2000). *Knowing What Counts: Self-Assessment and Goal Setting*. Courtenay, BC: Building Connections Publishing Inc.
- C0-258 (ISBN 978-1-59869-450-5) Nigro, N. (2008). *The Everything Coaching and Mentoring Book*. (2<sup>nd</sup> ed.). Avon, MA: F+W Publications Company.

THIS PAGE INTENTIONALLY LEFT BLANK



**COMMON TRAINING**  
**SILVER STAR**  
**INSTRUCTIONAL GUIDE**



**SECTION 4**

**EO M303.04 – COMMUNICATE AS A TEAM LEADER**

---

Total Time:

60 min

---

**PREPARATION**

---

**PRE-LESSON INSTRUCTIONS**

Resources needed for the delivery of this lesson are listed in the lesson specification located in A-CR-CCP-703/PG-001, Chapter 4. Specific uses for said resources are identified throughout the instructional guide within the TP for which they are required.

Review the lesson content and become familiar with the material prior to delivering the lesson.

Photocopy a Communication Puzzle located at Annex D for each cadet. Using half of the copies, cut out the puzzle pieces and place each set of pieces in a re-sealable plastic bag. With the other half, place each full puzzle in an envelope.

**PRE-LESSON ASSIGNMENT**

N/A.

**APPROACH**

An interactive lecture was chosen for TPs 1–4 to orient the cadets to communicating as a team leader.

An in-class activity was chosen for TP 5 as an interactive way to provoke thought and stimulate interest among cadets about the process of communication and the barriers to communication.

---

**INTRODUCTION**

---

**REVIEW**

N/A.

**OBJECTIVES**

By the end of this lesson the cadet shall have communicated as a team leader.

**IMPORTANCE**

It is important for cadets to understand the process of communication. People communicate everyday as a way to share knowledge, interests, attitudes, opinions, feelings and ideas with others. After understanding ways to communicate, cadets must become familiar with the process of communication and when and how to use

it. Communication skills are a fundamental part of leadership because they permit the flow of ideas from one individual to another or to a group, and vice versa. Effective communication helps people break down barriers between themselves and others.

---

**Teaching Point 1****Explain Verbal and Non-Verbal Communication**

Time: 5 min

Method: Interactive Lecture

---

Every form of communication must have a sender and a receiver.

**VERBAL COMMUNICATION**

When individuals speak to each other, verbal communication is being used. Much of what a person receives from a conversation is picked up through words. Verbal communications are used during conversations, meetings, interviews, speeches and more.

**NON-VERBAL COMMUNICATION**

When individuals communicate, body language and gestures are very useful. Body language and gestures act as communication shortcuts that convey messages previously learned by both the sender and the receiver.



Have the cadets give examples of body language and gestures. Ensure the examples are non-controversial.

Written communications such as memos and e-mail are considered non-verbal communications. Written communications are used in the cadet organization because they are accessible and usually permanent.

---

**CONFIRMATION OF TEACHING POINT 1**

---

**QUESTIONS**

- Q1. Every form of communication must have what?
- Q2. When is verbal communication used?
- Q3. List three types of non-verbal communications?

**ANTICIPATED ANSWERS**

- A1. A sender and a receiver.
- A2. Verbal communications are used during conversations, meetings, interviews, speeches and more.
- A3. Body language, gestures, and written communications.



**Teaching Point 2****Explain Hearing and Listening and Their Impact on Communication**

Time: 15 min

Method: Interactive Lecture



Before beginning this TP, ask the cadets if they think there is a difference between hearing and listening.

Do not spend a lot of time on the question since it will be elaborated throughout this TP.

**THE DEFINITION OF HEARING**

Oxford dictionary defines “hear” as:

- perceive (sound, etc) with the ear;
- listen to as a member of an audience; and
- be told or informed.

Hearing occurs naturally everyday, whether a person wishes to hear or not.

**THE DEFINITION OF LISTENING**

Oxford dictionary defines “listen” as:

- to make an effort to hear something;
- pay attention to; and
- give attention with the ear.

When a person listens, they are making an effort to hear something. In order to listen effectively, the listener must pay attention to the person who is speaking.

**ACTIVE LISTENING**

Active listening is difficult because it demands that the listener put aside any internal reactions and turn their attention to the speaker without judging what is being said.

By withholding judgment, a person communicates respect by acknowledging that the other person is important and deserves to be heard and understood. Active listening encourages people to talk about facts and feelings without a risk of being put down. The goal of active listening is not only to hear what the speaker is saying but also to allow them to focus on themselves so that they can accurately communicate how they feel. There are many situations in which active listening can be used and practiced. Some of these situations are explained in Figure 3-4-1.



Ask the cadets to think about some real-life examples of times when they have tried to be good listeners while sharing some of the comparisons below.

Active Non-Listening	Active Listening
Give the other person your version.	Repeat conversationally back to them, in your own words, your understanding of the meaning.
Give your own opinions and advice. Talk about yourself at every point.	Do not talk about yourself.
Introduce new topics to get off the subject if it is uncomfortable.	Let the speaker take the lead. Encourage them back to the issue when they digress. Do not allow the person to drift to a less significant topic because they feel that you do not understand.
Think of what you are going to say next while the speaker is talking.	Concentrate fully on what the person is saying.
Do not let the speaker know if you do not know what they are talking about.	Ask for clarification when you do not understand.
Reassure by saying "It's not that bad" or talk them out of it.	Let them come to their own answer since your answer may not be theirs. Do not offer advice.
Agree with generalizations such as "Yes, it's hopeless" or "There's nothing you can do."	Let them find their answer. Reflect back to them so that they know you understand but also so they can hear and understand themselves.
Dismiss their feelings by saying things such as "You'll feel better tomorrow" or "It's not the end of the world."	Support their feelings by saying things such as "You feel hopeless about it right now" or "You can't find anything that will fix it yet."
Fill silences.	Allow silences.

*E. Colver & M. Reid, Peacebuilders 2: Peer Helping, YouCAN (p. 13)*

Figure 3-4-1 Active Listening Examples

## POOR LISTENING HABITS

People often need to feel heard before they can hear. When listening, focus on the speaker. Affirmative listening (nodding and giving quick answers) shows the speaker that the listener is paying attention, consequently encouraging them to continue communicating.

Care should be taken to maintain focus and concentration when having a conversation. The following are some examples of poor listening habits:

- formulating replies while the other person is speaking;
- letting the mind wander;
- tuning out a point of view that differs from the listener's preconceived ideas;
- interrupting speakers;
- finishing a speaker's sentence for them;
- talking while other people are speaking;
- jumping to conclusions; and
- hearing only what the listener wants to hear or expects to hear or assuming what will be said.

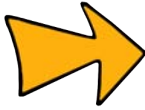

The Chinese character for listen, pronounced *ting*, is made up of four characters: the heart, the mind, the ears and the eyes.



*K. Cole, The Complete Idiot's Guide to Clear Communication, Alpha Books (p. 130)*

Figure 3-4-2 Chinese Listen Character

### THE IMPACT THAT LISTENING AND HEARING HAVE ON COMMUNICATION

Noises are easy to hear but because a person can hear what is happening, does it mean that they are listening? Sometimes the listener must stop the person who is talking and ask them to start over. It is possible to hear a person speak but have no idea what they are saying.



Ask the cadets to think about some lessons or conversations that occurred recently in which they could hear what was happening but were not listening.

In order to communicate effectively, it is vital that those who are receiving the information are listening; a speaker must have the attention and focus of the listeners.

Listeners should involve themselves in communication physically, mentally and verbally. Using body language will help keep the attention of listeners. Those listening should focus their attention solely on the speaker. If the topic is important, a good way to stay focused is to take notes. When the speaker is finished, ask questions to make sure the message you received is right.

---

### CONFIRMATION OF TEACHING POINT 2

---

#### QUESTIONS

- Q1. What is the definition of "listen"?
- Q2. List some examples of poor listening habits.
- Q3. In what ways should listeners involve themselves in communication?

## ANTICIPATED ANSWERS

A1. Oxford dictionary defines “listen” as:

- to make an effort to hear something;
- pay attention to; and
- give attention with the ear.

A2. The following are examples of poor listening habits:

- formulating replies while the other person is speaking;
- letting the mind wander;
- tuning out a point of view that differs from the listener’s preconceived ideas;
- interrupting speakers;
- finishing a speaker’s sentence for them;
- talking while other people are speaking;
- jumping to conclusions; and
- hearing only what the listener wants to hear or expects to hear or assuming what will be said.

A3. Listeners should involve themselves in communication physically, mentally and verbally.

---

### Teaching Point 3

### Describe the Process of Communication

Time: 5 min

Method: Interactive Lecture

---

## PROCESS OF COMMUNICATION

Communication skills are a fundamental part of leadership because they permit the flow of ideas from one individual to another or to a group, and vice versa. Effective communication helps people break down barriers between themselves and others. Giving careful thought, not only to what people want to express but also to how they want to express it, is an important part of communication. Communication involves a complex interaction of habits, attitudes, knowledge, information and bias.

The process of communication consists of three steps:

1. receiving;
2. interpreting; and
3. responding.

### Receiving Information

Receiving a message will depend directly on what information was sent by the sender and how it was sent. When receiving, listening is of the utmost importance.

Messages may be simple or complex. When receiving a complex message, the receiver must be prepared to write down important information. If there is a lack of understanding or any confusion, the receiver should ask questions.

### **Interpreting Information**

After a message has been received, it must be reflected on and interpreted. Simple messages may not require much interpretation.

Receivers of a message will translate what they heard based on their own set of definitions, which may differ greatly from those of the sender.

### **Responding To Information**

A response will let the sender know that the message has been received and interpreted and is now being acted on. The response may be to the sender or it may be to another person or a group to act on the message. When responding, being able to communicate what was interpreted from the message is important.

## **CONFIRMATION OF TEACHING POINT 3**

### **QUESTIONS**

- Q1. What step of communication occurs after the message has been received?
- Q2. What should be done if there is a lack of understanding or any confusion?
- Q3. Who may receive a response in the communication process?

### **ANTICIPATED ANSWERS**

- A1. Interpreting is the next step.
- A2. Questions should be asked.
- A3. The response may be to the sender or it may be to another person or a group in order to act on the message.

### **Teaching Point 4**

### **Identify the Barriers to Effective Communication**

Time: 10 min

Method: Interactive Lecture

### **BARRIERS TO COMMUNICATION**

When sending a message, the sender must understand that there are barriers to communication – ways in which communicating can lead to misinterpretation. In order to communicate effectively, these barriers must be overcome or managed. Keep in mind that the real communication is the message others receive, not the message intended.

When the receiver has to overcome barriers to communication, there may be effects such as:

- defensiveness, confusion, resistance and resentment;
- dependency on others to explain and inform;
- withdrawal from conversations;
- feelings of defeat or inadequacy; or
- decreased likelihood of problem solving.

Barriers to communication can be divided into three categories: intrapersonal factors, distraction factors and delivery factors.

## Intrapersonal Factors

The following barriers to communication are intrapersonal factors:

- **Stress.** When feeling the effects of stress, both the sender and the receiver may easily lose focus of the goal of the message. When experiencing stress, it may be difficult for a person to concentrate on messages.
- **Emotion.** When the sender of a message has high emotion, such as worry, fear or even excitement, the intent of the message may be lost. When the receiver has strong, negative emotions about the sender or disagrees with the message, interpreting may be difficult.
- **Misinterpretation.** The meaning of the message may be misinterpreted by the receiver. Sometimes a word can mean two different things and different words have different meanings for different people. When the sender uses complex words, they must ensure that the receiver is capable of understanding them. Be aware that a person may use a particular word in a different way than others understand it.
- **Poor Listening Habits.** When the receiver has poor listening habits, the meaning and intent of the message may be lost. It is important for the sender to look for cues to make sure that receivers are listening and paying attention.
- **Closed-Mindedness.** People sometimes only hear what they want to hear. When new ideas or change are brought to a situation, some people may have a difficult time accepting the message.
- **Prejudice.** Prejudice can occur between the sender and receiver. When the ability to understand is questioned or the intent is misjudged due to preconceived opinions, the effectiveness of the message may be weakened.

## Distraction Factors

The following barriers to communication are distraction factors:

- **Visual.** When sending or receiving a message, it is easy to become distracted by sights in the area. Even when the participants seem extremely focused, seeing something out of the corner of the eye can distract and confuse them.
- **Auditory.** Noise is also a distraction when sending or receiving a message. When noise occurs, participants can become distracted and confused. The sender may have to stop sending the message, wait for the noise to stop and then begin to send again. It is important that the receivers have an environment free of distractions.

## Delivery

The following barriers to communication are delivery factors:

- **Language.** The language a person speaks may have a significant affect on the effectiveness of a message. Trying to understand a message that is being sent in another language is extremely difficult. Also, when a person uses complex wording to explain a concept, meaning can be lost. Using simple language to explain concepts will ensure that everyone understands the message and will avoid possible confusion.
- **Mixed Messages.** Mixed messages occur when the sender sends a variety of messages, all indicating different ideas or meanings. Mixed messages may be interpreted through body language and tone of voice used by the sender. If the receiver interprets mixed messages, the intent of the message may become lost.
- **Overload.** When bombarded with information, understanding a message is difficult. When given extra information, the receiver has to sort through and pick out the key pieces. Being overloaded may cause a person to hear only part of a message or distort a message. As a sender, only send the information that the receiver needs to know.

**Teaching Point 5****Conduct an Activity That Demonstrates the Barriers to Effective Communication**

Time: 15 min

Method: In-Class Activity

**ACTIVITY****OBJECTIVE**

The objective of this activity is to have the cadets experience barriers to communication.

**RESOURCES**

- Stopwatch,
- Paper,
- Scissors,
- Resealable plastic bags (one per two cadets),
- Envelopes (one per two cadets), and
- Communication puzzle located at Annex D (one per cadet).

**ACTIVITY LAYOUT**

Set up an area in which the cadets can sit back to back.

**ACTIVITY INSTRUCTIONS**

1. Divide the cadets into pairs. Within each pair, have the cadets decide who will be "A" and who will be "B".
2. Explain to the cadets that they will have to sit back to back. Cadet "A" will have to try to get cadet "B" to use cut-out shapes to replicate the given design. There will be three rounds consisting of:
  - (a) During the first round, only Cadet "A" can speak.
  - (b) During the second round, Cadet "B" may ask questions but Cadet "A" can only answer with yes or no.
  - (c) In the third round, both cadets may speak freely.



If at any time the cadets think that the puzzle has been solved, Cadet "A" may look at their partner's puzzle. If correct, Cadet "A" should rotate (turn) the puzzle so that it is different from previous tries and begin again until time has run out.

3. Distribute the puzzle in an envelope to each Cadet "A". Distribute the cut-out pieces in a resealable bag to each Cadet "B".
4. Have the cadets sit back to back and begin the first round. Start the stopwatch.



If there is enough room, have all of the "A" cadets face one direction and all of the "B" cadets face the opposite direction to ensure that none of the "B" cadets can see another cadet's puzzle.

5. After three minutes, stop the cadets. Have them begin the second round. Start the stopwatch.
6. After three minutes, stop the cadets. Have them begin the third round. Start the stopwatch.
7. After three minutes, have the cadets compare puzzles with other pairs.
8. Bring the cadets together for a debriefing. Ask questions such as:
  - (a) Why was it frustrating not being able to fully communicate throughout the activity?
  - (b) What communication did you have to try to overcome during the activity?
  - (c) Can you think of a real-life situation in which you were trying to solve a problem but did not have all of the “pieces” needed? What would have changed in that situation if you had received more information or if others had communicated more clearly?
  - (d) What happens when one team member has a specific goal in mind but cannot clearly communicate it to the team? How can the team improve the way information is communicated?

**SAFETY**

N/A.

---

**CONFIRMATION OF TEACHING POINT 5**

---

The cadets participation in the in-class activity will serve as the confirmation of this TP.

---

**END OF LESSON CONFIRMATION**

---

The cadets participation in the in-class activity will serve as the confirmation of this lesson.

---

**CONCLUSION**

---

**HOMEWORK/READING/PRACTICE**

N/A.

**METHOD OF EVALUATION**

N/A.

**CLOSING STATEMENT**

People communicate everyday as a way to share knowledge, interests, attitudes, opinions, feelings and ideas with others. Communication skills are a fundamental part of leadership because they permit the flow of ideas from you to another person or to a group, and vice versa. Communication skills will increase with experience which is why you should take every opportunity to communicate with others.

**INSTRUCTOR NOTES/REMARKS**

N/A.

---

**REFERENCES**

---

CO-022 (ISBN 0-02864-207-4) Cole, K. (2002). *The Complete Idiot's Guide to Clear Communication*. Indianapolis, IN: Alpha Books.



- C0-115 (ISBN 0-7879-4059-3) van Linden, J. A., & Fertman, C. I. (1998). *Youth Leadership*. San Francisco, CA: Jossey-Bass Inc., Publishers.
- C0-144 Colver, E., & Reid, M. (2001). *Peacebuilders 2: Peer Helping*. Ottawa, ON: YouCAN.
- C0-237 (ISBN 0-19-541816-6) Barber, K. (Ed.). (2004). *Canadian Oxford Dictionary* (2<sup>nd</sup> ed.). Don Mills, ON: Oxford University Press Canada.
- C0-262 MacDonald, K. (2002). *Interpersonal Conflict Resolution Skills for Youth. Module 1: Fundamentals of Conflict Resolution*. New Westminster, BC: Centre for Conflict Resolution.
- C0-268 (ISBN 1-57542-265-4) MacGregor, M. (2008). *Teambuilding With Teens: Activities for Leadership, Decision Making and Group Success*. Minneapolis, MN: Free Spirit Publishing, Inc.

THIS PAGE INTENTIONALLY LEFT BLANK



**COMMON TRAINING**  
**SILVER STAR**  
**INSTRUCTIONAL GUIDE**



**SECTION 5**  
**EO M303.05 – SUPERVISE CADETS**

---

Total Time:

60 min

---



---

**PREPARATION**

---

**PRE-LESSON INSTRUCTIONS**

Resources needed for the delivery of this lesson are listed in the lesson specification located in A-CR-CCP-703/PG-001, Chapter 4. Specific uses for said resources are identified throughout the instructional guide within the TP for which they are required.

Review the lesson content and become familiar with the material prior to delivering the lesson.

**PRE-LESSON ASSIGNMENT**

N/A.

**APPROACH**

An interactive lecture was chosen for TPs 1 and 2 to introduce the cadets to supervision.

A group discussion was chosen for TPs 3 and 4 as it allows the cadets to interact with their peers and share their knowledge, experiences, opinions and feelings about supervision.

---

**INTRODUCTION**

---

**REVIEW**

N/A.

**OBJECTIVES**

By the end of this lesson the cadet shall be expected to supervise cadets.

**IMPORTANCE**

It is important for cadets to understand the purpose of supervision and how to supervise because effective supervision is a fundamental element of becoming a leader. Silver Star cadets will be expected to supervise their teams while conducting leadership assignments.

---

**Teaching Point 1****Explain the Purposes of Supervision**

Time: 10 min

Method: Interactive Lecture

---

**THE PURPOSES OF SUPERVISION**

There are three main purposes of supervision.

**To Provide Protection.** Supervision ensures the safety and well-being of personnel.



Safety is the number one issue in every aspect of the Cadet Program. When situations are not safe, they are stopped immediately.



CATO 14-31, *Director Cadets and Junior Canadian Rangers General Safety Program*, outlines the requirements for a general safety program that must be incorporated in every aspect of cadet activities.

**To Provide Support.** Supervision ensures that all members of the team are assisted, provided for and encouraged during tasks. If cadets are not practicing intrapersonal management, interpersonal management, teamwork and effective communication, the supervisor must act on the situation.

**To Provide Quality Assurance.** Supervision ensures the outcomes of a task meet expectations for that task. If cadets are not meeting their responsibilities in completing the task, the supervisor must act on the situation.



No one likes to be over-supervised. It is important to not micromanage your team.

---

**CONFIRMATION OF TEACHING POINT 1**

---

**QUESTIONS**

- Q1. What are the purposes of supervision?
- Q2. How does supervision provide support?
- Q3. How does supervision provide quality assurance?

**ANTICIPATED ANSWERS**

- A1. The purposes of supervision are to provide protection, to provide support and to provide quality assurance.
- A2. Supervision ensures that all members of the team are assisted, provided for and encouraged during tasks.
- A3. Supervision ensures outcomes of a task meet expectations for that task.

---

**Teaching Point 2****Explain How to Supervise**

Time: 10 min

Method: Interactive Lecture

---

**HOW TO SUPERVISE**

As team leaders, cadets will be expected to supervise others. Supervision takes place during the entire task, not just at the beginning or end of the task. Although each situation where supervision takes place is unique, there are some basic responsibilities that must be fulfilled. Team leaders shall meet these responsibilities by:

**Ensuring Safety.** Ensuring that every situation in the Cadet Program is carried out in a safe manner is the primary concern of all members involved.

**Ensuring the Well-Being of Cadets.** The welfare of cadets within the Cadet Program is a primary concern in the execution of all training and administrative tasks.

**Encouraging Cadets.** Encourage cadets to produce satisfactory work because they want to. Inspiring results through praise creates a positive outcome.

**Adjusting Responsibilities as Required.** Being able to adjust a cadet's responsibilities during tasks is important. Cadets with experience may need less supervision and may be given extra responsibilities.

**Maintaining Control of Cadets.** Keep cadets on task while they are producing satisfactory work. An effective supervisor will be able to keep cadets focused.

**Correcting Errors as Required.** If mistakes are made, effective supervisors will communicate this. They will revise what and how it needs to be done and remedy errors.

**Reporting Misconduct as Required.** When cadets behave in a manner that is inconsistent with the core leadership qualities of a cadet, these behaviours should be reported up the chain of command.

**Ensuring Completion of Responsibilities Assigned to Cadets as Required.** When supervisors delegate or assign tasks to others, it is the supervisor's responsibility to ensure all delegated tasks are completed.



Successful supervisors are usually successful leaders.

---

**CONFIRMATION OF TEACHING POINT 2**

---

**QUESTIONS**

- Q1. When does supervision take place?
- Q2. List the supervision responsibilities that a team leader should meet.
- Q3. What is the primary concern of all members involved in the Cadet Program?

**ANTICIPATED ANSWERS**

- A1. Supervision takes place during the entire task, not just at the beginning or end of the task.
- A2. The supervision responsibilities that a team leader should meet are:
- ensuring safety;
  - ensuring the well-being of cadets;

- encouraging cadets;
- adjusting responsibilities as required;
- maintaining control of cadets;
- correcting errors as required;
- reporting misconduct as required; and
- ensuring completion of responsibilities assigned to cadets as required.

A3. Ensuring that every situation in the Cadet Program is carried out in a safe manner.

---

**Teaching Point 3****Conduct a Group Discussion on Supervision**

Time: 15 min

Method: Group Discussion

---

---

**GROUP DISCUSSION**

---

**TIPS FOR ANSWERING/FACILITATING DISCUSSION**

- Establish ground rules for discussion, eg, everyone should listen respectfully; don't interrupt; only one person speaks at a time; no one's ideas should be made fun of; you can disagree with ideas but not with the person; try to understand others as much as you hope they understand you; etc.
- Sit the group in a circle, making sure all cadets can be seen by everyone else.
- Ask questions that will provoke thought; in other words avoid questions with yes or no answers.
- Manage time by ensuring the cadets stay on topic.
- Listen and respond in a way that indicates you have heard and understood the cadet. This can be done by paraphrasing their ideas.
- Give the cadets time to respond to your questions.
- Ensure every cadet has an opportunity to participate. One option is to go around the group and have each cadet answer the question with a short answer. Cadets must also have the option to pass if they wish.
- Additional questions should be prepared ahead of time.

**SUGGESTED QUESTIONS**

- Q1. What do you think the responsibilities of an effective supervisor are? Are they different from the list in TP 2?
- Q2. Which responsibility is the most important? Why?
- Q3. Which responsibility is used the least? Why?
- Q4. List some examples where you have seen leaders use the various responsibilities.



Other questions and answers will develop throughout the group discussion. The group discussion should not be limited to only those suggested.



Reinforce those answers given and comments made during the group discussion, ensuring the teaching point has been covered.

---

### CONFIRMATION OF TEACHING POINT 3

---

The cadets' participation in the group discussion will serve as the confirmation of this TP.

#### Teaching Point 4

#### Discuss the Supervision Requirements at the Corps

Time: 15 min

Method: Group Discussion



The point of the group discussion is to draw information about supervision at the corps from the group using the tips for answering/facilitating discussion and the suggested questions provided.

Cadets are supervised in various locations at the corps. These locations may include stairways, doorways, hallways, parade square, classrooms, canteen, etc. They are supervised to provide protection and support for cadets and quality assurance during the task.

---

### GROUP DISCUSSION

---



#### TIPS FOR ANSWERING/FACILITATING DISCUSSION

- Establish ground rules for discussion, eg, everyone should listen respectfully; don't interrupt; only one person speaks at a time; no one's ideas should be made fun of; you can disagree with ideas but not with the person; try to understand others as much as you hope they understand you; etc.
- Sit the group in a circle, making sure all cadets can be seen by everyone else.
- Ask questions that will provoke thought; in other words avoid questions with yes or no answers.
- Manage time by ensuring the cadets stay on topic.
- Listen and respond in a way that indicates you have heard and understood the cadet. This can be done by paraphrasing their ideas.
- Give the cadets time to respond to your questions.
- Ensure every cadet has an opportunity to participate. One option is to go around the group and have each cadet answer the question with a short answer. Cadets must also have the option to pass if they wish.

- Additional questions should be prepared ahead of time.

### **SUGGESTED QUESTIONS**

- Q1. Name some locations around the corps where the cadets will need to be supervised for safety reasons.
- Q2. How will you supervise these areas?
- Q3. Is supervision of cadets different in these areas than in the rest of the building?
- Q4. How will you supervise the areas in the rest of the building?
- Q5. Is supervision of cadets different when they are not in the building?
- Q6. Give some examples of how to encourage cadets during supervision.
- Q7. Give some examples of misconduct that you would report up the chain of command.



Other questions and answers will develop throughout the group discussion. The group discussion should not be limited to only those suggested.



Reinforce those answers given and comments made during the group discussion, ensuring the teaching point has been covered.

---

### **CONFIRMATION OF TEACHING POINT 4**

---

The cadets' participation in the group discussion will serve as the confirmation of this TP.

---

### **END OF LESSON CONFIRMATION**

---

The cadets' participation in the group discussions will serve as the confirmation of this lesson.

---

### **CONCLUSION**

---

### **HOMEWORK/READING/PRACTICE**

N/A.

### **METHOD OF EVALUATION**

This EO is assessed IAW A-CR-CCP-703/PG-001, Chapter 3, Annex B, Appendix 1 (303 PC).

### **CLOSING STATEMENT**

Successful supervisors are usually successful leaders. Supervisors safeguard others, encourage others, and empower others to use their skills, expertise and ideas to produce results.



**INSTRUCTOR NOTES/REMARKS**

N/A.

---

**REFERENCES**

---

- A0-107 CATO 14-31 Director Cadets 5. (2007). *Director Cadets and Junior Canadian Rangers General Safety Program*. Ottawa, ON: Department of National Defence.
- C0-249 (ISBN 0-7894-2890-3) Heller, R. (1998). *How to Delegate*. New York, NY: DK Publishing, Inc.
- C0-272 Coleridge Education, College of St. Mark and St. John. (2002). *A Consultation of Supervision Provision and Training Requirements Across Connexions Partnerships in England*. Retrieved March 17, 2008 from <http://www.connexions.gov.uk/partnerships/publications/uploads/cp/Supervisory%20Skills%20Exec%20Sum.pdf>.
- C0-273 (ISBN 978-1-56414-363-1) Ladew, D. P. (1998). *How to Supervise People: Techniques for Getting Results Through Others*. Franklin Lakes, NJ: Career Press.
- C0-274 (ISBN 1-4134-1294-7) Sargent, G. (2003). *The Little Black Book of Supervision*. USA: Xlibris Corporation.

THIS PAGE INTENTIONALLY LEFT BLANK



**COMMON TRAINING  
SILVER STAR  
INSTRUCTIONAL GUIDE**



**SECTION 6  
EO M303.06 – SOLVE PROBLEMS**

---

Total Time:

60 min

---



---

**PREPARATION**

---

**PRE-LESSON INSTRUCTIONS**

Resources needed for the delivery of this lesson are listed in the lesson specification located in A-CR-CCP-703/PG-001, Chapter 4. Specific uses for said resources are identified throughout the instructional guide within the TP for which they are required.

Review the lesson content and become familiar with the material prior to delivering the lesson.

Photocopy the problem-solving scenarios located at Annex E.

**PRE-LESSON ASSIGNMENT**

N/A.

**APPROACH**

An interactive lecture was chosen for TPs 1–3 to review logical analysis and orient the cadets to additional problem-solving methods.

An in-class activity was chosen for TP 4 as an interactive way to provoke thought and stimulate interest among cadets about problem solving.

---

**INTRODUCTION**

---

**REVIEW**

N/A.

**OBJECTIVES**

By the end of this lesson the cadet shall have solved problems.

**IMPORTANCE**

One important skill that a team leader must have is the ability to solve problems. As cadets become team leaders, they will use this skill more often. Cadets have a greater chance of success in solving problems if they have a variety of problem-solving methods to choose from.

**Teaching Point 1****Review the Steps for Logical Analysis**

Time: 5 min

Method: Interactive Lecture

**LOGICAL ANALYSIS**

The eight steps in logical analysis were taught in the previous year. They are:

1. confirming the task;
2. identifying the problem;
3. determining the critical factor;
4. developing alternative solutions;
5. comparing alternative solutions;
6. determining the best solution;
7. implementing the solution; and
8. evaluating the plan and the implementation.

**CONFIRMATION OF TEACHING POINT 1****QUESTIONS**

- Q1. What is the first step in logical analysis?
- Q2. What is the third step in logical analysis?
- Q3. What is the last step in logical analysis?

**ANTICIPATED ANSWERS**

- A1. Confirming the task.
- A2. Determining the critical factor.
- A3. Evaluating the plan and the implementation.

**Teaching Point 2****Explain the Steps in the IRISE Method of Problem Solving**

Time: 10 min

Method: Interactive Lecture



The IRISE method of problem solving is much like logical analysis but has fewer steps to remember.

The IRISE method of problem solving was developed for adolescents.

IRISE is an acronym. The IRISE method of problem solving has five steps. They are:

1. **Identifying the Problem.** To be able to solve a problem, cadets must understand what the problem really is. If the problem is not clearly identified, a problem may be solved but it may not be the “real” problem. Questions that should be asked in step one include:

- What do we wish to accomplish?
  - How much time will we need?
  - What resources do we have?
  - What resources do we need?
2. **Researching All of the Options.** This step involves “brainstorming” options to solve the problem. Cadets will have to research each option. Some options will need to be discussed outside the team and some options will need to be critically and methodically investigated. There will be some options which will solve the problem easily and some options will be more difficult. Some questions may need to be asked, such as:
- Which option is the simplest?
  - Which option is the safest?
  - What is the worst possible outcome?
  - Which option is the most flexible?
  - Which option uses available resources in an economical manner?
3. **Identifying the Consequences of the Options.** Each option will have consequences. Ensuring the cadets know what the consequences may be before putting a decision into action, may help to eliminate options with undesirable consequences. There may be consequences to options that will not be known, but these should be very limited.
4. **Selecting the Most Appropriate Option.** This is the step where the option is selected and implemented. Once an option is selected, a plan for implementation should be created. It is now time to put the plan into action.
5. **Evaluating the Decision.** Once the plan is implemented, evaluate the decision. Examine the implementation of the option and the needs that may not have been anticipated. Questions may include:
- Was the option a good one?
  - Was the plan to implement the option a success?
  - What can we do to improve the plan or the implementation for the next time?
  - What lessons were learned?

---

### CONFIRMATION OF TEACHING POINT 2

---

#### QUESTIONS

- Q1. For whom was the IRISE method of problem solving developed?
- Q2. The IRISE method of problem solving is similar to what other method of problem solving?
- Q3. What are the steps in the IRISE method of problem solving?

#### ANTICIPATED ANSWERS

- A1. For adolescents.
- A2. Logical analysis.
- A3. The steps in the IRISE method of problem solving are:

- (1) identifying the problem;
- (2) researching all of the options;
- (3) identifying the consequences of the options;
- (4) selecting the most appropriate option; and
- (5) evaluating the decision.

---

**Teaching Point 3**

**Explain the Steps in the TEACH Method of Problem Solving**

Time: 10 min

Method: Interactive Lecture

---



The TEACH method of problem solving is much like the IRISE method, which is like logical analysis.

The TEACH method of problem solving was developed for a team approach. The TEACH method of problem solving is another situation where positive team dynamics should be displayed.

TEACH is an acronym. The TEACH method of problem solving has five steps. They are:

1. **Time.** This first step involves spending time to discover the real issue or problem. With the assistance of the team the “real” problem must be identified. Questions that should be asked in the “time” step should be the same as the identifying the problem questions for the IRISE method.
2. **Exposure.** This second step involves uncovering what others have done in a similar situation. By using information gathered from others, the number of options that may be created to solve the problem should increase.
3. **Assistance.** This third step involves having your team study all the information from different perspectives. The team will be a great asset because differing views, based on knowledge and experience of the same issue, will lead to a better result and a more collaborative environment.
4. **Creativity.** This fourth step involves having the team “brainstorm” options and the consequences of those options. Again, the team will be a great asset because of differing views based on knowledge and experience.
5. **Hit it.** This last step involves implementing the best option. The team will help develop a plan to implement the selected option. After the option has been implemented, evaluation of the option and its implementation will need to take place. Questions to evaluate the implementation should be the same as the IRISE method of problem solving.

---

**CONFIRMATION OF TEACHING POINT 3**

---

**QUESTIONS**

- Q1. For what kind of approach was the TEACH method of problem solving developed?
- Q2. The TEACH method of problem solving is much like what other method of problem solving?
- Q3. List the five steps to the TEACH method of problem solving.

**ANTICIPATED ANSWERS**

A1. For a team approach.

A2. The IRISE method.

A3. The five steps to the TEACH method of problem solving are:

- time,
- exposure,
- assistance,
- creativity, and
- hit it.

**Teaching Point 4****Conduct an Activity Where Cadets Will Select a Problem-Solving Method and Apply it to a Scenario**

Time: 25 min

Method: In-Class Activity



Use all four scenarios located at Annex E. Distribute evenly among cadets (eg, four cadets receive scenario 1, four cadets receive scenario 2, three cadets receive scenario 3 and three cadets receive scenario 4).

**ACTIVITY****OBJECTIVE**

The objective of this activity is for cadets to select a problem-solving method and apply it to a scenario.

**RESOURCES**

- Scenario, and
- Pen/pencil.

**ACTIVITY LAYOUT**

N/A.

**ACTIVITY INSTRUCTIONS**

1. Distribute one scenario to each cadet.
2. Cadets shall choose a problem-solving method and apply its steps to the scenario. Cadets will write down their method and steps on the scenario paper.



Cadets may choose any method to solve the problem including Trial and Error, Logical Analysis, STOP, IRISE or TEACH.

3. After 10 minutes, have the cadets find everyone else in the class who has the same scenario. Cadets will share their ideas within the group.
4. After 5 minutes, have each group present their scenario to the class with the problem-solving methods and their possible solutions.

**SAFETY**

N/A.

---

**CONFIRMATION OF TEACHING POINT 4**

---

The cadets' participation in the activity will serve as the confirmation of this TP.

---

**END OF LESSON CONFIRMATION**

---

The cadets' participation in the problem-solving activity will serve as the confirmation of this lesson.

---

**CONCLUSION**

---

**HOMEWORK/READING/PRACTICE**

N/A.

**METHOD OF EVALUATION**

This EO is assessed IAW A-CR-CCP-703/PG-001, Chapter 3, Annex B, Appendix 1 (303 PC).

**CLOSING STATEMENT**

It is important to practice the skill of problem solving. Learning to solve problems is a leadership skill. Cadets have a greater chance of success in solving problems if they have a variety of problem-solving methods to choose from.

**INSTRUCTOR NOTES/REMARKS**

N/A.

---

**REFERENCES**

---

- C0-115 (ISBN 0-7879-4059-3) van Linden, J. A., & Fertman, C. I. (1998). *Youth Leadership*. San Francisco, CA: Jossey-Bass Inc., Publishers.
- C0-134 (ISBN 0-7852-7440-5) Maxwell, J. (1999). *The 21 Indispensable Qualities of a Leader: Becoming the Person Others Will Want to Follow*. Nashville, TN: Thomas Nelson Publishers.
- C0-135 (ISBN 0-7645-5176-0) Loeb, M., & Kindel, S. (1999). *Leadership for Dummies*. New York, NY: Hungry Minds, Inc.





**COMMON TRAINING**  
**SILVER STAR**  
**INSTRUCTIONAL GUIDE**



**SECTION 7**

**EO M303.07 – LEAD CADETS THROUGH A LEADERSHIP ASSIGNMENT**

---

Total Time:

60 min

---

**PREPARATION**

---

**PRE-LESSON INSTRUCTIONS**

Resources needed for the delivery of this lesson are listed in the lesson specification located in A-CR-CCP-703/PG-001, Chapter 4. Specific uses for said resources are identified throughout the instructional guide within the TP for which they are required.

Review the lesson content and become familiar with the material prior to delivering the lesson.

Review the assessment instructions located at A-CR-CCP-703/PG-001, Chapter 3, Annex B, Appendix 1 (303 PC).

Become familiar with the Rearrange Classroom Space leadership assignment located at Annex G.

Make a sketch of the classroom for the Rearrange Classroom Space leadership assignment which will be used throughout the lesson.

Photocopy the Leadership Assignment Format handout located at Annex H for each cadet.

Photocopy the After-Assignment Report and 303 PC Assessment Rubric located at Annex I for each cadet.

Photocopy the Leadership Assignment Assessment Rubric located at A-CR-CCP-703/PG-001, Chapter 3, Annex B, Appendix 1 for each cadet.

Leadership assignments will require different levels of planning and experience from the cadets. Select a leadership assignment for each cadet based on their ability. Ensure the sample stretches located at Annex K are photocopied for those cadets who are completing leadership assignments involving warming up or cooling down muscles.

Photocopy the Leadership Assignment Planning Guide located at Annex M for each cadet.

**PRE-LESSON ASSIGNMENT**

N/A.

**APPROACH**

A demonstration was chosen for TPs 1–4 as it allows the instructor to explain and demonstrate the format of a leadership assignment in a safe, controlled environment.

An interactive lecture was chosen for TP 5 to give direction on the procedure for completing an after-assignment report.

An in-class activity was chosen for TP 6 as it is an interactive way to provoke thought and stimulate interest among cadets.

---

## INTRODUCTION

---

### REVIEW

N/A.

### OBJECTIVES

By the end of this lesson the cadet shall be expected to lead peers through a leadership assignment.

### IMPORTANCE

It is important for cadets to understand the steps involved in completing leadership assignments as they occur many times throughout cadet training. All cadets will be required to complete at least two leadership assignments during Silver Star. When given an assignment, every cadet must know the steps involved for successful completion. An effective leader will merge together all of the pieces learned throughout leadership training, such as solving problems and supervising, to successfully lead a team through an assignment.



During Silver Star, each cadet will be required to complete at least two leadership assignments. A list of Possible Year Three Leadership Assignments is located at Annex F.

---

### Teaching Point 1

### Discuss and Demonstrate the Process of Preparing for a Leadership Assignment

Time: 10 min

Method: Demonstration



Discuss the aspects of preparing for a leadership assignment.

Use the sample leadership assignment located at Annex G to demonstrate the preparation stage.

Distribute copies of the Leadership Assignment Format handout located at Annex H and the After-Assignment Report and the 303 PC Assessment Rubric located at Annex I to each cadet. Distribute copies of the Leadership Assignment Planning Guide located at Annex M. Encourage the cadets to view each section as it is explained throughout this lesson.

## PREPARE FOR A LEADERSHIP ASSIGNMENT

### Ensure the Goal is Understood

Always ask questions to the directing staff, especially when there is doubt about any portion of the assignment. Before spending any time planning, the leader must ensure that what they think needs to happen is actually the goal of the assignment.

### **Ensure the Required Resources are Available**

Make sure that all the resources required to complete the assignment are available. Complete a reconnaissance by looking around the area. Try to locate other resources that may be used. If boundaries have been determined, locate them.

### **Complete a Time Appreciation**

Be aware of the time given for the completion of the assignment. If the assignment must be broken down into stages, the leader must determine how much time must be allocated to each. Sometimes tasks can be done concurrently, which will save time in the end.

When completing a time appreciation, check the time. All members involved in the assignment must be aware of the current time and the expected time of completion.

### **Make a Plan**

Using the planning guide (located at Annex M), make a plan to accomplish the goal of the assignment by:

- determining the tasks that need to be completed;
- developing a process to accomplish all tasks; and
- allocating resources.

The plan will include the answers to who, what, when, where, how and why. Who will do what? Who does it involve? What is going to be done? When does it start? When does it end? Where will it take place? How will it take place? Why must it be done? What will happen if it is not done?



Tasks can be assigned to individuals or teams. All members must have something to do.

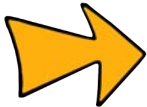

If the leader is given an unfamiliar assignment, ask questions to the directing staff to help clarify. If the leader has no experience with what is involved in the assignment, they may also ask a fellow cadet to clarify and then continue to make the plan. The more complex tasks may go to a cadet who has had previous experience with the requirements of the assignment.



A sample process for preparing the “Rearrange Classroom Space” leadership assignment could be:

1. Read the assignment.
2. Ask a question or two to ensure the assignment is understood. For example, “Which way will the classroom face?” or “So I can use more than four cadets?”
3. Look around the area to make sure all of the required resources are available.
4. Complete a time appreciation by checking and analyzing the time. For example, it will take three minutes to prepare and introduce the assignment, it will take approximately five minutes to complete the assignment and it will take approximately two minutes to carry out a debriefing.
5. Make a plan for the completion of the leadership assignment. The plan could include:
  - (a) dividing the team members into three teams (Team A, Team B and Team C);
  - (b) showing a brief sketch of what the classroom should look like at the end of the assignment;
  - (c) assigning Team A to rearrange the chairs;
  - (d) assigning Team B to rearrange the desks/tables; and
  - (e) assigning Team C to put the whiteboard and any electronic equipment in place.

---

### CONFIRMATION OF TEACHING POINT 1

---

#### QUESTIONS

- Q1. How can the leader make sure the goal is understood?
- Q2. What must be considered when completing a time appreciation?
- Q3. When making a plan, what must the leader do in order to accomplish the goal of the assignment?

#### ANTICIPATED ANSWERS

- A1. Ask questions to the directing staff.
- A2. Be aware of the time given for the completion of an assignment. If the assignment must be broken down into stages, the leader must determine how much time must be allocated to each. Sometimes tasks can be done concurrently, which will save time in the end.
- A3. The leader must determine all tasks, develop a process to accomplish all tasks and allocate resources.

**Teaching Point 2****Discuss and Demonstrate the Process of Introducing a Leadership Assignment**

Time: 10 min

Method: Demonstration



Discuss the aspects for introducing a leadership assignment.

Use the sample leadership assignment located at Annex G to demonstrate the introduction stage.

**INTRODUCE A LEADERSHIP ASSIGNMENT**

When giving the introduction, the leader must ensure they have the attention of all of the team members. If one cadet is not paying attention, it could affect the end state of the leadership assignment.

When introducing a leadership assignment, the leader must speak loudly, clearly and concisely, to let everyone know that they have faith in their plan. A leader who speaks with authority will capture the attention of team members and make them want to participate in the assignment.

**State the Assignment to be Completed**

Tell the team members the “big picture” of what is going to be done.



This statement could simply include the title of the leadership assignment.

**State the Goal of the Assignment**

What is the end state? If there is a reason for completing the assignment (eg, a guest speaker is coming, to begin summer biathlon, etc) it should be stated. If a sketch is included, it should be shown here so that everyone has a sense of what the result should be. When stating the goal, time requirements should be included.

**Identify the Resources Required for the Assignment**

Ensure that all of the cadets are aware of the resources that are required to complete the assignment and where these resources are located.

**Communicate the Overall Plan**

Explain how the assignment will be conducted. All members should know what is to be done, but will find out what their specific part is in another step. If boundaries exist, include them in the plan.

**Assign Tasks to Team Members as Applicable**

Assign all team and individual tasks needed to complete the assignment. Every member must have something to do.

## Ensure the Team Members Understand the Assignment

Ask the team if they have any questions. The leader should also ask a few questions to various members of the team to ensure comprehension. When members are given specific tasks, it is extremely important that they are completely aware of what is expected of them.



Asking “What are you going to do?” is more effective than “Do you understand?”

Never ask yes/no questions when ensuring that team members understand the assignment. Some may be too embarrassed or timid to admit that they do not completely understand, which will jeopardize the effectiveness of the plan.



After the introduction stage, all of the cadets should know where they fit into the overall plan and how, by working together, they will accomplish much more than they could as individuals.



A sample introduction for the “Rearrange Classroom Space” leadership assignment could be:

1. “Today we will be rearranging this classroom space for a guest speaker presentation.”
2. “The goal of this assignment is to rearrange the classroom by turning it around to face the opposite direction. We have five minutes to complete the assignment once we begin.” Show the sketch to the cadets.
3. “Resources required include chairs, tables, a whiteboard and a liquid crystal display (LCD) projector.”
4. “In order to turn the classroom around, the team will be divided into three teams; A, B and C. One team will be in charge of chair placement, another in charge of table placement and the other in charge of whiteboard and LCD projector placement. Each team will complete their task concurrently.”
5. Divide the cadets into three teams.
6. “Team A will rearrange the chairs, Team B will rearrange the tables and Team C will put the whiteboard and LCD projector in place.”
7. Ask two or three cadets to state what their task is to ensure understanding.

---

## CONFIRMATION OF TEACHING POINT 2

---

### QUESTIONS

- Q1. What are the steps to introduce a leadership assignment?
- Q2. What is the goal of the assignment?
- Q3. How can the leader make sure team members understand the assignment?

### ANTICIPATED ANSWERS

- A1. The steps are:
- state the assignment to be completed;

- state the goal of the assignment;
- identify the resources required for the assignment;
- communicate the overall plan;
- assign tasks to team members as applicable; and
- ensure the team members understand the assignment.

A2. The end state.

A3. Ask the group if they have any questions. The leader should also ask a few questions to various members of the team.

---

### Teaching Point 3

### Discuss and Demonstrate the Process of Conducting a Leadership Assignment

Time: 10 min

Method: Demonstration

---



Discuss the aspects of conducting a leadership assignment.

Use the sample leadership assignment located at Annex G to demonstrate the conducting stage.

## CONDUCT A LEADERSHIP ASSIGNMENT

### Supervise Peers

When an assignment is being conducted, the leader must constantly supervise the team members. The most important aspect of supervision is to ensure that the assignment is being conducted safely. If cadets are completing aspects of the assignment unsafely, stop the task immediately.

The cadets must remain focused on the goal. If mistakes occur, correct them as soon as possible. If members are experiencing difficulty, take time to reanalyze and reassign tasks. Asking questions throughout the completion of the assignment will ensure that all team members remain focused and that those (if any) who are experiencing difficulty are identified.

### Maintain Team Control

Ensure that all team members understand that the leader is in charge and that everyone is following the plan laid out in the introduction stage. When members are not completing what was asked of them, correct it immediately.

A way to maintain team control is to motivate throughout the task and encourage team members to motivate each other. This will help create a positive environment.

### Ensure the Assignment is Progressing According to the Time Allotted

Keep checking the time. If tasks are not being completed as planned, whether too slow or too fast, the plan may need to be reanalyzed.

### Modify the Plan as Required

If the plan is not working, take time to modify it. If help is required from team members, ask for it. Changing aspects of the plan partway through the assignment may benefit the outcome; however always keep time limits in mind. Once a new plan has been developed, have the team stop what they are doing, communicate the new plan to the members and then have them implement it.



A sample process for conducting the “Rearrange Classroom Space” leadership assignment could be:

1. Have the cadets begin the assignment.
2. Supervise the cadets by walking around, visually inspecting work and ensuring the assignment is being completed safely. Correct any mistakes or errors and ask questions (eg, “Are you having difficulty with your assigned task?”) to ensure everyone remains focused on the assignment.
3. Ensure the teams are working together toward the same goal.
4. Motivate the cadets throughout the assignment.
5. Check the time occasionally to make sure the assignment is progressing according to the time limits set.
6. Modify the plan as required.

---

### CONFIRMATION OF TEACHING POINT 3

---

#### QUESTIONS

- Q1. What is the most important aspect of supervision?
- Q2. What should the leader do if members are not completing what was asked of them?
- Q3. If a plan needs to be modified, what should happen once the new plan has been developed?

#### ANTICIPATED ANSWERS

- A1. The most important aspect of supervision is to ensure that the assignment is being conducted safely.
- A2. When members are not completing what was asked of them, correct it immediately.
- A3. Once a new plan has been developed, have the team stop what they are doing, communicate the new plan to the members and then have them implement it.

---

#### Teaching Point 4

#### Discuss and Demonstrate the Process of Debriefing a Team Following a Leadership Assignment

Time: 10 min

Method: Demonstration

---



Use the sample leadership assignment located at Annex G to demonstrate the debriefing stage.

#### DEBRIEF A TEAM FOLLOWING A LEADERSHIP ASSIGNMENT

##### Review the Goal

After the completion of a leadership assignment, it is important to review what the goal of the assignment was with the cadets.



## Provide Feedback

The leader should first ask for feedback on the assignment from the team. This can be done using general questions about leadership assignments, such as:

- Was there anything learned from the assignment?
- How did you feel about the assignment?
- Was the goal met?
- How did everyone interact during the assignment?
- Were there behaviours that helped and/or hindered the assignment?
- Were there any cadets who were not motivated to participate in the activity? How did this affect the morale of the remainder of the team?
- Were there leaders that emerged within the team?



It is important to know how the cadets felt about their participation in the completion of the assignment.

It is also important to give feedback to the cadets. It is vital for the leader to spend time focusing on how the team worked together to achieve a common goal.

## Re-Motivate the Team

The final step in debriefing a team after a leadership assignment has been completed is to re-motivate the cadets. The cadets need to be reminded of the importance of working together to accomplish an assignment.



A sample debriefing for the “Rearrange Classroom Space” leadership assignment could be:

1. Bring all of the cadets together.
2. Review the goal. For example “Great job team, we rearranged the classroom. It looks exactly like the sketch!”
3. Ask feedback questions to the team such as:
  - (a) How did you feel about the completion of the assignment?
  - (b) Were there behaviours that helped and/or hindered the assignment?
  - (c) Were there leaders that emerged within the team?
4. Re-motivate the team by reminding them of the importance of working together to accomplish an assignment.

---

## CONFIRMATION OF TEACHING POINT 4

---

## QUESTIONS

- Q1. What are the three steps of a leadership assignment debriefing?
- Q2. What are some questions that can be asked to get the team to provide feedback?
- Q3. Why is it important to re-motivate the team?

## ANTICIPATED ANSWERS

A1. The three steps of a leadership assignment debriefing:

- reviewing the goal;
- providing feedback; and
- re-motivating the team.

A2. Some questions could include:

- Was there anything learned from the assignment?
- How did you feel about the assignment?
- Was the goal met?
- How did everyone interact during the assignment?
- Were there behaviours that helped and/or hindered the assignment?
- Were there any cadets who were not motivated to participate in the activity? How did this affect the morale of the remainder of the team?
- Were there leaders that emerged within the team?

A3. The cadets need to be reminded of the importance of working together to accomplish an assignment.

---

### Teaching Point 5

### Explain the After-Assignment Report

Time: 5 min

Method: Interactive Lecture

---



It is important for the cadets to construct their own learning and decide the importance of the assignment that was conducted. This may not be the same for every leader.

## AFTER-ASSIGNMENT REPORT

The after-assignment report is a tool for cadets to use to reflect on their performance after completing a leadership assignment. It is used by the cadet (the leader) during the feedback session with the directing staff to help guide the discussion. The feedback session will take place after the assignment was completed.

Each cadet will complete an after-assignment report before attending the feedback session for the leadership assignment.

## LEADERSHIP ASSIGNMENT ASSESSMENT RUBRIC

The leadership assignment Assessment Rubric is the form the directing staff will use to assess each cadet's performance as a peer leader when conducting a leadership assignment.

Each cadet will be required to complete their own leadership assignment assessment in conjunction with their after-assignment report and bring it to the debriefing. This form will be used as a self-assessment tool for reflection and discussion with the directing staff.



The results that a cadet reveals on the assessment form shall not affect the results given by the directing staff.

---

## CONFIRMATION OF TEACHING POINT 5

---

**QUESTIONS**

- Q1. What is the after-assignment report?
- Q2. To whom is the after-assignment report presented?
- Q3. How long after the leadership assignment will the debriefing occur?

**ANTICIPATED ANSWERS**

- A1. The after-assignment report is a tool for cadets to use to reflect on their performance after completing a leadership assignment. It is used by the cadet (the leader) during the debriefing with the directing staff to help guide the discussion.
- A2. The directing staff.
- A3. The debriefing will take place the day after the assignment was completed.

---

**Teaching Point 6**
**Discuss How to Plan for a Leadership Assignment**

Time: 5 min

Method: In-Class Activity

---

### ACTIVITY

---

**OBJECTIVE**

The objective of this activity is for the cadets to complete the preparation stage of a leadership assignment.

**RESOURCES**

- Leadership assignment located at Annexes J and L,
- Leadership Assignment Planning Guide located at Annex M, and
- Pen/pencil.

**ACTIVITY LAYOUT**

N/A.

**ACTIVITY INSTRUCTIONS**

1. Explain that this step is normally completed directly before the leadership assignment is to be conducted. Time will be given to develop a plan for the leadership assignment when each assignment is given. Both leadership assignments will be conducted at a later time.
2. Distribute a leadership assignment to each cadet.
3. Encourage the cadets to ask questions if the goal is not understood.
4. Tell the cadets to assume that all required resources are available.
5. Ensure the cadets are aware that there are aspects of planning that must still be completed when leading a team through the leadership assignment. For example, questions must still be asked to make sure the goal is understood, resources must still be checked and a time appreciation must still be completed. At

this point during the actual leadership assignment, some cadets may wish to revisit/reanalyze the plan developed during this activity.

6. Have the cadets develop a plan to conduct their leadership assignment. The cadets may work in small teams if desired for answering questions and assisting with planning.

### **SAFETY**

N/A.

---

### **CONFIRMATION OF TEACHING POINT 6**

---

The cadets' participation in the in-class activity will serve as the confirmation of this TP.

---

### **END OF LESSON CONFIRMATION**

---

### **QUESTIONS**

- Q1. What are the five main steps to complete a leadership assignment?
- Q2. What is one way to maintain team control?
- Q3. What is an after-assignment report?

### **ANTICIPATED ANSWERS**

- A1. The five main steps are:
  - preparing for the assignment;
  - introducing the assignment;
  - conducting the assignment;
  - debriefing the team; and
  - presenting an after-assignment report.
- A2. A way to maintain team control is to motivate throughout the assignment and encourage team members to motivate each other. This will help create a positive environment.
- A3. The after-assignment report is a tool for cadets to use to reflect on their performance after completing a leadership assignment. It is used by the cadet (the leader) during the debriefing with the directing staff to help guide the discussion.

---

### **CONCLUSION**

---

### **HOMEWORK/READING/PRACTICE**

Any cadets who did not complete their plans will be required to complete them as homework.

### **METHOD OF EVALUATION**

This EO is assessed IAW A-CR-CCP-703/PG-001, Chapter 3, Annex B, Appendix 1 (303 PC).

### **CLOSING STATEMENT**

Leadership assignments will occur many times throughout cadet training. When given an assignment, all cadets must know and be comfortable performing the steps involved for successful completion. Being able to combine

all of the segments of leadership training such as solving problems and supervising, into one cohesive unit in order to lead a team through an assignment is a special achievement for which all cadets should strive.

### INSTRUCTOR NOTES/REMARKS

N/A.

---

### REFERENCES

---

- C0-114 (ISBN 0-02-863656-2) Pell, A. R. (1999). *The Complete Idiot's Guide to Team Building*. Indianapolis, IN: Alpha Books.
- C0-240 (ISBN 0-934387-05-2) Collard, M. (2005). *No Props: Great Games With No Equipment*. Beverly, MA: Project Adventure, Inc.
- C0-243 Clark, D. (2007). *After Action Reviews*. Retrieved February 21, 2008, from <http://www.nwlink.com/~donclark/leader/leadaar.html>.
- C0-243 Clark, D. (2007). *Leadership & Direction*. Retrieved February 21, 2008, from <http://www.nwlink.com/~donclark/leader/leaddir.html>.
- C0-245 (ISBN 1-58062-513-4) Adams, B. (2001). *The Everything Leadership Book*. Avon, MA: Adams Media.
- C0-247 (ISBN 0-14-024272-4) Rosen, R. H., & Brown, P. B. (1997). *Leading People*. New York, NY: Penguin Books.
- C0-248 (ISBN 0-7894-4862-9) Heller, R. (1999). *Learning to Lead*. New York, NY: DK Publishing, Inc.
- C0-253 (ISBN 0-7894-8006-9) Bruce, A., & Langdon, K. (2001). *Do It Now!* New York, NY: DK Publishing, Inc.
- C0-254 (ISBN 0-7894-3244-7) Heller, R. (1998). *Communicate Clearly*. New York, NY: DK Publishing, Inc.
- C0-255 (ISBN 0-7645-5408-5) Brounstein, M. (2002). *Managing Teams for Dummies*. Indianapolis, IN: Wiley Publishing, Inc.
- C0-256 (ISBN 0-7894-4863-7) Heller, R. (1999). *Achieving Excellence*. New York, NY: DK Publishing, Inc.

THIS PAGE INTENTIONALLY LEFT BLANK



**COMMON TRAINING**  
**SILVER STAR**  
**INSTRUCTIONAL GUIDE**



**SECTION 8**

**EO C303.01 – LEAD A TEAM-BUILDING ACTIVITY**

---

Total Time:

90 min

---

**PREPARATION**

---

**PRE-LESSON INSTRUCTIONS**

Resources needed for the delivery of this lesson are listed in the lesson specification located in A-CR-CCP-703/PG-001, Chapter 4. Specific uses for said resources are identified throughout the instructional guide within the TP for which they are required.

Review the lesson content and become familiar with the material prior to delivering the lesson.

Photocopy one team-building activity per group from the activities located at Annex N for the activity in TP 7.

Photocopy handouts of two team-building activities for each cadet – one activity from Annex O and one from Annex P.

Photocopy two Team-Building Planning Guides located at Annex Q for each cadet.

Photocopy the Self-Assessment Form located at Annex R for each cadet.

Prepare the activity for TP 3 by:

- gathering two colours of sticky notes and a marker;
- writing each consonant of the alphabet (minus Q, X and Z) on one colour of sticky notes (one letter per note);
- writing each vowel on the second colour of sticky notes (one letter per note); and
- ensuring there are enough letters for every cadet (if there are more cadets than letters, create duplicates of common letters [eg, A, E, N, R, S, T, etc]).

Ensure one or two assistant instructor(s) are available for the activity in TP 7 (depending on the number of cadets).

**PRE-LESSON ASSIGNMENT**

N/A.

**APPROACH**

An in-class activity was chosen for TPs 1, 3 and 5 as it is an interactive way to provoke thought and stimulate interest among cadets.

A group discussion was chosen for TPs 2, 4 and 6 as it allows the cadets to interact with their peers and share their knowledge, experiences, opinions and feelings about the components of team-building activities.

A practical activity was chosen for TP 7 as it is an interactive way to allow the cadets to experience team-building activities in a safe and controlled environment.

---

## **INTRODUCTION**

---

### **REVIEW**

N/A.

### **OBJECTIVES**

By the end of this lesson the cadet shall have led team-building activities.

### **IMPORTANCE**

It is important for cadets to know how to lead team-building activities to ensure that they are fun, challenging and achievable for every cadet. Each cadet will be given the opportunity to lead two team-building activities. Team-building activities are a great way to relieve boredom, lift team spirit, increase morale, re-energize cadets and accomplish goals. Therefore, every cadet in a leadership role should be able to lead activities focusing on these things. Once an activity that meets the needs of the group has been selected, it is the role of the leader to ensure the activity is completed in a manner that allows the group to learn. A meaningful and enjoyable team-building experience will occur for every cadet when the right activity is conducted in an appropriate fashion.





There are three components to leading a team-building activity. The individual leading a team-building activity should:

- introduce the activity;
- conduct the activity; and
- debrief the cadets on the activity.

To ensure the cadets understand how to lead a team-building activity, they will participate in each component separately as the instructor leads them through a sample team-building activity. Each component will then be discussed as it is completed to ensure understanding.

TPs 1–6 are to be conducted in the following manner:

- In TP 1 the cadets will participate as the instructor introduces a sample team-building activity.
- In TP 2 the cadets will participate in a group discussion that allows them to analyze the elements of an introduction as it was completed in TP 1.
- In TP 3 the cadets will participate as the instructor conducts a sample team-building activity.
- In TP 4 the cadets will participate in a group discussion that allows them to discuss the responsibilities of the leader while conducting a team-building activity as it was completed in TP 3.
- In TP 5 the cadets will participate as the instructor debriefs the cadets on the sample team-building activity conducted in TP 3.
- In TP 6 the cadets will participate in a group discussion that allows them to discuss the elements of a debriefing as it was completed in TP 5.

---

### Teaching Point 1

### Demonstrate and Have the Cadets Participate in an Introduction to a Team-Building Activity

Time: 5 min

Method: In-Class Activity

---

## ACTIVITY

---

### OBJECTIVE

The objective of this activity is for the cadets to participate in an introduction to a team-building activity as it is led by the instructor.

### RESOURCES

N/A.

### ACTIVITY LAYOUT

N/A.

### ACTIVITY INSTRUCTIONS

1. Get the attention of the cadets. Inform the cadets that they will be participating in an activity called “Alphabet Soup” (***Get the Team’s Attention***).

2. Explain that the goal of the team-building activity is to energize the cadets and get them moving (**Explain the Goal of the Activity**).
3. Explain the activity and allow time for the cadets to ask questions for clarification (**Explain the Activity and Assign Tasks as Necessary**), to include:
  - (a) every cadet gets a letter and sticks it to the front of their shirt;
  - (b) the cadets get a few minutes to form appropriate words using at least four letters; and
  - (c) once the cadets get used to forming small words, create longer words or small sentences.
4. Set a time limit of 10 minutes for the activity (**Set Time Limits**).
5. Motivate the cadets to participate in the activity (**Motivate the Team**).

## SAFETY

N/A.

---

### CONFIRMATION OF TEACHING POINT 1

---

The cadets' participation in the introduction to "Alphabet Soup" will serve as the confirmation of this TP.

---

## Teaching Point 2

## Have the Cadets Analyze the Elements of an Introduction

Time: 10 min

Method: Group Discussion

---

---

### BACKGROUND KNOWLEDGE

---



The point of the group discussion is to draw the following information from the group using the tips for answering/facilitating discussion and the suggested questions provided.

## ELEMENTS OF AN INTRODUCTION

### Getting the Team's Attention

In order to introduce a new activity, the leader must first get the attention of the team. The leader should get the team's undivided attention before continuing to introduce the activity. If one cadet is not paying attention they could miss an important point that could affect their participation in the activity or the activity's outcome.

### Explaining the Goal of the Activity

The goal of the activity should be explained to the team in general terms of what will be learned or accomplished. The context of the activity should be explained so the cadets know why their participation is essential and why the activity is a part of the day's agenda. It is important not to give too much detail at this point, as the leader should draw some points on the purpose of the activity from the cadets after the activity's completion.

### Explaining the Activity

The activity must be explained to the team prior to participating in the activity. The rules of the activity must be clearly outlined and understood by all cadets prior to commencement. The leader should give step-by-step instructions to ensure the activity is clearly understood.

### Assigning Tasks as Necessary

If any specific tasks need to be performed throughout the activity, the leader should assign cadets to these tasks during the introduction of the activity.

### Setting Time Limits

The leader is to set a time limit for the cadets to participate in the activity. The leader must factor in time for debriefing the cadets after completion of the activity. The team must be told how long they have to participate in or complete the assigned activity.

### Relaying Safety Concerns as Necessary

If there are any safety concerns, the leader must pass these on to the team prior to the start of the activity.

### Motivating the Team

Prior to the start of the activity, the leader must motivate the team. The leader should be enthusiastic and share this enthusiasm with the cadets. The goal of the activity is important and there is a reason the activity is being performed. The cadets should be informed of this reason and be motivated toward achieving the goal.

## GROUP DISCUSSION



### TIPS FOR ANSWERING/FACILITATING DISCUSSION

- Establish ground rules for discussion, eg, everyone should listen respectfully; don't interrupt; only one person speaks at a time; no one's ideas should be made fun of; you can disagree with ideas but not with the person; try to understand others as much as you hope they understand you; etc.
- Sit the group in a circle, making sure all cadets can be seen by everyone else.
- Ask questions that will provoke thought; in other words avoid questions with yes or no answers.
- Manage time by ensuring the cadets stay on topic.
- Listen and respond in a way that indicates you have heard and understood the cadet. This can be done by paraphrasing their ideas.
- Give the cadets time to respond to your questions.
- Ensure every cadet has an opportunity to participate. One option is to go around the group and have each cadet answer the question with a short answer. Cadets must also have the option to pass if they wish.
- Additional questions should be prepared ahead of time.

### SUGGESTED QUESTIONS

- Q1. What was the first thing that was done in the introduction to "Alphabet Soup"? Are there different ways to start a team-building activity? What is the first thing you should do?
- Q2. Should the goal of the activity be explained prior to commencing the activity? Why or why not? Will the activity be as successful if the goal is not explained?
- Q3. Why is it important to inform the cadets how much time they have to complete the activity? When would you tell them how much time they have?

Q4. During the introduction to “Alphabet Soup” were you motivated to begin the activity? What effect did this have on you? Did it make you more interested in completing the activity?

Q5. What other considerations should be passed on during an introduction? Should safety concerns be passed on to the team or should they be left to figure them out as they proceed through the activity?



Other questions and answers will develop throughout the group discussion. The group discussion should not be limited to only those suggested.



Reinforce those answers given and comments made during the group discussion, ensuring the teaching point has been covered.

---

### CONFIRMATION OF TEACHING POINT 2

---

The cadets' participation in the group discussion will serve as the confirmation of this TP.

---

#### Teaching Point 3

#### Demonstrate and Have the Cadets Participate in the Selected Team-Building Activity

Time: 10 min

Method: In-Class Activity

---

### ACTIVITY

---

#### OBJECTIVE

The objective of this activity, “Alphabet Soup”, is for the cadets to participate in a team-building activity lead by the instructor.

#### RESOURCES

- A large open space,
- Large sticky notes (two different colours), and
- Marker.

#### ACTIVITY LAYOUT

N/A.

#### ACTIVITY INSTRUCTIONS

1. Distribute a letter to each cadet.
2. Have the cadets stick the letter to the front of their shirts.
3. Give the cadets approximately three minutes to form small words, using at least four letters.
4. Check the words the cadets have formed.

5. Give the cadets approximately five minutes to form longer words or small sentences.

### SAFETY

N/A.

---

### CONFIRMATION OF TEACHING POINT 3

---

The cadets' participation in "Alphabet Soup" will serve as the confirmation of this TP.

---

### Teaching Point 4

### Discuss the Responsibilities of the Leader While Conducting a Team-Building Activity

Time: 10 min

Method: Group Discussion

---

### BACKGROUND KNOWLEDGE

---



The point of the group discussion is to draw the following information from the group using the tips for answering/facilitating discussion and the suggested questions provided.

### RESPONSIBILITIES OF THE LEADER WHILE CONDUCTING THE ACTIVITY

#### Start the Activity

The leader must inform the cadets when to start the activity.

#### Supervise the Team

Throughout the duration of the activity, the leader must supervise to ensure the following:

- there are no unsafe practices being followed;
- the cadets remain focused on the activity; and
- the rules are being followed.

#### Ensure the Goal is Achieved

It is important that the goal of the activity is achieved. If the goal is not achieved, the team-building activity was not successful as a team-building activity, it just became a game. The goal of the activity can sometimes be met without completing the activity. If the goal is not being achieved, the leader may need to:

- refocus the cadets by clarifying the goal of the activity; or
- redirect the activity by modifying the activity to better suit the group.

#### Stop the Activity if Required

There are a number of reasons why a leader may be required to stop an activity. The most important reason to stop an activity prior to completion is safety. If an activity has become a safety issue, the leader must stop the activity immediately.

An activity may also be stopped if the goal is not being achieved. If the activity is moving away from the goal, the leader must either stop and refocus the cadets, redirect the activity or move on to another point.

An activity may also be stopped if the goal has been achieved prior to the time allotted for its completion. Stopping an activity as it reaches its peak will allow the leader to draw out more specific key points and concepts. Not stopping an activity that has reached its peak will cause the following:

- the energy of the team to drop;
- interest in the goal to be lost; and
- understanding of the goal to be lost.

### End the Activity Within the Time Limit

A leader will need to end an activity once the time limit has been met. If the time limit has been met and the activity is not complete, it may be important to attempt the activity at another time. If the purpose of the activity is for the cadets to learn, then it is hard to end an activity until the learning has occurred. If strict time lines are being enforced, the activity can be stopped but it is very important that the leader explain this during the debriefing and perhaps revisit the activity at a later time.

---

## GROUP DISCUSSION

---



### TIPS FOR ANSWERING/FACILITATING DISCUSSION

- Establish ground rules for discussion, eg, everyone should listen respectfully; don't interrupt; only one person speaks at a time; no one's ideas should be made fun of; you can disagree with ideas but not with the person; try to understand others as much as you hope they understand you; etc.
- Sit the group in a circle, making sure all cadets can be seen by everyone else.
- Ask questions that will provoke thought; in other words avoid questions with yes or no answers.
- Manage time by ensuring the cadets stay on topic.
- Listen and respond in a way that indicates you have heard and understood the cadet. This can be done by paraphrasing their ideas.
- Give the cadets time to respond to your questions.
- Ensure every cadet has an opportunity to participate. One option is to go around the group and have each cadet answer the question with a short answer. Cadets must also have the option to pass if they wish.
- Additional questions should be prepared ahead of time.

### SUGGESTED QUESTIONS

- Q1. As the leader of a team-building activity, what do you think some of your responsibilities will be?
- Q2. Throughout the duration of the activity, what do you think is the one thing that every leader must do to ensure safety and progression of the activity?
- Q3. Under what circumstances would an activity have to be stopped? If an activity is stopped prior to its completion, can it be revisited?



Other questions and answers will develop throughout the group discussion. The group discussion should not be limited to only those suggested.



Reinforce those answers given and comments made during the group discussion, ensuring the teaching point has been covered.

---

### CONFIRMATION OF TEACHING POINT 4

---

The cadets' participation in the group discussion will serve as the confirmation of this TP.

#### Teaching Point 5

#### Demonstrate and Have the Cadets Participate in the Debriefing Component of the Selected Team-Building Activity

Time: 5 min

Method: In-Class Activity

---

### ACTIVITY

---

#### OBJECTIVE

The objective of this activity is for the cadets to participate in the debriefing of a team-building activity as it is led by the instructor.

#### RESOURCES

N/A.

#### ACTIVITY LAYOUT

N/A.

#### ACTIVITY INSTRUCTIONS

1. Have the cadets gather and refocus their attention after the completion of the activity.
2. Review that the goal of "Alphabet Soup" was to energize the cadets and get them moving.
3. Provide feedback on the activity such as:
  - (a) how the cadets felt about the activity;
  - (b) what the cadets felt they learned from the activity;
  - (c) if the goal was met;
  - (d) if the activity was completed;
  - (e) how the activity could have been conducted differently;

- (f) how the cadets interacted during the activity; and
- (g) what behaviours helped and/or hindered the activity.

4. Re-motivate the team by:

- (a) discussing the meaning of the activity;
- (b) discussing how the activity and its outcomes relate to the team's everyday interactions; and
- (c) discussing how the learning can affect the team on a daily basis.

**SAFETY**

N/A.

---

**CONFIRMATION OF TEACHING POINT 5**

---

The cadets' participation in a debriefing on "Alphabet Soup" will serve as the confirmation of this TP.

---

**Teaching Point 6**

**Discuss the Elements of a Debriefing**

Time: 10 min

Method: Group Discussion

---

**BACKGROUND KNOWLEDGE**

---



The point of the group discussion is to draw the following information from the group using the tips for answering/facilitating discussion and the suggested questions provided.

**ELEMENTS OF A DEBRIEFING**



It is important during the debriefing to allow the cadets to construct their own learning and decide the importance of the activity that was conducted. This may not be the same for every group.

**Reviewing the Goal**

After the completion of a team-building activity it is important to review what the goal of that activity was with the cadets. Cadets always want to know why they had to participate in an activity or learn about a specific topic so reinforce why the learning was important.

**Providing Feedback**

The leader should first ask for feedback from the group on the activity. This can be done through some preset questions specifically about the activity as well as some general questions about team-building activities. It is important to find out how the cadets felt about the activity (eg, did they feel it was useful, did they learn anything from participating in the activity, etc). The leader will gain valuable insight from the cadets on the activity itself (eg, if they would use it again, how it could be conducted differently, what elements of the activity they would not change if they did the activity again, etc). The most important information to elicit from the cadets is if they felt the activity was worthwhile in that they learned something valuable by participating.



The leader must also give feedback to the cadets. Whether the goal was met is an important point to focus on during this stage. Why was the goal met or why not? Was the activity completed and did this have an effect on the goal being met?

The leader should also give and get feedback on how the group interacted throughout the duration of the activity. The leader should tell the cadets how they viewed the groups' interactions and ask how the cadets felt they interacted with each other. The leader could ask questions such as:

- Were there leaders that emerged within the group?
- Were there any individuals who did not interact well with others during the activity?
- Was there an individual who was not motivated to participate in the activity? How did this affect the morale of the remainder of the group?

### Re-Motivating the Team

The final step in debriefing a group after a team-building activity has been completed is to re-motivate the cadets. The cadets need to be reminded of the importance of team-building activities and be motivated to continue participating in them to achieve new dynamics within a team environment.

---

## GROUP DISCUSSION

---



### TIPS FOR ANSWERING/FACILITATING DISCUSSION

- Establish ground rules for discussion, eg, everyone should listen respectfully; don't interrupt; only one person speaks at a time; no one's ideas should be made fun of; you can disagree with ideas but not with the person; try to understand others as much as you hope they understand you; etc.
- Sit the group in a circle, making sure all cadets can be seen by everyone else.
- Ask questions that will provoke thought; in other words avoid questions with yes or no answers.
- Manage time by ensuring the cadets stay on topic.
- Listen and respond in a way that indicates you have heard and understood the cadet. This can be done by paraphrasing their ideas.
- Give the cadets time to respond to your questions.
- Ensure every cadet has an opportunity to participate. One option is to go around the group and have each cadet answer the question with a short answer. Cadets must also have the option to pass if they wish.
- Additional questions should be prepared ahead of time.

### SUGGESTED QUESTIONS

- Q1. What should a leader do after the completion of a team-building activity? What should be discussed with the group?
- Q2. What is the purpose of reviewing the goal of the activity after completion of the activity?
- Q3. What feedback should be given from the group to the leader? How can this information be obtained? What feedback should the leader give to the group?



Other questions and answers will develop throughout the group discussion. The group discussion should not be limited to only those suggested.



Reinforce those answers given and comments made during the group discussion, ensuring the teaching point has been covered.

---

### CONFIRMATION OF TEACHING POINT 6

---

The cadets' participation in the group discussion will serve as the confirmation of this TP.

---

#### Teaching Point 7

#### Have Small Groups of Cadets Share Responsibilities of Leading a Team-Building Activity

Time: 30 min

Method: Practical Activity

---

### ACTIVITY

---

#### OBJECTIVE

The objective of this activity is for small groups of cadets to share responsibilities of leading a team-building activity.

#### RESOURCES

- A flat, open space free from obstacles,
- Team-building activity located at Annex N (one per group),
- Resources IAW the chosen team-building activities located at Annex N, and
- Team-Building Planning Guide located at Annex Q (one per group).

#### ACTIVITY LAYOUT

N/A.

#### ACTIVITY INSTRUCTIONS



With the help of assistant instructors, observe the partnered groups and offer feedback for Steps 4. to 6.

1. Divide the cadets into an even number of groups (eg, four groups for 24 cadets or less, six groups for 30 cadets).
2. Distribute a team-building activity and a Team-Building Planning Guide to each group.

3. Allow each group approximately 10 minutes to prepare their activity. Ensure that each cadet has a role to play in conducting their activity.
4. Have each group partner with another group for the presentation of their activity (eg, Group 1 will conduct their activity with Group 3 and vice versa).
5. Within the partnered groups, have one group conduct their activity with their partnered group. Allow approximately 15 minutes to conduct the activity. Observe and offer feedback on completion.
6. Within the partnered groups, have the second group conduct their activity with their partnered group. Allow approximately 15 minutes to conduct the activity. Observe and offer feedback on completion.

### **SAFETY**

IAW the chosen team-building activities located at Annex N.

---

### **CONFIRMATION OF TEACHING POINT 7**

---

The cadets' participation in conducting team-building activities as a member of a small group will serve as the confirmation of this TP.

---

### **END OF LESSON CONFIRMATION**

---

The cadets' participation in the activities will serve as the confirmation of this lesson.

---

### **CONCLUSION**

---

### **HOMEWORK/READING/PRACTICE**

N/A.

### **METHOD OF EVALUATION**

N/A.

### **CLOSING STATEMENT**

It is important for you to know how to properly lead team-building activities to ensure that they are fun, challenging and achievable for every cadet. Each of you will be given the opportunity to lead two team-building activities. Team-building activities are a great way to relieve boredom, lift team spirit, increase morale, re-energize cadets and accomplish goals. Once an activity that meets the needs of the group has been selected, it is the role of the leader to ensure the activity is completed in a manner that allows the cadets to learn or to elicit learning from the group. A meaningful and enjoyable team-building experience will occur for every cadet when the right activity is conducted in an appropriate fashion.

### **INSTRUCTOR NOTES/REMARKS**

A self-assessment is to be completed when the cadets lead their team-building activity. The self assessment form located at Annex R.

---

### **REFERENCES**

---

- C0-028 (ISBN 0-07-046513-4) Newstrom, J., & Scannell, E. (1998). *The Big Book of Team Building Games*. New York, NY: McGraw-Hill.

- C0-238 (ISBN 0-7879-4835-7) Sugar, S., & Takacs, G. (2000). *Games That Teach Teams: 21 Activities to Super-Charge Your Group!*, San Francisco, CA: Jossey-Bass/Pfeiffer.
- C0-240 (ISBN 0-934387-05-2) Collard, M. (2005). *No Props: Great Games With No Equipment*. Beverly, MA: Project Adventure, Inc.
- C0-268 (ISBN 1-57542-265-4) MacGregor, M. G. (2008). *Teambuilding With Teens*. Minneapolis, MN: Free Spirit Publishing Inc.



**COMMON TRAINING**  
**SILVER STAR**  
**INSTRUCTIONAL GUIDE**



**SECTION 9**

**EO C303.02 – DELIVER A PRESENTATION ABOUT A LEADER**

Total Time:

60 min

---

**PREPARATION**

---

**PRE-LESSON INSTRUCTIONS**

Resources needed for the delivery of this lesson are listed in the lesson specification located in A-CR-CCP-703/PG-001, Chapter 4. Specific uses for said resources are identified throughout the instructional guide within the TP for which they are required.

Review the lesson content and become familiar with the material prior to delivering the lesson.

Distribute to cadets the outline for delivering a presentation about a leader, located at Annex S, at least two weeks before the presentation is scheduled.

**PRE-LESSON ASSIGNMENT**

Using the outline for delivering a presentation about a leader located at Annex S, the cadets will research a leader of their choice (a military leader, political leader, spiritual leader, teacher, etc) prior to the lesson.

Cadets will bring to the class presentation materials and information about the leader they researched in order to deliver their presentation.

Ensure cadets are familiar with material from EO M309.01 (Explain the Principles of Instruction, Chapter 9, Section 1), EO M309.03 (Describe Effective-Speaking Techniques, Chapter 9, Section 3), EO M309.04 (Describe Questioning Techniques, Chapter 9, Section 4) and EO M309.05 (Select Appropriate Instructional Aids, Chapter 9, Section 5).

**APPROACH**

A practical activity was chosen for this lesson as it is an interactive way to allow cadets to experience giving a presentation in a safe and controlled environment. This activity contributes to the development of leadership skills and knowledge in fun and challenging setting.

---

**INTRODUCTION**

---

**REVIEW**

N/A.

## OBJECTIVES

By the end of this lesson the cadet shall have delivered a presentation about a leader.

## IMPORTANCE

It is important for cadets to deliver a presentation about a leader to assist in their leadership development. By researching and reporting on the core leadership qualities of the leader, cadets may gain an appreciation of how others put these qualities into practice. Having to make a presentation will also give the cadets another opportunity to practice their presentation skills.

---

### Teaching Point 1

### Supervise Cadets Delivering a Presentation About a Leader

Time: 50 min

Method: Practical Activity

---



The cadets will research a leader of their choice (a military leader, political leader, teacher, etc) prior to the lesson. Cadets will bring to the class presentation materials and information about the leader they researched in order to deliver their presentation.

---

## ACTIVITY

---

### OBJECTIVE

The objective of this activity is to have cadets deliver a presentation about a leader.

### RESOURCES

- Presentation aids (eg, whiteboard/flip chart/OHP/multimedia projector), and
- Information about the leader.

### ACTIVITY LAYOUT

N/A.

### ACTIVITY INSTRUCTIONS

1. Have a cadet volunteer to deliver their presentation.
2. The cadet will set up their presentation materials (if required).
3. The cadet will deliver a presentation to include an introduction of the leader, interesting points in the leader's career, the core leadership qualities displayed by the leader, and a conclusion.
4. Cadets will be encouraged to ask questions at the end of each presentation.
5. Repeat steps 1. to 4. until everyone has delivered a presentation.

### SAFETY

N/A.

---

**CONFIRMATION OF TEACHING POINT 1**

---

The cadets' participation in the activity will serve as the confirmation of this TP.

---

**END OF LESSON CONFIRMATION**

---

The cadets' participation in the delivery of a presentation will serve as the confirmation of this lesson.

---

**CONCLUSION**

---

**HOMEWORK/READING/PRACTICE**

N/A.

**METHOD OF EVALUATION**

N/A.

**CLOSING STATEMENT**

Seeing and hearing the example set by other leaders may assist the cadet in becoming a more effective leader. Leaders come from all walks of life and learning about how different leaders display core leadership qualities may help cadets further develop their leadership skills. Being given as many opportunities as possible to speak in front of groups will help develop the cadet's presentation and instructional skills.

**INSTRUCTOR NOTES/REMARKS**

It is recommended that this lesson be scheduled after all other lessons in PO 309 (Chapter 9).

If the corps has more than five Silver Star cadets, divide the cadets into groups of five, if facilities are available.

---

**REFERENCES**

---

N/A.

THIS PAGE INTENTIONALLY LEFT BLANK



### LEADERSHIP TEAM MODEL

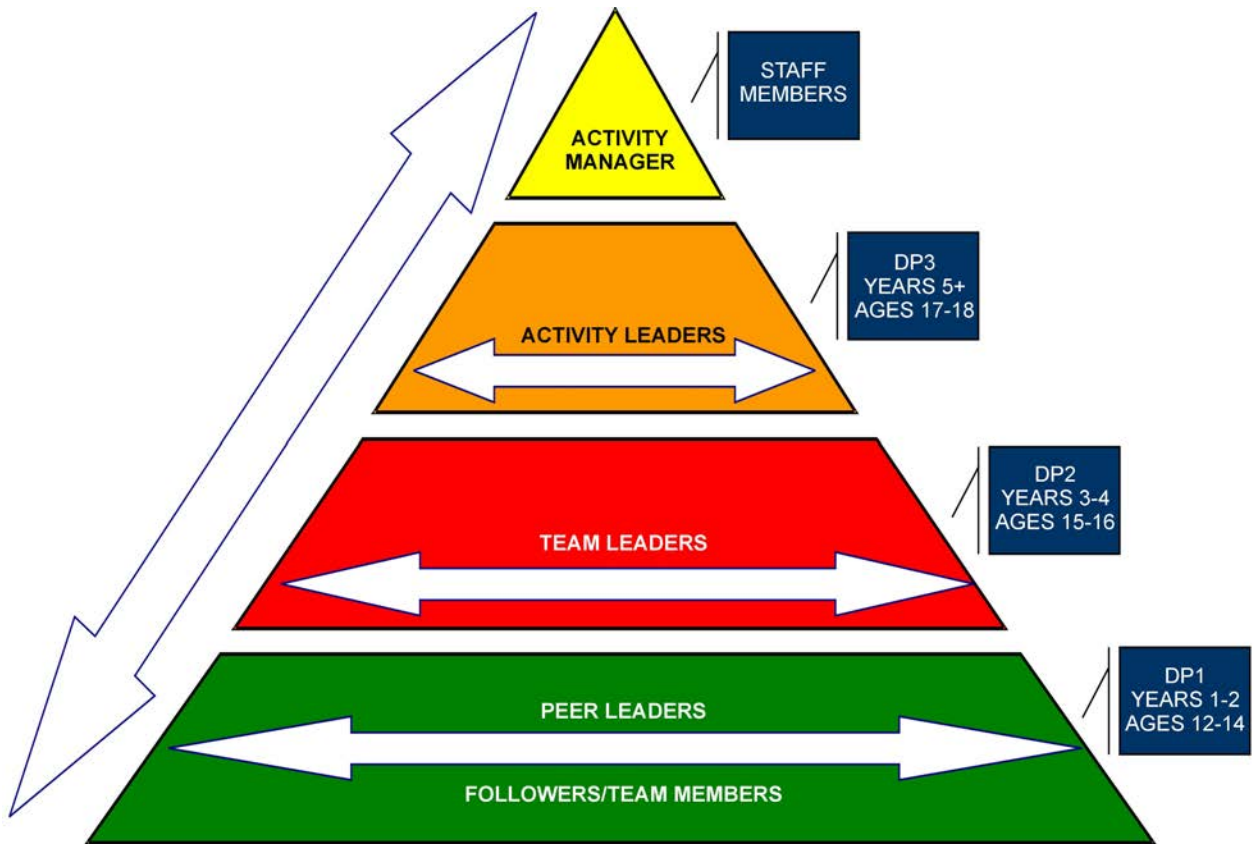

*Director Cadets 3, 2008, Ottawa, ON: Department of National Defence*

Figure 3A-1 Leadership Team Model

THIS PAGE INTENTIONALLY LEFT BLANK

**EXPECTATIONS OF A SILVER STAR CADET**

***Core Leadership Competencies***

Intrapersonal Management

Interpersonal Management

Teamwork

Effective Communication

Applied Leadership

Mentorship

<b>Components of Intrapersonal Management</b>	<ul style="list-style-type: none"> <li>• identifying and satisfying personal needs;</li> <li>• exercising self-control;</li> <li>• exercising self-management;</li> <li>• pursuing self-improvement; and</li> <li>• establishing a positive identity.</li> </ul>
<b>Components of Interpersonal Management</b>	<ul style="list-style-type: none"> <li>• interacting positively within the cadet community;</li> <li>• interacting positively with others; and</li> <li>• dealing with interpersonal conflict in a respectful way.</li> </ul>
<b>Components of Teamwork</b>	<ul style="list-style-type: none"> <li>• participating in the stages of team development;</li> <li>• displaying positive team dynamics; and</li> <li>• participating in team-building activities.</li> </ul>
<b>Components of Effective Communication</b>	<ul style="list-style-type: none"> <li>• receiving information;</li> <li>• interpreting information; and</li> <li>• responding to information.</li> </ul>
<b>Components of Applied Leadership</b>	<ul style="list-style-type: none"> <li>• setting an example for others to follow;</li> <li>• participating in leadership assignments;</li> <li>• conducting the leadership assignment while supervising the team;</li> <li>• leading team-building activities;</li> <li>• debriefing the team; and</li> <li>• presenting an after-assignment report to their leader.</li> </ul>
<b>Components of Mentorship</b>	<ul style="list-style-type: none"> <li>• fulfilling the role of a mentored cadet; and</li> <li>• fulfilling the role of a mentor.</li> </ul>

THIS PAGE INTENTIONALLY LEFT BLANK

**SELF-ASSESSMENT RUBRICS**

**SELF-ASSESSMENT FOR CORE LEADERSHIP QUALITIES OF A CADET**

Name: \_\_\_\_\_ Date: \_\_\_\_\_

Please rate your core leadership qualities by checking the correct box.

Core Leadership Quality	Never	Seldom	Often	Always
I am honest.				
I am dependable.				
I am loyal.				
I am collaborative.				
I am determined.				
I am courageous.				
I am analytical.				
I am positive.				
I am respectful.				
I am considerate.				
I am sympathetic.				

### SELF-ASSESSMENT FOR POSITIVE TEAM DYNAMICS

Name: \_\_\_\_\_ Date: \_\_\_\_\_

Please rate your positive team dynamics by checking the correct box.

<b>Positive Team Dynamics</b>	<b>Never</b>	<b>Seldom</b>	<b>Often</b>	<b>Always</b>
I follow the team leader.				
I include all participants.				
I encourage team members.				
I contribute to team morale and esprit de corps.				
I contribute to the accomplishment of team goals.				
I contribute to group decisions.				
I trust the team.				
I support team members.				
I appreciate team members.				
I celebrate team success.				

### COMMUNICATION PUZZLE

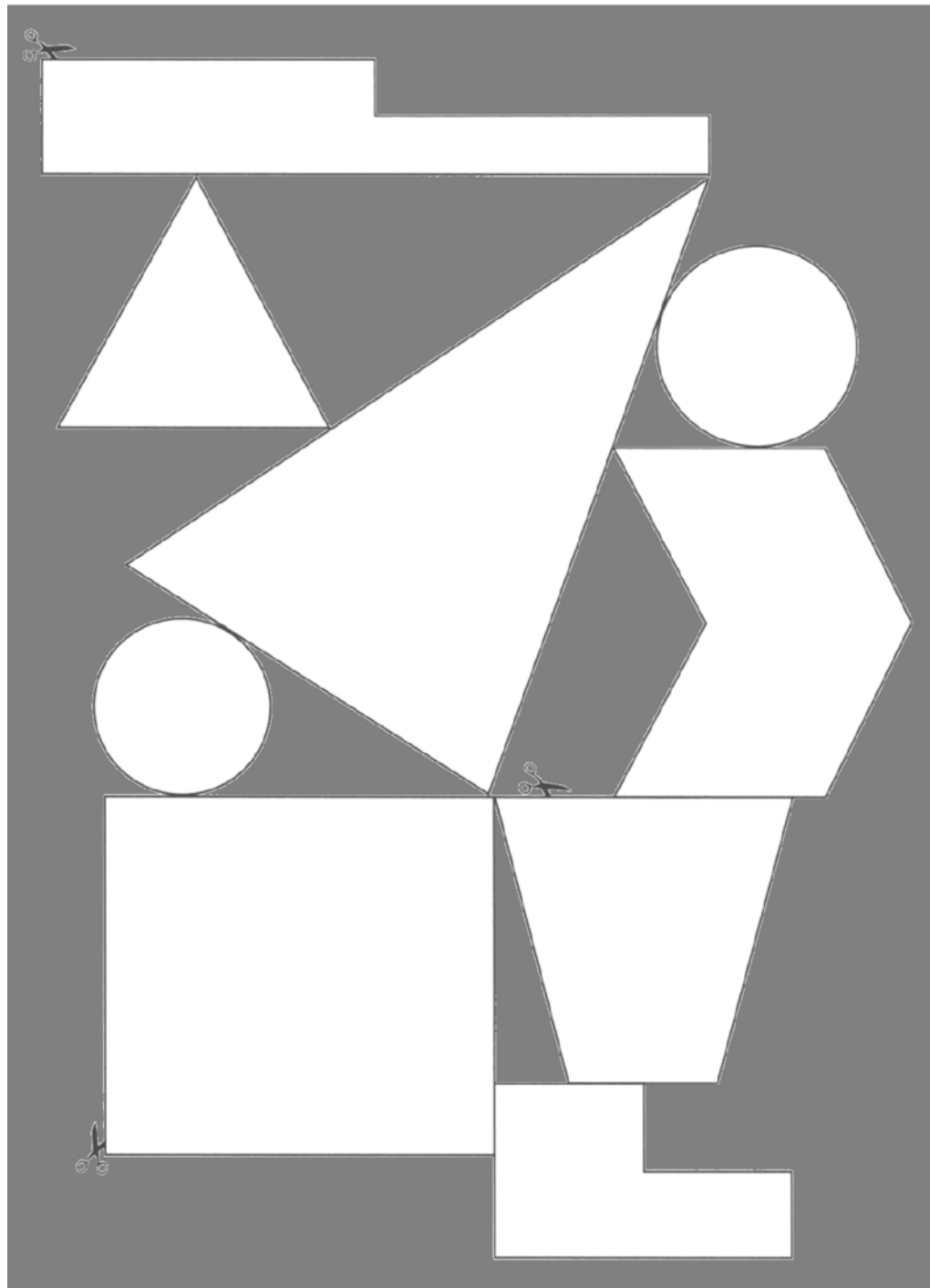

*M. G. MacGregor, Teambuilding With Teens, Free Spirit Publishing Inc. (p. 80)*

Figure 3D-1 Communication Puzzle

THIS PAGE INTENTIONALLY LEFT BLANK



## **PROBLEM-SOLVING SCENARIOS**

### **PROBLEM-SOLVING SCENARIO 1**

You are a member of your school volleyball team and a member of your cadet corps. This year your team is doing very well and is expected to go to the zone championship three weekends from now. You have just realized that your zone tournament may be the same weekend as your corps tour of a Canadian Forces unit.

What do you do?

**PROBLEM-SOLVING SCENARIO 2**

Your corps is conducting a tabloid sports meet tomorrow night. You have been assigned to organize the teams before the event begins.

What do you do?

**PROBLEM-SOLVING SCENARIO 3**

Your parents are going out of town for the weekend on business. You and your younger brother, who is 11 years old, are staying home. Your corps is conducting its annual community service event.

What do you do?

**PROBLEM-SOLVING SCENARIO 4**

You arrive at your cadet corps and you notice that your friend has extra money this week. You also know that she was working in the cadet canteen earlier that night.

What do you do?

## **POSSIBLE YEAR THREE COMMON LEADERSHIP ASSIGNMENTS**

### **RECREATIONAL MARKSMANSHIP ASSIGNMENTS**

- Set up a range for recreational marksmanship.
- Organize relays for recreational marksmanship.
- Control pellets and issue targets for recreational marksmanship.
- Conduct concurrent activities during recreational marksmanship.
- Tear down a range after recreational marksmanship.

### **SUMMER BIATHLON ASSIGNMENTS**

- Set up range for summer biathlon.
- Conduct a warm-up activity prior to participating in summer biathlon.
- Control pellets for summer biathlon.
- Conduct a cool-down activity after participating in summer biathlon.
- Tear down the range after summer biathlon.

### **RECREATIONAL SPORTS ASSIGNMENTS**

- Set up a recreational sports activity.
- Tear down a recreational sports activity.
- Organize a team for recreational sports.
- Conduct a warm-up prior to recreational sports.
- Conduct a concurrent activity during recreational sports.
- Conduct a cool-down after recreational sports.

### **WEEKLY PARADE CADET NIGHT ASSIGNMENTS**

- Set up chairs for a parade.
- Set up the dais area for a parade.
- Set up flags and parade markers for a parade.
- Tear down chairs after a parade.
- Tear down dais area after a parade.
- Tear down flags and parade markers after a parade.

### **WEEKLY CADET NIGHT ASSIGNMENTS**

- Set up classroom space.
- Rearrange classroom space.
- Tear down classroom space.
- Set up a canteen.
- Staff the canteen.

- Tear down a canteen.
- Set up a presentation area for a guest speaker.
- Tear down a presentation area for a guest speaker.
- Set up for an extracurricular activity.
- Conduct a concurrent activity.

#### **COMMUNITY SERVICE LEADERSHIP ASSIGNMENTS**

- Organize a team during a community service activity.
- Conduct concurrent activities during community service activity.
- Complete a final garbage sweep.

#### **OTHER LEADERSHIP ASSIGNMENT POSSIBILITIES**

- Embark and disembark personnel on vehicles during transportation.
- Conduct uniform inspection of year one cadets.
- Collect and dispose of garbage after weekly parade.
- Collect, sort and dispose of recycling after weekly parade.
- Turn off lights and close windows after weekly parade.

#### **ARMY CADET FIELD TRAINING LEADERSHIP ASSIGNMENTS**

##### **Prior to an FTX**

- Distribute personal equipment.
- Load team equipment and supplies for an FTX.

##### **Setting Up the Bivouac Site**

- Create the bivouac layout plan.
- Unload equipment and supplies for an FTX.
- Construct a food hang.
- Set up the POL, first aid and fire points.
- Set up the female sleeping area.
- Set up the male sleeping area.
- Mark the components of the bivouac site.

##### **Routine Tasks That Will Occur Throughout the FTX**

- Prepare a meal for a section.
- Clean up the site after a meal.
- Prepare the bivouac site for the night.
- Organize lights out for the female cadets.
- Organize lights out for the male cadets.

### **Tearing Down the Bivouac Site**

- Tear down the female sleeping area.
- Tear down the male sleeping area.
- Dismantle the POL, first aid and fire points.
- Dismantle the food hang and dispose of garbage.
- Load team equipment and supplies after an FTX.
- Erase signs of occupancy and complete a final garbage sweep.

### **After the FTX**

- Unload equipment and supplies after an FTX.
- Collect personal equipment.

THIS PAGE INTENTIONALLY LEFT BLANK



### SAMPLE LEADERSHIP ASSIGNMENT

<b>LEADERSHIP ASSIGNMENT</b> Rearrange Classroom Space
<b>ASSIGNMENT DESCRIPTION</b> Organize a team of cadets to rearrange a classroom as required. Move the chairs and desks/tables to match the diagram (if provided) or as directed.
<b>RESOURCES</b> <ul style="list-style-type: none"><li>• Chairs,</li><li>• Diagram of placement of chairs (if required),</li><li>• Desks/tables,</li><li>• Electronic equipment (if required),</li><li>• Whiteboards (if required), and</li><li>• A minimum of four cadets.</li></ul>
<b>TIME</b> A maximum of 10 minutes.
<b>SAFETY CONSIDERATIONS</b> N/A.

THIS PAGE INTENTIONALLY LEFT BLANK

## LEADERSHIP ASSIGNMENT FORMAT

1. Prepare for the leadership assignment by:
  - a. ensuring the goal is understood;
  - b. ensuring the required resources are available;
  - c. completing a time appreciation; and
  - d. making a plan.
  
2. Introduce the leadership assignment by:
  - a. stating the assignment to be completed;
  - b. stating the goal of the assignment;
  - c. identifying the resources required for the assignment;
  - d. communicating the overall plan;
  - e. assigning tasks to team members as applicable; and
  - f. ensuring the team members understand the assignment.
  
3. Conduct the leadership assignment by:
  - a. supervising peers;
  - b. maintaining team control;
  - c. ensuring the assignment is progressing according to the time allotted; and
  - d. modifying the plan as required.
  
4. Debrief the team following the leadership assignment by:
  - a. reviewing the goal;
  - b. providing feedback; and
  - c. re-motivating the team.
  
5. Complete an after-assignment report and a self-assessment.
  
6. Attend a debriefing with the directing staff.

THIS PAGE INTENTIONALLY LEFT BLANK

**AFTER-ASSIGNMENT REPORT AND ASSESSMENT RUBRIC**

**AFTER-ASSIGNMENT REPORT**

1. How did you feel after the assignment was completed?

---

---

---

---

2. How did you feel about the teamwork among the members? How is teamwork related to the outcome of a leadership assignment?

---

---

---

---

3. What aspects of the leadership assignment went well?

---

---

---

---

4. Is there anything you would do differently if you were to complete the same assignment again?

---

---

---

---

**303 PC ASSESSMENT RUBRIC**

Cadet's Name: \_\_\_\_\_

Platoon: \_\_\_\_\_

Date: \_\_\_\_\_

	<b>Incomplete</b>	<b>Completed With Difficulty</b>	<b>Completed Without Difficulty</b>	<b>Exceeded the Standard</b>
Communicate as a team leader.	Did not communicate with team members.	Communicated with team members occasionally. Team members needed clarification on many occasions.	Communicated with team members on many occasions. Team members needed few clarifications.	Communicated to the team throughout the leadership task. Team members did not need clarification.
Supervise cadets.	Did not supervise cadets.	Only supervised cadets at the beginning and/or end of the leadership assignment.	Supervised throughout the leadership assignment making some corrections when necessary.	Supervised throughout the leadership assignment making corrections as necessary.
Solve problems.	Did not solve the problem(s).		Solved the problem(s).	
Complete the leadership assignment.	Did not complete the leadership assignment.		Completed the leadership assignment.	
Perform self-assessment.	Did not complete the self-assessment.		Completed the self-assessment.	

*This form shall be reproduced locally.*

## LEADERSHIP ASSIGNMENTS

<b>LEADERSHIP ASSIGNMENT</b>
<p style="text-align: center;">Set Up a Range for Recreational Marksmanship</p>
<p><b>ASSIGNMENT DESCRIPTION</b></p> <p>Organize a team of cadets to set up a range for recreational marksmanship. Determine the equipment required according to the number of firing lanes. Set up the area as per the diagram provided.</p>
<p><b>RESOURCES</b></p> <ul style="list-style-type: none"><li>• Range area,</li><li>• Air rifle targets,</li><li>• Target frames,</li><li>• Flags (red and green),</li><li>• First aid kit,</li><li>• Stretcher,</li><li>• Shooting mats,</li><li>• Safety glasses/goggles,</li><li>• Cadet air rifles,</li><li>• Cadet air rifle slings,</li><li>• Diagram of placement for all resources, and</li><li>• A minimum of six cadets.</li></ul>
<p><b>TIME</b></p> <p>A maximum of 20 minutes.</p>
<p><b>SAFETY CONSIDERATIONS</b></p> <p>Ensure safety precautions are being obeyed at all times when handling cadet air rifles.</p>

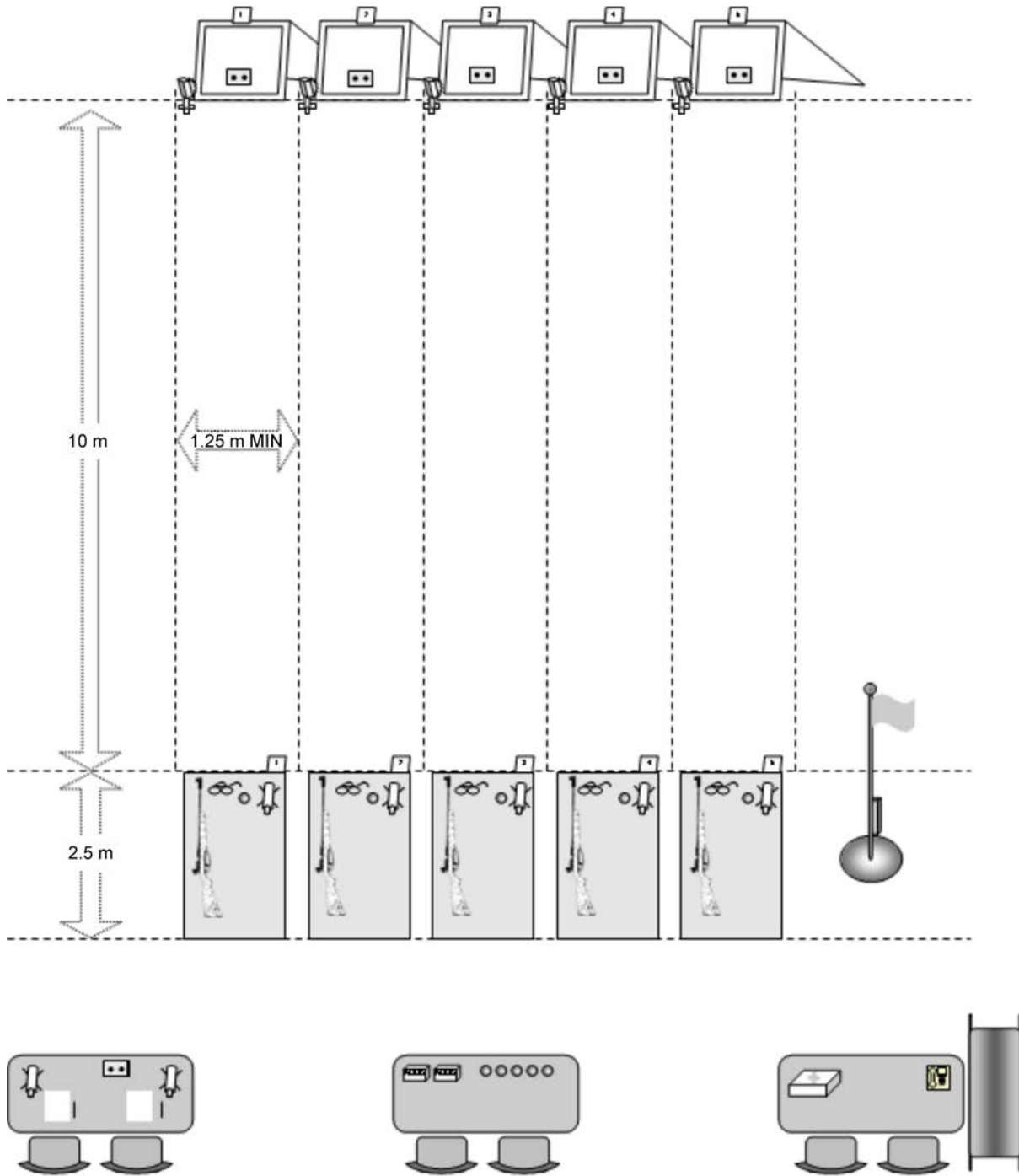

*Director Cadets 3, 2008, Ottawa, ON: Department of National Defence*

Figure 3J-1 Sample Range Layout



<p style="text-align: center;"><b>LEADERSHIP ASSIGNMENT</b></p> <p style="text-align: center;">Organize Relays for Recreational Marksmanship</p>
<p><b>ASSIGNMENT DESCRIPTION</b></p> <p>Organize the cadets into relays for recreational marksmanship according to the number of firing lanes.</p>
<p><b>RESOURCES</b></p> <p>All participating cadets.</p>
<p><b>TIME</b></p> <p>A maximum of 10 minutes.</p>
<p><b>SAFETY CONSIDERATIONS</b></p> <p>N/A.</p>

**LEADERSHIP ASSIGNMENT**

Control Pellets and Issue Targets for Recreational Marksmanship

**ASSIGNMENT DESCRIPTION**

Organize a team of cadets to control and distribute pellets and issue targets for recreational marksmanship. Allocate the pellets required, per relay, according to the number of firing lanes.

**RESOURCES**

- Air rifle pellets,
- Containers to hold pellets,
- Suitable targets, and
- A minimum of two cadets.

**TIME**

One relay, approximately 10 minutes.

**SAFETY CONSIDERATIONS**

Ensure all cadets wash their hands after handling pellets.

<p style="text-align: center;"><b>LEADERSHIP ASSIGNMENT</b></p> <p style="text-align: center;">Conduct a Concurrent Activity During Recreational Marksmanship</p>
<p><b>ASSIGNMENT DESCRIPTION</b></p> <p>Organize and conduct a concurrent activity during recreational marksmanship (eg, ground sweep, team-building activity, etc) for a small team of cadets. Ensure maximum participation of all cadets.</p>
<p><b>RESOURCES</b></p> <ul style="list-style-type: none"><li>• As directed by the directing staff based on the concurrent activity, and</li><li>• A small team of cadets.</li></ul>
<p><b>TIME</b></p> <p>A maximum of 20 minutes.</p>
<p><b>SAFETY CONSIDERATIONS</b></p> <p>N/A.</p>

**LEADERSHIP ASSIGNMENT**

Tear Down a Range After Recreational Marksmanship

**ASSIGNMENT DESCRIPTION**

Organize a team of cadets to tear down a range after recreational marksmanship. Return all equipment to the supply area. Count all equipment and report numbers to the directing staff after completing the assignment.

**RESOURCES**

- Resource checklist, and
- A minimum of six cadets.

**TIME**

A maximum of 20 minutes.

**SAFETY CONSIDERATIONS**

- Ensure safety precautions are being obeyed at all times when handling cadet air rifles.
- Ensure all cadets wash their hands after handling pellets.

<b>Resources</b>	<b>Quantity Returned</b>
Target Frame	
Red Flag	
Green Flag	
First Aid Kit	
Stretcher	
Shooting Mats	
Safety Glasses/Goggles	
Cadet Air Rifle	
Cadet Air Rifle Sling	
Pellets (Boxes)	

*Director Cadets 3, 2008, Ottawa, ON: Department of National Defence*

Figure 3J-2 Sample Resource Checklist

**LEADERSHIP ASSIGNMENT**

Set up a Range for Summer Biathlon

**ASSIGNMENT DESCRIPTION**

Organize a team of cadets to set up a range for summer biathlon as required. Determine the equipment required according to the number of firing lanes. Set up the area as per the diagram provided.

**RESOURCES**

- Range area,
- Biathlon air rifle targets (BART),
- Flags (red and green),
- First aid kit,
- Stretcher,
- Stopwatch,
- Shooting mats,
- Safety glasses/goggles,
- Cadet air rifles,
- Diagram of placement for all resources, and
- A minimum of six cadets.

**TIME**

A maximum of 20 minutes.

**SAFETY CONSIDERATIONS**

Ensure safety precautions are being obeyed at all times when handling cadet air rifles.

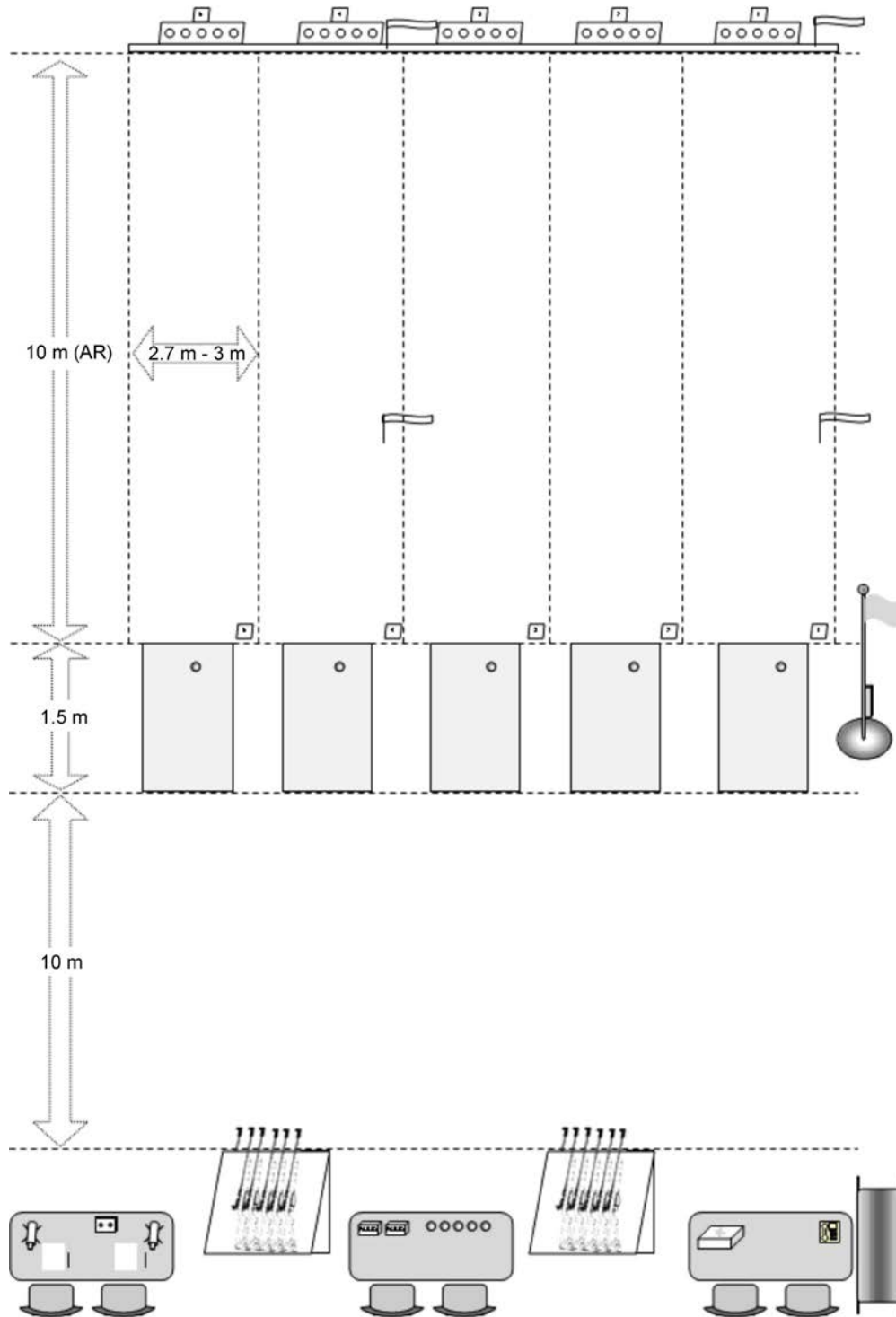

*Director Cadets 3, 2008, Ottawa, ON: Department of National Defence*

Figure 3J-3 Sample Biathlon Range Layout

**LEADERSHIP ASSIGNMENT**

Conduct a Warm-Up Activity Prior to Participating in Summer Biathlon

**ASSIGNMENT DESCRIPTION**

Organize and conduct a warm-up activity for a small team of cadets prior to participating in summer biathlon. Ensure maximum participation of all cadets.

**RESOURCES**

- Handout of sample stretches (located at Annex K), and
- A small team of cadets.

**TIME**

A maximum of 20 minutes.

**SAFETY CONSIDERATIONS**

N/A.



<b>LEADERSHIP ASSIGNMENT</b>
<p>Control Pellets for Summer Biathlon</p>
<p><b>ASSIGNMENT DESCRIPTION</b></p> <p>Organize a team of cadets to control and distribute pellets for summer biathlon. Allocate the pellets required, for each firing bout, according to the number of firing lanes.</p>
<p><b>RESOURCES</b></p> <ul style="list-style-type: none"><li>• Air rifle pellets,</li><li>• Containers to hold pellets, and</li><li>• A minimum of two cadets.</li></ul>
<p><b>TIME</b></p> <p>As per activity.</p>
<p><b>SAFETY CONSIDERATIONS</b></p> <p>Ensure all cadets wash their hands after handling pellets.</p>

**LEADERSHIP ASSIGNMENT**

Conduct a Cool-Down Activity After Participating in Summer Biathlon

**ASSIGNMENT DESCRIPTION**

Organize and conduct a cool-down activity for a team of cadets after participating in summer biathlon. Ensure maximum participation of all cadets in the team.

**RESOURCES**

- Handout of sample stretches (located at Annex K), and
- A team of cadets.

**TIME**

A maximum of 20 minutes.

**SAFETY CONSIDERATIONS**

N/A.

<b>LEADERSHIP ASSIGNMENT</b>
<p style="text-align: center;">Tear Down a Range After Summer Biathlon</p>
<p><b>ASSIGNMENT DESCRIPTION</b></p> <p>Organize a team of cadets to tear down a range after summer biathlon. Return all equipment to supply area. Count all equipment and report numbers to the directing staff after completing the assignment.</p>
<p><b>RESOURCES</b></p> <ul style="list-style-type: none"><li>• Resource checklist, and</li><li>• A minimum of six cadets.</li></ul>
<p><b>TIME</b></p> <p>A maximum of 20 minutes.</p>
<p><b>SAFETY CONSIDERATIONS</b></p> <ul style="list-style-type: none"><li>• Ensure safety precautions are being obeyed at all times when handling cadet air rifles.</li><li>• Ensure all cadets wash their hands after handling pellets.</li></ul>

<b>Resources</b>	<b>Quantity Returned</b>
Biathlon Air Rifle Target (BART)	
Red Flag	
Green Flag	
First Aid Kit	
Stretcher	
Stopwatch	
Shooting Mats	
Safety Glasses/Goggles	
Cadet Air Rifle	
Pellets (Boxes)	

*Director Cadets 3, 2008, Ottawa, ON: Department of National Defence*

Figure 3J-4 Sample Resource Checklist

<p style="text-align: center;"><b>LEADERSHIP ASSIGNMENT</b></p> <p style="text-align: center;">Set up a Recreational Sports Activity</p>
<p><b>ASSIGNMENT DESCRIPTION</b></p> <p>Organize a team of cadets to set up a recreational sports activity as required. Move the scoring tables, stopwatch and any other sports equipment as directed.</p>
<p><b>RESOURCES</b></p> <ul style="list-style-type: none"><li>• Scoring tables,</li><li>• Stopwatch,</li><li>• Sports equipment (as required), and</li><li>• A minimum of four cadets.</li></ul>
<p><b>TIME</b></p> <p>A maximum of 10 minutes.</p>
<p><b>SAFETY CONSIDERATIONS</b></p> <p>N/A.</p>

**LEADERSHIP ASSIGNMENT**

Tear Down a Recreational Sports Activity

**ASSIGNMENT DESCRIPTION**

Organize a team of cadets to set up a recreational sports activity as required. Remove the scoring tables, stopwatch and any other sports equipment as directed.

**RESOURCES**

- Scoring tables,
- Stopwatch,
- Sports equipment (as required), and
- A minimum of four cadets.

**TIME**

A maximum of 10 minutes.

**SAFETY CONSIDERATIONS**

N/A.

<b>LEADERSHIP ASSIGNMENT</b>
Organize a Team for Recreational Sports
<b>ASSIGNMENT DESCRIPTION</b> Organize the cadets into teams for recreational sports as directed (eg, teams, scorekeepers, timekeepers, etc).
<b>RESOURCES</b> <ul style="list-style-type: none"><li>• Stopwatches,</li><li>• Pens/pencils, and</li><li>• All participating cadets.</li></ul>
<b>TIME</b> A maximum of 10 minutes.
<b>SAFETY CONSIDERATIONS</b> N/A.

**LEADERSHIP ASSIGNMENT**

Conduct a Warm-Up Activity Prior to Participating in Recreational Sports

**ASSIGNMENT DESCRIPTION**

Conduct a warm-up activity for a team of cadets prior to participating in recreational sports. Ensure maximum participation of all cadets in the team.

**RESOURCES**

- Handout of sample stretches (located at Annex K), and
- A team of cadets.

**TIME**

A maximum of 20 minutes.

**SAFETY CONSIDERATIONS**

N/A.



<b>LEADERSHIP ASSIGNMENT</b>
Conduct a Concurrent Activity During Recreational Sports
<b>ASSIGNMENT DESCRIPTION</b> Conduct a concurrent activity during recreational sports (eg, team-building activity, cheering, etc) for a team of cadets. Ensure maximum participation of all cadets in the team.
<b>RESOURCES</b> <ul style="list-style-type: none"><li>• As directed by the directing staff based on the concurrent activity, and</li><li>• A team of cadets.</li></ul>
<b>TIME</b> A maximum of 20 minutes.
<b>SAFETY CONSIDERATIONS</b> N/A.

**LEADERSHIP ASSIGNMENT**

Conduct a Cool-Down Activity After Participating in Recreational Sports

**ASSIGNMENT DESCRIPTION**

Conduct a cool-down activity for a team of cadets after participating in recreational sports. Ensure maximum participation of all cadets in the team.

**RESOURCES**

- Handout of sample stretches (located at Annex K), and
- A team of cadets.

**TIME**

A maximum of 20 minutes.

**SAFETY CONSIDERATIONS**

N/A.

<p style="text-align: center;"><b>LEADERSHIP ASSIGNMENT</b></p> <p style="text-align: center;">Set up Chairs for a Parade</p>
<p><b>ASSIGNMENT DESCRIPTION</b></p> <p>Organize a team to set up chairs for guests of a parade. Count the chairs, which will already be on-site, then set them up as illustrated in the diagram or as directed.</p>
<p><b>RESOURCES</b></p> <ul style="list-style-type: none"><li>• Chairs,</li><li>• Diagram of placement of chairs (if required), and</li><li>• A minimum of four cadets.</li></ul>
<p><b>TIME</b></p> <p>A maximum of 10 minutes.</p>
<p><b>SAFETY CONSIDERATIONS</b></p> <p>N/A.</p>

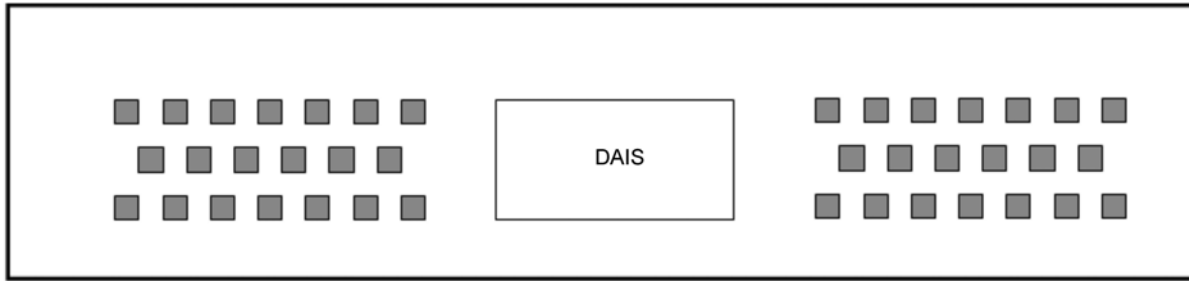

■ Chair

*Director Cadets 3, 2008, Ottawa, ON: Department of National Defence*

Figure 3J-5 Sample Placement of Chairs

<b>LEADERSHIP ASSIGNMENT</b> Set up the Dais Area for a Parade
<b>ASSIGNMENT DESCRIPTION</b> Organize a team to set up the dais area for dignitaries attending a parade. Using the resources provided, set up the dais area as illustrated in the diagram or as directed.
<b>RESOURCES</b> <ul style="list-style-type: none"><li>• Dais,</li><li>• Podium (if required),</li><li>• Chairs (if required),</li><li>• Diagram of dais area (if required), and</li><li>• A minimum of four cadets.</li></ul>
<b>TIME</b> A maximum of 10 minutes.
<b>SAFETY CONSIDERATIONS</b> N/A.

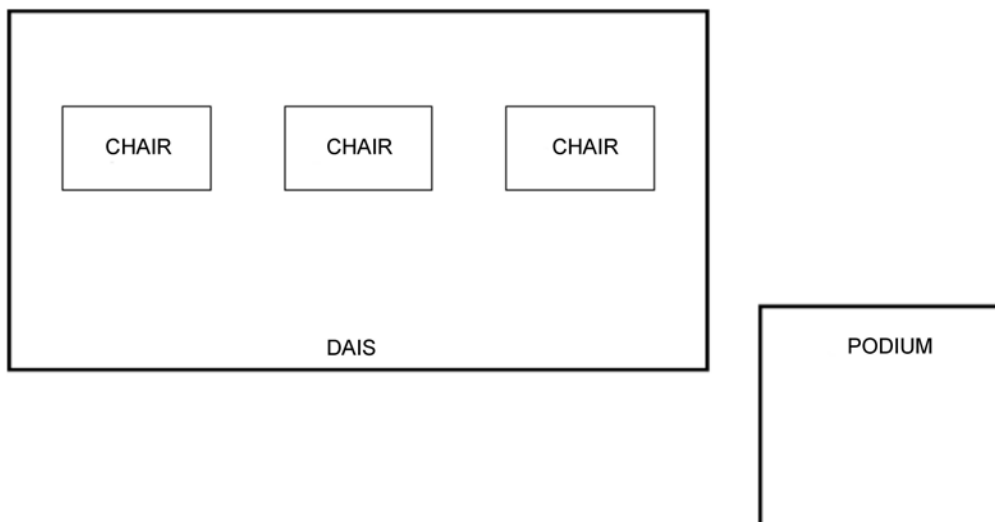

*Director Cadets 3, 2008, Ottawa, ON: Department of National Defence*

Figure 3J-6 Sample Dais Area

**LEADERSHIP ASSIGNMENT**

Set up Flags and Parade Markers for a Parade

**ASSIGNMENT DESCRIPTION**

Organize a team to set up flags and parade markers for a parade. Set them up as illustrated in the diagram or as directed.

**RESOURCES**

- Provincial and territorial flags,
- Parade markers,
- Diagram of placement of flags and parade markers (if required), and
- A minimum of four cadets.

**TIME**

A maximum of 15 minutes.

**SAFETY CONSIDERATIONS**

N/A.

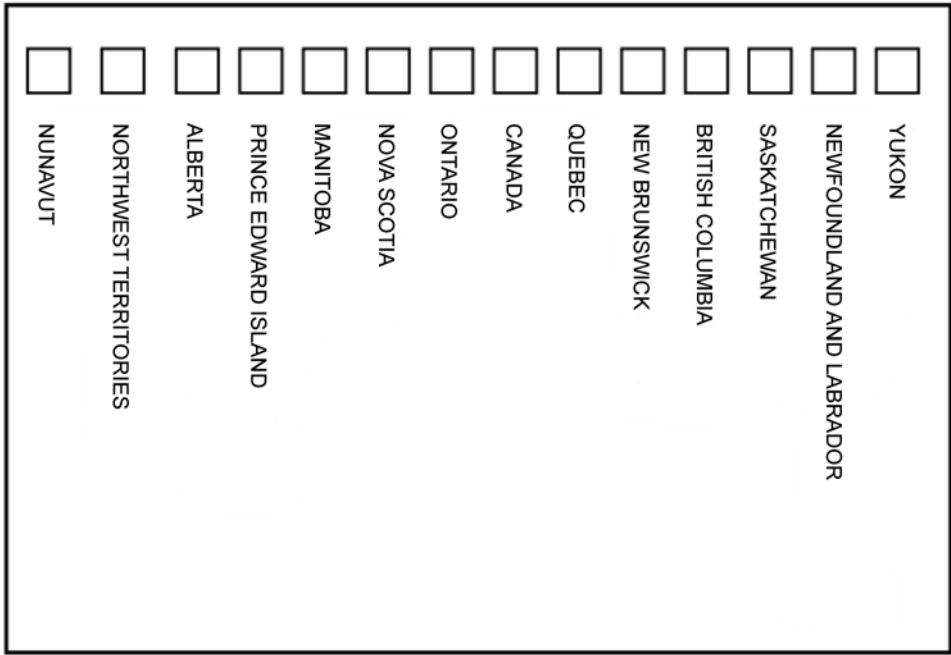

*Director Cadets 3, 2008, Ottawa, ON: Department of National Defence*

Figure 3J-7 Sample Placement of Flags

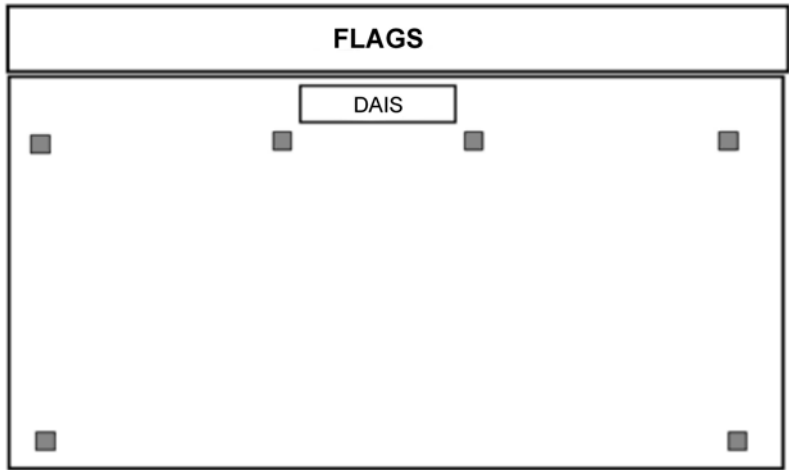

■ Parade Marker

*Director Cadets 3, 2008, Ottawa, ON: Department of National Defence*

Figure 3J-8 Sample Placement of Parade Markers



<b>LEADERSHIP ASSIGNMENT</b> Tear Down Chairs After a Parade
<b>ASSIGNMENT DESCRIPTION</b> Organize a team to tear down chairs after a parade. Move the chairs to the designated supply area. Count all equipment and report numbers to the directing staff after completing the assignment.
<b>RESOURCES</b> <ul style="list-style-type: none"><li>• Paper,</li><li>• Pen/pencil, and</li><li>• A minimum of four cadets.</li></ul>
<b>TIME</b> A maximum of 15 minutes.
<b>SAFETY CONSIDERATIONS</b> N/A.

**LEADERSHIP ASSIGNMENT**

Tear Down the Dais Area After a Parade

**ASSIGNMENT DESCRIPTION**

Organize a team to tear down the dais area after a parade. Return all equipment to the designated supply area. Count all equipment and report numbers to the directing staff after completing the assignment.

**RESOURCES**

- Paper,
- Pen/pencil, and
- A minimum of four cadets.

**TIME**

A maximum of 15 minutes.

**SAFETY CONSIDERATIONS**

N/A.

**LEADERSHIP ASSIGNMENT**

Tear Down Flags and Parade Markers After a Parade

**ASSIGNMENT DESCRIPTION**

Organize a team to tear down flags and parade markers after a parade. Return all equipment to the designated supply area. Count all equipment and report numbers to the directing staff after completing the assignment.

**RESOURCES**

- Paper,
- Pen/pencil, and
- A minimum of four cadets.

**TIME**

A maximum of 15 minutes.

**SAFETY CONSIDERATIONS**

N/A.

**LEADERSHIP ASSIGNMENT**

Set Up Classroom Space

**ASSIGNMENT DESCRIPTION**

Organize a team of cadets to set up a classroom as required. Move the chairs, desks/tables and any other equipment as directed.

**RESOURCES**

- Chairs,
- Desks/tables,
- Electronic equipment (if required),
- Whiteboards (if required), and
- A minimum of four cadets.

**TIME**

A maximum of 10 minutes.

**SAFETY CONSIDERATIONS**

N/A.

<b>LEADERSHIP ASSIGNMENT</b> Rearrange Classroom Space
<b>ASSIGNMENT DESCRIPTION</b> Organize a team of cadets to rearrange a classroom as required. Move the chairs and desks/tables to match the diagram (if provided) or as directed.
<b>RESOURCES</b> <ul style="list-style-type: none"><li>• Chairs,</li><li>• Diagram of placement of chairs (if required),</li><li>• Desks/tables,</li><li>• Electronic equipment (if required),</li><li>• Whiteboards (if required), and</li><li>• A minimum of four cadets.</li></ul>
<b>TIME</b> A maximum of 10 minutes.
<b>SAFETY CONSIDERATIONS</b> N/A.

**LEADERSHIP ASSIGNMENT**

Tear Down Classroom Space

**ASSIGNMENT DESCRIPTION**

Organize a team of cadets to tear down a classroom as required. Remove the chairs and desks/tables to match the diagram (if provided) or as directed.

**RESOURCES**

- Chairs,
- Diagram of placement of chairs (if required),
- Desks/tables,
- Electronic equipment (if required),
- Whiteboards (if required), and
- A minimum of four cadets.

**TIME**

A maximum of 10 minutes.

**SAFETY CONSIDERATIONS**

N/A.

**LEADERSHIP ASSIGNMENT**

Set up a Canteen

**ASSIGNMENT DESCRIPTION**

Organize a team of cadets to set up a canteen. Move the tables/counters, chairs, stock, cashbox and any other equipment as directed.

**RESOURCES**

- Chairs,
- Tables/counter,
- Stock,
- Cashbox, and
- A minimum of four cadets.

**TIME**

A maximum of 10 minutes.

**SAFETY CONSIDERATIONS**

N/A.

**LEADERSHIP ASSIGNMENT**

Staff a Canteen

**ASSIGNMENT DESCRIPTION**

Organize a team of cadets to staff a canteen. Ensure team know the price of each item to be sold.

**RESOURCES**

- Chairs,
- Tables/counter,
- Stock,
- Cashbox, and
- A minimum of four cadets.

**TIME**

A maximum of 20 minutes.

**SAFETY CONSIDERATIONS**

N/A.



<p style="text-align: center;"><b>LEADERSHIP ASSIGNMENT</b></p> <p style="text-align: center;">Tear Down a Canteen</p>
<p><b>ASSIGNMENT DESCRIPTION</b></p> <p>Organize a team of cadets to tear down a canteen. Remove the tables/counters, chairs, stock, cashbox and any other equipment as directed. Ensure cashbox is returned to an area that is secured.</p>
<p><b>RESOURCES</b></p> <ul style="list-style-type: none"><li>• Chairs,</li><li>• Tables/counter,</li><li>• Stock,</li><li>• Cashbox, and</li><li>• A minimum of four cadets.</li></ul>
<p><b>TIME</b></p> <p>A maximum of 10 minutes.</p>
<p><b>SAFETY CONSIDERATIONS</b></p> <p>N/A.</p>

**LEADERSHIP ASSIGNMENT**

Set up a Presentation Area for a Guest Speaker

**ASSIGNMENT DESCRIPTION**

Organize a team to set up a presentation area for a guest speaker. Set up the podium, chairs and electronic equipment (if required) as directed.

**RESOURCES**

- Podium,
- Chairs,
- Electronic equipment (if required), and
- A minimum of two cadets.

**TIME**

A maximum of 15 minutes.

**SAFETY CONSIDERATIONS**

N/A.

**LEADERSHIP ASSIGNMENT**

Tear Down a Presentation Area After a Guest Speaker

**ASSIGNMENT DESCRIPTION**

Organize a team to tear down a presentation area after a guest speaker. Return all equipment to supply area. Count all equipment and report numbers to the directing staff after completing the assignment.

**RESOURCES**

- Paper,
- Pen/pencil, and
- A minimum of two cadets.

**TIME**

A maximum of 10 minutes.

**SAFETY CONSIDERATIONS**

N/A.

**LEADERSHIP ASSIGNMENT**

Set Up for an Extracurricular Activity

**ASSIGNMENT DESCRIPTION**

Organize a team of cadets to set up for an extracurricular activity (eg, recreational sports, tour of a facility, field trip, summer biathlon, etc).

**RESOURCES**

As provided by directing staff.

**TIME**

A maximum of 20 minutes.

**SAFETY CONSIDERATIONS**

N/A.

<p style="text-align: center;"><b>LEADERSHIP ASSIGNMENT</b></p> <p style="text-align: center;">Conduct a Concurrent Activity</p>
<p><b>ASSIGNMENT DESCRIPTION</b></p> <p>Conduct a concurrent activity (eg, ground sweep, team-building activity, singing, etc) for a team of cadets who are awaiting further direction. Ensure maximum participation of all cadets in the team.</p>
<p><b>RESOURCES</b></p> <ul style="list-style-type: none"><li>• As directed by the directing staff based on the concurrent activity, and</li><li>• A team of cadets.</li></ul>
<p><b>TIME</b></p> <p>A maximum of 20 minutes.</p>
<p><b>SAFETY CONSIDERATIONS</b></p> <p>Cadets should be kept out of high-traffic areas.</p>

**LEADERSHIP ASSIGNMENT**

Organize a Team During a Community Service Activity

**ASSIGNMENT DESCRIPTION**

Organize a team of cadets during a community service activity. Move people and equipment as directed.

**RESOURCES**

A team of cadets.

**TIME**

A maximum of 20 minutes.

**SAFETY CONSIDERATIONS**

Cadets should be kept out of high-traffic areas.

**LEADERSHIP ASSIGNMENT**

Conduct a Concurrent Activity During a Community Service Activity

**ASSIGNMENT DESCRIPTION**

Conduct a concurrent activity during a community service activity (eg, ground sweep, team-building activity, singing, etc) for a team of cadets who are awaiting further direction. Ensure maximum participation of all cadets in the team.

**RESOURCES**

- As directed by the directing staff based on the concurrent activity, and
- A team of cadets.

**TIME**

A maximum of 20 minutes.

**SAFETY CONSIDERATIONS**

Cadets should be kept out of high-traffic areas.

**LEADERSHIP ASSIGNMENT**

Complete a Final Garbage Sweep After a Community Service Activity

**ASSIGNMENT DESCRIPTION**

Organize a team of cadets to complete a final garbage sweep after a community service activity and ensure all areas used are free of garbage.

**RESOURCES**

- Garbage bags, and
- A minimum of 10 cadets.

**TIME**

A maximum of 20 minutes.

**SAFETY CONSIDERATIONS**

N/A.



**LEADERSHIP ASSIGNMENT**

Embark and Disembark Personnel on Vehicles During Transportation

**ASSIGNMENT DESCRIPTION**

Organize a team of cadets to ensure all personnel embark and disembark vehicles in a safe manner. Count all personnel when embarking and disembarking the vehicle. Assist in supervision while personnel are being transported.

**RESOURCES**

- Vehicle, and
- A minimum of seven cadets.

**TIME**

Travel time.

**SAFETY CONSIDERATIONS**

Cadets must sit facing the front of the vehicle and must use seat belts.

**LEADERSHIP ASSIGNMENT**

Conduct Uniform Inspections of Year One Cadets

**ASSIGNMENT DESCRIPTION**

Organize a team of cadets to conduct uniform inspections of year one cadets.

**RESOURCES**

- Uniform inspection rubrics,
- Year one cadets, and
- A team of cadets.

**TIME**

A maximum of 15 minutes.

**SAFETY CONSIDERATIONS**

N/A

**UNIFORM INSPECTION RUBRICS**

	<b>Incomplete</b>	<b>Completed With Difficulty</b>	<b>Completed Without Difficulty</b>
<b>Headdress</b>	The cadet was not wearing a uniform	The cadet was wearing headdress, but it was either not correctly positioned or fitted, or had an incorrectly attached cap badge.	The cadet was wearing a properly fitting headdress with a properly attached cap badge.
<b>Uniform</b>	The cadet was not wearing a uniform	The cadet was wearing a uniform, but it was either not correctly worn or fitting, or had signs of being dirty or not having been properly pressed.	The cadet was wearing a properly fitting and properly pressed uniform.
<b>Badges</b>	The cadet was not wearing a uniform	The cadet had badges worn on the uniform, but some were either not correctly positioned or had missing badges.	The cadet's rank and all other badges were worn and correctly positioned.
<b>Footwear</b>	The cadet was not wearing a uniform	The cadet had boots, but they were either poorly maintained or poorly shone.	The cadet had well maintained boots with the entire boot shone equally.
<b>Personal Appearance</b>	The cadet was either not on parade or was not hygienic.	The cadet was on parade, but their personal appearance was somewhat below the standard IAW dress instructions (eg, hair, shaving, makeup, jewellery, etc.).	The cadet was on parade, and their personal appearance met the standard IAW dress instructions (eg, hair, shaving, makeup, jewellery, etc.).

**UNIFORM INSPECTION CHECKLIST**

Name	Headress	Uniform	Badges	Footwear	Personal Appearance	Comments
1.						
2.						
3.						
4.						
5.						
6.						
7.						
8.						
9.						
10.						
11.						
12.						
13.						
14.						
15.						
16.						
17.						
18.						
19.						
20.						
21.						
22.						
23.						
24.						
I – Incomplete			D – Completed With Difficulty		W – Completed Without Difficulty	

<b>LEADERSHIP ASSIGNMENT</b>	
Collect and Dispose of Garbage After Weekly Parade	
<b>ASSIGNMENT DESCRIPTION</b>	Organize a team of cadets to collect and dispose of garbage and ensure all areas used are free of garbage.
<b>RESOURCES</b>	<ul style="list-style-type: none"><li>• Garbage bags, and</li><li>• A minimum of five cadets.</li></ul>
<b>TIME</b>	A maximum of 10 minutes.
<b>SAFETY CONSIDERATIONS</b>	N/A.

**LEADERSHIP ASSIGNMENT**

Collect, Sort and Dispose of Recycling After Weekly Parade

**ASSIGNMENT DESCRIPTION**

Organize a team of cadets to collect, sort and dispose of material to be recycled. Ensure all areas used are free of material to be recycled.

**RESOURCES**

- Garbage bags,
- Recycling containers or bags (as required), and
- A minimum of five cadets.

**TIME**

A maximum of 10 minutes.

**SAFETY CONSIDERATIONS**

N/A.

<p style="text-align: center;"><b>LEADERSHIP ASSIGNMENT</b></p> <p style="text-align: center;">Turn Off Lights and Close Windows After Weekly Parade</p>
<p><b>ASSIGNMENT DESCRIPTION</b></p> <p>Organize a team of cadets to turn off lights and close windows after weekly parade.</p>
<p><b>RESOURCES</b></p> <p>A minimum of five cadets.</p>
<p><b>TIME</b></p> <p>A maximum of five minutes.</p>
<p><b>SAFETY CONSIDERATIONS</b></p> <p>N/A.</p>

THIS PAGE INTENTIONALLY LEFT BLANK





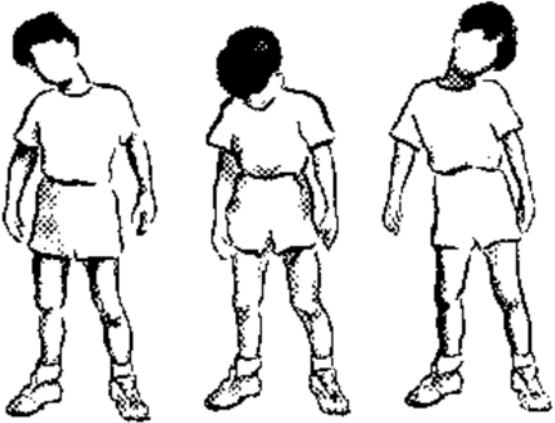

### SAMPLE STRETCHES

a. Neck:

 <p><i>Moving on the Spot: A Collection of 5 Minute Stretch and Movement Sessions, by B. Hanson, (1999), Toronto, ON: Toronto Public Health. Retrieved October 26, 2006, from <a href="http://www.lin.ca/resource/html/dn3.htm#1">http://www.lin.ca/resource/html/dn3.htm#1</a></i></p> <p>Figure 3K-1 Neck Stretch</p>	<p>Slowly roll your head across your chest from shoulder to shoulder. Do not roll your head backwards.</p>
--	--

b. Shoulders:

 <p><i>Moving on the Spot: A Collection of 5 Minute Stretch and Movement Sessions, by B. Hanson, (1999), Toronto, ON: Toronto Public Health. Retrieved October 26, 2006, from <a href="http://www.lin.ca/resource/html/dn3.htm#1">http://www.lin.ca/resource/html/dn3.htm#1</a></i></p> <p><b>Figure 3K-2 Shoulder Push</b></p>	<p>Stand and extend your arms behind you, interlocking your fingers. Push up and back with your shoulders.</p> <p>Hold this position for a minimum of 10 seconds.</p>
 <p><i>Moving on the Spot: A Collection of 5 Minute Stretch and Movement Sessions, by B. Hanson, (1999), Toronto, ON: Toronto Public Health. Retrieved October 26, 2006, from <a href="http://www.lin.ca/resource/html/dn3.htm#1">http://www.lin.ca/resource/html/dn3.htm#1</a></i></p> <p><b>Figure 3K-3 Shoulder Shrug</b></p>	<p>Stand and raise your shoulders as high as possible and then lower your shoulders, stretching your neck up.</p> <p>Pull your shoulders back as far as possible and then round your shoulders forward by pushing your shoulders forward as far as possible.</p> <p>Hold each position for a minimum of 10 seconds.</p>
 <p><i>Warm Ups, by Martha Jefferson Hospital, Copyright 2001 by Martha Jefferson Hospital. Retrieved October 26, 2006, from <a href="http://www.marthajefferson.org/warmup.php">http://www.marthajefferson.org/warmup.php</a></i></p> <p><b>Figure 3K-4 Arm Circles</b></p>	<p>Hold your arms straight out, palms up. Make small circles with your arms, gradually increasing the size.</p> <p>Reverse the direction of your circles.</p>
 <p><i>Smart Start: A Flexible Way to Get Fit. Retrieved October 26, 2006, from <a href="http://www.in-motion.ca/walkingworkout/plan/flexibility">http://www.in-motion.ca/walkingworkout/plan/flexibility</a></i></p> <p><b>Figure 3K-5 Shoulder Stretch</b></p>	<p>Either standing or sitting, take your right arm in your left hand and bring it across your chest, supporting the joint by holding it behind the elbow. Pull lightly on the elbow towards your chest. You should feel the stretch in your right shoulder.</p> <p>Hold this position for a minimum of 10 seconds and repeat on the opposite side.</p>

c. Arms:



*Exercises. Copyright 1998 by Impacto Protective Products Inc. Retrieved October 26, 2006, from <http://www.2protect.com/home.htm>*

Figure 3K-6 Wrist Rotations

Rotate your hands in circular motions at the wrist.  
Change direction and repeat on both sides.



*Smart Start: A Flexible Way to Get Fit. Retrieved October 26, 2006, from <http://www.in-motion.ca/walkingworkout/plan/flexibility>*

Figure 3K-7 Triceps Stretch

Stand and bring your right arm over your head, bent at the elbow. Use your left hand to gently pull your arm down.  
Hold this position for a minimum of 10 seconds and repeat on the opposite side.



*Exercise Programme for Squash, Tennis, Softball, Handball. Retrieved October 26, 2006, from <http://www.physionline.co.za/conditions/article.asp?id=49>*

Figure 3K-8 Forearm Stretch

In a kneeling position, place your hands on the floor in front of you turned so that your fingers are pointing toward your knees, and your thumbs are pointing out. Keeping your hands flat on the floor, lean back.  
Hold this position for a minimum of 10 seconds.

d. Chest and Abdominals:



*Smart Start: A Flexible Way to Get Fit. Retrieved October 26, 2006, from <http://www.in-motion.ca/walkingworkout/plan/flexibility>*

Figure 3K-9 Chest Stretch

Stand facing a wall. With your right arm bent and your elbow at shoulder height, place your palm against the wall. Turn your body away from your right arm. You should feel the stretch on the front side of your armpit and across the front of your chest.

Hold this position for a minimum of 10 seconds and repeat on the opposite side.



*Moving on the Spot: A Collection of 5 Minute Stretch and Movement Sessions, by B. Hanson, (1999), Toronto, ON: Toronto Public Health. Retrieved October 26, 2006, from <http://www.lin.ca/resource/html/dn3.htm#1>*

Figure 3K-10 Side Stretch

Stand with your left arm up over your head. Bend at your waist towards the right side of your body.

Hold this position for a minimum of 10 seconds and repeat on the opposite side.

e. Back:



*Smart Start: A Flexible Way to Get Fit. Retrieved October 26, 2006, from <http://www.in-motion.ca/walkingworkout/plan/flexibility>*

Figure 3K-11 Lower Back Stretch

Lie on your back and bring your knees toward your chest. Grasp the back of your knees.  
Hold this position for a minimum of 10 seconds.

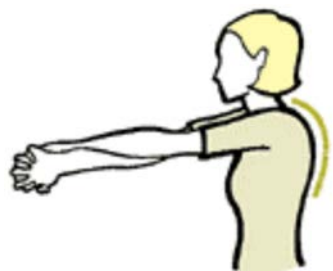

*Smart Start: A Flexible Way to Get Fit. Retrieved October 26, 2006, from <http://www.in-motion.ca/walkingworkout/plan/flexibility>*

Figure 3K-12 Upper Back Stretch

Extend your arms straight in front of you at shoulder height crossing one arm over the other. With the palms facing each other, intertwine your fingers and press out through your arms. Let your chin fall to your chest as you exhale. You should feel the stretch in the upper back.

Hold this position for a minimum of 10 seconds and repeat on the opposite side.

f. Legs:



*Smart Start: A Flexible Way to Get Fit. Retrieved October 26, 2006, from <http://www.in-motion.ca/walkingworkout/plan/flexibility>*

Figure 3K-13 Hamstring Stretch

Lie flat on the floor with your knees bent and your back flat on the floor. Slowly raise and straighten one leg, grasping it behind your thigh with both hands.

Hold this position for a minimum of 10 seconds.



*Smart Start: A Flexible Way to Get Fit. Retrieved October 26, 2006, from <http://www.in-motion.ca/walkingworkout/plan/flexibility>*

Figure 3K-14 Inner Thigh Stretch

Sit on the floor with your knees bent and the soles of your feet together. Grab your toes and pull yourself forward while keeping your back and neck straight.

Hold this position for a minimum of 10 seconds.

Grab your ankles and push your knees down toward the floor with your elbows.

Hold this position for a minimum of 10 seconds.



*Smart Start: A Flexible Way to Get Fit. Retrieved October 26, 2006, from <http://www.in-motion.ca/walkingworkout/plan/flexibility>*

Figure 3K-15 Hip Flexor

Kneel on your right knee. Position your left foot in front of you, bending your knee and placing your left hand on that leg for stability. Keep your back straight and abdominal muscles tight. Lean forward, shifting more body weight onto your front leg. You should feel the stretch in the front of your hip and the thigh of the leg you are kneeling on. Cushion your kneecap with a folded towel if necessary.

Hold this position for a minimum of 10 seconds and repeat on the opposite side.



*Running Exercises. Retrieved October 26, 2006, <http://www.physionline.co.za/conditions/article.asp?id=46>*

Figure 3K-16 Ankle Rotations

From a sitting position, rotate your foot in a clockwise, and then a counter-clockwise, direction.

Switch and repeat on the opposite side.



*Smart Start: A Flexible Way to Get Fit. Retrieved October 26, 2006, from <http://www.in-motion.ca/walkingworkout/plan/flexibility>*

Figure 3K-17 Calf Stretch

Stand three steps away from and facing a wall. Step in towards the wall with your right leg, bending your right knee and keeping your left leg straight. Extending your arms with your palms forward, reach out to the wall and let your body fall toward the wall. Keep your toes forward and your heels down. Lean your body into the wall with your left leg straight behind your body. You should feel the stretch in your left calf.

Hold this position for a minimum of 10 seconds and repeat on the opposite side.



*Smart Start: A Flexible Way to Get Fit. Retrieved October 26, 2006, from <http://www.in-motion.ca/walkingworkout/plan/flexibility>*

Figure 3K-18 Quadriceps Stretch

Stand with your hand against a wall for balance. Lift your left foot off the ground, bending your knee as if you are trying to kick your bottom with your heel. Do not lean forward at the hips. Grab and hold your ankle with your left hand. You should feel the stretch in your left thigh.

Hold this position for a minimum of 10 seconds and repeat on the opposite side.

THIS PAGE INTENTIONALLY LEFT BLANK



## LEADERSHIP ASSIGNMENTS

<p style="text-align: center;"><b>LEADERSHIP ASSIGNMENT</b></p> <p style="text-align: center;">Distribute Personal Equipment</p>
<p><b>ASSIGNMENT DESCRIPTION</b></p> <p>Organize a team to distribute personal equipment required for a bivouac exercise to the members of their squad.</p>
<p><b>RESOURCES</b></p> <ul style="list-style-type: none"><li>• Field pack (one per cadet),</li><li>• Sleeping bag (one per cadet),</li><li>• Air mattress (one per cadet), and</li><li>• A minimum of three cadets.</li></ul>
<p><b>TIME</b></p> <p>A maximum of 15 minutes.</p>
<p><b>SAFETY CONSIDERATIONS</b></p> <p>N/A.</p>

**LEADERSHIP ASSIGNMENT**

Label Personal Equipment

**ASSIGNMENT DESCRIPTION**

Organize the cadets to label their personal equipment that was distributed for the survival exercise.

**RESOURCES**

- Field pack (one per cadet),
- Sleeping bag (one per cadet),
- Air mattress (one per cadet),
- Masking tape,
- Markers, and
- A minimum of eight cadets.

**TIME**

A maximum of 15 minutes.

**SAFETY CONSIDERATIONS**

N/A.

**LEADERSHIP ASSIGNMENT**

Load Team Equipment and Supplies for a Survival Exercise.

**ASSIGNMENT DESCRIPTION**

Organize a team to load equipment and supplies on the supply vehicle for a survival exercise.

## RESOURCES

- Resources as detailed by the directing staff, such as:
  - two-person tents,
  - mallets,
  - Coleman two-burner stoves,
  - Coleman lanterns,
  - matches,
  - funnels,
  - lantern mantels,
  - stove and lantern fuel,
  - pot sets,
  - wash basins,
  - first aid kits,
  - stretcher,
  - fire extinguishers,
  - environmental spill kit,
  - axes,
  - shovels,
  - water jerry cans,
  - garbage bags,
  - Glow Sticks,
  - mine tape,
  - flashlights,
  - flashlight batteries,
  - radios,
  - radio batteries,
  - rope,
  - meals for the Survival Exercise,
  - paper,
  - markers,
  - masking tape, and
  - pens/pencils.
- Supply vehicle,
- Resource checklist,
- Pen/pencil, and
- A minimum of four cadets.

**TIME**

A maximum of 30 minutes.

**SAFETY CONSIDERATIONS**

- Cadets should be kept out of high-traffic areas.
- Field tools must be safely handled.

Equipment and Supplies	Quantity Loaded
Two-Person Tents	
Mallets	
Coleman Two-Burner Stoves	
Coleman Lanterns	
Matches	
Funnel	
Lantern Mantels	
Stove and Lantern Fuel	
Pot Sets	
Wash Basins	
First Aid Kits	
Stretcher	
Fire Extinguishers	
Environmental Spill Kit	
Axes	
Shovels	
Water Jerry Cans	
Garbage Bags	
Glow Sticks	
Flashlights	
Flashlight Batteries	
Radios	
Radio Batteries	
Rope	
Meals for the Survival Exercise	
Paper	
Markers	
Masking Tape	
Pens/Pencils	

*Director Cadets 3, 2008, Ottawa, ON: Department of National Defence*

Figure 3L-1 Sample Resource Checklist

<p style="text-align: center;"><b>LEADERSHIP ASSIGNMENT</b></p> <p style="text-align: center;">Create the Bivouac Layout Plan</p>
<p><b>ASSIGNMENT DESCRIPTION</b></p> <p>Create and sketch the bivouac layout plan. Upon completion, communicate the plan to the team members. The plan will be carried out by other peer leaders as leadership assignments.</p>
<p><b>RESOURCES</b></p> <ul style="list-style-type: none"><li>• Handout of sample bivouac site layout,</li><li>• Paper, and</li><li>• Pen/pencil.</li></ul>
<p><b>TIME</b></p> <p>A maximum of 15 minutes.</p>
<p><b>SAFETY CONSIDERATIONS</b></p> <p>N/A.</p>

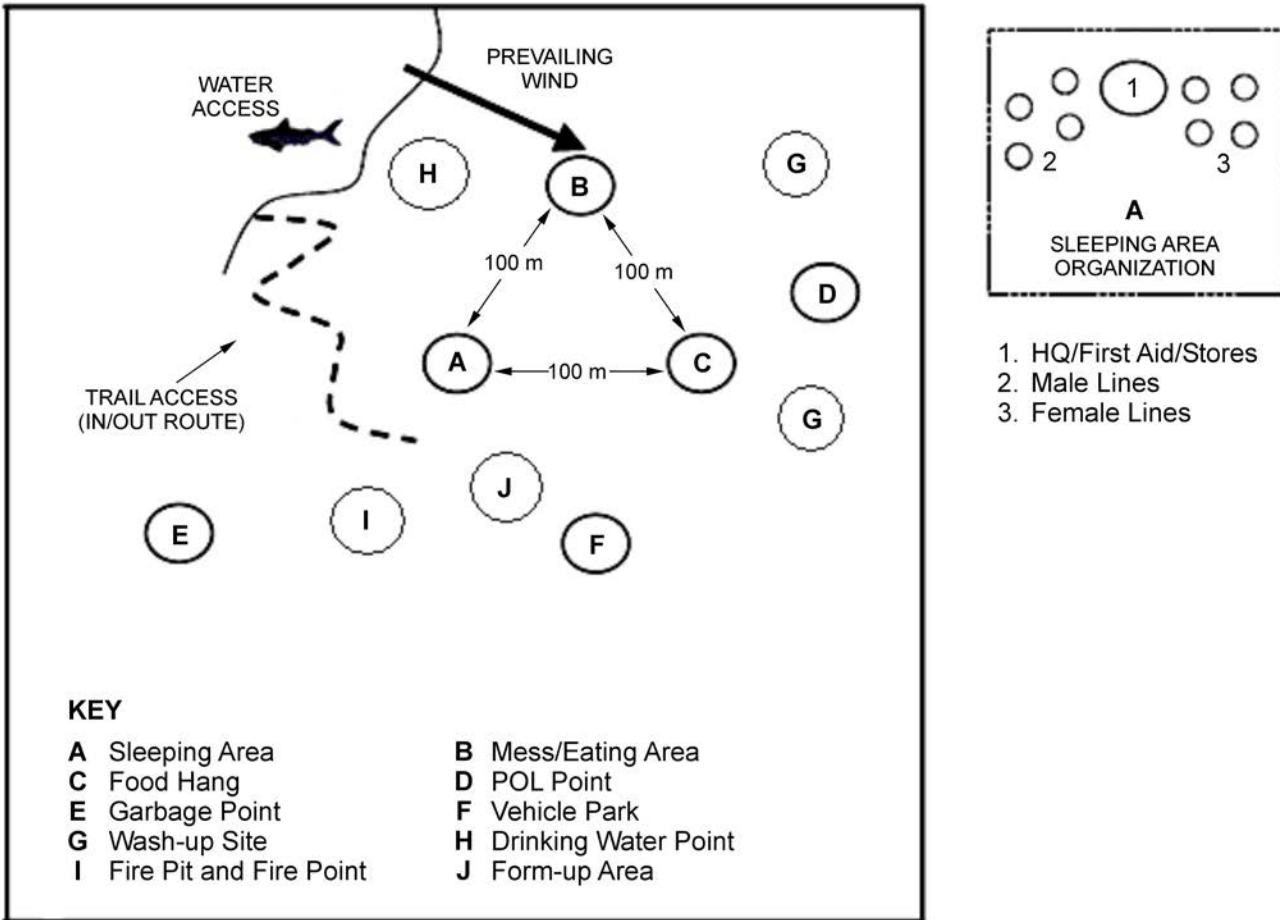

Director Cadets 3, 2008, Ottawa, ON: Department of National Defence

Figure 3L-2 Sample Bivouac Site Layout



## LEADERSHIP ASSIGNMENT

Unload Team Equipment and Supplies for a Survival Exercise

### ASSIGNMENT DESCRIPTION

Organize a team to unload team equipment and supplies from the supply vehicle (eg, equipment required for fire point, equipment required for petroleum, oils and lubricants [POL] point, etc). Place the equipment in an area easily accessible but do not store the equipment and supplies as they will be required to set up the bivouac site.

### RESOURCES

- Team equipment and supplies,
- Supply vehicle, and
- A minimum of four cadets.

### TIME

A maximum of 20 minutes.

### SAFETY CONSIDERATIONS

- Equipment should be kept out of high-traffic areas.
- Field tools must be safely handled.

**LEADERSHIP ASSIGNMENT**

Construct a Food Hang

**ASSIGNMENT DESCRIPTION**

Organize a team to construct a food hang as per the given bivouac site layout.

**RESOURCES**

- Area for the food hang,
- Diagram and instructions for the construction,
- Garbage bags,
- 15 m (50 feet) of rope, and
- A minimum of two cadets.

**TIME**

A maximum of 20 minutes.

**SAFETY CONSIDERATIONS**

N/A.

### CONSTRUCTING A FOOD HANG

1. Find a tree with a live branch. The branch should be at least 5 m (15 ft) from the ground with no object below that a bear could stand on.
2. Separate food from other items and store them into two equal bags.
3. Throw the rope over the branch. Attach one end of the rope to one of the bags with a slipped overhand knot.
4. Raise the bag as close as possible to the branch.
5. Attach the other bag to the rope as high up on the rope as possible. Leave a loop of rope near the bag for retrieval.
6. Push the second bag up to the level of the other bag with a long stick.
7. To retrieve the bags, hook the loop of the rope with the stick and pull it down. Remove the bag and lower the first bag.



*R. Curtis, The Backpackers Field Manual: A Comprehensive Guide to Mastering Backcountry Skills, Three Rivers Press (p. 186)*

Figure 3L-3 Food Hang

**LEADERSHIP ASSIGNMENT**

Set Up POL, First Aid and Fire Points

**ASSIGNMENT DESCRIPTION**

Organize a team to set up POL, first aid and fire points as per the given bivouac site layout.

**RESOURCES**

- Areas for the points,
- POL supplies,
- First aid equipment,
- Fire point equipment, and
- A minimum of six cadets.

**TIME**

A maximum of 15 minutes.

**SAFETY CONSIDERATIONS**

Equipment and supplies must be safely handled.

<b>LEADERSHIP ASSIGNMENT</b> Set Up the Female Sleeping Area
<b>ASSIGNMENT DESCRIPTION</b> Organize the female cadets into tent teams. Ensure they are aware of the female sleeping area boundaries. Supervise the cadets as they set up their tents in the female sleeping area. Ensure personal equipment is stored.
<b>RESOURCES</b> <ul style="list-style-type: none"><li>• Tents (one per two cadets),</li><li>• Mallets, and</li><li>• All female cadets.</li></ul>
<b>TIME</b> A maximum of 30 minutes.
<b>SAFETY CONSIDERATIONS</b> <ul style="list-style-type: none"><li>• Tents should be placed approximately 2 m apart.</li><li>• Consideration must be given to placement of guy lines.</li></ul>

**LEADERSHIP ASSIGNMENT**

Set Up the Male Sleeping Area

**ASSIGNMENT DESCRIPTION**

Organize the male cadets into tent teams. Ensure they are aware of the male sleeping area boundaries. Supervise the cadets as they set up their tents in the male sleeping area. Ensure personal equipment is stored.

**RESOURCES**

- Tents (one per two cadets),
- Mallets, and
- All male cadets.

**TIME**

A maximum of 30 minutes.

**SAFETY CONSIDERATIONS**

- Tents should be placed approximately 2 m apart.
- Consideration must be given to placement of guy lines.

## LEADERSHIP ASSIGNMENT

Mark the Components of the Bivouac Site

### ASSIGNMENT DESCRIPTION

Organize a team to mark the following components of the bivouac site:

- headquarters,
- first aid point,
- supply,
- wash station,
- mess/eating area,
- fire point,
- in/out route for the safety vehicle,
- form-up area,
- food hang,
- parking area,
- drinking water point,
- POL point,
- female/male sleeping areas,
- garbage point, and
- washrooms.

Glow Sticks or other lights will be used to mark areas that will be accessed at night.

### RESOURCES

- Paper,
- Markers,
- Tape,
- Glow Sticks or lights, and
- A minimum of three cadets.

### TIME

A maximum of 20 minutes.

### SAFETY CONSIDERATIONS

N/A.

**LEADERSHIP ASSIGNMENT**

Prepare a Meal for a Section

**ASSIGNMENT DESCRIPTION**

Organize a team to prepare a meal for a section during a Bivouac Exercise. When using individual meal packages (IMPs), field strip as required.

**RESOURCES**

- IMPs (if required),
- Water,
- Pots,
- Fuelled stove,
- Matches, and
- A minimum of two cadets.

**TIME**

A maximum of 30 minutes.

**SAFETY CONSIDERATIONS**

Stoves must be safely handled and monitored at all times when lit.



<b>LEADERSHIP ASSIGNMENT</b>
<p>Clean Up the Eating Area After a Meal</p>
<p><b>ASSIGNMENT DESCRIPTION</b></p> <p>Organize a team to clean up the bivouac site after a meal. Ensure all equipment is stored, all garbage is disposed of and that drinking water has been replenished.</p>
<p><b>RESOURCES</b></p> <ul style="list-style-type: none"><li>• Garbage bags,</li><li>• Water, and</li><li>• A minimum of four cadets.</li></ul>
<p><b>TIME</b></p> <p>A maximum of 20 minutes.</p>
<p><b>SAFETY CONSIDERATIONS</b></p> <p>N/A.</p>

**LEADERSHIP ASSIGNMENT**

Prepare the Bivouac Site for the Night

**ASSIGNMENT DESCRIPTION**

Organize a team to prepare the bivouac site for night. Ensure all equipment is stored, all garbage is disposed of and that lanterns are fuelled and accessible.

**RESOURCES**

- Garbage bags,
- Lanterns,
- Naphtha,
- Funnel,
- Matches, and
- A minimum of four cadets.

**TIME**

A maximum of 20 minutes.

**SAFETY CONSIDERATIONS**

N/A.

<b>LEADERSHIP ASSIGNMENT</b>
Organize Lights Out for the Female Cadets
<b>ASSIGNMENT DESCRIPTION</b> Organize lights out for the female cadets. Ensure that all female cadets are accounted for and that all personal equipment is stored inside the tents.
<b>RESOURCES</b> A minimum of two cadets.
<b>TIME</b> A maximum of 20 minutes.
<b>SAFETY CONSIDERATIONS</b> N/A.

**LEADERSHIP ASSIGNMENT**

Organize Lights Out for the Male Cadets

**ASSIGNMENT DESCRIPTION**

Organize lights out for the male cadets. Ensure that all male cadets are accounted for and that all personal equipment is stored inside the tents.

**RESOURCES**

A minimum of two cadets.

**TIME**

A maximum of 20 minutes.

**SAFETY CONSIDERATIONS**

N/A.

<b>LEADERSHIP ASSIGNMENT</b>
<p style="text-align: center;">Tear Down the Female Sleeping Area</p>
<p><b>ASSIGNMENT DESCRIPTION</b></p> <p>Organize a team to tear down the female sleeping area. Have the cadets strike, fold and store their tents in tent bags. Ensure all personal kit is organized and packed. Ensure all team equipment is returned to the supply area and all personal equipment is placed in the form-up area. Count all equipment and report numbers to the directing staff after completing the assignment.</p>
<p><b>RESOURCES</b></p> <ul style="list-style-type: none"><li>• Bivouac site layout, and</li><li>• All female cadets.</li></ul>
<p><b>TIME</b></p> <p>A maximum of 40 minutes.</p>
<p><b>SAFETY CONSIDERATIONS</b></p> <p>N/A.</p>

**LEADERSHIP ASSIGNMENT**

Tear Down the Male Sleeping Area

**ASSIGNMENT DESCRIPTION**

Organize a team to tear down the male sleeping area. Have the cadets strike, fold and store their tents in tent bags. Ensure all personal kit is organized and packed. Ensure all team equipment is returned to the supply area and all personal equipment is placed in the form-up area. Count all equipment and report numbers to the directing staff after completing the assignment.

**RESOURCES**

- Bivouac site layout,
- Paper,
- Pen/pencil, and
- All male cadets.

**TIME**

A maximum of 40 minutes.

**SAFETY CONSIDERATIONS**

N/A.

<p style="text-align: center;"><b>LEADERSHIP ASSIGNMENT</b></p> <p style="text-align: center;">Dismantle the POL, First Aid and Fire Points</p>
<p><b>ASSIGNMENT DESCRIPTION</b></p> <p>Organize a team to dismantle the POL, first aid and fire points. Return resources to the supply area as required.</p>
<p><b>RESOURCES</b></p> <ul style="list-style-type: none"><li>• Areas for the points, and</li><li>• A minimum of six cadets.</li></ul>
<p><b>TIME</b></p> <p>A maximum of 15 minutes.</p>
<p><b>SAFETY CONSIDERATIONS</b></p> <p>Equipment and supplies must be safely handled.</p>

**LEADERSHIP ASSIGNMENT**

Dismantle the Food Hang and Dispose of Garbage

**ASSIGNMENT DESCRIPTION**

Organize a team to dismantle the food hang and dispose of garbage to a given location. Return resources to the supply area as required.

**RESOURCES**

- Area for the food hang, and
- A minimum of two cadets.

**TIME**

A maximum of 15 minutes.

**SAFETY CONSIDERATIONS**

- Ensure no cadets are standing under the food hang when it is being taken down.
- Watch out for rope burns.



**LEADERSHIP ASSIGNMENT**

Load Team Equipment and Supplies After a Survival Exercise

**ASSIGNMENT DESCRIPTION**

Organize a team to load equipment and supplies on the supply vehicle after a survival exercise.

**RESOURCES**

- Resources as detailed by the instructional staff,
- Supply vehicle, and
- A minimum of four cadets.

**TIME**

A maximum of 30 minutes.

**SAFETY CONSIDERATIONS**

- Cadets should be kept out of high-traffic areas.
- Field tools must be safely handled.

**LEADERSHIP ASSIGNMENT**

Erase Signs of Occupancy and Complete a Final Garbage Sweep

**ASSIGNMENT DESCRIPTION**

Organize a team to erase signs of occupancy and complete a final garbage sweep. If a fire pit was used, ensure rocks and other materials are dispersed. Ensure the cadets fill in any tent peg holes with dirt. Conduct a final garbage sweep, ensuring all areas used are free of garbage.

**RESOURCES**

- Garbage bags, and
- A minimum of 10 cadets.

**TIME**

A maximum of 20 minutes.

**SAFETY CONSIDERATIONS**

N/A.

**LEADERSHIP ASSIGNMENT**

Unload Equipment and Supplies After a Bivouac Exercise

**ASSIGNMENT DESCRIPTION**

Organize a team to unload team equipment and supplies from the supply vehicle (eg, equipment required for POL point, equipment required for fire point). Place the equipment in a designated area.

**RESOURCES**

- Supply vehicle, and
- A minimum of four cadets.

**TIME**

A maximum of 20 minutes.

**SAFETY CONSIDERATIONS**

- Equipment should be kept out of high traffic areas.
- Field tools must be safely handled.

**LEADERSHIP ASSIGNMENT**

Collect Personal Equipment

**ASSIGNMENT DESCRIPTION**

Organize a team to collect personal equipment (eg, field packs, sleeping bags and air mattresses) after completing a Survival Exercise. Count all equipment and report numbers to the directing staff after completing the assignment.

**RESOURCES**

- Paper,
- Pen/pencil,
- Cadets with personal equipment to return, and
- A minimum of three cadets for collection.

**TIME**

A maximum of 20 minutes.

**SAFETY CONSIDERATIONS**

N/A.

## LEADERSHIP ASSIGNMENT PLANNING GUIDE

### **ENSURE GOAL**

Questions to the directing staff (eg, time to complete the task, etc)

### **REQUIRED RESOURCES**

Task assignment to peers/allocating resources (eg, are all tasks accomplished, etc)

### **MAKE A PLAN**

Reconnaissance of area, etc

### **COMPLETE THE TIME APPRECIATION**

### **DIAGRAMS**

THIS PAGE INTENTIONALLY LEFT BLANK

## LESSON ACTIVITIES

### LIST OF ACTIVITIES FOR ANNEX N

Title		Page Number
<b>ENERGIZERS</b>	Toe to Toe	<a href="#">3N-2</a>
	Pass the Buck	<a href="#">3N-3</a>
	Toe Tag	<a href="#">3N-4</a>
	Triangle Tag	<a href="#">3N-5</a>
	What Can You Do With This?	<a href="#">3N-6</a>
<b>ICEBREAKERS</b>	Personal Trivia	<a href="#">3N-7</a>
	ESP	<a href="#">3N-8</a>
	One Common Goal	<a href="#">3N-9</a>

<b>TEAM-BUILDING ACTIVITY</b>	<b>ENERGIZER</b>
<b>TOE TO TOE</b>	<b>TIME:</b> 10 min
<b>RESOURCES</b> <ul style="list-style-type: none"><li>• A large, open space free from obstacles, and</li><li>• Masking tape.</li></ul>	
<b>ACTIVITY LAYOUT</b> <p>Place the masking tape in a straight line approximately 4.5 m (15 feet) long on the ground.</p>	
<b>ACTIVITY INSTRUCTIONS</b> <ol style="list-style-type: none"><li>1. Divide the cadets into pairs.</li><li>2. Have each pair stand facing each other as if they were standing on a tight rope (on the masking tape line). The cadets are to stand with their right foot in front of the left, with the left foot directly in line with the right and about one foot length behind.</li><li>3. Have the cadets move toward each other so the toes of their right feet are touching.</li><li>4. Have the cadets grasp right hands in a handshake.</li><li>5. Explain the following to the cadets:<ol style="list-style-type: none"><li>(a) The objective of the activity is to try to bring their partner off balance and try to get them to fall off the tight rope (masking tape).</li><li>(b) At no time may the cadets let go of their partners' hand.</li><li>(c) They are not permitted to use their feet to try to knock their partner off balance. Feet must remain positioned on the line at all times.</li><li>(d) All movements must be made in slow motion. They are not permitted to push or shove their partner. There is to be no sharp, thrusting movements or any sudden shifts in movement.</li></ol></li><li>6. On the start signal, have the cadets try to knock their partner off balance and step off the tight rope (masking tape).</li><li>7. As time permits, have the cadets switch partners and attempt the activity again.</li></ol>	
<b>SAFETY</b> <p>N/A.</p>	
<b>REFERENCE</b> <p>(ISBN 0-934387-05-2) Collard, M. (2005). <i>No Props: Great Games With No Equipment</i>. (pp. 77–78). Beverly, MA: Project Adventure, Inc.</p>	



<b>TEAM-BUILDING ACTIVITY</b>	<b>ENERGIZER</b>
<b>PASS THE BUCK</b>	<b>TIME: 10 min</b>
<b>RESOURCES</b> <ul style="list-style-type: none"><li>• A large, open space free from obstacles,</li><li>• Stopwatch,</li><li>• First set of objects for passing (eg, bag of potato chips, air-filled balloon, roll of masking tape, mug, small ball, newspaper, etc), and</li><li>• Second set of objects for passing (eg, bag of potatoes, mug full of water, water-filled balloon, pillow, rolled sleeping bag, large ball, large textbook, etc).</li></ul>	
<b>ACTIVITY LAYOUT</b> <p>N/A.</p>	
<b>ACTIVITY INSTRUCTIONS</b> <ol style="list-style-type: none"><li>1. Have the cadets stand in a circle, facing the centre.</li><li>2. Assign one cadet as the “point”. This cadet will indicate the beginning and end of each cycle.</li><li>3. Explain the following to the cadets:<ol style="list-style-type: none"><li>(a) The objective of the activity is to pass the set of objects around the circle three times.</li><li>(b) Each time the last object passes the “point” a cycle is complete.</li><li>(c) If an object is dropped, all objects must go back to the “point” to begin again.</li><li>(d) If the objects are successfully passed around the circle three times in one minute, 15 points are awarded. Each additional item that completes a cycle, earns the group one point.</li></ol></li><li>4. Start the activity by passing the objects to the “point” one at a time. At this time, start the stopwatch for one minute.</li><li>5. Continue this activity until time has lapsed or the cadets understand the objective of the activity.</li><li>6. As time allows, have the cadets follow the directions for the second set of objects.</li></ol>	
<b>SAFETY</b> <p>N/A.</p>	
<b>REFERENCE</b> <p>(ISBN 0-7879-4835-7) Sugar, S., &amp; Takacs, G. (2000). <i>Games That Teach Teams</i>. (pp. 139–142). San Francisco, CA: Jossey-Bass/Pfeiffer.</p>	

<b>TEAM-BUILDING ACTIVITY</b>	<b>ENERGIZER</b>
<b>TOE TAG</b>	<b>TIME:</b> 10 min
<b>RESOURCES</b> A large, open space free from obstacles.	
<b>ACTIVITY LAYOUT</b> N/A.	
<b>ACTIVITY INSTRUCTIONS</b> <ol style="list-style-type: none"><li>1. Divide the cadets into partners.</li><li>2. Have each set of partners stand apart from the other cadets.</li><li>3. Have the partners stand with their backs to one another.</li><li>4. On a start signal, have the cadets spin around in a 180-degree circle and try to “tag” the toe of their partner before they get tagged.</li><li>5. Each set of partners should attempt this two to three times.</li><li>6. Have the cadets switch partners and try the activity again.</li></ol>	
<b>SAFETY</b> Ensure the cadets remember the name of the game is “tag”, not “stomp”.	
<b>REFERENCE</b> (ISBN 0-934387-05-2) Collard, M. (2005). <i>No Props: Great Games With No Equipment</i> . (p. 97). Beverly, MA: Project Adventure, Inc.	

<b>TEAM-BUILDING ACTIVITY</b>	<b>ENERGIZER</b>
<b>TRIANGLE TAG</b>	<b>TIME: 10 min</b>
<b>RESOURCES</b> A large, open space free from obstacles.	
<b>ACTIVITY LAYOUT</b> N/A.	
<b>ACTIVITY INSTRUCTIONS</b> <ol style="list-style-type: none"><li>1. Have one cadet volunteer to be “it”.</li><li>2. Divide the remainder of the cadets into groups of three.</li><li>3. Have each group form a circle, holding hands and facing the centre of their circle.</li><li>4. Explain the following to the cadets:<ol style="list-style-type: none"><li>(a) One cadet within each circle will be designated to be tagged – the “tagee”. The other two members of the group will be that cadet’s protectors.</li><li>(b) On a start signal, the cadet who is “it” must try to tag the cadet within the circle who is designated the “tagee”.</li><li>(c) The cadets are to protect the “tagee” by spinning in circles to avoid the cadet who is “it”.</li><li>(d) If a cadet is tagged, they will become “it” and the former cadet who was “it” will join the group with a new cadet being designated the “tagee”.</li><li>(e) After a couple of minutes if the same cadet is still “it” change the roles of the cadets and give someone else an opportunity to be “it”.</li></ol></li><li>5. On a start signal, have the cadets begin to spin to avoid the cadet designated as “it”.</li></ol>	
<b>SAFETY</b> N/A.	
<b>REFERENCE</b> (ISBN 0-934387-05-2) Collard, M. (2005). <i>No Props: Great Games With No Equipment</i> . (p. 98). Beverly, MA: Project Adventure, Inc.	

<b>TEAM-BUILDING ACTIVITY</b>	<b>ENERGIZER</b>
<b>WHAT CAN YOU DO WITH THIS?</b>	<b>TIME:</b> 10 min
<b>RESOURCES</b> <ul style="list-style-type: none"><li>• A large, open space,</li><li>• An odd object (eg, staple remover, kitchen tongs, kitchen strainer, plastic container, etc),</li><li>• Paper, and</li><li>• Pens/pencils (one per group).</li></ul>	
<b>ACTIVITY LAYOUT</b> <p>N/A.</p>	
<b>ACTIVITY INSTRUCTIONS</b> <ol style="list-style-type: none"><li>1. Divide the cadets into two groups.</li><li>2. Distribute a piece of paper and a pen/pencil to each group.</li><li>3. Explain the following to the cadets:<ol style="list-style-type: none"><li>(a) Once they see an item they will have to list as many possible uses for the object as they can.</li><li>(b) They will have a time limit of five minutes to make the list.</li><li>(c) After the time is up both groups are to come back together and the lists will be discussed as a full group.</li></ol></li><li>4. Pull the object out of the bag and have the cadets begin their lists.</li><li>5. After five minutes, have the groups come together and present their lists to the other groups.</li></ol>	
<b>SAFETY</b> <p>N/A.</p>	
<b>REFERENCE</b> <p>(ISBN 0-9662341-6-2) Jones, A. (1999). <i>Team-Building Activities for Every Group</i>. (p. 25). Richland, WA: Rec Room Publishing.</p>	

<b>TEAM-BUILDING ACTIVITY</b>	<b>ICEBREAKER</b>
<b>PERSONAL TRIVIA</b>	<b>TIME: 10–15 min</b>
<b>RESOURCES</b> <ul style="list-style-type: none"><li>• A large, open space free from obstacles,</li><li>• Index cards (one per cadet),</li><li>• Paper (one sheet per cadet), and</li><li>• Pens/pencils (one per cadet).</li></ul>	
<b>ACTIVITY LAYOUT</b> <p>N/A.</p>	
<b>ACTIVITY INSTRUCTIONS</b> <ol style="list-style-type: none"><li>1. Distribute an index card and a pen/pencil to each cadet.</li><li>2. Have each cadet write the following on their index card:<ol style="list-style-type: none"><li>(a) their name, and</li><li>(b) five little-known facts about themselves (eg, favourite movie, favourite singer/band, favourite television show, favourite restaurant, favourite sport, etc).</li></ol></li><li>3. Collect all of the index cards.</li><li>4. Distribute a piece of paper to each cadet.</li><li>5. Read out each index card, one at a time, and have each cadet write down the name of the cadet whose card they think was read.</li><li>6. After the last card was read, have the cadets read out their guesses and identify which cadets guessed them correctly.</li></ol>	
<b>SAFETY</b> <p>N/A.</p>	
<b>REFERENCE</b> <p>(ISBN 0-9662341-6-2) Jones, A. (1999). <i>Team-Building Activities for Every Group</i>. (p. 26). Richland, WA: Rec Room Publishing.</p>	

<b>TEAM-BUILDING ACTIVITY</b>	<b>ICEBREAKER</b>
<b>ESP</b>	<b>TIME: 10–15 min</b>
<b>RESOURCES</b> A large, open space free from obstacles.	
<b>ACTIVITY LAYOUT</b> N/A.	
<b>ACTIVITY INSTRUCTIONS</b> <ol style="list-style-type: none"><li>Demonstrate three physical gestures that will be used for the activity. The three gestures should be from a similar category. For example, three of the following sports-related gestures could be chosen:<ol style="list-style-type: none"><li>swimming;</li><li>swinging a golf club;</li><li>swinging a baseball bat;</li><li>shooting a hockey puck; or</li><li>kicking a soccer ball.</li></ol></li><li>Divide the cadets into pairs.</li><li>Have the cadets practice these gestures a couple of times.</li><li>Have the pairs line up back to back in a straight line with plenty of room between each set of pairs.</li><li>Explain the following to the cadets:<ol style="list-style-type: none"><li>The objective of the activity is to try to perform the same gesture as your partner, without any clues, as many times as possible.</li><li>On a start signal from the leader, the cadets will turn around and face their partner while performing one of the three given gestures.</li><li>After completing each gesture, the partners will stand back to back again without giving any clues to each other as to the next gesture they will perform.</li><li>The cadets will continue to do this on each start signal from the leader until the time is complete.</li><li>The cadets should count how many times they successfully performed the same gesture as their partner.</li><li>Upon completion of the activity, have each group state how many times they were successful.</li></ol></li><li>On a given start signal have the cadets turn around to face their partner while performing one of the gestures.</li><li>Have the cadets continue this until the time has lapsed.</li><li>Have the cadets state how many times they were successful at performing the same gesture as their partner on completion of the activity.</li></ol>	
<b>SAFETY</b> N/A.	
<b>REFERENCE</b> (ISBN 0-934387-05-2) Collard, M. (2005). <i>No Props: Great Games With No Equipment</i> . (pp. 57–58). Beverly, MA: Project Adventure, Inc.	

<b>TEAM-BUILDING ACTIVITY</b>	<b>ICEBREAKER</b>
<b>ONE COMMON GOAL</b>	<b>TIME: 10–15 min</b>
<b>RESOURCES</b> <ul style="list-style-type: none"><li>• A large, open space,</li><li>• Paper (one sheet per pair), and</li><li>• Pens/pencils (one per pair).</li></ul>	
<b>ACTIVITY LAYOUT</b> <p>N/A.</p>	
<b>ACTIVITY INSTRUCTIONS</b> <ol style="list-style-type: none"><li>1. Divide the cadets into pairs.</li><li>2. Distribute a piece of paper and a pen/pencil to each pair.</li><li>3. Explain that each pair is to think of as many common traits (eg, hair colour, number of siblings) between them as they can and write them on the piece of paper.</li><li>4. After approximately six minutes, have the cadets come together as a group and present their common traits one pair at a time.</li></ol>	
<b>SAFETY</b> <p>N/A.</p>	
<b>REFERENCE</b> <p>(ISBN 0-9662341-6-2) Jones, A. (1999). <i>Team-Building Activities for Every Group</i>. (p. 31). Richland, WA: Rec Room Publishing.</p>	

THIS PAGE INTENTIONALLY LEFT BLANK



**ENERGIZERS AND ICEBREAKERS**

**LIST OF ACTIVITIES FOR ANNEX O**

Title	Page Number
<b>ENERGIZERS</b>	Shipwreck 30-2
	Balloons 30-3
	Mirror Image 30-4
	Have You Ever? 30-5
	Zip Zap 30-6
	Tall Ship 30-7
	Chic-a-Boom 30-8
	Pig Personality Profile 30-9
	Circle the Circle 30-10
	Clumps 30-11
	Cadet Feud #1 30-12
	Cadet Feud #2 30-14
	Tiny Teach 30-16
	Four Up 30-17
	Yurt Circle 30-18
	Hoop Relay 30-19
	All Aboard 30-21
	Line Up 30-22
	Pick Pocket 30-23
	About Now 30-25
Mass Stand Up 30-26	
Word Puzzle 30-27	
<b>ICEBREAKERS</b>	Categories 30-30
	Human Scavenger Hunt 30-31
	The Walking Billboard 30-32
	Getting Acquainted 30-33
	Bingo Blast 30-34
	Team Charades 30-36
	Double Take 30-37
	Peculiarities 30-38
	I Like Me Because 30-40
	Group Juggle 30-41
	Meet 'N Greet 30-42
	Who Are You? 30-43
	Birthday Line 30-44
	A Coat of Arms 30-45
Martian Names 30-47	

<b>TEAM-BUILDING ACTIVITY</b>	<b>ENERGIZER</b>
<b>SHIPWRECK</b>	<b>TIME:</b> 10 min
<b>RESOURCES</b> <ul style="list-style-type: none"><li>• A large, open space free from obstacles,</li><li>• Rope (enough for 0.5 m [1.6 feet] per group), and</li><li>• Scissors.</li></ul>	
<b>ACTIVITY LAYOUT</b> <p>Cut the rope into 0.5 m (1.6 feet) lengths and tie to make one circle per group.</p>	
<b>ACTIVITY INSTRUCTIONS</b> <ol style="list-style-type: none"><li>1. Divide the cadets into groups of five.</li><li>2. Give each group a “ship” (rope circle).</li><li>3. With all members holding on to the sides of the “ship”, the cadets must run back and forth the length of the playing field.</li><li>4. When the leader yells “SHARK”, all members must lay the “ship” down and jump “on board” (inside the rope circle). The first group with all feet off the ground gains a point.</li><li>5. Repeat the procedure until a group reaches five points.</li></ol>	
<b>SAFETY</b> <p>N/A.</p>	
<b>REFERENCE</b> <p>(ISBN 0-8403-5682-X) Rohnke, K. (1984). <i>Silver Bullets: A Guide to Initiative Problems, Adventure Games and Trust Activities</i>. (p. 112). Dubuque, IA: Kendall/Hunt Publishing Company.</p>	

<b>TEAM-BUILDING ACTIVITY</b>	<b>ENERGIZER</b>
<b>BALLOONS</b>	<b>TIME:</b> 10 min
<b>RESOURCES</b> <ul style="list-style-type: none"><li>• A large, open space free from obstacles,</li><li>• Balloons (a minimum of one per group),</li><li>• Funnel, and</li><li>• Water.</li></ul>	
<b>ACTIVITY LAYOUT</b> <p>Blow up the balloons and put a small amount of water in each.</p>	
<b>ACTIVITY INSTRUCTIONS</b> <ol style="list-style-type: none"><li>1. Divide the cadets into groups of five.</li><li>2. Have each group form a circle.</li><li>3. Give each group a balloon with a small amount of water in it.</li><li>4. Have the cadets try to keep the balloon off the ground by using their feet to hit it to the other cadets in the group.</li><li>5. Encourage teams to try to keep the balloon moving from cadet to cadet for as long as possible.</li></ol>	
<b>SAFETY</b> <p>N/A.</p>	
<b>REFERENCE</b> <p>(ISBN 0-8403-5682-X) Rohnke, K. (1984). <i>Silver Bullets: A Guide to Initiative Problems, Adventure Games and Trust Activities</i>. (p. 67). Dubuque, IA: Kendall/Hunt Publishing Company.</p>	

<b>TEAM-BUILDING ACTIVITY</b>	<b>ENERGIZER</b>
<b>MIRROR IMAGE</b>	<b>TIME: 10 min</b>
<b>RESOURCES</b> A large, open space free from obstacles.	
<b>ACTIVITY LAYOUT</b> N/A.	
<b>ACTIVITY INSTRUCTIONS</b> <ol style="list-style-type: none"><li>1. Divide the cadets into pairs (pairs should be close to the same height).</li><li>2. Within each pair, have one cadet initiate an action and the other imitate it, becoming the “mirror image”.</li><li>3. Encourage the initiator to make slow movements, stretches and jumps.</li><li>4. Swap roles after a few minutes.</li></ol>	
<b>SAFETY</b> N/A.	
<b>REFERENCE</b> (ISBN 0-934387-05-2) Collard, M. (2005). <i>No Props: Great Games With No Equipment</i> . (pp. 76–77). Beverly, MA: Project Adventure, Inc.	

<b>TEAM-BUILDING ACTIVITY</b>	<b>ENERGIZER</b>
<b>HAVE YOU EVER?</b>	<b>TIME:</b> 10 min
<b>RESOURCES</b> A large, open space free from obstacles.	
<b>ACTIVITY LAYOUT</b> N/A.	
<b>ACTIVITY INSTRUCTIONS</b> <ol style="list-style-type: none"><li>1. Have the cadets form a circle, either seated or standing.</li><li>2. Ask for a volunteer to sit or stand in the middle (the “questioner”).</li><li>3. Have the “questioner” ask an appropriate question to the group that is prefaced with “Have you ever....?” (eg, Have you ever stayed up for 48 hours straight? Have you ever been to another Cadet Summer Training Centre?). The question that the “questioner” asks must be something that they have actually done.</li><li>4. If there are cadets in the circle who have experienced what the “questioner” asked, they are to leave their place in the circle and find an empty place somewhere else in the circle. The “questioner” also tries to find an empty space.</li><li>5. The person who is left without a place in the circle once everyone has moved is the new “questioner”.</li><li>6. Continue the process with a new “questioner”.</li></ol>	
<b>SAFETY</b> N/A.	
<b>REFERENCE</b> (ISBN 0-934387-05-2) Collard, M. (2005). <i>No Props: Great Games With No Equipment</i> . (pp. 193–194). Beverly, MA: Project Adventure, Inc.	

<b>TEAM-BUILDING ACTIVITY</b>	<b>ENERGIZER</b>
<b>ZIP ZAP</b>	<b>TIME: 10 min</b>
<b>RESOURCES</b> A large, open space free from obstacles.	
<b>ACTIVITY LAYOUT</b> N/A.	
<b>ACTIVITY INSTRUCTIONS</b> <ol style="list-style-type: none"><li>1. Have the cadets stand in a circle.</li><li>2. Ask for a volunteer to stand in the middle. This cadet is the “zipper”.</li><li>3. Have the “zipper” approach someone with their hands pressed together and all fingers pointing forward, look them straight in the eye and say “zip”.</li><li>4. Once “zip” is called, the cadet being pointed at is to duck down – the “ducker”. The two cadets on each side of the “ducker” are to face in toward each other, with their hands clasped and index fingers pointing at the other person. Each cadet is to yell “zap” at the other person (this will usually occur simultaneously). These people are the “zappers”.</li><li>5. If the “ducker” does not duck quick enough or a cadet gets zapped, that cadet is to go to the middle and become the new “zipper”.</li><li>6. After two or three rounds, invite another “zipper” to the middle to create more challenge. Continue the activity with two or more “zippers”.</li></ol>	
<b>SAFETY</b> N/A.	
<b>REFERENCE</b> (ISBN 0-934387-05-2) Collard, M. (2005). <i>No Props: Great Games With No Equipment</i> . (pp. 58–59). Beverly, MA: Project Adventure, Inc.	

<b>TEAM-BUILDING ACTIVITY</b>	<b>ENERGIZER</b>
<b>TALL SHIP</b>	<b>TIME: 10 min</b>
<b>RESOURCES</b> A large, open space free from obstacles.	
<b>ACTIVITY LAYOUT</b> Determine the bow, stern, port and starboard sides of the “ship”.	
<b>ACTIVITY INSTRUCTIONS</b> <ol style="list-style-type: none"><li>1. Have the cadets stand in a circle in the centre of the “ship”.</li><li>2. Demonstrate and explain the seaworthy terms and chores that the cadets will be performing:<ol style="list-style-type: none"><li>(a) “Bow” – move to the front;</li><li>(b) “Stern” – move to the rear;</li><li>(c) “Port” – move to the left;</li><li>(d) “Starboard” – move to the right;</li><li>(e) “Attention” – cadets stand at attention and salute;</li><li>(f) “Swab the Deck” – cadets get on their hand and knees and scrub the deck;</li><li>(g) “Sailor Overboard” – all cadets drop to the deck on either the port or starboard sides;</li><li>(h) “Lifeboats” – groups of three form a single file line, sit and pretend to row a boat; and</li><li>(i) “Rig the Sails” – groups of two join hands and pretend to set up the sails.</li></ol></li><li>3. As the Captain, issue a series of commands to the cadets.</li></ol>	
<b>SAFETY</b> N/A.	
<b>REFERENCE</b> (ISBN 0-934387-05-2) Collard, M. (2005). <i>No Props: Great Games With No Equipment</i> . (pp. 87–88). Beverly, MA: Project Adventure, Inc.	

<b>TEAM-BUILDING ACTIVITY</b>	<b>ENERGIZER</b>
<b>CHIC-A-BOOM!</b>	<b>TIME:</b> 10 min
<b>RESOURCES</b>	
A large, open space free from obstacles.	
<b>ACTIVITY LAYOUT</b>	
Look over the dance moves and the words to the Chic-a-boom song.	
<b>ACTIVITY INSTRUCTIONS</b>	
<ol style="list-style-type: none"><li>1. Have the group stand in a circle.</li><li>2. Teach the group the following moves – with the index fingers, point up to the sky and alternate thrusts of each hand to a beat (eg, left hand up, then right hand up). Point down with alternating thrusts, point to the left while taking rocking steps and point to the right while taking rocking steps.</li><li>3. Using the dancing moves, teach the cadets the Chic-a-Boom song:  <i>“Hey there (enter name), you’re a real cool cat. You’ve got a lot of this, and you’ve got a lot of that. So come on in and get down... ...aaaand, up chic-a-boom, chic-a-boom, chic-a-boom. And down chic-a-boom, chic-a-boom, chic-a-boom. To the left, chic-a-boom, chic-a-boom, chic-a-boom. To the right, chic-a-boom, chic-a-boom, chic-a-boom.”</i></li></ol>	
<ol style="list-style-type: none"><li>4. Have one cadet volunteer to be the first cadet to go in the middle of the circle.</li><li>5. Have the cadets sing the song and complete the dance moves. The cadet in the middle begins to sing while looking directly at someone in the circle. When the song gets to the “<i>come on in and get down</i>” part, have the cadet in the middle sidle up to another cadet, link arms and lead them to the centre of the circle.</li><li>6. On the next turn, both cadets stay in the middle and bring another cadet in, and so on.</li><li>7. Encourage cadets to be creative and expressive with their singing and dancing when they are in the middle of the circle. They could bring some attitude or even beat boxing into the circle.</li><li>8. The activity ends when all cadets are in the middle of the circle.</li></ol>	
<b>SAFETY</b>	
N/A.	
<b>REFERENCE</b>	
(ISBN 0-934387-05-2) Collard, M. (2005). <i>No Props: Great Games With No Equipment</i> . (pp. 74–75). Beverly, MA: Project Adventure, Inc.	



<p><b>TEAM-BUILDING ACTIVITY</b></p> <p><b>PIG PERSONALITY PROFILE</b></p>	<p><b>ENERGIZER</b></p> <p><b>TIME:</b> 10 min</p>
<p><b>RESOURCES</b></p> <ul style="list-style-type: none"> <li>• Paper (one sheet per cadet), and</li> <li>• Pens/pencils (one per cadet).</li> </ul>	
<p><b>ACTIVITY LAYOUT</b></p> <p>N/A.</p>	
<p><b>ACTIVITY INSTRUCTIONS</b></p> <ol style="list-style-type: none"> <li>1. Distribute a piece of paper and a pen/pencil to each cadet.</li> <li>2. Read the following out loud, “On a blank piece of paper, draw a pig. Don’t look at your neighbour’s pig. Don’t even glance.”</li> <li>3. Allow approximately three minutes for the cadets to draw a pig.</li> <li>4. When all cadets are finished, allow a few moments for the cadets to look at their neighbours’ pigs.</li> <li>5. Explain that the pig drawings could indicate a person’s personality traits. Share the personality traits of the pig exercise with the group. If the pig is drawn:             <ol style="list-style-type: none"> <li>(a) toward the top of the paper, you are a positive, cheerful person;</li> <li>(b) toward the middle of the paper (top to bottom), you are a practical person;</li> <li>(c) toward the bottom of the paper, you are gloomy and have a tendency to behave negatively;</li> <li>(d) facing left, you believe in tradition, are friendly and remember dates, including birthdays;</li> <li>(e) facing forward (looking toward you), you are direct, enjoy playing devil’s advocate and neither fear nor avoid discussions;</li> <li>(f) facing right, you are innovative and active but don’t have a strong sense of family, nor do you remember dates;</li> <li>(g) with many details, you are investigative, cautious and distrustful;</li> <li>(h) with few details, you are emotional and naïve, care little for details and are a risk taker;</li> <li>(i) with four legs showing, you are secure, stubborn and stick to your ideals;</li> <li>(j) with less than four legs showing, you are insecure or are living through a period of major change;</li> <li>(k) the size of the pig’s ears indicates how good a listener you are – large is good; and</li> <li>(l) the length of the pig’s tail indicates your energy level – longer indicates more.</li> </ol> </li> <li>6. Allow time for the cadets to discuss their pigs with others.</li> </ol>	
<p><b>SAFETY</b></p> <p>N/A.</p>	
<p><b>REFERENCE</b></p> <p>(ISBN 0-943210-44-5) Pike. B., &amp; Busse, C. (1995). <i>101 More Games for Trainers</i>. (pp. 102–103). Minneapolis, MN: Lakewood Publications.</p>	

<b>TEAM-BUILDING ACTIVITY</b>	<b>ENERGIZER</b>
<b>CIRCLE THE CIRCLE</b>	<b>TIME:</b> 10 min
<b>RESOURCES</b> <ul style="list-style-type: none"><li>• A large, open space free from obstacles, and</li><li>• Hula hoop.</li></ul>	
<b>ACTIVITY LAYOUT</b> <p>N/A.</p>	
<b>ACTIVITY INSTRUCTIONS</b> <ol style="list-style-type: none"><li>1. Have the cadets form a circle and hold hands with the cadet on either side of them.</li><li>2. Rest a hula hoop on two cadets' grasped hands.</li><li>3. Have the cadets try to have the hoop travel around the circle, while everyone is still holding hands.</li><li>4. If the activity is completed quickly, have the cadets try again.</li></ol>	
<b>SAFETY</b> <p>N/A.</p>	
<b>REFERENCE</b> <p>(ISBN 0-8403-5682-X) Rohnke, K. (1984). <i>Silver Bullets: A Guide to Initiative Problems, Adventure Games and Trust Activities</i>. (p. 60). Dubuque, IA: Kendall/Hunt Publishing Company.</p>	

<b>TEAM-BUILDING ACTIVITY</b>	<b>ENERGIZER</b>
<b>CLUMPS</b>	<b>TIME:</b> 10 min
<b>RESOURCES</b> A large, open space free from obstacles.	
<b>ACTIVITY LAYOUT</b> N/A.	
<b>ACTIVITY INSTRUCTIONS</b> <ol style="list-style-type: none"><li>1. Have the cadets gather in the designated space.</li><li>2. Explain that numbers will be shouted out (eg, “four”, “seven”, etc). When numbers are shouted out, the cadets are to form groups consisting of that number of people. Those cadets who do not form a group can simply wait until another number is shouted out, and then form a group.</li><li>3. If the cadets catch on quickly, add a new rule that each cadet cannot form a new group with any cadet who was in their previous group.</li></ol>	
<b>SAFETY</b> N/A.	
<b>REFERENCE</b> (ISBN 0-934387-05-2) Collard, M. (2005). <i>No Props: Great Games With No Equipment</i> . (pp. 32–33). Beverly, MA: Project Adventure, Inc.	

<b>TEAM-BUILDING ACTIVITY</b>	<b>ENERGIZER</b>
<b>CADET FEUD #1</b>	<b>TIME: 10 min</b>
<b>RESOURCES</b> <ul style="list-style-type: none"><li>• Cadet Feud Survey (one per cadet),</li><li>• Scissors,</li><li>• Pens/pencils (one per cadet),</li><li>• Tennis ball,</li><li>• Chalkboard/whiteboard, and</li><li>• Chalk or whiteboard markers.</li></ul>	
<b>ACTIVITY LAYOUT</b> <ul style="list-style-type: none"><li>• Photocopy, cut out and have the cadets complete the survey.</li><li>• Conduct the attached survey.</li><li>• Tally and rank the top five answers for each question.</li><li>• Prepare the chalkboard/whiteboard by writing the numbers one through five.</li></ul>	
<b>ACTIVITY INSTRUCTIONS</b> <p><b>Note:</b> This game is played in the same manner as the television show “Family Feud.”</p> <ol style="list-style-type: none"><li>1. Divide the group into two teams and have them sit facing each other.</li><li>2. Place a tennis ball on a table or on the floor. Have the first person from each team come forward and sit an equal distance away from the tennis ball (this will serve as the “buzzer”).</li><li>3. Ask the first question (eg, “Name five of the top restaurants.”). The first person to grab the ball will get a chance to answer the question. If the ball is grabbed early, stop reading the question and allow for the cadet to give an answer.</li><li>4. If the cadet gives an answer that is on the list, write it beside the corresponding number. If this person has not guessed the number one answer, the other player may have a turn to guess. The person who guesses the highest answer on the list gets to choose whether his/her team will play or pass.</li><li>5. After this, each team gets three strikes (wrong answers). The team that is playing gets the chance to guess the remaining answers on the board. Give each person a turn, down the line.</li><li>6. Once the playing team gets three strikes, the other team decides as a group what one answer they want to give to try to fill in one of the remaining blanks.</li><li>7. If the first team fills in all the blanks, they win the round, but if the opposing team guesses one of the remaining answers, they win the round.</li><li>8. Continue with the rest of the questions in the same manner.</li></ol>	
<b>SAFETY</b> <p>N/A.</p>	
<b>REFERENCE</b> <p>(ISBN 0-9662341-6-2) Jones, A. (1999). <i>Team-Building Activities for Every Group</i>. (pp. 36–37). Richland, WA: Rec Room Publishing.</p>	

**CADET FEUD SURVEY**

Answer the following questions. Be sure to write only one answer.

<b>QUESTIONS</b>	<b>ANSWERS</b>
1. What is your favourite restaurant?	
2. What is your favourite type of music?	
3. What is your hair colour?	
4. What is your favourite shampoo?	
5. What is your favourite winter activity?	

**CADET FEUD SURVEY**

Answer the following questions. Be sure to write only one answer.

<b>QUESTIONS</b>	<b>ANSWERS</b>
1. What is your favourite restaurant?	
2. What is your favourite type of music?	
3. What is your hair colour?	
4. What is your favourite shampoo?	
5. What is your favourite winter activity?	

**CADET FEUD SURVEY**

Answer the following questions. Be sure to write only one answer.

<b>QUESTIONS</b>	<b>ANSWERS</b>
1. What is your favourite restaurant?	
2. What is your favourite type of music?	
3. What is your hair colour?	
4. What is your favourite shampoo?	
5. What is your favourite winter activity?	

**CADET FEUD SURVEY**

Answer the following questions. Be sure to write only one answer.

<b>QUESTIONS</b>	<b>ANSWERS</b>
1. What is your favourite restaurant?	
2. What is your favourite type of music?	
3. What is your hair colour?	
4. What is your favourite shampoo?	
5. What is your favourite winter activity?	

<b>TEAM-BUILDING ACTIVITY</b>	<b>ENERGIZER</b>
<b>CADET FEUD #2</b>	<b>TIME: 10 min</b>
<b>RESOURCES REQUIRED</b> <ul style="list-style-type: none"><li>• Cadet Feud Survey (one per cadet),</li><li>• Scissors,</li><li>• Pens/pencils (one per cadet),</li><li>• Tennis ball,</li><li>• Chalkboard/whiteboard, and</li><li>• Chalk or whiteboard markers.</li></ul>	
<b>ACTIVITY LAYOUT</b> <ul style="list-style-type: none"><li>• Photocopy, cut out and have the cadets complete the survey.</li><li>• Conduct the attached survey.</li><li>• Tally and rank the top five answers for each question.</li><li>• Prepare the chalkboard or whiteboard by writing the numbers one through five.</li></ul>	
<b>ACTIVITY INSTRUCTIONS</b> <p><b>Note:</b> This game is played in the same manner as the television show “Family Feud.”</p> <ol style="list-style-type: none"><li>1. Divide the group into two teams and have them sit facing each other.</li><li>2. Place a tennis ball on a table or on the floor. Have the first person from each team come forward and sit an equal distance away from the tennis ball (this will serve as the “buzzer”).</li><li>3. Ask the first question (eg, “Name five of the top celebrities.”). The first person to grab the ball will get a chance to answer the question. If the ball is grabbed early, stop reading the question and allow for the cadet to give an answer.</li><li>4. If the cadet gives an answer that is on the list, write it beside the corresponding number. If this person has not guessed the number one answer, the other player may have a turn to guess. The person who guesses the highest answer on the list gets to choose whether his/her team will play or pass.</li><li>5. After this, each team gets three strikes (wrong answers). The team that is playing gets the chance to guess the remaining answers on the board. Give each person a turn, down the line.</li><li>6. Once the playing team gets three strikes, the other team decides as a group what one answer they want to give to try to fill in one of the remaining blanks.</li><li>7. If the first team fills in all the blanks, they win the round, but if the opposing team guesses one of the remaining answers, they win the round.</li><li>8. Continue with the rest of the questions in the same manner.</li></ol>	
<b>SAFETY</b> <p>N/A.</p>	
<b>REFERENCE</b> <p>(ISBN 0-9662341-6-2) Jones, A. (1999). <i>Team-Building Activities for Every Group</i>. (pp. 36–37). Richland, WA: Rec Room Publishing.</p>	

**CADET FEUD SURVEY**

Answer the following questions. Be sure to write only one answer.

<b>QUESTIONS</b>	<b>ANSWERS</b>
1. Who is your favourite celebrity?	
2. Where is your favourite place to shop (store name)?	
3. What is your favourite sport?	
4. What is the colour of your toothbrush?	
5. What is your dream job?	

**CADET FEUD SURVEY**

Answer the following questions. Be sure to write only one answer.

<b>QUESTIONS</b>	<b>ANSWERS</b>
1. Who is your favourite celebrity?	
2. Where is your favourite place to shop (store name)?	
3. What is your favourite sport?	
4. What is the colour of your toothbrush?	
5. What is your dream job?	

**CADET FEUD SURVEY**

Answer the following questions. Be sure to write only one answer.

<b>QUESTIONS</b>	<b>ANSWERS</b>
1. Who is your favourite celebrity?	
2. Where is your favourite place to shop (store name)?	
3. What is your favourite sport?	
4. What is the colour of your toothbrush?	
5. What is your dream job?	

**CADET FEUD SURVEY**

Answer the following questions. Be sure to write only one answer.

<b>QUESTIONS</b>	<b>ANSWERS</b>
1. Who is your favourite celebrity?	
2. Where is your favourite place to shop (store name)?	
3. What is your favourite sport?	
4. What is the colour of your toothbrush?	
5. What is your dream job?	

<b>TEAM-BUILDING ACTIVITY</b>	<b>ENERGIZER</b>
<b>TINY TEACH</b>	<b>TIME:</b> 10 min
<b>RESOURCES</b> A large, open space free from obstacles.	
<b>ACTIVITY LAYOUT</b> N/A.	
<b>ACTIVITY INSTRUCTIONS</b> <ol style="list-style-type: none"><li>1. Divide the cadets into pairs.</li><li>2. Explain that there will be a series of partner activities announced that the cadets will have to perform.</li><li>3. Introduce each performance:<ol style="list-style-type: none"><li>(a) <b>Tie a Pair of Shoelaces.</b> Each pair of cadets will untie the laces of the shoe closest to their partner as they stand side by side. The object is for each pair of cadets, using only one hand, to tie the shoelaces (one from each shoe) together with a standard bow.</li><li>(b) <b>Whistle in Your Hands.</b> Cup the hands tightly together to form an air-tight container, but leave a small gap in the top between the thumbs. Try to make a hollow-pitched whistle sound.</li><li>(c) <b>Tell a Joke.</b> No matter how long or short, funny or not, pass on an <b>appropriate</b> joke to the other cadet.</li><li>(d) <b>Let Me Show You.</b> Each cadet will present a skill or talent they choose to their partner (eg, curl of the tongue, a yoga move, etc).</li><li>(e) <b>Body Gym.</b> Each pair takes turns showing and teaching the other how to do something completely bizarre with their bodies.</li></ol></li><li>4. Call out a performance and have each pair of cadets perform it. Continue calling out different performances.</li></ol>	
<b>SAFETY</b> N/A.	
<b>REFERENCE</b> (ISBN 0-934387-05-2) Collard, M. (2005). <i>No Props: Great Games With No Equipment.</i> (pp. 44–45). Beverly, MA: Project Adventure, Inc.	



<b>TEAM-BUILDING ACTIVITY</b>	<b>ENERGIZER</b>
<b>FOUR UP</b>	<b>TIME:</b> 10 min
<b>RESOURCES</b> A large, open space free from obstacles.	
<b>ACTIVITY LAYOUT</b> N/A.	
<b>ACTIVITY INSTRUCTIONS</b> <ol style="list-style-type: none"><li>1. Have the group sit on the ground, with space between each cadet.</li><li>2. Explain to the cadets that anyone can stand up when they would like to, but no one can remain standing for longer than five seconds before they sit again.</li><li>3. Once some cadets begin to stand, tell them that the goal is to have exactly four people standing up at all times.</li></ol>	
<b>SAFETY</b> N/A.	
<b>REFERENCE</b> (ISBN 0-934387-05-2) Collard, M. (2005). <i>No Props: Great Games With No Equipment</i> . (p. 172). Beverly, MA: Project Adventure, Inc.	

<b>TEAM-BUILDING ACTIVITY</b>	<b>ENERGIZER</b>
<b>YURT CIRCLE</b>	<b>TIME:</b> 10 min
<b>RESOURCES</b> A large, open space with a non-slip surface.	
<b>ACTIVITY LAYOUT</b> N/A.	
<b>ACTIVITY INSTRUCTIONS</b> <ol style="list-style-type: none"><li>1. Have the cadets form a circle and grasp the hands or wrists of their neighbours.</li><li>2. Have the cadets move back and stretch out the circle without letting go (not to the full extent of the arms).</li><li>3. With everyone's feet together and planted on the ground, instruct everyone to lean backwards.</li><li>4. Encourage the cadets to adjust the position of their feet if they are uncomfortable.</li><li>5. Try to get everyone to fully support each other's weight. This may take a few tries!</li></ol>	
<b>SAFETY</b> Ensure cadets look out for the safety of each other so they do not fall backwards.	
<b>REFERENCE</b> (ISBN 0-934387-05-2) Collard, M. (2005). <i>No Props: Great Games With No Equipment</i> . (pp. 91 and 92). Beverly, MA: Project Adventure, Inc.	

<b>TEAM-BUILDING ACTIVITY</b>	<b>ENERGIZER</b>
<b>HOOP RELAY</b>	<b>TIME: 10 min</b>
<b>RESOURCES</b> <ul style="list-style-type: none"><li>• A large, open space free from obstacles, and</li><li>• Hula hoops (four).</li></ul>	
<b>ACTIVITY LAYOUT</b> <p>N/A.</p>	
<b>ACTIVITY INSTRUCTIONS</b> <ol style="list-style-type: none"><li>1. Have the cadets form a single file, one behind the other.</li><li>2. Have the cadets hold hands front-to-back by reaching backward through their legs to grasp the free hand of the person behind them.</li><li>3. Designate one cadet to be the “starter”. Have the “starter” stand in front of the line, holding four hula hoops.</li><li>4. Explain that when signalled to begin the game, the “starter” will place one of the hula hoops over the head of the first person in line. The cadets will have to try to have the hula hoop travel from cadet to cadet. When the first hoop reaches the third person in line, the “starter” may add another hoop, and so on. If the “starter” wishes to be part of the game, they can simply start the last hoop and become the first person in line.</li><li>5. Signal to begin the game.</li><li>6. When the first hoop reaches the last cadet in the line, they will run to the front of the line with the hoop, grab the hand of the now second cadet and start to move the hoop to the end of the line.</li><li>7. Continue until the original front cadet returns to their original position.</li></ol>	
<b>SAFETY</b> <p>N/A.</p>	
<b>REFERENCE</b> <p>(ISBN 0-8403-5682-X) Rohnke, K. (1984). <i>Silver Bullets: A Guide to Initiative Problems, Adventure Games and Trust Activities</i>. (p. 61). Dubuque, IA: Kendall/Hunt Publishing Company.</p>	



*K .Rohnke, Silver Bullets: A Guide to Initiative Problems, Adventure Games and Trust Activities, Kendall/Hunt Publishing Company (p. 61)*

Figure 3O-1 Hoop Relay

<b>TEAM-BUILDING ACTIVITY</b>	<b>ENERGIZER</b>
<b>ALL ABOARD</b>	<b>TIME: 10 min</b>
<b>RESOURCES</b> <ul style="list-style-type: none"><li>• A large, open space free from obstacles,</li><li>• Balloons of varying colours (two per cadet), and</li><li>• Markers (one per group).</li></ul>	
<b>ACTIVITY LAYOUT</b> <p>N/A.</p>	
<b>ACTIVITY INSTRUCTIONS</b> <ol style="list-style-type: none"><li>1. Divide the cadets into groups of four.</li><li>2. Distribute deflated balloons of varying colours around the space.</li><li>3. Have each group get into train formation (together in single file) and give the first person in each line, the “engine”, a marker.</li><li>4. Explain to the cadets that each group is a passenger “train” that must pick up “passengers”, balloons, two per person. Each person in the train will be a “car”.</li><li>5. Balloons become “passengers” when they are inflated and have a face. One cadet must inflate the balloon, tie it and paint a face on it with the marker.</li><li>6. Each train must move around together and pick up “passengers”. “Passengers” must be the same colour and everyone must be carrying two. The train must stay still while a cadet is inflating and drawing. The objective is for each train to have all “passengers” that are the same colour.</li><li>7. The first “train” to reach the destination point with all “passengers” accounted for (two balloons per cadet) wins the game.</li></ol>	
<b>SAFETY</b> <p>N/A.</p>	
<b>REFERENCE</b> <p>(ISBN 0-07-134984-7) West, E. (1999). <i>The Big Book of Icebreakers</i>. (pp. 135–136). New York, NY: McGraw-Hill.</p>	

<b>TEAM-BUILDING ACTIVITY</b>	<b>ENERGIZER</b>
<b>LINE UP</b>	<b>TIME: 10 min</b>
<b>RESOURCES</b> A large, open space free from obstacles.	
<b>ACTIVITY LAYOUT</b> N/A.	
<b>ACTIVITY INSTRUCTIONS</b> 1. Explain to the cadets that instructions will be given for them to line up in a particular way. 2. Once lined up, the group must sit at the same time, to indicate that they are finished. 3. Possible categories include: (a) order of shoe size; (b) alphabetically by favourite colour; (c) order by the number of siblings each cadet has; (d) order by age, youngest to oldest; (e) order by hair colour, lightest to darkest; (f) alphabetically by first name; and (g) alphabetically by last name.	
<b>SAFETY</b> N/A.	
<b>REFERENCE</b> (ISBN 0-07-134984-7) West, E. (1999). <i>The Big Book of Icebreakers</i> . (pp. 87–89). New York, NY: McGraw-Hill.	

<b>TEAM-BUILDING ACTIVITY</b>	<b>ENERGIZER</b>
<b>PICK POCKET</b>	<b>TIME: 10 min</b>
<b>RESOURCES</b> <ul style="list-style-type: none"><li>• Pick Pocket Activity Sheet (one per group),</li><li>• Scissors,</li><li>• Pens/pencils (one per group), and</li><li>• Stopwatch.</li></ul>	
<b>ACTIVITY LAYOUT</b> <p>Photocopy and cut the survey.</p>	
<b>ACTIVITY INSTRUCTIONS</b> <ol style="list-style-type: none"><li>1. Divide the cadets into two groups.</li><li>2. Explain to the cadets that they will have five minutes to try and find as many items on the Pick Pocket Activity Sheet as possible.</li><li>3. Distribute a Pick Pocket Activity Sheet to each group.</li><li>4. Start the activity.</li><li>5. Once five minutes have passed, bring the cadets back to one area and compare which items were found by each group.</li></ol>	
<b>SAFETY</b> <p>N/A.</p>	
<b>REFERENCE</b> <p>(ISBN 0-07-134984-7) West, E. (1999). <i>The Big Book of Icebreakers</i>. (pp. 53–55). New York, NY: McGraw-Hill.</p>	

**PICK POCKET ACTIVITY SHEET**

- \_\_\_\_\_ A purple pen,
- \_\_\_\_\_ A piece of gum,
- \_\_\_\_\_ A pair of sunglasses,
- \_\_\_\_\_ A comb,
- \_\_\_\_\_ A padlock key,
- \_\_\_\_\_ A bobby pin,
- \_\_\_\_\_ A picture of a friend or relative,
- \_\_\_\_\_ Money,
- \_\_\_\_\_ A bank card, and
- \_\_\_\_\_ A mint.

**PICK POCKET ACTIVITY SHEET**

- \_\_\_\_\_ A purple pen,
- \_\_\_\_\_ A piece of gum,
- \_\_\_\_\_ A pair of sunglasses,
- \_\_\_\_\_ A comb,
- \_\_\_\_\_ A padlock key,
- \_\_\_\_\_ A bobby pin,
- \_\_\_\_\_ A picture of a friend or relative,
- \_\_\_\_\_ Money,
- \_\_\_\_\_ A bank card, and
- \_\_\_\_\_ A mint.

**PICK POCKET ACTIVITY SHEET**

- \_\_\_\_\_ A purple pen,
- \_\_\_\_\_ A piece of gum,
- \_\_\_\_\_ A pair of sunglasses,
- \_\_\_\_\_ A comb,
- \_\_\_\_\_ A padlock key,
- \_\_\_\_\_ A bobby pin,
- \_\_\_\_\_ A picture of a friend or relative,
- \_\_\_\_\_ Money,
- \_\_\_\_\_ A bank card, and
- \_\_\_\_\_ A mint.



<b>TEAM-BUILDING ACTIVITY</b>	<b>ENERGIZER</b>
<b>ABOUT NOW</b>	<b>TIME:</b> 10 min
<b>RESOURCES</b> <ul style="list-style-type: none"><li>• A large, open space free from obstacles, and</li><li>• Stopwatch.</li></ul>	
<b>ACTIVITY LAYOUT</b> <p>N/A.</p>	
<b>ACTIVITY INSTRUCTIONS</b> <ol style="list-style-type: none"><li>1. Gather the group in an area.</li><li>2. Explain to the group that on the command “Now” everyone will try to count 60 seconds in their head and then sit. There is to be no talking and the cadets cannot look at their watches.</li><li>3. While looking at the stopwatch, yell “Now” to signal the cadets to begin.</li><li>4. Note the cadet who sits down closest to the 60 second time frame.</li><li>5. When all cadets are sitting, announce who was the closest.</li><li>6. Repeat the activity.</li></ol>	
<b>SAFETY</b> <p>N/A.</p>	
<b>REFERENCE</b> <p>(ISBN 0-934387-05-2) Collard, M. (2005). <i>No Props: Great Games With No Equipment</i>. (p. 148). Beverly, MA: Project Adventure, Inc.</p>	

<b>TEAM-BUILDING ACTIVITY</b>	<b>ENERGIZER</b>
<b>MASS STAND UP</b>	<b>TIME:</b> 10 min
<b>RESOURCES</b> A large, open space free from obstacles.	
<b>ACTIVITY LAYOUT</b> N/A.	
<b>ACTIVITY INSTRUCTIONS</b> <ol style="list-style-type: none"><li>1. Divide the cadets into two equal groups.</li><li>2. Have each group sit in a circle, with their backs to the middle.</li><li>3. Have the cadets in each group link elbows with the cadets sitting on either side of them.</li><li>4. Explain that on the command “Go” everyone will try to stand up as one.</li><li>5. Give the command “Go.” This activity may require a lot of encouragement and many tries.</li></ol>	
<b>SAFETY</b> N/A.	
<b>REFERENCE</b> (ISBN 0-8403-5682-X) Rohnke, K. (1984). <i>Silver Bullets: A Guide to Initiative Problems, Adventure Games and Trust Activities</i> . (p. 100). Dubuque, IA: Kendall/Hunt Publishing Company.	

<b>TEAM-BUILDING ACTIVITY</b>	<b>ENERGIZER</b>
<b>WORD PUZZLE</b>	<b>TIME: 10 min</b>
<b>RESOURCES</b> <ul style="list-style-type: none"><li>• A large space,</li><li>• Word puzzle sheet (one per cadet),</li><li>• Pens/pencils (one per cadet), and</li><li>• Stopwatch.</li></ul>	
<b>ACTIVITY LAYOUT</b> <p>Photocopy a word puzzle sheet for every cadet.</p>	
<b>ACTIVITY INSTRUCTIONS</b> <ol style="list-style-type: none"><li>1. Distribute a word puzzle sheet and a pen/pencil to each cadet.</li><li>2. Explain to the cadets that they have three minutes to try and complete as many word puzzles as possible.</li><li>3. After three minutes, have the cadets form groups of three. Among the three cadets, encourage them to come up with as many answers as possible.</li><li>4. Share the word puzzle answers with the cadets.</li></ol>	
<b>SAFETY</b> <p>N/A.</p>	
<b>REFERENCE</b> <p>(ISBN 0-07-046414-6) Scannel, E., &amp; Newstrom, J. (1994). <i>Even More Games Trainers Play</i>. (pp. 137–177). New York, NY: McGraw-Hill Companies.</p>	

WORD PUZZLE

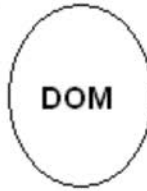
<p>1</p> 	<p>2</p> <p>NE1410S</p>	<p>3</p> <p>CYCLE CYCLE CYCLE</p>	<p>4</p> 
<p>5</p> <p>Jan. Feb. Mar. ----- DUE</p>	<p>6</p> 	<p>7</p> <p>HEAD LO VE HEELS</p>	<p>8</p> 
<p>9</p> <p>L Bus Term L</p>	<p>10</p> <p>BAN ANA</p>	<p>11</p> <p>T K The R C A</p>	<p>12</p> <p>BACK CK K</p>
<p>13</p> <p>LAL</p>	<p>14</p> <p>I'm nhappy</p>	<p>15</p> <p>ME QUIT</p>	<p>16</p> 
<p>17</p> <p>S P L I T</p>	<p>18</p> <p>PETS A</p>	<p>19</p> <p>CITY <small>Life</small></p>	<p>20</p> <p>YOU / JUST / ME</p>

### WORD PUZZLE ANSWERS

1. A tall tale.
2. Anyone for tennis?
3. Tricycle.
4. Curve ball.
5. Three months overdue.
6. Hole in one.
7. Head over heels in love.
8. Type written.
9. Bus terminals.
10. Banana split.
11. The inside track.
12. Full back, half back, quarterback.
13. All mixed up.
14. I'm unhappy without you.
15. Quit following me.
16. Domino.
17. Split down the middle.
18. A step backwards.
19. Life in the big city.
20. Just between you and me.

<b>TEAM-BUILDING ACTIVITY</b>	<b>ICEBREAKER</b>
<b>CATEGORIES</b>	<b>TIME:</b> 10 min
<b>RESOURCES</b> A large, open space free from obstacles.	
<b>ACTIVITY LAYOUT</b> N/A.	
<b>ACTIVITY INSTRUCTIONS</b> <ol style="list-style-type: none"><li>1. Have the group gather.</li><li>2. Explain to the group that they will separate and regroup according to the categories announced.</li><li>3. Announce a category. Possible categories include:<ol style="list-style-type: none"><li>(a) number of siblings,</li><li>(b) last digit in home telephone number,</li><li>(c) position of thumbs when hands are clasped (eg, left over right or right over left),</li><li>(d) month of birth,</li><li>(e) colour of eyes,</li><li>(f) colour of hair,</li><li>(g) type of breakfast ate this morning,</li><li>(h) favourite hot or cold drink, and</li><li>(i) distance travelled to get here.</li></ol></li><li>4. Once groups are formed, announce another category. Continue announcing categories until the time has lapsed.</li></ol>	
<b>SAFETY</b> N/A.	
<b>REFERENCE</b> (ISBN 0-934387-05-2) Collard, M. (2005). <i>No Props: Great Games With No Equipment</i> . (pp. 31–32). Beverly, MA: Project Adventure, Inc.	

<b>TEAM-BUILDING ACTIVITY</b>	<b>ICEBREAKER</b>
<b>HUMAN SCAVENGER HUNT</b>	<b>TIME: 10 min</b>
<b>RESOURCES</b> A large, open space free from obstacles.	
<b>ACTIVITY LAYOUT</b> Create a list of scavenger hunt items if other choices than those listed are preferred.	
<b>ACTIVITY INSTRUCTIONS</b> <ol style="list-style-type: none"><li>1. Have the group stand or sit together.</li><li>2. Read a point from the human scavenger hunt. The team must send a cadet to the front who fits the description. For example, if the leader says “Two cadets who have the same middle name,” members must talk and find out if there are two cadets in the group who fit the description and then quickly send those cadets to the leader.</li><li>3. The human scavenger hunt could consist of:<ol style="list-style-type: none"><li>(a) Two cadets who have the same first and last initials.</li><li>(b) The cadet in the group who was born the furthest away.</li><li>(c) Two cadets with the same middle name.</li><li>(d) A group of cadets whose ages add up to 40.</li><li>(e) Two cadets who were born on the same date (eg, June 14<sup>th</sup> and September 14<sup>th</sup>)</li><li>(f) Two cadets who were born in the same month.</li><li>(g) A group of cadets whose shoe sizes add up to 30.</li><li>(h) The cadet who lives the closest to here.</li><li>(i) A group of cadets who can spell a word by putting together the first letters of their first names.</li><li>(j) A group of three cadets who all have different coloured eyes.</li></ol></li></ol>	
<b>SAFETY</b> N/A.	
<b>REFERENCE</b> (ISBN 0-9662341-6-2) Jones, A. (1999). <i>Team-Building Activities for Every Group</i> . (pp. 18–19). Richland, WA: Rec Room Publishing.	

<b>TEAM-BUILDING ACTIVITY</b>	<b>ICEBREAKER</b>
<b>THE WALKING BILLBOARD</b>	<b>TIME:</b> 10 min
<b>RESOURCES</b> <ul style="list-style-type: none"><li>• A large, open space free from obstacles,</li><li>• Flip chart paper (one sheet per cadet),</li><li>• Markers (one per cadet), and</li><li>• Masking tape (one roll).</li></ul>	
<b>ACTIVITY LAYOUT</b> <p>N/A.</p>	
<b>ACTIVITY INSTRUCTIONS</b> <ol style="list-style-type: none"><li>1. Distribute a piece of flip chart paper and a marker to each cadet. Get all the cadets to place their first and last names at the top.</li><li>2. Write and post the following questions on a piece of flip chart paper:<ol style="list-style-type: none"><li>(a) What is your favourite food?</li><li>(b) What is your biggest pet peeve?</li><li>(c) What is your all-time favourite movie?</li><li>(d) What is your dream job?</li></ol></li><li>3. Allow time for each cadet to write their answers on their piece of flip chart paper.</li><li>4. Using masking tape, have the cadets help each other attach the flip chart paper to the writer's shoulders, to look like a "walking billboard".</li></ol>	
<b>SAFETY</b> <p>N/A.</p>	
<b>REFERENCE</b> <p>(ISBN 0-07-046501-0) Scannel, E., &amp; Newstrom, J. (1998). <i>The Big Book of Presentation Games</i>. (pp. 125–126). New York, NY: McGraw-Hill.</p>	



<b>TEAM-BUILDING ACTIVITY</b>	<b>ICEBREAKER</b>
<b>GETTING ACQUAINTED</b>	<b>TIME: 10 min</b>
<b>RESOURCES</b> <ul style="list-style-type: none"><li>• A large, open space,</li><li>• Large sticky notes (one per cadet), and</li><li>• Pens/pencils (one per cadet).</li></ul>	
<b>ACTIVITY LAYOUT</b> <p>N/A.</p>	
<b>ACTIVITY INSTRUCTIONS</b> <ol style="list-style-type: none"><li>1. Distribute a large sticky note and a pen/pencil to each cadet.</li><li>2. Have each cadet write their first and last names on their sticky note.</li><li>3. Allow two or three minutes for each cadet to write down two words or brief phrases that tell something about themselves and can be used as conversation starters (eg, hometown, hobby, quirk, etc).</li><li>4. Have the cadets start to mingle and form groups of two or three and discuss their words or phrases with other cadets.</li><li>5. Once a few minutes have passed, tell the cadets to switch groups while encouraging them to meet and mingle with as many cadets as possible.</li></ol>	
<b>SAFETY</b> <p>N/A.</p>	
<b>REFERENCE</b> <p>(ISBN 0-07-046501-0) Scannel, E., &amp; Newstrom, J. (1998). <i>The Big Book of Presentation Games</i>. (pp. 23–24). New York, NY: McGraw-Hill.</p>	

<b>TEAM-BUILDING ACTIVITY</b>	<b>ICEBREAKER</b>
<b>BINGO BLAST</b>	<b>TIME: 10 min</b>
<b>RESOURCES</b> <ul style="list-style-type: none"><li>• A large, open space,</li><li>• Bingo Blast cards (one per cadet), and</li><li>• Pens/pencils (one per cadet).</li></ul>	
<b>ACTIVITY LAYOUT</b> <p>Photocopy a Bingo Blast card for each cadet.</p>	
<b>ACTIVITY INSTRUCTIONS</b> <ol style="list-style-type: none"><li>1. Distribute a bingo card and a pen/pencil to each cadet.</li><li>2. Allow five minutes for the cadets to roam around the area trying to find a person to fit each description on the card. Once a person is found, that cadet will sign their name on the bingo card. Encourage the cadets to try to fill out the complete card.</li><li>3. Once time is up, have the cadets gather in one area and sit.</li><li>4. Read the descriptions out loud and see who fits each description.</li></ol>	
<b>SAFETY</b> <p>N/A.</p>	
<b>REFERENCE</b> <p>(ISBN 0-07-046501-0) Scannel, E., &amp; Newstrom, J. (1998). <i>The Big Book of Presentation Games</i>. (pp. 28–29). New York, NY: McGraw-Hill.</p>	

**BINGO BLAST**

PLAYS TENNIS  _____	HAS TRAVELLED OUTSIDE OF CANADA  _____	SPEAKS TWO LANGUAGES  _____	HAS BROWN EYES  _____	HAS AN OLDER BROTHER  _____
HAS BROKEN A BONE  _____	HATES BRUSSELS SPROUTS  _____	HAS RED HAIR  _____	HAS A PET FISH  _____	PLAYS AN INSTRUMENT  _____
HAS NEVER BEEN TO A CSTC BEFORE  _____	HAS CANOED  _____	<b>FREE</b>	HAS HAD A CAVITY  _____	LOVES PICKLES  _____
CAN SWIM  _____	HAS A PET DOG  _____	HAS BLUE EYES  _____	HAS THEIR TOENAILS PAINTED  _____	PLAYS VOLLEYBALL  _____
HAS BLONDE HAIR  _____	LIKES MATH  _____	HAS A BIRTHDAY DURING THE COURSE  _____	KNOWS A SET OF TWINS  _____	KNOWS HOW TO DO THE HOKEY POKEY  _____

<b>TEAM-BUILDING ACTIVITY</b>	<b>ICEBREAKER</b>
<b>TEAM CHARADES</b>	<b>TIME: 10 min</b>
<b>RESOURCES</b> A large, open space free from obstacles.	
<b>ACTIVITY LAYOUT</b> N/A.	
<b>ACTIVITY INSTRUCTIONS</b> 1. Divide the cadets into two equal groups. 2. Give each group five minutes to: (a) choose a name for the team that best represents it; and (b) discuss a set of charades or acts that they will use to try to get the others to guess their team name. 3. Allow one minute for each group to act out their group's name, while the rest of the cadets guess.	
<b>SAFETY</b> N/A.	
<b>REFERENCE</b> (ISBN 0-07-046501-0) Scannel, E., & Newstrom, J. (1998). <i>The Big Book of Presentation Games</i> . (p. 161). New York, NY: McGraw-Hill.	

<b>TEAM-BUILDING ACTIVITY</b>	<b>ICEBREAKER</b>
<b>DOUBLE TAKE</b>	<b>TIME: 10 min</b>
<b>RESOURCES</b> A large, open space free from obstacles.	
<b>ACTIVITY LAYOUT</b> N/A.	
<b>ACTIVITY INSTRUCTIONS</b> <ol style="list-style-type: none"><li>1. Have the cadets spread out in the area.</li><li>2. Have the cadets walk around shaking hands and introducing themselves to other cadets.</li><li>3. Call out a characteristic and have the cadets form groups with other cadets who share that characteristic. Some characteristics could include:<ol style="list-style-type: none"><li>(a) hair colour,</li><li>(b) eye colour,</li><li>(c) shoe size,</li><li>(d) favourite colour,</li><li>(e) favourite pizza topping,</li><li>(f) pet ownership,</li><li>(g) favourite sport, and</li><li>(h) favourite music.</li></ol></li><li>4. Encourage the cadets to form groups with different cadets as frequently as possible.</li></ol>	
<b>SAFETY</b> N/A.	
<b>REFERENCE</b> (ISBN 0-07-134984-7) West, E. (1999). <i>The Big Book of Icebreakers</i> . (pp. 25–29). New York, NY: McGraw-Hill.	

<b>TEAM-BUILDING ACTIVITY</b>	<b>ICEBREAKER</b>
<b>PECULIARITIES</b>	<b>TIME:</b> 10 min
<b>RESOURCES</b> <ul style="list-style-type: none"><li>• A large, open space,</li><li>• Peculiarities Activity Sheet (one per cadet), and</li><li>• Pens/pencils (one per cadet).</li></ul>	
<b>ACTIVITY LAYOUT</b> <p>Photocopy a Peculiarities Activity Sheet for each cadet.</p>	
<b>ACTIVITY INSTRUCTIONS</b> <ol style="list-style-type: none"><li>1. Distribute an activity sheet and a pen/pencil to each cadet.</li><li>2. Allow five minutes for the cadets to roam around the area trying to find a cadet to fit each description on the card. Once a cadet is found, have the cadet tick their peculiarity off the list and write their name next to the description. Encourage the cadets to try to tick off as many as possible.</li><li>3. Once time is up, have the cadets join in one area and sit.</li><li>4. Read the descriptions out loud and see who fits each description.</li></ol>	
<b>SAFETY</b> <p>N/A.</p>	
<b>REFERENCE</b> <p>(ISBN 0-07-134984-7) West, E. (1999). <i>The Big Book of Icebreakers</i>. (pp. 105–107). New York, NY: McGraw-Hill.</p>	

**PECULIARITIES ACTIVITY SHEET**

1. Who was born on February 29<sup>th</sup>?
2. Who has or had a dog named Spot, Midnight, Lucky, Shadow or Snoopy?
3. Who competes in sporting activities such as running, basketball, etc?
4. Who likes pizza with anchovies?
5. Who was born in a different province than the one in which they reside?
6. Who was born outside of Canada?
7. Who has been to Nunavut?
8. Who writes songs or poetry?
9. Who has a twin brother or sister?
10. Who has a shoe size greater than 10?
11. Who has milked a cow?
12. Who has been to a concert in the past three months?
13. Who has been on a radio or television show?
14. Who prefers winter to summer?

<b>TEAM-BUILDING ACTIVITY</b>	<b>ICEBREAKER</b>
<b>I LIKE ME BECAUSE</b>	<b>TIME: 10 min</b>
<b>RESOURCES</b> A large, open space free from obstacles.	
<b>ACTIVITY LAYOUT</b> N/A.	
<b>ACTIVITY INSTRUCTIONS</b> <ol style="list-style-type: none"><li>1. Divide the cadets into pairs, preferably two cadets that do not know each other well.</li><li>2. Have the pairs sit facing each other and decide who will go first and who will go second.</li><li>3. Have each pair make eye contact and sit with an open body posture (eg, do not cross arms).</li><li>4. Explain that each pair will have two minutes each to answer the question “What do I like about myself?” The partner not answering the question cannot talk but must express a keen interest in the cadet through body language.</li><li>5. Have the first cadet speak about themselves. At the end of the two minutes, have the cadets switch roles.</li></ol>	
<b>SAFETY</b> N/A.	
<b>REFERENCE</b> (ISBN 0-07-046513-4) Newstrom, J., & Scannel, E. (1998). <i>The Big Book of Team Building Games</i> . (pp. 73–74). New York, NY: McGraw-Hill.	



<b>TEAM-BUILDING ACTIVITY</b>	<b>ICEBREAKER</b>
<b>GROUP JUGGLE</b>	<b>TIME: 10 min</b>
<b>RESOURCES</b> <ul style="list-style-type: none"><li>• A large, open space free from obstacles, and</li><li>• Tennis balls (three).</li></ul>	
<b>ACTIVITY LAYOUT</b> <p>N/A.</p>	
<b>ACTIVITY INSTRUCTIONS</b> <ol style="list-style-type: none"><li>1. Have the cadets stand in a circle.</li><li>2. Start the activity using one ball. All cadets will begin the game with one arm in the air. The cadet with the ball will call out their own name and the name of the cadet to whom they are going to throw the ball they will then throw the ball to that cadet. The ball must be thrown to a cadet with their arm in the air to ensure each cadet has the opportunity to participate. Once the cadet has caught the ball they are to put their arm down.</li><li>3. Have the cadet who catches the ball say their own name, say the name of the cadet to whom they are going to throw the ball and then throw the ball to that cadet.</li><li>4. Continue the game until the cadets seem comfortable using one ball.</li><li>5. Add more balls. The rules remain the same, only that the cadets have to pay much more attention! Continue until everyone has caught a ball, then all cadets should start again with their arm in the air.</li></ol>	
<b>SAFETY</b> <p>N/A.</p>	
<b>REFERENCE</b> <p>(ISBN 0-07-059532-1) Snow, H. (1997). <i>Indoor/Outdoor Team-Building Games for Trainers</i>. (p. 109). New York, NY: McGraw-Hill Companies, Inc.</p>	

<b>TEAM-BUILDING ACTIVITY</b>	<b>ICEBREAKER</b>
<b>MEET 'N GREET</b>	<b>TIME: 10 min</b>
<b>RESOURCES</b> A large, open space free from obstacles.	
<b>ACTIVITY LAYOUT</b> N/A.	
<b>ACTIVITY INSTRUCTIONS</b> <ol style="list-style-type: none"><li>1. Divide the cadets into groups of three or four.</li><li>2. Allow two minutes for each group to find three distinctive things that all of the cadets have in common. The only rule is that the three distinctive things cannot be related to the Cadet Program (eg, won the marksmanship team or received an award at the Annual Ceremonial Review). Some examples could be:<ol style="list-style-type: none"><li>(a) all are from the same province;</li><li>(b) all have an older brother; and</li><li>(c) all grew up in a single parent home.</li></ol></li><li>3. Once all groups have completed Step 2., have the cadets regroup and share the three commonalities with the remainder of the cadets.</li><li>4. If time remains, complete the activity again with different groups.</li></ol>	
<b>SAFETY</b> N/A.	
<b>REFERENCE</b> (ISBN 0-07-046414-6) Newstrom, J. (1994). <i>Even More Games Trainers Play</i> . (p. 11). New York, NY: McGraw-Hill Companies.	

<b>TEAM-BUILDING ACTIVITY</b>	<b>ICEBREAKER</b>
<b>WHO ARE YOU?</b>	<b>TIME:</b> 10 min
<b>RESOURCES</b> <ul style="list-style-type: none"><li>• A large, open space,</li><li>• Index cards (one per cadet), and</li><li>• Pens/pencils (one per cadet).</li></ul>	
<b>ACTIVITY LAYOUT</b> <p>N/A.</p>	
<b>ACTIVITY INSTRUCTIONS</b> <ol style="list-style-type: none"><li>1. Distribute an index card and a pen/pencil to each cadet.</li><li>2. Have each cadet write down one thing about themselves that they do not think anyone else would know.</li><li>3. Collect all the cards and shuffle them. Randomly distribute one card to each cadet.</li><li>4. Allow five minutes for the cadets to circulate the room and ask questions to the other cadets to try to find out whose card they have.</li><li>5. Have each cadet sit after they have found the person whose card they have and when the cadet with their card locates them.</li></ol>	
<b>SAFETY</b> <p>N/A.</p>	
<b>REFERENCE</b> <p>(ISBN 0-07-046501-0) Scannel, E., &amp; Newstrom, J. (1998). <i>The Big Book of Presentation Games</i>. (pp. 23–24). New York, NY: McGraw-Hill.</p>	

<b>TEAM-BUILDING ACTIVITY</b>	<b>ICEBREAKER</b>
<b>BIRTHDAY LINE</b>	<b>TIME: 10 min</b>
<b>RESOURCES</b> <ul style="list-style-type: none"><li>• A large, open space free from obstacles, and</li><li>• Tape/rope (approximately 10 m [32 feet]).</li></ul>	
<b>ACTIVITY LAYOUT</b> <ul style="list-style-type: none"><li>• If using tape, tape two parallel lines 50 cm (20 inches) apart, each approximately 5 m (16 feet) long on the floor.</li><li>• If using rope, place two parallel lines 50 cm (20 inches) apart, each approximately 5 m (16 feet) long on the ground.</li></ul>	
<b>ACTIVITY INSTRUCTIONS</b> <ol style="list-style-type: none"><li>1. Have all the cadets stand side by side inside the two lines, without their feet touching them.</li><li>2. Tell the cadets to organize themselves in order of birthday without stepping outside or on the lines.</li><li>3. If completed quickly, have the cadets organize themselves again using different criteria (eg, height, shoe size, hair colour).</li></ol>	
<b>SAFETY</b> <p>N/A.</p>	
<b>REFERENCE</b> <p>(ISBN 0-07-059532-1) Snow, H. (1997). <i>Indoor/Outdoor Team-Building Games for Trainers</i>. (p. 57). New York, NY: McGraw-Hill Companies, Inc.</p>	

<b>TEAM-BUILDING ACTIVITY</b>	<b>ICEBREAKER</b>
<b>A COAT OF ARMS</b>	<b>TIME:</b> 10 min
<b>RESOURCES</b> <ul style="list-style-type: none"><li>• A large, open space,</li><li>• Coat of arms template (one per cadet),</li><li>• Pens/pencils (one per cadet).</li></ul>	
<b>ACTIVITY LAYOUT</b> <p>Photocopy a coat of arms template for each cadet.</p>	
<b>ACTIVITY INSTRUCTIONS</b> <ol style="list-style-type: none"><li>1. Distribute a coat of arms template and a pen/pencil to each cadet.</li><li>2. Have the cadets fill in their coat of arms by reading the following aloud, one at a time:<ol style="list-style-type: none"><li>(a) In Space 1, draw something that characterizes a recent peak performance.</li><li>(b) In Space 2, sketch something about yourself that very few people know about.</li><li>(c) In Space 3, draw a symbol of how you like to spend your free time.</li><li>(d) In Space 4, represent something that you are very good at.</li><li>(e) In Space 5, write or draw something that could be your personal motto.</li></ol></li><li>3. When complete, use the remaining the time for the cadets to mingle with others to share their coat of arms.</li></ol>	
<b>SAFETY</b> <p>N/A.</p>	
<b>REFERENCE</b> <p>(ISBN 0-07-046513-4) Newstrom, J., &amp; Scannel, E. (1998). <i>The Big Book of Team Building Games</i>. (pp. 77–79). New York, NY: McGraw-Hill.</p>	

COAT OF ARMS TEMPLATE

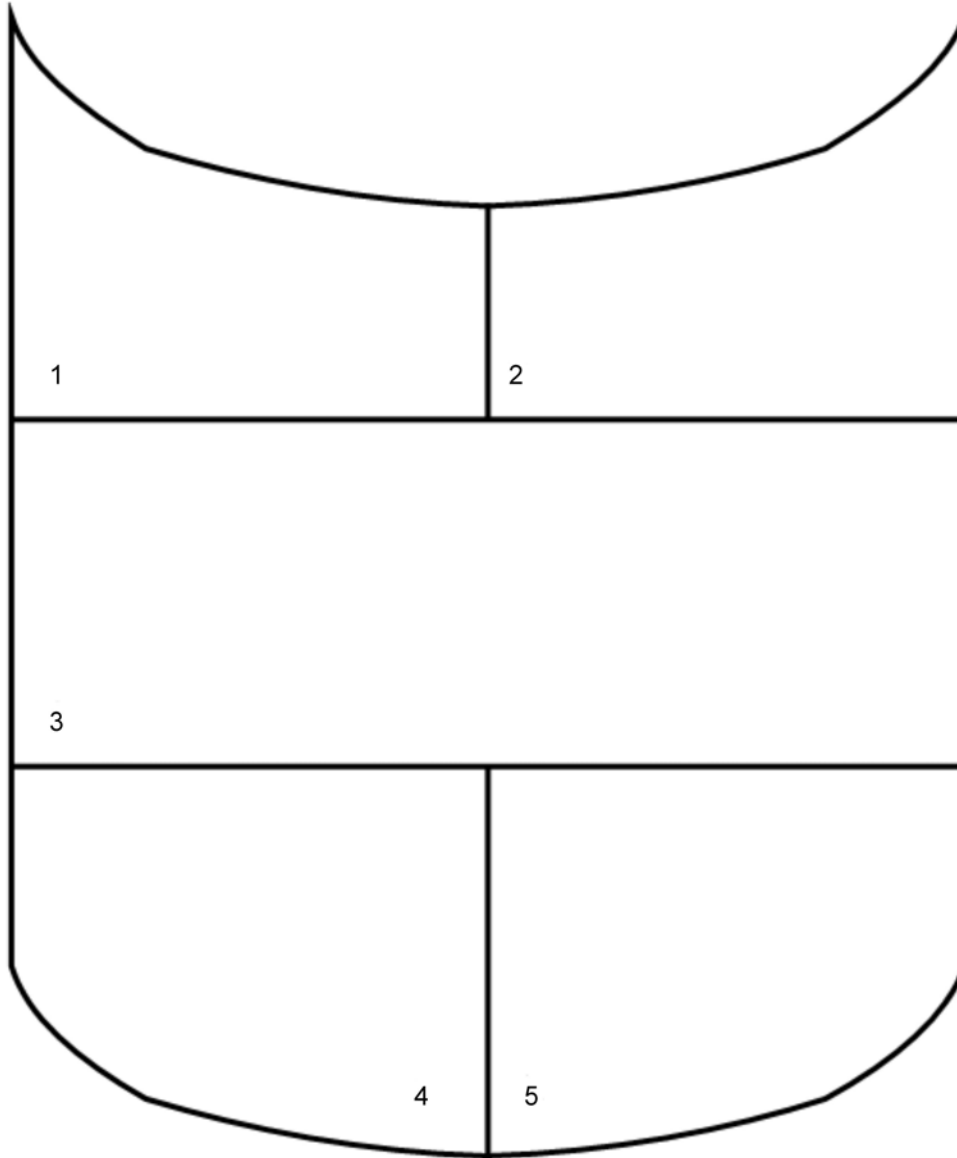

*J. Newstrom & E. Scannel, The Big Book of Team Building Games, McGraw-Hill (p. 79)*

Figure 3O-2 Coat of Arms Template

<b>TEAM-BUILDING ACTIVITY</b>	<b>ICEBREAKER</b>
<b>MARTIAN NAMES</b>	<b>TIME: 10 min</b>
<b>RESOURCES</b> <ul style="list-style-type: none"><li>• A large, open space,</li><li>• Paper (one piece per cadet), and</li><li>• Pens/pencils (one per cadet).</li></ul>	
<b>ACTIVITY LAYOUT</b> <p>Prepare your Martian name and meaning on a piece of paper.</p>	
<b>ACTIVITY INSTRUCTIONS</b> <ol style="list-style-type: none"><li>1. Tell the following story: “Imagine you have just landed on Mars and need to introduce yourself to your Martian tour guide. Language on Mars is the complete reverse of ours. This means you must change your name so it is backward: last name first, first name last and both spelled backward, letter by letter. In addition, every name on Mars means something special and relates to the person who has that name. On your sheet of paper, write your name as it would appear on Mars. Practice pronouncing it. Think about what your Martian name means and be prepared to share it with the group.”</li><li>2. Show the cadets your Martian name and meaning. For example, Sarah Jones becomes “Senoj Haras,” which means “enjoys taking long trips and hiking with my friends” or Joshua Carew becomes “Werac Auhsoj,” which means “warrior of the desert.”</li><li>3. Distribute a piece of paper and a pen/pencil to each cadet and allow two minutes for the cadets to complete their Martian names.</li><li>4. Have the cadets share their Martian names with the group.</li></ol>	
<b>SAFETY</b> <p>N/A.</p>	
<b>REFERENCE</b> <p>(ISBN 1-57542-265-4) MacGregor, M. (2008). <i>Teambuilding With Teens: Activities for Leadership, Decision Making and Group Success</i>. (pp. 8–9). Minneapolis, MN: Free Spirit Publishing, Inc.</p>	

THIS PAGE INTENTIONALLY LEFT BLANK



**COMMUNICATION, PROBLEM-SOLVING AND TRUST-BUILDING**

**LIST OF ACTIVITIES FOR ANNEX P**

Title	Page Number	
<b>COMMUNICATION</b>	Snowflake	3P-2
	Back-to-Back	3P-3
	Group Construction	3P-6
	Where Do I Go?	3P-7
	Missing Bucket	3P-8
	Charade Line	3P-9
	The Rock	3P-11
	King/Queen Frog	3P-12
	Mute Lineup	3P-13
	Marriage	3P-14
	That Ain't Me!	3P-15
	Blind Shapes	3P-16
	Wink	3P-17
	Minefield	3P-18
	Categories Twist	3P-19
	Negotiation	3P-20
<b>PROBLEM-SOLVING</b>	Magic Carpet	3P-21
	Raft	3P-22
	Moonwalk	3P-23
	Balance Beam	3P-24
	Group Search	3P-26
	Traffic Jam	3P-27
	Circle Wars	3P-29
	Untying Knots	3P-30
	Stepping Stones	3P-31
	Swamp Trail	3P-32
	Human Knot	3P-34
	Circle Clap	3P-35
	Quick Shuffle	3P-36
	Tall Tower	3P-37
	Swamp Crossing	3P-38
	Water Transfer	3P-40
<b>TRUST-BUILDING</b>	Egg Construction	3P-41
	Water Carry	3P-42
	Crazy Maze	3P-44
	Everybody Up	3P-45
	Slice & Dice	3P-46
	Hog Call	3P-48
	Hug a Tree	3P-49
	Blindfold Build	3P-50
	Lighthouse	3P-51
	Trust Tag	3P-52

<b>TEAM-BUILDING ACTIVITY</b>	<b>COMMUNICATION</b>
<b>SNOWFLAKE</b>	<b>TIME:</b> 15 min
<b>RESOURCES</b> 8-1/2 x 11 inch sheet of white paper (one per cadet).	
<b>ACTIVITY LAYOUT</b> N/A.	
<b>ACTIVITY INSTRUCTIONS</b> <ol style="list-style-type: none"><li>1. Distribute a piece of paper to each cadet.</li><li>2. Explain that the cadets are to individually follow the directions you are about to give without asking questions or seeking clarification.</li><li>3. Give the following directions quickly, with no clarification:<ol style="list-style-type: none"><li>(a) Fold the paper in half and tear off a top corner.</li><li>(b) Fold it in half again and tear off the top corner.</li><li>(c) Fold it in half again and tear off the left corner.</li><li>(d) Rotate the paper to the right three times and tear off the bottom corner.</li><li>(e) Fold it in half again and tear off the middle piece.</li></ol></li><li>4. Instruct the group to unfold their papers and compare their snowflakes with those around them. They will find that their snowflakes may or may not match others depending on how the instructions were understood.</li></ol>	
<b>SAFETY</b> N/A.	
<b>REFERENCE</b> (ISBN 1-57542-265-4) MacGregor, M. G. (2008). <i>Team-Building With Teens</i> . (pp. 67–68). Minneapolis, MN: Free Spirit Publishing Inc.	

<b>TEAM-BUILDING ACTIVITY</b>	<b>COMMUNICATION</b>
<b>BACK-TO-BACK</b>	<b>TIME:</b> 10–15 min
<b>RESOURCES</b> <ul style="list-style-type: none"><li>• Paper,</li><li>• Pens/pencils (one per group), and</li><li>• Drawings (two per group).</li></ul>	
<b>ACTIVITY LAYOUT</b> <p>Photocopy both drawings for each group.</p>	
<b>ACTIVITY INSTRUCTIONS</b> <ol style="list-style-type: none"><li>1. Divide the cadets into pairs. Have each pair sit back to back.</li><li>2. Distribute a copy of Figure 3P-1 to one cadet from each pair. Distribute a piece of paper and pen/pencil to the other cadet.</li><li>3. On the signal to start, the cadet with the drawing is to guide their partner to draw the figure without letting them see the original. The cadets are to use symbols and metaphors to describe the drawing, but not geometrical shapes. For example, the cadet cannot say draw a square or circle.</li><li>4. Allow the cadets approximately five minutes to draw the figure. When the time is up, have the cadets compare the drawing to the original drawing.</li><li>5. Have the cadets reverse roles. Distribute a copy of Figure 3P-2 to the cadet who drew first and a piece of paper and a pen/pencil to the other cadet. Repeat Steps 3. and 4.</li></ol>	
<b>SAFETY</b> <p>N/A.</p>	
<b>REFERENCE</b> <p>(ISBN 0-07-059532-1) Snow, H. (1997). <i>Indoor/Outdoor Team-Building Games for Trainers</i>. (pp. 95–97). New York, NY: McGraw-Hill.</p>	

**DRAWING 1**

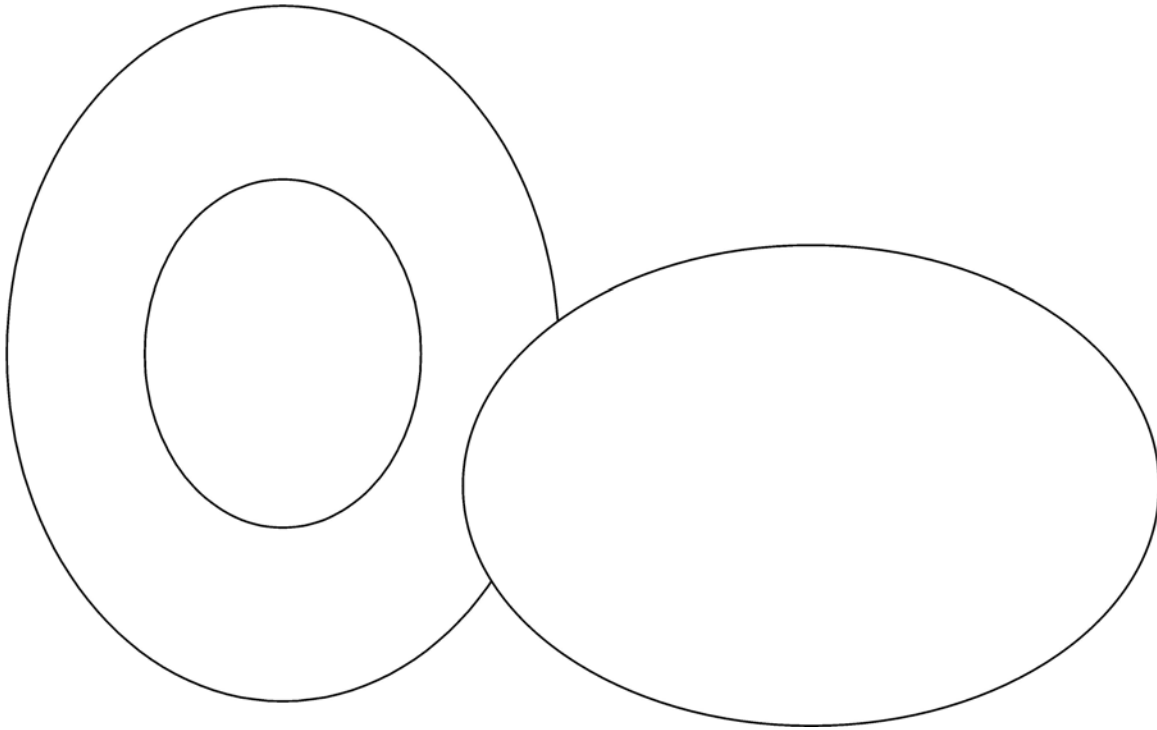

*Director Cadets 3, 2008, Ottawa, ON: Department of National Defence*

Figure 3P-1 Drawing 1

**DRAWING 2**

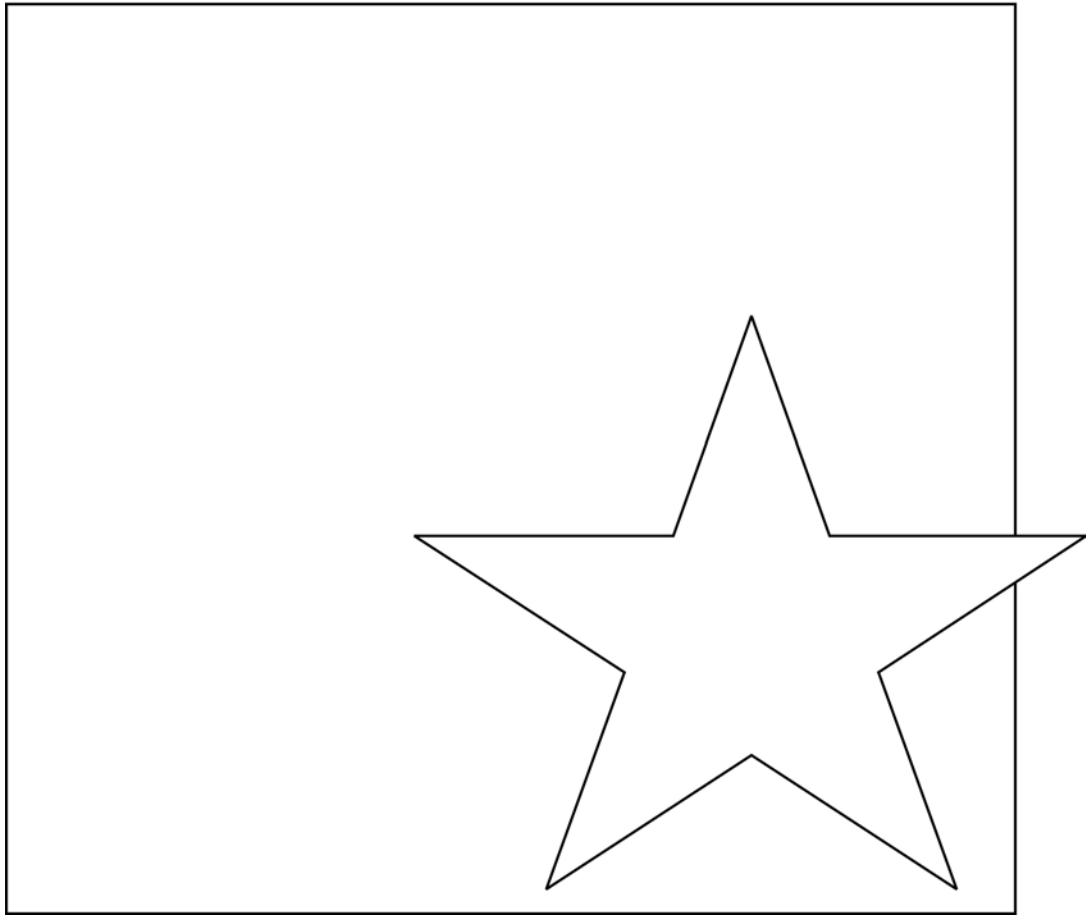

*Director Cadets 3, 2008, Ottawa, ON: Department of National Defence*

Figure 3P-2 Drawing 2

<b>TEAM-BUILDING ACTIVITY</b>	<b>COMMUNICATION</b>
<b>GROUP CONSTRUCTION</b>	<b>TIME:</b> 15 min
<b>RESOURCES</b> <ul style="list-style-type: none"><li>• A large, open space free from obstacles, and</li><li>• Toothpicks/popsicle sticks/straws (10 per cadet).</li></ul>	
<b>ACTIVITY LAYOUT</b> <p>N/A.</p>	
<b>ACTIVITY INSTRUCTIONS</b> <ol style="list-style-type: none"><li>1. Have the cadets sit in a semicircle with their backs to the centre. Ensure they are spread out enough that they cannot see the toothpicks/popsicle sticks/straws of the cadets near them.</li><li>2. Inform the cadets that they are not allowed to speak or look at the other cadets' design throughout the activity.</li><li>3. Distribute 10 toothpicks/popsicle sticks/straws to each cadet, including yourself.</li><li>4. As the "construction manager" you will build a design on the floor one toothpick/popsicle stick/straw at a time.</li><li>5. After placing each toothpick/popsicle stick/straw on the ground, verbally guide the cadets to place their toothpicks/popsicle sticks/straws in the same position.</li><li>6. When you have placed all 10 toothpicks/popsicle sticks/straws into a design, the designs of the cadets' should mimic your design.</li><li>7. Upon completion of the activity, look at the cadets' designs to see how close they are to the original.</li></ol>	
<b>SAFETY</b> <p>N/A.</p>	
<b>REFERENCE</b> <p>(ISBN 0-7360-5088-4) Midura, D. W., &amp; Glover, D. R. (2005). <i>Essentials of Team Building</i>. (p. 54). Champaign, IL: Human Kinetics.</p>	

<b>TEAM-BUILDING ACTIVITY</b>	<b>COMMUNICATION</b>
<b>WHERE DO I GO?</b>	<b>TIME:</b> 10–15 min
<b>RESOURCES</b> <ul style="list-style-type: none"><li>• A large, open space free from obstacles,</li><li>• Two small objects (eg, coins, paper clips, toothpicks, etc), and</li><li>• Blindfold.</li></ul>	
<b>ACTIVITY LAYOUT</b> <p>N/A.</p>	
<b>ACTIVITY INSTRUCTIONS</b> <ol style="list-style-type: none"><li>1. Ask one cadet to volunteer to go first in the activity.</li><li>2. Have the remainder of the cadets sit in a circle approximately 3 m (10 feet) in diameter.</li><li>3. Blindfold the volunteer and have them stand in the middle of the circle.</li><li>4. Have a member of the group place the two small objects on the ground, inside the circle, close enough together that the volunteer can simultaneously cover one object with each foot.</li><li>5. On a start signal, each group member, one at a time, can give one direction to the volunteer (eg, “Move your left foot forward 6 inches.”).</li><li>6. Each member can give just one direction with the intent of getting the volunteer to cover one object with each foot.</li><li>7. As time permits, have more cadets volunteer to participate as the cadet in the middle of the circle.</li></ol>	
<b>SAFETY</b> <p>Ensure cadets look out for the safety of the cadet in the centre of the circle.</p>	
<b>REFERENCE</b> <p>(ISBN 0-7360-5088-4) Midura, D. W., &amp; Glover, D. R. (2005). <i>Essentials of Team Building</i>. (p. 58). Champaign, IL: Human Kinetics.</p>	

<b>TEAM-BUILDING ACTIVITY</b>	<b>COMMUNICATION</b>
<b>MISSING BUCKET</b>	<b>TIME:</b> 10–15 min
<b>RESOURCES</b> <ul style="list-style-type: none"><li>• A large, flat and open space free from obstacles,</li><li>• Rope/pylons to mark boundaries,</li><li>• Blindfolds (one per every two cadets),</li><li>• 20 L (five gallon) bucket,</li><li>• 4 L (one gallon) jug,</li><li>• Plastic drinking cups (enough for half the cadets), and</li><li>• 8–10 objects to use as obstacles.</li></ul>	
<b>ACTIVITY LAYOUT</b> <ul style="list-style-type: none"><li>• Place the rope/pylons to create an area that is approximately 3.5 m (10–12 feet) wide and 7.5 m (25 feet) long.</li><li>• Set up obstacles throughout the course in a random pattern.</li><li>• Fill the 20 L (five gallon) bucket with water and place it at the start line.</li><li>• Place the empty 4 L (one gallon) container (the receiving container) at the finish line.</li><li>• Place the plastic drinking cups at the start line.</li></ul>	
<b>ACTIVITY INSTRUCTIONS</b> <ol style="list-style-type: none"><li>1. The goal of the activity is for a group of blindfolded cadets to be verbally led through the obstacle course by the non-blindfolded cadets while transferring water. The blindfolded cadets are to transfer the water in the bucket to the receiving container at the finish line without moving the buckets.</li><li>2. Cadets are to avoid the obstacles as they proceed through the course.</li><li>3. Non-blindfolded cadets are not allowed to touch the bucket, the receiving container or the drinking cups.</li><li>4. If anyone breaks a rule or steps on an obstacle, that cadet must return to the starting line without emptying their water into the receiving container.</li><li>5. The activity is complete when the receiving container is filled to the designated mark.</li></ol>	
<b>SAFETY</b> <p>The cadets must ensure the safety of the blindfolded cadets at all times throughout this activity.</p>	
<b>REFERENCE</b> <p>(ISBN 0-7360-5088-4) Midura, D. W., &amp; Glover, D. R. (2005). <i>Essentials of Team Building</i>. (pp. 126–127). Champaign, IL: Human Kinetics.</p>	



<b>TEAM-BUILDING ACTIVITY</b>	<b>COMMUNICATION</b>
<b>CHARADE LINE</b>	<b>TIME: 15 min</b>
<b>RESOURCES</b> A large, open space free from obstacles.	
<b>ACTIVITY LAYOUT</b> Create sample situations for the activity if you wish to use different ones than the samples given here.	
<b>ACTIVITY INSTRUCTIONS</b> <ol style="list-style-type: none"><li>1. Divide the cadets in two groups.</li><li>2. Have the first group come to the front (performance area) and the second group be the audience.</li><li>3. Explain the activity to the cadets, to include:<ol style="list-style-type: none"><li>(a) Line up facing the back of the cadet in front of you.</li><li>(b) Act out a situation for the cadet in front of you without using any verbal communication.</li><li>(c) That person will act out the situation for the next person in line and so forth down the line.</li></ol></li><li>4. Have the group in the performance area line up with their backs to you. Tap the first cadet on the shoulder and have them turn around.</li><li>5. Act out a situation. For example, you may mime the following:<ol style="list-style-type: none"><li>(a) you walk in swinging a bag in your hand;</li><li>(b) you pull up a chair and have a seat;</li><li>(c) you take a fishing rod out of the bag and cast your line;</li><li>(d) you pull in the line when you feel a tug on it;</li><li>(e) you find a rubber boot on your line instead of a fish; and</li><li>(f) you dump the water out of the boot, put it on your foot and leave.</li></ol></li><li>6. That cadet then taps the next cadet, acts out the same situation and so forth down the line. Expect the situation being acted out to change as it passes through the line.</li><li>7. The group of cadets acting as the audience may laugh but not offer any advice or guidance.</li><li>8. Once the last cadet has observed the situation they should act it out for you and the initial cadet and the entire group should watch while you perform the original situation once more.</li><li>9. Have the groups reverse roles so the original audience becomes the actors and vice versa. Have the cadets repeat Steps 4. to 8. with a new situation. For example, you may mime the following:<ol style="list-style-type: none"><li>(a) you pull a lottery ticket out of your back pocket;</li><li>(b) you pull out a chair and sit;</li><li>(c) you pull a newspaper out of a bag;</li><li>(d) you check the numbers on your lottery ticket with the numbers on the newspaper; and</li><li>(e) you realize all the numbers match and jump up and down in amazement!</li></ol></li></ol>	
<b>SAFETY</b> N/A.	

**REFERENCE**

(ISBN 0-934387-05-2) Collard, M. (2005). *No Props: Great Games With No Equipment*. (pp. 202–203). Beverly, MA: Project Adventure, Inc.

<b>TEAM-BUILDING ACTIVITY</b>	<b>COMMUNICATION</b>
<b>THE ROCK</b>	<b>TIME: 15 min</b>
<b>RESOURCES</b> <ul style="list-style-type: none"><li>• A large, open space free from obstacles, and</li><li>• Small rock (must be small enough to be concealed in a fist).</li></ul>	
<b>ACTIVITY LAYOUT</b> <p>N/A.</p>	
<b>ACTIVITY INSTRUCTIONS</b> <ol style="list-style-type: none"><li>1. Have the cadets stand in a circle, facing the centre.</li><li>2. Have the cadets close their eyes and stand with both of their hands clenched behind their backs.</li><li>3. Explain that if they would like to be the cadet holding the rock, they must open one fist into a cupped position, ready to receive the rock. Cadets not wishing to hold the rock should remain with their hands clenched. Once a cadet receives the rock they are to clench their hand into a fist.</li><li>4. Walk around the circle, as quietly as possible and place the small rock into one of the open hands.</li><li>5. Continue around the circle to the point from which you started.</li><li>6. Have all cadets clench their hands, open their eyes and sit in the circle, keeping their hands clenched at all times.</li><li>7. Every person, including the one holding the rock, will have a chance to guess who is holding the rock.</li><li>8. After a minute of everyone looking around the circle, allow the group to start making guesses. There is to be no talking among the cadets.</li><li>9. Ask for a volunteer to guess first. If a cadet guesses wrong they are not allowed to guess again.</li><li>10. Each cadet is given an opportunity to make one guess until the rock holder is discovered.</li></ol>	
<b>SAFETY</b> <p>N/A.</p>	
<b>REFERENCE</b> <p>(ISBN 0-934387-05-2) Collard, M. (2005). <i>No Props: Great Games With No Equipment</i>. (pp.189–190). Beverly, MA: Project Adventure, Inc.</p>	

<b>TEAM-BUILDING ACTIVITY</b>	<b>COMMUNICATION</b>
<b>KING/QUEEN FROG</b>	<b>TIME:</b> 15 min
<b>RESOURCES</b> <ul style="list-style-type: none"><li>• A large, open space free from obstacles, and</li><li>• Poly spots/chairs (one per cadet).</li></ul>	
<b>ACTIVITY LAYOUT</b> <p>N/A.</p>	
<b>ACTIVITY INSTRUCTIONS</b> <ol style="list-style-type: none"><li>1. Have the cadets sit in a circle, facing the centre. Mark each position with spots or chairs.</li><li>2. Every cadet must have a unique action that represents an animal. For example:<ol style="list-style-type: none"><li>(a) a gorilla beating on their chest;</li><li>(b) a monkey scratching their armpits;</li><li>(c) a bird fluttering their wings;</li><li>(d) a dog wagging their tail;</li><li>(e) a cat grooming their face;</li><li>(f) a snake slithering through the grass;</li><li>(g) a penguin waddling;</li><li>(h) an elephant raising their trunk;</li><li>(i) a rabbit hopping;</li><li>(j) a lobster moving their claws; or</li><li>(k) a chicken clucking.</li></ol></li><li>3. Go around the circle and have each cadet demonstrate their action. You may act as the King/Queen Frog or designate one cadet to hold this position. The action for the King/Queen Frog will be a frog leaping.</li><li>4. Each round will start with the King/Queen Frog. That cadet will perform their gesture and then the gesture of another cadet. This cadet must quickly do their action, followed by another cadet's action and so forth.</li><li>5. If a cadet is too slow, messes up the action or goes in the wrong sequence the game stops. This cadet will leave their spot and sit directly to the left of the King/Queen Frog. This causes everyone sitting to the right of this cadet to move one seat to the left to fill in the gap.</li><li>6. When a cadet moves seats, their action does not move with them, it stays with the seat!</li><li>7. The object of the game is to get into the royal throne. This occurs when the King/Queen Frog makes a mistake and everyone in the circle moves one seat to the left.</li></ol>	
<b>SAFETY</b> <p>N/A.</p>	
<b>REFERENCE</b> <p>(ISBN 0-934387-05-2) Collard, M. (2005). <i>No Props: Great Games With No Equipment</i>. (pp. 182–183). Beverly, MA: Project Adventure, Inc.</p>	

<b>TEAM-BUILDING ACTIVITY</b>	<b>COMMUNICATION</b>
<b>MUTE LINEUP</b>	<b>TIME:</b> 15 min
<b>RESOURCES</b> A large, open space free from obstacles.	
<b>ACTIVITY LAYOUT</b> N/A.	
<b>ACTIVITY INSTRUCTIONS</b> <ol style="list-style-type: none"><li>1. Explain to the group that from this point on they are all mute – no verbal communication is allowed. The cadets are also not to write anything down on paper, flip charts, etc.</li><li>2. Have the group line up in a straight line according to set criteria (eg, height, birth date, number of letters in their first/last name, etc).</li><li>3. Once the cadets think they are lined up in the correct order, have them sit to signify they are done.</li><li>4. Go through the lineup verbally to see if they were able to get in the correct sequence with non-verbal communication.</li><li>5. If time permits, have the group line up using different criteria to see if there were any lessons learned from the first attempt.</li></ol>	
<b>SAFETY</b> N/A.	
<b>REFERENCE</b> (ISBN 0-934387-05-2) Collard, M. (2005). <i>No Props: Great Games With No Equipment</i> . (pp. 145–146). Beverly, MA: Project Adventure, Inc.	

<b>TEAM-BUILDING ACTIVITY</b>	<b>COMMUNICATION</b>
<b>MARRIAGE</b>	<b>TIME:</b> 10–15 min
<b>RESOURCES</b> <ul style="list-style-type: none"><li>• A large, open space free from obstacles, and</li><li>• Deck of playing cards (Joker included).</li></ul>	
<b>ACTIVITY LAYOUT</b> <p>Based on the number of cadets in the group, pull out a card for each player. Ensure you have a card for each participant, including one Joker. The other cards must be pairs in the same colour and denomination (eg, three of hearts and three of diamonds, ten of spades and ten of clubs).</p> <p>If there is an even number of cadets participating in the activity, exclude the Joker.</p>	
<b>ACTIVITY INSTRUCTIONS</b> <ol style="list-style-type: none"><li>1. Each cadet is given a card and asked not to show it to anyone.</li><li>2. Explain that the cadets are to find the person in the room that has their matching card based on colour and denomination (eg, the queen of hearts would be looking for the queen of diamonds).</li><li>3. Explain that the cadets are not allowed to show their card at any time and are not allowed to say colours or numbers.</li><li>4. Have the cadets try to find their match. They may use words such as “I have a fire engine coloured card and like shiny objects in rings” to determine they have a red card that is a diamond.</li><li>5. When pairs think they have found each other they are to link arms and wait for the other participants to finish.</li><li>6. The Joker in the room is to do the same thing throughout the activity but will not be able to find their partner as there is only one Joker in the group leaving them as the unmarried card at the end of the activity.</li></ol>	
<b>SAFETY</b> <p>N/A.</p>	
<b>REFERENCE</b> <p>(ISBN 0-7575-4094-5) Cummings, M. (2007). <i>Playing With a Full Deck: 52 Team Activities Using a Deck of Cards</i>. (p. 93). Dubuque, IA: Kendall/Hunt Publishing Company.</p>	

<b>TEAM-BUILDING ACTIVITY</b>	<b>COMMUNICATION</b>
<b>THAT AIN'T ME!</b>	<b>TIME:</b> 10–15 min
<b>RESOURCES</b> A large, open space free from obstacles.	
<b>ACTIVITY LAYOUT</b> N/A.	
<b>ACTIVITY INSTRUCTIONS</b> <ol style="list-style-type: none"><li>1. Divide the cadets into pairs.</li><li>2. Explain that each cadet will have to mime three things about themselves to their partner enabling their partner to later verbally introduce them to the remainder of the group.</li><li>3. The cadets are not allowed to use any form of verbal communication. Cadets should be given approximately three minutes to mime their information to their partner.</li><li>4. Cadets can mime things such as:<ol style="list-style-type: none"><li>(a) part-time jobs,</li><li>(b) favourite school subject,</li><li>(c) favourite hobby/pastime, and</li><li>(d) favourite movie/television show.</li></ol></li><li>5. Once everyone has had time to mime their information, gather the group. Each cadet will then have to verbally introduce their partner based on the information that was mimed.</li><li>6. If cadets introduce something that was misinterpreted from the mime, their partner should state, "That ain't me!". This activity is complete when all the cadets have introduced their partners.</li></ol>	
<b>SAFETY</b> N/A.	
<b>REFERENCE</b> (ISBN 0-934387-05-2) Collard, M. (2005). <i>No Props: Great Games With No Equipment</i> . (pp. 52–53). Beverly, MA: Project Adventure, Inc.	

<b>TEAM-BUILDING ACTIVITY</b>	<b>COMMUNICATION</b>
<b>BLIND SHAPES</b>	<b>TIME:</b> 15 min
<b>RESOURCES</b> <ul style="list-style-type: none"><li>• A large, open space free from obstacles,</li><li>• Blindfolds (one per cadet), and</li><li>• Length of rope long enough for all cadets to hold on to at once.</li></ul>	
<b>ACTIVITY LAYOUT</b> <p>Tie the end of the rope in a knot.</p>	
<b>ACTIVITY INSTRUCTIONS</b> <ol style="list-style-type: none"><li>1. Have the cadets stand in a circle and blindfold each of them.</li><li>2. Place the length of rope on the ground near the feet of the cadets. Explain that the first thing they will have to do is find the rope and pick it up. The cadets are allowed to verbally communicate throughout this activity.</li><li>3. Tell the cadets to form a square. After a few minutes, ask the cadets if they think they have formed the square. If they say no, allow them to continue, even if they already are in a square. If they say yes, allow them to remove their blindfolds and look at the shape they have formed.</li><li>4. Continue with other shapes (eg, triangles, rectangles, ovals, etc) as time allows.</li></ol>	
<b>SAFETY</b> <p>Ensure the safety of all blindfolded cadets.</p>	
<b>REFERENCE</b> <p>(ISBN 0-7872-0107-3) (1995). <i>Youth Leadership in Action</i>. (pp. 63–64). Dubuque, IA: Kendall/Hunt Publishing Company.</p>	



<b>TEAM-BUILDING ACTIVITY</b>	<b>COMMUNICATION</b>
<b>WINK</b>	<b>TIME:</b> 15 min
<b>RESOURCES</b> A large, open space free from obstacles.	
<b>ACTIVITY LAYOUT</b> N/A.	
<b>ACTIVITY INSTRUCTIONS</b> <ol style="list-style-type: none"><li>1. Have the cadets sit in a circle facing the centre.</li><li>2. Explain that there is a mystery “winker” among the group, but not even that cadet knows who it is yet.</li><li>3. Have the cadets close their eyes. Secretly assign the “winker” by tapping them on the shoulder.</li><li>4. Explain that the cadets must mingle with all the others and greet each other. The “winker” will be secretly winking at cadets to get them out of the game.</li><li>5. Explain that the cadets must wait at least 10 seconds before sitting after they have been winked at by the “winker”. Cadets who have been winked at are to be seated while others continue to mingle.</li><li>6. If a cadet who is still in the game suspects someone of being the “winker,” they may raise a hand and announce, “I accuse”. Stop the proceedings and ask if there is a seconder, who is a second cadet who suspects they know who the “winker” may be. If there is no seconder the game will continue.</li><li>7. If a seconder speaks up, the facilitator is to count to three and each accuser must point directly to the person they believe is the “winker”. If they each point to a different person, regardless if one of them is correct, they are both out of the game. If they point to the same wrong person, they are both out of the game. If they are correct the activity is over.</li><li>8. The activity continues until either everyone is out or two people make a successful accusation.</li></ol>	
<b>SAFETY</b> N/A.	
<b>REFERENCE</b> (ISBN 0-934387-05-2) Collard, M. (2005). <i>No Props: Great Games With No Equipment</i> . (pp. 179–180). Beverly, MA: Project Adventure, Inc.	

<b>TEAM-BUILDING ACTIVITY</b>	<b>COMMUNICATION</b>
<b>MINEFIELD</b>	<b>TIME:</b> 15 min
<b>RESOURCES</b> <ul style="list-style-type: none"><li>• A large, open space free from obstacles,</li><li>• Large quantity of small balls (eg, tennis balls, golf balls, ping pong balls, etc),</li><li>• Stopwatch, and</li><li>• Blindfolds (two).</li></ul>	
<b>ACTIVITY LAYOUT</b> <ul style="list-style-type: none"><li>• Place the balls around the floor in a random pattern.</li><li>• Mark off a start and a finish line.</li></ul>	
<b>ACTIVITY INSTRUCTIONS</b> <ol style="list-style-type: none"><li>1. Ask for two volunteers and blindfold them.</li><li>2. Divide the cadets in two groups. Have each group of cadets place themselves evenly throughout the “minefield”. One group will be responsible for verbally guiding the first blindfolded cadet through the “minefield”. The second group will be responsible for verbally guiding the second blindfolded cadet to try to tag the first blindfolded cadet.</li><li>3. Explain that the first blindfolded cadet will be the “sidewinder”. This cadet is to aim for the finish line and will be verbally guided through the “minefield” by their group. If the “sidewinder” touches a “mine” (ball) on their way through the “minefield” they must swing both of their arms in a full circle 10 times, counting each revolution aloud.</li><li>4. One minute after the “sidewinder” is released into the minefield, launch the second blindfolded cadet, the “missile” into the “minefield”. The “missile’s” team is to guide them to try to tag the “sidewinder”.</li><li>5. If the “missile” tags the “sidewinder” prior to them reaching the finish line, the mission is complete.</li></ol>	
<b>SAFETY</b> <p>Ensure the safety of the blindfolded cadets at all times throughout the duration of the activity.</p>	
<b>REFERENCE</b> <p>(ISBN 0-8403-5682-X) Rohnke, K. (1984). <i>Silver Bullets: A Guide to Initiative Problems, Adventure Games and Trust Activities</i>. (p. 24). Dubuque, IA: Kendall/Hunt Publishing Company.</p>	

<b>TEAM-BUILDING ACTIVITY</b>	<b>COMMUNICATION</b>
<b>CATEGORIES TWIST</b>	<b>TIME: 15 min</b>
<b>RESOURCES</b> A large, open space free from obstacles.	
<b>ACTIVITY LAYOUT</b> N/A.	
<b>ACTIVITY INSTRUCTIONS</b> <ol style="list-style-type: none"><li>1. Divide the cadets into groups of three.</li><li>2. Have each group go to a quiet area away from the other groups. Allow approximately four minutes for the group to come up with as many categories as possible of things they have in common – the odder the better (eg, they have all seen a zebra).</li><li>3. Each group will have to share three things with the rest of the group. One item should not be true.</li><li>4. Have everyone come back to a common meeting place in the room and sit.</li><li>5. Have each group, one at a time, come to the front and state their three commonalities with a straight face.</li><li>6. The remaining groups are to decide which commonality is not true. This activity will allow the cadets to start reading people's non-verbal communication skills.</li></ol>	
<b>SAFETY</b> N/A.	
<b>REFERENCE</b> (ISBN 0-934387-05-2) Collard, M. (2005). <i>No Props: Great Games With No Equipment</i> . (p. 178). Beverly, MA: Project Adventure, Inc.	

<b>TEAM-BUILDING ACTIVITY</b>	<b>COMMUNICATION</b>
<b>NEGOTIATION</b>	<b>TIME:</b> 15 min
<b>RESOURCES</b> A large, open space free from obstacles.	
<b>ACTIVITY LAYOUT</b> N/A.	
<b>ACTIVITY INSTRUCTIONS</b> <ol style="list-style-type: none"><li>1. Divide the cadets into three or four small groups (depending on the number of cadets).</li><li>2. Explain that each group will go to an area where the other groups can not see them and decide on a physical gesture that they will later have to reveal to the rest of the cadets. Examples of gestures may include:<ol style="list-style-type: none"><li>(a) waving their hands in the air;</li><li>(b) jumping up and down;</li><li>(c) performing jumping jacks;</li><li>(d) flapping their arms like a bird;</li><li>(e) spinning around in a circle; or</li><li>(f) rubbing their stomachs while patting their heads.</li></ol></li><li>3. After approximately three minutes, have each group come back to the centre of the training area, and stand in a position where every other group can see them. Explain that the cadets are no longer allowed to use any verbal communication.</li><li>4. On the word “go” have every cadet in each group simultaneously demonstrate their group’s gesture for the remainder of the cadets.</li><li>5. Explain that the cadets are to now decide on one gesture among all the groups. Remember that the cadets are not allowed to communicate verbally throughout the remainder of this activity.</li><li>6. The goal is to see how many times it will take to get every group doing the same gesture without any verbal communication. The gesture may be one from of the groups or a combination of the gestures.</li></ol>	
<b>SAFETY</b> N/A.	
<b>REFERENCE</b> (ISBN 0-934387-05-2) Collard, M. (2005). <i>No Props: Great Games With No Equipment</i> . (pp. 150–151). Beverly, MA: Project Adventure, Inc.	

<b>TEAM-BUILDING ACTIVITY</b>	<b>PROBLEM-SOLVING</b>
<b>MAGIC CARPET</b>	<b>TIME:</b> 15 min
<b>RESOURCES</b> <ul style="list-style-type: none"><li>• A large, open space free from obstacles, and</li><li>• Piece of plastic or material approximately 1.2 m (4 feet) by 1.5 m (5 feet).</li></ul>	
<b>ACTIVITY LAYOUT</b> <p>N/A.</p>	
<b>ACTIVITY INSTRUCTIONS</b> <ol style="list-style-type: none"><li>1. Explain that everyone must stand on the magic carpet and that everyone must maintain contact with the magic carpet at all times throughout the activity.</li><li>2. Explain that the group is on a magic carpet ride high above the CSTC when suddenly you discover that you are travelling in the wrong direction because the magic carpet is upside down.</li><li>3. Have the cadets turn the magic carpet over without stepping off. Every cadet must maintain contact with the magic carpet at all times.</li></ol>	
<b>SAFETY</b> <p>Ensure all cadets maintain contact with the magic carpet. This will prevent cadets from being picked up or carried on shoulders.</p>	
<b>REFERENCE</b> <p>(ISBN 0-7872-4532-1) Cain, J., &amp; Jolliff, B. (1998). <i>Teamwork &amp; Teamplay</i>. (pp. 125–126). Dubuque, IA: Kendall/Hunt Publishing Company.</p>	

<b>TEAM-BUILDING ACTIVITY</b>	<b>PROBLEM-SOLVING</b>
<b>RAFT</b>	<b>TIME: 15 min</b>
<b>RESOURCES</b> <ul style="list-style-type: none"><li>• A large, open space free from obstacles, and</li><li>• Piece of tarp/plywood approximately 1.2 m (4 feet) by 1.2 m (4 feet) depending on the size of the group (should be just large enough for all of the cadets to fit on).</li></ul>	
<b>ACTIVITY LAYOUT</b> <p>N/A.</p>	
<b>ACTIVITY INSTRUCTIONS</b> <ol style="list-style-type: none"><li>1. Explain to the cadets that their cruise ship has hit a reef and they are required to abandon ship.</li><li>2. Explain that there are a number of sharks in the water nearby and the group must all get aboard the life raft in order to be rescued by the Coast Guard. The rescue helicopter can only pick them up if no one is in the water (touching the ground) for at least 20 seconds.</li><li>3. The objective is for all the cadets to remain on the life raft for at least 20 seconds in order for the rescue helicopter to come to the rescue.</li><li>4. Have the cadets participate in the activity.</li></ol>	
<b>SAFETY</b> <p>Ensure the safety of all cadets while on the raft.</p>	
<b>REFERENCE</b> <p>(ISBN 0-07-059532-1) Snow, H. (1997). <i>Indoor/Outdoor Team-Building Games for Trainers</i>. (pp. 113–115). New York, NY: McGraw-Hill.</p>	

<b>TEAM-BUILDING ACTIVITY</b>	<b>PROBLEM-SOLVING</b>
<b>MOONWALK</b>	<b>TIME:</b> 15 min
<b>RESOURCES</b> <ul style="list-style-type: none"><li>• A large, open space free from obstacles,</li><li>• Hula hoops (minimum of eight), and</li><li>• Large rubber bands or pieces of soft fabric (one per every two cadets).</li></ul>	
<b>ACTIVITY LAYOUT</b> <p>Place eight or more hula hoops randomly on the ground no more than a foot apart.</p>	
<b>ACTIVITY INSTRUCTIONS</b> <ol style="list-style-type: none"><li>1. Have the cadets assemble on one end of the hula hoops. Place the rubber bands around their ankles, connecting them to each other so that the cadets have to move together as a team.</li><li>2. Explain that they must move from one hoop to the next without stepping outside.</li><li>3. Explain that if someone steps outside a hoop the team must go back to the start and begin again, attempting to communicate and decide how to best move through the hula hoops.</li><li>4. The goal is for the cadets to communicate and problem solve the best method of travelling through the hula hoops from the beginning to the end.</li><li>5. Have the cadets participate in the activity.</li></ol>	
<b>SAFETY</b> <p>Ensure the rubber bands are large enough not to be too tight on the cadets' ankles.</p>	
<b>REFERENCE</b> <p>(ISBN 0-07-059532-1) Snow, H. (1997). <i>Indoor/Outdoor Team-Building Games for Trainers</i>. (pp. 123–124). New York, NY: McGraw-Hill.</p>	

<b>TEAM-BUILDING ACTIVITY</b>	<b>PROBLEM-SOLVING</b>
<b>BALANCE BEAM</b>	<b>TIME:</b> 15 min
<b>RESOURCES</b> <ul style="list-style-type: none"><li>• A large, open space on grass or soft ground,</li><li>• 3 m (10 feet) plank of wood approximately 5 cm (2 inches) thick and 20 cm (8 inches) wide,</li><li>• Cinder block,</li><li>• Surveyor's tape, and</li><li>• Eggs (as per Step 2. in Activity Instructions).</li></ul>	
<b>ACTIVITY LAYOUT</b> <ul style="list-style-type: none"><li>• Set up the plank of wood so it is balanced in the middle on the cinder block.</li><li>• Mark a "V" on the ground in front of the cinder block with the surveyor's tape (as illustrated in Figure 3P-3).</li></ul>	
<b>ACTIVITY INSTRUCTIONS</b> <ol style="list-style-type: none"><li>1. Stand on the plank while you brief the team. Demonstrate how a slight shift in weight causes the plank to turn into a see-saw.</li><li>2. Explain that all of the cadets are to mount the plank, one at a time, from between the "V" marked on the ground, balance the plank as a group for a minimum of 10 seconds, and dismount, one at a time, between the "V" without causing either end of the plank to touch the ground – an egg can be laid under each end to ensure the plank has not touched the ground on either end.</li><li>3. Allow the cadets approximately five minutes to plan a strategy. Explain that once the cadets begin to mount the plank, there will be no more verbal communication.</li><li>4. The activity is complete when all of the cadets have successfully stepped off the plank into the "V".</li></ol>	
<b>SAFETY</b> <ul style="list-style-type: none"><li>• Ensure the activity is set up on grass or soft ground. In situations where this is not possible, have gym mats set up on either side of the plank.</li><li>• Have one or two assistant instructors to spot the cadets on the plank.</li><li>• Caution the cadets that if they are about to lose their balance they should step off the plank to avoid causing other cadets to fall or jump.</li><li>• Ensure the cadets do not jump off the plank as it could cause it to spin.</li></ul>	
<b>REFERENCE</b> <p>(ISBN 0-07-059532-1) Snow, H. (1997). <i>Indoor/Outdoor Team-Building Games for Trainers</i>. (pp. 125–128). New York, NY: McGraw-Hill.</p>	



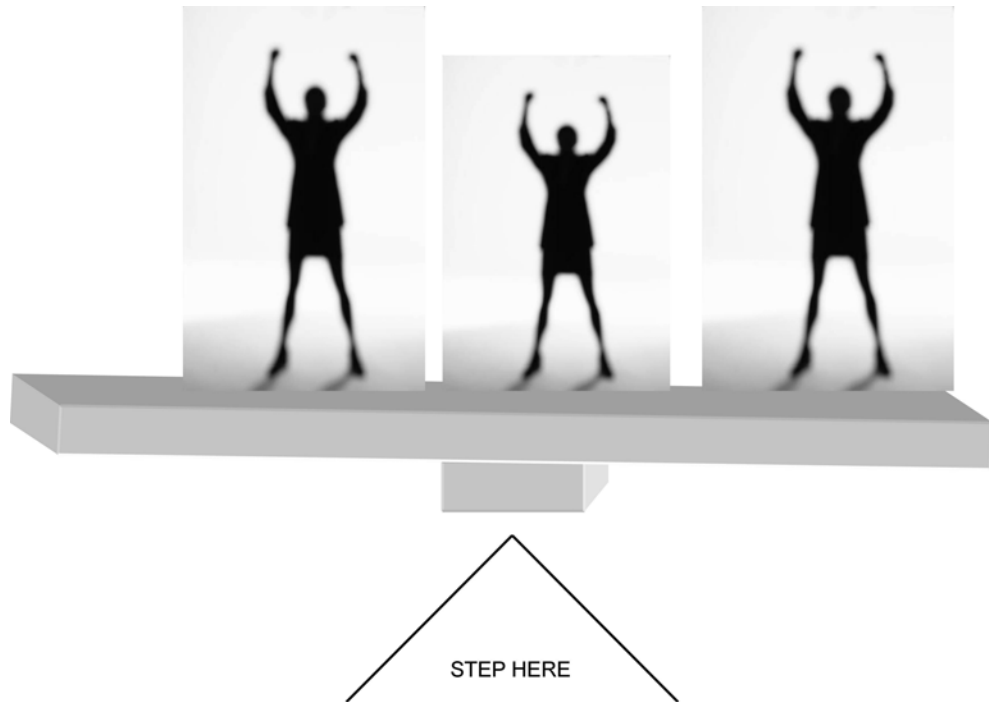

*Director Cadets 3, 2008, Ottawa, ON: Department of National Defence*

Figure 3P-3 Balance Beam Set-Up

<b>TEAM-BUILDING ACTIVITY</b>	<b>PROBLEM-SOLVING</b>
<b>GROUP SEARCH</b>	<b>TIME: 15 min</b>
<b>RESOURCES</b> <ul style="list-style-type: none"><li>• A large, open space free from obstacles,</li><li>• Masking tape/long piece of cloth (approximately 1.2 m [4 feet] long),</li><li>• Blindfolds (one per every two cadets),</li><li>• Stopwatch, and</li><li>• Three small toys/objects that will fit in a hand (eg, plastic dinosaur, plastic boat, plastic plane, plastic tank, doll, ball, etc).</li></ul>	
<b>ACTIVITY LAYOUT</b> <p>N/A.</p>	
<b>ACTIVITY INSTRUCTIONS</b> <ol style="list-style-type: none"><li>1. Divide the cadets into two groups.</li><li>2. Show the first group the three objects they will have to find.</li><li>3. Explain that the group, together as a team, will have to find the three objects while blindfolded.</li><li>4. Put masking tape or a long piece of cloth around the first group to attach them together.</li><li>5. Blindfold the first group of cadets.</li><li>6. Place the objects at various places on the ground within approximately 9 m (30 feet) of their location.</li><li>7. Have the cadets' move to find the three objects with the verbal assistance of the second group. It is the cadets' goal to decide how best to move about the area without breaking the tape/cloth or removing their blindfolds.</li><li>8. As the cadets find each object they are to identify what it is to the leader.</li><li>9. Have the groups reverse roles and repeat Steps 2. to 8.</li><li>10. Time both groups to see which group found and identified all three objects faster.</li></ol>	
<b>SAFETY</b> <p>Ensure the safety of the cadets who are blindfolded and attached to their team. The cadets in the other group should be watching out for any safety concerns and alerting the blindfolded cadets.</p>	
<b>REFERENCE</b> <p>(ISBN 0-07-059532-1) Snow, H. (1997). <i>Indoor/Outdoor Team-Building Games for Trainers</i>. (pp. 133–134). New York, NY: McGraw-Hill.</p>	

<b>TEAM-BUILDING ACTIVITY</b>	<b>PROBLEM-SOLVING</b>
<b>TRAFFIC JAM</b>	<b>TIME:</b> 15 min
<b>RESOURCES</b> <ul style="list-style-type: none"><li>• A large, open space free from obstacles, and</li><li>• Tape or pieces of cardboard/plywood (there should be one more space than the number of cadets).</li></ul>	
<b>ACTIVITY LAYOUT</b> <ul style="list-style-type: none"><li>• Mark spaces on the ground (as illustrated in Figure 3P-4) with tape or pieces of cardboard/plywood (there should be one more space than the number of cadets).</li><li>• Mark the centre space with an “X” (as illustrated in Figure 3P-4).</li></ul>	
<b>ACTIVITY INSTRUCTIONS</b> <ol style="list-style-type: none"><li>1. Divide the cadets into two equal groups.</li><li>2. Have each group stand on a space facing the middle space.</li><li>3. Explain that the group is to attempt to move past each other so that the group to the right of the “X” ends up on the left and vice versa.</li><li>4. Explain the following rules:<ol style="list-style-type: none"><li>(a) Cadets are not allowed to move around someone facing the same direction as them.</li><li>(b) Cadets are not allowed to move backwards around someone.</li><li>(c) Cadets are allowed to step forward onto an empty space.</li><li>(d) Cadets are allowed to step around someone facing them into an empty space.</li></ol></li><li>5. The activity is complete when all cadets have successfully changed sides.</li></ol>	
<b>SAFETY</b> <p>N/A.</p>	
<b>REFERENCE</b> <p>(ISBN 0-07-059532-1) Snow, H. (1997). <i>Indoor/Outdoor Team-Building Games for Trainers</i>. (pp. 149–150). New York, NY: McGraw-Hill.</p>	

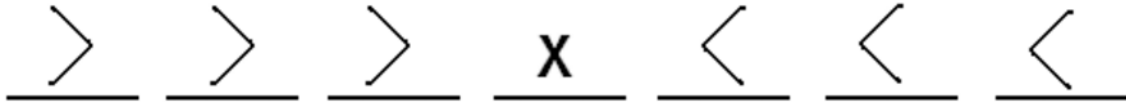

*Director Cadets 3, 2008, Ottawa, ON: Department of National Defence*

Figure 3P-4 Traffic Jam Set-Up

<b>TEAM-BUILDING ACTIVITY</b>	<b>PROBLEM-SOLVING</b>
<b>CIRCLE WARS</b>	<b>TIME:</b> 15 min
<b>RESOURCES</b> <ul style="list-style-type: none"><li>• A large, open space free from obstacles, and</li><li>• 15 rope circles of varying sizes between 0.3–1 m (1–3 feet) in diameter.</li></ul>	
<b>ACTIVITY LAYOUT</b> <p>Place the circles on the ground approximately 0.3–1 m (1–3 feet) apart from each other.</p>	
<b>ACTIVITY INSTRUCTIONS</b> <ol style="list-style-type: none"><li>1. Explain to the cadets that they are to put both of their feet entirely in a circle. More than one cadet can put their feet in a circle at a time.</li><li>2. On the word “change” have the cadets, when possible, move to another circle and put their feet entirely in that circle.</li><li>3. After each time you say “change”, casually pick up one or two of the circles. This will cause the cadets to move faster as circles disappear.</li><li>4. Once you get down to the last one or two circles, remind the cadets that they are not allowed to move them. Remind them that it is problem-solving initiative and they are to work with what they have in order to develop possible solutions.</li><li>5. This activity is complete when the cadets all have their feet in the last circle.</li></ol>	
<b>SAFETY</b> <p>N/A.</p>	
<b>REFERENCE</b> <p>(ISBN 0-07-059532-1) Snow, H. (1997). <i>Indoor/Outdoor Team-Building Games for Trainers</i>. (pp. 163–165). New York, NY: McGraw-Hill.</p>	

<b>TEAM-BUILDING ACTIVITY</b>	<b>PROBLEM-SOLVING</b>
<b>UNTYING KNOTS</b>	<b>TIME: 15 min</b>
<b>RESOURCES</b> <ul style="list-style-type: none"><li>• A large, open space free from obstacles, and</li><li>• Soft cloth ropes approximately 2.5 m (8 feet) long (one per every cadet).</li></ul>	
<b>ACTIVITY LAYOUT</b> <p>N/A.</p>	
<b>ACTIVITY INSTRUCTIONS</b> <ol style="list-style-type: none"><li>1. Have the cadets stand in a circle approximately 3 m (10 feet) in diameter.</li><li>2. Have every cadet hold a piece of rope in their right hand.</li><li>3. Explain that the cadets must join their free hand with the ropes of other cadets in the circle. Explain that the cadets are not to hold the rope of a cadet standing next to them.</li><li>4. This process continues until all cadets are holding a piece of rope in each hand and are joined to the rope in one cadet's right hand and a different cadet's left hand. This will create a knot in the cadets through the ropes (much like a human knot).</li><li>5. Have the cadets untie the knot the ropes have created using the following rules:<ol style="list-style-type: none"><li>(a) cadets are not allowed to let go of their ropes or change hands with the ropes;</li><li>(b) cadets are to communicate and move around to untie the knot to form a connected circle; and</li><li>(c) cadets may end up facing outward from the circle.</li></ol></li></ol>	
<b>SAFETY</b> <p>N/A.</p>	
<b>REFERENCE</b> <p>(ISBN 0-7360-5088-4) Midura, D. W., &amp; Glover, D. R. (2005). <i>Essentials of Team Building</i>. (pp. 56–57). Champaign, IL: Human Kinetics.</p>	

<b>TEAM-BUILDING ACTIVITY</b>	<b>PROBLEM-SOLVING</b>
<b>STEPPING STONES</b>	<b>TIME: 15 min</b>
<b>RESOURCES</b> <ul style="list-style-type: none"><li>• A large, open space free from obstacles, and</li><li>• One base (eg, pieces of cardboard/plywood/tape) per cadet plus one extra.</li></ul>	
<b>ACTIVITY LAYOUT</b> <p>Place each base/tape mark in a straight line approximately 30–38 cm (12–15 inches) apart.</p>	
<b>ACTIVITY INSTRUCTIONS</b> <ol style="list-style-type: none"><li>1. Have the cadets stand in a specified order of their choosing, on a base each.</li><li>2. Have the cadets determine where the extra base goes.</li><li>3. The objective is for the team to end up standing in reverse order from their starting position.</li><li>4. The following rules apply:<ol style="list-style-type: none"><li>(a) Only one person may touch a base at a time.</li><li>(b) When moving bases, a cadet may move in either direction to a neighbouring base.</li><li>(c) Cadets may move to a new base only if it is empty.</li><li>(d) The bases cannot be moved.</li><li>(e) Cadets are not allowed to touch the ground during the activity.</li><li>(f) If any one cadet breaks a rule, the entire group must start the task over.</li></ol></li></ol>	
<b>SAFETY</b> <p>Secure the bases to the ground or use tape so that the bases do not move.</p>	
<b>REFERENCE</b> <p>(ISBN 0-7360-5088-4) Midura, D. W., &amp; Glover, D. R. (2005). <i>Essentials of Team Building</i>. (pp. 106–107). Champaign, IL: Human Kinetics.</p>	

<b>TEAM-BUILDING ACTIVITY</b>	<b>PROBLEM-SOLVING</b>
<b>SWAMP TRAIL</b>	<b>TIME:</b> 15 min
<b>RESOURCES</b> <ul style="list-style-type: none"><li>• A large, open space free from obstacles,</li><li>• Twelve 30-cm (12-inch) bases (eg, cardboard/poly spots/tape),</li><li>• Tape, and</li><li>• Six beanbags.</li></ul>	
<b>ACTIVITY LAYOUT</b> <ul style="list-style-type: none"><li>• Designate a start and finish line approximately 4.5 m (15 feet) apart (the swamp is the area in between the two lines).</li><li>• Place the bases in two parallel lines between the start and finish lines.</li><li>• Place a beanbag at various distances, between 0.5–1.5 m (2–4 feet) away from bases 2, 3, 5, 7, 9 and 10 (as illustrated in Figure 3P-5).</li></ul>	
<b>ACTIVITY INSTRUCTIONS</b> <ol style="list-style-type: none"><li>1. Explain to the cadets that they must cross a swamp as a team, holding hands along the way. Each cadet must make it to the other side without stepping into the swamp or letting go of their team members' hands.</li><li>2. Explain that along the way, the cadets are to pick up the beanbags.</li><li>3. The following rules apply:<ol style="list-style-type: none"><li>(a) The team must hold hands for the duration of the activity.</li><li>(b) A cadet who is attempting to pick up a beanbag may let go of their team member's hand but must rejoin hands before moving to a new base.</li><li>(c) No one may touch the swamp during the trip through to the other side.</li><li>(d) Each cadet is permitted to pick up and carry only one beanbag.</li></ol></li><li>4. Have the cadets participate in the activity.</li></ol>	
<b>SAFETY</b> <ul style="list-style-type: none"><li>• Ensure the bases are secured to the ground or tape is used so that there is no chance of them slipping.</li><li>• Each cadet must ensure the safety of their fellow team members as they cross the swamp.</li></ul>	
<b>REFERENCE</b> <p>(ISBN 0-7360-5088-4) Midura, D. W., &amp; Glover, D. R. (2005). <i>Essentials of Team Building</i>. (pp. 166–167). Champaign, IL: Human Kinetics.</p>	



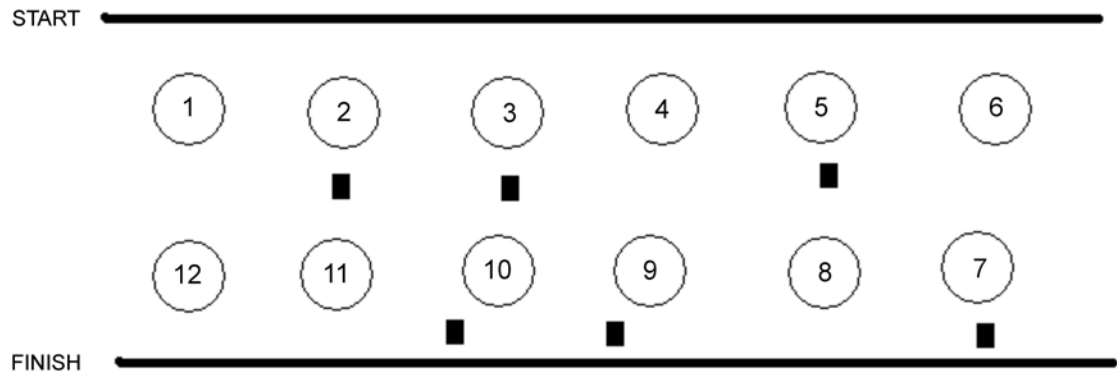

*Director Cadets 3, 2008, Ottawa, ON: Department of National Defence*

Figure 3P-5 Swamp Trail Set-Up

<b>TEAM-BUILDING ACTIVITY</b>	<b>PROBLEM-SOLVING</b>
<b>HUMAN KNOT</b>	<b>TIME:</b> 15 min
<b>RESOURCES</b> A large, open space free from obstacles.	
<b>ACTIVITY LAYOUT</b> N/A.	
<b>ACTIVITY INSTRUCTIONS</b> <ol style="list-style-type: none"><li>1. Have the cadets form a tight circle facing the centre, raise their arms in the air and grasp the hands of two different cadets. The cadets should not be holding hands with the cadets directly on either side of them.</li><li>2. Have the cadets untangle themselves without letting go of the other cadets' hands.</li><li>3. The activity is complete when the cadets have untied the knot and formed a circle.</li></ol>	
<b>SAFETY</b> The cadets are to ensure the safety of their team members at all times throughout the duration of this activity.	
<b>REFERENCE</b> (ISBN 0-934387-05-2) Collard, M. (2005). <i>No Props: Great Games With No Equipment</i> . (pp. 165–166). Beverly, MA: Project Adventure, Inc.	

<b>TEAM-BUILDING ACTIVITY</b>	<b>PROBLEM-SOLVING</b>
<b>CIRCLE CLAP</b>	<b>TIME: 10–15 min</b>
<b>RESOURCES</b> A large, open space free from obstacles.	
<b>ACTIVITY LAYOUT</b> N/A.	
<b>ACTIVITY INSTRUCTIONS</b> <ol style="list-style-type: none"><li>1. Explain that the objective of this activity is for everyone to simultaneously clap hands with the person next to them.</li><li>2. Have the cadets form a circle. Choose a cadet to begin and have each cadet clap once in succession.</li><li>3. Next, have the cadets attempt to make one solitary clap, all clapping in unison.</li><li>4. Once they have achieved this, have the cadets attempt to make one solitary clap – the catch being they cannot clap their own hands together. The cadets must clap their hands with the hands of the cadets on either side of them.</li><li>5. This activity is complete when the cadets have successfully made one solitary clap by clapping the hands of the cadets on both sides of them.</li></ol>	
<b>SAFETY</b> N/A.	
<b>REFERENCE</b> (ISBN 0-934387-05-2) Collard, M. (2005). <i>No Props: Great Games With No Equipment</i> . (pp. 155–156). Beverly, MA: Project Adventure, Inc.	

<b>TEAM-BUILDING ACTIVITY</b>	<b>PROBLEM-SOLVING</b>
<b>QUICK SHUFFLE</b>	<b>TIME:</b> 10–15 min
<b>RESOURCES</b> A large, open space free from obstacles.	
<b>ACTIVITY LAYOUT</b> N/A.	
<b>ACTIVITY INSTRUCTIONS</b> <ol style="list-style-type: none"><li>1. Divide the cadets into two groups. The cadets should not be evenly divided (eg, if there are 10 cadets, divide them into a group of seven and a group of three).</li><li>2. Have the larger group stand in one line, side by side, in front of the smaller group. Note the order of the larger group as a reference at the end of the activity.</li><li>3. Have the smaller group look at the lineup of cadets for approximately 10 seconds. Then have the cadets close their eyes until directed to open them. While these cadets have their eyes closed, have the larger group quietly shuffle their positions within the lineup.</li><li>4. Tell the smaller group to open their eyes and try to put the lineup back into their original configuration.</li><li>5. This activity is complete when the cadets have been put into their original configuration.</li><li>6. If the cadets complete this activity quickly, rearrange the groups and repeat Steps 1. to 5.</li></ol>	
<b>SAFETY</b> N/A.	
<b>REFERENCE</b> (ISBN 0-934387-05-2) Collard, M. (2005). <i>No Props: Great Games With No Equipment</i> . (p. 147). Beverly, MA: Project Adventure, Inc.	

<b>TEAM-BUILDING ACTIVITY</b>	<b>PROBLEM-SOLVING</b>
<b>TALL TOWER</b>	<b>TIME:</b> 10–15 min
<b>RESOURCES</b> <ul style="list-style-type: none"><li>• A large, open space free from obstacles, and</li><li>• Supplies for each group to build a tower (eg, paper, raw spaghetti noodles, marshmallows, toothpicks, straws, paper clips, paper cups, chewing gum, tape, etc).</li></ul>	
<b>ACTIVITY LAYOUT</b> <p>N/A.</p>	
<b>ACTIVITY INSTRUCTIONS</b> <ol style="list-style-type: none"><li>1. Divide the cadets into groups of two to four cadets.</li><li>2. Distribute an equal amount of the supplies to each group.</li><li>3. Explain to each group that they are to build the tallest tower they can using only the supplies given to them.</li><li>4. Allow the groups approximately seven minutes to build their towers. Have each group display their tower for the other groups.</li><li>5. Determine which group has the tallest tower.</li></ol>	
<b>SAFETY</b> <p>N/A.</p>	
<b>REFERENCE</b> <p>(ISBN 0-9662341-6-2) Jones, A. (1999). <i>Team-Building Activities for Every Group</i>. (pp. 92–93). Richland, WA: Rec Room Publishing.</p>	

<b>TEAM-BUILDING ACTIVITY</b>	<b>PROBLEM-SOLVING</b>
<b>SWAMP CROSSING</b>	<b>TIME: 15 min</b>
<b>RESOURCES</b> <ul style="list-style-type: none"><li>• A large, open space free from obstacles,</li><li>• Pieces of cardboard about 30 cm (12 inches) square (two fewer pieces than there are cadets), and</li><li>• Three 2-L plastic jugs with lids, and</li><li>• Water.</li></ul>	
<b>ACTIVITY LAYOUT</b> <ul style="list-style-type: none"><li>• Fill the plastic jugs with water and put the lids on them.</li><li>• Designate the start and finish lines for the swamp and place the plastic jugs at the finish.</li></ul>	
<b>ACTIVITY INSTRUCTIONS</b> <ol style="list-style-type: none"><li>1. Tell the cadets the following story: “Your group is stranded on an island and you need fresh water. The only water is in jugs on the other side of the salt-water, alligator-infested swamp. You must go and get it. You must do this as a group because the island gorillas are on the other side and are protective of their water but are afraid of a large group. You may use these special floating stepping stones (give them one or two fewer pieces of cardboard than there are cadets) that you can move across the water. The stones may be moved only by being picked up and set back down. You may not slide them because this will cause them to sink into the swamp.”</li><li>2. Explain that the cadets may not make a bridge with the stones but must move the last one to the front in order to advance through the swamp.</li><li>3. Have the cadets cross the swamp, get the jugs of water and return safely to the start of the swamp with the jugs.</li></ol>	
<b>SAFETY</b> <p>N/A.</p>	
<b>REFERENCE</b> <p>(ISBN 0-9662341-6-2) Jones, A. (1999). <i>Team-Building Activities for Every Group</i>. (pp. 104–105). Richland, WA: Rec Room Publishing.</p>	

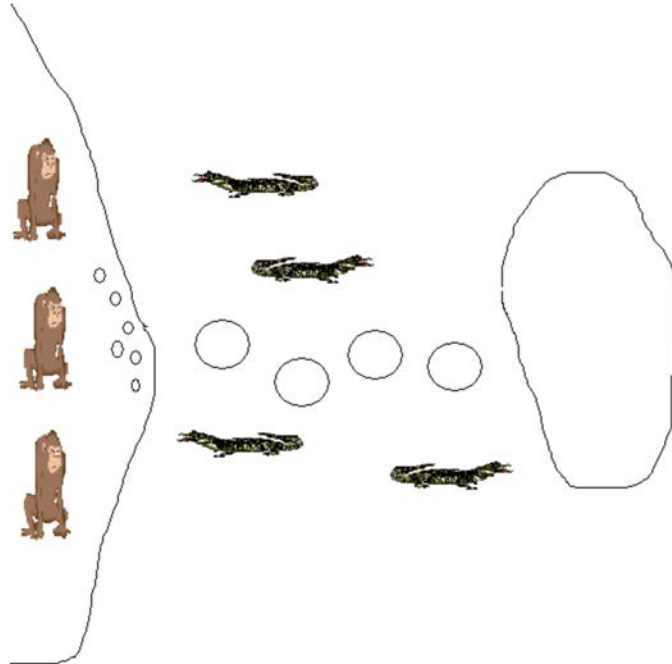

*Director Cadets 3, 2008, Ottawa, ON: Department of National Defence*

Figure 3P-6 Swamp Crossing Set-Up

<b>TEAM-BUILDING ACTIVITY</b>	<b>PROBLEM-SOLVING</b>
<b>WATER TRANSFER</b>	<b>TIME:</b> 10–15 min
<b>RESOURCES</b> <ul style="list-style-type: none"><li>• A large, open space free from obstacles,</li><li>• Four old bicycle tire inner tubes/three hula hoops,</li><li>• Chalk/tape,</li><li>• Two large coffee cans, and</li><li>• Water.</li></ul>	
<b>ACTIVITY LAYOUT</b> <ul style="list-style-type: none"><li>• In a large, open area draw/tape a circle on the ground that is approximately 4.5 m (15 feet) in diameter.</li><li>• Place one large coffee can, half-filled with water, in the centre of the circle.</li></ul>	
<b>ACTIVITY INSTRUCTIONS</b> <ol style="list-style-type: none"><li>1. Explain to the cadets that they are to get the can of water out of the circle without spilling any of the water.</li><li>2. Give the cadets either four old bicycle inner tubes or three hula hoops.</li><li>3. Explain that the following rules apply:<ol style="list-style-type: none"><li>(a) Cadets are not allowed to cross into the circle with any part of their body.</li><li>(b) The extra coffee can may be used for practice before moving the coffee can holding the water.</li><li>(c) Once the cadets have retrieved the can of water they are to pour it into the empty can without the two cans touching.</li></ol></li><li>4. Have the cadets participate in the activity.</li><li>5. This activity is complete when the cadets have successfully retrieved the can with water out of the circle and poured it into the second can without spilling any water.</li></ol>	
<b>SAFETY</b> <p>N/A.</p>	
<b>REFERENCE</b> <p>(ISBN 0-9662341-6-2) Jones, A. (1999). <i>Team-Building Activities for Every Group</i>. (pp. 114–115). Richland, WA: Rec Room Publishing.</p>	



<b>TEAM-BUILDING ACTIVITY</b>	<b>PROBLEM-SOLVING</b>
<b>EGG CONSTRUCTION</b>	<b>TIME:</b> 15 min
<b>RESOURCES</b> <ul style="list-style-type: none"><li>• Raw eggs (one per group), and</li><li>• Supplies to build an egg protection cover (eg, straws, tape, paper, popsicle sticks, glue, etc).</li></ul>	
<b>ACTIVITY LAYOUT</b> <p>N/A.</p>	
<b>ACTIVITY INSTRUCTIONS</b> <ol style="list-style-type: none"><li>1. Divide the cadets into two groups.</li><li>2. Distribute a raw egg and an equal amount of supplies to each group.</li><li>3. Have the cadets build an egg protection cover for their egg which will be dropped from a height of at least 2 m (6 feet).</li><li>4. Explain that once each group has their covers built they are to gather as a complete group and drop their eggs to see if they break or are protected.</li><li>5. Have the groups drop their eggs, one group at a time, to see if they are adequately protected.</li></ol>	
<b>SAFETY</b> <p>N/A.</p>	
<b>REFERENCE</b> <p>(ISBN 0-9662341-6-2) Jones, A. (1999). <i>Team-Building Activities for Every Group</i>. (p. 116). Richland, WA: Rec Room Publishing.</p>	

<b>TEAM-BUILDING ACTIVITY</b>	<b>PROBLEM-SOLVING</b>
<b>WATER CARRY</b>	<b>TIME:</b> 15 min
<b>RESOURCES</b> <ul style="list-style-type: none"><li>• A large, open space free from obstacles,</li><li>• Ten paper cups,</li><li>• Cafeteria-style tray, and</li><li>• Water, and</li><li>• Paper towels/mop.</li></ul>	
<b>ACTIVITY LAYOUT</b> <ul style="list-style-type: none"><li>• Fill the 10 paper cups with water, about three-quarters full.</li><li>• Place five paper cups at one end of the space and five at the opposite end (the space should be a minimum of 4.5 m [15 feet] apart).</li><li>• Place the cafeteria-style tray in the middle of the area (as illustrated in Figure 3P-7).</li><li>• Have an extra jug of water to refill cups and paper towel or a mop to clean up spills.</li></ul>	
<b>ACTIVITY INSTRUCTIONS</b> <ol style="list-style-type: none"><li>1. Explain that the cadets are to start in the middle of the space where the cafeteria-style tray is placed.</li><li>2. Have the cadets retrieve all 10 cups and place them onto the tray without spilling any of the water. The following rules apply:<ol style="list-style-type: none"><li>(a) Cadets may only get one cup at a time.</li><li>(b) Before getting a second cup from that side of the room, the cadets must travel to the other side of the room with the tray and retrieve a cup from that side.</li><li>(c) When cadets have retrieved all 10 cups of water, they are to place the tray on the floor in the centre of the space.</li><li>(d) Each cadet can only use one foot and one hand for the duration of this activity.</li></ol></li><li>3. Explain that if any water is spilled the whole group must start over.</li><li>4. This activity is complete when the 10 cups have been successfully placed on the tray in the centre of the space.</li></ol>	
<b>SAFETY</b> <p>N/A.</p>	
<b>REFERENCE</b> <p>(ISBN 0-9662341-6-2) Jones, A. (1999). <i>Team-Building Activities for Every Group</i>. (pp. 146–147). Richland, WA: Rec Room Publishing.</p>	

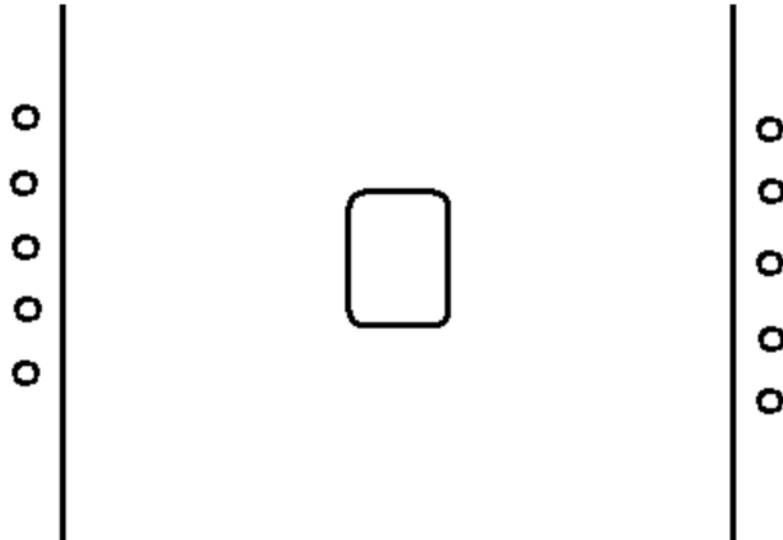

*Director Cadets 3, 2008, Ottawa, ON: Department of National Defence*

Figure 3P-7 Water Carry Set-Up

<b>TEAM-BUILDING ACTIVITY</b>	<b>TRUST-BUILDING</b>
<b>CRAZY MAZE</b>	<b>TIME: 15 min</b>
<b>RESOURCES</b> <ul style="list-style-type: none"><li>• A large, open space,</li><li>• Chairs (minimum of 10),</li><li>• Yarn, string or thin rope (approximately 15 m [50 feet] long) for each group, and</li><li>• Blindfolds (two).</li></ul>	
<b>ACTIVITY LAYOUT</b> <p>N/A.</p>	
<b>ACTIVITY INSTRUCTIONS</b> <ol style="list-style-type: none"><li>1. Divide the cadets into two groups.</li><li>2. Distribute a minimum of five chairs and yarn, string or thin rope to each group.</li><li>3. Have the two groups go to separate parts of the training area.</li><li>4. Have each group create a maze with the chairs and yarn, string or rope, with as many twists and turns as possible and perhaps even some dead ends along the way.</li><li>5. Once each group has completed their maze, have a blindfolded volunteer from each group walk through the other group's maze. The mazes will be completed one at a time.</li><li>6. The blindfolded cadet will be verbally led through the maze by their group. Members of the group that constructed the maze may try to confuse the cadet by giving opposing directions. At no time may the groups touch the blindfolded cadet to help them through the maze.</li></ol>	
<b>SAFETY</b> <p>The cadets must ensure the safety of the blindfolded cadets at all times throughout this activity.</p>	
<b>REFERENCE</b> <p>(ISBN 0-9662341-6-2) Jones, A. (1999). <i>Team-Building Activities for Every Group</i>. (pp. 136–137). Richland, WA: Rec Room Publishing.</p>	

<b>TEAM-BUILDING ACTIVITY</b>	<b>TRUST-BUILDING</b>
<b>EVERYBODY UP</b>	<b>TIME: 15 min</b>
<b>RESOURCES</b> A large, open space free from obstacles.	
<b>ACTIVITY LAYOUT</b> N/A.	
<b>ACTIVITY INSTRUCTIONS</b> <ol style="list-style-type: none"><li>1. Divide the cadets into pairs (the first time this activity is done it may be best to try to pair the cadets by size).</li><li>2. Have the cadets sit in two straight lines, facing their partners, with the soles of their shoes pressed against their partner's shoes.</li><li>3. Have the cadets grab their partner's hands.</li><li>4. On your count, have the cadets try to pull each other up to a standing position without letting go of each other's hands.</li><li>5. If time allows, the cadets can switch partners and attempt this activity with a new partner of a different size.</li></ol>	
<b>SAFETY</b> The cadets must ensure the safety of their partners at all times throughout this activity by maintaining a solid grasp of one another and staff members must supervise carefully to ensure proper procedures are being followed.	
<b>REFERENCE</b> (ISBN 0-7872-0107-3) (1995). <i>Youth Leadership in Action</i> . (pp. 86–87). Dubuque, IA: Kendall/Hunt Publishing Company.	

<b>TEAM-BUILDING ACTIVITY</b>	<b>TRUST-BUILDING</b>
<b>SLICE &amp; DICE</b>	<b>TIME:</b> 10–15 min
<b>RESOURCES</b> A large, open space free from obstacles.	
<b>ACTIVITY LAYOUT</b> N/A.	
<b>ACTIVITY INSTRUCTIONS</b> <ol style="list-style-type: none"><li>1. Have the cadets line up in two separate lines facing each other approximately 1–1.5 m (3.5–5 feet) apart.</li><li>2. Select a volunteer to be the first walker.</li><li>3. Explain that upon starting the activity the cadets in the lines should start to swing their arms full stretch in front of them in a chopping motion, bringing the arms up and down in succession (as illustrated in Figure 3P-8). This activity should be started slowly and may pick up speed as the cadets get used to the motion.</li><li>4. Have the walker walk through the line of swinging arms at a steady pace.</li><li>5. As time allows, have as many walkers go through the line as possible.</li></ol>	
<b>SAFETY</b> Explain the following safety considerations to the group: <ul style="list-style-type: none"><li>• Members swinging their arms are to ensure they do not touch the walker.</li><li>• Walkers are to ensure they keep their eyes open.</li><li>• Walkers are to ensure they keep a steady pace while walking through the lines.</li></ul>	
<b>REFERENCE</b> (ISBN 0-934387-05-2) Collard, M. (2005). <i>No Props: Great Games With No Equipment</i> . (pp. 136–137). Beverly, MA: Project Adventure, Inc.	

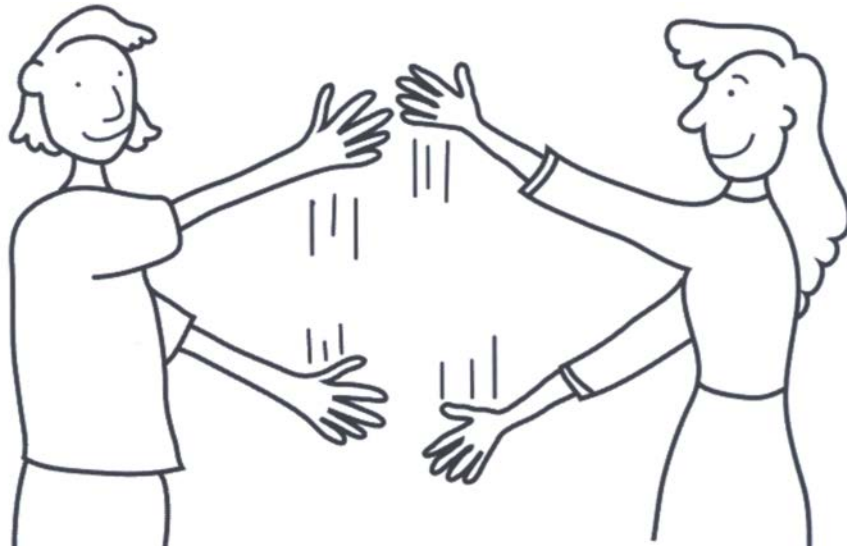

*M. Collard, No Props: Great Games With No Equipment, Project Adventure, Inc. (p. 136)*

Figure 3P-8 Slice and Dice

<b>TEAM-BUILDING ACTIVITY</b>	<b>TRUST-BUILDING</b>
<b>HOG CALL</b>	<b>TIME:</b> 10–15 min
<b>RESOURCES</b> <ul style="list-style-type: none"><li>• A large, open space free from obstacles, and</li><li>• Blindfolds (one per cadet).</li></ul>	
<b>ACTIVITY LAYOUT</b> <p>N/A.</p>	
<b>ACTIVITY INSTRUCTIONS</b> <ol style="list-style-type: none"><li>1. Have the cadets form two lines facing each other. The cadets facing each other will become partners. If there is an odd number, form one group of three.</li><li>2. Assign each group a matching set of words from the following list (or have cadets quickly come up with their own set of appropriate words):<ol style="list-style-type: none"><li>(a) peanut-butter,</li><li>(b) Coca-Cola,</li><li>(c) salt-pepper,</li><li>(d) bubble-gum,</li><li>(e) french-fry,</li><li>(f) Ken-Barbie,</li><li>(g) Power-Rangers,</li><li>(h) Batman-Robin,</li><li>(i) snap-crackle-pop, and</li><li>(j) Larry-Curly-Moe.</li></ol></li><li>3. Have each line move to opposite ends of the training space. Have each group turn away from the other and blindfold all of the cadets. Each group of cadets will mix themselves up among the other participants.</li><li>4. On a signal, have the cadets start the activity by shouting their partner’s word. For example, if your word was peanut, you would shout “butter” and your partner would shout “peanut” until you found each other.</li><li>5. Once partners find each other have them sit together and remove their blindfolds until all cadets have found their partners.</li></ol>	
<b>SAFETY</b> <p>All cadets are asked to place their hands in front of their torso with palms facing forward and elbows tucked in to avoid running into anything. The cadets are to move around the space cautiously to avoid running into anyone or anything.</p>	
<b>REFERENCE</b> <p>(ISBN 0-934387-05-2) Collard, M. (2005). <i>No Props: Great Games With No Equipment</i>. (pp. 126–127). Beverly, MA: Project Adventure, Inc.</p>	



<b>TEAM-BUILDING ACTIVITY</b>	<b>TRUST-BUILDING</b>
<b>HUG A TREE</b>	<b>TIME:</b> 15 min
<b>RESOURCES</b> <ul style="list-style-type: none"><li>• A large, open space (preferably outdoors with lots of obstacles), and</li><li>• Blindfolds (one per two cadets).</li></ul>	
<b>ACTIVITY LAYOUT</b> <p>N/A.</p>	
<b>ACTIVITY INSTRUCTIONS</b> <ol style="list-style-type: none"><li>1. Divide the cadets into pairs.</li><li>2. Blindfold one partner at a time and have the other cadet verbally guide them to an object that is at least 40–50 m (130–160 feet) away from the point from which they started.</li><li>3. Once led to the object (eg, a distinctive tree, fallen log, rock, etc) have the blindfolded cadet spend up to one minute getting acquainted with the object. The cadet should be encouraged to feel and smell the object.</li><li>4. Have the cadet who is not blindfolded guide the blindfolded cadet back to the starting point – preferably not using a direct line.</li><li>5. Upon arriving back at the starting point remove the blindfold.</li><li>6. Have the cadet who was blindfolded attempt to find the object that they were introduced to while they were blindfolded. Have their partner accompany them while they attempt to find the object but should not offer them any clues.</li><li>7. As time allows, have the cadets reverse roles.</li></ol>	
<b>SAFETY</b> <p>The cadet who is not blindfolded is to ensure the safety of the blindfolded cadet at all times throughout this activity.</p>	
<b>REFERENCE</b> <p>(ISBN 0-934387-05-2) Collard, M. (2005). <i>No Props: Great Games With No Equipment</i>. (pp. 122–123). Beverly, MA: Project Adventure, Inc.</p>	

<b>TEAM-BUILDING ACTIVITY</b>	<b>TRUST-BUILDING</b>
<b>BLINDFOLD BUILD</b>	<b>TIME:</b> 15 min
<b>RESOURCES</b> <ul style="list-style-type: none"><li>• A large, open space free from obstacles,</li><li>• Blindfolds (one per two cadets), and</li><li>• Building blocks (minimum 40).</li></ul>	
<b>ACTIVITY LAYOUT</b> <p>N/A.</p>	
<b>ACTIVITY INSTRUCTIONS</b> <ol style="list-style-type: none"><li>1. Divide the cadets into two even groups. Blindfold the cadets from one group.</li><li>2. Use the building blocks to build a structure with half of the blocks while the non-blindfolded cadets watch. Give them one minute to study the structure.</li><li>3. Hide the structure and scatter the other half of the pieces around the space.</li><li>4. Have the non-blindfolded cadets guide the blindfolded cadets to build the same structure. The non-blindfolded cadets must not touch any building blocks.</li><li>5. Once the structure is complete, have the cadets remove their blindfolds. Inform the group how close they were to the original.</li><li>6. As time allows, have the cadets reverse roles.</li></ol>	
<b>SAFETY</b> <p>N/A.</p>	
<b>REFERENCE</b> <p>(ISBN 0-9662341-6-2) Jones, A. (1999). <i>Team-Building Activities for Every Group</i>. (pp. 66–67). Richland, WA: Rec Room Publishing.</p>	

<b>TEAM-BUILDING ACTIVITY</b>	<b>TRUST-BUILDING</b>
<b>LIGHTHOUSE</b>	<b>TIME:</b> 10–15 min
<b>RESOURCES</b>	
<ul style="list-style-type: none"><li>• A large, open space,</li><li>• Various obstacles (eg, desks, chairs, boxes, crates, pylons, etc),</li><li>• Blindfold, and</li><li>• Pieces of wrapped candy (one piece per lighthouse).</li></ul>	
<b>ACTIVITY LAYOUT</b>	
Set up obstacles around the training area.	
<b>ACTIVITY INSTRUCTIONS</b>	
<ol style="list-style-type: none"><li>1. Have one cadet volunteer to be the “cargo ship”. Blindfold this cadet.</li><li>2. Have three or four cadets stand at various points among the obstacles. These cadets will be the “lighthouses”.</li><li>3. Give the “cargo ship” three or four pieces of the wrapped candy.</li><li>4. Explain that the job of each “lighthouse” is to guide the “cargo ship” through the rough waters (obstacle course) so the cargo (wrapped candy) can be delivered to each “lighthouse” safely.</li><li>5. Have the “lighthouse” closest to the start point verbally guide the “cargo ship” safely to their “lighthouse”. If successful, the “cargo ship” should deliver the cargo (a piece of candy) to that person.</li><li>6. Have each “lighthouse” guide the “cargo ship” to them in succession as the “cargo ship” makes their way through the rough water (obstacles).</li><li>7. The only “lighthouse” allowed to give directions at a given time is the one the “cargo ship” is headed toward. If the “cargo ship” is in danger of crashing into an obstacle the guiding lighthouse does not receive their shipment of cargo. As well if the “lighthouse” is unable to successfully guide them to the “lighthouse” and the “cargo ship” passes by, they do not receive their shipment of cargo and the next “lighthouse” takes over the directions.</li><li>8. As time allows, have the cadets change positions and assume different roles.</li></ol>	
<b>SAFETY</b>	
The cadets acting as lighthouses are to ensure the safety of the cargo ship throughout the activity.	
<b>REFERENCE</b>	
(ISBN 0-9662341-6-2) Jones, A. (1999). <i>Team-Building Activities for Every Group</i> . (pp. 88–89). Richland, WA: Rec Room Publishing.	

<b>TEAM-BUILDING ACTIVITY</b>	<b>TRUST-BUILDING</b>
<b>TRUST TAG</b>	<b>TIME:</b> 15 min
<b>RESOURCES</b> <ul style="list-style-type: none"><li>• A large, open space free of obstacles, and</li><li>• Blindfolds (one per two cadets).</li></ul>	
<b>ACTIVITY LAYOUT</b> <p>Mark off a playing area.</p>	
<b>ACTIVITY INSTRUCTIONS</b> <ol style="list-style-type: none"><li>1. Divide the cadets into pairs. Blindfold one cadet from each pair.</li><li>2. Designate one pair to be “it”.</li><li>3. Have the blindfolded cadets play a game of tag while their partners verbally guide them through the game. The cadets are to walk for this activity, not run. The non-blindfolded cadet of the team who is “it” must attempt to guide their partner to tag someone. The non-blindfolded cadets of the other partners must attempt to guide their partners away from the cadet who is “it”.</li><li>4. Halfway through the time, have the cadets reverse roles.</li></ol>	
<b>SAFETY</b> <ul style="list-style-type: none"><li>• The cadets who are not blindfolded are to ensure the safety of the blindfolded cadets at all times throughout this activity.</li><li>• Cadets are not permitted to run.</li></ul>	
<b>REFERENCE</b> <p>(ISBN 0-9662341-6-2) Jones, A. (1999). <i>Team-Building Activities for Every Group</i>. (pp. 102–103). Richland, WA: Rec Room Publishing.</p>	

### TEAM-BUILDING PLANNING GUIDE

<b>TEAM-BUILDING ACTIVITY</b>	<b>Type:</b> _____
<b>Name of Activity:</b> _____	<b>Time:</b> ____ minutes
<b>QUESTIONS TO THE INSTRUCTOR</b>	
<b>TIME APPRECIATION</b>	
<b>Introduction:</b>	
<b>Conduct of Activity:</b>	
<b>Debriefing:</b>	
<b>ACTIVITY LAYOUT</b>	
<b>ACTIVITY INSTRUCTIONS</b>	
<b>SAFETY</b>	
<b>DEBRIEFING QUESTIONS</b>	

THIS PAGE INTENTIONALLY LEFT BLANK

**SELF-ASSESSMENT FORM – LEAD A TEAM-BUILDING ACTIVITY**

1. How did you feel after leading a team-building activity?

---

---

---

---

---

2. How did you feel about the teamwork among the members? How did this affect your experience in leading the activity?

---

---

---

---

---

3. Which aspects did you feel went well while leading the activity? Which aspects did you feel did not go so well? Why?

---

---

---

---

---

4. What would you do differently given another opportunity lead a team-building activity?

---

---

---

---

---

THIS PAGE INTENTIONALLY LEFT BLANK



## **OUTLINE FOR DELIVERING A PRESENTATION ABOUT A LEADER**

Use the information and techniques discussed from PO 309 (Instruct a Lesson, Chapter 9) while delivering this presentation.

This presentation is another opportunity to practice presentation skills.

This presentation is to be no less than 7 minutes and no more than 10 minutes long. Notes may be used to deliver this presentation. Presentation aids may be used during the delivery of the presentation (eg, whiteboard/flip chart/OHP/multimedia projector/handouts).

This presentation will not be evaluated for delivery or content, however each cadet should do their best.

### **Introduction**

- Name of the leader,
- Date and place of birth,
- Date of death (if applicable),
- Display a picture of the leader (if available), and
- Information about the childhood of the leader.

### **Body**

- Interesting points of the leader's career, to include:
  - positions of responsibility (if applicable), and
  - incidents where they used their influence,
- How and where the core leadership qualities were displayed by the leader, and
- Other interesting facts about the leader.

### **Conclusion**

- Why you chose this leader,
- Three questions to ensure confirmation of the presentation, and
- A final summary sentence about the leader.

THIS PAGE INTENTIONALLY LEFT BLANK

**CHAPTER 4**

**PO X04 – TRACK PARTICIPATION IN PHYSICAL ACTIVITIES**





**COMMON TRAINING**  
**ALL TRAINING LEVELS**  
**INSTRUCTIONAL GUIDE**  
**PERSONAL FITNESS**  
**AND HEALTHY LIVING**



**PO X04 – TRACK PARTICIPATION IN PHYSICAL ACTIVITIES**

---

Total Time:

---

For the following EOs, refer to the lesson specifications located in A-CR-CCP-701/PG-001, *Royal Canadian Army Cadets Green Star Qualification Standard and Plan*:

- CX04.01 – Participate in the Cadet Fitness Assessment and Identify Strategies for Improving Personal Physical Fitness,
- CX04.03 – Participate in a Cooking Class,
- CX04.04 – Attend a Personal Fitness and Healthy Living Presentation, and
- CX04.05 – Attend a Local Amateur Sporting Event.

For the following EOs, refer to the instructional guides located in A-CR-CCP-701/PF-001, *Royal Canadian Army Cadets Green Star Instructional Guides*:

- MX04.01 – Participate in 60 Minutes of Moderate- to Vigorous-Intensity Physical Activity (MVPA) and Track Participation in Physical Activities,
- MX04.02 – Identify Strategies to Improve Participation in Physical Activities and Participate in the Cadet Fitness Assessment,
- MX04.03 – Participate in the Cadet Fitness Assessment and Identify Strategies for Improving Personal Physical Fitness, and
- CX04.02 – Participate in Activities that Reinforce the Three Components of Physical Fitness.

THIS PAGE INTENTIONALLY LEFT BLANK

**CHAPTER 5**

**PO X05 – PARTICIPATE IN PHYSICAL ACTIVITIES**







**COMMON TRAINING  
ALL TRAINING LEVELS  
INSTRUCTIONAL GUIDE  
PHYSICAL ACTIVITIES**



**PO X05 – PARTICIPATE IN PHYSICAL ACTIVITIES**

---

Total Time:

---

For the following EOs, refer to the instructional guides located in A-CR-CCP-701/PF-001, *Royal Canadian Army Cadets Green Star Instructional Guides*:

- MX05.01 – Participate in Physical Activities,
- CX05.01 – Participate in Physical Activities, and
- CX05.02 – Participate in a Tournament.

THIS PAGE INTENTIONALLY LEFT BLANK

**CHAPTER 6**

**PO 306 – FIRE THE CADET AIR RIFLE DURING RECREATIONAL MARKSMANSHIP**





**COMMON TRAINING**  
**SILVER STAR**  
**INSTRUCTIONAL GUIDE**



**SECTION 1**

**EO M306.01 – PARTICIPATE IN A RECREATIONAL MARKSMANSHIP ACTIVITY**

Total Time:

90 min

---

**PREPARATION**

---

**PRE-LESSON INSTRUCTIONS**

Resources needed for the delivery of this lesson are listed in the lesson specification located in A-CR-CCP-703/PG-001, Chapter 4. Specific uses for said resources are identified throughout the instructional guide within the TP for which they are required.

Review the lesson content, unit range standing orders, and become familiar with the material prior to delivering the lesson.

Photocopy the targets located at Annexes B to J as required.

Construct a range IAW A-CR-CCP-177/PT-001, *Canadian Cadet Movement: Cadet Marksmanship Program Reference Manual*.

**PRE-LESSON ASSIGNMENT**

N/A.

**APPROACH**

A practical activity was chosen for this lesson as it is an interactive way to allow the cadet to experience recreational marksmanship in a safe and controlled environment. This activity contributes to the development of marksmanship skills and knowledge in a fun and challenging setting.

---

**INTRODUCTION**

---

**REVIEW**

The review for this lesson will be from EO M106.02 (Carry Out Safety Precautions on the Cadet Air Rifle, A-CR-CCP-701/PF-001, Chapter 6, Section 2).

**QUESTIONS**

- Q1. Why do we follow safety regulations?
- Q2. How would you verify the safety catch is ON?
- Q3. What are the four “ACTS” of firearm safety?

## ANTICIPATED ANSWERS

A1. We follow safety regulations to prevent accidents with the cadet air rifle.

A2. When the safety is ON, no red can be seen.

A3. The mnemonic "ACTS" stands for:

- Assume every firearm is loaded.
- Control the muzzle direction at all times.
- Trigger finger must be kept off the trigger and out of the trigger guard.
- See that the firearm is unloaded (prove it safe).

## OBJECTIVES

By the end of this lesson the cadet shall have participated in a recreational marksmanship activity.

## IMPORTANCE

It is important for cadets to participate in a recreational marksmanship activity because it allows them to experience marksmanship in a fun, dynamic and safe setting.

---

### Teaching Point 1

### Supervise the Participation of the Cadet in a Recreational Marksmanship Activity

Time: 80 min

Method: Practical Activity

---



A range briefing is conducted to pass on vital information and answer any questions the cadets may have prior to participating in a marksmanship activity. The range briefing is required to ensure the safe execution of a marksmanship activity.

## CONDUCT A RANGE BRIEFING

1. Explain pertinent sections of the local range standing orders.
2. Review general rules observed on all ranges, to include:
  - (a) proving that rifles are safe prior to being picked up, handed to or received from another person;
  - (b) never pointing rifles at people;
  - (c) inserting safety rods into the barrels of rifles when not in use on the range;
  - (d) never horseplaying on a range;
  - (e) always pointing rifles down range; and
  - (f) following the Range Safety Officer's (RSO) directions and orders at all times.



Review range commands with an explanation and demonstration for each command.  
All loading/firing is to be simulated.

3. Review commands used on an air rifle range (as illustrated in Figure 6-1-1).

Command	Action to Be Taken
<b>Cover Off Your Firing Point</b>	Stand up, move behind the firing point and await further commands.
<b>Place Your Equipment Down and Stand Back</b>	Lay the equipment down on the mat and stand back when finished.
<b>Adopt the Prone Position</b>	Adopt the prone position, pick up the rifle, ready the equipment and put on hearing and eye protection.
<b>Type of Firing (GRIT)</b>	<p>GRIT is the acronym for:</p> <ol style="list-style-type: none"> <li>1. Group (relay),</li> <li>2. Range (distance),</li> <li>3. Indication (number of rounds), and</li> <li>4. Type (grouping, scored).</li> </ol>
<b>Relay, Load</b>	<ol style="list-style-type: none"> <li>1. Pick up and hold the rifle with the dominant hand.</li> <li>2. Ensure the safety catch is in the “ON” position.</li> <li>3. Pump the rifle, observing a three second pause.</li> <li>4. Load a pellet (flat end forward).</li> <li>5. Close the bolt.</li> </ol>
<b>Relay, Fire</b>	<ol style="list-style-type: none"> <li>1. Place the safety catch in the “OFF” position.</li> <li>2. Aim the rifle at the target.</li> <li>3. Squeeze the trigger.</li> <li>4. Open the bolt.</li> <li>5. Repeat the following sequence for each shot: <ol style="list-style-type: none"> <li>(a) Pump the rifle, observing a three second pause.</li> <li>(b) Load a pellet (flat end forward).</li> <li>(c) Close the bolt.</li> <li>(d) Aim the rifle at the target.</li> <li>(e) Squeeze the trigger.</li> <li>(f) Open the bolt.</li> </ol> </li> <li>6. Place the safety in the “ON” position.</li> <li>7. Partially open the pump lever.</li> <li>8. Lay down the rifle.</li> </ol>

*Director Cadets 3, 2006, Ottawa, ON: Department of National Defence*

Figure 6-1-1 Air Rifle Range Commands

4. Describe the layout of the air rifle range.
5. Review hand-washing procedures on completion of firing. This is important because each time a person handles pellets, a small trace of lead is left on their hands. To decrease the risk of lead poisoning, it is important that all persons wash their hands thoroughly after handling pellets.



---

**ACTIVITY**

---

**OBJECTIVE**

The objective of this activity is to provide the cadet the opportunity to participate in a recreational marksmanship activity.

**RESOURCES**

- Cadet air rifle (one per firing lane),
- Cadet air rifle sling (one per cadet),
- Air rifle pellets,
- Target frame,
- Suitable target,
- Shooting mat,
- Safety glasses/goggles, and
- Pen/pencil.



Additional resources required for specific marksmanship activities may be found in the annexes.

**ACTIVITY LAYOUT**

N/A.

**ACTIVITY INSTRUCTIONS**

1. Brief cadets on safety rules or any other guidelines pertaining to the activity.
2. Divide the cadets into relays according to the number of firing lanes.
3. Conduct a recreational marksmanship activity, choosing from the following categories:
  - (a) classification (see Annex A),
  - (b) fun activities (see Annexes B to E),
  - (c) timed activities (see Annexes F to H), or
  - (d) competitive team/individual activities (see Annexes I and J).



If EO C306.03 (Adopt the Standing Position With the Cadet Air Rifle, Section 4) has been taught prior to this marksmanship activity, this EO may be conducted in the standing position.

## **SAFETY**

Range activities will be conducted IAW A-CR-CCP-177/PT-001.

---

### **END OF LESSON CONFIRMATION**

---

The cadets' participation in the activity will serve as the confirmation of this lesson.

---

### **CONCLUSION**

---

## **HOMEWORK/READING/PRACTICE**

N/A.

## **METHOD OF EVALUATION**

N/A.

## **CLOSING STATEMENT**

Marksmanship is a fun and exciting activity that requires personal discipline and teamwork skills. This activity has also developed into highly competitive levels at the provincial, regional, and national levels.

## **INSTRUCTOR NOTES/REMARKS**

Hand-washing stations must be available for cleanup after the activity is completed.

Cadets may fire in the standing position if they have previously received the training during EO C306.03 (Adopt the Standing Position With the Cadet Air Rifle, Section 4).

---

### **REFERENCES**

---

- A0-027 A-CR-CCP-177/PT-001 Director Cadets 3. (2005). *Canadian Cadet Movement: Cadet Marksmanship Program Reference Manual*. Ottawa, ON: Department of National Defence.
- A0-041 Director Cadets 4. (2007). CATO 14-41, *Marksmanship, Rifles and Ammunition*. Ottawa ON: Department of National Defence.



**COMMON TRAINING**  
**SILVER STAR**  
**INSTRUCTIONAL GUIDE**



**SECTION 2**

**EO C306.01 – IDENTIFY CIVILIAN MARKSMANSHIP ORGANIZATIONS**

Total Time:

30 min

---

**PREPARATION**

---

**PRE-LESSON INSTRUCTIONS**

Resources needed for the delivery of this lesson are listed in the lesson specification located in A-CR-CPP-703/PG-001, Chapter 4. Specific uses for said resources are identified throughout the instructional guide within the TP for which they are required.

Review the lesson content and become familiar with the material prior to delivering the lesson.

Consult the Internet or local telephone directory to identify the national, provincial and local civilian marksmanship organizations applicable to the corps.

**PRE-LESSON ASSIGNMENT**

N/A.

**APPROACH**

An interactive lecture was chosen for this lesson to orient the cadet to opportunities available to enhance their marksmanship training with civilian organizations.

---

**INTRODUCTION**

---

**REVIEW**

N/A.

**OBJECTIVES**

By the end of this lesson the cadet shall have identified opportunities to enhance their marksmanship training with civilian organizations.

**IMPORTANCE**

It is important for the cadets to identify local civilian marksmanship organizations and understand that the activities available through these organizations are personal and not supported by the Cadet Program. Civilian marksmanship organizations assist people who are interested in marksmanship.

**Teaching Point 1****Discuss Local Civilian Marksmanship Organizations**

Time: 5 min

Method: Interactive Lecture



Inform the cadets of a local civilian marksmanship organization and identify available activities and requirements for membership.

Civilian marksmanship organizations and rifle associations are popular throughout the world and are found in many countries. Traditionally formed to augment the military, marksmanship organizations now have become governing bodies for civilians interested in marksmanship.

Local civilian marksmanship organizations exist in most major cities in Canada. These organizations can include the city or regional rifle associations or local rod and gun clubs. These organizations usually have a small calibre rifle range available for their members' use. To find local civilian marksmanship organizations, refer to the Internet or the local telephone listings.

**CONFIRMATION OF TEACHING POINT 1****QUESTIONS**

- Q1. Why were civilian marksmanship organizations traditionally formed?
- Q2. What are some examples of these organizations?
- Q3. How would you find some organizations in your area?

**ANTICIPATED ANSWERS**

- A1. They were traditionally formed to augment the military.
- A2. City or regional rifle associations or local rod and gun clubs.
- A3. Refer to the internet or local telephone listings.

**Teaching Point 2****Discuss the Applicable Provincial Rifle Organizations**

Time: 10 min

Method: Interactive Lecture

**PROVINCIAL RIFLE ORGANIZATIONS**

Select the rifle association for the province in which the cadet corps is located.



Civilian marksmanship organizations assist people interested in marksmanship to advance their skills in marksmanship. These activities are not supported by the Cadet Program.

Provincial rifle associations are the provinces' governing bodies on fullbore and smallbore target shooting. These associations exist to promote marksmanship within the province by organizing events and competitions. Provincial rifle associations also provide competitions for cadet units within their province. Provincial associations include:

**Alberta Provincial Rifle Association.** The Alberta Provincial Rifle Association (APRA) was created in 1902, as the Territorial Rifle Association, before the Province of Alberta was created. The objectives of the APRA are:

- to promote in every lawful way the interests of small arms marksmanship in the Province of Alberta;
- to promote annual prize meetings for individuals and teams and to offer prizes for skill in shooting;
- to encourage the establishment and maintenance of suitable ranges through legislation and private means;
- to assist in the formation of shooting clubs; and
- to create public interest for the encouragement of small arms shooting both as a sport and as a necessary means of national defence;

The APRA can be found on the Internet at [www.albertarifle.com](http://www.albertarifle.com).

**British Columbia Rifle Association.** The British Columbia Rifle Association (BCRA) was created in 1874, incorporated in 1910, and is one of the oldest members of the British Columbia Societies Act. The objectives of the BCRA are:

- to create a public sentiment for the encouragement of small arms shooting as a sport; and
- the control and safe handling of firearms and as a necessary part of national defence.

Through the Department of National Defence, members are permitted to participate in shooting events held on military rifle ranges in British Columbia.

The BCRA can be found on the Internet at [www.bcrifle.org](http://www.bcrifle.org).

**Manitoba Provincial Rifle Association.** The Manitoba Provincial Rifle Association Inc. (MPRA) was created in 1872, for the purpose of encouraging rifle shooting among the militia and citizens of Manitoba. The objectives of the MPRA are:

- to enhance the perception of shooting as a sport by encouraging and supporting all athletes involved in shooting to achieve their maximum performance levels; and
- to promote safe firearms handling.



The Honourable D.A. Smith (Lord Strathcona) was a patron of the MPRA for 40 years. He took an interest in shooting and donated many prizes, especially to cadets.

The MPRA can be found on the Internet at [www.manitobarifle.ca](http://www.manitobarifle.ca).

**Newfoundland Provincial Rifle Association.** The Newfoundland Provincial Rifle Association can be contacted through the Dominion of Canada Rifle Association (DCRA).

**Nova Scotia Rifle Association.** The Nova Scotia Rifle Association (NSRA) was created in 1861, and is the oldest provincial rifle association. The objectives of the NSRA are:

- to foster the safe and responsible use of firearms, and
- to develop marksmanship skills.

The NSRA can be found on the Internet at [www.nsrifle.org](http://www.nsrifle.org).

**Ontario Provincial Rifle Association.** The Ontario Provincial Rifle Association (ORA) was created in 1868. The objectives of the ORA are:

- to provide opportunities for shooting with different types of rifles; and
- offer programs for marksman from beginner to world class.

The ORA can be found on the Internet at [www.ontariorifleassociation.org](http://www.ontariorifleassociation.org).

**Prince Edward Island Rifle Association.** The Prince Edward Island Rifle Association can be contacted through the DCRA.

**Province of Quebec Rifle Association.** The Province of Quebec Rifle Association (PQRA) was created in 1869 and supports various shooting clubs and associations. The objective of the PQRA is to teach and promote marksmanship in competitive and recreational environments, where safety is first and foremost.

The PQRA can be found on the Internet at [www.pqra.org](http://www.pqra.org).

**Royal New Brunswick Rifle Association.** The Royal New Brunswick Rifle Association (RNBRA) was created in 1866 to serve all shooting and related disciplines in New Brunswick. The objectives of the RNBRA are to promote:

- good sportsmanship,
- safe, efficient and practical arms handling, and
- good marksmanship by civilians, civic police and the military.

The RNBRA can be found on the Internet at [www.rnbra.ca](http://www.rnbra.ca).

**Saskatchewan Provincial Rifle Association.** The Saskatchewan Provincial Rifle Association (SPRA) is the governing body for fullbore target rifle shooting in Saskatchewan. The objectives of the SPRA are to promote:

- the pursuit of excellence in marksmanship; and
- the safe and responsible handling of firearms.

The SPRA can be found on the Internet at [www.saskrifle.ca](http://www.saskrifle.ca).

---

## CONFIRMATION OF TEACHING POINT 2

---

### QUESTIONS

- Q1. What is the objective of provincial rifle associations?
- Q2. How do these rifle associations meet this objective?
- Q3. How do these associations support the cadet movement?

### ANTICIPATED ANSWERS

- A1. To promote marksmanship within the province.
- A2. By organizing marksmanship events and competitions.
- A3. By providing competitions for cadet units within their province.

---

**Teaching Point 3****Discuss National Marksmanship Organizations**

Time: 5 min

Method: Interactive Lecture

---

**NATIONAL MARKSMANSHIP ORGANIZATIONS****The DCRA**

The DCRA, headquartered at Connaught Ranges Primary Training Centre, Ottawa, Ont., is Canada's national governing body for fullbore and smallbore target shooting. The DCRA was founded in 1868 and incorporated by parliament in 1890, to encourage marksmanship training in response to the departure of the British military and the Fenian Raids in 1866.



The Fenian Raids were attacks on British targets in Canada between 1866 and 1871, to pressure Britain to withdraw from Ireland. Most of the raids were successfully repelled by British forces and local militias.

The DCRA continues to promote excellence in civilian and military marksmanship.

The DCRA works with the CCM by organizing events and competitions including postal championships held for cadet units across the country and summer matches for the National Rifle Team (NRT) and Canadian and British army cadets on CSTC courses at Connaught NACSTC.

The DCRA can be found on the internet at [www.dkra.ca](http://www.dkra.ca).



Section One of the DCRA postal championships are matches that are restricted to sea, army and air cadets. Section Two is open to any junior team and cadets are encouraged to enter.

**The Shooting Federation of Canada (SFC)**

The SFC, headquartered at Connaught Ranges Primary Training Centre, Ottawa, Ont., is Canada's national sport governing body for recreational and competitive target shooting in Canada. The SFC is the authority for the marksmanship technical training portion of the National Coaching Certification Program (NCCP).

The SFC can be found on the internet at [www.sfc-ffc.ca](http://www.sfc-ffc.ca).

---

**CONFIRMATION OF TEACHING POINT 3**

---

**QUESTIONS**

- Q1. What are the two National Marksmanship Organizations in Canada?
- Q2. How does the DCRA work with the NRT?
- Q3. How does the DCRA work with cadet units across Canada?

**ANTICIPATED ANSWERS**

- A1. The Dominion of Canada Rifle Association and the Shooting Federation of Canada.
- A2. The DCRA works with the NRT by organizing events and competitions during the summer.
- A3. The DCRA conducts postal matches held for cadet units across the country.

---

**Teaching Point 4****Identify the Applicable National/Provincial Biathlon Organizations**

Time: 5 min

Method: Interactive Lecture

---

**BIATHLON CANADA**

Biathlon Canada is the governing body for the sport of biathlon within Canada. Biathlon Canada organizes many events, competitions and programs, including the Biathlon Bears Program, which is a community program, offered across Canada. The Biathlon Bears program is open to novices and the training is tailored to the athlete's skill level. This program offers training to develop both skiing and marksmanship skills. As skills are learned and mastered, the biathlete progresses to the next Biathlon Bear level.

**PROVINCIAL AND TERRITORIAL BIATHLON ORGANIZATIONS**

Divisions of Biathlon Canada are located within many of the provinces and territories. These division offices run training and offer support to the local resorts/clubs. These divisions include:

- Biathlon Alberta,
- Biathlon British Columbia,
- Biathlon Manitoba,
- Biathlon New Brunswick,
- Biathlon Nova Scotia,
- Biathlon Newfoundland and Labrador,
- Biathlon Ontario,
- Biathlon Quebec,
- Biathlon Saskatchewan,
- Biathlon Yukon, and
- Northwest Territories Biathlon.

---

**CONFIRMATION OF TEACHING POINT 4**

---

**QUESTIONS**

- Q1. What organization is the governing body for the sport of biathlon within Canada?
- Q2. What community biathlon program is offered across Canada?
- Q3. What are the objectives of the provincial and territorial organizations?

**ANTICIPATED ANSWERS**

- A1. Biathlon Canada is the governing body within Canada.
- A2. Biathlon Bears is offered across Canada.
- A3. To run training and offer support to the local resorts/clubs.



---

**END OF LESSON CONFIRMATION**

---

**QUESTIONS**

- Q1. What are the Canadian national marksmanship organizations?
- Q2. What marksmanship organizations are in your province/territory?
- Q3. Which of these organizations is your cadet corps active with?

**ANTICIPATED ANSWERS**

- A1. The DCRA, SFC and Biathlon Canada.
- A2. Answers will vary by province/territory.
- A3. Answers will depend on cadet corps.

---

**CONCLUSION**

---

**HOMEWORK/READING/PRACTICE**

N/A.

**METHOD OF EVALUATION**

N/A.

**CLOSING STATEMENT**

Identifying opportunities with civilian marksmanship organizations, one will know where they can acquire additional marksmanship training that is not supported by the Cadet Program. The opportunities provided by these organizations could enhance one's sense of accomplishment through improved marksmanship skills and allow them to choose activities in which they would like to participate.

**INSTRUCTOR NOTES/REMARKS**

Have the cadets identify only the applicable national, provincial and local marksmanship organizations.

---

**REFERENCES**

---

- A0-119 Shooting Federation of Canada. (2007). *Shooting Federation of Canada*. Retrieved November 2, 2007, from [www.sfc-ftc.ca/document.cfm?sectionID=39](http://www.sfc-ftc.ca/document.cfm?sectionID=39).
- C0-149 Biathlon Canada. (2005). *Biathlon Bears: Community Coaching*. Ottawa, ON: Biathlon Canada.
- C2-086 Dominion of Canada Rifle Association. (2007). *History*. Retrieved October 4, 2007, from [www.dkra.ca/history.htm](http://www.dkra.ca/history.htm).

THIS PAGE INTENTIONALLY LEFT BLANK



**COMMON TRAINING**  
**SILVER STAR**  
**INSTRUCTIONAL GUIDE**



**SECTION 3**

**EO C306.02 – CORRECT MARKSMANSHIP ERROR**

---

Total Time:

60 min

---

**PREPARATION**

---

**PRE-LESSON INSTRUCTIONS**

Resources needed for the delivery of this lesson are listed in the lesson specification located in A-CR-CCP-703/PG-001, Chapter 4. Specific uses for said resources are identified throughout the instructional guide within the TP for which they are required.

Review the lesson content and become familiar with the material prior to delivering the lesson.

Photocopy Annexes K and L for each cadet.

Photocopy the answer key located at Annex M for the instructor and assistant instructors.

Set up a mock firing point.

**PRE-LESSON ASSIGNMENT**

N/A.

**APPROACH**

An interactive lecture was chosen for TPs 1–3 to give an overview of the theories and the practice of adjusting sights.

A practical activity was chosen for TP 4 as it is an interactive way to introduce and allow cadets to experience adjusting sights on the cadet air rifle in a controlled environment. This activity contributes to the development of sight adjustment skills and knowledge in a fun and challenging setting.

---

**INTRODUCTION**

---

**REVIEW**

N/A.

**OBJECTIVES**

By the end of this lesson the cadet is expected to correct marksmanship error by adjusting elevation and windage on the cadet air rifle.

## IMPORTANCE

It is important for the cadets to learn how to correct marksmanship error in order to zero the cadet air rifle when participating in a marksmanship activity. A zeroed rifle will give the marksman the assurance that the centre of the target is properly aligned with themselves and their rifle. Having a zeroed rifle and knowing how to zero a rifle is important to every marksman in order to achieve a higher score in application activities.

---

### Teaching Point 1

### Explain Centring the Group

Time: 10 min

Method: Interactive Lecture

---

## THE THEORY OF A GROUP

When a series of three or more shots are fired from the same point of aim, they will seldom pass through the same point on the target. The pattern that is produced from the shot holes in the target is called a group.

### Factors Affecting the Group

There are three factors that affect the shape and size of the group:

- **The Ammunition.** Even though every pellet is manufactured to be exactly the same, slight variations in each pellet will result in slight variations in results when firing. The number of pellets used will also affect the group size.
- **The Rifle.** Each rifle will fire a pellet with its own slight variation due to small differences in the barrel and firing mechanisms.
- **The Marksman.** Factors associated with the marksman's aiming, holding, breathing and follow-through techniques will affect each shot.

## MEAN POINT OF IMPACT (MPI)



Ensure the handout located at Annex K is passed out to the cadets during this portion of the lesson to allow the cadets to see how the MPI moves as more pellets are shot into the target.

The MPI is the point on the target which is the average centre between all shots on the target. As each shot is fired, the MPI changes as the group develops. To centre the group correctly, corrections should be based on the MPI.

To determine the MPI, each shot must be evaluated. It takes at least two shots for an MPI to be determined. For two shots, the MPI will be the point centred between the two shots. After firing three shots, the MPI will change so that the MPI is centred between all three shots (as illustrated in Figure 6-3-1).

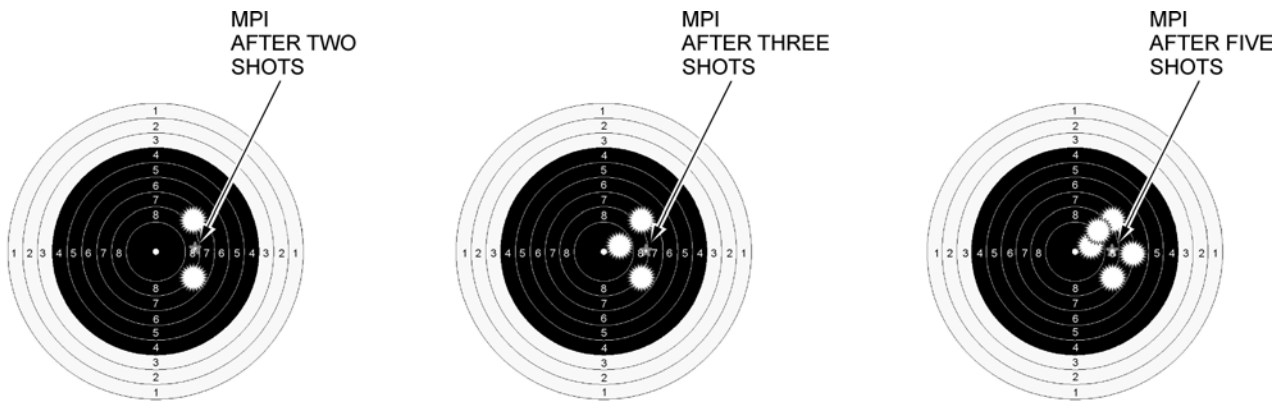

Director Cadets 3, 2007, Ottawa, ON: Department of National Defence

Figure 6-3-1 MPI Examples

---

### CONFIRMATION OF TEACHING POINT 1

---

#### QUESTIONS

- Q1. Define the term group.
- Q2. What are the three factors that affect the size and shape of the group?
- Q3. What is the definition of MPI?

#### ANTICIPATED ANSWERS

- A1. The pattern that is produced from the shot holes in a target.
- A2. The three factors that affect the shape and size of the group:
- the ammunition,
  - the rifle, and
  - the marksman.
- A3. The MPI is the point on the target which is the average centre between all shots on the target.

---

#### Teaching Point 2

#### Explain Sight Adjustment

Time: 10 min

Method: Interactive Lecture

---

#### THE PURPOSE OF SIGHT ADJUSTMENT

Sight adjustment is used to ensure that the rifle is zeroed to the marksman. Sight adjustment will not make up for poor marksmanship skills, but may aid the proficient marksman in aligning their grouping to a target. There are two different ways a sight can be adjusted in order to zero the rifle: the windage and the elevation.

#### ELEVATION

Elevation affects the pellet by moving its vertical position, which moves the point of impact up or down the target. It compensates for the trajectory drop of the pellet.

## WINDAGE

Windage affects the pellet by moving its horizontal position, which moves the point of impact left or right. It compensates for the direction and force of the wind on the pellet.

## A ZEROED CADET AIR RIFLE

A zeroed cadet air rifle is accurate for a particular marksman at a particular position and distance from the target. A zeroed cadet air rifle has a particular sight setting that will be perfectly aimed, by putting pellets directly into the centre of the target.

---

### CONFIRMATION OF TEACHING POINT 2

---

#### QUESTIONS

- Q1. What is the purpose of adjusting the sights on a rifle?
- Q2. What does the elevation adjustment refer to?
- Q3. What does the windage adjustment refer to?

#### ANTICIPATED ANSWERS

- A1. Sight adjustment is used to ensure the rifle is zeroed to the marksman.
- A2. Elevation adjustment refers to the adjustment required to compensate for the trajectory drop of the pellet.
- A3. Windage adjustment refers to the adjustment required to compensate for the direction and force of the wind on the pellet.

---

#### Teaching Point 3

#### Explain the Increments of Sight Adjustment

Time: 5 min

Method: Interactive Lecture

---



Ensure the cadets have a cadet air rifle in front of them during this portion of the lesson in order to see the actual sight of the cadet air rifle and the means in which it functions.

#### SIGHT ADJUSTMENT OF THE CADET AIR RIFLE

Sight adjustment of the cadet air rifle is achieved by turning the knobs of the rear sight. The elevation adjustment knob is found on the top of the rear sight and the windage elevation knob is found on the right-hand side of the rear sight. They are used to move the MPI of the shot either left or right and up or down. The adjustment of these knobs is measured in clicks that can be felt as the knob is turned. It takes three clicks to move the point of impact approximately one pellet width in any direction.

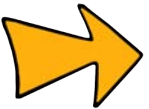

At a distance of 10 m, each click equals approximately a 1.219 mm shift of the MPI.

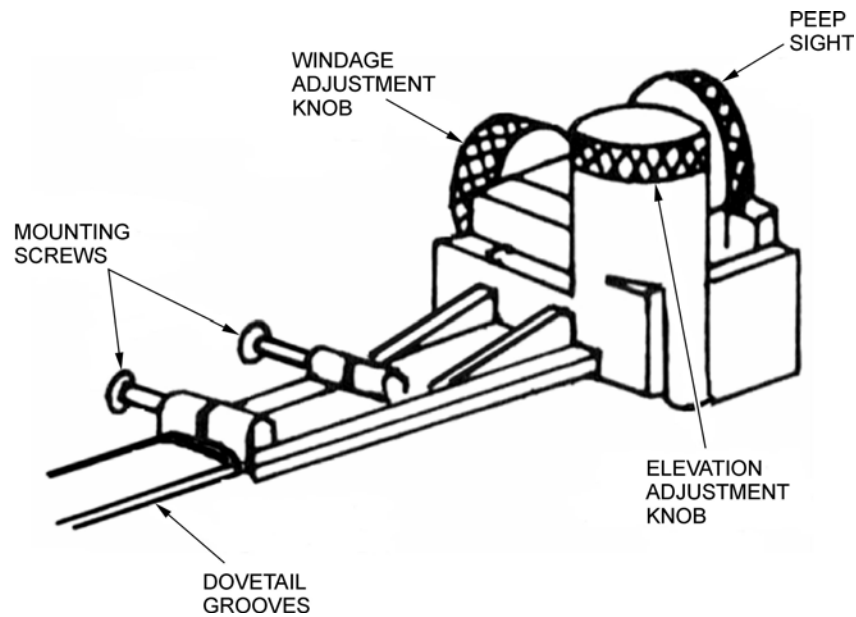

Rogers, AR., AVANTI Competition Pellet Rifle: Operation Manual: AVANTI Legend Model 853, Daisy Outdoor Products (p. 6)

Figure 6-3-2 Rear Sight of the Cadet Air Rifle

### LOWERING AND RAISING THE ELEVATION

To lower the elevation of the MPI, turn the elevation knob counter-clockwise (to the left). To raise the elevation of the MPI, turn the elevation knob clockwise (to the right), as per the arrow and the word "UP" located on the knob.

### MOVING THE WINDAGE LEFT AND RIGHT

To move the MPI left, turn the windage knob counter-clockwise (to the left). To move the MPI to the right, turn the windage knob clockwise (to the right), as per the arrow and the letter "R" located on the knob.



In order to move the MPI up and to the right turn the elevation and windage knobs clockwise.  
In order to move the MPI down and left turn the elevation and windage knobs counter-clockwise.

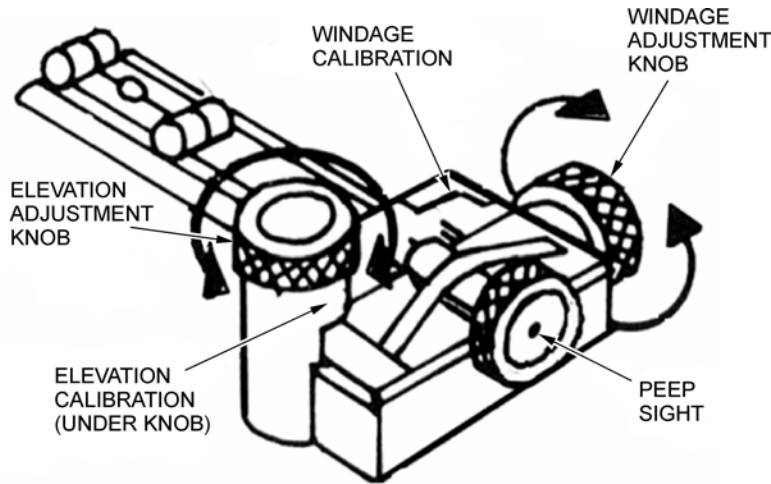

Rogers, AR., AVANTI Competition Pellet Rifle: Operation Manual: AVANTI Legend Model 853, Daisy Outdoor Products (p. 6)

Figure 6-3-3 Sight Adjustment of the Cadet Air Rifle

---

### CONFIRMATION OF TEACHING POINT 3

---

#### QUESTIONS

- Q1. How many clicks on the adjustment knob will move the MPI on the target one pellet width in any direction?
- Q2. What direction does the marksman turn the elevation adjustment knob in order to raise the MPI?
- Q3. What direction does the marksman turn the windage adjustment knob in order to move the MPI to the left?

#### ANTICIPATED ANSWERS

- A1. In order to move the MPI on the target one pellet width, three clicks are required.
- A2. The marksman turns the elevation adjustment knob clockwise (to the right) in order to raise the MPI.
- A3. The marksman turns the windage adjustment knob counter-clockwise (to the left) in order to move the MPI to the left.

---

#### Teaching Point 4

#### Conduct a Sight Adjustment Exercise

Time: 30 min

Method: Practical Activity



Each pair of cadets will complete the exercise located at Annex L and then practice adjusting their sights.

An assistant instructor may be used to aid the cadets in the completion of this activity.

---

### ACTIVITY

---

#### OBJECTIVE

The objective of this activity is to confirm that each cadet can determine the MPI and adjust sights accordingly on the cadet air rifle.



**RESOURCES**

- Cadet air rifle (one per firing lane),
- Sight adjustment activity targets located at Annex L, and
- Pencil/pen.

**ACTIVITY LAYOUT**

A mock firing point.

**ACTIVITY INSTRUCTIONS**

1. Divide the cadets into pairs.
2. Distribute the exercise located at Annex L to each cadet.
3. Have the cadets, in pairs, determine the MPI of all five shots for each scoring diagram.
4. Have the cadets put an asterisk to indicate the MPI.
5. Have the cadets determine the vertical and horizontal distance, in clicks, that the MPI must move to be aimed at the centre of the target.
6. Have the cadets write the number of clicks required for the windage and elevation, marking whether to turn the knob clockwise (cw) or counter-clockwise (ccw).
7. Have the cadets practice adjusting the sights on the cadet air rifle for each scoring diagram.
8. Correct using the answer key located at Annex M.

**SAFETY**

Ensure the following:

- the cadet air rifles are safe by performing individual safety precautions IAW A-CR-CCP-177/PT-001;
- all cadet air rifles are pointed in a safe direction throughout the lesson;
- no pellets or cleaning pellets are present in the training area; and
- all other applicable safety regulations are followed IAW local range standing orders.

---

**CONFIRMATION OF TEACHING POINT 4**

---

The cadets' participation in the activity will serve as the confirmation of this TP.

---



---

**END OF LESSON CONFIRMATION**

---

The cadets' participation in the sight adjustment exercise will serve as the confirmation of this lesson.

---



---

**CONCLUSION**

---

**HOMEWORK/READING/PRACTICE**

N/A.

## METHOD OF EVALUATION

N/A.

## CLOSING STATEMENT

Correcting marksmanship error is necessary to achieve success in marksmanship activities. It ensures that the marksman, the rifle and the target are aligned and that the centre of aim is in the centre of the target. It is important for each marksman to understand how to adjust their sights in order to achieve a completely aligned rifle.

## INSTRUCTOR NOTES/REMARKS

N/A.

---

## REFERENCES

---

- A0-027 A-CR-CCP-177/PT-001 Director Cadets 3. (2001). *Canadian Cadet Movement: Cadet Marksmanship Program Reference Manual*. Ottawa, ON: Department of National Defence.
- C2-097 Ontario Rifle Association. (2003). *Ontario Rifle Association Handbook for New Member*. Haliburton County, ON: MilCun Marksmanship Complex.
- C2-098 (ISBN 1-931220-05-0) Constantine, R. (1998). *Modern Highpower Competition: From Beginner to Master*. Manchester, CT: Precision Shooting Inc.



**COMMON TRAINING  
SILVER STAR  
INSTRUCTIONAL GUIDE**



**SECTION 4**

**EO C306.03 – ADOPT THE STANDING POSITION WITH THE CADET AIR RIFLE**

Total Time:

60 min

---

**PREPARATION**

---

**PRE-LESSON INSTRUCTIONS**

Resources needed for the delivery of this lesson are listed in the lesson specification located in A-CR-CCP-703/PG-001, Chapter 4. Specific uses for said resources are identified throughout the instructional guide within the TP for which they are required.

Review the lesson content and become familiar with the material prior to delivering the lesson.

**PRE-LESSON ASSIGNMENT**

N/A.

**APPROACH**

An interactive lecture was chosen for TP 1 to give an overview of the objectives of the standing position.

Demonstration was chosen for TPs 2–4 as it allows the instructor to explain and demonstrate aspects of the standing position.

A practical activity was chosen for TP 5 as it is an interactive way to allow the cadet to experience the standing position in a safe and controlled environment. This activity contributes to the development of marksmanship skills and knowledge in a fun and challenging setting.

---

**INTRODUCTION**

---

**REVIEW**

N/A.

**OBJECTIVES**

By the end of this lesson the cadet shall be expected to adopt the standing position with the cadet air rifle.

**IMPORTANCE**

It is important for cadets to adopt the standing position with the cadet air rifle as this position is used in both biathlon and civilian air rifle competitions. As the standing position is the only position for the international air rifle competitions, it is seen as a progression for cadet recreational marksmanship.

---

**Teaching Point 1****Explain the Objectives of the Standing Position**

Time: 5 min

Method: Interactive Lecture

---

The first principle of marksmanship is to find a comfortable firing position. The standing position is the easiest and quickest position to assume and does not require any artificial support like the sling in the prone position. It is the most difficult position in which to remain steady as it has the smallest area of support and it has a high centre of gravity. Cadets must accept that when firing in the standing position, they may never achieve complete immobility.

**OBTAINING A GOOD POSITION**

Obtaining a good position is the most important principle of marksmanship; this is especially true when firing in the standing position. A good position helps to maintain balance, comfort and stability during firing. Cadets should wear comfortable flat sole shoes or boots to add stability to the position and stand on the firmest surface possible. Although an excellent position will not guarantee an excellent performance, a poor position can almost assure a substantially negative effect on one's score.

The objective of a good position is to obtain a stable, balanced, uniform platform in the most efficient way possible allowing holding and aiming to be achieved with as little movement and muscular tension as possible.

The standing position should be:

- natural,
- without strain,
- comfortable,
- stable,
- balanced in such a way that body weight is equally distributed between both feet, and
- consistent throughout the relay.

**USING A RIFLE REST**

An excellent way for a cadet to learn the standing position is to practice with the use of a rifle rest. Since the movements of the cadet air rifle are amplified from the lack of support points with the standing position, a rifle rest is very helpful. This allows the cadet air rifle to remain steady while allowing the cadet to understand and perfect the marksmanship skills being practiced. Once these skills are learned, the rifle rest should be removed. Some examples of rifle rests for the standing position are a tripod stand, a stool on top of a table or simply a flat surface on the end of a broom stick.

**MAINTAINING A CENTRE OF GRAVITY**

The instructions given are based on a right-handed marksman. For a left-handed marksman, substitute the left for right and right for left throughout the points.

The centre of gravity is the point where the weight of the rifle and the cadet's body weight are evenly distributed between the feet. In order to compensate for the weight of the rifle, the cadet's back is bent rearward and rotated to the left in order to gain bone support and stability.

If the cadet stands straight, the weight of the cadet air rifle will pull their body to the front. Muscle strain will be felt in the back as the cadet attempts to keep their body from falling forward. By bending backward and rotating the back to the left, a shift in body weight will occur slightly towards the right foot. At a certain point, the weight of the body on the right foot will equal the weight on the left foot. The body-rifle combination then reaches a state of balance, with the centre of gravity located between the cadet's two feet.

---

### CONFIRMATION OF TEACHING POINT 1

---

#### QUESTIONS

- Q1. What is the first principle of marksmanship?
- Q2. What is an excellent way for a cadet to learn the standing position?
- Q3. What is the centre of gravity in relation to the standing position?

#### ANTICIPATED ANSWERS

- A1. Obtaining a good position.
- A2. With the use of a rifle rest.
- A3. The centre of gravity is the point where the weight of the rifle and the cadet's body weight are evenly distributed between the feet.

---

#### Teaching Point 2

#### Explain and Demonstrate Adopting the Standing Position

Time: 5 min

Method: Demonstration

---



For this TP, it is recommended that instruction take the following format:

1. Explain and demonstrate the complete skill while cadets observe.
2. Explain and demonstrate each step required to complete the skill.

**Note:** Assistant instructors may be employed to demonstrate the skill as it is explained.



No two bodies are exactly the same, not even twins; therefore, no two bodies will look alike in any shooting position. Building the best position for your performance, means your standing position will differ from the person standing beside you.

#### ADOPTING THE STANDING POSITION

The following guidelines should be adhered to when adopting the standing position:

1. the body should face to the right, approximately 90 degrees to the target;
2. the feet should be:
  - (a) positioned shoulder width apart,
  - (b) pointed straight ahead in relation to the body, or
  - (c) turned slightly outward for comfort;



The weight of the body and the rifle should be equally distributed between both feet.

3. the legs should be straight with knees unlocked, as locked knees affect circulation, causing increased discomfort and unsteadiness;
4. the hips should be 90 degrees to the target and should not thrust forward;

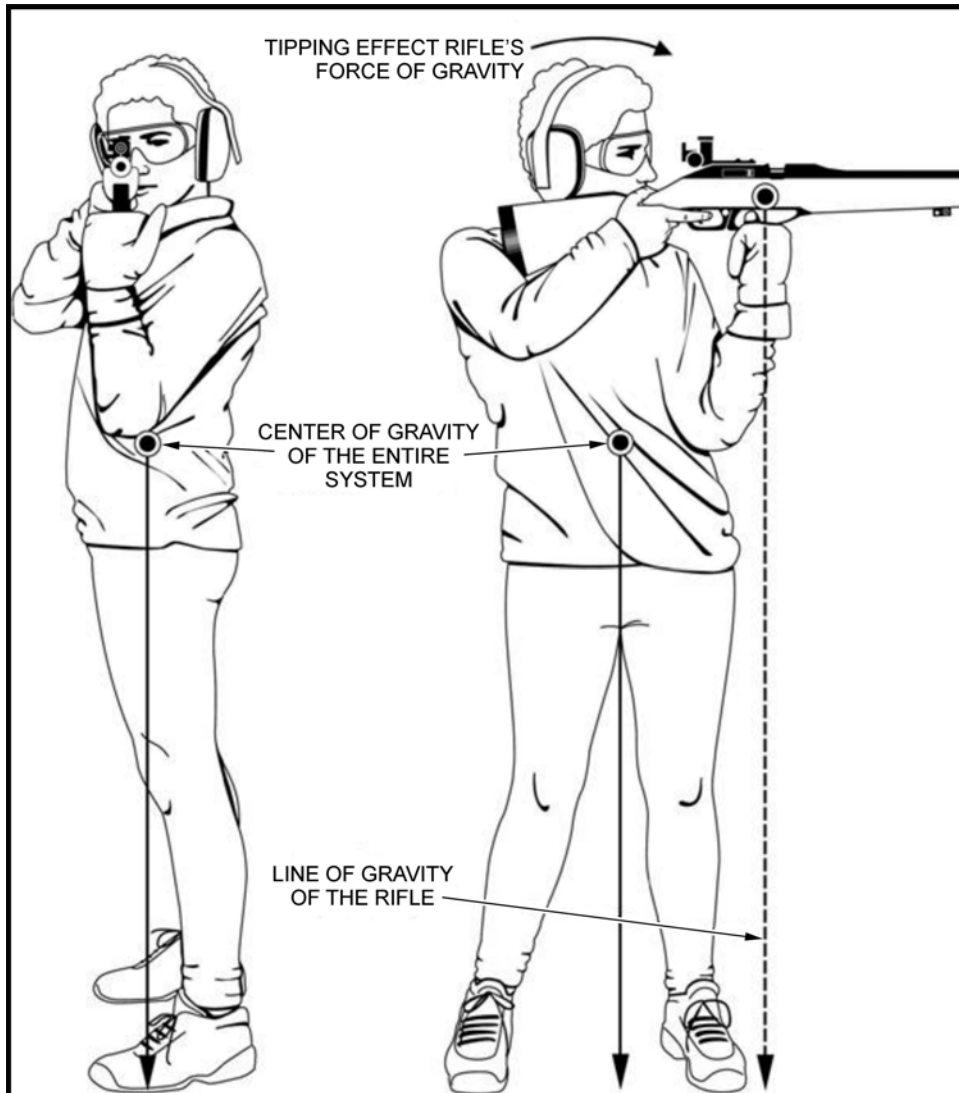

A-CR-CCP-177/PT-001 (p. 2-9)

Figure 6-4-1 Standing Position

5. the back should be bent rearward to gain bone support and stability;
6. the left arm, without muscles used for support, should rest against the ribcage with the elbow almost directly under the rifle, resting against the ribcage or hipbone;
7. the left hand is used to support the rifle and should be positioned on the pump handle, using one of the following methods:
  - (a) forming a clenched fist;



A-CR-CCP-177/PT-001 (p. 1-6-3)

Figure 6-4-2 Clenched Fist

(b) forming a V shape with the thumb and fingers; or



A-CR-CCP-177/PT-001 (p. 1-6-3)

Figure 6-4-3 V Shape With the Thumb and Fingers

(c) using the heel of the hand with relaxed fingers;



A-CR-CCP-177/PT-001 (p. 1-6-4)

Figure 6-4-4 Heel of the Hand

8. the right arm should drop naturally to the side with the right hand placed comfortably, but firmly on the small of the butt;
9. the head should remain in an upright and natural position to allow the eyes to look forward through the sights; and



A-CR-CCP-177/PT-001 (p. 1-6-4)

Figure 6-4-5 Head and Eyes

10. the butt should rest slightly high on the shoulder, allowing the cadet air rifle to rest naturally across the chest with the cheek resting on the stock and the sights at eye level.



The standing position allows for a more natural and relaxed position that is more comfortable than prone, as it places less pressure and weight on the spine.



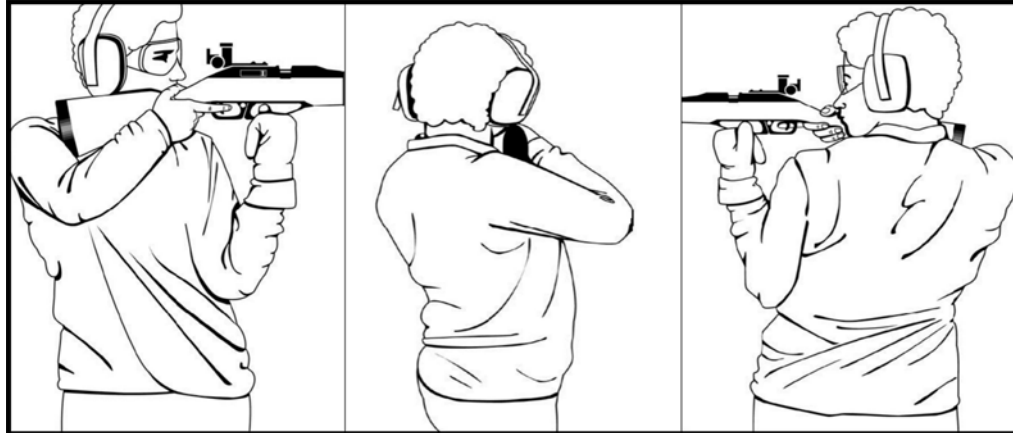

A-CR-CCP-177/PT-001 (p. 2-9)

Figure 6-4-6 Back and Hip Position

---

## CONFIRMATION OF TEACHING POINT 2

---

### QUESTIONS

- Q1. Why is the back bent rearward?
- Q2. Why should the head remain in an upright and natural position?
- Q3. Where should the butt of the cadet air rifle rest?

### ANTICIPATED ANSWERS

- A1. The back is bent rearward to gain bone support and stability.
- A2. The head should remain in an upright and natural position to allow the eyes to look forward through the sights.
- A3. The butt resting slightly high on the shoulder, allowing the cadet air rifle to rest naturally across the chest with the cheek resting on the stock and the sights at eye level.

---

### Teaching Point 3

### Explain and Demonstrate Adjusting the Aim

Time: 5 min

Method: Demonstration



When firing in the standing position, the larger of the two front apertures should be selected to provide the best sight picture. The aperture size should appear 1-1/2 times bigger than the aiming mark to allow the cadet to see the aiming mark that will be shifting around more than in the prone position.

When aiming the cadet air rifle in the standing position, the aiming process is the same as it is for the prone position. It is achieved by adopting a comfortable position, ensuring body alignment with the target, sight alignment and obtaining a sight picture. The only thing that varies from the prone position is that the front aperture should be larger and eye relief may be longer, but still between 5–15 cm (2–6 inches).



For this TP, it is recommended that instruction take the following format:

1. Explain and demonstrate the complete skill while cadets observe.
2. Explain and demonstrate each step required to complete the skill.

**Note:** Assistant instructors may be employed to demonstrate the skill as it is explained.

### Higher

To adjust the aim higher in the standing position, move the left hand rearward, closer to the trigger guard.

### Lower

To adjust the aim lower in the standing position, move the left hand forward, away from the trigger guard.



When smaller adjustments higher or lower are required, they can be achieved by adjusting when to hold a breath during the breathing cycle.

### Left and Right

To adjust the aim to the left or right, adjustments are made by moving both feet in such a way as to keep them in the same position in relation to each other. The result should be as if the position was rotated in a disc, turned to the left or right as required.



When smaller adjustments left or right are required, they can be achieved by adjusting the position of the left hand and forearm. Adjusting the aim by this method may result in having to acquire a new firing position.

---

## CONFIRMATION OF TEACHING POINT 3

---

### QUESTIONS

- Q1. How does aiming in the standing position vary from the prone position?
- Q2. How is aiming adjusted higher or lower in the standing position?
- Q3. How is aiming adjusted to the left or right in the standing position?

### ANTICIPATED ANSWERS

- A1. The front aperture should be larger and eye relief may be longer, but still between 5–15 cm (2–6 inches).
- A2. By moving the left hand rearward or forward of the trigger guard.
- A3. By moving both feet in such a way as to keep them in the same position in relation to each other, as if on a rotating disc.

**Teaching Point 4****Explain and Demonstrate Natural Alignment**

Time: 5 min

Method: Demonstration



Natural alignment is the same procedure for the standing position as it is for the prone position.

Natural alignment describes the direction that the cadet air rifle is aimed when the marksman is in a comfortable standing position with the cadet air rifle at the ready. In a comfortable position, the cadet air rifle should not be forced to point at the target. Even with a comfortable standing position and sight alignment, forcing the cadet air rifle can cause muscle tension and will affect the accuracy of each shot.



For this TP, it is recommended that instruction take the following format:

1. Explain and demonstrate the complete skill while cadets observe.
2. Explain and demonstrate each step required to complete the skill.

**Note:** Assistant instructors may be employed to demonstrate the skill as it is explained.

Natural alignment is obtained by:

1. adopting the standing position;
2. acquiring a sight picture;
3. closing both eyes;
4. taking 3–4 normal breaths to relax the muscles;
5. after 10 seconds, opening the eyes to inspect the sight picture; and
6. adjusting body position to acquire a sight picture.



The purpose of closing the eyes and relaxing is to allow the muscles to return to a natural position. This allows the position to be adjusted and avoids having to force the cadet air rifle to aim at the target.

---

**CONFIRMATION OF TEACHING POINT 4**

---

**QUESTIONS**

- Q1. Natural alignment has a marksman in what type of position?
- Q2. How long are the eyes closed, and how many breaths are taken to obtain natural alignment?
- Q3. What negative effect can forcing the cadet air rifle have?

**ANTICIPATED ANSWERS**

- A1. In a comfortable standing position with the cadet air rifle at the ready.

A2. The eyes are closed for 10 seconds and 3–4 natural breaths are taken.

A3. It can cause muscle tension and will affect the accuracy of each shot.

---

**Teaching Point 5****Have the Cadets Adopt the Standing Position**

Time: 30 min

Method: Practical Activity

---

---

**ACTIVITY**

---

**OBJECTIVE**

The objective of this activity is to have cadets adopt the standing position, position the cadet air rifle into the shoulder, obtain natural alignment and adjust their position as required.

**RESOURCES**

- Cadet air rifle (one per firing lane),
- Rifle rest (one per firing lane),
- Target frame (one per firing lane),
- Suitable target (one per firing lane),
- Raised target platform (one per firing lane),
- Safety glasses/goggles.

**ACTIVITY LAYOUT**

Construct an air rifle range IAW Part 1, Section 8 of A-CR-CCP-177/PT-001.

**ACTIVITY INSTRUCTIONS**

1. Divide cadets into equal relays according to the number of firing lanes.
2. Have the relays take turns assuming the standing position using the cadet air rifle.
3. With assistance, allow the cadets to practice the standing position as taught.
4. Have cadets adjust their standing position, to include:
  - (a) the body should face 90 degrees to the target;
  - (b) the feet should be:
    - (1) positioned shoulder width apart,
    - (2) pointed straight ahead in relation to the body, or
    - (3) turned slightly outward for comfort,
  - (c) the legs should be straight with knees unlocked;
  - (d) the hips should be 90 degrees to the target and not thrust forward;
  - (e) the back should be bent rearward;

- (f) the left arm should rest against the ribcage with the elbow under the rifle, resting against the ribcage or hipbone;
  - (g) the left hand supporting the rifle, should be positioned on the pump handle;
  - (h) the right arm should drop naturally to the side with the right hand placed on the small of the butt;
  - (i) the head should remain upright and in a natural position to allow the eyes to look through the sights; and
  - (j) the butt should rest slightly high on the shoulder, allowing the cadet air rifle to rest naturally across the chest with the cheek resting on the stock and the sights at eye level.
5. Inspect each cadet for a comfortable position.
  6. Repeat steps as required, within the allotted time.

### **SAFETY**

Ensure that the cadet air rifles are pointed in a safe direction at all times. Cadets will treat air rifles as though they are loaded.

---

### **CONFIRMATION OF TEACHING POINT 5**

---

The cadets' participation in the standing position activity will serve as the confirmation of this TP.

---

### **END OF LESSON CONFIRMATION**

---

The cadets' participation in the activity in TP 5 will serve as the confirmation of this lesson.

---

### **CONCLUSION**

---

### **HOMEWORK/READING/PRACTICE**

N/A.

### **METHOD OF EVALUATION**

N/A.

### **CLOSING STATEMENT**

The standing position is the least stable position due to its high centre of gravity and small support area. It requires a great amount of concentration and practice. The standing position is seen as a progression for cadet recreational marksmanship and is the only position for the international air rifle competitions.

### **INSTRUCTOR NOTES/REMARKS**

Cadets who have completed this lesson will participate in EO M306.01 (Participate in a Recreational Marksmanship Activity, Section 1) from the standing position.

---

### **REFERENCES**

---

A0-027 A-CR-CCP-177/PT-001 Director Cadets 3. (2001). *Canadian Cadet Movement: Cadet Marksmanship Program Reference Manual*. Ottawa, ON: Department of National Defence.

C2-146 (ISBN 0-9655780-0-3) Pullum, B. & Hanenkrat, F. (1997). *The New Position Rifle Shooting: A Comprehensive Guide to Better Target Shooting*. Oak Harbor, OH: Target Sports Education Center.

## CLASSIFICATION ACTIVITY

CLASSIFICATION ACTIVITY
<p><b>Objective.</b> To provide cadets the opportunity to obtain marksmanship classifications.</p>
<p><b>Scoring.</b> The standard for the classification levels that are:</p> <ol style="list-style-type: none"><li>1. Marksman: Two five-round groupings within a circle of 3 cm in diameter.</li><li>2. First Class Marksman: Two five-round groupings within a circle of 2.5 cm in diameter.</li><li>3. Expert Marksman: Two five-round groupings within a circle of 2 cm in diameter.</li><li>4. Distinguished Marksman: Two five-round groupings within a circle of 1.5 cm in diameter.</li></ol>
<p><b>Equipment Required</b></p> <p>Mandatory:</p> <ul style="list-style-type: none"><li>• CCT200GRTD Canadian Cadet Movement (CCM) Air Rifle Grouping Target (one per cadet),</li><li>• Air Rifle Grouping Template from A-CR-CCP-177/PT-001 (p. B1-1), and</li><li>• A stopwatch.</li></ul> <p>Optional aids to firing are limited to the following:</p> <ul style="list-style-type: none"><li>• Cadet air rifle sling,</li><li>• Marksmanship jacket,</li><li>• Shooting glove, and</li><li>• Hat.</li></ul>
<p><b>Activity Instructions</b></p> <ol style="list-style-type: none"><li>1. Distribute an Air Rifle Grouping Target to each cadet.</li><li>2. Have the cadets write their name and date on the target and attach it to the target frame.</li><li>3. Give the cadets five pellets to fire into the centre of the target.</li><li>4. Have the cadets fire in relays following the commands given by the RSO.</li><li>5. Give the cadets 15 minutes to complete firing.</li><li>6. Have the cadets retrieve their targets.</li><li>7. Score the targets using the Air Rifle Grouping Template.</li><li>8. Record the scores and allow the cadets to keep their targets.</li></ol> <p>The following is prohibited:</p> <ul style="list-style-type: none"><li>• Alterations made to the rifles.</li><li>• A pellet-loading clip.</li><li>• Supports used as a rest for the rifle or the forearm.</li><li>• A spotting scope.</li><li>• Use of sights not provided with the cadet air rifle.</li><li>• Coaching.</li></ul>

THIS PAGE INTENTIONALLY LEFT BLANK



## FUN ACTIVITIES – PYRAMID

PYRAMID
<b>Objective.</b> To fire pellets into each point on the pyramid.
<b>Scoring.</b> One point is awarded for each point on the pyramid that is hit by a pellet.
<b>Equipment Required</b>  Mandatory: Pyramid Target (one per cadet).  Optional aids to firing are limited to the following: <ul style="list-style-type: none"><li>• Cadet air rifle sling,</li><li>• Marksmanship jacket,</li><li>• Shooting glove, and</li><li>• Hat.</li></ul>
<b>Activity Instructions</b> <ol style="list-style-type: none"><li>1. Distribute one Pyramid Target to each cadet.</li><li>2. Have the cadets write their name and date on the target and attach it to the target frame.</li><li>3. Give the cadets three pellets to fire, one pellet into each corner of the pyramid.</li><li>4. Have the cadets fire in relays following the commands given by the RSO.</li><li>5. Give the cadets three minutes to complete firing.</li><li>6. Score the targets awarding one point for each corner hit on the pyramid.</li><li>7. Allow the cadets to review and keep their targets.</li></ol> The following actions are prohibited: <ul style="list-style-type: none"><li>• Alterations made to the rifles.</li><li>• A pellet-loading clip.</li><li>• Supports used as a rest for the rifle or the forearm.</li><li>• A spotting scope.</li><li>• Use of sights not provided with the cadet air rifle.</li></ul>

PYRAMID TARGET

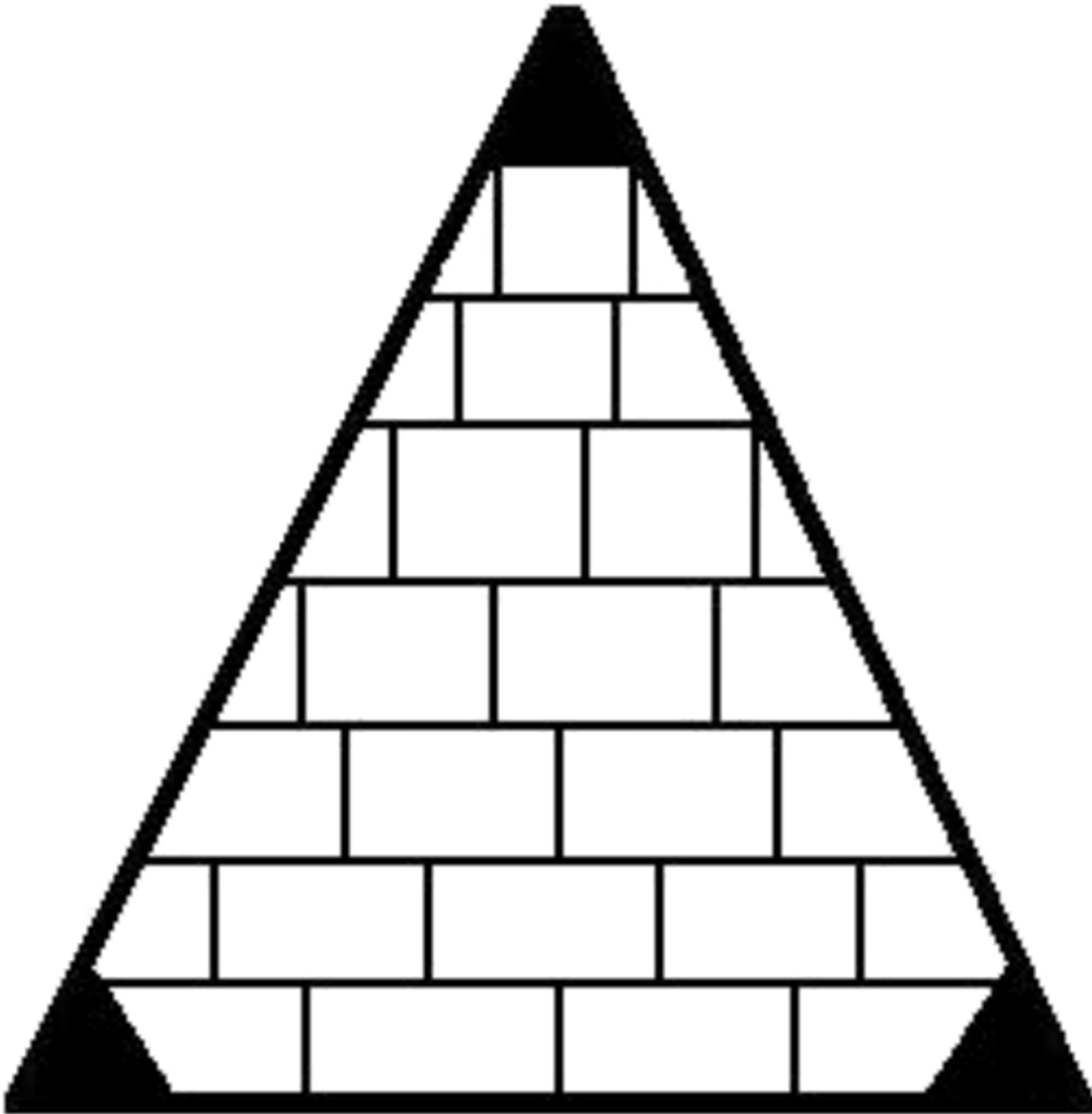

Name: \_\_\_\_\_ Date: \_\_\_\_\_

*Director Cadets 3, 2007, Ottawa, ON: Department of National Defence*

Figure 6B-1 Pyramid Target

## FUN ACTIVITIES – SHOOTING STAR

<b>SHOOTING STAR</b>
<b>Objective.</b> To fire a pellet into each point on the star.
<b>Scoring.</b> One point is awarded for each point on the star that is hit by a pellet.
<b>Equipment Required</b>  Mandatory: Star Target (one per cadet).  Optional aids to firing are limited to the following: <ul style="list-style-type: none"><li>• Cadet air rifle sling,</li><li>• Marksmanship jacket,</li><li>• Shooting glove, and</li><li>• Hat.</li></ul>
<b>Activity Instructions</b>  <ol style="list-style-type: none"><li>1. Distribute one Star Target to each cadet.</li><li>2. Have the cadets write their name and date on the target and attach it to the target frame.</li><li>3. Give the cadets five pellets to fire, one pellet into each point on the star.</li><li>4. Have the cadets fire in relays following the commands given by the RSO.</li><li>5. Give the cadets five minutes to complete firing.</li><li>6. Score the targets awarding one point for a pellet hit within each point on the star.</li><li>7. Allow the cadets to review and keep their targets.</li></ol> <p>The following is prohibited:</p> <ul style="list-style-type: none"><li>• Alterations made to the rifles.</li><li>• A pellet-loading clip.</li><li>• Supports used as a rest for the rifle or the forearm.</li><li>• A spotting scope.</li><li>• Use of sights not provided with the cadet air rifle.</li></ul>

**STAR TARGET**

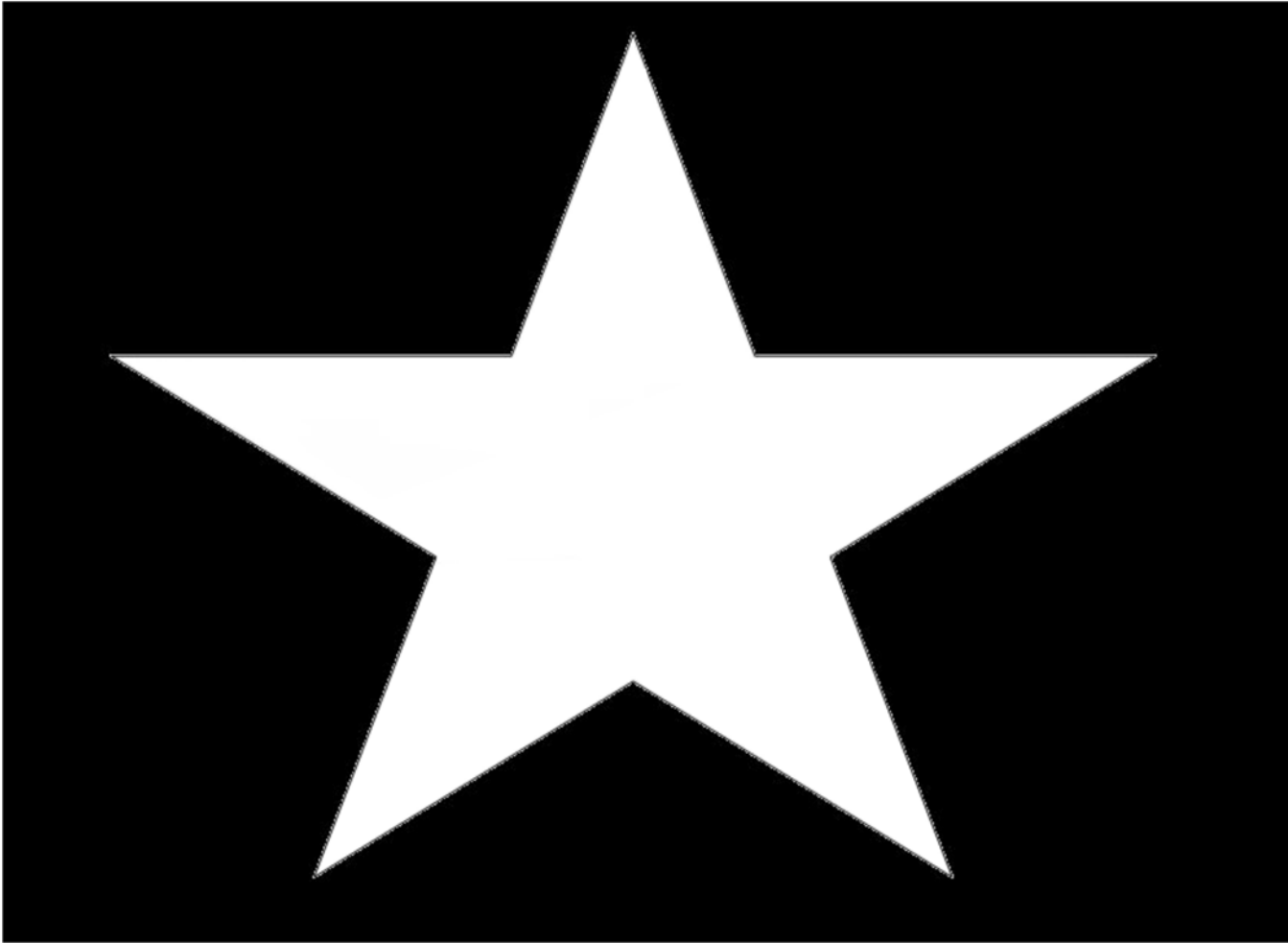

Name: \_\_\_\_\_ Date: \_\_\_\_\_

*Director Cadets 3, 2007, Ottawa, ON: Department of National Defence*

Figure 6C-1 Star Target

## FUN ACTIVITIES – BEACH BALL

<b>BEACH BALL</b>
<b>Objective.</b> To fire 10 pellets into the black circle on the beach ball.
<b>Scoring.</b> One point is awarded for each successful hit in the black circle.
<b>Equipment Required</b>  Mandatory: Beach Ball Target (one per cadet).  Optional aids to firing are limited to the following: <ul style="list-style-type: none"><li>• Cadet air rifle sling,</li><li>• Marksmanship jacket,</li><li>• Shooting glove, and</li><li>• Hat.</li></ul>
<b>Activity Instructions</b>  <ol style="list-style-type: none"><li>1. Distribute one Beach Ball Target to each cadet.</li><li>2. Have the cadets write their name and date on the target and attach it to the target frame.</li><li>3. Give the cadets 10 pellets to fire into the black circle of the beach ball.</li><li>4. Have the cadets fire in relays following the commands given by the RSO.</li><li>5. Give the cadets 10 minutes to complete firing.</li><li>6. Score the targets awarding one point for each pellet hit within the black circle.</li><li>7. Allow the cadets to review and keep their targets.</li></ol> <p>The following is prohibited:</p> <ul style="list-style-type: none"><li>• Alterations made to the rifles.</li><li>• A pellet-loading clip.</li><li>• Supports used as a rest for the rifle or the forearm.</li><li>• A spotting scope.</li><li>• Use of sights not provided with the cadet air rifle.</li></ul>

**BEACH BALL TARGET**



Name: \_\_\_\_\_ Date: \_\_\_\_\_

*Director Cadets 3, 2006, Ottawa, ON: Department of National Defence*

Figure 6D-1 Beach Ball Target

## FUN ACTIVITIES – BALLOONS

<b>BALLOONS</b>
<b>Objective.</b> To fire pellets into balloons on the target.
<b>Scoring.</b> One point is awarded for each balloon hit by a pellet.
<b>Equipment Required</b>  Mandatory: Balloon Target (one per cadet).  Optional aids to firing are limited to the following: <ul style="list-style-type: none"><li>• Cadet air rifle sling,</li><li>• Marksmanship jacket,</li><li>• Shooting glove, and</li><li>• Hat.</li></ul>
<b>Activity Instructions</b>  <ol style="list-style-type: none"><li>1. Distribute one Balloon Target to each cadet.</li><li>2. Have the cadets write their name and date on the target and attach it to the target frame.</li><li>3. Give the cadets five pellets to fire, one pellet into each balloon.</li><li>4. Have the cadets fire in relays following the commands given by the RSO.</li><li>5. Give the cadets five minutes to complete firing.</li><li>6. Score the targets awarding one point for each balloon hit.</li><li>7. Allow the cadets to review and keep their targets.</li></ol> The following is prohibited: <ul style="list-style-type: none"><li>• Alterations made to the rifles.</li><li>• A pellet-loading clip.</li><li>• Supports used as a rest for the rifle or the forearm.</li><li>• A spotting scope.</li><li>• Use of sights not provided with the cadet air rifle.</li></ul>
<b>Note:</b> Actual balloons may be used in place of the paper targets.

**BALLOON TARGET**

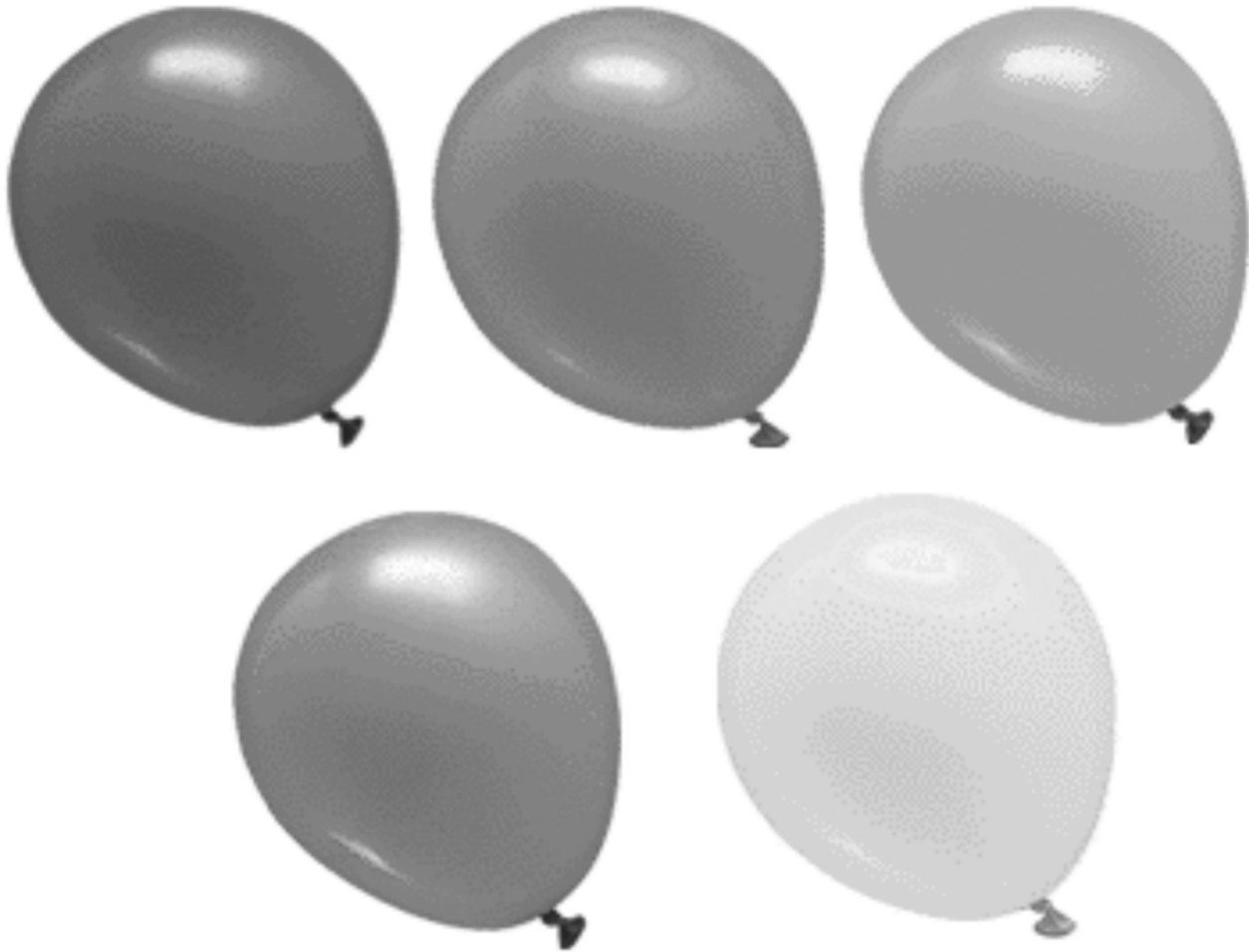

Name: \_\_\_\_\_ Date: \_\_\_\_\_

*Director Cadets 3, 2007, Ottawa, ON: Department of National Defence*

Figure 6E-1 Balloon Target



## TIMED ACTIVITIES – CHASE THE DOTS

<b>CHASE THE DOTS</b>	
<b>Objective.</b>	To fire pellets into the dots on the target in a clockwise direction, within a time limit.
<b>Scoring.</b>	One point is awarded for each black dot that is hit by a pellet within the time allotted.
<b>Equipment Required</b>	
Mandatory:	
<ul style="list-style-type: none"><li>• Chase the Dots Target (one per cadet), and</li><li>• A stopwatch.</li></ul>	
Optional aids to firing are limited to the following:	
<ul style="list-style-type: none"><li>• Cadet air rifle sling,</li><li>• Marksmanship jacket,</li><li>• Shooting glove, and</li><li>• Hat.</li></ul>	
<b>Activity Instructions</b>	
<ol style="list-style-type: none"><li>1. Distribute one Chase the Dots Target to each cadet.</li><li>2. Have the cadets write their name and date on the target and attach it to the target frame.</li><li>3. Give the cadets eight pellets to fire, one pellet into each black dot, in a clockwise direction.</li><li>4. Have the cadets fire in relays following the commands given by the RSO.</li><li>5. Give the cadets eight minutes to complete firing.</li><li>6. Score the targets awarding one point for each black dot hit.</li><li>7. Allow the cadets to review and keep their targets.</li></ol>	
The following is prohibited:	
<ul style="list-style-type: none"><li>• Alterations made to the rifles.</li><li>• A pellet-loading clip.</li><li>• Supports used as a rest for the rifle or the forearm.</li><li>• A spotting scope.</li><li>• Use of sights not provided with the cadet air rifle.</li><li>• Coaching.</li></ul>	
<b>Note:</b>	To make this activity more difficult, shorten the time allowance.

**CHASE THE DOTS TARGET**

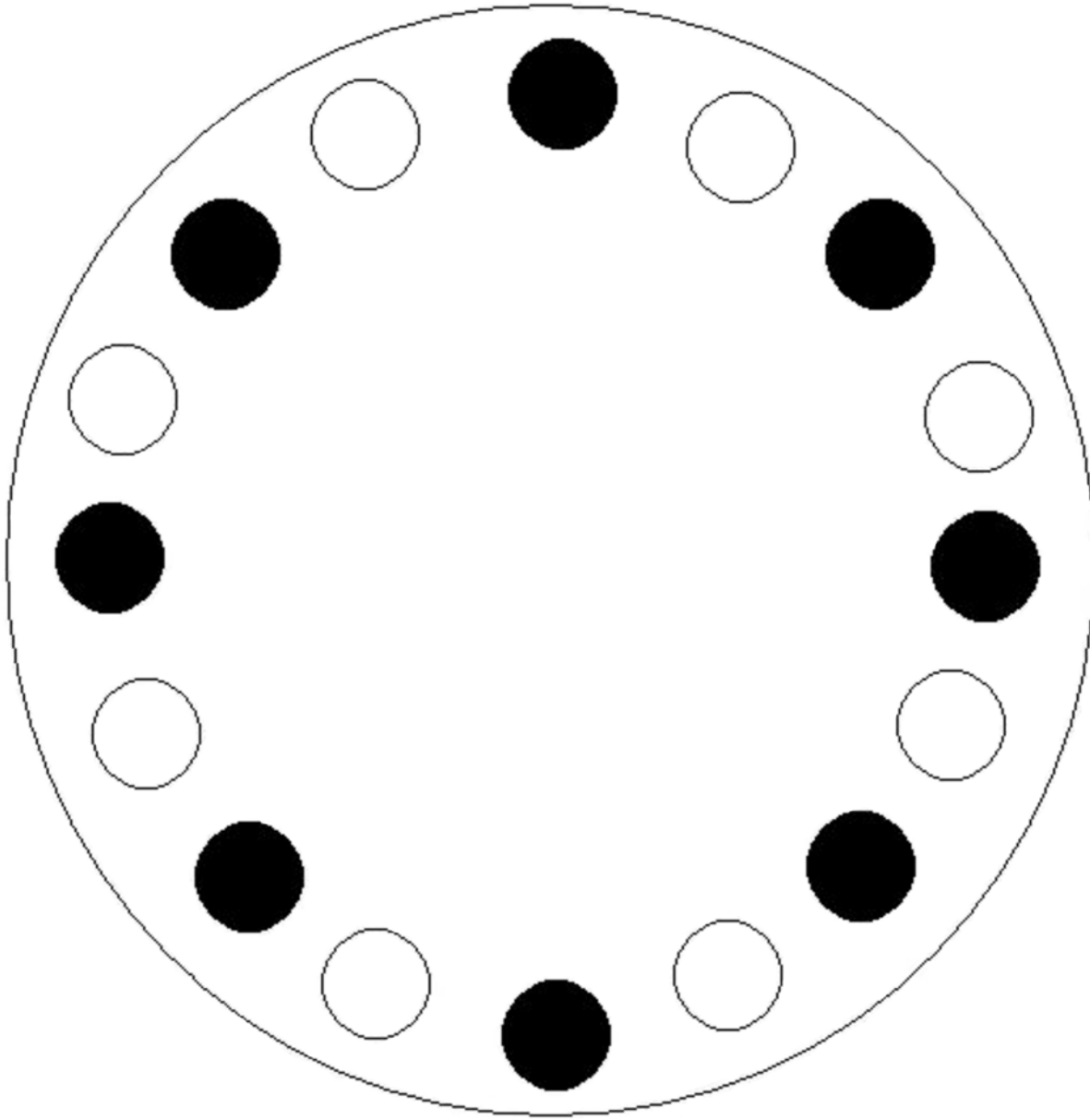

Name: \_\_\_\_\_ Date: \_\_\_\_\_

*Director Cadets 3, 2007, Ottawa, ON: Department of National Defence*

Figure 6F-1 Chase the Dots Target

## TIMED ACTIVITIES – SPEED GRID

<b>SPEED GRID</b>
<b>Objective.</b> To fire pellets into the circles on the target, within a time limit.
<b>Scoring.</b> One point is awarded for each circle that is hit by a pellet within the time allotted.
<b>Equipment Required</b>  Mandatory: <ul style="list-style-type: none"><li>• Cadet air rifle five-pellet clip (three per firing lane),</li><li>• Speed Grid Target (one per cadet), and</li><li>• A stopwatch.</li></ul> Optional aids to firing are limited to the following: <ul style="list-style-type: none"><li>• Cadet air rifle sling,</li><li>• Marksmanship jacket,</li><li>• Shooting glove, and</li><li>• Hat.</li></ul>
<b>Activity Instructions</b>  <ol style="list-style-type: none"><li>1. Distribute one Speed Grid Target to each cadet.</li><li>2. Have the cadets write their name and date on the target and attach it to the target frame.</li><li>3. Give the cadets 15 pellets, pre-loaded into three five pellet clips.</li><li>4. Have the cadets fire one pellet into each circle on the target.</li><li>5. Have the cadets fire in relays following the commands given by the RSO.</li><li>6. Give the cadets 15 minutes to complete firing.</li><li>7. Score the targets awarding one point for each circle hit.</li><li>8. Allow the cadets to review and keep their targets.</li></ol> The following is prohibited: <ul style="list-style-type: none"><li>• Alterations made to the rifles.</li><li>• Supports used as a rest for the rifle or the forearm.</li><li>• A spotting scope.</li><li>• Use of sights not provided with the cadet air rifle.</li><li>• Coaching.</li></ul>
<b>Note:</b> To make this activity more difficult, shorten the time allowance.

**SPEED GRID TARGET**

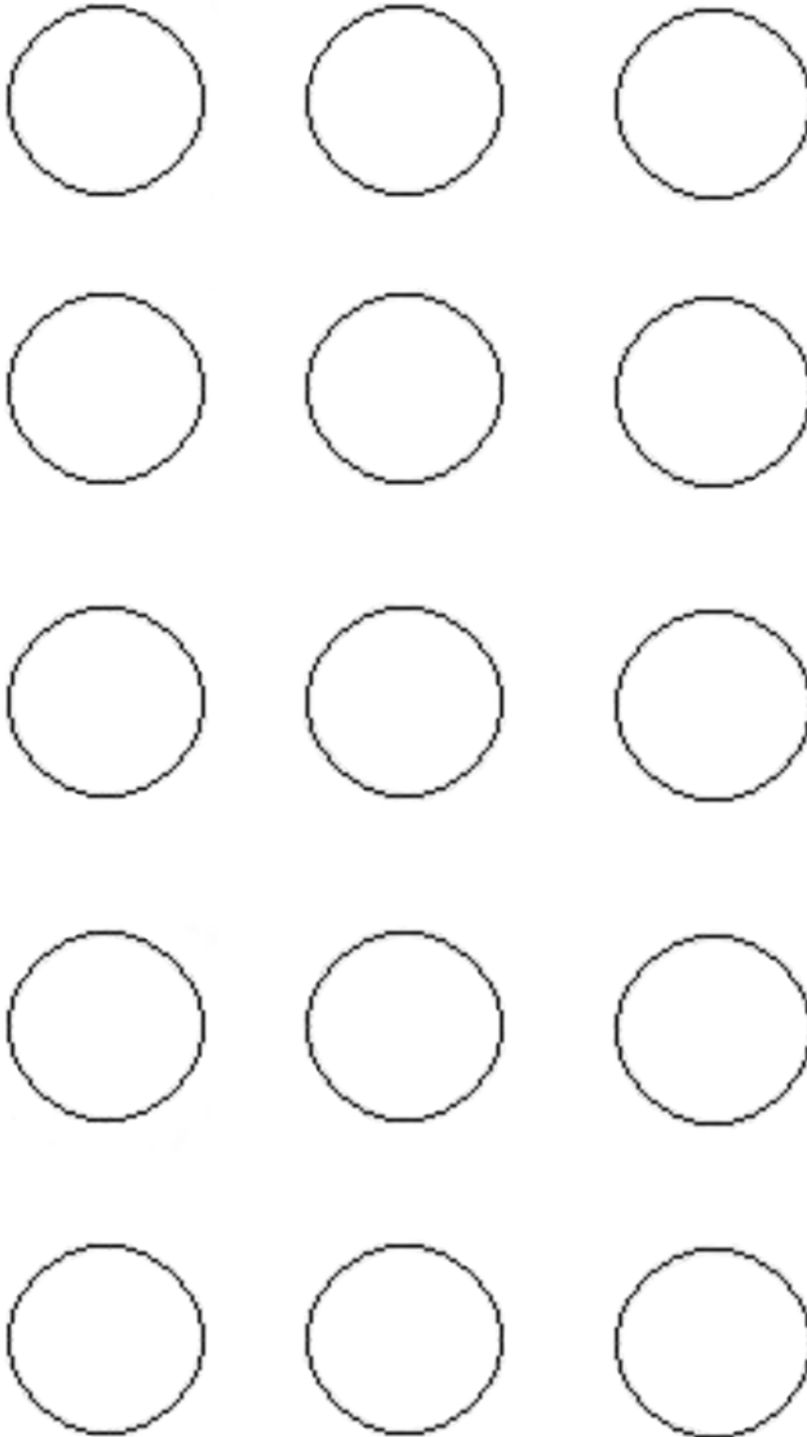

Name: \_\_\_\_\_ Date: \_\_\_\_\_

*Director Cadets 3, 2007, Ottawa, ON: Department of National Defence*

Figure 6G-1 Speed Grid Target

## TIMED ACTIVITIES – BEAT THE CLOCK

<b>BEAT THE CLOCK</b>	
<b>Objective.</b>	To fire pellets into the designated hours (numbers) within a time limit.
<b>Scoring.</b>	One point is awarded for each correct hour (number) hit by a pellet within the time allotted.
<b>Equipment Required</b>	
Mandatory:	
<ul style="list-style-type: none"><li>• Beat the Clock Target (one per cadet), and</li><li>• A stopwatch.</li></ul>	
Optional aids to firing are limited to the following:	
<ul style="list-style-type: none"><li>• Cadet air rifle sling,</li><li>• Marksmanship jacket,</li><li>• Shooting glove, and</li><li>• Hat.</li></ul>	
<b>Activity Instructions</b>	
<ol style="list-style-type: none"><li>1. Distribute one Beat the Clock Target to each cadet.</li><li>2. Have the cadets write their name and date on the target and attach it to the target frame.</li><li>3. Have the cadets fire in relays following the commands given by the RSO.</li><li>4. Have the RSO using the 12-hour clock, call out one number every 20 second for a total of six numbers.</li><li>5. Give the cadets six pellets to fire, one pellet at each hour (number) as it is called.</li><li>6. Score the targets awarding one point for each correct number hit on the target.</li><li>7. Allow the cadets to review and keep their targets.</li></ol>	
The following is prohibited:	
<ul style="list-style-type: none"><li>• Alterations made to the rifles.</li><li>• Supports used as a rest for the rifle or the forearm.</li><li>• A spotting scope.</li><li>• Use of sights not provided with the cadet air rifle.</li><li>• Coaching.</li></ul>	
<b>Note:</b>	To make this activity more difficult, shorten the time allowance.

**BEAT THE CLOCK TARGET**

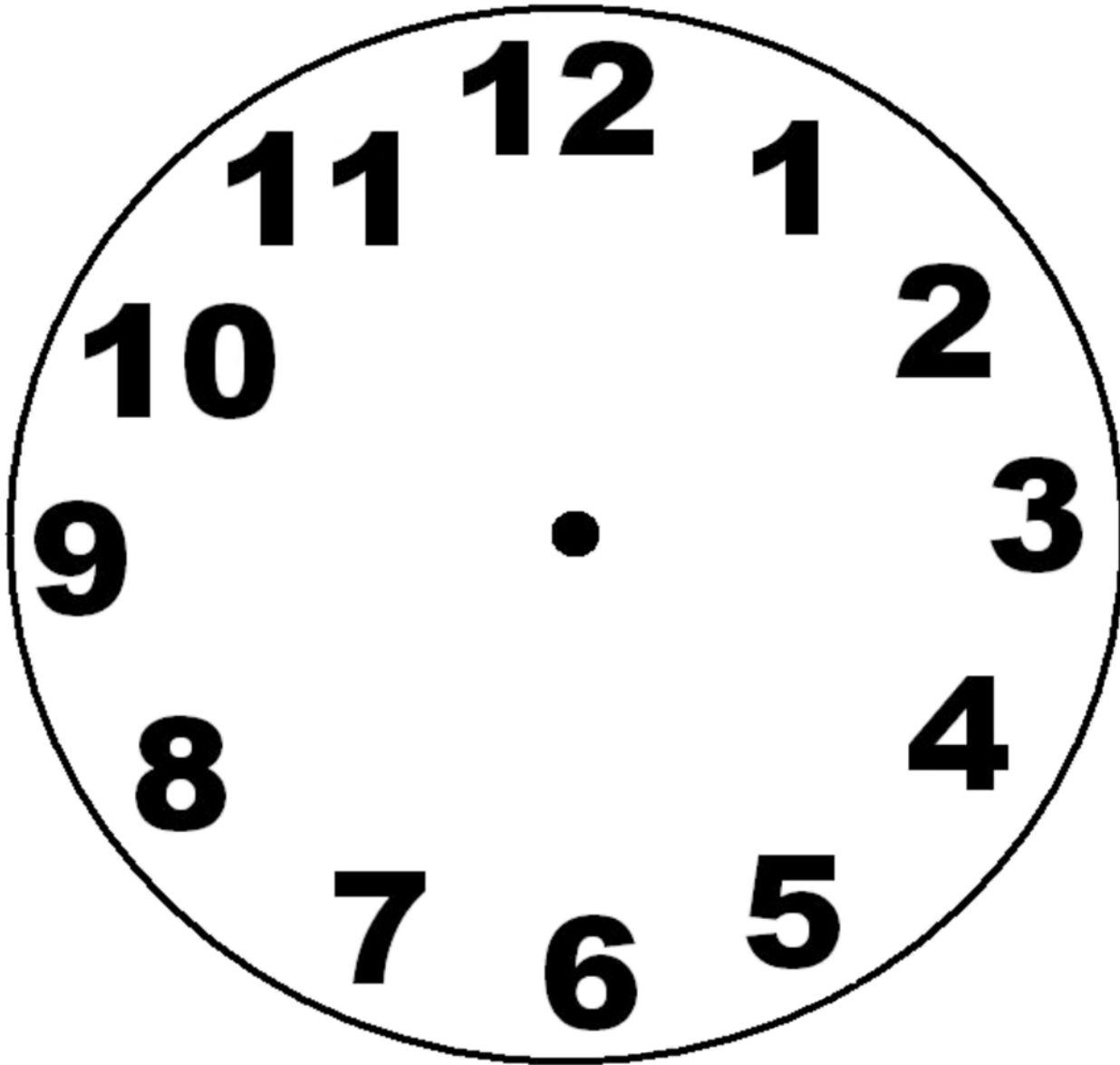

Name: \_\_\_\_\_ Date: \_\_\_\_\_

*Director Cadets 3, 2007, Ottawa, ON: Department of National Defence*

Figure 6H-1 Clock Target

## COMPETITIVE ACTIVITIES – CORPS MARKSMANSHIP COMPETITION

<b>CORPS MARKSMANSHIP COMPETITION</b>
<p><b>Objective.</b> To provide cadets the opportunity to compete within the corps.</p>
<p><b>Scoring.</b> Targets will be scored IAW A-CR-CCP-177/PT-001, to include:</p> <ul style="list-style-type: none"><li>• Each target has a highest possible score of 100 points (10 diagrams worth 10 points each).</li><li>• All shot holes are scored using the highest value of the scoring ring that it is broken.</li><li>• Shots outside the scoring rings are given a value of zero.</li><li>• If more than the one pellet is fired on a target, the shots with the highest value will be discarded until one shot remain on the target. Also, a two-point penalty will be deducted for each excess shot.</li><li>• If more than one shot is fired at a scoring diagram, only the prescribed number of shots may be fired at the remaining diagrams [eg, if two shots were fired at the first diagram, one diagram on the target would remain blank (free of shots)]. If this occurs more than twice, a two-point penalty will be deducted for each excess shot.</li><li>• This activity may be conducted as individuals or teams of four.</li></ul>
<p><b>Equipment Required</b></p> <p>Mandatory: CCT2001AR853 CCM Competition Targets (two per cadet).</p> <p>Optional aids to firing are limited to the following:</p> <ul style="list-style-type: none"><li>• Cadet air rifle sling,</li><li>• Marksmanship jacket,</li><li>• Shooting glove, and</li><li>• Hat.</li></ul>
<p><b>Activity Instructions</b></p> <ol style="list-style-type: none"><li>1. Distribute two CCT2001AR853 CCM Competition Targets to each cadet.</li><li>2. Have the cadets write their name and date on each target and attach them to the target frame.</li><li>3. Give the cadets 20 scoring pellets to fire, one pellet at each scoring diagram (additional zeroing pellets are permitted).</li><li>4. Have the cadets fire in relays, following the commands given by the RSO.</li><li>5. Give the cadets 30 minutes to complete firing.</li><li>6. Have the RSO collect the targets, score as described above and record the results.</li><li>7. Allow the cadets to review and keep their targets.</li></ol> <p>The following is prohibited:</p> <ul style="list-style-type: none"><li>• Crossfiring.</li><li>• Alterations made to the rifles.</li><li>• Supports used as a rest for the rifle or the forearm.</li><li>• A spotting scope.</li><li>• Use of sights not provided with the cadet air rifle.</li></ul>

THIS PAGE INTENTIONALLY LEFT BLANK



## COMPETITIVE ACTIVITIES – LUNAR LAUNCH

<b>LUNAR LAUNCH</b>			
<b>Objective.</b> To provide cadets the opportunity to compete within the corps.			
<b>Scoring.</b> The average distance from the earth to the moon is 384 400 km. All targets from marksmanship activities conducted during marksmanship training will be added together to calculate a distance from earth and achieve a position on the space shuttle crew. The four scoring levels/positions must meet the following standards:			
1.	Mission Commander:	A score of 100 plus:	384 400 km from earth, lunar landing!
2.	Mission Specialist:	A score of 75 to 99:	288 300 km from earth.
3.	Chief Engineer:	A score of 50 to 74:	192 200 km from earth.
4.	Science Officer:	A score of 25 to 49:	96 100 km from earth, lunar launch!
<b>Equipment Required</b>			
Mandatory: Scores for all targets used in marksmanship activities during the training year.			
<b>Activity Instructions</b>			
1. Add the scores from the targets used by each cadet during the training year.			
2. Use the scoring method described above to assign the cadets levels/positions on the space shuttle crew.			
<b>Notes:</b>			
1. A record must be kept of each cadet's scores from all marksmanship activities.			
2. This activity may be conducted over multiple training years.			
3. The certificate found in this annex may be awarded to cadets who achieve levels/positions in this activity.			

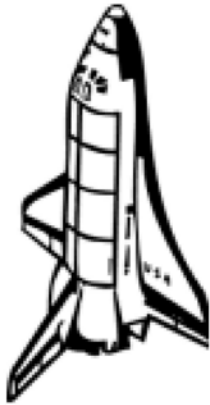

This is to certify that

\_\_\_\_\_

has achieved the position of

\_\_\_\_\_

in the



## **Lunar Launch Marksmanship Activity**

\_\_\_\_\_

Date

\_\_\_\_\_

Range Safety Officer

### MPI EXAMPLES

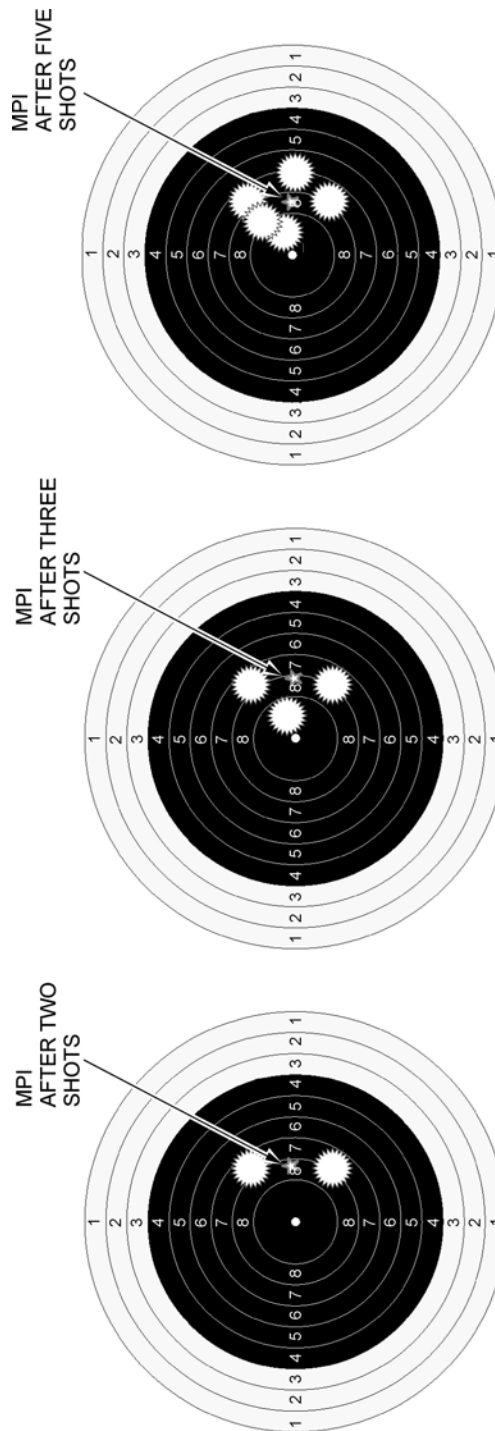

*Director Cadets 3, 2007, Ottawa, ON: Department of National Defence*

Figure 6K-1 MPI Examples

THIS PAGE INTENTIONALLY LEFT BLANK

### SIGHT ADJUSTMENT ACTIVITY

Name: \_\_\_\_\_ Date: \_\_\_\_\_



ELEVATION: \_\_\_\_\_  
WINDAGE: \_\_\_\_\_



ELEVATION: \_\_\_\_\_  
WINDAGE: \_\_\_\_\_



ELEVATION: \_\_\_\_\_  
WINDAGE: \_\_\_\_\_



ELEVATION: \_\_\_\_\_  
WINDAGE: \_\_\_\_\_



ELEVATION: \_\_\_\_\_  
WINDAGE: \_\_\_\_\_



ELEVATION: \_\_\_\_\_  
WINDAGE: \_\_\_\_\_



ELEVATION: \_\_\_\_\_  
WINDAGE: \_\_\_\_\_

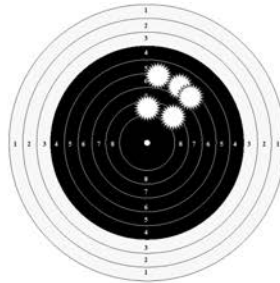

ELEVATION: \_\_\_\_\_  
WINDAGE: \_\_\_\_\_



ELEVATION: \_\_\_\_\_  
WINDAGE: \_\_\_\_\_

*Director Cadets 3, 2007, Ottawa, ON: Department of National Defence*

Figure 6L-1 Sight Adjustment Activity Targets

THIS PAGE INTENTIONALLY LEFT BLANK

### SIGHT ADJUSTMENT ACTIVITY ANSWER KEY



ELEVATION: 1 CCW  
WINDAGE: 4 CCW



ELEVATION: 2 CCW  
WINDAGE: 1 CW



ELEVATION: 5 CW  
WINDAGE: 6 CCW



ELEVATION: 6 CW  
WINDAGE: NONE



ELEVATION: 9 CW  
WINDAGE: 12 CCW



ELEVATION: 6 CCW  
WINDAGE: 1 CW



ELEVATION: 1 CCW  
WINDAGE: 6 CCW



ELEVATION: 8 CCW  
WINDAGE: 4 CCW



ELEVATION: 0 CLICKS  
WINDAGE: 0 CLICKS

*Director Cadets 3, 2007, Ottawa, ON: Department of National Defence*

Figure 6M-1 Answer Key Targets

THIS PAGE INTENTIONALLY LEFT BLANK



**CHAPTER 7**  
**PO 307 – SERVE IN AN ARMY CADET CORPS**





**ROYAL CANADIAN ARMY CADETS**  
**SILVER STAR**  
**INSTRUCTIONAL GUIDE**



**SECTION 1**

**EO M307.01 – IDENTIFY SILVER STAR TRAINING OPPORTUNITIES**

---

Total Time: 30 min

---

**PREPARATION**

---

**PRE-LESSON INSTRUCTIONS**

Resources needed for the delivery of this lesson are listed in the lesson specification located in A-CR-CCP-703/PG-001, Chapter 4. Specific uses for said resources are identified throughout the instructional guide within the TP for which they are required.

Review the lesson content and become familiar with the material prior to delivering the lesson.

Photocopy the summary of the POs and EOs for Silver Star training, located at A-CR-CCP-703/PG-001, Chapter 2, Annex A, for each cadet.

Obtain a copy of the corps Silver Star annual training plan.

Obtain a copy of the corps Full Value Contract developed during EO M107.01 (Participate in a Discussion on Year One Training, A-CR-CCP-701/PF-001, Chapter 7, Section 1).

**PRE-LESSON ASSIGNMENT**

N/A.

**APPROACH**

An interactive lecture was chosen for this lesson to orient the cadets to and generate interest in Silver Star training opportunities.

---

**INTRODUCTION**

---

**REVIEW**

N/A.

**OBJECTIVES**

By the end of this lesson the cadet shall have identified the training opportunities they will receive in Silver Star.

**IMPORTANCE**

It is important for cadets to receive an overview of the training that will be conducted during Silver Star as it may create eagerness and excitement to complete a year of new training experiences and leadership opportunities. The updates in the corps Full Value Contract should energize the cadets individually and as a group for the upcoming training year.

**Teaching Point 1****Identify Silver Star Mandatory Training Opportunities**

Time: 5 min

Method: Interactive Lecture

Silver Star mandatory training is a plan of activities that corps, and specialized training establishments (expedition centres), must conduct for year three cadets. Mandatory training is conducted as follows:

1. sixty periods of instruction to be conducted during training sessions (3 periods per session);
2. eighteen periods of instruction to be conducted during two mandatory training days (9 periods per day);
3. eighteen periods of instruction to be conducted during one weekend bivouac Field Training Exercise (FTX); and
4. eighteen periods of instruction to be conducted during one weekend expedition exercise at an expedition centre.

**TRAINING COMMON TO SEA, ARMY AND AIR CADETS**

As in Green and Red Star, there is training in Silver Star which is common and applies to sea, army and air cadets. Performance objectives (POs) for common training this year include:

<b>PO</b>	<b>Topic</b>	<b>PO Statement</b>
301	Citizenship	Recognize the Purpose of Service Groups Within Canada
302	Community Service	Perform Community Service
303	Leadership	Perform the Role of a Team Leader
304	Personal Fitness and Healthy Living	Update Personal Activity Plan
305	Recreational Sports	Participate in Recreational Sports
306	Air Rifle Marksmanship	Fire the Cadet Air Rifle During Recreational Marksmanship
307	General Cadet Knowledge	Serve in an Army Cadet Corps
308	Drill	Direct a Squad Prior to a Parade
309	Instructional Techniques	Instruct a Lesson
311	Biathlon	(Complementary Only)



The Annual Ceremonial Review (ACR) is also common to all three elements of cadets, but there is no specific training allocated for it.

**ARMY CADET ELEMENTAL TRAINING**

There is training in Silver Star that is specifically designed for army cadets. POs for the army cadet specific training this year include:

<b>PO</b>	<b>Topic</b>	<b>PO Statement</b>
320	CF Familiarization	Recognize the Valour of Members of the Canadian Army
321	Field Training	Perform the Duties of a Team Leader on a Weekend Bivouac Exercise
322	Navigation	Plot Location on a Topographical Map Using a Global Positioning System Receiver
323	Trekking	(Complementary Only)
324	Wilderness Survival	Survive When Lost
325	Outdoor Leadership	Identify the Competencies of an Outdoor Leader
326	Expedition	Perform Expedition Skills

Expedition is one activity that distinguishes army cadets from the other cadet elements. Expedition is defined as any activity that consists of dynamic travel of no less than 36 hours in duration, where there is a clear goal associated with the activity. "In Silver Star training, expedition is supported by PO 321 (Perform the duties of a Team Leader on a Weekend Bivouac Exercise, Chapter 12), PO 322 (Plot Location on a Topographical Map Using a Global Positioning System Receiver, Chapter 13), PO 324 (Survive When Lost, Chapter 14), PO 325 (Identify the Competencies of Outdoor Leaders, Chapter 15) and PO 326 (Perform Expedition Skills, Chapter 16). In Silver Star cadets will have the opportunity to attend a weekend Expedition Exercise at a Regional Expedition Centre.

Assessment is an important aspect of cadet training. It is designed to assist cadets and their instructors meet the training targets set for each PO. Cadets will be informed of the requirements prior to assessment starting. After the assessment is completed, the cadet will be informed of their results and given a copy to keep. The POs and methods to be assessed include:

- 303 (Perform the Role of a Team Leader, Chapter 3). Performance assessment and personal communication.
- 308 (Direct a Squad Prior to a Parade, Chapter 8). Performance assessment.
- 309 (Instruct a Lesson, Chapter 9). Performance assessment.
- 322 (Plot Location on a Topographical Map Using a Global Positioning System Receiver, Chapter 13), to include:
  - EC-01 Extended written response, and
  - PC Performance assessment.
- 324 (Survive When Lost, Chapter 14), to include:
  - EC-01 Performance assessment,
  - EC-02 Performance assessment,
  - EC-03 Performance assessment, and
  - EC-04 Personal communication.
- 326 (Perform Expedition Skills, Chapter 16). Performance assessment.



The details for each assessment can be located at A-CR-CCP-703/PG-001, Chapter 3, Annex B.

---

## CONFIRMATION OF TEACHING POINT 1

---

### QUESTIONS

- Q1. How many mandatory periods of instruction are there?
- Q2. What is common training?
- Q3. Which POs support expedition training in Silver Star?

### ANTICIPATED ANSWERS

- A1. There are 60 mandatory periods of instruction.
- A2. Common training is training that applies to sea, army and air cadets.
- A3. Expedition training in Silver Star is supported by PO 221 (Perform the Duties of a Section Member During a Weekend Bivouac Exercise, A-CR-CCP-702/PF-001, Chapter 11), PO 222 (Navigate Along a Route Using a Map and Compass, A-CR-CCP-702/PF-001, Chapter 12), PO 224 (Identify Immediate Actions to Take When Lost, A-CR-CCP-702/PF-001, Chapter 14), PO 325 (Identify the Competencies of Outdoor Leaders, Chapter 15) and PO 326 (Perform Expedition Skills, Chapter 16).

### Teaching Point 2

### Identify Silver Star Complementary Training Opportunities

Time: 5 min

Method: Interactive Lecture

Silver Star complementary training is a plan of activities that corps and specialized training establishments (expedition centres) may conduct for year three cadets. These activities complement mandatory activities and form an integral part of the Star Level program. Every PO identified in TP 1, except for PO 326 (Perform Expedition Skills, Chapter 16) has complementary activities available to be selected. Commanding Officers (COs) have the discretion to choose activities from a range of possibilities, thus allowing them flexibility to tailor Silver Star training to match the corps' interests and resources.



This TP will vary by cadet corps. Refer to the corps annual training plan and discuss the complementary training the cadet corps will conduct throughout the Silver Star program.

---

## CONFIRMATION OF TEACHING POINT 2

---

### QUESTIONS

- Q1. What complementary training is being conducted in Silver Star that is also available to sea and air cadets?
- Q2. What army cadet specific complementary training is being conducted in Silver Star?
- Q3. What complementary training is most interesting as a Silver Star cadet?

## ANTICIPATED ANSWERS

- A1. Answers will only be from common POs.
- A2. Answers will vary.
- A3. Answers will vary.

### Teaching Point 3

### Review the Goals of a Full Value Contract (FVC)

Time: 15 min

Method: Interactive Lecture



A corps FVC was developed in EO M107.01 (Participate in a Discussion on Year One Training, A-CR-CCP-701/PF-001, Chapter 7, Section 1) and revisited in Red Star as a refresher of the FVC.

Review the elements of the corps' existing FVC. All cadets should be aware of the corps goals that were developed.

The cadets may agree that some goals need to be changed, added or even deleted.

## GOALS OF THE FVC



A Full Value Contract can take many forms; examples are located at Annex A.

Before establishing a FVC, everyone must be ready to commit to common goals.

**Be Here.** The FVC asks everyone to make a conscious commitment to be present in body and mind, as well as to commit to full participation and to accept and demonstrate responsibility for their actions. This means that everyone shows interest in supporting others and actively engaging in the learning process.

**Be Safe.** In order to stimulate interest, facilitate participation and create an open-minded environment for the group members, everyone must feel safe. It is the instructor's responsibility to ensure that team members feel physically and emotionally safe in order to contribute to their learning process. This responsibility also falls on group members. Behaviours and attitudes must not put other group members at risk. A safe environment will encourage each member to actively participate, ask questions and give answers without fear of being ridiculed.

**Set Goals.** It is essential that everyone set personal goals. These goals provide the person and the group reference points to make choices about actions and plans. In every learning process, it is imperative to set goals. Once goals are set, group members and individuals will take on the responsibility to reach them. The FVC calls for the members of a group to work collectively toward the attainment of group goals and to support each other to meet individual goals.

**Be Honest.** Being honest assumes that one is honest with others and with oneself. For example, in a situation of disappointment or anger, the team members must simply acknowledge their feelings in regard to the situation and openly and fairly explain their state of mind. In this situation, everybody will be able to work toward solving the problem. Being honest requires members to be accountable to each other and responsible for their own actions and words.

**Let Go and Move On.** The FVC requires that group members acknowledge that they will not always agree and that they will have different opinions and ideas. In this instance, members must choose to put aside differences and move forward in order to achieve the goals.

---

### CONFIRMATION OF TEACHING POINT 3

---

#### QUESTIONS

- Q1. What are the goals of the FVC?
- Q2. In the FVC, what does “be honest” imply?
- Q3. What must happen before letting go and moving on?

#### ANTICIPATED ANSWERS

- A1. The goals of the FVC are:
- be here,
  - be safe,
  - set goals,
  - be honest, and
  - let go and move on.
- A2. That everyone is honest with others and themselves.
- A3. Everyone must choose to put aside differences and move forward in order to achieve the goals.

---

### END OF LESSON CONFIRMATION

---

#### QUESTIONS

- Q1. What POs are army cadet specific?
- Q2. Which PO in Silver Star has no complementary training?
- Q3. What changes have you noticed in the FVC over the years?

#### ANTICIPATED ANSWERS

- A1. The army cadet specific POs include:
- 320 (Recognize the Valour of Members of the Canadian Army, Chapter 11),
  - 321 (Perform the Duties of a Team Leader on a Weekend Bivouac Exercise, Chapter 12),
  - 322 (Plot Location on a Topographical Map Using a Global Positioning System Receiver, Chapter 13),
  - 323 (Trekking [complementary only]),
  - 324 (Survive When Lost, Chapter 14),
  - 325 (Identify the Competencies of an Outdoor Leader, Chapter 15), and
  - 326 (Perform Expedition Skills, Chapter 16).



A2. PO 326 (Perform Expedition Skills, Chapter 16).

A3. Answers will vary.

---

## CONCLUSION

---

### HOMEWORK/READING/PRACTICE

N/A.

### METHOD OF EVALUATION

N/A.

### CLOSING STATEMENT

Knowing what to expect in the Silver Star program allows the cadets to have an understanding of the training ahead of them. It also aids in maintaining interest and anticipation of the emerging leadership challenges for a Silver Star cadet.

### INSTRUCTOR NOTES/REMARKS

For Silver Star complementary training opportunities in TP 2, refer to the corps' annual training plan.

This EO should be scheduled as early as possible in the training year. A sample schedule is located in A-CR-CCP-703/PG-001, Chapter 2, Annex B.

---

## REFERENCES

---

- A0-054 Director Cadets 3. (2007). CATO 11-04, *Cadet Program Outline*. Ottawa, ON: Department of National Defence.
- C2-038 (ISBN 0-7872-2459-6) Henton, M. (2006). *Adventure in the Classroom: Using Adventure to Strengthen Learning and Build a Community of Life-Long Learners*. Dubuque, IA: Kendall Hunt Publishing.

THIS PAGE INTENTIONALLY LEFT BLANK



**ROYAL CANADIAN ARMY CADETS**  
**SILVER STAR**  
**INSTRUCTIONAL GUIDE**



**SECTION 2**

**EO M307.02 – IDENTIFY YEAR THREE CSTC TRAINING OPPORTUNITIES**

---

Total Time: 30 min

---

**PREPARATION**

---

**PRE-LESSON INSTRUCTIONS**

Resources needed for the delivery of this lesson are listed in the lesson specification located in A-CR-CCP-703/PG-001, Chapter 4. Specific uses for said resources are identified throughout the instructional guide within the TP for which they are required.

Review the lesson content and become familiar with the material prior to delivering the lesson.

Refer to Annex C of CATO 40-01, *Army Cadet Program Outline* prior to delivering this lesson.

**PRE-LESSON ASSIGNMENT**

N/A.

**APPROACH**

A group discussion was chosen for TP 1 as it allows the cadets to interact with their peers and share their experiences, opinions, and feelings about areas of interest for CSTC training opportunities.

An interactive lecture was chosen for TP 2 to orient the cadets to year three CSTC training opportunities and generate interest.

---

**INTRODUCTION**

---

**REVIEW**

N/A.

**OBJECTIVES**

By the end of this lesson the cadet shall have identified year three CSTC training opportunities.

**IMPORTANCE**

It is important for cadets to identify the year three CSTC training opportunities available to them, as it will allow them to make an informed decision on which course they would like to apply for.

---

**Teaching Point 1**

**Discuss the Areas of Interest for CSTC Training Opportunities**

Time: 10 min

Method: Group Discussion

---

**BACKGROUND KNOWLEDGE**

---



The point of the group discussion is to draw the following information from the group using the tips for answering/facilitating discussion and the suggested questions provided.

Write the specialty areas on a whiteboard/flip chart and discuss the activities associated with each area. Cadets may already know which area they would like to pursue and may already have a general idea of the activities.

**CEREMONIAL LEADERSHIP**

Cadets will develop the knowledge and skills required to improve leadership abilities in a peer and small group setting. Topics include:

- leadership,
- confidence building,
- public speaking,
- problem solving, and
- ceremonial drill.

**EXPEDITION LEADERSHIP**

Cadets will develop expedition knowledge and skills in a field setting. Topics include:

- adventure training activities,
- field training,
- trekking,
- navigating,
- wilderness survival, and
- expedition.

**FULLBORE MARKSMANSHIP**

Cadets will develop the knowledge and skills required to improve fullbore marksmanship abilities. Topics include:

- marksmanship with fullbore rifles,
- recreational marksmanship, and
- course level marksmanship competition.

**AIR RIFLE MARKSMANSHIP**

Cadets will develop the knowledge and skills required to improve air rifle marksmanship abilities. Topics include:

- two-position shooting (standing and prone),
- recreational marksmanship,
- course level marksmanship competition, and
- biathlon.

**FITNESS AND SPORTS**

Cadets will improve individual fitness and sports knowledge and skills. Topics include:

- studying personal fitness;
- studying rules and regulations of sports; and
- organizing and delivering sports activities.

**MILITARY BAND**

Cadets will develop music knowledge and skills. Topics include:

- studying music theory;
- playing an instrument as part of an ensemble;
- playing an instrument as part of a military band; and
- developing individual music skills.

**PIPE BAND**

Cadets will develop music knowledge and skills. Topics include:

- studying music theory;
- playing an instrument as part of an ensemble;
- playing an instrument as part of a pipe and drum band; and
- developing individual music skills.

---

## GROUP DISCUSSION

---



### TIPS FOR ANSWERING/FACILITATING DISCUSSION

- Establish ground rules for discussion, eg, everyone should listen respectfully; don't interrupt; only one person speaks at a time; no one's ideas should be made fun of; you can disagree with ideas but not with the person; try to understand others as much as you hope they understand you; etc.
- Sit the group in a circle, making sure all cadets can be seen by everyone else.
- Ask questions that will provoke thought; in other words avoid questions with yes or no answers.
- Manage time by ensuring the cadets stay on topic.
- Listen and respond in a way that indicates you have heard and understood the cadet. This can be done by paraphrasing their ideas.
- Give the cadets time to respond to your questions.
- Ensure every cadet has an opportunity to participate. One option is to go around the group and have each cadet answer the question with a short answer. Cadets must also have the option to pass if they wish.
- Additional questions should be prepared ahead of time.

### SUGGESTED QUESTIONS

- Q1. Which summer training activities interest you?
- Q2. Who is interested in applying for summer training this year? Why?
- Q3. What areas of interest do you plan to pursue? Why?



Other questions and answers will develop throughout the group discussion. The group discussion should not be limited to only those suggested.



Reinforce those answers given and comments made during the group discussion, ensuring the teaching point has been covered.

---

### CONFIRMATION OF TEACHING POINT 1

---

The cadets participation in the group discussion will serve as the confirmation of this TP.

**Teaching Point 2****Discuss Year Three CSTC Courses and the Prerequisites**

Time: 15 min

Method: Interactive Lecture



During this TP, a cadet who has successfully completed one of the year three courses could be asked to speak about their experience. This will give a cadet's view of the course and let the other cadets know what they could expect.

**COMMON COURSES**

The CSTC courses listed below are common and apply to sea, army and air cadets.



As the prerequisites for any CSTC course may change, refer to CATO 40-01, *Army Cadet Program Outline*.

**Air Rifle Marksmanship Instructor.** The aim of this course is to develop specialist knowledge and skills in air rifle marksmanship and biathlon. This will allow the cadet to assist in the development and implementation of a competitive marksmanship program and instruct marksmanship training in the corps program. The prerequisite for this six-week, regionally conducted course is the successful completion of the Silver Star program.

**Fitness and Sports Instructor.** The aim of this course is to improve individual fitness and develop the knowledge and skills needed to allow the cadet to assist in the organization and delivery of various sports activities. The prerequisites for this six-week, regionally conducted course are the successful completion of the Silver Star program, an intermediate fitness level and an interest in fitness and sports.

**Intermediate Military Band Musician.** The aim of this course is to expand on the knowledge and skills required to play and lead a unit military band. The prerequisites for this six-week, regionally conducted course are the successful completion of the Red Star program and Music Level Basic or 1.

**Intermediate Pipe Band Musician.** The aim of this course is to expand on the knowledge and skills required to play and lead a unit pipe band. The prerequisites for this six-week, regionally conducted course are the successful completion of the Red Star program and Music Level Basic or 1.

**ARMY CADET ELEMENTAL COURSES**

The CSTC courses listed below are specifically designed for army cadets.

**Drill and Ceremonial Instructor.** The aim of this course is to continue to develop leadership knowledge and skills required for junior leadership positions supporting the corps program. It also develops a specialty in drill and ceremonial, and drill instruction. The prerequisite for this six-week, regionally conducted course is the successful completion of the Silver Star program.

**Expedition Instructor.** The aim of this course is to develop subject matter knowledge and specialist skills required to successfully participate in, and lead during an intermediate level expedition. The prerequisites for this six-week course are the successful completion of the Silver Star program, ability to swim with the aid of a Personal Floatation Device (PFD) and a suitable medical category for strenuous field activities.

**Fullbore Marksman Phase I.** The aim of this course is to develop a specialist level of knowledge and skills in marksmanship beyond the air rifle. This will allow the cadet to participate as an individual or as a team member in a national-level target rifle competition. The prerequisites for this six-week, nationally conducted course are

the successful completion of the Silver Star program, the successful completion of the Basic Marksman course and demonstrated marksmanship ability.

---

**CONFIRMATION OF TEACHING POINT 2**

---

**QUESTIONS**

- Q1. What year three CSTC courses are common to army, air and sea cadets?
- Q2. What year three CSTC courses are only for army cadets?
- Q3. What year three CSTC courses interest you the most? Why?

**ANTICIPATED ANSWERS**

- A1. Year three CSTC common courses include:
- Air Rifle Marksmanship Instructor,
  - Fitness and Sports Instructor,
  - Intermediate Military Band Musician, and
  - Intermediate Pipe Band Musician.
- A2. Year three CSTC courses for army cadets only include:
- Drill and Ceremonial Instructor,
  - Expedition Instructor, and
  - Fullbore Marksman Phase I.
- A3. Answers will vary.

---

**END OF LESSON CONFIRMATION**

---

The cadets' participation in the group discussion will serve as the confirmation of this lesson.

---

**CONCLUSION**

---

**HOMEWORK/READING/PRACTICE**

N/A.

**METHOD OF EVALUATION**

N/A.

**CLOSING STATEMENT**

It is important for cadets to be familiar with the summer training courses offered, so they may apply for the courses that interest them the most. Training is offered in speciality areas that may not be accessible at the corps. Summer training is a fun and exciting aspect of the Cadet Program. CSTCs are also places to meet cadets and make new friends from different corps across Canada.

**INSTRUCTOR NOTES/REMARKS**

This EO should be conducted prior to the summer training application deadline.



It is recommended that the summer training application forms be completed during a training session after this EO has been conducted.

---

### REFERENCES

---

- A0-010 Director Cadets 2. (2006). CATO 11-03, *Cadet Program Mandate*. Ottawa, ON: Department of National Defence.
- A0-033 Director Cadets 3. (2004). CATO 14-21, *Music Training and Education With the Canadian Cadet Organizations*. Ottawa, ON: Department of National Defence.
- A2-031 Director Cadets 3. (2008). CATO 40-01, *Army Cadet Program Outline*. Ottawa, ON: Department of National Defence.

THIS PAGE INTENTIONALLY LEFT BLANK



**ROYAL CANADIAN ARMY CADETS**  
**SILVER STAR**  
**INSTRUCTIONAL GUIDE**



**SECTION 3**

**EO M307.03 – RECOGNIZE THE PARTNERSHIP BETWEEN THE ARMY CADET LEAGUE OF CANADA (ACLC) AND THE DEPARTMENT OF NATIONAL DEFENCE (DND)**

---

Total Time: 30 min

---

**PREPARATION**

---

**PRE-LESSON INSTRUCTIONS**

Resources needed for the delivery of this lesson are listed in the lesson specification located in A-CR-CCP-703/PG-001, Specific uses for said resources are identified throughout the instructional guide within the TP for which they are required.

Review the lesson content and become familiar with the material prior to delivering the lesson.

**PRE-LESSON ASSIGNMENT**

N/A.

**APPROACH**

An interactive lecture was chosen for this lesson to introduce cadets to the three levels of the ACLC and the responsibilities of the ACLC and DND in support of the CCM, as it allows the instructor to control the delivery of information while encouraging the cadets to become actively involved by asking and responding to questions.

---

**INTRODUCTION**

---

**REVIEW**

N/A.

**OBJECTIVES**

By the end of this lesson the cadet shall recognize the partnership between the ACLC and DND in support of the CCM.

**IMPORTANCE**

It is important for cadets to recognize the partnership between the ACLC and DND in support of the CCM because these two organizations work together to ensure the success of the CCM which impacts the cadet directly. Some cadets will not be aware that there are many people and organizations supporting the program beyond the local corps.

---

**Teaching Point 1****Describe the Three Levels of the ACLC**

Time: 5 min

Method: Interactive Lecture

---

There are three branches of the Army Cadet League of Canada (ACLC). Each one works in partnership with DND on respective matters.

**National**

Located in Ottawa, Ontario and overseen by an Executive Director, the national office is responsible for managing the day-to-day affairs of the ACLC.

The national office administers and coordinates all National League activities including insurance, finances and honours and awards.

**Provincial/Territorial**

The provincial branch of the ACLC oversees the local representatives and administers volunteer screening and fundraising within the province/territory. In addition, the provincial/territorial branch submits applications on behalf of the province for national awards.

**Local Sponsor**

There are many local sponsors who make up the ACLC. Volunteers from the local sponsoring committees assist cadet corps with fundraising and activities.

There is often a representative of the local sponsor of the ACLC at parades and events including the Annual Ceremonial Review each year.

---

**CONFIRMATION OF TEACHING POINT 1**

---

**QUESTIONS**

- Q1. What are the three levels of the ACLC?
- Q2. Where would a representative of the ACLC visiting a cadet corps typically come from?
- Q3. What level of the ACLC administers awards?

**ANTICIPATED ANSWERS**

- A1. The three levels of the ACLC are:
- national,
  - provincial/territorial, and
  - local sponsor.
- A2. The local sponsor.
- A3. National level.

---

**Teaching Point 2****Identify the Responsibilities of the ACLC and DND**

Time: 10 min

Method: Interactive Lecture

---

**RESPONSIBILITIES OF THE ACLC**

**Recruiting Cadets.** The local sponsor must organize and implement a plan for recruiting cadets.

**Recruiting Cadet Instructor Cadre (CIC) Officers.** The ACLC is responsible for recommending suitable people to be enrolled into the Canadian Forces (CF) as cadet instructors.

**Fundraising.** The local sponsor must organize fundraising activities that support the corps.

**Providing Corps Training Facilities.** The ACLC provincial branches provide office and training facilities for the corps, when not provided by DND.

**Organizing/Conducting Recreational Programs.** The ACLC is responsible for organizing and conducting various activities where the corps requires assistance.

**Providing Funds for Optional Training Activities.** The ACLC local sponsor and provincial branch provide funds for optional training activities which DND does not support.

**Providing Equipment to Cadet Corps.** The ACLC is responsible for providing equipment to support optional training activities.

**RESPONSIBILITIES OF DND**

**Training CIC Officers.** DND is responsible for analyzing, designing and developing course curriculum, approving training according to regional requirements and consulting with the ACLC with respect to CIC officer course content.

**Providing Qualification Standards and Plans (QSPs) and Instructional Guides (IGs) for Cadet Training.** DND develops and provides QSPs and IGs that direct cadet training.

**Providing Funds for Mandatory Training and Support Activities.** Mandatory training and support activities that are approved are funded by DND.

**Developing Policy Regarding CIC Officers, Civilian Instructors (CIs) and Cadets.** DND is responsible for developing, implementing and enforcing policy regarding CIC officers, CIs and cadets.

**Issuing Equipment to Cadet Corps IAW Scales of Issue.** All equipment required for mandatory training, mandatory support activities and directed optional training is provided by DND.

**Providing Pay for CIC Officers and CIs.** DND is responsible for developing, implementing and enforcing pay policy as well as providing pay for CIC officers and CIs.

**Selecting Cadets for Cadet Summer Training Centres (CSTCs).** DND is responsible for ensuring that cadets meet prerequisites and selecting cadets for summer training courses.

**Providing Facilities and Staff for CSTCs.** DND is responsible for ensuring adequate facilities and selecting staff for CSTCs.

**RESPONSIBILITIES OF BOTH THE ACLC AND DND**

**Forming or Disbanding Cadet Corps.** The ACLC and DND work collaboratively to form new cadet corps and disband non-effective cadet corps.

**Providing Awards and Medals.** The ACLC and DND provide awards to cadets such as the General Walsh Memorial Sword, Cadet Certificate of Commendation and the Major-General W.A. Howard Award.

**Developing Community and Media Relationships.** Media relationships are maintained at all levels of the ACLC and DND. DND has regionally and nationally appointed public affairs officers that maintain media relationships at their level. It is the responsibility of the local ACLC sponsor to ensure good relations with the local community and media.

**Supervising and Administering Cadet Corps.** The local ACLC sponsor and corps' staff work collaboratively to ensure there is adequate supervision and administration within the cadet corps.

**Providing a Reviewing Party for Annual Ceremonial Reviews (ACRs).** The ACLC and DND work collaboratively to provide reviewing parties for corps' ACRs.

---

## CONFIRMATION OF TEACHING POINT 2

---

### QUESTIONS

- Q1. What are the responsibilities of the ACLC?
- Q2. What are the responsibilities of DND?
- Q3. What is one responsibility of both the ACLC and DND?

### ANTICIPATED ANSWERS

- A1. The ACLC is responsible for:
- recruiting cadets;
  - recruiting CIC officers;
  - fundraising;
  - providing corps training facilities;
  - organizing/conducting recreational programs;
  - providing funds for optional training activities; and
  - providing equipment to cadet corps.
- A2. DND is responsible for:
- training CIC officers;
  - providing QSPs and IGs for cadet training;
  - providing funds for mandatory training and support activities;
  - developing policy regarding CIC officers, CIs and cadets;
  - issuing equipment to cadet corps IAW scales of issue;
  - providing pay for CIC officers and CIs;
  - selecting cadets for CSTCs; and
  - providing facilities and staff for CSTCs.
- A3. Both the ACLC and DND are responsible for:

- forming or disbanding cadet corps;
- providing awards and medals;
- developing community and media relationships;
- supervising and administering cadet corps; and
- providing a reviewing party for ACRs.

---

**Teaching Point 3**
**Identify the Awards and Medals of the Army Cadet Program**

Time: 10 min

Method: Interactive Lecture



CATO 13-16, *National Cadet Honours and Awards*, outlines the authority for all national awards including dress instructions.



The National Cadet Honours and Awards are not part of the Canadian Military Honours (orders, decorations and medals) system.



Selection of awards is a partnership between the cadet corps, RCSU and an ACLC representative.

**General Walsh Memorial Sword.** This award was created in 2004 by the ACLC in partnership with the Royal Canadian Legion. It is a national award and the highest national award for army cadets. The successful cadet will be hosted by the Royal Canadian Legion during Remembrance Day ceremonies and be a part of the vice-regal party. In addition to this, the cadet tours the national capital and meets both the Governor General, and the Chief of Defence Staff (CDS).

The award is named in honour of Lieutenant-General Geoffrey Walsh who dedicated much of his time to the Army Cadet Program.

Recipients are chosen based on their performance as army cadets, their community involvement and academic standings.

**Cadet Medal of Bravery.** The medal of bravery may be awarded to a cadet who performs an outstanding deed of valour involving risk of life in attempting to save the life or property of others.

**Cadet Certificate of Commendation.** The Cadet Certificate of Commendation may be awarded to a cadet for outstanding deeds in attempting to save the life or property of another person.

**Lord Strathcona Medal.** The Lord Strathcona Trust Fund Medal is given for exemplary performance in physical and military training. Lord Strathcona's objectives in establishing his endowment were:

- to encourage the improvement of the physical and intellectual capabilities of cadets; and
- to foster patriotism in cadets through the acquisition of good knowledge of military matters.

**Legion Medal of Excellence.** The Legion Medal of Excellence is given for demonstrating superior commitment to corps and community.

**Army, Navy, and Air Force Veterans Medal (ANAVETS).** The ANAVETS medal is given for overall achievement on the Cadet Leader Instructor’s course in the areas of leadership and physical fitness performance. Recipients of the ANAVETS medal are eligible to apply for the Colonel Frank Kossa Memorial Scholarship if perusing post secondary education.

**Major-General W.A. Howard Award.** This award promotes excellence in the final year of the star program in combination with a cadet’s overall performance. The award is administered and selected by a committee established within the ACLC.



*Director Cadets 3, Royal Canadian Army Cadets Reference Book, Department of National Defence (p. 2-14)*

Figure 7-3-1 Army Cadet Medals

**Army Cadet Service Medal (ACSM).** The ACSM is awarded to all nominated cadets who have completed four years of continuous meritorious service within the Army Cadet Program. Time spent within one element of the Cadet Program before a transfer to another element is counted toward the eligibility period of the Cadet Service Medal of any element. A cadet may only be awarded one service medal. The onus is on the cadet to apply for this award. The cadet cannot have any infractions and must be recommended by the corps Commanding Officer. All cadets, including former cadets can apply for the medal by completing the “Application for the Army Cadet Service Medal”.

**1st Canadian Parachute Battalion Bursary.** Awarded to a cadet with high academic standing and a graduate of the Army Cadet Parachutist Course.



Detailed prerequisites and nomination information can be found through the regional orders, and the ACLC Reference Manual at <http://www.armycadetleague.ca/Templates/refManual.htm>.

---

**CONFIRMATION OF TEACHING POINT 3**

---

**QUESTIONS**

- Q1. What is the highest national award for army cadets?
- Q2. When is the Cadet Medal of Bravery Awarded?
- Q3. What is the Legion Medal of Excellence awarded for?



**ANTICIPATED ANSWERS**

- A1. The highest national award for army cadets is the General Walsh Memorial Sword.
- A2. The Cadet Medal of Bravery is awarded when a cadet performs an outstanding deed of valour involving risk of life in attempting to save the life or property of others.
- A3. The Legion Medal of Excellence is awarded for demonstrating superior commitment to corps and community.

---

**END OF LESSON CONFIRMATION**

---

**QUESTIONS**

- Q1. What does the provincial level of the ACLC do?
- Q2. What are the responsibilities of both the ACLC and DND?
- Q3. What is the ANAVETS medal awarded for?

**ANTICIPATED ANSWERS**

- A1. The provincial branch of the ACLC oversees the local representatives and administers volunteer screening and fundraising within the province/territory. In addition, the provincial/territorial branch submits applications on behalf of the province for national awards.
- A2. Both the ACLC and DND are responsible for:
- forming or disbanding cadet corps;
  - providing awards and medals;
  - developing community and media relationships;
  - supervising and administering cadet corps; and
  - providing reviewing parties for ACRs.
- A3. The ANAVETS cadet medal of merit is given for overall achievement on the Cadet Leader Instructor's course in the areas of leadership and physical fitness performance.

---

**CONCLUSION**

---

**HOMEWORK/READING/PRACTICE**

N/A.

**METHOD OF EVALUATION**

N/A.

**CLOSING STATEMENT**

Recognizing the partnership between the ACLC and DND in support of the CCM is important because these organizations work together to ensure the success of the CCM.

**INSTRUCTOR NOTES/REMARKS**

It is recommended that this EO be scheduled early in the training year.

This EO could be delivered by the local league representative or sponsoring committee representative.

---

**REFERENCES**

---

- A2-036 Director Cadets 3. (2003). *Royal Canadian Army Cadets Reference Book*. Ottawa, ON: Department of National Defence.
- A2-065 Director Cadets and Junior Canadian Rangers. (2005). *Memorandum of Understanding Between DND and the Leagues*. Ottawa, ON: Department of National Defence.
- C2-165 Army Cadet League of Canada. (2008). *Reference Manual*. Retrieved February 26, 2008, from <http://www.armycadetleague.ca/Templates/refManual.htm>.



**ROYAL CANADIAN ARMY CADETS**  
**SILVER STAR**  
**INSTRUCTIONAL GUIDE**



**SECTION 4**

**EO C307.01 – PARTICIPATE IN A PRESENTATION GIVEN BY A  
GUEST SPEAKER FROM THE REGIONAL CADET SUPPORT UNIT**

---

Total Time:

60 min

---

**THERE IS NO INSTRUCTIONAL GUIDE PROVIDED FOR THIS EO.**

THIS PAGE INTENTIONALLY LEFT BLANK



**ROYAL CANADIAN ARMY CADETS**  
**SILVER STAR**  
**INSTRUCTIONAL GUIDE**



**SECTION 5**

**EO C307.02 – PARTICIPATE IN A PRESENTATION GIVEN BY THE CADET LIAISON OFFICER**

---

Total Time:

60 min

---

**THERE IS NO INSTRUCTIONAL GUIDE PROVIDED FOR THIS EO.**

THIS PAGE INTENTIONALLY LEFT BLANK



**ROYAL CANADIAN ARMY CADETS**  
**SILVER STAR**  
**INSTRUCTIONAL GUIDE**



**SECTION 6**

**EO C307.03 – PARTICIPATE IN A PRESENTATION GIVEN BY A  
GUEST SPEAKER FROM THE ARMY CADET LEAGUE OF CANADA**

---

Total Time:

60 min

---

**THERE IS NO INSTRUCTIONAL GUIDE PROVIDED FOR THIS EO.**

THIS PAGE INTENTIONALLY LEFT BLANK



## FULL VALUE CONTRACT

### Full Value Contract: The Circle

1. Draw a wheel. At the centre of the wheel, draw a circle. This circle represents the individuals, the group, and the goals.
2. Draw rays from this circle. On these rays, write each selected value.
3. The outer circle symbolizes that the group is one and that all members go toward the same direction.
4. Without the respect of the chosen values by everyone, the group could not make a wheel, and could not walk toward the same goals.

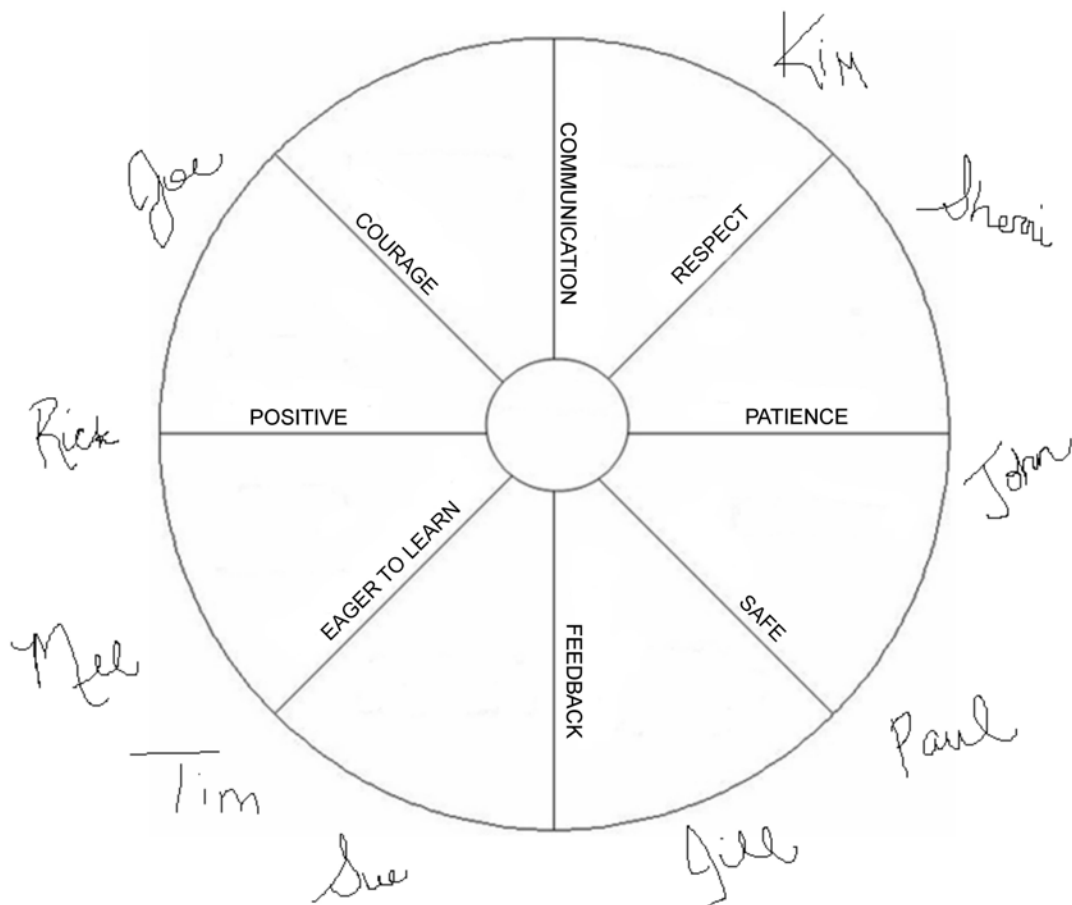

*Director Cadets 3, 2007, Ottawa ON: Department of National Defence*

Figure 7A-1 The Circle

### **Full Value Contract: The Village**

1. Draw a frame (village) on cardboard or flipchart paper.
2. Have the cadets think about values, qualities, and behaviours that make them feel safe and respected, both as an individual and in a group setting.
3. Have each cadet select their most important value, quality, or behaviour.
4. Have each cadet represent what they chose by drawing or writing it on a piece of paper.
5. Have each cadet glue their drawing or writing inside the village and briefly explain to the others why that choice was made.
6. Repeat the activity by including something that will prevent the group from reaching their goals and affect the running of the village.
7. Have each cadet explain why they chose their representation.
8. Have each cadet glue their drawing or writing outside the village.
9. Discuss the values selected by the cadets (inside and outside the village) and ask if everyone agrees. The cadets must understand that they are agreeing to respect each person's value, quality or behaviour in order for the cadet corps (village) to run properly and be a place where everyone will feel safe and respected.
10. After everyone has agreed, everyone (staff and cadets) will sign the village.

### Full Value Contract: The Five-Finger Contract

Each finger will represent a value that will help the group members feel secure, respected, and part of the group.

The five fingers on the hand represent the following:

- the little finger = safety,
  - the ring finger = commitment,
  - the middle finger = respect of others,
  - the index finger = taking responsibilities, and
  - the thumb = agreement to work toward the group's goals.
1. On a piece of cardboard or flip chart paper, write the representations of the fingers. Discuss the elements with the group so that all cadets have a clear understanding. Each cadet must agree that these five elements are important for group members to feel secure, respected, and part of the group.
  2. Have each cadet draw his/her hand on a sheet of paper and write inside each finger the element associated with each.
  3. Have each cadet sign their hand and glue it on bristol board or flip chart paper. The set of the group's hands represents everyone's commitment to each other.



*Director Cadets 3, 2007, Ottawa ON: Department of National Defence*

Figure 7A-2 The Five Finger Contract

### Full Value Contract: The Being

1. Draw the outline of a body on two pieces of flip chart paper, taped together.
2. Inside the outline, have the cadets draw or write the behaviours, qualities or values that will make the environment safe and a place where everyone is respected.
3. Outside the outline, have the cadets draw or write the behaviours, qualities or values that will prevent the environment from being safe and a place where everyone is respected.
4. Cadets must agree on the meaning of each word and explain their choices.
5. Have all cadets sign the being.

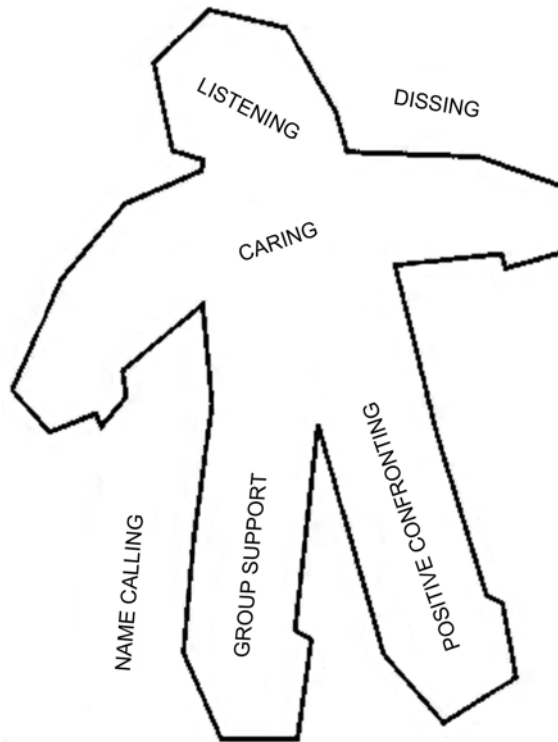

*M. Henton, Adventure in the Classroom: Using Adventure to Strengthen Learning and Build a Community of Life-Long Learners, Kendall Hunt Publishing. (p. 74)*

Figure 7A-3 The Being

### Full Value Contract: The Chain of Hands

1. Have the cadets write a list of words and sentences that describe how they would like to be treated and how they will treat the other group members in order to feel safe and respected.
2. From this list, have the cadets select the 10 most important for the group.
3. On a sheet of flip chart paper (two may be required), have the cadets draw their hands around the sheet. Write the 10 selected words or sentences in the middle of the sheet.
4. Have the cadets sign his or her own hand.



*Director Cadets 3, 2007, Ottawa ON: Department of National Defence*

Figure 7A-4 The Chain of Hands

**Full Value Contract: What do I need? What can I give?**

1. Give two pieces of different coloured paper to each cadet.
2. Ask the cadets to think about what they need in order to feel secure and respected in the group.
3. Have the cadets write the most important item they need on one of the pieces of paper.
4. Have the cadets think about what they could provide to the group in order to have other team members feel safe and respected in the group.
5. On the remaining piece of paper, have the cadets write the most important item.
6. When done writing on both pieces of paper, have the cadets present what they wrote to the group.
7. Once everyone has explained what they need and what they can provide, glue those pieces of papers on cardboard or flip chart paper, making sure that both categories are spilt up.
8. Ask the cadets if they need more explanations and then have everyone sign.

**CHAPTER 8**

**PO 308 – DIRECT A SQUAD PRIOR TO A PARADE**







**COMMON TRAINING**  
**SILVER STAR**  
**INSTRUCTIONAL GUIDE**



**SECTION 1**

**EO M308.01 – PREPARE A SQUAD FOR PARADE**

---

Total Time:

90 min

---

**PREPARATION**

---

**PRE-LESSON INSTRUCTIONS**

Resources needed for the delivery of this lesson are listed in the lesson specification located in A-CR-CCP-703/PG-001, Chapter 4. Specific uses for said resources are identified throughout the instructional guide within the TP for which they are required.

Review the lesson content and become familiar with the material prior to delivering the lesson.

Photocopy the drill sequence handout at Annex A and the aide-mémoire card at Annex B as required.

**PRE-LESSON ASSIGNMENT**

N/A.

**APPROACH**

An interactive lecture was chosen for TP 1 to introduce drill theory to the cadet.

Demonstration and performance was chosen for TP 2 as it allows the instructor to explain and demonstrate preparing a squad for a parade while providing an opportunity for the cadets to practice the skill under supervision.

---

**INTRODUCTION**

---

**REVIEW**

N/A.

**OBJECTIVES**

By the end of this lesson the cadet shall be expected to prepare a squad for parade.

**IMPORTANCE**

It is important for cadets to be able to prepare a squad for parade as they will be in placed in a team leader role and will need to know the formations and locations of all members on the parade square.

**Teaching Point 1**

**Explain Drill Theory**

Time: 20 min

Method: Interactive Lecture



Drill is the basis of all teamwork throughout the CCM. This lesson provides guidance and establishes uniformity to ensure that cadets move as one in an orderly and efficient manner. Drill promotes precision, pride and the cohesion of a corps through self-discipline and practice.

**SQUAD FORMATIONS**



The term squad is a generic name for a group of cadets. This term can be interchanged with platoon, flight, division or any other applicable elemental or regimental term.



The squad formation should be implemented when there is a parade strength of less than 32 cadets.

Squad formations are essential to maintain control and ensure uniformity. The instructor shall determine the formation to be used, based on the number of cadets present, to include:

**Single Rank.** A single rank shall be formed when there are five or fewer cadets.

**Two Ranks.** Two ranks shall be formed when there are six to nine cadets.

**Three Ranks.** Three ranks shall be formed when there are 10 or more cadets.

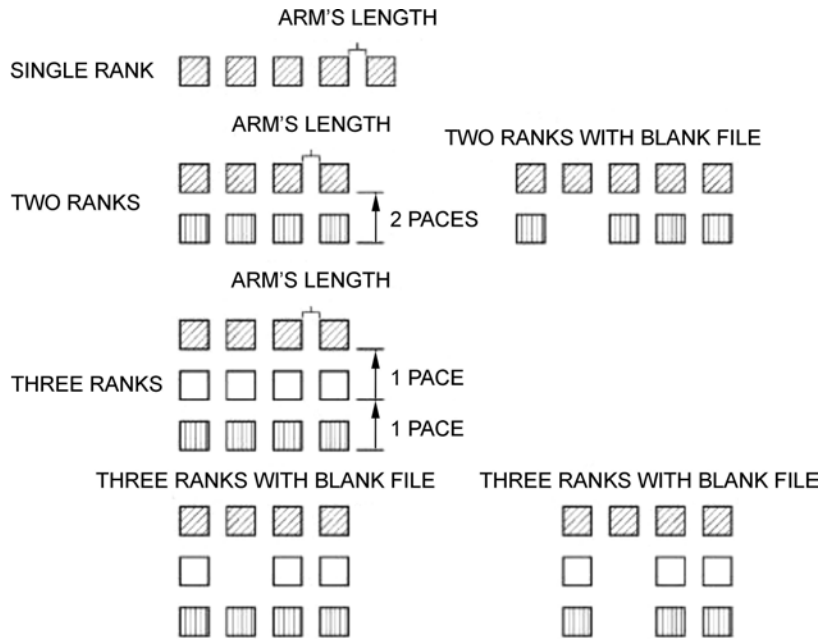

A-PD-201-000/PT-000, *The Canadian Forces Manual of Drill and Ceremonial* (p. 2-2)

Figure 8-1-1 Squad Formations



When there are not enough cadets to form complete files, a file shall be left blank (as illustrated in Figure 8-1-1). The file blank shall be the second file from the left.

In two ranks, this blank file is without a rear rank cadet, and in three ranks, this blank file is without a centre and/or rear rank cadet.

The symbol for the Parade Commander (Pde Comd) is:



The symbol for the Parade Deputy Commander (DComd) is:



The symbol for the Parade Sergeant Major (CSM) is:



The symbol for Platoon Commander (PI Comd) is:



The symbol for the Platoon Warrant Officer (PI WO) is:



The symbol Platoon Marker (Marker) is:



*Director Cadets 3, 2008, Ottawa, ON: Department of National Defence*

Figure 8-1-2 Parade Appointment Symbols

## COMPANY FORMATIONS

A company consists of two or more platoons. The aim of company drill is to manoeuvre the company as one under the command of a parade commander and assistance of a parade deputy commander. Other senior non-commissioned officers (NCOs) not directly involved with the platoons, shall be supernumeraries and form supernumerary ranks as directed by the parade commander. There shall be seven paces between platoons for all formations.



When space is limited, intervals and distances between platoons may be decreased.

There are three company formations used by cadets, to include:

**Line.** A company is formed in line when platoons are formed up side-by-side, seven paces apart and aligned facing the front, with parade appointments located in the front and rear of the formation (as illustrated in Figure 8-1-3).



To be formed in threes and in line is the common formation when a squad forms up.

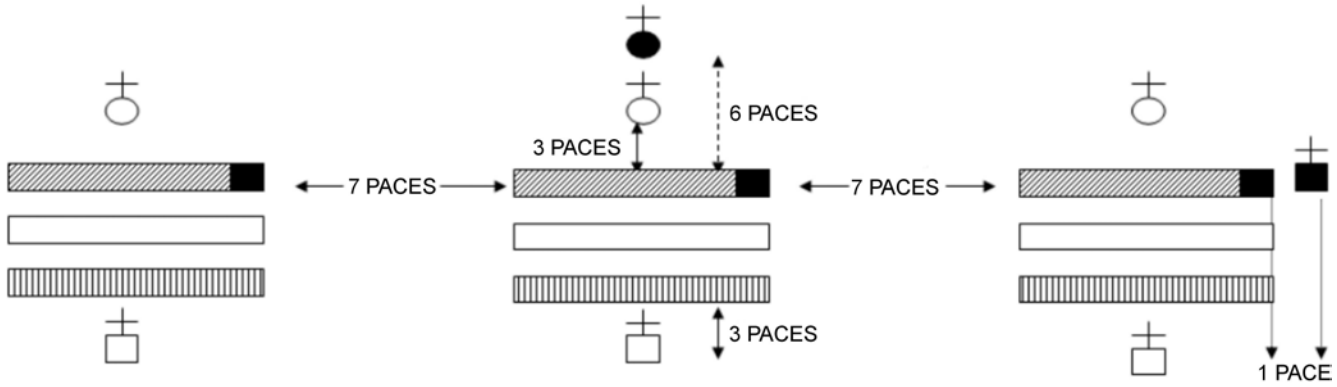

Director Cadets 3, 2008, Ottawa, ON: Department of National Defence

Figure 8-1-3 Company in Line

**Column of Threes.** A company is formed in column of threes when platoons are turned to the right or left of the front, with parade appointments located in their positions in the front and rear of the formation and turned to the right or left with the platoon (as illustrated in Figure 8-1-4).

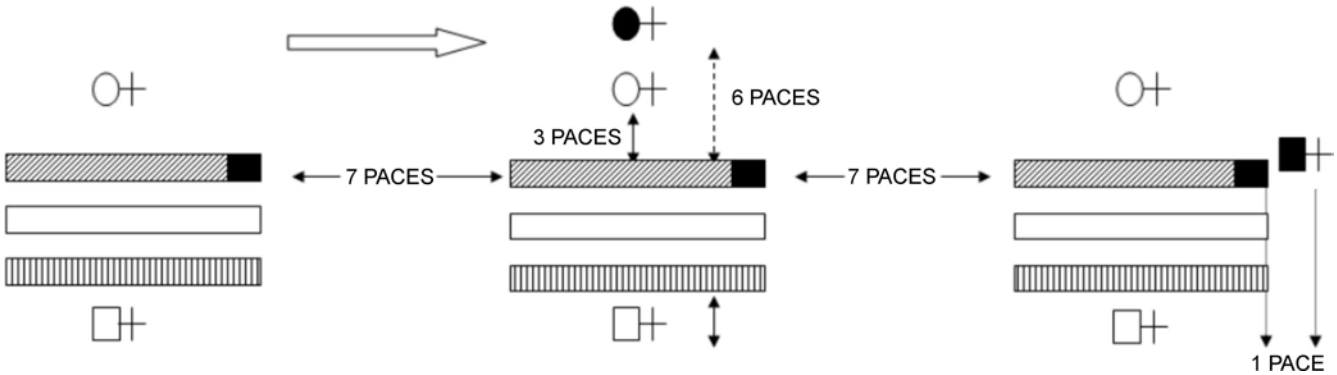

Director Cadets 3, 2008, Ottawa, ON: Department of National Defence

Figure 8-1-4 Company in Column of Threes

**Column of Route.** A company is formed in column of route when platoons are turned to the right or left, with parade appointments positioned to lead or follow the formation (as illustrated in Figure 8-1-5).

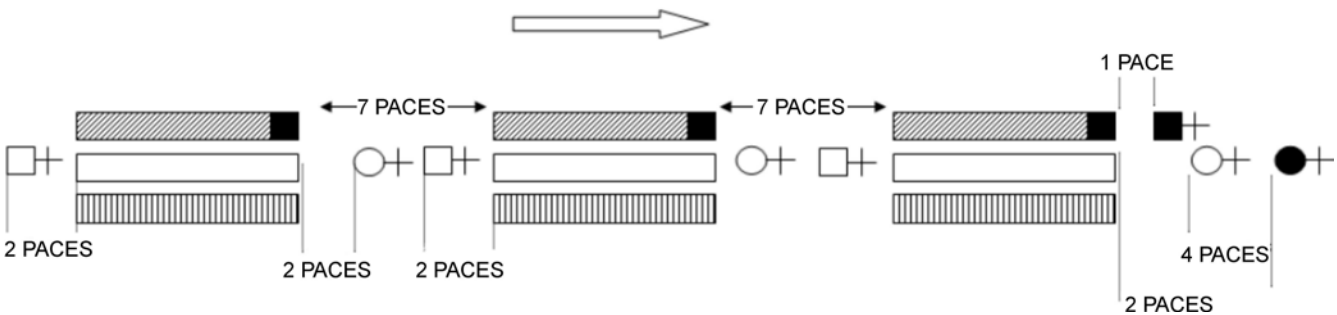

Director Cadets 3, 2008, Ottawa, ON: Department of National Defence

Figure 8-1-5 Company in Column of Route

## LOCATION OF PARADE APPOINTMENTS

The unique nature of the cadet unit allows for the adjustment of parade positions to be filled by cadet WOs and cadet senior NCOs. The following parade positions are normally filled by cadets when conducting a formal parade:

**Parade Commander (Pde Comd).** With a company in line or in column of threes, the Pde Comd is centred three paces in front of the line of platoon commanders, facing the same direction as the platoons except when addressing the company. With a company in column of route, the Pde Comd is centred four paces in front of the leading platoon.

**Parade Deputy Commander (DComd).** The DComd is an appointment that is seldom assigned in a cadet corps. If applicable, the DComd is centred three paces in front of the second single file from the right flank of the company and in line with the PI Comd.

**Parade Sergeant Major (CSM).** With a company in line or in column of threes, the CSM is located one pace to the right of the No. 1 Platoon marker, in line with the front rank. With a company in column of route, the CSM is located one pace in front of the directing flank of the leading platoon.

**Platoon Commander (PI Comd).** With a company in line or in column of threes, the PI Comd is centred three paces in front of the platoon. With a company in column of route, the PI Comd is centred two paces in front of their platoon.

**Platoon Warrant Officer (PI WO).** With a company in line or in column of threes, the PI WO is centred three paces in rear of the platoon. With a company in column of route, the PI WO is centred two paces in the rear of their platoon.



Prior to handing over to the PI Comd, the PI WO will be centred three paces in front of the platoon. After handing over to the PI Comd, the PI WO assumes their position as stated above.

**Platoon Marker (Marker).** The marker is the individual placed in the first rank of the first file to indicate the position which a body of cadets will occupy when covering and falling in. In all squad and company formations, the marker remains in the same location.

---

## CONFIRMATION OF TEACHING POINT 1

---

### QUESTIONS

- Q1. What are the three squad formations?
- Q2. What are the three company formations?
- Q3. Where is the PI Comd located when the formation is in line?

### ANTICIPATED ANSWERS

A1. The three squad formations are:

- single rank,
- two ranks, and
- three ranks.

A2. The three company formations are:

- line,
- column of threes, and
- column of route.

A3. The PI Comd is located three paces in front and centre of the platoon.

---

**Teaching Point 2**

**Explain, Demonstrate and Have the Cadet Assume the Role of a Team Leader in Preparing a Squad for Parade**

Time: 60 min

Method: Demonstration and Performance

---

When preparing a squad for parade, the team leader, acting as the PI WO, is responsible to ensure the squad is ready for parade by:

1. having the squad on the parade square by falling in a squad;
2. knowing who is present or absent by calling the roll;
3. ensuring uniformity of the squad by sizing in single rank and reforming threes (twos);
4. ensuring the squad is properly spaced by dressing a squad;
5. ensuring all cadets are well turned out by inspecting a squad; and
6. continuing with the parade by handing over the squad.



The purpose of this TP is to aid the cadets' comprehension of the process they have executed during Green and Red Star when preparing for parade during a training sessions.



If the time allotted is not sufficient for all cadets to assume the role of a team leader in preparing a squad for parade, additional time during nightly opening and closing parades shall be used to provide all cadets the opportunity for performance.

---

**ACTIVITY**

---

**OBJECTIVE**

The objective of this activity is to confirm the ability of a Silver Star cadet, as a team leader, to prepare a squad for parade.

**RESOURCES**

N/A.

**ACTIVITY LAYOUT**

N/A.

**ACTIVITY INSTRUCTIONS**

Distribute a copy of the drill sequence handout at Annex A and an aide-mémoire card at Annex B to each cadet. This activity will be conducted IAW Annex A.



For this activity, it is recommended that instruction take the following format:

1. Explain and demonstrate the complete skill while cadets observe.
2. Explain and demonstrate each step required to complete the skill.
3. Select a cadet to assume the role of team leader and practice the complete skill.

**Note:** Assistant instructors may be employed for demonstration purposes.

**SAFETY**

N/A.

---

**CONFIRMATION OF TEACHING POINT 2**

---

The cadets' participation in the activity will serve as the confirmation of this TP.

---

**END OF LESSON CONFIRMATION**

---

The cadets' participation in preparing a squad for parade will serve as the confirmation of this lesson.

---

**CONCLUSION**

---

**HOMEWORK/READING/PRACTICE**

N/A.

**METHOD OF EVALUATION**

This EO is assessed IAW A-CR-CCP-703/PG-001, Chapter 3, Annex B, Appendix 2 (308 PC).

**CLOSING STATEMENT**

When preparing a squad for parade with confidence and determination, it will affect how cadets respond to the orders given. Delivering words of command can allow a squad to move as a team in an organized and efficient manner as all members learn to work together.

**INSTRUCTOR NOTES/REMARKS**

Cadets shall perform these skills and be given feedback during weekly opening and closing parades, and ceremonial parades.

Assistant instructors may be required for this lesson.

---

**REFERENCES**

---

- A0-002 A-PD-201-000/PT-000 Director History and Heritage 3-2. (2005). *The Canadian Forces Manual of Drill and Ceremonial*. Ottawa, ON: The Department of National Defence.





**COMMON TRAINING  
SILVER STAR  
INSTRUCTIONAL GUIDE**



**SECTION 2**

**EO M308.02 – DELIVER WORDS OF COMMAND**

---

Total Time:

30 min

---

**PREPARATION**

---

**PRE-LESSON INSTRUCTIONS**

Resources needed for the delivery of this lesson are listed in the lesson specification located in A-CR-CCP-703/PG-001, Chapter 4. Specific uses for said resources are identified throughout the instructional guide within the TP for which they are required.

Review the lesson content and become familiar with the material prior to delivering the lesson.

Photocopy, cut out, fold and laminate the aide-mémoire cards with the words of command located at Annex B for each cadet.

**PRE-LESSON ASSIGNMENT**

N/A.

**APPROACH**

An interactive lecture was chosen for TP 1 to orient the cadets to the parts of a command and to generate interest.

Demonstration was chosen for TP 2 as it allows the instructor to demonstrate the voice techniques the cadets are expected to acquire.

---

**INTRODUCTION**

---

**REVIEW**

N/A.

**OBJECTIVES**

By the end of this lesson the cadet shall be expected to deliver words of command.

**IMPORTANCE**

It is important for cadets to know how to deliver words of command. Words of command that are delivered in a clear and concise manner, with confidence and determination, will affect how cadets respond to orders. Words of command are required to move a platoon in an organized and efficient manner.

---

**Teaching Point 1****Explain the Parts of a Command**

Time: 10 min

Method: Interactive Lecture

---

**CAUTIONARY COMMAND**

A cautionary command shall be given at the beginning of every command to warn the squad that a movement will be performed. It includes additional instructions to the command such as “advance” or “retire”.



The direction of the movements are indicated based on the initial front rank.

The additional instructions are based on the direction a squad falls in (as illustrated in Figure 8-2-1). In general:

- **Advance.** Indicates a turn or movement in the direction of the front rank (is used whenever turning into line).
- **Retire.** Indicates a turn or movement in the direction of the rear rank (is used whenever turning into line).
- **Move to the Right/Left.** Indicates a turn or movement in the direction of the indicated flank (eg, the right/left markers).

**EXECUTIVE COMMAND**

An executive command is to signal that the movement is to be carried out.

When written, a dash shall separate the cautionary command from the executive command.

The following are examples of words of command. In these examples, the word “TURN” indicates the executive command.

- “SQUAD RETIRE, RIGHT—TURN,”
- “SQUAD ADVANCE, LEFT—TURN,” and
- “SQUAD MOVE TO THE RIGHT IN COLUMN OF ROUTE, RIGHT—TURN.”

On the march, the cautionary command should be drawn out over at least two paces of quick time and the interval between the cautionary and executive commands should be two paces.

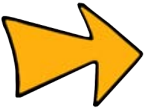

The order, “As You Were”, should only be given when another word of command cannot be given to have a squad adopt a previous position or to cancel an incorrect order before it has been completed.

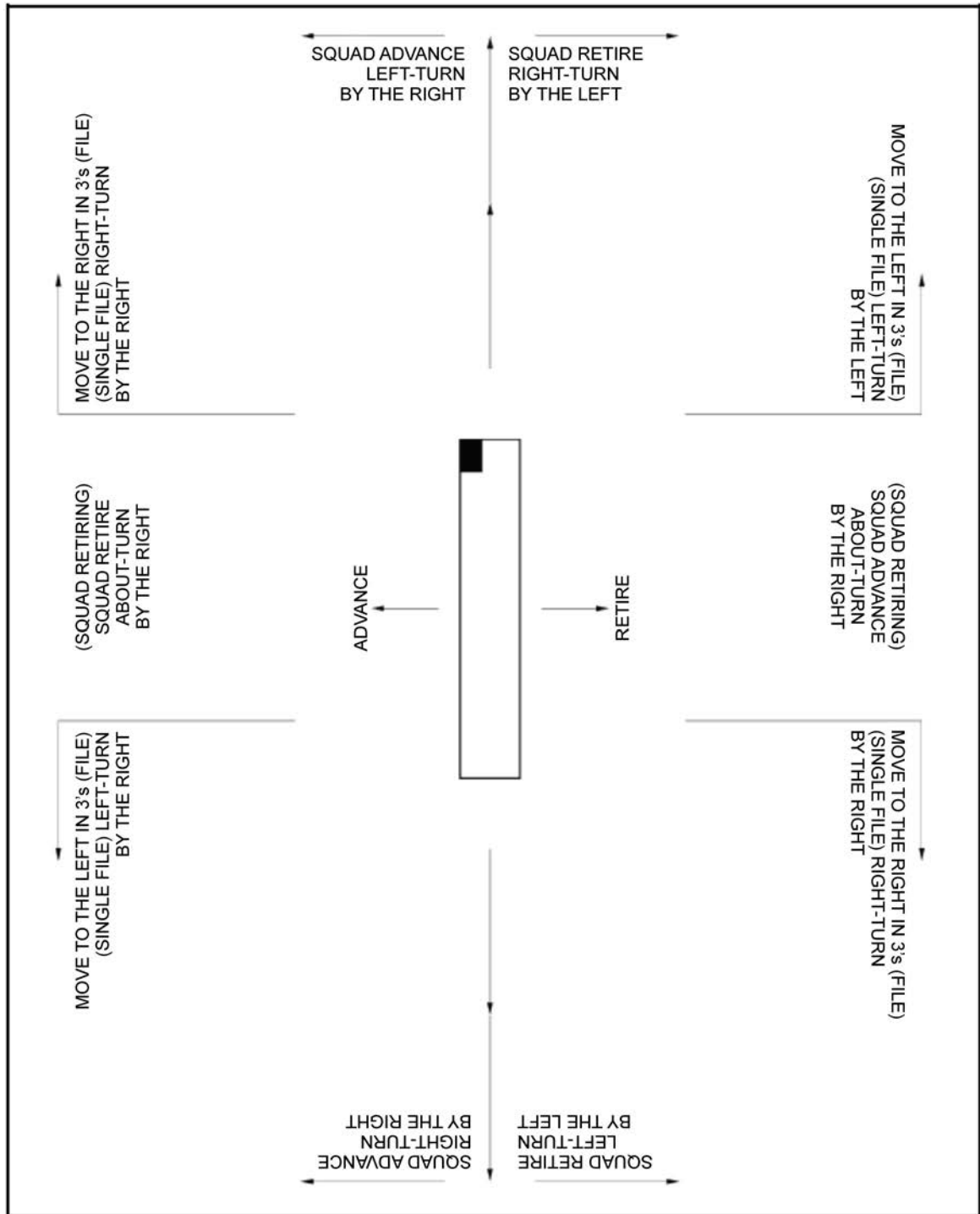

A-PD-201-000/PT-000 (p. 3-4)

Figure 8-2-1 Advance/Retire and Directing Flanks

---

**CONFIRMATION OF TEACHING POINT 1**

---

**QUESTIONS**

- Q1. Why are cautionary commands given?
- Q2. What is the purpose of the executive command?
- Q3. When commands are written, what is the purpose of the dash?

**ANTICIPATED ANSWERS**

- A1. To warn the squad that a movement will be performed.
- A2. To signal that the movement is to be carried out.
- A3. To separate the cautionary from the executive command.

---

**Teaching Point 2****Demonstrate and Explain the Requirements for a Well-Delivered Command**

Time: 15 min

Method: Demonstration

---



As each point is discussed, give an example of a command being delivered correctly and incorrectly, using the specified technique.

**VOICE**

The voice used to deliver commands has a strong effect on how others will respond. The following points should be considered:

**Volume.** The volume used to deliver a command is very important in drill. Often, commands must be presented to a group over a band or over other cadets giving commands to another group. The volume should be adjusted based on the number of individuals, the distance the command must carry and whether there is a band or not.

**Projection.** The projection of the voice is its ability to reach a desired distance. Erect posture, proper breathing, a relaxed throat and an open mouth will help a voice project.

**Distinctness.** How clearly and distinctly a command is pronounced will affect how others respond. If a command is not clear and distinct some cadets may not understand the command and perform the wrong movement. Clear enunciation and pronunciation of commands is key in distinctness.

**Inflection.** Inflection is the change in pitch of the voice. The cautionary command is usually started with a pitch near the level of the normal speaking voice and rising toward the end. The executive command should not have any change in inflection but should be delivered with a higher pitch than the cautionary command.

**Snap.** The snap of a command is the quality that demands an immediate response. It expresses the confidence and decisiveness of the commander.

**ACCURACY**

Commands must be given with accuracy at all times. Proper use of cautionary commands will alert the cadets to what is coming. The executive command will signal the cadets that the movement is to be carried out. When delivering executive commands on the march, it is important that it be delivered on the correct foot.

**CONFIDENCE**

All words of command must be given with confidence. This portrays that it is an order that must be promptly and smartly obeyed. A command delivered with confidence will help build a sense of security in the commander from the members of the squad.

**CORRECT POSTURE**

Poor posture restricts the ability to breathe deeply as it restricts the movement of the diaphragm. Maintaining good posture will allow a cadet to breathe deeply allowing the command to come deep from the diaphragm instead of from the throat causing less strain on the throat and allowing the command to be given with more volume.

**BREATHING CONTROL**

Breathe deeply and relax the muscles in the neck and vocal cords in order to give the voice more control and a higher volume. This will allow the voice to come from deep in the diaphragm instead of higher in the throat.

---

**CONFIRMATION OF TEACHING POINT 2**

---

**QUESTIONS**

- Q1. If a command is not pronounced clearly and distinctly, what affect may it have on the squad being commanded?
- Q2. Why should commands be delivered with confidence?
- Q3. How does poor posture affect delivering commands?

**ANTICIPATED ANSWERS**

- A1. Cadets may not understand the command and perform the wrong movement.
- A2. It portrays that it is an order that must be promptly and smartly obeyed.
- A3. It restricts the ability to breathe deeply, restricting the movement of the diaphragm, which will cause commands to come from the throat.

---

**END OF LESSON CONFIRMATION**

---

**QUESTIONS**

- Q1. What order is given to cancel an incorrect order before it has been completed?
- Q2. What are the five points of voice to be considered for a well-delivered command?
- Q3. What gives the voice more control and a higher volume?

**ANTICIPATED ANSWERS**

- A1. The order, "As You Were".

A2. Volume, projection, distinction, inflection and snap.

A3. Breathing deeply and relaxing the muscles in the neck and vocal cords.

---

## CONCLUSION

---

### HOMEWORK/READING/PRACTICE

N/A.

### METHOD OF EVALUATION

N/A.

### CLOSING STATEMENT

When words of command are delivered in a clear and concise manner and with confidence and determination, it will affect how cadets respond to the order. Delivering words of command can allow a platoon to move as a team in an organized and efficient manner as all members learn to work together.

### INSTRUCTOR NOTES/REMARKS

Cadets shall be provided the opportunity to deliver words of command and be given feedback during weekly opening and closing parades, and ceremonial parades.

Additional time for this EO is available in EO C308.02 (Deliver Words of Command, Section 4).

---

## REFERENCES

---

- A0-002 A-PD-201-000/PT-000 Director History and Heritage 3-2. (2005). *The Canadian Forces Manual of Drill and Ceremonial*. Ottawa, ON: Department of National Defence.
- C0-022 (ISBN 0-02-864207-4) Cole, K. (2002). *The Complete Idiot's Guide to Clear Communication*. Indianapolis, IN: Alpha Books.
- C0-241 Optimal Breathing. (2007). *Posture and Breathing*. Retrieved February 12, 2008, from <http://breathing.com/articles/posture.htm>.
- C0-269 AFMAN 36-2203 Department of the Air Force. (1996). *Drill and Ceremonies*. Lackland, AFB, TX: Secretary of the Air Force.



**COMMON TRAINING  
SILVER STAR  
INSTRUCTIONAL GUIDE**



**SECTION 3  
EO C308.01 – EXECUTE FLAG DRILL**

---

Total Time:

180 min

---



---

**PREPARATION**

---

**PRE-LESSON INSTRUCTIONS**

Resources needed for the delivery of this lesson are listed in the lesson specification located in A-CR-CCP-703/PG-001, Chapter 4. Specific uses for said resources are identified throughout the instructional guide within the TP for which they are required.

Review the lesson content and become familiar with the material prior to delivering the lesson.

For further direction and information on cadet flags and banners, refer to CATO 12-05, *Cadet Flags and Banners*, Paragraphs 1. to 9.

**PRE-LESSON ASSIGNMENT**

N/A.

**APPROACH**

An interactive lecture was chosen for TP 1 to present basic background material on flags and flag parties.

Demonstration and performance was chosen for TPs 2–6 as it allows the instructor to demonstrate and explain the skills the cadets are expected to acquire while providing an opportunity for the cadets to practice flag drill under supervision.

---

**INTRODUCTION**

---

**REVIEW**

N/A.

**OBJECTIVES**

By the end of this lesson the cadet, as a member of a flag party, shall have executed flag drill.

**IMPORTANCE**

It is important for cadets to execute flag drill so they are able to take part in ceremonies and parades as members of the flag party at the corps, cadet summer training centre (CSTC) and other community events as

required. Colours and flags have many meanings and are symbols of such things as achievements, nationality and identity. It is considered an honour to be a member of the flag party.

### Teaching Point 1

### Explain Details of Flags, the Pike, the Colour Carrying Belt and the Composition of a Flag Party

Time: 10 min

Method: Interactive Lecture

### FLAGS

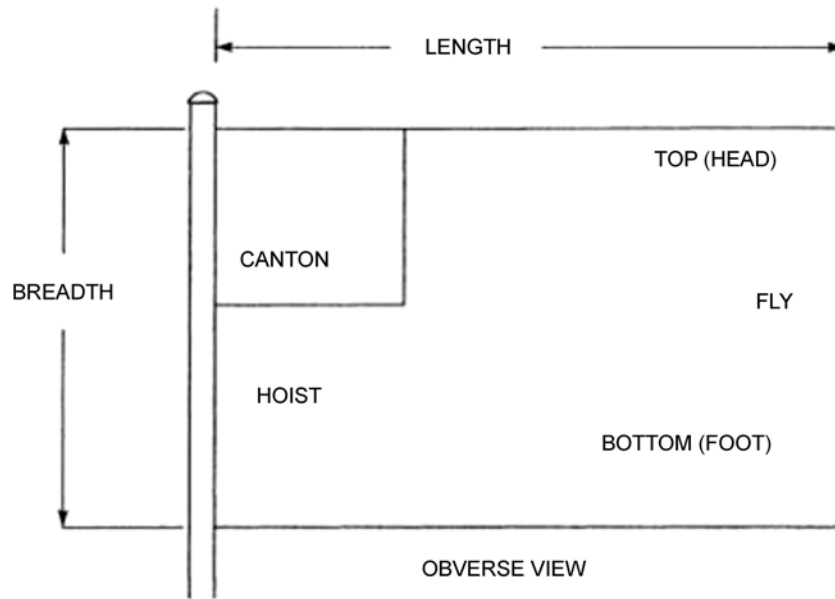

A-AD-200-000/AG-000, *The Honours, Flags and Heritage Structure of the Canadian Forces* (p. 4-1-8)

Figure 8-3-1 Details of a Flag

**Flags.** As a generic term (including colours), flags are pieces of bunting or other material, attachable to a pike, staff or halyard, and used as a means of identification or for signalling.

**Canton.** The upper half of the hoist. It is also called the First Quarter and sometimes the Upper Hoist. The canton is considered the place of honour on a flag.

**Hoist.** The half of the flag nearest to the halyard.

**Halyard.** The rope that raises or lowers a flag.

**Fly.** The half of the flag furthest from the halyard.

**Staff (Flagstaff).** A pole on which a flag is mounted for display.



Colours are consecrated ceremonial flags carried to mark the identity of Canadian Forces (CF) formations and units. They belong to a separate class and are not paraded with other flags. Cadet flags are not consecrated (made sacred and devoted to service by the Chaplain General as symbols of honour and duty), therefore shall not be referred to as colours.

Commanding Officers of cadet corps and CSTCs shall ensure that flags and banners are not referred to as colours, adorned with honours or consecrated and not issued at public expense.



Flags are used to identify individuals and groups. Many flags which originated as the insignia of individuals gradually came to represent the state or agencies within the state.

### Authorized Flags and Banners

The following is a list of flags and banners that may be carried on parade by cadet units:

1. the Royal Canadian Sea Cadets Ensign,
2. the Royal Canadian Army Cadets Flag,
3. the Royal Canadian Air Cadets Ensign, and
4. the Royal Canadian Air Cadets Squadron Banner.

The following is a list of flags and banners that should only be carried on ceremonial parades to indicate a cadet formation:

1. the Royal Canadian Army Cadets Banner,
2. the Royal Canadian Army Cadets Trumpet Banner,
3. the Royal Canadian Army Cadets Pipe Banner,
4. the Royal Canadian Air Cadets Banner, and
5. the Royal Canadian Air Cadets Pipe Banner.

### THE PIKE

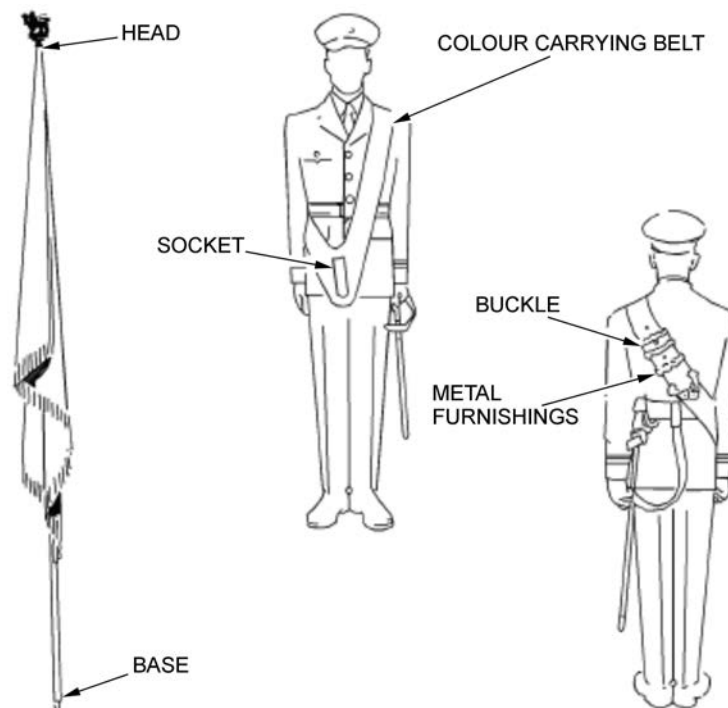

*A-PD-201-000/PT-000 (p. 8-2-3)*

Figure 8-3-2 Details of the Pike and Colour Carrying Belt

**Pike.** A pole on which colours or other flags are mounted for carrying or displaying.

**Pike Head.** The decorative ornament (finial) on the top of a pike, staff or pole.

## COLOUR CARRYING BELT

The colour carrying belt is worn over the left shoulder by members of the flag party carrying flags. The socket is the “pocket” where the pike base is placed while the flag is in the carry position.

## COMPOSITION OF A FLAG PARTY

### LEGEND

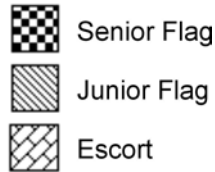

*Director Cadets 3, 2008, Ottawa, ON: Department of National Defence*

Figure 8-3-3 Flag Party Legend



*Director Cadets 3, 2008, Ottawa,  
ON: Department of National Defence*

Figure 8-3-4 Flag Party for One Flag

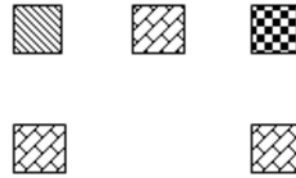

*Director Cadets 3, 2008, Ottawa,  
ON: Department of National Defence*

Figure 8-3-5 Flag Party for Two Flags

The composition of a flag party carrying one flag (as illustrated in Figure 8-3-3) consists of the flag party commander (cadet carrying the flag) and two escorts (cadets on either side of the flag).

The composition of a flag party carrying two flags (as illustrated in Figure 8-3-4) consists of one senior escort (cadet between the flags), the flag party commander and one flag bearer (cadets carrying the flags) and two senior NCOs (cadets directly behind the flags).

The flag party commander and/or flag bearer is appointed to carry, handle and protect the flags.

The senior escort and/or escort are appointed to safeguard the flags. They remain with the flags and may or may not carry drill-purpose rifles.



When a flag party carries the national flag and either the CF Ensign or a command flag, the national flag occupies the position of honour on the right (on the left from the spectators view) and is normally carried by a senior cadet.

Normally, the national flag does not have an escort. It may be given an escort with a drill-purpose rifle if the cadets on parade are carrying drill-purpose rifles.

---

### CONFIRMATION OF TEACHING POINT 1

---

## QUESTIONS

Q1. What is a pike?

Q2. Over which shoulder is the colour carrying belt worn?

Q3. How many members are in a flag party with only one flag?

### ANTICIPATED ANSWERS

A1. A pike is a pole on which colours or other flags are mounted for carrying or displaying.

A2. The colour carrying belt is worn over the left shoulder.

A3. There are three members in a flag party with only one flag: the flag party commander and two escorts.

### Teaching Point 2

### Demonstrate, Explain and Have the Cadets Practice Adopting the Order, Stand at Ease From the Order, Stand Easy From the Stand at Ease, Stand at Ease From the Stand Easy and Order From the Stand at Ease With a Flag

Time: 15 min

Method: Demonstration and Performance



Develop and use a vocabulary of short, concise words to impress on the cadets that the movements must be performed smartly. For example, the words “crack”, “drive”, “seize” and “grasp” suggest the degree of smartness required. Profanity or personal sarcasm shall never be used.

Proper drill movements shall be combined with a professional demeanour throughout the period of instruction.

Check for faults and correct them immediately as they occur.



Each TP is to be conducted as follows:

1. Have the cadets fall in, in an effective squad formation (eg, hollow square, semi-circle or single rank).
2. Demonstrate and explain each movement, as time allows.
3. Give the cadets time to practice each movement on their own.
4. After all movements have been demonstrated and practiced, deliver commands and have all the cadets perform them as a squad.



Capitalization indicates the words of command for each movement.

Cadence is to be maintained while completing these movements.

### THE ORDER (ATTENTION)



The position for the Order is the same as Attention.



*A-PD-201-000/PT-000 (p. 8-3-2)*

Figure 8-3-6 The Order (Attention)

To assume the position of the order (attention), the cadets shall:

1. Stand with heels together and in line, with the feet turned out to form an angle of 30 degrees.
2. Maintain balance and distribute weight evenly on both feet.
3. Keep the shoulders squared and to the front.
4. Hold the head erect with the neck touching the back of the collar, eyes steady, looking directly to the front.
5. Hold the pike vertical in the right hand, along the right side.
6. Keep the base of the pike on the ground at the right foot in line with the small toe.
7. Hold the pike and flag with an all-round grasp with the right hand, with the back of the hand pointed outwards at the point of the pike where the lowest corner of the flag hangs.
8. Ensure the flag hangs naturally down the pike and is not pulled taut.
9. Keep the right elbow at the side.
10. Hold the left arm at the position of attention.

**STAND AT EASE FROM THE ORDER**

*A-PD-201-000/PT-000 (p. 8-3-2)*

Figure 8-3-7 Stand at Ease

On the command, **STAND AT—EASE**, the cadets shall:

1. bend the left knee and place the left foot smartly on the ground 25 cm (approximately 10 inches) to the left;
2. maintain the left arm in the position of attention; and
3. maintain the pike and flag in the position of the order.



Timing for this movement is one.

**STAND EASY FROM STAND AT EASE**

On the command, **STAND—EASY**, the cadets shall:

1. maintain the feet at the position of stand at ease;
2. keep the left arm at the side; and
3. relax the body.



Timing for this movement is one.

### **STAND AT EASE FROM STAND EASY**

On the command, SQUAD, the cadets shall resume the position of stand at ease.



Timing for this movement is one.

### **ORDER FROM STAND AT EASE**

On the command, ATTEN—TION, the cadets shall:

1. bend the left knee and bring the left foot to the position of attention, keeping the left arm at the side; and
2. maintain the pike and flag in the position of the order.



Timing for this movement is one.

---

### **CONFIRMATION OF TEACHING POINT 2**

---

The cadets' practicing of the order, stand at ease and stand easy, with a flag, will serve as the confirmation of this TP.

**Teaching Point 3****Demonstrate, Explain and Have the Cadets Practice Adopting the Carry From the Order, Order From the Carry, Let Fly From the Carry and Catch the Flag From the Let Fly**

Time: 25 min

Method: Demonstration and Performance

**CARRY FROM THE ORDER***A-PD-201-000/PT-000 (p. 8-3-4)*

Figure 8-3-8 Carry From the Order

On the command, CARRY—FLAGS, the cadets shall:

1. on the first movement:
  - (a) with the right hand, carry the flag to a vertical position in front of the centre of the body, keeping the right forearm along the side of the pike, and keeping the base of the pike just over the socket of the carrying belt; and
  - (b) simultaneously, bring the left hand to the socket and guide in the base of the pike; and
2. on the second movement:
  - (a) cut the left hand to the side in the position of attention; and
  - (b) simultaneously, bring the right forearm parallel to the ground so that upon completion of the movement, the right hand is opposite the mouth with the back of the right hand facing out, the wrist straight and the forearm parallel to the ground.

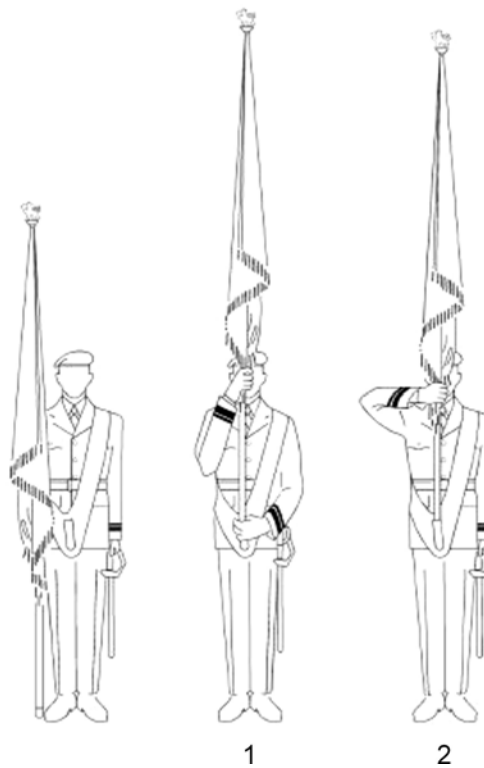

Timing for this movement is one-two-three, one.

### ORDER FROM THE CARRY

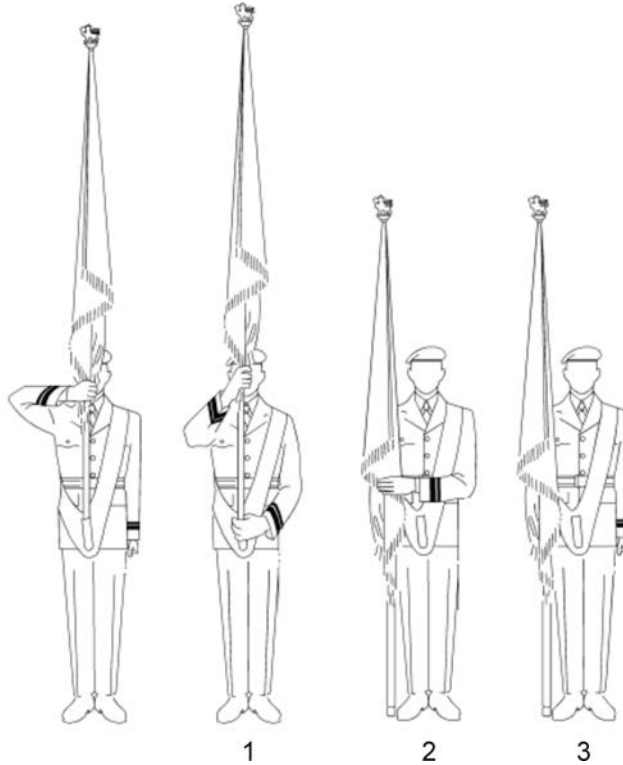

*A-PD-201-000/PT-000 (p. 8-3-6)*

Figure 8-3-9 Order From the Carry

On the command, ORDER—FLAGS, the cadets shall:

1. on the first movement:
  - (a) bring the right forearm from a horizontal to a vertical position along the pike and with the right hand, raise the pike clear of the socket of the carrying belt; and
  - (b) simultaneously, bring the left hand to the socket to steady the pike and the carrying belt; and
2. on the second movement:
  - (a) carry the flag with the right hand to the position of the order; and
  - (b) simultaneously, move the left hand across the body to steady the pike with the forearm parallel to the ground, the back of the hand facing out, and the fingers of the left hand together, extended and pointing to the right; and
3. on the third movement, cut the left hand to the side in the position of attention.



Timing for this movement is one-two-three, one-two-three, one.



**LET FLY FROM THE CARRY**

Let fly is used either as a salute to dignitaries or to allow for the identification of the flag.

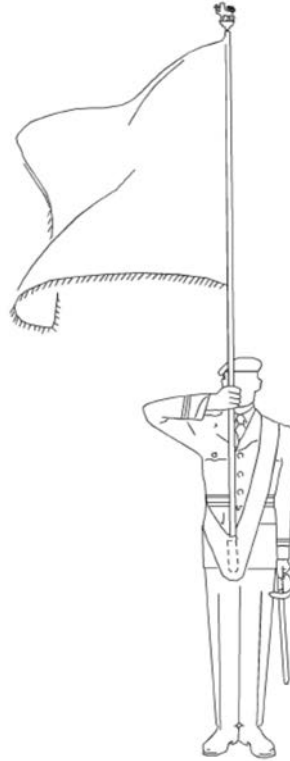

*A-PD-201-000/PT-000 (p. 8-3-17)*

Figure 8-3-10 Let Fly From the Carry

On the command LET FLY THE—FLAG(S), the cadets shall:

1. maintain the grip of the pike; and
2. simultaneously release the flag with a downward movement of the right hand.

This drill movement is also used on the commands:

- GENERAL SALUTE—SALUTE; and
- EYES—RIGHT during a march past (the flag is let fly on the next left foot).



Timing for this movement is one.

## CATCH THE FLAG FROM THE LET FLY

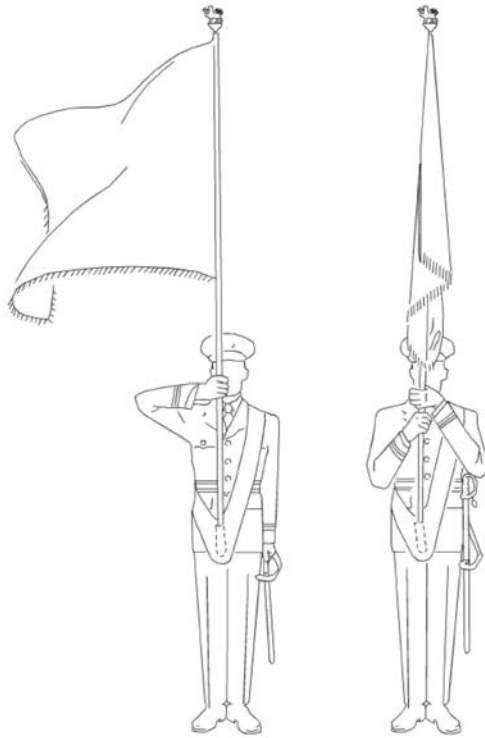

*A-PD-201-000/PT-000 (p. 8-3-18)*

Figure 8-3-11 Catch the Flag From the Let Fly

On the command, CATCH THE— FLAG(S), the cadets shall:

1. on the first movement:
  - (a) grasp the flag with the left hand and bring it in to the pike; and
  - (b) simultaneously, grasp the corner of the flag with the right hand, back of the hand outwards, at the point of the pike where the lowest corner of the flag reached; and
2. on the second movement, cut the left hand to the side to the position of attention and raise the right forearm to the horizontal position.

This drill movement is also used on the commands:

- ATTEN—TION following the General Salute; and
- EYES—FRONT during the march past.



Timing for this movement is one-two-three, one.



Depending on the wind direction, the flag may be grasped with the right hand after securing the pike in the left hand. If, because of wind strength, the flag cannot be caught, the flag shall be brought to the position of the order, the flag secured and returned to the carry.

---

### CONFIRMATION OF TEACHING POINT 3

---

The cadets' practicing of carry from the order, order from the carry, let fly and catch the flag will serve as the confirmation of this TP.

---

#### Teaching Point 4

#### Demonstrate, Explain and Have the Cadets Practice Marching and Halting in Quick Time and Spiral Countermarching With Flags

Time: 35 min

Method: Demonstration and Performance

---

#### MARCHING AND HALTING IN QUICK TIME WITH FLAGS

On the command, QUICK—MARCH, the cadets shall:

1. shoot the left foot forward one half pace (35 cm [14 inches]), with the toe up;
2. strike the heel on the ground first and keep the toe pointed directly forward;
3. simultaneously, swing the left arm back waist high;
4. maintain the right arm in the position of the carry; and
5. continue to march with subsequent standard paces (75 cm [30 inches]).



Timing for this movement is left-right-left.

On the command, SQUAD—HALT, the cadets shall:

1. place the right foot flat on the ground naturally, using the heel as a brake;
2. simultaneously swing the left arm forward, breast-pocket high;
3. take a half pace (35 cm [14 inches]) with the left foot, placing it flat on the ground, swinging the left arm back;
4. bend the right knee and straighten it in double time; and
5. simultaneously, cut the left arm to the side as quickly as possible and assume the position of attention.



The command SQUAD—HALT is given as the left foot is on the ground.



Timing for this movement is one-one-two.



Practice the movements with:

- the **instructor** calling the time;
- the **squad** calling the time; and

- the squad **judging** the time.

Emphasize any movements that the cadets had difficulty with during the lesson.

### SPIRAL COUNTERMARCHING WITH FLAGS

An adapted form of the spiral countermarch is used to reverse the direction that the flag party is facing without using as much space as is required for a double wheel by the flag party.

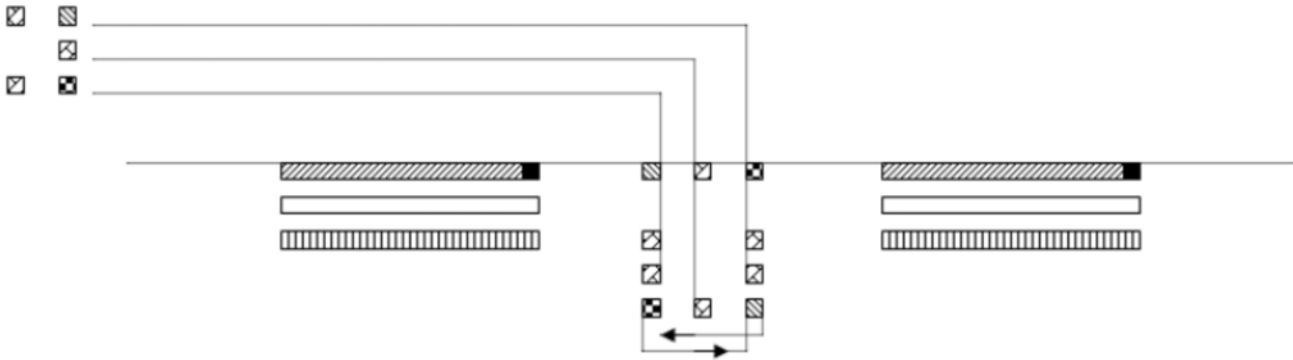

*Director Cadets 3, 2008, Ottawa, ON: Department of National Defence*

Figure 8-3-12 Spiral Countermarch

On the command, FLAG PARTY, SPIRAL COUNTER—MARCH:

1. all cadets shall maintain the same cadence;
2. the cadets in the file on the right shall perform two consecutive left wheel movements;
3. the cadets in the centre and the file on the left shall perform two consecutive right wheel movements; and
4. the escorts in the rear rank shall follow the flag bearer to their front into position while maintaining dressing.



It is recommended to end this lesson here and teach TPs 5 and 6 during a second session.

### CONFIRMATION OF TEACHING POINT 4

The cadets' participation in practicing marching and halting, and spiral countermarching with flags will serve as the confirmation of this TP.

### Teaching Point 5

**Demonstrate, Explain and Have the Cadets Practice Forming to the Right and Left With Flags**

Time: 40 min

Method: Demonstration and Performance



A form changes the direction faced by a flag party in line while maintaining its formation.

## CHANGE DIRECTION BY FORMING AT THE HALT

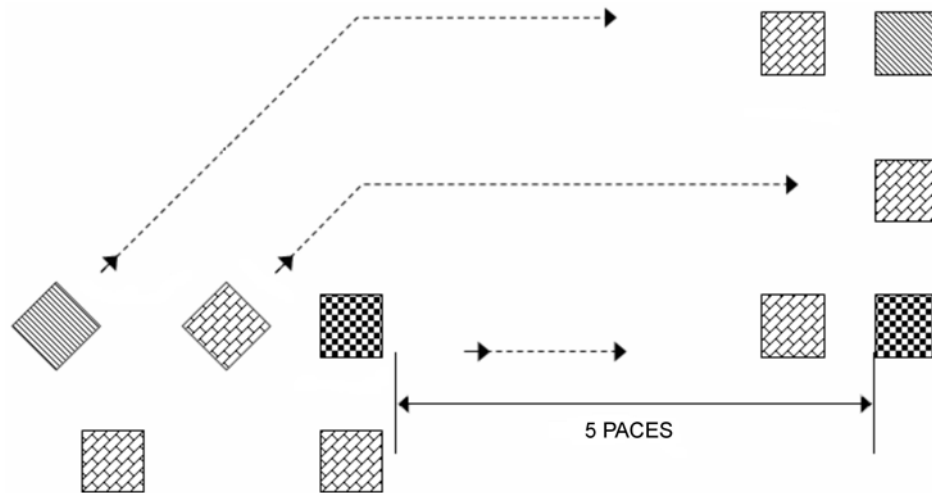

*Director Cadets 3, 2008, Ottawa, ON: Department of National Defence*

Figure 8-3-13 Right Form

To change direction by forming at the halt to the halt, the following movements shall occur:

On the command AT THE HALT, CHANGE DIRECTION RIGHT (LEFT), RIGHT (LEFT)—FORM:

1. the leading person on the directing flank turns right (left);
2. simultaneously, the remainder of the front rank makes a right (left) incline; and
3. the rear ranks stand fast.

On the command QUICK—MARCH:

1. the leading person of the directing flank marches forward five paces and halts;
2. simultaneously, the remainder of the squad steps off, wheeling as necessary to regain their original position to the left (right) of the directing flank; and
3. each successive file halts in succession from right to left (left to right), facing the new direction.

## CHANGE DIRECTION BY FORMING ON THE MARCH



The command CHANGE DIRECTION RIGHT (LEFT), RIGHT (LEFT)—FORM is given as the left (right) foot is on the ground.

To change direction by forming on the march, the following movements shall occur:

On the command CHANGE DIRECTION RIGHT (LEFT), RIGHT (LEFT)—FORM:

1. the leading person of the directing flank makes a right (left) turn, marches forward six paces and marks time;
2. simultaneously, the remainder of the front rank makes a right (left) incline and steps off toward the new position in line with the right (left) flag;

3. the remainder of the squad wheels as necessary to regain their original position to the left (right) of the directing flank; and
4. each successive file marks time, in succession from right to left (left to right), facing the new direction.

On the command FOR—WARD or FLAG PARTY—HALT, the squad acts as ordered.



The commands FOR—WARD and FLAG PARTY—HALT are given as the left foot is on the ground.



Practice the movements with:

- the **instructor** calling the time;
- the **squad** calling the time; and
- the squad **judging** the time.

Emphasize any movements that the cadets had difficulty with during the lesson.

---

### CONFIRMATION OF TEACHING POINT 5

---

The cadets' practicing of change direction by forming at the halt and on the march will serve as the confirmation of this TP.

---

### Teaching Point 6

### Demonstrate, Explain and Have the Cadets Practice Marching On and Marching Off the Flags

Time: 45 min

Method: Demonstration and Performance

---

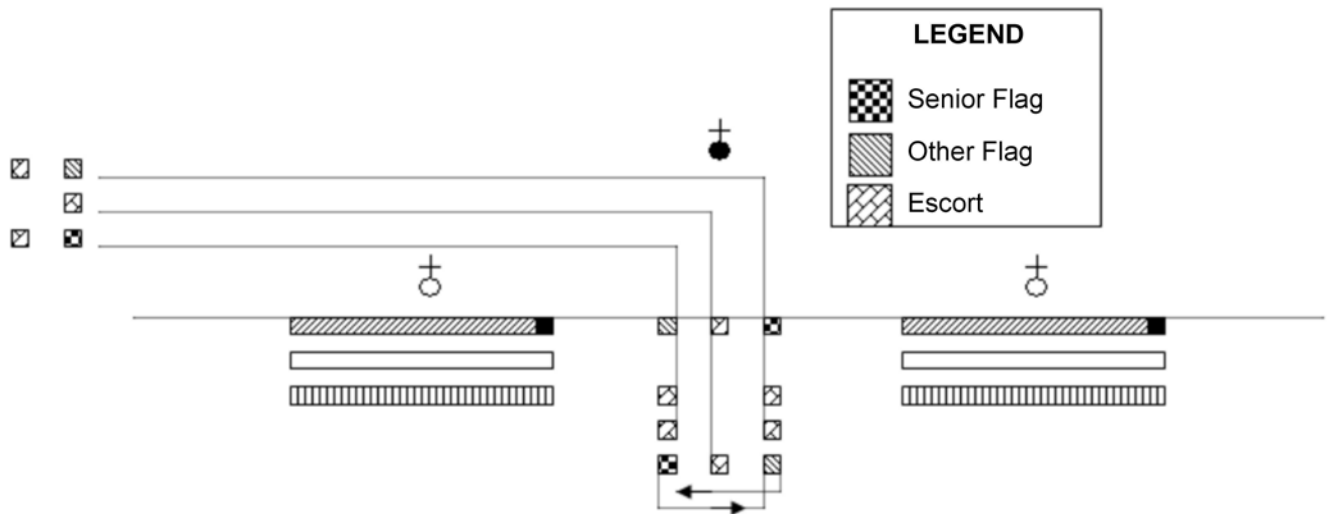

The flag party shall march on and march off the parade from the same flank, either left or right.

**MARCHING ON THE FLAG(S)**

*Director Cadets 3, 2008, Ottawa, ON: Department of National Defence*

Figure 8-3-14 March on the Flag(s) From the Left Flank

On the command, MARCH ON THE—FLAG(S), members of the flag party shall perform the following:

1. the flag party commander shall order the cautionary FLAG PARTY;
2. the parade commander shall order TO THE FLAG(S)—SALUTE; and
3. the flag party commander shall order BY THE RIGHT (CENTRE), QUICK—MARCH.

The flag party shall march to its position by a series of forms (as illustrated in Figure 8-3-14).

On the command, FLAG PARTY, SPIRAL COUNTER—MARCH:

1. all cadets shall maintain the same cadence;
2. the cadets in the file on the right shall perform two consecutive left wheel movements;
3. the cadets in the centre and the file on the left shall perform two consecutive right wheel movements; and
4. the escorts in the rear rank shall follow the flag bearer to their front into position while maintaining dressing.

The series of forms shall be conducted as follows:

1. On the command FLAG PARTY, QUICK—MARCH, the flag party shall move as a unit to a location on the parade square centred on the parade commander.
2. On the command FLAG PARTY, CHANGE DIRECTION RIGHT (LEFT), RIGHT (LEFT)—FORM, the flag party shall perform a right (left) form on the march. Upon completion of the form, the cadets shall mark time.
3. The flag party shall resume marching on the command FOR—WARD.
4. The flag party shall perform a spiral countermarch.
5. Upon completion of the spiral countermarch, the flag party shall move to a predetermined location on the parade square.

6. Upon halting in its parade position, the flag party commander orders FLAG PARTY, TO THE FLAG(S) —SALUTE.



If the flag party is armed, the flag party commander will order FLAG PARTY, TO THE FLAG(S), PRESENT—ARMS.

Once the flag escort is at the present, the parade commander will order SLOPE—ARMS, and the parade, now including the flag party will slope arms.

Until the flag party is ordered off at the conclusion of the parade, it shall execute the parade commander's commands rather than the flag party commander's commands, except in the following circumstances:

- During an inspection, the flag shall remain in the carry position when the parade commander orders the corps AT—EASE.
- When required to move to a flank independently, the flag party shall do so under command of its flag party commander by executing forms at the halt or on the march.

### **MARCHING OFF THE FLAG(S)**

On the command, MARCH OFF THE—FLAG(S), members of the flag party shall perform the following:

1. the flag party commander shall order the cautionary FLAG PARTY;
2. the parade commander shall order TO THE FLAG(S)—SALUTE; and
3. the flag party commander shall order BY THE RIGHT (CENTRE), QUICK—MARCH.

The series of forms shall be conducted as follows:

1. On the command FLAG PARTY, QUICK—MARCH, the flag party shall move as a unit to a location on the parade square centred on the parade commander.
2. On the command FLAG PARTY, CHANGE DIRECTION LEFT (RIGHT), LEFT (RIGHT)—FORM, the flag party shall perform a left (right) form on the march. Upon completion of the form, the cadets shall mark time.
3. The flag party shall resume marching on the command FOR—WARD.
4. The flag party shall move to the left (right) flank and march off the parade square.

---

### **CONFIRMATION OF TEACHING POINT 6**

---

The cadets' participation in practicing marching on and off as members of a flag party will serve as the confirmation of this TP.

---

### **END OF LESSON CONFIRMATION**

---

Have the cadets execute flag drill on the march while judging the time.

Continue delivering commands as time allows, focusing on movements with which the cadets experience difficulty.



---

**CONCLUSION**

---

**HOMEWORK/READING/PRACTICE**

N/A.

**METHOD OF EVALUATION**

N/A.

**CLOSING STATEMENT**

Flag drill is the foundation for all other flag drill movements. Drill develops many qualities through self-discipline and practice. Drill that is well-rehearsed, closely supervised and precise is an exercise in obedience and alertness that creates teamwork.

**INSTRUCTOR NOTES/REMARKS**

It is recommended that this lesson be conducted in two separate sessions. Conduct TPs 1 to 4 in the first session and TPs 5 and 6 in the second session.

Corps wishing to deviate from the lesson structure for local/Regimental traditions may do so, but are limited to the six periods allocated.

---

**REFERENCES**

---

- A0-002 A-PD-201-000/PT-000 Director History and Heritage 3-2. (2005). *The Canadian Forces Manual of Drill and Ceremonial*. Ottawa, ON: Department of National Defence.
- A0-031 A-PD-202-001/FP-000 Director Ceremonial 2. (1993). *Canadian Forces Military Bands and Marches: Band Instructions*. Ottawa, ON: Department of National Defence.
- A0-099 A-AD-200-000/AG-000 Director History and Heritage. (1999). *The Honours, Flags and Heritage Structure of the Canadian Forces*. Ottawa, ON: Department of National Defence.
- A0-102 Director Cadets 5. (1999). CATO 12-05, *Cadet Flags and Banners*. Ottawa, ON: Department of National Defence.

THIS PAGE INTENTIONALLY LEFT BLANK



**COMMON TRAINING**  
**SILVER STAR**  
**INSTRUCTIONAL GUIDE**



**SECTION 4**  
**EO C308.02 – DELIVER WORDS OF COMMAND**

---

Total Time:

60 min

---



---

**PREPARATION**

---

**PRE-LESSON INSTRUCTIONS**

Resources needed for the delivery of this lesson are listed in the lesson specification located in A-CR-CCP-703/PG-001, Chapter 4. Specific uses for said resources are identified throughout the instructional guide within the TP for which they are required.

Review the lesson content and become familiar with the material prior to delivering the lesson.

Photocopy, cut out, fold and laminate the aide-mémoire cards with the words of command located at Annex B for each cadet.

**PRE-LESSON ASSIGNMENT**

N/A.

**APPROACH**

A practical activity was chosen for this lesson as it is an interactive way to allow the cadets to experience delivering words of command in a safe, controlled environment.

---

**INTRODUCTION**

---

**REVIEW**

The review associated with this lesson is from EO M308.02 (Deliver Words of Command, Section 2), to include:

**QUESTIONS**

- Q1. Why are cautionary commands given?
- Q2. What is the purpose of the executive command?
- Q3. If a command is not pronounced clearly and distinctly, what affect may it have on the squad being commanded?
- Q4. How does poor posture affect delivering commands?

## ANTICIPATED ANSWERS

- A1. To warn the squad that a movement will be performed.
- A2. To signal that the movement is to be carried out.
- A3. Cadets may not understand the command and perform the wrong movement.
- A4. It restricts the ability to breathe deeply, restricting the movement of the diaphragm, which will cause commands to come from the throat.

## OBJECTIVES

By the end of this lesson the cadet shall have delivered words of command.

## IMPORTANCE

It is important for cadets to know how to deliver words of command, as words of command that are delivered in a clear, concise manner, with confidence and determination, will affect how cadets respond to orders. Words of command are required to move a platoon in an organized and efficient manner.

---

### Teaching Point 1

### Demonstrate and Have the Cadets Practice Delivering Words of Command

Time: 50 min

Method: Practical Activity

---

---

## ACTIVITY

---

### OBJECTIVE

The objective of this activity is for each cadet to practice delivering words of command.

### RESOURCES

Aide-mémoire cards located at Annex B.

### ACTIVITY LAYOUT

N/A.

### ACTIVITY INSTRUCTIONS

1. Demonstrate delivering words of command.
2. Distribute the aide-mémoire cards to each cadet.
3. Divide the cadets into groups of no more than four cadets.
4. Have each cadet, within their group, practice delivering words of command with emphasis on voice, accuracy, confidence, correct posture and breathing control. Have the cadets practice commands at the halt and on the march with the other members of the group acting as the squad. Each cadet will be allotted approximately 10 minutes in front of their group.
5. Circulate among the groups and assist the cadets as necessary, offering suggestions and advice for improvement.

**SAFETY**

N/A.

---

**CONFIRMATION OF TEACHING POINT 1**

---

The cadets' participation in the activity will serve as the confirmation of this TP.

---

**END OF LESSON CONFIRMATION**

---

The cadets' participation in delivering words of command will serve as the confirmation of this lesson.

---

**CONCLUSION**

---

**HOMEWORK/READING/PRACTICE**

N/A.

**METHOD OF EVALUATION**

N/A.

**CLOSING STATEMENT**

When words of command are delivered in a clear and concise manner and with confidence and determination, it will affect how cadets respond to the order. Delivering words of command can allow a platoon to move as a team in an organized and efficient manner as all members learn to work together.

**INSTRUCTOR NOTES/REMARKS**

Cadets shall be provided the opportunity to deliver words of command and be given feedback during weekly opening and closing parades, and ceremonial parades.

This EO will be used as additional practice time for EO M308.02 (Deliver Words of Command, Section 2).

---

**REFERENCES**

---

N/A.

THIS PAGE INTENTIONALLY LEFT BLANK

## DRILL SEQUENCE HANDOUT (PREPARING A SQUAD FOR PARADE)

### Squad in Line

When a squad is formed in line, the team leader, assuming the role of the PI WO, shall be positioned three paces in front and centred on the squad.

### Steps to Preparing a Squad for Parade

The steps to preparing a squad for parade include:

1. The squad shall form up in three ranks at the edge of the parade square and stand at ease.
2. The team leader shall carry on with forming up a squad as detailed below.

Item	Command	Given By	Execution	Observation
a.		Team Leader	The Team Leader shall march to a position three paces in front of, and facing, the position the marker is to occupy.	The squad is formed up just off the parade square, standing easy. The right hand cadet of the front rank is the designated "Marker".
b.	MARKER	Team Leader	The Marker shall come to attention, answer by rank, observe the standard pause, march in a direct line to, and halt three paces in front of and facing, the Team Leader. The Marker shall remain at attention.	The platoon shall come to the position of stand at ease. The Team Leader, after placing the Marker, shall turn right and march to a position three paces in front of and centre facing where the squad shall fall in.
c.	Squad FALL—IN	Team Leader	The squad shall come to attention, observe the standard pause and march onto the parade ground. It shall halt on the left of and covering off the marker and remain at attention.	A direct route shall be taken by the squad.

3. The team leader shall carry on with calling the roll as detailed below.

Item	Command	Given By	Execution	Observation
a.	ANSWER TO YOUR NAME, STAND AT—EASE	Team Leader	Each squad member shall come to attention as their name is called, answer accordingly and stand at ease.	The team leader shall read each name from a roll and mark the attendance for each cadet.

4. The team leader shall carry on with sizing in a single rank and reforming threes (twos) as detailed below.

Item	Command	Given By	Execution	Observation
a.	TALLEST ON THE  RIGHT, SHORTEST ON THE LEFT, IN A SINGLE  RANK— SIZE	Team Leader	The squad shall turn right, observe the standard pause, then arrange themselves according to height, with tallest on the right and shortest on the left in one single rank, shoulder to shoulder dressing and covering off front to rear.	The team leader shall ensure the cadets are arranged as ordered before proceeding.
b.	SQUAD— NUMBER	Team Leader	The squad shall call out their number in sequence from the right.	The team leader shall ensure that no numbers are missed.
c.	ODD NUMBERS ONE PACE FORWARD, EVEN NUMBERS ONE PACE STEP BACK —MARCH	Team Leader	The squad shall act as ordered.	
d.	NUMBER ONE STAND FAST, ODD NUMBERS RIGHT, EVEN NUMBERS LEFT— TURN	Team Leader	The squad shall act as ordered.	
e.	REFORM THREES (TWOS), QUICK— MARCH	Team Leader	The squad reform ranks with Number 1 as the marker and remainder filling in the next open position.	When each person arrives in their new position, they shall halt, at arm's-length interval, observe the standard pause, turn left and remain at attention.

5. The team leader shall carry on with dressing a squad as detailed below.



Item	Command	Given By	Execution	Observation
a.	RIGHT— DRESS	Team Leader	The squad shall act as ordered.	
b.	EYES— FRONT	Team Leader	The squad shall act as ordered.	Squad members shall snap the head and eyes to the front, cut the right arm behind the cadet on the right and return to the position of attention.

6. The team leader shall carry on with inspecting a squad as detailed below.

Item	Command	Given By	Execution	Observation
a.	OPEN ORDER— MARCH	Team Leader	The squad shall act as ordered.	
b.	RIGHT— DRESS	Team Leader	The squad shall act as ordered.	
c.	EYES— FRONT	Team Leader	The squad shall act as ordered.	
d.		Team Leader	The team leader will inspect the front and rear of each cadet, starting at the right marker and proceeding around each rank in turn. The inspection of a cadet shall start at the head and work down to the feet.	The purpose of an inspection is to ensure a standard of personal hygiene and grooming, and that each cadet is properly dressed, with all clothing, badges, etc, are worn correctly, clean, and in good repair.
e.	CLOSE ORDER— MARCH	Team Leader	The squad shall act as ordered.	
f.	RIGHT— DRESS	Team Leader	The squad shall act as ordered.	
g.	EYES— FRONT	Team Leader	The squad shall act as ordered.	
h.	STAND AT— EASE	Team Leader	The squad shall act as ordered.	

7. As the platoon commander approaches, the team leader shall carry on with handing over a squad as detailed below.

<b>Item</b>	<b>Command</b>	<b>Given By</b>	<b>Execution</b>	<b>Observation</b>
a.	ATTEN— TION	Team Leader	The squad shall act as ordered.	The team leader calls the squad to attention as the platoon commander approaches.
b.		Team Leader		The platoon commander halts two paces in front of the team leader, who reports the squads strength and condition.
c.		Team Leader		Upon being ordered to fall in, the team leader turns right, by a series of wheels proceeds around the right flank and takes their position behind the squad.
d.		Platoon Commander		The platoon commander marches forward two paces to take up their position.

### AIDE-MÉMOIRE CARD



<b>PREPARING A SQUAD FOR PARADE</b>	
<b>FALLING IN:</b> <ul style="list-style-type: none"><li>• MARKER.</li><li>• SQUAD FALL—IN.</li></ul>	<b>DRESSING:</b> <ul style="list-style-type: none"><li>• RIGHT—DRESS.</li><li>• EYES—FRONT.</li></ul>
<b>CALLING THE ROLL:</b> <ul style="list-style-type: none"><li>• ANSWER TO YOUR NAME, STAND AT—EASE.</li></ul>	<b>PRE-INSPECTING:</b> <ul style="list-style-type: none"><li>• OPEN ORDER—MARCH.</li><li>• RIGHT—DRESS.</li><li>• EYES—FRONT.</li></ul>
<b>SIZING IN A SINGLE RANK:</b> <ul style="list-style-type: none"><li>• TALLEST ON THE RIGHT, SHORTEST ON THE LEFT, IN A SINGLE RANK—SIZE.</li><li>• SQUAD—NUMBER.</li><li>• ODD NUMBERS ONE PACE FORWARD, EVEN NUMBERS ONE PACE STEP BACK—MARCH.</li><li>• NUMBER ONE STAND FAST, ODD NUMBERS RIGHT, EVEN NUMBERS LEFT—TURN.</li><li>• REFORM THREES (TWOS), QUICK—MARCH.</li></ul>	<b>POST-INSPECTING:</b> <ul style="list-style-type: none"><li>• CLOSE ORDER—MARCH.</li><li>• RIGHT—DRESS.</li><li>• EYES—FRONT.</li><li>• STAND AT—EASE.</li></ul>
	<b>HANDING OVER:</b> <ul style="list-style-type: none"><li>• ATTEN—TION.</li></ul>



<b>PREPARING A SQUAD FOR PARADE</b>	
<b>FALLING IN:</b> <ul style="list-style-type: none"><li>• MARKER.</li><li>• SQUAD FALL—IN.</li></ul>	<b>DRESSING:</b> <ul style="list-style-type: none"><li>• RIGHT—DRESS.</li><li>• EYES—FRONT.</li></ul>
<b>CALLING THE ROLL:</b> <ul style="list-style-type: none"><li>• ANSWER TO YOUR NAME, STAND AT—EASE.</li></ul>	<b>PRE-INSPECTING:</b> <ul style="list-style-type: none"><li>• OPEN ORDER—MARCH.</li><li>• RIGHT—DRESS.</li><li>• EYES—FRONT.</li></ul>
<b>SIZING IN A SINGLE RANK:</b> <ul style="list-style-type: none"><li>• TALLEST ON THE RIGHT, SHORTEST ON THE LEFT, IN A SINGLE RANK—SIZE.</li><li>• SQUAD—NUMBER.</li><li>• ODD NUMBERS ONE PACE FORWARD, EVEN NUMBERS ONE PACE STEP BACK—MARCH.</li><li>• NUMBER ONE STAND FAST, ODD NUMBERS RIGHT, EVEN NUMBERS LEFT—TURN.</li><li>• REFORM THREES (TWOS), QUICK—MARCH.</li></ul>	<b>POST-INSPECTING:</b> <ul style="list-style-type: none"><li>• CLOSE ORDER—MARCH.</li><li>• RIGHT—DRESS.</li><li>• EYES—FRONT.</li><li>• STAND AT—EASE.</li></ul>
	<b>HANDING OVER:</b> <ul style="list-style-type: none"><li>• ATTEN—TION.</li></ul>

THIS PAGE INTENTIONALLY LEFT BLANK

**CHAPTER 9**  
**PO 309 – INSTRUCT A LESSON**





**COMMON TRAINING**  
**SILVER STAR**  
**INSTRUCTIONAL GUIDE**



**SECTION 1**

**EO M309.01 – EXPLAIN THE PRINCIPLES OF INSTRUCTION**

Total Time:

60 min

---

**PREPARATION**

---

**PRE-LESSON INSTRUCTIONS**

Resources needed for the delivery of this lesson are listed in the lesson specification located in A-CR-CCP-703/PG-001, Chapter 4. Specific uses for said resources are identified throughout the instructional guide within the TP for which they are required.

Review the lesson content and become familiar with the material prior to delivering the lesson.

The activity in TP 2 uses learning stations. Learning stations are a form of group work where the cadets learn by sorting through the information presented. When setting up learning stations, ensure there is enough room for each cadet to be comfortable and have adequate space for writing down information. When the cadets arrive at a learning station, all required information shall be available. These stations should be placed close together to minimize time for movement; however far enough apart to avoid interruptions from other groups. For this lesson, choose and set up six learning stations for the principles of instruction.

Photocopy the Principles of Instruction Information Sheets located at Annex A and the Principles of Instruction Worksheets located at Annex B for each station.

**PRE-LESSON ASSIGNMENT**

N/A.

**APPROACH**

An interactive lecture was chosen for TP 1 to present the principles of instruction and to generate interest.

An in-class activity was chosen for TP 2 as it is an interactive way for the cadets to apply the principles of instruction.

---

**INTRODUCTION**

---

**REVIEW**

N/A.

## OBJECTIVES

By the end of this lesson the cadet shall have explained the principles of instruction and how they are applied when planning and instructing a lesson.

## IMPORTANCE

It is important for the cadets to explain the principles of instruction and how they are applied when planning and instructing a lesson to make training enjoyable and successful and to help the instructor make informed decisions while in front of a class. The ability to keep a class interested, motivated and eager to learn are invaluable skills that will provide a positive learning experience for the cadets.

---

### Teaching Point 1

### Describe the Principles of Instruction

Time: 10 min

Method: Interactive Lecture

---

## THE PRINCIPLES OF INSTRUCTION



**Principle.** A fundamental truth or law as the basis of reasoning or action.

In order to create an environment that promotes participation and learning, an instructor follows a set of guidelines or principles to plan and instruct a lesson. The following are the fundamental guidelines known as the principles of instruction:

- **Interest.** Cadets are more receptive to learning when they are curious and have an emotional connection to a topic. The instructor must arouse, create and maintain the interest of the cadets. Without interest, the cadets will be less inclined to listen and will not learn.
- **Comprehension.** Comprehension or understanding relates to the cadet's ability to understand the material taught. The cadets' readiness to learn new material is influenced by what has previously been taught; new content should not exceed the knowledge level of the cadets. If the cadets do not understand, they are unable to learn.
- **Emphasis.** During a period of instruction, there will be some information that may be of particular importance. The instructor can emphasize this important information through the use of voice control, training aids and in-class activities.
- **Participation.** Cadets are more likely to retain information if they are both mentally and physically involved in learning. The instructor should conduct activities that contain action, activity and excitement. Cadets learn by doing.
- **Accomplishment.** The lesson must impart a sense of accomplishment to each cadet. The cadets should leave the class with the satisfaction that they were able to accomplish something in the lesson.
- **Confirmation.** Confirmation is an essential part of learning and instructing. It gives both the instructor and the cadet the opportunity to see how well the information is understood.



The acronym ICEPAC is useful for remembering the principles of instruction.



---

## CONFIRMATION OF TEACHING POINT 1

---

**QUESTIONS**

- Q1. List the principles of instruction.
- Q2. What will occur if a lesson lacks interest?
- Q3. What is the acronym that can be used to remember the principles of instruction?

**ANTICIPATED ANSWERS**

A1. The principles of instruction are:

- interest,
- comprehension,
- emphasis,
- participation,
- accomplishment, and
- confirmation.

A2. Without interest the cadets will be less inclined to listen and will not learn.

A3. The acronym that can be used to remember the principles of instruction is ICEPAC.

---

**Teaching Point 2**
**Conduct an Activity Where the Cadets Will Apply the Principles of Instruction**

Time: 40 min

Method: In-Class Activity

---



---

### ACTIVITY

---

**OBJECTIVE**

The objective of this activity is to have the cadets practice the application of the principles of instruction.

**RESOURCES**

- Principles of instruction information sheets,
- Principles of instruction worksheets, and
- Pens/pencils.

**ACTIVITY LAYOUT**

Set up six learning stations, to include:

- principles of instruction information sheets,
- principles of instruction worksheets, and
- pens/pencils.

## ACTIVITY INSTRUCTIONS

1. Divide the cadets into six groups and place each group at one of the principles of instruction learning stations.
2. Assign each group a leader. Have the group leader assign a recorder and a reader.
3. Using the principle and topic at the top of the page, have the groups fill out the principle of instruction worksheet (it is necessary for each group to fill out only one worksheet).
4. After five minutes, have the groups rotate clockwise to the next station. Have the cadets complete the next principle of instruction worksheet.



Have the groups bring their worksheets with them as they rotate through the stations.



It is important to circulate around the room to facilitate the activities and help the cadets as required. If possible, assign other instructors to aid with supervision and facilitation.

5. Rotate the groups through the remaining stations.
6. Have the cadets share the information they recorded with the rest of the cadets. In most cases the groups will have recorded the same information for each station. If a group has listed different information it will be shared after the presentation is finished.

## SAFETY

N/A.

---

### CONFIRMATION OF TEACHING POINT 2

---

The cadets' participation in the activity will serve as the confirmation of this TP.

---

### END OF LESSON CONFIRMATION

---

The cadets' participation in the principles of instruction learning stations will serve as the confirmation of this lesson.

---

### CONCLUSION

---

## HOMEWORK/READING/PRACTICE

N/A.

## METHOD OF EVALUATION

N/A.

**CLOSING STATEMENT**

Describing the principles of instruction and knowing how to apply them when planning and instructing a lesson assists in making training enjoyable and successful and helps the instructor make informed decisions while in front of a class. The ability to keep a class interested, motivated and eager to learn are invaluable skills that will provide a positive learning experience.

**INSTRUCTOR NOTES/REMARKS**

The learning stations must be set up prior to beginning this lesson.

The cadets will be divided into six groups and will rotate through the stations during the in-class activity in TP 2.

---

**REFERENCES**

---

A0-055 A-P9-050-000/PT-006 Canadian Forces Individual Training and Education System. (1997). *Conduct of Instructional Programmes* (Vol. 6). Ottawa, ON: Department of National Defence.

THIS PAGE INTENTIONALLY LEFT BLANK



**COMMON TRAINING  
SILVER STAR  
INSTRUCTIONAL GUIDE**



**SECTION 2**

**EO M309.02 – IDENTIFY METHODS OF INSTRUCTION**

Total Time:

60 min

**PREPARATION**

**PRE-LESSON INSTRUCTIONS**

Resources needed for the delivery of this lesson are listed in the lesson specification located in A-CR-CCP-703/PG-001, Chapter 4. Specific uses for said resources are identified throughout the instructional guide within the TP for which they are required.

Review the lesson content and become familiar with the material prior to delivering the lesson.

Photocopy Annexes C and D for each cadet.

**PRE-LESSON ASSIGNMENT**

N/A.

**APPROACH**

An interactive lecture was chosen for TP 1 to describe types of lessons as it allows the instructor to deliver new information while encouraging the cadets to actively participate by asking and responding to questions.

An in-class activity was chosen for TPs 2 and 3 as it is an interactive way to reinforce the topic and confirm the cadets' comprehension of types of lessons and methods of instruction.

**INTRODUCTION**

**REVIEW**

N/A

**OBJECTIVES**

By the end of this lesson the cadet shall have identified a method of instruction appropriate for a specific type of lesson and given topic.

**IMPORTANCE**

It is important for cadets to know that there are many methods of instruction that can be used for knowledge and skill lessons. Varying the method of instruction is one way for instructors to create interest and encourage learning.

---

**Teaching Point 1****Describe Types of Lessons**

Time: 5 min

Method: Interactive Lecture

---

**TYPES OF LESSONS**

Knowledge and skill are the two types of lessons.



The main differences between a knowledge lesson and a skill lesson are how the cadets participate during the lesson and how the instructor confirms learning at the end of a teaching point or lesson.

In a knowledge lesson, the cadets participate by asking and responding to questions and discussing lesson content. The instructor confirms learning by posing questions to the class or conducting an activity.

In a skill lesson, the cadets participate by practicing and performing a skill while the instructor observes the cadets' performance to confirm learning.

**Knowledge Lesson**

A knowledge lesson gives the cadets the theoretical aspects of a subject. The instructor presents basic information about a topic, typically following the who, what, where, when and why (5 Ws) format. Delivering an effective knowledge lesson requires the instructor to:

1. select an instructional method;
2. research the lesson information thoroughly;
3. summarize the information;
4. prepare questions to encourage class participation;
5. prepare questions for confirmation; and
6. prepare training aids.



All lessons require the instructor to create and maintain interest. It is especially important that instructors ensure that knowledge lessons are interesting because they are not hands-on.

**Skill Lesson**

A skill lesson demonstrates the skill to be learned in a step-by-step sequence. Conducting an effective demonstration requires the instructor to:

1. plan carefully;
2. breakdown the skill to be taught into sequential steps;
3. rehearse the sequence to ensure that it is accurate and clear;
4. prepare a written lesson plan;
5. prepare and/or obtain all material needed to demonstrate and practice the skill in advance;
6. organize the class so the demonstration can be seen;

7. allow the cadets to practice the steps under supervision;
8. provide assistance or re-demonstrate as necessary; and
9. allow the cadets to continue to practice under supervision until all have achieved the skill.



Mastery of a particular skill may require practice beyond class time depending upon the learners and difficulty of the skill.



Learning is a combination of knowledge, attitudes and skills that promote the development of a cadet.

---

### CONFIRMATION OF TEACHING POINT 1

---

#### QUESTIONS

- Q1. What are the main differences between knowledge and skill lessons?
- Q2. How do instructors confirm learning in a skill lesson?
- Q3. Why is it more difficult to create and maintain interest in a knowledge lesson?

#### ANTICIPATED ANSWERS

- A1. Knowledge and skill lessons differ mainly in how cadets participate during the lesson and how instructors confirm learning at the end of a teaching point or lesson.
- A2. Instructors confirm learning in a skill lesson by observing the cadets perform the skill.
- A3. It is more difficult to create and maintain interest in a knowledge lesson because it is not hands-on.

---

#### Teaching Point 2

#### Conduct an Activity Where the Cadets Will Describe Methods of Instruction

Time: 25 min

Method: In-Class Activity

---

### BACKGROUND KNOWLEDGE

---

#### INSTRUCTIONAL METHODS

Instructors should be familiar with and able to use a variety of methods of instruction. Some of the more widely used instructional methods are described and located at Annex C.

---

### ACTIVITY

---

#### OBJECTIVE

The objective of this activity is to have the cadets describe methods of instruction.

## RESOURCES

- Methods of instruction information sheets,
- Flip chart paper,
- Coloured markers, and
- Pens/pencils.

## ACTIVITY LAYOUT

Set up four work stations and label them “description”, “pre-lesson preparation”, “typical applications” and “lesson development”. At each station have:

- three sheets of flip chart paper, and
- coloured markers.

## ACTIVITY INSTRUCTIONS

1. Divide the cadets into four groups and place each group at one of the labelled work stations.
2. Give the cadets a copy of Annex C.
3. Assign each group a leader. The group leader will be responsible for assigning a recorder and reader.
4. Have each group research their information (description, pre-lesson preparation, typical applications, or lesson development) from Annex C for each method of instruction and record the key points on the flip chart paper. (10 minutes)
5. Have the groups share their information with the class. (10 minutes)

## SAFETY

N/A.

---

### CONFIRMATION OF TEACHING POINT 2

---

The cadets' participation in the activity will serve as the confirmation of this TP.

---

### Teaching Point 3

### Conduct an Activity Where the Cadets Will Select an Appropriate Method of Instruction for a Given Topic

Time: 20 min

Method: In-Class Activity

---



The instructional method is determined by the:

- lesson material,
- environment in which the training will take place,
- resources available to the instructor,
- time available to the instructor, and
- needs of the cadets.



---

## ACTIVITY

---

**OBJECTIVE**

The objective of this activity is to have the cadets consider criteria and select an appropriate method of instruction for each topic.

**RESOURCES**

List of lesson topics located at Annex D.

**ACTIVITY LAYOUT**

N/A.

**ACTIVITY INSTRUCTIONS**

1. Give the cadets a copy of Annex D.
2. Introduce the objective of the activity and have the cadets work individually for 10 minutes matching the lesson topics to the instructional methods described in TP 2.
3. Stress that some topics can be taught using more than one method of instruction but they are to chose the one they consider to be the most appropriate.
4. Have the cadets share their work with the class by identifying and explaining their choice of instructional method for a topic.

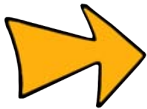

No single instructional method is best for all objectives. Providing instruction using a variety of methods can often enhance learning.

**SAFETY**

N/A.

---

### CONFIRMATION OF TEACHING POINT 3

---

The cadets' participation in the activity will serve as the confirmation of this TP.

---

### END OF LESSON CONFIRMATION

---

**QUESTIONS**

- Q1. What is one application of the interactive lecture?
- Q2. How does the instructor confirm learning when using the demonstration and performance instructional method?
- Q3. What instructional method is being used when the cadets participate in "real life" operations that illustrate what was discussed or learned in the classroom?
- Q4. Give two examples of in-class activities?
- Q5. Games create variety and arouse interest. It is critical they do what?

Q6. Which instructional method is being used when cadets produce a product, carry out an application or demonstrate a process?

**ANTICIPATED ANSWERS**

- A1. Interactive lectures can be used to review previously taught material, present background information, introduce a new subject, give instructions on procedures, illustrate the application of rules, principles or concepts and introduce a demonstration, discussion or performance.
- A2. During a demonstration and performance, the instructor confirms learning by observing the cadet perform the operation, skill or movement.
- A3. Field trip.
- A4. In-class activities include learning stations, videos, brainstorming, debating and group work.
- A5. It is critical that games support learning.
- A6. Practical activity.

---

**CONCLUSION**

---

**HOMEWORK/READING/PRACTICE**

N/A.

**METHOD OF EVALUATION**

This EO is assessed IAW A-CR-CCP-703/PG-001, Chapter 3, Annex B, Appendix 3 (309 PC).

**CLOSING STATEMENT**

Being able to select a method of instruction appropriate for a given lesson is an important skill for an instructor. Cadets will be more likely to pay attention, participate in classroom activities, answer questions and generally have a positive learning experience if instructors select an appropriate instructional method and plan the learning activities.

**INSTRUCTOR NOTES/REMARKS**

N/A.

---

**REFERENCES**

---

- A0-055 A-P9-050-000/PT-006 Director Training and Education Policy. (2002). *Canadian Forces Individual Training and Education System* (Vol. 6). Ottawa, ON: Department of National Defence.
- A0-056 A-P9-050-000/PT-005 Director Training and Education Policy. (2001). *Canadian Forces Individual Training and Education System* (Vol. 5). Ottawa, ON: Department of National Defence.



**COMMON TRAINING  
SILVER STAR  
INSTRUCTIONAL GUIDE**



**SECTION 3**

**EO M309.03 – DESCRIBE EFFECTIVE-SPEAKING TECHNIQUES**

Total Time:

30 min

---

**PREPARATION**

---

**PRE-LESSON INSTRUCTIONS**

Resources needed for the delivery of this lesson are listed in the lesson specification located in A-CR-CCP-703/PG-001, Chapter 4. Specific uses for said resources are identified throughout the instructional guide within the TP for which they are required.

Review the lesson content and become familiar with the material prior to delivering the lesson.

**PRE-LESSON ASSIGNMENT**

N/A.

**APPROACH**

An interactive lecture was chosen for TPs 1 and 3 to present basic material and to orient the cadets to aspects of voice control and how to prepare for effective-speaking.

A group discussion was chosen for TP 2 as it allows the cadets to interact with their peers and share their knowledge, experiences, opinions and feelings about physical presence while speaking in front of a group.

---

**INTRODUCTION**

---

**REVIEW**

N/A.

**OBJECTIVES**

By the end of this lesson the cadet shall have described elements of voice control, elements of physical presence and effective-speaking preparation.

**IMPORTANCE**

It is important for the cadets to describe elements of voice control and physical presence to be a confident instructor. The ability to effectively prepare for a presentation and control nervousness are invaluable skills that help to provide a positive learning experience for both the instructor and the trainee.

**Teaching Point 1****Explain Elements of Voice Control**

Time: 10 min

Method: Interactive Lecture



The cadets may have been exposed to people from other communities, provinces and even countries with accents different from their own. Brainstorm with the cadets how elements of voice control can affect how the message is received and write down the responses. After the brainstorming is complete, compare the class list to the list below.

**ELEMENTS OF VOICE CONTROL**

One of the most important and effective tools of communication is voice control. The ability to use voice control to communicate effectively and place emphasis on important information is a fundamental skill that will be used while in front of an audience.

**Pitch.** How high or low a voice is. A change in pitch usually does not add any significance to a message. However, a pitch change will be noticed by the audience and will keep people involved.

**Tone.** The quality of the sound of a voice. Effective communicators will often change the tone of their voice to give emphasis to a single word or phrase to convey emotion and conviction.



**Monotone.** A sound without change of pitch or tone.

**Volume.** The quantity or power of sound or fullness of tone. A change in volume often signifies emphasis on a particular phrase or point. Environmental factors such as outside noise and room size must be taken into consideration to ensure the audience can hear the message being sent.

**Speed.** The rate or rapidity in which words are spoken. Speaking too fast or too slow can be distracting to an audience. It is important to communicate at a pace that ensures the audience can understand every word being said.

**Pause.** A break in speaking or reading. A pause is an important part of the communication process. A pause gives the audience an opportunity to digest what has been said and to ask questions. A pause is also an effective way to announce a change in subject or an important point.

**Articulation.** The clear and distinct pronunciation of a word. It is important to properly pronounce and articulate words to ensure the audience can understand the message being sent.

**CONFIRMATION OF TEACHING POINT 1****QUESTIONS**

- Q1. Name the six elements of voice control.
- Q2. What can a change in volume signify when sending a message?
- Q3. What is the purpose of pausing while speaking?

**ANTICIPATED ANSWERS**

- A1. The six elements of voice control are:

- pitch,
- tone,
- volume,
- speed,
- pause, and
- articulation.

A2. A change in volume can signify emphasis on a particular phrase or point.

A3. A pause gives the audience an opportunity to digest what has been said and to ask questions. A pause is also an effective way to announce a change in subject or an important point.

---

### Teaching Point 2

### Discuss Elements of Physical Presence

Time: 10 min

Method: Group Discussion

---

## BACKGROUND KNOWLEDGE

---



The purpose of the group discussion is to draw the following information from the group using the tips for answering/facilitating discussion and the suggested questions provided.

### ELEMENTS OF PHYSICAL PRESENCE

It is estimated that 93 percent of the total meaning of a message comes from non-verbal communication and only 7 percent of meaning comes from the words themselves. Being aware of physical presence and its effect on a message being sent is an important element of effective communication.

#### Body Language

Body language or non-verbal communication is the process of communicating through conscious and unconscious gestures and expressions. Understanding that body language affects how a message is received and interpreted is an important tool for communicating effectively.

**Facial Expressions.** While 93 percent of the total meaning of a message comes from non-verbal communication, most of that meaning is communicated by the eyes, eyebrows and mouth. The movement of the eyes, eyebrows and mouth can result in an infinite variety of expressions to complement the spoken word. It is important that facial expressions match the tone of the message being sent to create emphasis and believability. A smile is the most important of all facial expressions. A smile adds sincerity to a message and will add to the likeability of the individual in front of the audience.

**Eye Contact.** Maintaining eye contact is an effective way of engaging an audience and building interest. Pausing two or three seconds on each member of the audience will make them feel as though they are involved in a one-on-one conversation. It is important to look at the entire room and scan from left to right, back to front.

**Gestures.** The combination of hand, arm and shoulder movements can make a wide variety of gestures that can help add meaning to a message. Effective communicators will let their hands and arms move naturally to help give emphasis and emotion to a message. It is important not to point directly at members of the audience or let gestures become distracting.

**Movement.** Being aware of movement while in front of an audience is very important to communication. Movement will keep listeners engaged and interested in what is being said. Moving around the front of the room, toward and away from an audience and from side to side can help emphasize points. Too much or frantic movement can become distracting and will affect how a message is received.



Hands placed in pockets are typically a sign of nervousness or overconfidence.

### **Dress and Deportment**

Effective communicators are aware of their dress and deportment. Audiences will react differently to an individual who is well dressed and acts professionally, than an individual who is poorly dressed and acts unprofessionally.

**Dress.** Effective communicators will always appear in clean, well-pressed and appropriate attire. Dressing appropriately for the event will help create confidence and credibility.

**Deportment.** An audience that sees an individual as being prepared, on time, appropriately dressed and confident will be much more receptive, than to an individual who is unprepared, late, poorly dressed and nervous. The most important element of deportment is displaying an interest in the subject; this will be noticed by the audience and will generate interest in the presentation.

---

## **GROUP DISCUSSION**

---



### **TIPS FOR ANSWERING/FACILITATING DISCUSSION**

- Establish ground rules for discussion, eg, everyone should listen respectfully; don't interrupt; only one person speaks at a time; no one's ideas should be made fun of; you can disagree with ideas but not with the person; try to understand others as much as you hope they understand you; etc.
- Sit the group in a circle, making sure all cadets can be seen by everyone else.
- Ask questions that will provoke thought; in other words avoid questions with yes or no answers.
- Manage time by ensuring the cadets stay on topic.
- Listen and respond in a way that indicates you have heard and understood the cadet. This can be done by paraphrasing their ideas.
- Give the cadets time to respond to your questions.
- Ensure every cadet has an opportunity to participate. One option is to go around the group and have each cadet answer the question with a short answer. Cadets must also have the option to pass if they wish.
- Additional questions should be prepared ahead of time.

### **SUGGESTED QUESTIONS**

Q1. How could you use facial expressions to emphasize something that is funny?

Q2. As an effective-speaker how could you make the audience feel like they are part of the presentation?

Q3. How would you expect an instructor to present themselves in terms of dress and deportment?

Q4. What is one of the most important elements of deportment?



Other questions and answers will develop throughout the group discussion. The group discussion should not be limited to only those suggested.



Reinforce the answers given and comments made during the group discussion, ensuring the teaching point has been covered.

---

### CONFIRMATION OF TEACHING POINT 2

---

The cadets' participation in the group discussion will serve as the confirmation of this TP.

#### Teaching Point 3

#### Explain Effective-Speaking Preparation

Time: 5 min

Method: Interactive Lecture

Effective-speaking preparation is the most critical component of effective communication. Preparation will help to ensure confidence, control nervousness and increase the likelihood of success when in front of an audience.

The following are the steps to effective-speaking preparation:

1. **Practicing.** Proper rehearsal will aid in memorizing content, which will allow for more eye contact and movement while in front of an audience. Memorizing the introduction and conclusion are the two most critical elements; a strong introduction will aid in gaining confidence and will draw the interest of the audience, a strong conclusion will aid in leaving a lasting impression on the audience. If possible, practice in front of a small group, speak aloud even when practicing alone and always practice while standing.
2. **Controlling Nervousness.** The feeling of nervousness prior to speaking in front of a group is normal and often can help if channeled effectively. The following actions can be taken to control nervousness:
  - (a) **Room Layout.** Become familiar with the layout of the room prior to speaking.
  - (b) **Materials.** Ensure notes, handouts and presentation aids are organized.
  - (c) **Equipment.** Ensure any equipment being used is in working order and ready to use.
  - (d) **Practice.** Spend time going over notes and rehearsing content.
  - (e) **Attitude.** Enter the room with a smile and a positive and confident attitude.
  - (f) **Breathing.** Take a deep breath before entering the room. Slow down the delivery if necessary and breathe from the diaphragm while speaking, not from the chest.
3. **Identifying a Friendly Face.** While walking in front of an audience, identify a friendly face. Making eye contact with a friendly face while beginning to speak will often give confidence while beginning the introduction and ultimately lead to success when addressing an audience.

---

**CONFIRMATION OF TEACHING POINT 3**

---

**QUESTIONS**

- Q1. What are the three steps to effective-speaking preparation?
- Q2. What actions can be taken to control nervousness?
- Q3. What is the benefit of identifying a friendly face?

**ANTICIPATED ANSWERS**

- A1. The three steps to effective-speaking preparation are:
- (1) practice,
  - (2) control nervousness, and
  - (3) identify a friendly face.
- A2. The actions that can be taken to control nervousness are:
- become familiar with the layout of the room prior to speaking,
  - ensure notes, handouts and presentation aids are well organized,
  - ensure any equipment being used is in working order and ready to use,
  - spend time going over notes and rehearse content,
  - enter the room with a smile and a positive and confident attitude, and
  - take a deep breath before entering the room.
- A3. Making eye contact with a friendly face while beginning to speak will often give confidence while beginning the introduction and ultimately lead to success when addressing an audience.

---

**END OF LESSON CONFIRMATION**

---

**QUESTIONS**

- Q1. What is meant by tone?
- Q2. What are the two elements of physical presence?
- Q3. What are the four aspects of body language?

**ANTICIPATED ANSWERS**

- A1. The quality of the sound of a voice.
- A2. The two elements of physical presence are:
- body language, and
  - dress and deportment.
- A3. The four aspects of body language are:
- facial expressions,



- eye contact,
- gestures, and
- movement.

---

**CONCLUSION**

---

**HOMEWORK/READING/PRACTICE**

N/A.

**METHOD OF EVALUATION**

N/A.

**CLOSING STATEMENT**

Knowing how to apply elements of voice control and physical presence will make instructing enjoyable and successful by helping develop presence while in front of an audience. The ability to effectively prepare for a presentation and control nervousness are invaluable skills that may help to develop a more confident instructor.

**INSTRUCTOR NOTES/REMARKS**

N/A.

---

**REFERENCES**

---

C0-192 (ISBN 0-9695066-2-7) Bender, P. (2000). *Secrets of Power Presentations*. Toronto, ON: The Achievement Group.

THIS PAGE INTENTIONALLY LEFT BLANK



**COMMON TRAINING**  
**SILVER STAR**  
**INSTRUCTIONAL GUIDE**



**SECTION 4**

**EO M309.04 – DESCRIBE QUESTIONING TECHNIQUES**

Total Time:

30 min

---

**PREPARATION**

---

**PRE-LESSON INSTRUCTIONS**

Resources needed for the delivery of this lesson are listed in the lesson specification located in A-CR-CCP-703/PG-001, Chapter 4. Specific uses for said resources are identified throughout the instructional guide within the TP for which they are required.

Review the lesson content and become familiar with the material prior to delivering the lesson.

Arrange for officers or senior cadets to assist in conducting the activity and recording data regarding the cadets' performance.

Review the activity instructions with the officers and senior cadets assisting with the activity.

Photocopy Annexes E, F, G and H for the officers and senior cadets assisting with the activity.

Photocopy Annex E for each cadet.

Assign spaces in the training area for workstations to conduct the activity if more than one group is used.

Make photocopies of Annex F for each station if necessary.

**PRE-LESSON ASSIGNMENT**

N/A.

**APPROACH**

An interactive lecture was chosen for TPs 1–3 as it allows the instructor to describe the purposes, qualities and types of questions while encouraging the cadets to actively participate by asking and responding to questions.

An in-class activity was chosen for TP 4 as it is an interactive way to reinforce the topic and confirm the cadets' comprehension of questioning techniques.

---

**INTRODUCTION**

---

**REVIEW**

N/A.

## OBJECTIVES

By the end of this lesson the cadet shall have described questioning techniques by listing the purposes of questioning, listing the qualities of a good question, defining types of questions and by listing the steps to posing questions while instructing.

## IMPORTANCE

Asking questions throughout a lesson helps the instructor to determine the cadets' level of comprehension of previously taught material, to create interest in the lesson and to confirm the cadets' comprehension of new material. Proper questioning techniques will help instructors ask questions properly to accomplish these goals and to develop confidence in their instructional abilities.

---

### Teaching Point 1

### Describe the Purposes of Questioning

Time: 5 min

Method: Interactive Lecture

---

## PURPOSES OF QUESTIONING

Questions that are carefully developed and incorporated into a lesson plan may improve learning. In fact, instructors' use of questions has such an impact on learning that it can be considered an indicator of their overall effectiveness. Instructors may improve their questioning technique by carefully planning what questions to ask, when and how to ask them so as to improve their instructional ability.

Questions can be posed throughout a lesson to:

- determine the cadets' level of comprehension of previously taught related material;
- create and maintain interest by keeping the cadets mentally alert and making them feel more involved in the lesson;
- guide and provoke thinking by carefully selecting questions and following answers with other questions as the lesson progresses; and
- confirm learning, especially for knowledge lessons, by asking questions at the end of each TP and at the end of the lesson.

---

### CONFIRMATION OF TEACHING POINT 1

---

## QUESTIONS

- Q1. Why is questioning such an important aspect of instruction?
- Q2. How can instructors improve their questioning technique?
- Q3. What are four purposes of questioning?

## ANTICIPATED ANSWERS

- A1. Questioning has a big impact on learning and is considered an indicator of an instructor's effectiveness.
- A2. By planning what questions to ask and when and how to ask them.
- A3. To determine comprehension of previously learned material, create and maintain interest, guide and provoke thinking, and to confirm learning.

**Teaching Point 2****Describe the Qualities of a Good Question**

Time: 5 min

Method: Interactive Lecture

**QUALITIES OF A GOOD QUESTION**

Questions used during a lesson should be written out ahead of time. Instructors who consistently pay attention to writing good quality questions will improve their instruction and learn to instinctively phrase good questions when the situation demands it during a lesson.

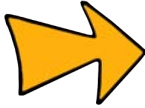

Often the cadets who are being instructed ask questions for clarification. Effective instructors create a classroom atmosphere that encourages cadets to ask questions, which are relevant to the lesson.

The exact wording of a question is determined by its purpose and the situation in which it is asked. While the wording may vary, all questions should be:

- brief, complete and easily understood;
- stated clearly using simple language;
- a challenge to cadets to apply their knowledge;
- not so difficult that only a few cadets can answer; and
- relevant to the lesson by reinforcing and supporting the teaching points.

**CONFIRMATION OF TEACHING POINT 2****QUESTIONS**

- Q1. Why should questions be written out ahead of time?
- Q2. How can instructors learn to ask better quality questions while instructing?
- Q3. What are five qualities of good questions?

**ANTICIPATED ANSWERS**

- A1. Questions written out ahead of time are of better quality and will improve instruction.
- A2. By crafting good quality questions, the question-making process will become instinctive.
- A3. Brief and complete, clearly stated, challenging, not too difficult, and relevant.

**Teaching Point 3****Describe Types of Questions**

Time: 5 min

Method: Interactive Lecture



All questions may be categorized as either participatory or evaluative. Participatory questions are used during a lesson to create and maintain interest, to keep cadets mentally alert and to guide thought. Evaluative questions are used at the beginning of a lesson to

determine retention of previously taught material or at the end of a TP or lesson to confirm comprehension of new material.

There are many types of questions but those most commonly recognized include:

**Lead-Off.** Questions, which are used to begin a lecture or start a discussion. This type of question does not necessarily require a verbal or written response and is designed to get the cadets thinking about the topic of the lesson or the issue being discussed.

Example: “What does being a good cadet mean to you?”

**Follow-Up.** Questions that are used to further stimulate the cadets’ thinking about the topic of the lesson or point of discussion. As the name suggests they are supplementary questions related to the initial lead-off question or are questions, which are phrased on the spot to probe an answer to a previous question or extend a point of discussion.

Example: “Identify an item, just mentioned in question one, that can be considered both a good and bad cadet quality.”

**Overhead.** Questions that are asked to the whole group without indicating who is to reply. There will be several answers to this type of question and everyone should be given a chance to respond.

Example: “Identify one factor that can determine if a cadet quality is good or bad”

**Direct.** Questions that are the opposite of overhead questions because someone is directed to answer. These questions can be used to draw in those who are reluctant to take part in discussions, to prompt cadets who are inattentive or to get a discussion back on track.

Example: “Cadet I.M. Reluctant, can you think of another factor which determines if a cadet quality is good or bad?”

**Reverse or Relay.** Questions are used to keep the discussion in the hands of the cadets. Instead of answering a question posed by a cadet the instructor can reverse the question and return it to the person who asked it or relay it to another member of the class.

Example: “Cadet C. Legs, can you answer Cadet I.M. Reluctant’s question?”

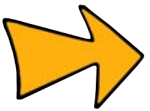

Never use reverse or relay as an escape mechanism for questions you cannot answer. Always admit that you don’t know the answer and follow up later rather than use reverse and relay.

---

### CONFIRMATION OF TEACHING POINT 3

---

#### QUESTIONS

- Q1. Which type of question does not necessarily require a response?
- Q2. Which type of question can be used to encourage cadets to take part in a discussion?
- Q3. What is one thing to avoid when using reverse and relay questions?

#### ANTICIPATED ANSWERS

- A1. Lead-off.
- A2. Direct.

A3. Trying to hide the fact that an instructor doesn't know the answer to a question.

---

#### Teaching Point 4

#### Conduct an Activity Where the Cadets Will Practice Posing Questions Using the Pose, Pause, Pounce, Ponder and Praise Sequence

Time: 10 min

Method: In-Class Activity

---

### ACTIVITY

---

#### OBJECTIVE

The objective of this activity is to introduce cadets to a posing questions sequence that they can follow when asking questions while instructing, particularly during M309.07 (Instruct a 15-Minute Lesson, Section 7).

#### RESOURCES

- Posing questions sequence handout located at Annex E,
- Questions handout located at Annex F,
- Posing questions rubric located at Annex G, and
- Posing questions checklist located at Annex H.

#### ACTIVITY LAYOUT

Set up work stations, if necessary, labelled A, B, C, etc. and place the following at each station:

- a copy of the posing questions sequence handout,
- a copy of the questions, and
- pens/pencils.



If possible brief the assisting staff and the cadets prior to the lesson.



The activity can be used with one group of five to ten cadets or several smaller groups if numbers warrant. The objective is to have each cadet follow the question posing sequence for at least one question but they can ask more than one if necessary. If the group is larger than five other questions can be devised using the children's story, "Goldilocks and the Three Bears."

#### ACTIVITY INSTRUCTIONS

Divide cadets into groups, if necessary, and assign a supervisor and letter name to each group.

1. Brief the assisting staff that they will be expected to:
  - (a) assign each cadet in their group a number from one to five indicating the order in which they will take part in the activity;

- (b) move their groups to the appropriately named area to conduct the activity;
  - (c) read the introduction to the children’s story, “Goldilocks and the Three Bears” to the cadets;
  - (d) ask Cadet # 1 to pose the first question from Annex F and record information on the checklist describing their performance;
  - (e) carry out the same procedure for each succeeding cadet;
  - (f) provide feedback to each cadet regarding their performance;
  - (g) return the group to the main area; and
  - (h) give the completed posing questions checklist to the instructor.
2. Ensure that assisting staff have a copy of Annexes E to H.
  3. Brief the cadets that they will:
    - (a) listen to a short introduction to the children’s story, “Goldilocks and the Three Bears”;
    - (b) use a question posing sequence to ask one question to their group based on the children’s story, “Goldilocks and the Three Bears”; and
    - (c) be supervised and corrected on the spot if they do not follow the posing questions sequence properly.
  4. Have the cadets begin the activity.
  5. Circulate throughout the training area observing the groups as they take part in the activity.
  6. Debrief the cadets on their performance.

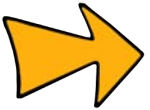

Remind cadets that the activity was designed to introduce a posing questions sequence that they can follow when asking questions while instructing, particularly during M309.07 (Instruct a 15-Minute Lesson, Section 7).

## SAFETY

N/A.

---

### CONFIRMATION OF TEACHING POINT 4

---

The cadets’ participation in the activity will serve as the confirmation of this TP.

---

### END OF LESSON CONFIRMATION

---

## QUESTIONS

- Q1. What are the four purposes for asking questions?
- Q2. List two qualities of a good question.
- Q3. List two types of questions most commonly recognized.
- Q4. List the five parts of the question posing sequence.



**ANTICIPATED ANSWERS**

- A1. The four purposes of questions are:
- to determine the cadets' level of comprehension of previously taught material;
  - to create and maintain interest;
  - to guide and provoke thinking; and
  - to confirm learning of new material.
- A2. Good questions should be brief and complete, written clearly using simple language, challenging, not too difficult and relevant to the lesson.
- A3. The types of questions most commonly recognized are lead-off questions, follow-up questions, overhead questions, direct questions and reverse or relay questions.
- A4. The five parts of the question posing sequence are pose, pause, point, ponder and praise.

**CONCLUSION****HOMEWORK/READING/PRACTICE**

N/A.

**METHOD OF EVALUATION**

N/A.

**CLOSING STATEMENT**

The question is an important tool for the instructor. It is useful for instructors to know the purposes, qualities and types of questions but should keep in mind that this knowledge alone will not necessarily improve questioning technique. Carefully writing out questions before hand and asking them properly are just as important when using questions while instructing a lesson.

**INSTRUCTOR NOTES/REMARKS**

N/A.

**REFERENCES**

- A0-055 A-P9-050-000/PT-006 Director Training and Education Policy. (2002). *Canadian Forces Individual Training and Education System* (Vol. 6). Ottawa, ON: Department of National Defence.
- A0-056 A-P9-050-000/PT-005 Director Training and Education Policy. (2001). *Canadian Forces Individual Training and Education System* (Vol. 5). Ottawa, ON: Department of National Defence.
- A0-057 A-CR-CCP-913/PT-001 Cadet Instructors List Training School. (1978). *Technique of Instruction*. Ottawa, ON: Department of National Defence.

THIS PAGE INTENTIONALLY LEFT BLANK



**COMMON TRAINING**  
**SILVER STAR**  
**INSTRUCTIONAL GUIDE**



**SECTION 5**

**EO M309.05 – SELECT APPROPRIATE INSTRUCTIONAL AIDS**

Total Time:

60 min

---

**PREPARATION**

---

**PRE-LESSON INSTRUCTIONS**

Resources needed for the delivery of this lesson are listed in the lesson specification located in A-CR-CCP-703/PG-001, Chapter 4. Specific uses for said resources are identified throughout the instructional guide within the TP for which they are required.

Review the lesson content and become familiar with the material prior to delivering the lesson.

The activity in TP 2 uses learning stations. Learning stations are a form of group work where the cadets learn by sorting through the information presented. When setting up learning stations, ensure there is enough room for each cadet to be comfortable and have adequate space for writing down information. When the cadets arrive at a learning station, all required information shall be available. These stations should be placed close together to minimize time for movement; however far enough apart to avoid interruptions from other groups. For this lesson, choose and set up five learning stations.

Photocopy the handouts located at Annexes I and J and place a copy of each at the appropriate learning station.

Samples of instructional aids available at the corps should be used during this lesson.

**PRE-LESSON ASSIGNMENT**

N/A.

**APPROACH**

An interactive lecture was chosen for TP 1 to introduce instructional aids, as it allows the instructor to deliver new information while encouraging the cadets to actively participate by asking and responding to questions.

An in-class activity was chosen for TP 2 as it is an interactive way to introduce the cadets to the different types of instructional aids and to confirm the cadets' comprehension of the material presented.

---

**INTRODUCTION**

---

**REVIEW**

N/A.

## OBJECTIVES

By the end of this lesson the cadet shall have identified and selected appropriate instructional aids for a given topic.

## IMPORTANCE

It is important for cadets to know that selecting appropriate instructional aids is an important part of pre-lesson preparation. Using instructional aids during a lesson helps stimulate the cadets' interest and helps them comprehend and recall the new material.

---

### Teaching Point 1

### Describe Instructional Aids

Time: 5 min

Method: Interactive Lecture

---

## INSTRUCTIONAL AIDS

Instructional aids consist of various types of learning support that emphasize and clarify teaching points. Instructional aids include handouts, verbal support, audiovisual aids, simulators and real equipment. Instructional aids can be produced locally or purchased externally but must:

- be relevant to the teaching point;
- support learning; and
- be appropriate to the cadets' background and needs.

Instructional aids can be categorized as:

- **Training Aids.** Training aids refer to all types of learning support instructors use to instruct the lesson.
- **Learning Aids.** Learning aids refer to all the materials the cadets use to participate in the lesson and comprehend the material.

---

### CONFIRMATION OF TEACHING POINT 1

---

## QUESTIONS

- Q1. How can instructional aids support learning?
- Q2. How can instructional aids be obtained?
- Q3. What is the difference between a training aid and a learning aid?

## ANTICIPATED ANSWERS

- A1. Instructional aids support learning by emphasizing and clarifying teaching points.
- A2. Instructional aids can be produced locally or purchased externally.
- A3. A training aid is used by the instructor to instruct the lesson and a learning aid is used by the cadet to participate in the lesson and comprehend the material.

**Teaching Point 2****Conduct an Activity Where the Cadets Will Identify Types of Instructional Aids and Select an Instructional Aid Appropriate for a Given Topic**

Time: 45 min

Method: In-Class Activity

**BACKGROUND KNOWLEDGE**

The saying “a picture is worth a thousand words”, describes the effectiveness of instructional aids. New instructional aids are being developed all the time and it is important for instructors to know what aids are available, when to use them and how to use them. Some of the more common instructional aids are described in Annex I.



“Show 'em as well as tell 'em!” Cadets will remember more for longer periods of time.

**ACTIVITY****OBJECTIVE**

The objective of this activity is to have cadets identify types of instructional aids and select an instructional aid appropriate for a given topic.

**RESOURCES**

- Instructional aids information sheets,
- Worksheets,
- Stopwatch,
- Signalling device,
- Flip chart paper,
- Coloured markers, and
- Pens/pencils.

**ACTIVITY LAYOUT**

Set up and label five learning stations “Instructional Aids”, “Verbal Support”, “Audiovisual Aids”, “Simulators and Training Equipment” and “Select an Instructional Aid.”

**ACTIVITY INSTRUCTIONS**

1. Divide the cadets into five groups and place one group at each learning station.
2. Assign each group a leader. Have the group leader assign a recorder and a reader.
3. Have the cadets read the information sheets and fill out a worksheet on each aspect of instructional aids. It is necessary for each group to fill out only one worksheet.
4. After eight minutes, have the groups rotate clockwise to the next station, where they will have another eight minutes to complete a worksheet.

5. Rotate the groups through the remaining stations.
6. Have the cadets share the information they recorded from each station.

**SAFETY**

N/A.

---

**CONFIRMATION OF TEACHING POINT 2**

---

The cadets' participation in the activity will serve as the confirmation of this TP.

---

**END OF LESSON CONFIRMATION**

---

The cadets' participation in the instructional aids activity in TP 2 will serve as the confirmation of this lesson.

---

**CONCLUSION**

---

**HOMEWORK/READING/PRACTICE**

N/A.

**METHOD OF EVALUATION**

This EO is assessed IAW A-CR-CCP-703/PG-001, Chapter 3, Annex B, Appendix 3 (309 PC).

**CLOSING STATEMENT**

Instructional aids appeal to all five senses but mainly to our senses of sight and hearing. It has often been reported that 75 percent of all learning happens through sight and that you remember 50 percent more when you both see and hear the information. It naturally follows therefore, that learning is enhanced when instructional aids are used.

**INSTRUCTOR NOTES/REMARKS**

Samples of instructional aids available at the corps should be used during this lesson.

---

**REFERENCES**

---

- |        |   |
|--------|---|
| A0-056 | A-P9-050-000/PT-005 Director Training and Education Policy. (2001). <i>Canadian Forces Individual Training and Education System</i> . (Vol. 5). Ottawa, ON: Department of National Defence.   |
| A0-058 | A-P9-050-000/PT-004 Director Training and Education Policy. (1999). <i>Canadian Forces Individual Training and Education System</i> . (Vol. 4). Ottawa, ON: Department of National Defence.   |
| A0-057 | A-CR-CCP-913/PT-001 Cadet Instructors List Training School. (1978). <i>Technique of Instruction</i> . Ottawa, ON: Department of National Defence.   |
| C0-194 | Dynamic Flight, Inc. <i>Instructional Aids and Training Technologies</i> . (2003). Retrieved March 20, 2008, from <a href="http://www.dynamicflight.com/avcfibook/inst_aids">http://www.dynamicflight.com/avcfibook/inst_aids</a> . |



**COMMON TRAINING**  
**SILVER STAR**  
**INSTRUCTIONAL GUIDE**



**SECTION 6**  
**EO M309.06 – PLAN A LESSON**

---

Total Time:

60 min

---



---

**PREPARATION**

---

**PRE-LESSON INSTRUCTIONS**

Resources needed for the delivery of this lesson are listed in the lesson specification located in A-CR-CCP-703/PG-001, Chapter 4. Specific uses for said resources are identified throughout the instructional guide within the TP for which they are required.

Review the lesson content and become familiar with the material prior to delivering the lesson.

Photocopy the lesson specification and instructional guide handout located at Annex K, the blank lesson plan located at Annex L and the plan a lesson checklist located at Annex M for each cadet.

Photocopy the lesson specifications and instructional guides located at Annexes N to AB as required.

**PRE-LESSON ASSIGNMENT**

N/A.

**APPROACH**

An interactive lecture was chosen for TPs 1–3 to present basic material on how to research lesson content and how to prepare for a lesson.

A practical activity was chosen for TP 4 to allow the cadets to plan a lesson in a structured and controlled environment. This activity contributes to the development of lesson-planning skills and will serve as preparation for EO M309.07 (Instruct a 15-Minute Lesson, Section 7).

---

**INTRODUCTION**

---

**REVIEW**

N/A.

**OBJECTIVES**

By the end of this lesson the cadet shall be expected to research lesson content and develop a lesson plan.

## IMPORTANCE

It is important for cadets to research lesson content, prepare a lesson location and plan a lesson because these are critical steps to the success of a period of instruction. The preparation of a lesson location sets the tone for the lesson and a well-developed lesson plan provides structure and organization, guides the instructor through each stage of the lesson and ensures that all essential information is delivered.

### Teaching Point 1

### Explain How to Research Lesson Content

Time: 10 min

Method: Interactive Lecture



Some common abbreviations and terms used by training officers and instructors:

- **QSP.** Qualification Standard and Plan.
- **PO.** Performance Objective.
- **EO.** Enabling Objective.
- **TP.** Teaching Point.
- **PC.** Performance Check.
- **EC.** Enabling Check.
- **IG.** Instructional Guide.

## RESEARCHING LESSON CONTENT

To plan for a lesson, the cadets will need to research lesson content and become familiar with the conditions, standard, TPs, lesson content and the time allocated for the EO and TPs.

The Canadian Forces employs an acronym that is used to provide a framework for the instructor to gather and organize the reference material into an efficient and practical lesson plan. The initialism is CCSAM.

**Collect.** During this step, the instructor researches the material to be covered in the period of instruction using course documents such as the lesson specification, IG and listed references. In situations where no course documents exist, the instructor will research the material to be taught using whatever references exist.

**Consider.** During this step, the instructor sifts through all of the material found in the collection step and determines what is relevant and current.

**Select.** During this step, instructor selects the material that is appropriate for the lesson. The instructor also selects the method of instruction to be used.

**Arrange.** During this step, the instructor arranges the material into stages that allow for the information to be presented in a logical sequence.

**Master.** During this step, the instructor writes the lesson plan.



The use of CCSAM is a good general practice. In most cases for cadet training these steps have been completed during the development of the lesson specifications and IGs. The instructor may need to only transpose the information into the pertinent parts of their lesson plan.





Distribute the lesson specification and instructional guide handout located at Annex K to each cadet.

### **ENABLING OBJECTIVE AND LESSON SPECIFICATION**



Enabling objectives and lesson specifications can be found in Chapter 4 of the QSP.

Performance objectives are broken down into a series of enabling objectives and lesson specifications. The enabling objective consists of Paragraphs 1. to 3. (as illustrated in Figure 9-6-1). The information in these paragraphs will answer three questions:

1. What will the cadet be expected to be able to do by the end of this lesson?
2. Under what conditions will the cadet be expected to carry out the performance?
3. How well or to what standard will the cadet be expected to perform?

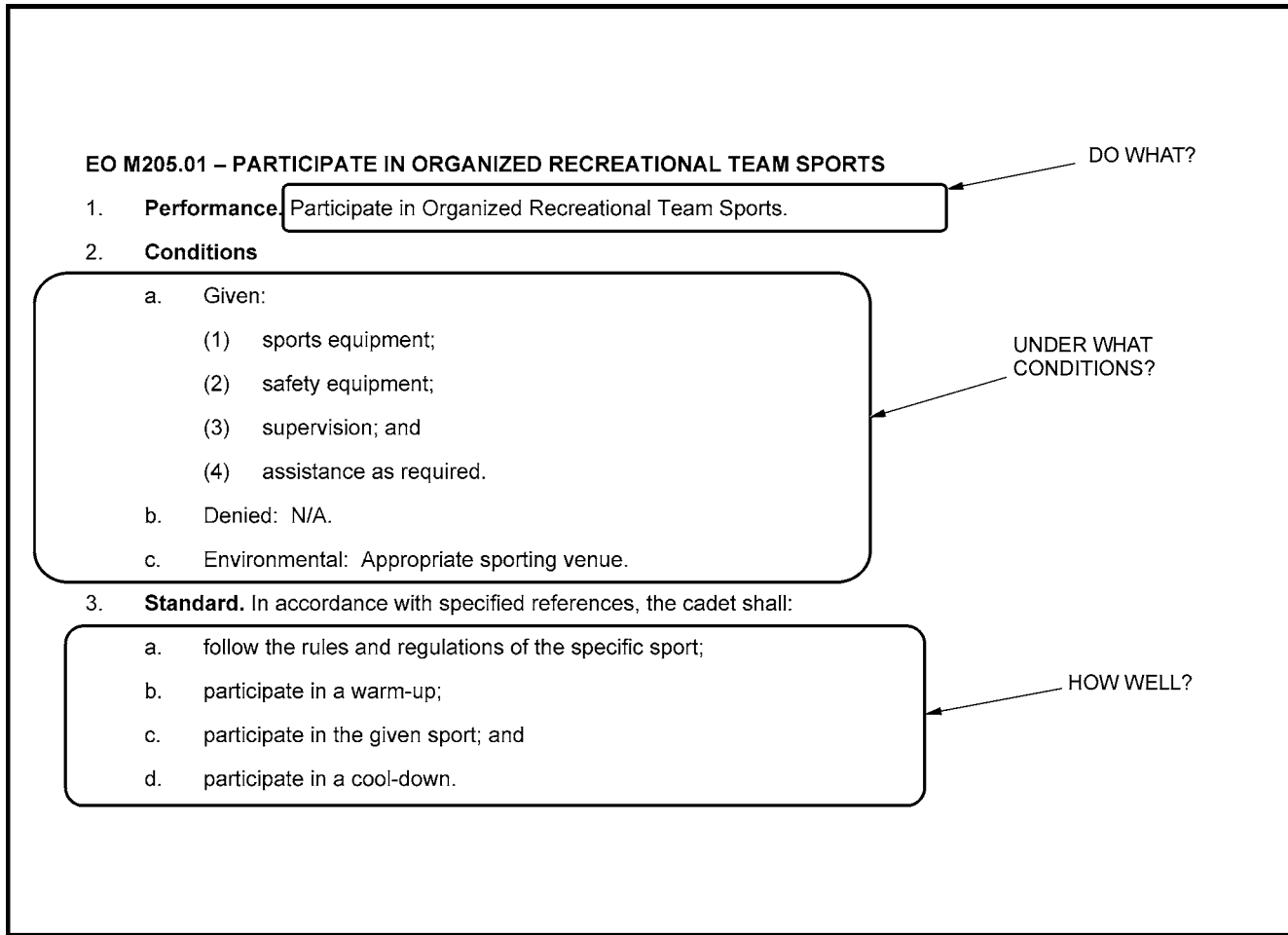

*Director Cadets 3, 2008, Ottawa, ON: Department of National Defence*

Figure 9-6-1 Enabling Objective

Paragraphs 4. to 11. are known as the lesson specification. The lesson specification provides information about the content to be taught, teaching methods, time, references, training aids, learning aids, test details and remarks.

In Paragraph 4., the TPs are usually described in a table where information is provided on the content taught in each TP, the suggested teaching method, the time for each TP and references (as illustrated in Figure 9-6-2).

4. Teaching Points

TP	Description	Method	Time	Ref
TP1	Introduce cadets to a specific sport's rules and regulations, to include: <ul style="list-style-type: none"> <li>a. an overview of how to play the sport; and</li> <li>b. rules and regulations of the sport.</li> </ul>	Interactive Lecture	10 min	C0-001
TP2	Conduct a warm-up session, composed of light cardiovascular exercises, meant to: <ul style="list-style-type: none"> <li>a. stretch the muscles;</li> <li>b. gradually increase respiratory action and heart rate;</li> <li>c. expand the muscles' capillaries to accommodate the increase in blood circulation; and</li> <li>d. raise muscle temperature to facilitate reactions in muscle tissue.</li> </ul>	Practical Activity	10 min	C0-002 (pp. 109 to 113) C0-089
TP3	Supervise the cadets' participation in a given sports activity.	Practical Activity	50 min	

CONTENT TO BE TAUGHT

LENGTH OF TP

REFERENCE NUMBER

SUGGESTED TEACHING METHOD

*Director Cadets 3, 2008, Ottawa, ON: Department of National Defence*

Figure 9-6-2 Teaching Points

Paragraph 5. outlines how much time is spent on the introduction/conclusion and the different teaching methods. Paragraph 6. offers substantiation or reasons why certain teaching methods were recommended for each TP. Paragraph 7. provides a list of references used to compile the content in Paragraph 4. (as illustrated in Figure 9-6-3).

**5. Time**

a.	Introduction/Conclusion:	10 min
b.	Interactive Lecture:	10 min
c.	Practical Activity:	70 min
d.	Subtotal:	90 min
e.	Total (three sessions):	270 min

**6. Substantiation**

- a. An interactive lecture was chosen for TP1 to illustrate the application of rules, principles, or concepts of the specific sport to be played.
- b. A practical activity was chosen for TP2 to TP4 as it allows cadets to participate in sports activities in a safe and controlled environment. This activity contributes to the development of sports skills in a fun and challenging setting.

**7. References**

- a. C0-001 (ISBN 0-88011-807-5) Hanlon, T. (1998). *The Sports Rules Book: Essential Rules for 54 Sports*. USA: Human Kinetics Publishers, Inc.
- b. C0-002 (ISBN 0-88962-630-8) LeBlanc, J., and Dickson, L. (1997). *Straight Talk About Children and Sport: Advice for Parents, Coaches, And teachers*. Oakville, ON and Buffalo, NY: Mosaic Press.

*Director Cadets 3, 2008, Ottawa, ON: Department of National Defence*

Figure 9-6-3 Paragraphs 5–7

Paragraphs 8. and 9. list the training aids and learning aids required for the lesson. Training aids are the materials that are required by the instructor to instruct the lesson and learning aids are the materials that will be required by the cadet to participate in the lesson (as illustrated in Figure 9-6-4).

**8. Training Aids**

- a. Sports/safety equipment appropriate for the activity;
- b. First aid kit;
- c. Whistles; and
- d. Stopwatch.

**9. Learning Aids.** Sports equipment.

*Director Cadets 3, 2008, Ottawa, ON: Department of National Defence*

Figure 9-6-4 Training Aids and Learning Aids

Paragraph 10. is test details, which is information about the evaluation to be conducted. Paragraph 11. is remarks, which describe any other information that may be useful to the Training Officer or instructor (as illustrated in Figure 9-6-5).

- |   |
|---|
| <p>10. <b>Test Details.</b> N/A.</p> <p>11. <b>Remarks</b></p> <p>a. The CCO list of approved sports is located at A-CR-CCP-702/PF-001, Chapter 5, Annex A.</p> <p>b. Recreational sports can be carried out as nine periods during a supported day or over three sessions of three periods each.</p> |
|---|

*Director Cadets 3, 2008, Ottawa, ON: Department of National Defence*

Figure 9-6-5 Test Details and Remarks



Test details will be described in one of the following ways:

- **N/A.** No evaluation for this EO.
- **This EO is Assessed IAW Chapter 3, Annex B, 209 PC.** There is a performance check (PC) associated with this EO, refer to Chapter 3, Annex B for details.
- **This EO is Assessed IAW Chapter 3, Annex B, 209 EC 01.** There is an enabling check (EC) associated with this EO, refer to Chapter 3, Annex B for details.

## INSTRUCTIONAL GUIDE

The IG is used in conjunction with the QSP and other resources to conduct training. IGs should be reviewed in conjunction with lesson specifications so that the instructor can adequately plan and prepare their lesson. IGs do not replace lesson plans but offer written content, supporting figures and suggestions on how to instruct a lesson. The following are the six sections of an IG:

1. preparation,
2. introduction,
3. body,
4. conclusion,
5. references, and
6. annexes.

### Preparation

The preparation section provides information about where to find the lesson specification and any instructions to the instructor such as reviewing lesson content, photocopying handouts, pre-lesson assignments and the approach and substantiation as to why certain teaching methods were recommended for each TP.

### Introduction

The introduction section provides information to the instructor about review that may be necessary, what the cadet will be expected to do by the end of the lesson and why the knowledge/skills are important.

### The Body

The body of the IG contains all of the TPs and content listed in Paragraph 4. of the lesson specification in greater detail. The body provides suggested teaching methods, note boxes with special instructions or information (as illustrated in Figure 9-6-6), lesson content, figures, activities and confirmation questions.

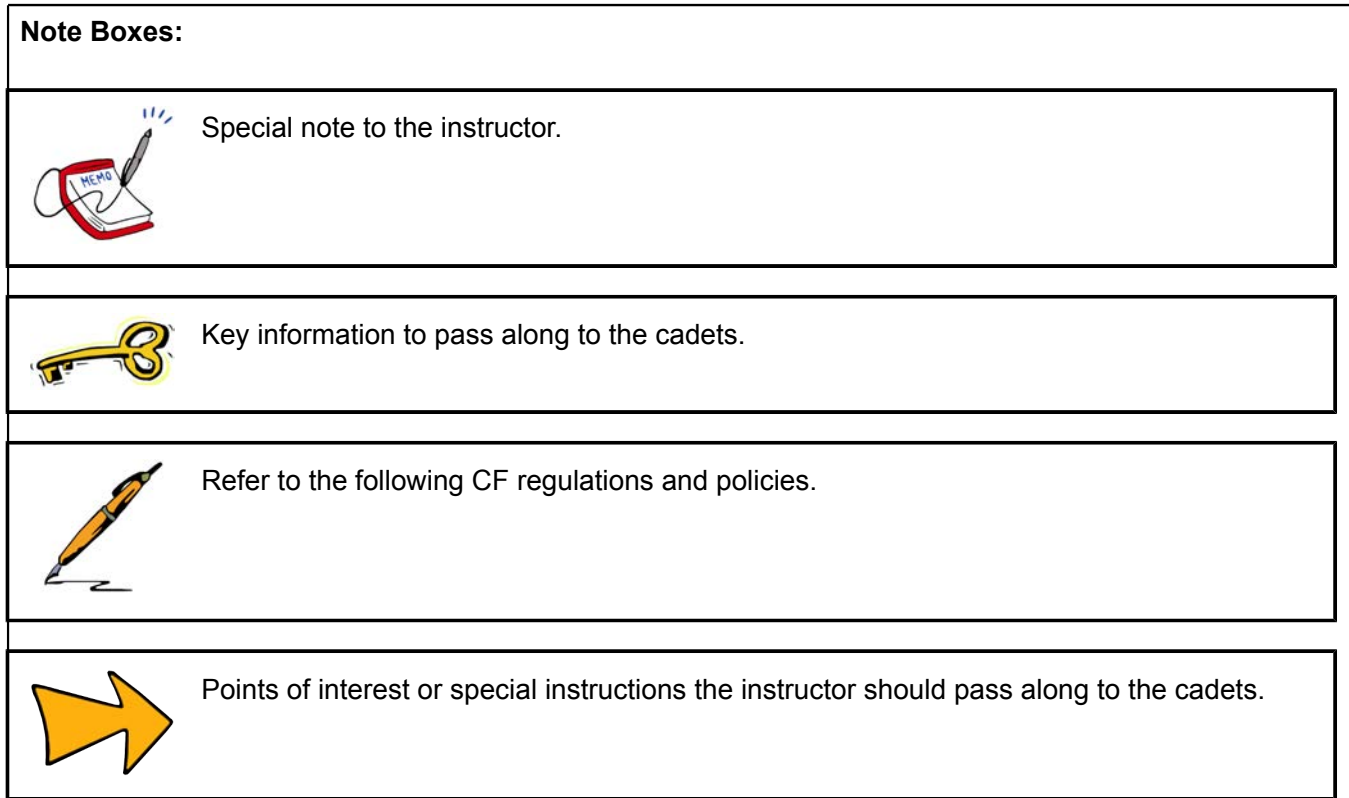

*Director Cadets 3, 2008, Ottawa, ON: Department of National Defence*

Figure 9-6-6 Note Boxes

## The Conclusion

The conclusion section states any homework/reading/practice that may be required of the cadet and the method of evaluation as stated in the lesson specification. The conclusion section also provides a closing statement to be spoken aloud to the cadets and any additional instructor notes/remarks.

## References

The reference section lists the references used to create the lesson specification and instructional guide. In some cases, an IG may direct the instructor to a specific reference to be used during a lesson. In most cases this section is only used to identify where the content of the lesson has been drawn from.

## Annexes

The annex section contains information that may range from pre-made training aids, learning aids such as handouts and additional information for activities.

---

## CONFIRMATION OF TEACHING POINT 1

---

## QUESTIONS

- Q1. Where can a lesson specification be found?
- Q2. What information can be found in the preparation section of an instructional guide?
- Q3. What information can be found in the body of an instructional guide?

## ANTICIPATED ANSWERS

- A1. In Chapter 4 of the QSP.
- A2. The preparation section provides information about where to find the lesson specification and any instructions to the instructor such as reviewing lesson content, photocopying handouts, pre-lesson assignments and the approach and substantiation as to why certain teaching methods were recommended for each TP.
- A3. The body of the IG contains all of the TPs and content listed in Paragraph 4. of the lesson specification in greater detail. The body provides suggested teaching methods, note boxes with special instructions or information (as illustrated in Figure 9-6-6), lesson content, figures, activities and confirmation questions.

---

### Teaching Point 2

### Explain How to Prepare for a Lesson

Time: 5 min

Method: Interactive Lecture

---

## PREPARING FOR A LESSON

A well-prepared and positive learning environment can enhance a lesson and the learning experience.

The cadets' attention will not only be focused on the instructor but also on the environment around them. Effort put into lesson preparation and presentation can be wasted if the environment is not prepared for optimal learning.

### Selecting a Lesson Location

When selecting a lesson location the instructor should consider the following:

- the type of training to be conducted (eg, general cadet knowledge versus navigation);
- any activities outlined in the instructional guide;
- the size of the group being trained;
- the size of the location;
- the lighting of the location;
- the ventilation of the location;
- the suitability of the location regarding noise distractions; and
- the suitability of the location regarding the use of visual aids.

### Setting Up the Location

After selecting a lesson location, the instructor must take steps to ensure the location is clean and arranged properly for an optimal training environment.

**Cleanliness.** A clean training area will prevent distractions and will positively affect motivation. Cadets will notice a messy, disorganized area immediately and will be distracted before the class begins. The room must be clean and well-organized with the boards wiped clean, debris picked up, garbage cans empty, etc.

**Seating Arrangements.** Cadets must be able to see the instructor, the visual aids and each other to achieve maximum participation. Some arrangements will not be possible given the allotted space. The following descriptions and diagrams depict possible seating arrangements:

- **U-Shaped.** Allows the instructor to see all cadets easily and also allows trainees to see each other.

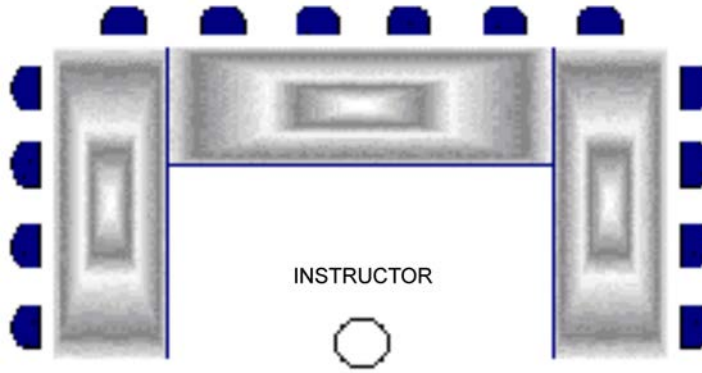

*E. Jenson, Super Teaching: Mastering Strategies for Building Trainee Success, The Brain Store Inc. (p. 109)*

Figure 9-6-7 U-Shaped

- **Chevron Shape.** Found mostly in auditorium-style rooms and can accommodate large groups.

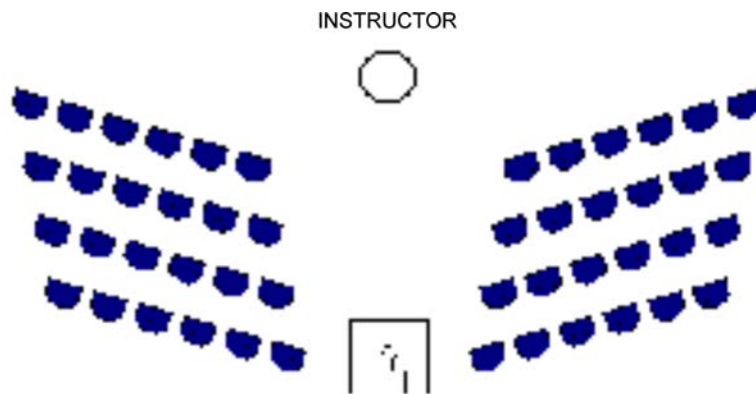

*E. Jenson, Super Teaching: Mastering Strategies for Building Trainee Success, The Brain Store Inc. (p. 109)*

Figure 9-6-8 Chevron Shape

- **Horseshoe.** Can be employed for two groups. This set-up works well during debates and in-class activities.

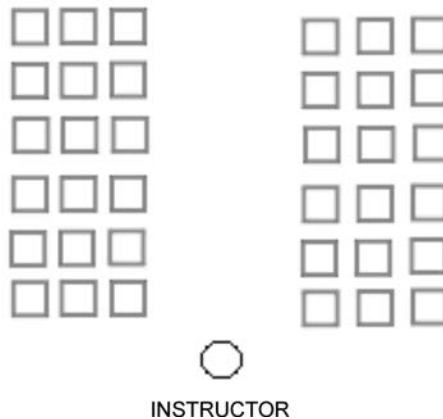

*E. Jenson, Super Teaching: Mastering Strategies for Building Trainee Success, The Brain Store Inc. (p. 109)*

Figure 9-6-9 Horseshoe

- **Semicircle.** Instructor has a good view of the cadets.



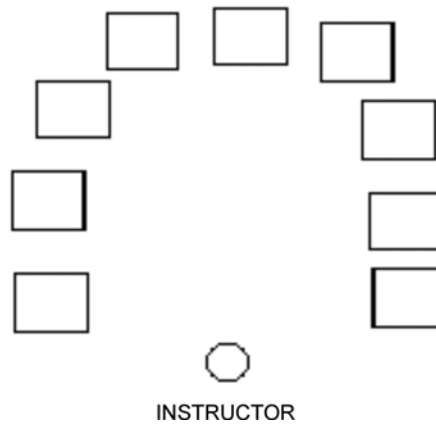

*E. Jenson, Super Teaching: Mastering Strategies for Building Trainee Success, The Brain Store Inc. (p. 109)*

Figure 9-6-10 Semicircle

- **Standard in Line.** Allows for more frontal coverage with less depth front to back.

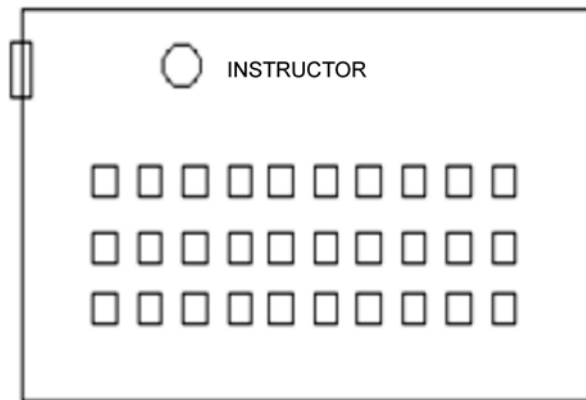

*E. Jenson, Super Teaching: Mastering Strategies for Building Trainee Success, The Brain Store Inc. (p. 109)*

Figure 9-6-11 Standard in Line

---

## CONFIRMATION OF TEACHING POINT 2

---

### QUESTIONS

- Q1. What should the instructor consider when selecting a lesson location?
- Q2. Why is it important to have a clean lesson location?
- Q3. What are three seating arrangements?

### ANTICIPATED ANSWERS

- A1. When selecting a lesson location the instructor should consider the following:
- the type of training to be conducted (eg, general cadet knowledge versus navigation);
  - any activities outlined in the instructional guide;
  - the size of the group being trained;
  - the size of the location;

- the lighting of the location;
- the ventilation of the location;
- the suitability of the location regarding noise distractions; and
- the suitability of the location regarding the use of visual aids.

A2. Cadets will notice a messy, disorganized area immediately and will be distracted before the class begins.

A3. Seating arrangements are:

- u-shaped,
- chevron shape,
- horseshoe,
- semicircle, and
- standard in line.

---

**Teaching Point 3**

**Describe the Lesson Plan Format**

Time: 10 min

Method: Interactive Lecture

---

**LESSON PLAN FORMAT**

The lesson plan is a way for the instructor to organize the lesson and summarize the information included in the lesson specification, the IG and their personal ideas. Lesson plans provide a set of detailed directions for delivering one or more periods of instruction.

The lesson plan is arranged in this specific order:

Part	Purpose
1. Introduction	Builds the cadets' interest and motivation.
2. Body	Presents and explains each TP.
3. End of Lesson Confirmation	Confirms cadets' comprehension of the lesson.
4. Conclusion	Summarizes key points and identifies future lessons.

**Introduction**

The introduction is the instructor's first verbal interaction with the cadets. It should capture the cadets' interest. The following should be included in the introduction of a lesson plan:

- **What.** A description of what the cadets will be expected to accomplish at the end of the lesson.
- **Where.** A description of how and where the lesson fits into the Cadet Program.
- **Why.** A description of why it is important for the cadets to achieve the objectives.



Read the Objective and Importance paragraphs in the IG for help in writing the introduction of the lesson plan.

## Body

The body of the lesson plan is where the content is presented, explained and supported. Each TP directs the instructor and the cadets.

Each TP in the lesson includes:

- **Introduction.** Briefly introduce the content to be taught during the TP.
- **Teaching Method.** Identify which teaching method has been chosen for the TP.
- **Lesson Content.** Present the content of the TP in a clear and logical order, from easy to difficult, known to unknown and simple to complex.
- **Confirmation.** May be oral questions, games, role play, in-class activities or practical activities. IGs offer suggestions for how to confirm TPs. Instructors may choose to use those confirmation suggestions or develop their own.

## End of Lesson Confirmation

The lesson plan should outline procedures to be used to confirm the learning of the TP. End of lesson confirmations are carried out to ensure that the cadets understood the whole lesson and that any weaknesses in performance are identified so they can be corrected.

Confirmation activities are based on the lesson objectives. The end of lesson confirmation may be oral questions, games, role play, in-class activities or practical activities. IGs offer suggestions for how to conduct end of lesson confirmations. Instructors may choose to use those confirmation suggestions or develop their own.

## Conclusion

The conclusion of a lesson summarizes the key points and links them to the coming lessons and their practical use.

**A Summary of Important Points and Weak Areas.** The summary reviews the main TPs. The depth of the summary will be determined by the lesson objectives and the results of the cadets' end of lesson confirmation. If the cadets achieved the objectives successfully, the summary may be brief. If they experienced some difficulties, the instructor should identify them here and indicate how the issue will be addressed.

**Re-Motivation Statement.** The re-motivation statement restates the importance of the lesson (the "why") and re-motivates the cadets. The instructor should also take this time to address any precautions the cadets should be aware of when applying the knowledge in a practical setting and give an overview of the next lesson.



Read the Closing Statement paragraph in the IG for help in writing the conclusion of the lesson plan.

---

## CONFIRMATION OF TEACHING POINT 3

---

### QUESTIONS

- Q1. What are the four sections of a lesson plan?
- Q2. What three questions are answered in the introduction?
- Q3. What are the four sections of a teaching point?

## ANTICIPATED ANSWERS

A1. The four sections of a lesson plan are:

- introduction,
- body,
- end of lesson confirmation, and
- conclusion.

A2. The three questions answered in the introduction are:

- what,
- where, and
- why.

A3. The four sections of a teaching point are:

- introduction,
- teaching method,
- lesson content, and
- confirmation.

---

### Teaching Point 4

### Supervise and Provide Assistance While the Cadets Plan a Lesson

Time: 25 min

Method: Practical Activity

---

In EO M309.07 (Instruct a 15-Minute Lesson, Section 7) the cadets will be expected to instruct a lesson using a lesson plan, an instructional aid and the appropriate instructional method. The lesson plan created in this EO will be used to instruct that lesson.



Distribute the blank lesson plan located at Annex L and the plan a lesson checklist located at Annex M to each cadet.



As the cadets begin to place information in the lesson plan, they will need to know what information to place in the two columns not discussed in the previous TP.

**Time.** This column reminds the instructor how long to spend on each section of the lesson.

**Notes.** The instructor can place information in this column as a reminder of when to distribute a handout, to pass along special information to the class or information about a confirmation activity.

INSTRUCTIONS AND REMINDERS		
LESSON PLAN		
EO #:	Title of the EO:	
Instructor:	Location:	Total Time: min
TIME	INTRODUCTION	NOTES
3 min	<b>What:</b> <b>Where:</b> <b>Why:</b>	Distribute handouts here.
TIME	BODY	NOTES
10 min	<b>TP: Teaching Method:</b> <b>TP 1:</b>	Use analogy here.
EXPECTED TIME		

Director Cadets 3, 2008, Ottawa, ON: Department of National Defence

Figure 9-6-12 Lesson Plan

## ACTIVITY

### OBJECTIVE

The objective of this activity is to have the cadets plan a 15-minute lesson.

### RESOURCES

- List of approved 15-minute topics located at Annex M, and
- Modified lesson specifications and instructional guides located at Annexes N to AB.

### ACTIVITY LAYOUT

N/A.

### ACTIVITY INSTRUCTIONS

1. Have each cadet choose a topic from the list of approved 15-minute topics.
2. Have the cadets use the lesson specification and IG for their chosen topic to help develop their lesson plan. Cadets shall be expected to teach their chosen lesson as part of M309.07 (Instruct a 15-Minute Lesson, Section 7).
3. Circulate around the room facilitating the activity and helping the cadets as required.



Ensure that cadets request all resources required to instruct their lesson.

## **SAFETY**

N/A.

---

### **CONFIRMATION OF TEACHING POINT 4**

---

The cadets' participation in the activity will serve as the confirmation of this TP.

---

### **END OF LESSON CONFIRMATION**

---

The cadets' completion of a lesson plan will serve as the confirmation of this lesson.

---

### **CONCLUSION**

---

## **HOMEWORK/READING/PRACTICE**

The cadets should be prepared to instruct their lesson at the beginning of M309.07 (Instruct a 15-Minute Lesson, Section 7).

## **METHOD OF EVALUATION**

This EO is assessed IAW A-CR-CCP-703/PG-001, Chapter 3, Annex B, Appendix 3 (309 PC).

## **CLOSING STATEMENT**

Researching lesson content, preparing a lesson location and planning a lesson are critical steps in preparing a period of instruction. The preparation of a lesson location sets the tone for the lesson to be taught and a well-developed lesson plan provides structure and organization, guides the instructor through each stage of the lesson and ensures that all essential information is delivered.

## **INSTRUCTOR NOTES/REMARKS**

EO M309.06 (Plan a Lesson) should be scheduled at least one week prior to EO M309.07 (Instruct a 15-Minute Lesson, Section 7).

EO C309.02 (Plan a Lesson, Section 9) may be scheduled as additional time for this EO.

---

### **REFERENCES**

---

- A1-042 A-P9-050-000/PT-005 Director Training and Education Policy. (2001). *Canadian Forces Individual Training & Education System* (Vol. 5). Ottawa, ON: Department of National Defence.
- C1-133 (ISBN 0-9695066-2-7) Bender, P. (2000). *Secrets of Power Presentations*. Toronto, ON: The Achievement Group.
- C1-140 (ISBN 1-890460-02-8) Jenson, E. (1999). *Super Teaching: Mastering Strategies for Building Trainee Success*. San Diego, CA: The Brain Store Inc.



**COMMON TRAINING**  
**SILVER STAR**  
**INSTRUCTIONAL GUIDE**



**SECTION 7**

**EO M309.07 – INSTRUCT A 15-MINUTE LESSON**

---

Total Time:

90 min

---

**PREPARATION**

---

**PRE-LESSON INSTRUCTIONS**

Resources needed for the delivery of this lesson are listed in the lesson specification located in A-CR-CCP-703/PG-001, Chapter 4. Specific uses for said resources are identified throughout the instructional guide within the TP for which they are required.

Review the lesson content and become familiar with the material prior to delivering the lesson.

Photocopy the Instructional Techniques Assessment Form located at Annex AC for each cadet.

Ensure that all resources requested by the cadets are available.

**PRE-LESSON ASSIGNMENT**

N/A.

**APPROACH**

A practical activity was chosen for this lesson as it is an interactive way for cadets to develop instructional skills in a safe and controlled environment.

---

**INTRODUCTION**

---

**REVIEW**

N/A.

**OBJECTIVES**

By the end of this lesson the cadet shall have instructed a 15-minute lesson using a lesson plan, an appropriate method of instruction and an appropriate instructional aid.

**IMPORTANCE**

It is important for cadets to instruct a 15-minute lesson as it gives them the opportunity to practice instructional techniques in a peer setting and to receive feedback to further develop their confidence.

**Teaching Point 1****Have the Cadets Instruct a 15-Minute Lesson**

Time: 85 min

Method: Practical Activity

**ACTIVITY****OBJECTIVE**

The objective of this activity is to have the cadets instruct a 15-minute lesson in a peer setting using a lesson plan, an appropriate method of instruction and an appropriate instructional aid.

**RESOURCES**

- Presentation aids (eg, whiteboard/flip chart/OHP) appropriate for the classroom/training area, and
- Instructional Techniques Assessment Form.

**ACTIVITY LAYOUT**

N/A.

**ACTIVITY INSTRUCTIONS**

1. Have the cadets provide a copy of their lesson plan to the assessor.
2. Determine the order in which cadets will instruct their lessons.
3. Have one cadet prepare the classroom/training area for their lesson.
4. Have one cadet instruct a 15-minute lesson using a written lesson plan, an appropriate method of instruction and an appropriate instructional aid (as prepared in EO M309.06 [Plan a Lesson, Section 6]).
5. Assess the cadet's lesson using the Instructional Techniques Assessment Form.
6. Upon completion of the lesson, provide feedback to the cadet.
7. Repeat Steps 3. to 6. until all cadets have instructed a lesson.



The Instructional Techniques Assessment Form located at Annex AC is used to provide feedback on the cadet's lesson and to introduce the cadet to the type of instructional techniques assessment they will receive in their future star level training. The grey areas of the form are those applicable to the 309 PC (eg, the standard required for the achievement of PO 309). The remainder of the form is intended solely for the purposes of assessment for learning, providing the cadets with the feedback they need to improve their skills.

8. Debrief the cadets by providing feedback, focusing on:
  - (a) best practices,
  - (b) general trends and key areas for improvement, and
  - (c) re-motivation, highlighting the effort and accomplishments of the group.





If the group of cadets is large, divide them up into smaller groups and assign other instructors to aid with assessment and feedback.

## **SAFETY**

N/A.

---

### **CONFIRMATION OF TEACHING POINT 1**

---

The cadets' participating in the activity will serve as the confirmation of this TP.

---

### **END OF LESSON CONFIRMATION**

---

The cadets' instructing a 15-minute lesson will serve as the confirmation of this lesson.

---

### **CONCLUSION**

---

## **HOMEWORK/READING/PRACTICE**

N/A.

## **METHOD OF EVALUATION**

This EO is assessed IAW A-CR-CCP-703/PG-001, Chapter 3, Appendix 3 (309 PC).

## **CLOSING STATEMENT**

Practicing instructional skills in a peer setting allows for the development of skills necessary to become a competent instructor while further developing confidence and a sense of accomplishment.

## **INSTRUCTOR NOTES/REMARKS**

Additional time for this EO is available in EO C309.03 (Instruct a 15-Minute Lesson, Section 10).

---

### **REFERENCES**

---

A0-055 A-P9-050-000/PT-006 Director Training and Education Policy. (2002). *Canadian Forces Manual of Individual Training and Education* (Vol. 6). Ottawa, ON: Department of National Defence.

THIS PAGE INTENTIONALLY LEFT BLANK



**COMMON TRAINING  
SILVER STAR  
INSTRUCTIONAL GUIDE**



**SECTION 8**

**EO C309.01 – DELIVER A ONE-MINUTE VERBAL PRESENTATION**

Total Time:

60 min

---

**PREPARATION**

---

**PRE-LESSON INSTRUCTIONS**

Resources needed for the delivery of this lesson are listed in the lesson specification located in A-CR-CCP-703/PG-001, Chapter 4. Specific uses for said resources are identified throughout the instructional guide within the TP for which they are required.

Review the lesson content and become familiar with the material prior to delivering the lesson.

Photocopy the list of topics located at Annex AD and the verbal presentation feedback form located at Annex AE for each cadet.

**PRE-LESSON ASSIGNMENT**

N/A.

**APPROACH**

A group discussion was chosen for TP 1 as it allows the cadets to interact with their peers and share their knowledge, experiences, opinions and feelings about public speaking.

An interactive lecture was chosen for TP 2 as it allows the instructor to explain the expectations of the cadets for the one-minute verbal presentation.

A practical activity was chosen for TP 3 as it is an interactive way to help the cadets develop effective-speaking skills in a safe and controlled environment.

---

**INTRODUCTION**

---

**REVIEW**

Review EO M309.03 (Describe Effective-Speaking Techniques, Section 3).

**OBJECTIVES**

By the end of this lesson the cadet shall have delivered a one-minute verbal presentation.

## IMPORTANCE

It is important for cadets to practice effective-speaking techniques because this will develop the skills required to present information and build the self-confidence needed to speak in front of others.

### Teaching Point 1

### Review Effective-Speaking Techniques

Time: 15 min

Method: Group Discussion

## BACKGROUND KNOWLEDGE



The purpose of the group discussion is to draw the following information from the group using the tips for answering/facilitating discussion and the suggested questions provided.

## ELEMENTS OF VOICE CONTROL

One of the most important and effective tools of communication is voice control. The ability to use voice control to communicate effectively and place emphasis on important information is a fundamental skill that will be used while in front of an audience.

**Pitch.** How high or low a voice is. A change in pitch usually does not add any significance to a message. However, a pitch change will be noticed by the audience and will keep people involved.

**Tone.** The quality of the sound of a voice. Effective communicators will often change the tone of their voice to give emphasis to a single word or phrase to convey emotion and conviction.



**Monotone.** A sound without change of pitch or tone.

**Volume.** The quantity or power of sound or fullness of tone. A change in volume often signifies emphasis on a particular phrase or point. Environmental factors such as outside noise and room size must be taken into consideration to ensure the audience can hear the message being sent.

**Speed.** The rate or rapidity in which words are spoken. Speaking too fast or too slow can be distracting to an audience. It is important to communicate at a pace that ensures the audience can understand every word being said.

**Pause.** A break in speaking or reading. A pause is an important part of the communication process. A pause gives the audience an opportunity to digest what has been said and to ask questions. A pause is also an effective way to announce a change in subject or an important point.

**Articulation.** The clear and distinct pronunciation of a word. It is important to properly pronounce and articulate words to ensure the audience can understand the message being sent.

## ELEMENTS OF PHYSICAL PRESENCE

It is estimated that 93 percent of the total meaning of a message comes from non-verbal communication and only 7 percent of meaning comes from the words themselves. Being aware of physical presence and its effect on a message being sent is an important element of effective communication.

## Body Language

Body language or non-verbal communication is the process of communicating through conscious and unconscious gestures and expressions. Understanding that body language affects how a message is received and interpreted is an important tool for communicating effectively.

**Facial Expressions.** While 93 percent of the total meaning of a message comes from non-verbal communication, most of that meaning is communicated by the eyes, eyebrows and mouth. The movement of the eyes, eyebrows and mouth can result in an infinite variety of expressions to complement the spoken word. It is important that facial expressions match the tone of the message being sent to create emphasis and believability. A smile is the most important of all facial expressions. A smile adds sincerity to a message and will add to the likeability of the individual in front of the audience.

**Eye Contact.** Maintaining eye contact is an effective way of engaging an audience and building interest. Pausing two or three seconds on each member of the audience will make them feel as though they are involved in a one-on-one conversation. It is important to look at the entire room and scan from left to right, back to front.

**Gestures.** The combination of hand, arm and shoulder movements can make a wide variety of gestures that can help add meaning to a message. Effective communicators will let their hands and arms move naturally to help give emphasis and emotion to a message. It is important not to point directly at members of the audience or let gestures become distracting.

**Movement.** Being aware of movement while in front of an audience is very important to communication. Movement will keep listeners engaged and interested in what is being said. Moving around the front of the room, toward and away from an audience and from side to side can help emphasize points. Too much or frantic movement can become distracting and will affect how a message is received.



Hands placed in pockets are typically a sign of nervousness or overconfidence.

## Dress and Deportment

Effective communicators are constantly aware of their dress and deportment. Audiences will react differently to an individual who is well dressed and acts professionally when in front of them, than an individual who is poorly dressed and acts unprofessionally.

**Dress.** Effective communicators will always appear in clean, well-pressed and appropriate attire. Dressing appropriately for the event will help create confidence and credibility.

**Deportment.** An audience that sees an individual as being prepared, on time, appropriately dressed and confident will be much more receptive, than to an individual who is unprepared, late, poorly dressed and nervous. The most important element of deportment is displaying an interest in the subject; this will be noticed by the audience and will generate interest in the presentation.

## PREPARATION

Effective speaking preparation is the most critical component of effective communication. Preparation will help ensure confidence, control nervousness and increase the likelihood of success when in front of an audience.

The following are the steps to effective-speaking preparation:

1. **Practicing.** Proper rehearsal will aid in memorizing content, which will allow for more eye contact and movement while in front of an audience. Memorizing the introduction and conclusion are the two most critical elements; a strong introduction will aid in gaining confidence and will draw the interest of the

audience, a strong conclusion will aid in leaving a lasting impression on the audience. If possible, practice in front of a small group, speak aloud even when practicing alone and always practice while standing.

2. **Controlling Nervousness.** The feeling of nervousness prior to speaking in front of a group is normal and often can help if channeled effectively. The following actions can be taken to control nervousness:
  - (a) **Room Layout.** Become familiar with the layout of the room prior to speaking.
  - (b) **Materials.** Ensure notes, handouts and presentation aids are organized.
  - (c) **Equipment.** Ensure any equipment being used is in working order and ready to use.
  - (d) **Practice.** Spend time going over notes and rehearsing content.
  - (e) **Attitude.** Enter the room with a smile and a positive and confident attitude.
  - (f) **Breathing.** Take a deep breath before entering the room. Slow down the delivery if necessary and breathe from the diaphragm while speaking, not from the chest.
3. **Identifying a Friendly Face.** While walking in front of an audience, identify a friendly face. Making eye contact with a friendly face while beginning to speak will often give confidence while beginning the introduction and ultimately lead to success when addressing an audience.

---

## GROUP DISCUSSION

---



### TIPS FOR ANSWERING/FACILITATING DISCUSSION

- Establish ground rules for discussion, eg, everyone should listen respectfully; don't interrupt; only one person speaks at a time; no one's ideas should be made fun of; you can disagree with ideas but not with the person; try to understand others as much as you hope they understand you; etc.
- Sit the group in a circle, making sure all cadets can be seen by everyone else.
- Ask questions that will provoke thought; in other words avoid questions with yes or no answers.
- Manage time by ensuring the cadets stay on topic.
- Listen and respond in a way that indicates you have heard and understood the cadet. This can be done by paraphrasing their ideas.
- Give the cadets time to respond to your questions.
- Ensure every cadet has an opportunity to participate. One option is to go around the group and have each cadet answer the question with a short answer. Cadets must also have the option to pass if they wish.
- Additional questions should be prepared ahead of time.

### SUGGESTED QUESTIONS

- Q1. How can voice be varied to maintain class interest?
- Q2. How does physical presence affect how a message is received?
- Q3. What is one of the most important elements of deportment?
- Q4. What are some ways for controlling nervousness?



Other questions and answers will develop throughout the group discussion. The group discussion should not be limited to only those suggested.



Reinforce those answers given and comments made during the group discussion, ensuring the teaching point has been covered.

## Teaching Point 2

## Explain the Expectations of the One-Minute Verbal Presentation

Time: 10 min

Method: Interactive Lecture

### EXPECTATIONS OF THE ONE-MINUTE VERBAL PRESENTATION

The expectations of the one-minute verbal presentation are to practice the following skills:

1. using effective speaking techniques to communicate ideas; and
2. speaking clearly and confidently in front of a group of peers.

#### Instructions

1. Each cadet is required to deliver a one-minute verbal presentation on a topic chosen from the list located at Annex AD.
2. Each cadet is permitted to use one piece of paper not larger than 8 1/2 inches by 11 inches for outline notes. Cadets are not permitted to read their presentations directly from the paper.
3. Cadets will not be given assistance during their presentations other than the signal from the timekeeper.
4. Cadets will be given feedback using the feedback form located at Annex AE. The feedback positively emphasizes what the cadet did well and areas for improvement.
5. Aids such as a podium, OHP or flip charts should be made available (where possible), if requested by the cadet, prior to the presentation.
6. A timekeeper will be present to signal the cadet when they are nearing the one-minute mark.



Hand out the list of topics located at Annex AD and have the cadets choose what topic they will speak about.

Hand out the Verbal Presentation Feedback Form located at Annex AE to each cadet and discuss how it will be used.

### CONFIRMATION OF TEACHING POINT 2

#### QUESTIONS

Q1. What is the aim of the one-minute verbal presentation?

Q2. When should aids required for the presentation be requested?

### ANTICIPATED ANSWERS

A1. To practice the skills for effectively communicating ideas by speaking clearly and confidently.

A2. Prior to the presentation.

---

### Teaching Point 3

### Conduct an Activity Where the Cadets Will Deliver a One-Minute Verbal Presentation

Time: 25 min

Method: Practical Activity

---



This activity should be conducted on a separate training night from TP 1 & 2 to allow the cadets an opportunity to prepare their verbal presentations.

---

### ACTIVITY

---

#### OBJECTIVE

The objective of this activity is to have the cadets deliver a one-minute verbal presentation.

#### RESOURCES

- Presentation aids (eg, whiteboard/flip chart/OHP) appropriate for the classroom/training area,
- Other presentation aids as requested by the cadets, and
- Verbal Presentation Feedback Form.

#### ACTIVITY LAYOUT

N/A.

#### ACTIVITY INSTRUCTIONS



During the activity:

- Use the Verbal Presentation Feedback Form located at Annex AE to record feedback on what the cadet has done well and areas for improvement.
- Ensure that the requested presentation aids are available prior to the start of the activity.
- Ensure that a timekeeper is present to signal the cadets when they near the one-minute mark. If the cadets go over time, note this in their feedback. Abruptly cutting them off may be more damaging than the negative feedback.

1. Brief the cadets on the following instructions for this activity:
  - (a) Each cadet is required to deliver a one-minute verbal presentation on a chosen topic.
  - (b) Each cadet is permitted to use one piece of paper not larger than 8 1/2 inches by 11 inches for outline notes. Cadets are not permitted to read their presentations directly from the paper.



- (c) No assistance will be provided.
2. Determine the order in which the cadets will deliver their presentations.
  3. Have each cadet deliver a presentation. At the end of the presentation, provide one-on-one feedback to the cadet using the Verbal Presentation Feedback Form. Have the next cadet prepare for their presentation while the one-on-one feedback interview is in progress.



Instructions for the one-on-one feedback interview:

1. Conduct in a private setting.
2. Put the cadet at ease.
3. Ask how they think they did.
4. Ask what they think went well. Discuss two positive points about their presentation.
5. Ask what they think needs improvement. Discuss two areas for improvement.
6. Finish the feedback interview on a positive note.

Positive feedback is essential and should take into account that this may be the first time the cadet has delivered a prepared presentation in front of a group.

4. Continue until all the cadets have had the opportunity to present.
5. Summarize the common feedback for the group and discuss how to improve the presentations.



It is essential that the cadets leave the lesson with a positive attitude.

### SAFETY

N/A.

---

### CONFIRMATION OF TEACHING POINT 3

---

The cadets' participation in a one-minute verbal presentation will serve as confirmation for this TP.

---

### END OF LESSON CONFIRMATION

---

The cadets' participation in a one-minute verbal presentation will serve as confirmation for this lesson.

---

### CONCLUSION

---

### HOMEWORK/READING/PRACTICE

N/A.

**METHOD OF EVALUATION**

N/A.

**CLOSING STATEMENT**

Practicing effective speaking techniques in front of peers will build self-confidence and develop presentation skills needed for instructing cadets.

**INSTRUCTOR NOTES/REMARKS**

TP 3 should be scheduled on a separate training night after TPs 1 and 2 have been conducted.

This EO should be scheduled after EO M309.03 (Describe Effective-Speaking Techniques, Section 3) and before EO M309.06 (Plan a Lesson, Section 6).

---

**REFERENCES**

---

C0-192 (ISBN 0-9695066-2-7) Bender, P. (2000). *Secrets of Power Presentations*. Toronto, ON: The Achievement Group.



**COMMON TRAINING  
SILVER STAR  
INSTRUCTIONAL GUIDE**



**SECTION 9  
EO C309.02 – PLAN A LESSON**

---

Total Time:

60 min

---

**THERE IS NO INSTRUCTIONAL GUIDE PROVIDED FOR THIS EO.**

THIS PAGE INTENTIONALLY LEFT BLANK



**COMMON TRAINING  
SILVER STAR  
INSTRUCTIONAL GUIDE**



**SECTION 10  
EO C309.03 – INSTRUCT A 15-MINUTE LESSON**

---

Total Time:

60 min

---

**THERE IS NO INSTRUCTIONAL GUIDE PROVIDED FOR THIS EO.**

THIS PAGE INTENTIONALLY LEFT BLANK



**COMMON TRAINING  
SILVER STAR  
INSTRUCTIONAL GUIDE**



**SECTION 11**

**EO C309.04 – IDENTIFY FORMATIONS FOR DRILL INSTRUCTION**

Total Time:

30 min

---

**PREPARATION**

---

**PRE-LESSON INSTRUCTIONS**

Resources needed for the delivery of this lesson are listed in the lesson specification located in A-CR-CCP-703/PG-001, Chapter 4. Specific uses for said resources are identified throughout the instructional guide within the TP for which they are required.

Review the lesson content and become familiar with the material prior to delivering the lesson.

**PRE-LESSON ASSIGNMENT**

N/A.

**APPROACH**

An interactive lecture was chosen for TP 1 to introduce the formations used for drill instruction.

A demonstration was chosen for TP 2 as it allows the instructor to demonstrate the procedures for forming a hollow square and reforming the squad.

---

**INTRODUCTION**

---

**REVIEW**

N/A.

**OBJECTIVES**

By the end of this lesson the cadet shall have identified the formations for drill instruction.

**IMPORTANCE**

It is important for cadets to identify formations for drill instruction to be able to select the most effective formation for the lesson being taught. The choice of formation is important because it allows all of the cadets to see the instructor.

---

**Teaching Point 1****Describe the Formations for Drill Instruction**

Time: 5 min

Method: Interactive Lecture

---

**FORMATIONS FOR DRILL INSTRUCTION**

The choice of formation is important because it allows all of the cadets to see the instructor. The three formations that are recommended are a single file, a semicircle and a hollow square.

**Single File.** Used for groups of five cadets or less which can form up into one rank.

**Semicircle.** Used for groups of six to nine cadets which can be formed up in two ranks. There is no formal drill command for forming a semicircle.

**Hollow Square.** Used for groups of 10 or more cadets which are formed up in three ranks.

---

**CONFIRMATION OF TEACHING POINT 1**

---

**QUESTIONS**

- Q1. When is a single file formation used?
- Q2. What formation should be used for a squad in two ranks?
- Q3. How many ranks must the squad be in to form a hollow square?

**ANTICIPATED ANSWERS**

- A1. Groups of five cadets or less.
- A2. Semicircle.
- A3. Three ranks.
- 

**Teaching Point 2****Demonstrate the Procedure for Forming a Hollow Square and Reforming a Squad**

Time: 20 min

Method: Demonstration

---



Proper drill movements shall be combined with a professional demeanour throughout the period of instruction.

Check for faults and correct them immediately when they occur.



Capitalization indicates the words of command for each movement.



## FORM HOLLOW SQUARE



The squad shall be in line in three ranks prior to forming the hollow square.

The following procedure is used to form a hollow square (as illustrated in Figure 9-11-1):

1. On the command FORM HOLLOW SQUARE, CENTRE RANK RIGHT, REAR RANK LEFT-TURN, the squad acts as ordered.
2. On the command CENTRE RANK LEFT WHEEL, REAR RANK RIGHT WHEEL, QUICK-MARCH, the squad acts as ordered.
3. The command MARK-TIME shall be given when the rear individuals of the centre and rear ranks are one pace in front of the front rank.
4. On the command SQUAD-HALT, the squad acts as ordered.
5. On the command CENTRE RANK LEFT, REAR RANK RIGHT-TURN, the squad acts as ordered.



Where new cadets may not yet know the movements listed for the forming of a hollow square, instructors should give instructions such as: "*Centre rank turn to your right, rear rank turn to your left*" and then guide the cadets into the correct formation. The use of drill commands where the cadets are unaware of the actions they should take will only serve to create a negative atmosphere for the class.

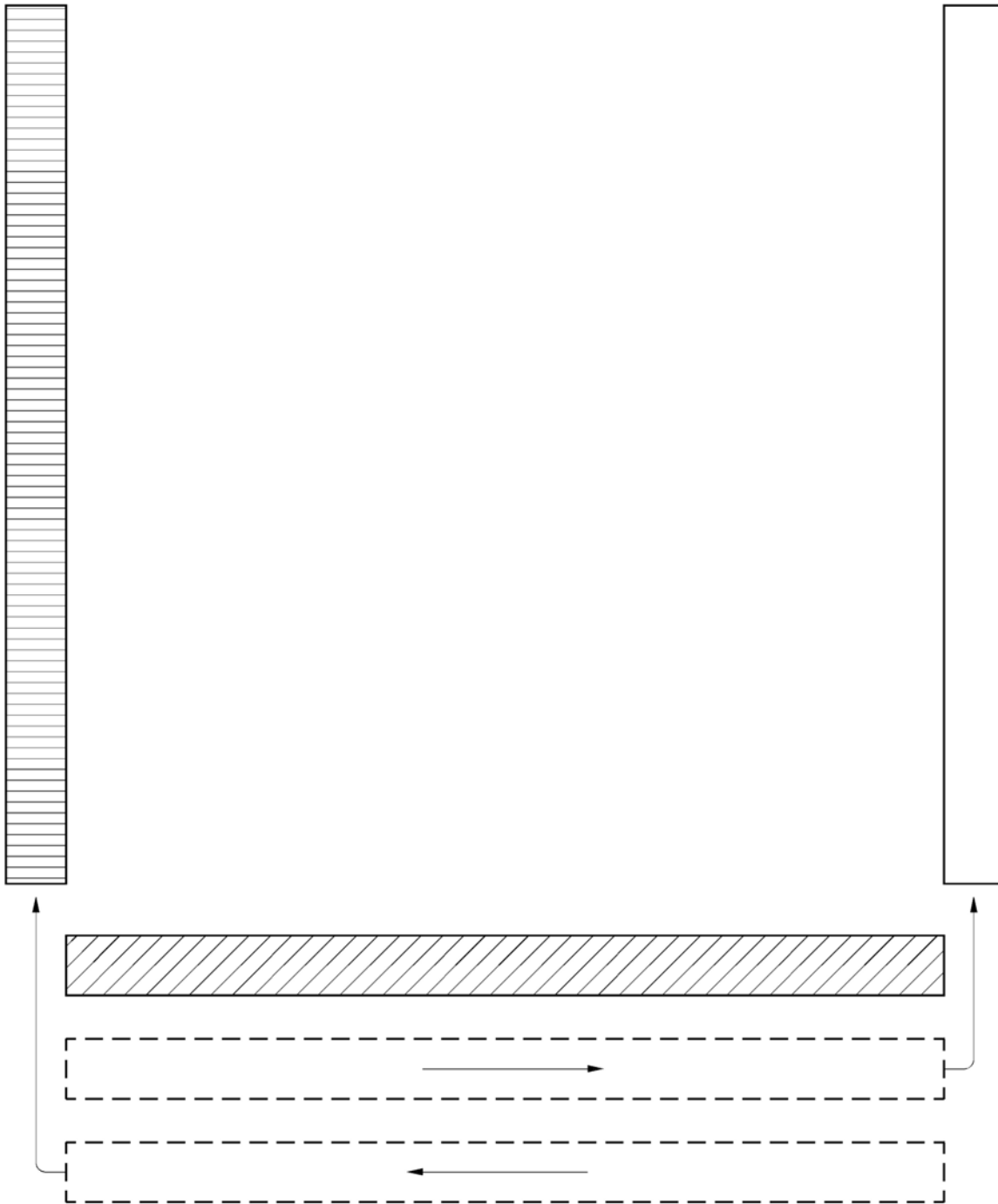

*A-PD-201-000/PT-000, The Canadian Forces Manual of Drill and Ceremonial (p. 3-23)*

Figure 9-11-1 Forming a Hollow Square

**REFORM THREE RANKS**



The reverse procedure to forming a hollow square is used to reform a squad into three ranks.

The following procedure is used to reform three ranks:

1. On the command REFORM THREE RANKS, CENTRE RANK LEFT, REAR RANK RIGHT–TURN, the squad acts as ordered.
2. On the command CENTRE RANK RIGHT WHEEL, REAR RANK LEFT WHEEL, QUICK–MARCH, the squad acts as ordered.
3. The command MARK–TIME shall be given when the squad has reformed three ranks.
4. On the command SQUAD–HALT, the squad acts as ordered.
5. On the command CENTRE RANK RIGHT, REAR RANK LEFT–TURN, the squad acts as ordered.



If time permits, have the cadets practice forming a hollow square with their peers. Simulate three ranks for groups less than 10 cadets.

---

### CONFIRMATION OF TEACHING POINT 2

---

#### QUESTIONS

- Q1. How must a squad be formed before forming a hollow square?
- Q2. When should the instructor give the command to mark time when forming a hollow square?
- Q3. What procedure is used to reform three ranks?

#### ANTICIPATED ANSWERS

- A1. In three ranks.
- A2. The rear individuals of the centre and rear ranks are one pace in front of the front rank.
- A3. The reverse procedure to forming a hollow square.

---

### END OF LESSON CONFIRMATION

---

#### QUESTIONS

- Q1. What three formations are used for drill instruction?
- Q2. What formation should be used for a group of seven cadets?
- Q3. How many cadets are needed to form a hollow square?

#### ANTICIPATED ANSWERS

- A1. Single file, semicircle and hollow square.
- A2. Semicircle.
- A3. 10 or more.

---

**CONCLUSION**

---

**HOMEWORK/READING/PRACTICE**

N/A.

**METHOD OF EVALUATION**

N/A.

**CLOSING STATEMENT**

Drill instruction requires the instructor to demonstrate each individual squad of a movement so the cadets can see what is expected. The choice of formation is important because it allows all of the cadets to see the instructor.

**INSTRUCTOR NOTES/REMARKS**

N/A.

---

**REFERENCES**

---

A0-002 A-PD-201-000/PT-000 Director History and Heritage 3-2. (2005). *The Canadian Forces Manual of Drill and Ceremonial*. Ottawa, ON: Department of National Defence.



**COMMON TRAINING  
SILVER STAR  
INSTRUCTIONAL GUIDE**



**SECTION 12  
EO C309.05 – PLAN A DRILL LESSON**

---

Total Time:

60 min

---



---

**PREPARATION**

---

**PRE-LESSON INSTRUCTIONS**

Resources needed for the delivery of this lesson are listed in the lesson specification located in A-CR-CCP-703/PG-001, Chapter 4. Specific uses for said resources are identified throughout the instructional guide within the TP for which they are required.

Review the lesson content and become familiar with the material prior to delivering the lesson.

Photocopy Annexes AF to AI for each cadet.

Photocopy the lesson specifications and instructional guides located at Annexes AJ to AP as required.

**PRE-LESSON ASSIGNMENT**

N/A.

**APPROACH**

An interactive lecture was chosen for TPs 1 and 2 to present the drill instruction sequence and to stimulate an interest in planning a drill lesson.

A practical activity was chosen for TP 3 to guide the cadets through the process of planning a drill lesson.

---

**INTRODUCTION**

---

**REVIEW**

N/A.

**OBJECTIVES**

By the end of this lesson the cadet shall have identified the drill instruction sequence and written a drill lesson plan.

**IMPORTANCE**

It is important for cadets to know the essential elements of a drill lesson and be able to develop a written drill lesson plan as it allows them to be better prepared to deliver drill instruction. Drill that is well taught and executed develops individual pride, mental alertness, precision and esprit de corps.

---

**Teaching Point 1****Describe the Drill Instruction Sequence**

Time: 10 min

Method: Interactive Lecture

---

**INTRODUCTION**

The lesson shall be introduced as follows:

1. Order the squad into a suitable formation such as a single rank, hollow square or semicircle.
2. Review the previous lesson.
3. Describe the new movement.
4. Describe why it is important to learn the movement.
5. Describe where and when the movement will be used.
6. Describe how the cadets will be assessed.

**BODY**

The lesson shall be taught using the following process:

1. Demonstrate the complete movement, calling out the time.
2. Explain the complete movement.
3. Demonstrate the first part of the movement.
4. Explain the first part of the movement.
5. Give the squad the opportunity to ask questions.
6. Practice the first movement (collectively, individually, collectively) (as illustrated in Figure 9-12-1).
7. Demonstrate and explain the second part of the movement and any subsequent parts of the movement following Steps 3. to 6.
8. Give two complete demonstrations.
9. Practice the complete movement with:
  - (a) the instructor calling the time;
  - (b) the squad calling the time; and
  - (c) the squad judging the time.

**DEMONSTRATE THE COMPLETE MOVEMENT WITH TIMING**

The instructor shall provide a complete demonstration of the drill movement, with timing. A practiced assistant instructor may carry out this demonstration.

The demonstration shall be provided from various vantage points, as required.

**DEMONSTRATE FIRST PART OF MOVEMENT (FIRST NUMBER)**

For ease of instruction, drill commands have been broken down into individual movements, or numbers. The instructor(s) shall demonstrate and explain each number.

In order to adopt the position of attention from stand at ease, the cadet shall:

On the command ATTENTION BY NUMBERS, SQUAD—ONE, bend the left knee and shift the balance to the right foot.

**PRACTICE THE SQUAD ON THE FIRST MOVEMENT**

Practice the squad on the first movement collectively, individually and collectively.

*Director Cadets 3, 2008, Ottawa, ON: Department of National Defence*

Figure 9-12-1 Drill Instruction Sequence

**END OF LESSON CONFIRMATION**

The end of lesson confirmation must meet the following criteria:

1. It shall be a performance of the movement taught.
2. It shall be conducted as a squad.
3. It will emphasize any aspects of the movement that the cadets experienced difficulty with during the lesson.

**CONCLUSION**

The lesson shall be summarized as follows:

1. Restate the movement taught and where or when it will be used;
2. Re-motivate the cadets by:
  - (a) commenting on the cadets' progress; and
  - (b) re-stating why the drill movement just learned is important.
3. Describe the next lesson.

---

**CONFIRMATION OF TEACHING POINT 1**

---

**QUESTIONS**

- Q1. Describe one action an instructor shall take during the introduction of a drill lesson.
- Q2. List the sequence for practicing drill movements.

Q3. What shall an instructor do in the conclusion of a drill lesson?

**ANTICIPATED ANSWERS**

A1. During the beginning of a drill lesson, an instructor shall:

- (1) Order the squad into a suitable formation.
- (2) Review the previous lesson.
- (3) Describe the new movement.
- (4) Describe why it is important to learn it.
- (5) Describe where and when the movement will be used.
- (6) Describe how the cadets will be assessed.

A2. The sequence for practicing drill movements is to practice the squad collectively, individually, collectively.

A3. In the conclusion the instructor shall:

- (1) Restate the movement taught and where or when it will be used.
- (2) Re-motivate the cadets by commenting on the cadets' progress and by re-stating the reason for learning the movement.
- (3) Describe the next lesson.

---

**Teaching Point 2**

**Review the Lesson-Planning Process**

Time: 10 min

Method: Interactive Lecture

---

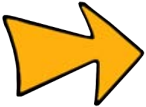

Before beginning the activity for planning a drill lesson, review the lesson-planning process taught in M309.06 (Plan A Lesson, Section 6) summarized below.



Distribute the lesson plan handout located at Annex AF to each cadet.

**THE LESSON-PLANNING PROCESS**

The Canadian Forces employs an initialism that is used to provide a framework for the instructor to gather and organize the reference material into an efficient and practical lesson plan. The initialism is CCSAM.

**Collect.** During this step, the instructor researches the material to be covered in the period of instruction using course documents such as the lesson specification, IG and listed references. In situations where no course documents exist, the instructor will research the material to be taught using whatever references exist.

**Consider.** During this step, the instructor sifts through all of the material found in the collection step and determines what is relevant and current.

**Select.** During this step, the instructor selects the material that is appropriate for the lesson. The instructor also selects the method of instruction to be used.



**Arrange.** During this step, the instructor arranges the material into stages that allow for the information to be presented in a logical sequence.

**Master.** During this step, the instructor writes the lesson plan.

## LESSON SPECIFICATION

Lesson specifications are found in Chapter 4 of the Qualification Standard and Plan (QSP). The two sections of a lesson specification are the enabling objective (EO) and the lesson specification.

### Enabling Objective

The EO is the first three paragraphs of the lesson specification and will answer three questions:

- What will the cadet be expected to be able to do by the end of this lesson?
- Under what conditions will the cadet be expected to carry out the performance?
- How well or to what standard will the cadet be expected to perform?

### Lesson Specification

The lesson specification, (paragraphs 4. to 11.), contains information about:

- the content to be taught broken down into teaching points;
- the teaching method(s) to be used and why they were chosen;
- the time for each teaching point (TP);
- the references used;
- the training aids to be used;
- the learning aids to be used;
- the test details; and
- remarks for the instructor.

## INSTRUCTIONAL GUIDE (IG)

The IG is used in conjunction with the QSP and other resources to conduct training. IGs should be reviewed in conjunction with lesson specifications so that the instructor can adequately plan and prepare their lesson. The following are the six sections of an IG:

**Preparation.** This section provides information to the instructor regarding:

- pre-lesson instructions;
- pre-lesson assignment; and
- instructional approach or method.

**Introduction.** This section provides information to the instructor regarding:

- any review that may be necessary;
- what the cadet will be expected to do by the end of the lesson; and
- why the knowledge/skill is important.

**Body.** This section provides information to the instructor regarding:

- the TPs and their content as listed in paragraph 4. of the lesson specification in greater detail;
- suggested teaching methods;
- note boxes with special instructions or information;
- lesson content;
- figures;
- activities; and
- confirmation questions or activities.

**Conclusion.** This section provides information to the instructor regarding:

- any homework/reading/practice that may be required of the cadet;
- the method of evaluation to be used as stated in the lesson specification;
- a closing statement to be spoken aloud to the cadet; and
- any additional instructor notes/remarks.

**References.** This section lists the sources of information used to create the lesson specification and instructional guide.

**Annexes.** This section contains background information for the TPs, pre-made instructional aids and additional information for activities.

---

## CONFIRMATION OF TEACHING POINT 2

---

### QUESTIONS

- Q1. List the five parts of the lesson-planning process.
- Q2. What is included in the EO portion of a lesson specification?
- Q3. What are the six sections of an instructional guide?

### ANTICIPATED ANSWERS

- A1. The five parts of the lesson planning process are collect, consider, select, arrange and master.
- A2. The information included in the EO is what the cadet will be expected to learn, what materials, supervision and equipment will be available to the cadet and what standard the cadet will be expected to achieve.
- A3. The six sections of an IG are preparation, introduction, body, conclusion, references and annexes.

---

### Teaching Point 3

### Supervise and Provide Assistance While the Cadets Plan a Drill Lesson

Time: 30 min

Method: Practical Activity

---

In EO C309.06 (Instruct a 15-Minute Drill Lesson, Section 13), the cadets shall be expected to instruct a drill lesson using a lesson plan, the drill instruction sequence and the appropriate drill formation. The lesson plan created in this EO will be used to instruct that drill lesson.



Distribute the blank lesson plan located at Annex AG and the plan a drill lesson checklist located at Annex AH to each cadet.

---

## ACTIVITY

---

### OBJECTIVE

The objective of this activity is to have the cadets plan a 15-minute drill lesson.

### RESOURCES

- List of approved 15-minute drill topics located at Annex AI, and
- Modified lesson specifications and instructional guides located at Annexes AJ to AP.

### ACTIVITY LAYOUT

N/A.

### ACTIVITY INSTRUCTIONS

1. Have each cadet choose a topic from the list of approved 15-minute drill topics.
2. Have the cadets use the lesson specification and IG for their chosen topic to help develop their drill lesson plan. Cadets shall be expected to teach their chosen lesson as part of C309.06 (Instruct a 15-Minute Drill Lesson, Section 13).
3. Circulate around the room facilitating the activity and helping the cadets as required.



Ensure that cadets request all resources required to instruct their lesson.

### SAFETY

N/A.

---

### CONFIRMATION OF TEACHING POINT 3

---

The cadets' participation in the activity will serve as the confirmation of this TP.

---

### END OF LESSON CONFIRMATION

---

The cadets' planning a drill lesson will serve as the confirmation of this lesson.

---

## CONCLUSION

---

### HOMEWORK/READING/PRACTICE

The cadets shall be prepared to instruct their lesson at the beginning of C309.06 (Instruct a 15-Minute Drill Lesson, Section 13)

### METHOD OF EVALUATION

N/A.

### CLOSING STATEMENT

Instructors must continually work to improve the quality of instruction. Being able to plan drill lessons is a critical step in boosting the instructor's confidence and improving the quality of drill instruction.

### INSTRUCTOR NOTES/REMARKS

EO C309.05 (Plan a Drill Lesson) should be scheduled at least one week prior to EO C309.06 (Instruct a 15-Minute Drill Lesson, Section 13).

---

## REFERENCES

---

A0-002 A-PD-201-000/PT-000 Director History and Heritage 3-2. (2005). *The Canadian Forces Manual of Drill and Ceremonial*. Ottawa, ON: Department of National Defence.



**COMMON TRAINING**  
**SILVER STAR**  
**INSTRUCTIONAL GUIDE**



**SECTION 13**

**EO C309.06 – INSTRUCT A 15-MINUTE DRILL LESSON**

---

Total Time:

90 min

---

**PREPARATION**

---

**PRE-LESSON INSTRUCTIONS**

Resources needed for the delivery of this lesson are listed in the lesson specification located in A-CR-CCP-703/PG-001, Chapter 4. Specific uses for said resources are identified throughout the instructional guide within the TP for which they are required.

Review the lesson content and become familiar with the material prior to delivering the lesson.

Photocopy the Drill Instructional Techniques Assessment Form located at Annex AQ for each cadet.

Ensure that all resources requested by the cadets are available.

**PRE-LESSON ASSIGNMENT**

N/A.

**APPROACH**

A practical activity was chosen for this lesson as it is an interactive way for cadets to develop drill instructional skills in a safe and controlled environment.

---

**INTRODUCTION**

---

**REVIEW**

N/A.

**OBJECTIVES**

By the end of this lesson the cadet shall have instructed a 15-minute drill lesson using a written lesson plan and the drill instruction sequence.

**IMPORTANCE**

It is important for cadets to instruct a 15-minute drill lesson as it gives them the opportunity to practice drill instructional skills in a peer setting and to receive feedback to further develop instructional skills and confidence.

**Teaching Point 1****Supervise While the Cadets Instruct a 15-Minute Drill Lesson**

Time: 85 min

Method: Practical Activity

**ACTIVITY**

Time: 85 min

**OBJECTIVE**

The objective of this activity is to have cadets instruct a 15-minute drill lesson in a peer setting using a written lesson plan and the drill instruction sequence.

**RESOURCES**

Drill Instructional Techniques Assessment Form.

**ACTIVITY LAYOUT**

N/A.

**ACTIVITY INSTRUCTIONS**

1. Have the cadets provide a copy of their lesson plan to the assessor.
2. Determine the order in which cadets will instruct their lessons.
3. Have one cadet form up the squad for their drill lesson.
4. Have one cadet instruct a 15-minute drill lesson using a written lesson plan and the drill instruction sequence (as prepared in EO C309.05 [Plan a Drill Lesson, Section 12]).
5. Assess the cadet's lesson using the Drill Instructional Techniques Assessment Form.
6. Upon completion of the lesson, provide feedback to the cadet.
7. Repeat Steps 3. to 6. until all cadets have instructed a lesson.



The Drill Instructional Techniques Assessment Form located at Annex AQ is used to provide feedback on the cadet's lesson and to introduce the cadet to the type of instructional techniques assessment they will receive in their future star level training. The form is intended solely for the purposes of assessment for learning, providing the cadets with the feedback they need to improve upon their own skills.

8. Debrief the cadets by providing feedback, focusing on:
  - (a) best practices,
  - (b) general trends and key areas for improvement, and
  - (c) re-motivation, highlighting the effort and accomplishments of the group.



If the group of cadets is large, divide them up into smaller groups and assign other instructors to aid with assessment and feedback.

## SAFETY

N/A.

---

## CONFIRMATION OF TEACHING POINT 1

---

The cadets' participation in the activity will serve as the confirmation of this TP.

---

## END OF LESSON CONFIRMATION

---

The cadet's instructing a 15-minute drill lesson will serve as the confirmation of this lesson.

---

## CONCLUSION

---

## HOMEWORK/READING/PRACTICE

N/A.

## METHOD OF EVALUATION

N/A.

## CLOSING STATEMENT

Practicing drill instructional skills in a peer setting allows for the development of fundamental skills necessary to become a drill instructor while further developing confidence and providing a sense of accomplishment.

## INSTRUCTOR NOTES/REMARKS

This EO shall be conducted after EO C309.04 (Identify Formations for Drill Instruction, Section 11) and EO C309.05 (Plan a Drill Lesson, Section 12).

Additional time may be required for class sizes greater than five cadets.

---

## REFERENCES

---

A0-002 A-PD-201-000/PT-000 Director Heritage and History 3-2 (2005). *The Canadian Forces Manual of Drill and Ceremonial*. Ottawa, ON: Department of National Defence.

THIS PAGE INTENTIONALLY LEFT BLANK



## PRINCIPLES OF INSTRUCTION INFORMATION SHEET

### INTEREST

Cadets are more receptive to learning when they are curious and have an emotional connection to a topic. The instructor must arouse, create and maintain the interest of the cadets. Without interest, the cadets will be less inclined to listen and will not learn.

- **Principle.** People learn when they are interested in the material or skill.
- **Action.** Instructors must arouse, create and maintain the cadets' interest. The instructor should employ imaginative means to keep curiosity, while taking into account experience and interests.

Ensure Interest	Technique
Information	Inform the cadets why they are learning the skill or knowledge. Explain all of the benefits of this new knowledge or skill.
Enthusiasm	Show enthusiasm. Smile and have fun. Make eye contact. Vary the pitch, resonance, articulation, speed, volume, inflection and rhythm of your speech.
Variety	Use more than one instructor. Use verbal support to back up a statement or to clarify an idea. Use a variety of different training aids. Try different teaching methods.
Realism	Try a different location for your class. If you are teaching judging distance then take your cadets out to a field and place items at different intervals.
Participation	Involve the cadets by asking questions. Ensure cadets participate early in a skill lesson. Use speed and/or ability competitions or games to reinforce learning.

## COMPREHENSION

Comprehension or understanding relates to the cadet's ability to understand the material taught. The cadets' readiness to learn new material is influenced by what has previously been taught; new content should not exceed the knowledge level of the cadets. If the cadets do not understand, they are unable to learn.

- **Principle.** People learn when instruction starts at their level of understanding and proceeds at the rate of their comprehension.
- **Action.** Instructors must determine the cadet's level of knowledge and only progress with new material when the cadets have full understanding of the material previously taught.

<b>Ensure Comprehension</b>	<b>Technique</b>
Research	Examine the Qualification Standard and Plan (QSP) to determine what material the cadets have already been taught.
Plan	Organize lesson material in a logical order. Proceed from the known to the unknown. Move from simple material to the more difficult.
Question	Ask review questions at the start of the lesson to determine the level of understanding. Continue to ask questions throughout the lesson to ensure understanding. Assure cadets early in the lesson that questions are welcome.
Observe	Watch for expressions of body language that may indicate difficulty with parts of the lesson. Observe cadets when they practice a skill and correct error as they occur.

## EMPHASIS

During a period of instruction there will be some information, which may be of particular importance. The instructor can emphasize this important information through the use of voice control, training aids and in-class activities.

- **Principle.** People retain more important information when the instructor uses repetition and emphasis.
- **Action.** Instructors must stress essential points.

<b>Ensure Emphasis</b>	<b>Technique</b>
Process	Teach the material step by step. Re-cap each area (stress key points). Have the cadets take notes.
In-Class Review	Review the key points from the past lesson. Repeat the key points during the lesson.
Reinforcement	For a knowledge lesson, ask questions on the key points. For a skill lesson, allow sufficient practice time for the cadets to ask questions and receive corrective action. Do not over demonstrate. Try saying "This is important, remember it." Use verbal support by giving examples, to include: <ul style="list-style-type: none"> <li>• comparisons,</li> <li>• reasons,</li> <li>• restatement and repetition,</li> <li>• examples,</li> <li>• statistics, and</li> <li>• testimonials.</li> </ul> Use training aids.
Post Lesson	Distribute handouts covering key points.

**PARTICIPATION**

Cadets are more likely to retain information if they are both mentally and physically involved in learning. The instructor should conduct activities that contain action, activity and excitement. Cadets Learn by doing.

- **Principle.** People learn best when they have an opportunity to participate actively in the learning process. People learn by doing.
- **Action.** The instructor creates class participation in the form of a physical or mental activity.

<b>Ensure Participation in a Knowledge Lesson</b>	<b>Technique</b>
Involvement	Ask open-ended questions that will encourage individual thought and generate a discussion.
Group Work	Select teaching methods that allow the cadets to share ideas and knowledge.
Learning Activity	Organize teaching points to contain such things as: <ul style="list-style-type: none"> <li>• puzzles,</li> <li>• crosswords,</li> <li>• trivia games,</li> <li>• board games,</li> <li>• word searches,</li> <li>• discussions,</li> <li>• case studies,</li> <li>• competitions,</li> <li>• experiments, or</li> <li>• problem solving.</li> </ul>
Application	Allow the cadets to apply the knowledge through case studies and problem-based learning.

<b>Ensure Participation in a Skill Lesson</b>	<b>Technique</b>
Involvement	Ensure early involvement by cadets. Have as many cadets as possible working on the skills at the same time.
Practice	Ensure ample practice time. Maintain close supervision during practice

<b>Ensure Participation in a Skill Lesson</b>	<b>Technique</b>
Detection and Correction	Be aware of commonly made errors while practicing a new skill. Observe cadets closely when they practice a skill. Correct errors as they occur. Correct one error at a time.
Competition	Allow the cadets to practice new skills by conducting friendly competitions and contests.

## ACCOMPLISHMENT

The lesson must impart a sense of accomplishment to each cadet. The cadets should leave the class with the satisfaction that they were able to achieve something in the lesson.

- **Principle.** People learn most effectively when their performance results in a sense of accomplishment.
- **Action.** The instructor must tell the cadets what they are doing well and what needs improvement. The objective is to offer feedback that will reinforce desired performance and correct undesired performance.

<b>Ensure Accomplishment</b>	<b>Technique</b>
Expectations	Inform cadets of the lesson objectives. Ensure the cadets understand what will be expected of them at the end of the lesson.
Learner Satisfaction	Explain lessons clearly using simple words. The cadets will learn easily creating fulfillment.
Learner Responsibility	Keep cadets informed of their progress. Just by saying “Now that you have all correctly tied the reef knot, let’s practice the bowline” will indicate the cadets’ progress.
Encouragement	Reassure cadets that they will be successful. Compliment cadets on work that is well done.
Perseverance	Encourage cadets who may be having difficulty. Allow cadets to practice skills they have difficulty with. Offer extra help if necessary.

## CONFIRMATION

Confirmation is an essential part of learning and instructing. It gives both the instructor and the cadet the opportunity to see how well the information is understood.

- **Principle.** Confirm that learning has occurred and knowledge has been retained.
- **Action.** Instructors must confirm that the cadets' learning meets established standards and ensure that the skills can be performed safely and competently.

<b>Ensure Confirmation</b>	<b>Technique</b>
Practice	Observe as the cadets practice the skills.
Exercise	Have the cadets perform the skill. If you are teaching cadets how to ascend and descend hills when mountain biking, watch each cadet as they demonstrate the skill. Anyone who cannot do it may need extra instruction.  Provide exercises or guide discussions that stress the key points of the lesson.
Questions	Ask questions at the end of the lesson to assess how well the cadets are learning.  Listen carefully to the cadets' answers. You may be able to identify weak areas that may need to be re-taught.
Assignments	Review assignments completed outside class to determine the extent of learning.
Tests	Conduct confirmation for teaching points and enabling checks. This will also reinforce learning.
Observations	Note and provide feedback on cadet behaviour.

THIS PAGE INTENTIONALLY LEFT BLANK









# PRINCIPLES OF INSTRUCTION

# Worksheet

**NAME OF PRINCIPLE:** Participation.

**TOPIC:** How to walk down the stairs.

**TECHNIQUES FOR APPLYING THE PRINCIPLE TO THIS TOPIC:**

---

---

---

---

---

---

---

---

---

---

---

---

---

---

---

---

---

---

---

---

---

---

---

---

# PRINCIPLES OF INSTRUCTION

# Worksheet

**NAME OF PRINCIPLE:** Accomplishment.

**TOPIC:** How to work a zipper.

**TECHNIQUES FOR APPLYING THE PRINCIPLE TO THIS TOPIC:**

---

---

---

---

---

---

---

---

---

---

---

---

---

---

---

---

---

---

---

---

---

---

---

# PRINCIPLES OF INSTRUCTION

# Worksheet

**NAME OF PRINCIPLE:** Confirmation.

**TOPIC:** How to throw a ball.

**TECHNIQUES FOR APPLYING THE PRINCIPLE TO THIS TOPIC:**

---

---

---

---

---

---

---

---

---

---

---

---

---

---

---

---

---

---

---

---

---

---

---

---

**METHODS OF INSTRUCTION**

**INTERACTIVE LECTURE**

Description	Pre-Lesson Preparation	Typical Applications	Lesson Development
<p>Interactive lecture is an instructor-driven method, which combines both lecture and interaction to meet lesson objectives. The lecture portions of the lesson are offset with relevant activities such as videos with discussion, games, learning stations, brainstorming, debating, group work or the completion of handouts.</p>	<p>Use attention-getters such as interesting facts, statistics or rhetorical questions to begin the lecture or to introduce new teaching points.</p> <p>Prepare participatory questions to encourage cadet participation.</p> <p>Prepare evaluative questions for confirmation of teaching points.</p> <p>Obtain or develop training aids to clarify main points.</p> <p>Prepare an in-class activity to avoid lecturing too long.</p> <p>Practice delivering the material.</p>	<p>Interactive lectures can be used with different sizes of groups to:</p> <ul style="list-style-type: none"> <li>• introduce a subject;</li> <li>• present background information;</li> <li>• review previously taught material;</li> <li>• give instructions on procedures;</li> <li>• illustrate the application of rules, principles or concepts; or</li> <li>• introduce a demonstration, discussion or performance.</li> </ul>	<p>Begin the lesson and each new TP with an attention-getter.</p> <p>Use presentation aids such as:</p> <ul style="list-style-type: none"> <li>• flip chart,</li> <li>• whiteboard, and/or</li> <li>• electronic media.</li> </ul> <p>Pay attention to signals of alertness, such as:</p> <ul style="list-style-type: none"> <li>• cadets' facial expressions, and</li> <li>• cadets' body language.</li> </ul> <p>Deal with alertness problems by:</p> <ul style="list-style-type: none"> <li>• asking for questions; and</li> <li>• posing questions to the group.</li> </ul> <p>Use visual training aids at opportune moments.</p> <p>Integrate interesting facts with lesson material to maintain interest.</p> <p>Use participatory questions or a short activity to avoid lecturing too long.</p> <p>Use questions to confirm each teaching point.</p> <p>Confirm the lesson using questions or an activity.</p>

**DEMONSTRATION AND PERFORMANCE**

Description	Pre-Lesson Preparation	Typical Applications	Lesson Development
<p><b>Demonstration and Performance</b></p> <p>During demonstration and performance the cadets observe the instructor performing the task in a demonstration, and rehearse it under the supervision of the instructor.</p> <p><b>Demonstration Method</b></p> <p>A method of instruction where the instructor, by actually performing an operation or doing a job, shows the cadet what to do, how to do it and explains why, where and when it is done.</p> <p><b>Performance Method</b></p> <p>A method in which the cadet is required to perform, under controlled conditions, the operations, skill or movement being taught.</p>	<p>The instructor must be skilled in the task.</p> <p>Gather all materials necessary to instruct the lesson.</p> <p>Break the task down into smaller sequential steps.</p> <p>Practice the lesson to ensure that steps are accurate and clear.</p> <p>Prepare a handout outlining the steps, if necessary.</p> <p>Organize the training area so that all cadets can:</p> <ul style="list-style-type: none"> <li>• see the demonstration, and</li> <li>• perform the task.</li> </ul>	<p><b>Demonstration Method</b></p> <p>Demonstration can be used to:</p> <ul style="list-style-type: none"> <li>• teach hands-on operations or procedures;</li> <li>• teach troubleshooting;</li> <li>• illustrate principles;</li> <li>• teach operation or functioning of equipment;</li> <li>• set standards of workmanship;</li> <li>• explain a theory or concept; or</li> <li>• teach safety procedures.</li> </ul> <p><b>Performance Method</b></p> <p>Performance can be used to:</p> <ul style="list-style-type: none"> <li>• teach hands-on operations or procedures;</li> <li>• teach operation or functioning of equipment;</li> <li>• teach team skills; or</li> <li>• teach safety procedures.</li> </ul>	<p>Introduce the lesson by demonstrating what the cadets will be able to do at the end.</p> <p>Explain where the skill can be applied and why it is important.</p> <p>Provide a handout outlining the steps if the process is complex.</p> <p>Explain and demonstrate each step in a sequential manner.</p> <p>Allow cadets maximum time to practice the steps as soon as possible.</p> <p>Positively reinforce everything the cadets do correctly.</p> <p>Supervise the cadets as they practice, providing assistance or re-demonstrations when necessary.</p> <p>Have cadets perform the skill as confirmation.</p> <p>Encourage the cadets to practice beyond class time.</p>



**IN-CLASS ACTIVITY**

Description	Pre-Lesson Preparation	Typical Applications	Lesson Development
<p>In-class activities encompass a wide variety of activity-based learning opportunities that can be used to reinforce and practice instructional topics or to introduce cadets to new experiences. In-class activities should stimulate interest among cadets and encourage their participation, while maintaining relevance to the performance objectives. Examples of in-class activities include learning stations, videos, brainstorming, debating, and group work.</p>	<p>Create an activity that involves all cadets, which can be conducted within the time allocated.</p> <p>Clearly specify the objective of the activity.</p> <p>Obtain all materials necessary to complete the activity.</p> <p>Write out specific instructions describing what participants are supposed to do.</p> <p>Write out specific directions for conducting the activity.</p> <p>Arrange for assisting staff, if necessary, to help conduct the activity.</p> <p>Prepare handouts for cadets containing background information.</p> <p>Organize the training area into work/learning stations.</p>	<p>An in-class activity can be used for both knowledge and skill lessons to:</p> <ul style="list-style-type: none"> <li>• reinforce instructional objectives;</li> <li>• introduce a subject and generate interest;</li> <li>• present background information;</li> <li>• give direction on procedures;</li> <li>• introduce a demonstration, discussion or performance;</li> <li>• illustrate the application of rules, principles or concepts;</li> <li>• to create interactivity during a lecture; or</li> <li>• to review, clarify or summarize information.</li> </ul>	<p>Introduce the activity to the whole group.</p> <p>Brief participants on what will be expected of them.</p> <p>Stress timings.</p> <p>Ensure all resources are available.</p> <p>Begin the activity.</p> <p>Supervise and assist the groups as required.</p> <p>Conclude the activity.</p> <p>Confirm the TP or lesson.</p> <p>Debrief the cadets.</p>

**PRACTICAL ACTIVITY**

Description	Pre-Lesson Preparation	Typical Applications	Lesson Development
<p>Practical activities encompass a wide variety of activity-based learning opportunities that can be used to reinforce and practice instructional topics or to introduce cadets to new experiences. Practical activities should stimulate interest among cadets and encourage their participation, while maintaining relevance to the performance objective.</p>	<p>The instructor must be skilled in the task.</p> <p>Gather all materials necessary to instruct the lesson.</p> <p>Organize the training area so that all cadets will have space to perform the task safely.</p> <p>Ensure there is enough time to conduct the complete activity or breakdown the task into smaller stages.</p> <p>Prepare a handout outlining the steps, if necessary.</p> <p>Arrange for assisting staff, if necessary.</p> <p>Divide cadets into small groups.</p>	<p>The objective of the practical activity method is to reinforce and practice instructional topics or to introduce the cadets to new experiences.</p> <p>If it is used to teach new material it must be combined with other methods to ensure cadets have the necessary background information to complete the activity.</p> <p>The practical activity method can be used to:</p> <ul style="list-style-type: none"> <li>• carry out an application;</li> <li>• demonstrate a process;</li> <li>• verify an explanation;</li> <li>• produce a product;</li> <li>• introduce a subject;</li> <li>• teach manipulative operations;</li> <li>• teach procedures;</li> <li>• teach troubleshooting;</li> <li>• illustrate principles;</li> <li>• teach equipment operation; or</li> <li>• teach safety.</li> </ul>	<p>Review background information.</p> <p>Distribute the handout, if necessary.</p> <p>Introduce the activity to the group.</p> <p>Stress safety.</p> <p>Brief the cadets on what they will be expected to do.</p> <p>Brief assisting staff on what they will be expected to do.</p> <p>Begin the activity.</p> <p>Supervise the cadets and provide assistance, if necessary.</p> <p>Watch for safety infractions and stop the activity, if necessary.</p> <p>Conclude the activity.</p> <p>Debrief the cadets.</p>

**GAME**

Description	Pre-Lesson Preparation	Typical Applications	Lesson Development
<p>Games are used with one or more participants to practice skills, apply strategies and enhance teams. It is critical that the game supports learning through a challenging activity that allows for skill practice or knowledge confirmation.</p>	<p>Develop a simple game with the following characteristics:</p> <ul style="list-style-type: none"> <li>• fast to play,</li> <li>• easy and quick to organize,</li> <li>• has few rules,</li> <li>• uses minimal equipment, and</li> <li>• involves maximum participation.</li> </ul> <p>If possible use variations of games cadets know from childhood or television.</p> <p>Determine the following when developing the rules of the game:</p> <ul style="list-style-type: none"> <li>• individual or team play,</li> <li>• how to change leaders,</li> <li>• what the leader will do,</li> <li>• what the followers will do,</li> <li>• timings for the game,</li> <li>• how to signal the start and stop of the game,</li> <li>• how to ensure safety.</li> </ul> <p>Obtain the resources needed to play the game.</p> <p>Organize the training area to play the game.</p>	<p>Games create variety and arouse interest but must also support learning.</p> <p>Games can be used to:</p> <ul style="list-style-type: none"> <li>• introduce a topic;</li> <li>• discover concepts and principles;</li> <li>• learn terminology;</li> <li>• recall terms;</li> <li>• recognize equipment parts;</li> <li>• develop strategies and tactics;</li> <li>• carry out an application;</li> <li>• demonstrate a process;</li> <li>• practice interpersonal skills; and/or</li> <li>• confirm learning</li> </ul>	<p>Brief the cadets on the following:</p> <ul style="list-style-type: none"> <li>• the objective of the game, and</li> <li>• rules of the game.</li> </ul> <p>Play the game.</p> <p>Supervise closely to:</p> <ul style="list-style-type: none"> <li>• ensure that the game is played in the manner expected;</li> <li>• ensure that the game is played safely; and</li> <li>• ensure maximum participation.</li> </ul> <p>End the game.</p> <p>Debrief the cadets.</p>

**FIELD TRIP**

Description	Pre-Lesson Preparation	Typical Applications	Lesson Development
<p>Theoretical knowledge is reinforced through participation in an activity in a real-life setting. Prior planning helps to ensure all pre-training and safety standards are met. Field trip activities are planned and carried out to achieve clear instructional objectives that are understood by the cadets. Examples include trips to areas of local interest, flying/gliding, hiking and/or sailing.</p>	<p>Specify the objective(s) of the field trip.</p> <p>Determine the time and location of the field trip.</p> <p>Obtain necessary authorizations.</p> <p>Determine the timings.</p> <p>Determine the activities or demonstrations needed to achieve the objectives.</p> <p>Determine if trained personnel will be available to assist.</p> <p>Arrange the following, if necessary:</p> <ul style="list-style-type: none"> <li>• transportation,</li> <li>• supervision, and</li> <li>• meals.</li> </ul> <p>Determine if the cadets will be allowed to use equipment or participate in a training activity.</p> <p>Determine if all cadets can take part at once or if they need to be rotated through.</p> <p>Divide the cadets into groups, if necessary.</p> <p>Ensure safety.</p>	<p>The field trip is used to:</p> <ul style="list-style-type: none"> <li>• introduce/illustrate and confirm topics;</li> <li>• reinforce and clarify classroom learning;</li> <li>• inject variety into the training situation; or</li> <li>• allow cadets to view operations or equipment that cannot easily be shown in the classroom.</li> </ul>	<p>Inform cadets as soon as possible of the following:</p> <ul style="list-style-type: none"> <li>• time of the field trip,</li> <li>• location of the field trip, and</li> <li>• timings for departure.</li> </ul> <p>Brief cadets on the following prior to departure:</p> <ul style="list-style-type: none"> <li>• objectives of the field trip,</li> <li>• timings and groupings for activities and demonstrations, and</li> <li>• how they will participate during the field trip.</li> </ul> <p>During the field trip ensure the following:</p> <ul style="list-style-type: none"> <li>• the safety of all cadets,</li> <li>• maximum participation, and</li> <li>• the objectives are met.</li> </ul> <p>After the field trip:</p> <ul style="list-style-type: none"> <li>• debrief the cadets; and</li> <li>• confirm that objectives have been met.</li> </ul> <p>Express appreciation to the facilitators of the field trip.</p>

**SELECT A METHOD OF INSTRUCTION**

<b>Lesson Topic</b>	<b>Method of Instruction</b>	<b>Explanation</b>
Participate in a Discussion on Hygienic Practices During Physical Activity		
Identify the Parts and the Characteristics of the Daisy 853C Air Rifle		
Apply Basic Marksmanship Techniques		
Participate in a Discussion on Year One Training		
Wear the Army Cadet Uniform		
Participate in a Discussion of Year One Summer Training Opportunities		
Describe the History and Traditions of the Affiliated Unit		
Tie Knots and Lashings		
Assemble a Survival Kit		
Erect a Group Tent		
Discuss Leadership Within A Peer Setting		
Identify Types of Maps		
Orient a Map by Inspection		
Select Trekking Gear		
Identify the Rank Structure of the Royal Canadian Sea, Army and Air Cadets		

THIS PAGE INTENTIONALLY LEFT BLANK

### POSING QUESTIONS SEQUENCE

<b>Question Sequence</b>	<b>Action</b>
<b>Pose the Question</b>	The instructor must ensure that they have the full attention of the class and ask a question that is clearly heard by all.
<b>Pause</b>	The instructor must allow cadets time to think of a response. Do not waste time, but avoid answering the question for the cadets just to break the silence.
<b>Pounce</b>	When using a direct question the instructor must indicate which cadet will answer.
<b>Ponder</b>	The instructor must allow the cadets time to answer fully, listen carefully to the response, confirm the correct response and explain why it is correct. If an answer is incomplete, the instructor must emphasize what is correct and ask a follow-up question to complete the response or simply provide additional information. If an answer is incorrect the instructor must point that out as well, in a manner that does not embarrass the cadet and explain why the answer is incorrect. There may be a need to reword the question to get a better response.
<b>Praise</b>	The instructor must praise all cadets for participating and confirm/summarize all correct responses so as to avoid confusion regarding which responses were correct or incorrect.

THIS PAGE INTENTIONALLY LEFT BLANK



### QUESTIONS HANDOUT

Read the short passage to the group and ask them to remember the children's story "Goldilocks and the Three Bears."

**Once upon a time there was a little girl named Goldilocks. She went for a walk in the forest. Pretty soon, she came upon a house. She knocked and, when no one answered, she walked right in.**

- Q. Who do you think lived in the house in the forest?
- A. The three bears.
- Q. What did Goldilocks first do when she entered the house?
- A. She tasted the porridge.
- Q. Whose chair did Goldilocks break?
- A. Little bear's chair.
- Q. Why did Goldilocks go upstairs to the bedroom?
- A. She felt tired.
- Q. Did Goldilocks ever return to the house in the forest?
- A. No.

THIS PAGE INTENTIONALLY LEFT BLANK

## POSING QUESTIONS RUBRIC

### Standard

Effective Questioner: Follows posing questions sequence when asking questions.

### Performance Task

Ask a recall question to the group about the children’s story, “Goldilocks and the Three Bears” using the posing questions sequence.

<b>Performance Element</b>	<b>Met the Standard (Level 3)</b>	<b>Met the Standard With Difficulty (Level 2)</b>	<b>Did Not Meet the Standard (Level 1)</b>
Pose the question	Had the attention of the group.  Asked the question clearly.	Had the attention of the group.  Did not ask the question clearly.	Did not get the attention of the group.  Did not ask the question carefully.
Pause	Allowed cadets ample time to think of a response.  Did not waste time.  Did not answer the question for the cadets.	Unsure of how much time to allow for a response.	Allowed too much/too little time for a response.  Answered the question for the cadet.
Pounce	Pointed to a cadet.	Had to be told to point to a cadet.	Allowed anyone to answer.
Ponder	Allowed cadet to answer fully.  Confirmed correct response.  Explained incorrect answer.	Allowed cadet to answer fully.  Confirmed correct response after being prompted.  Explained incorrect response after being prompted.	Did not allow cadet to answer fully.  Did not confirm correct response after being prompted.  Did not explain incorrect response after being prompted.
Praise	Ensured all cadets participated.  Praised correct response appropriately.  Clarified any confusion regarding responses.	Ensured all cadets participated.  Had to be prompted to praise correct response.  Had to be prompted to clarify confusion regarding responses.	Did not ensure all cadets participated.  Failed to praise correct responses.  Did not clarify lingering confusion regarding responses.

THIS PAGE INTENTIONALLY LEFT BLANK



THIS PAGE INTENTIONALLY LEFT BLANK

## COMMON INSTRUCTIONAL AIDS

# INSTRUCTIONAL AIDS

### HOW INSTRUCTIONAL AIDS WORK

During the communication process, the brain filters the important pieces of information from the less significant pieces. What is considered to be the most important information is passed to the short-term memory for possible storage into the long-term memory. Instructional aids support learning by highlighting and emphasizing the most important pieces of information for the brain to store in memory.

Instructional aids also:

- attract and hold the cadets' attention;
- involve the two most important senses – sight and sound; and
- help instructors teach more in less time.

### CHARACTERISTICS OF INSTRUCTIONAL AIDS

Instructional aids should:

- support the lesson by emphasizing and clarifying important information;
- keep the cadets' attention on the topic;
- contain quality pictures, graphs or text;
- be simple and easy to use; and
- be large enough to be seen and loud enough to be heard.

### GUIDELINES FOR USING INSTRUCTIONAL AIDS

During the lesson planning stage the following process can be used to determine if and where instructional aids are necessary:

- clearly establish the lesson objective – the information to be communicated or the task to be accomplished;
- research supporting material to achieve the lesson objective;
- organize the material into a lesson plan; and
- select the important points to be supported by instructional aids.

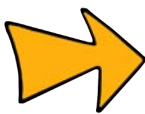

Instructional aids should be used only if they support learning and should not be made visible until the appropriate time during a lesson so as not to become a distraction.

# VERBAL SUPPORT

Almost all ideas need some sort of clarification, explanation or proof to be understood. If cadets are learning something new, they want proof to support what is being said. The lesson topic, the instructional method, the cadets' background knowledge and the size of the group are factors that determine how much learning support is required.

Verbal support is one type of support instructors use to clarify, prove, illustrate, emphasize or to add variety and interest to information during a lesson. Types of verbal support include:

- **COMPARISONS**

A comparison is a bridge built by the instructor between the known and the unknown. New information can be clarified by pointing out its similarity to a familiar topic, idea or situation. A factual comparison clarifies by highlighting how two or more related things are similar. For example, a factual comparison is used when the **similarities** between two or more different types of uniforms are highlighted. A contrast clarifies by highlighting how two or more things are different. A contrast is used when the **differences** between two or more types of uniforms are highlighted. Figurative comparisons use similes and metaphors to add variety and gain attention. A figurative comparison is used when expressions such as the “ship cut through the water like a knife” or “the ship knifed through the water” are used to indicate the ship's speed.

- **REASONS**

Reasons are logical explanations that satisfy the question “why”. Explaining the reason for something often makes it easier for the cadets to accept what is being explained. When instructors cite “safety concerns” as the reason why a task must be completed a certain way, they are using reasons as verbal support.

- **RESTATEMENT AND REPETITION**

Instructors can emphasize main ideas or key points by repeating them. One way to repeat something is to restate it in a different way. Skillful repetition can also persuasively help cadets accept an idea or point of view. Sometimes directions or instructions need to be repeated many times without change for clarity.

- **EXAMPLES**

An example is a specific instance of a general idea used to clarify or simplify information. It should be short and specific and in the cadets' background knowledge so that the cadets can associate new information with something already known.

- **STATISTICS**

Statistics are a summary of numerical information about an event or thing. If properly used, statistics help instructors prove or emphasize main points and create interest in the information. Do not assume, however, that verbal support is being used every time a number or figure is quoted. For example, saying “last year's national budget for cadets was approximately \$180 million” is a statement of fact but saying “last year's cadet budget was approximately \$3 000.00 for every cadet in Canada” is using statistics to emphasize the point that the cadet budget is large.

- **TESTIMONY**

Testimony is simply using the experiences, words and thoughts of others to emphasize or prove points. Testimonials are believable because they are offered by experts or people with first- hand knowledge. For example, simply saying, “the cadet organization offers many advantages to youth” is not as powerful as quoting or hearing from cadets who have gone through the program and realized its benefits.





The acronym **CRREST** can be used to remember the different types of verbal support.

# AUDIOVISUAL AIDS

Instructional aids appeal to all five senses. Audiovisual aids are particularly effective because individuals learn and retain over 50 percent of what they both see and hear.

## MODELS

A model is a copy of a real object and can be an enlargement, a reduction or the same size as the original. Two types of models are:

- the scale model which is an exact reproduction of the original, and
- the simplified model, which does not represent reality in all details.



As instructional aids, models are usually more practical than the real object because they are lightweight and easy to manipulate.

## Mock-Ups

A mock-up is a three dimensional or specialized type of working model and is used for study, training or testing in place of the real object, which may be too costly, too dangerous or impossible to obtain. The advantage of the mock-up over the real thing is that the mock-up may emphasize the essential elements to be learned by distinguishing them from non-essential elements.

## Cut-Aways

Some models are solid and show only the outline of the object while others can be manipulated or operated. Specialized models, called cut-aways, are built in sections and can be taken apart to reveal an internal structure. Whenever possible, the various parts should be labelled and coloured to clarify relationships.



Production and equipment costs are limiting factors in developing and using models, mock-ups and cut-aways. If a two-dimensional representation will satisfy the instructor's needs it should be used.

## THE REAL OBJECT AND REALISTIC IMAGES

The real object is often the most effective visual aid. To be effectively used the real object should be safe and big enough for everyone to see or small enough and available enough for each cadet to have one. Realistic images, including quality photographs or drawings of the real object, are suitable replacements if the real object cannot be obtained or effectively used.

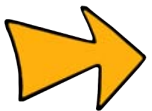

Realistic images and objects are most effective when they are used after a teaching point has been introduced.

## GRAPHICS

Graphics, which include charts, graphs, maps, diagrams, drawings and cartoons, can be used to clarify relationships between concepts or effectively explain a concept that would otherwise require a lengthy description.

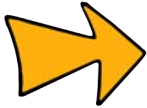

Graphics catch the cadets' attention and stimulate thinking by:

- presenting one idea;
- avoiding too many details; and
- using colours, which contrast with the background to emphasize main points.

## PROJECTED MATERIAL

Projected material includes videotapes, DVDs and slides projected by an overhead projector or computer. Short, high-quality video presentations have become one of the most popular instructional aids.

Passive video, which includes VHS, DVDs and slides, provides motion, colour, sound and in some cases special advanced graphic and animation techniques. The availability, low cost and user-friendly characteristics are important advantages of passive video but instructors should be aware it is often difficult for instructional video to compete with the action-packed entertainment videos and is often considered less exciting and stimulating by cadets. This, in addition to the cadets' passive viewing style for entertainment videos, can diminish the instructional value of the video.

To increase the value of passive video for instructional purposes, instructors should follow these basic guidelines:

- preview the video to determine the important points and concepts;
- prepare the cadets for viewing the video by stressing what is important to watch; and
- summarize the presentation and answer any questions the cadets may have.

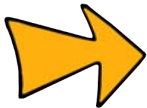

Video presentations are not designed to replace the instructor.

Videotapes and DVDs are generally purchased but slides can easily be developed by hand or by using a computer.

Guidelines for developing slides are:

- illustrate key points;
- use key words or phrases as headers for each slide;
- include a maximum of six words per line and six lines per slide; and
- use lettering large enough to be clearly read from the back of the classroom.



Use of projected materials requires planning and practice. Instructors should set up and adjust the equipment and lighting beforehand and always preview the presentation.

Interactive video refers to software that responds to choices and commands by the user. A typical system consists of a combination of a compact disk and computer with video presentation capability. The software may include image banks of colour photos and graphics as well as questions or directions, which are programmed to create interactivity for students as they progress through the course.

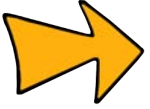

Interactive video solves one of the main problems of passive video in that it increases the cadets' involvement in the learning process. Each cadet receives a customized learning experience.

# SIMULATORS

Simulators are mechanical or electronic devices that act like the actual equipment or systems and provide the cadets with realistic practice in a safe and controlled environment. They may have various capabilities such as jump, freeze, record and replay which can capture and playback information for instructional feedback. Simulators replicate the real thing at a fraction of the cost.

Some concerns include:

- the need for the provision of background information,
- the requirement for hardware and software maintenance,
- the need for expertise to run the simulator, and
- the need for specialized facilities.

Some of the more commonly recognized simulators include flight simulators, driver training simulators and marine simulators, which simulate normal and emergency situations, which would otherwise be encountered in real life.

# TRAINING EQUIPMENT

Training equipment refers to the use of actual equipment such as boats, air rifles, or gliders for training purposes. The main advantage of this type of aid is that it is the actual piece of equipment or system that the cadet will be expected to use. Despite the benefits of simulators, training is not complete without intensive training in or with the real thing.

Some concerns include:

- the need for subject matter experts,
- the high maintenance costs,
- the need for modifications for instructional purposes, and
- scheduling difficulties caused by external factors such as weather and the availability of the resources.

In short, cadets will only learn to sail, fly or complete an expedition by using a sailboat or glider or travelling to the field.

# SELECT AN INSTRUCTIONAL AID

## GUIDELINES FOR SELECTING INSTRUCTIONAL AIDS

During the lesson planning stage the following process can be used to determine if and where instructional aids are necessary:

- clearly establish the lesson objective – the information to be communicated or the task to be accomplished;
- research supporting material to achieve the lesson objective;
- organize the material into a lesson plan; and
- select the important points to be supported by instructional aids. Instructional aids are appropriate when:
  - long segments of technical description are necessary;
  - a point is complex and difficult to put into words;
  - instructors find themselves forming visual images; and
  - students are puzzled by an explanation or description.

The selection of instructional aids depends on several factors, which include:

- **Availability.** Which ready-made aids are available? What resources are available to make instructional aids?
- **Facilities.** Does the training area or equipment available allow the instructor to use certain instructional aids?
- **Cost.** Are the instructional aids too expensive to purchase or produce?
- **Class Size.** Does the number of people in the class make the use of the instructional aid practical? Does the instructional aid encourage cadet participation?

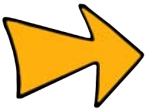

Instructional aids should be used only if they support learning and should not be a distraction.

INSTRUCTIONAL AIDS WORKSHEETS

# INSTRUCTIONAL AIDS Worksheet

1. How do instructional aids support learning?

---

---

---

---

2. In your opinion, what is the most important characteristic of instructional aids?

---

---

---

---

---

---

3. When should instructional aids be used during a lesson?

---

---

---

---

# VERBAL SUPPORT Worksheet

Match Column A with Column B by placing the correct number from Column B opposite the correct phrase from Column A.

**Column A**

- a. a bridge between the known and unknown \_\_\_\_\_
- b. numerical information about an event or thing \_\_\_\_\_
- c. can be used to persuade the cadets to accept an idea \_\_\_\_\_
- d. a specific instance of a general idea \_\_\_\_\_
- e. logical explanations that satisfy the question “why” \_\_\_\_\_
- f. using the words of others to prove a point \_\_\_\_\_
- g. highlighting how two or more things are different \_\_\_\_\_

**Column B**

- 1. testimony
- 2. reasons
- 3. comparison
- 4. statistics
- 5. repetition
- 6. example
- 7. contrast



# AUDIOVISUAL AIDS

## Worksheet

COMPLETE THE CROSSWORD PUZZLE

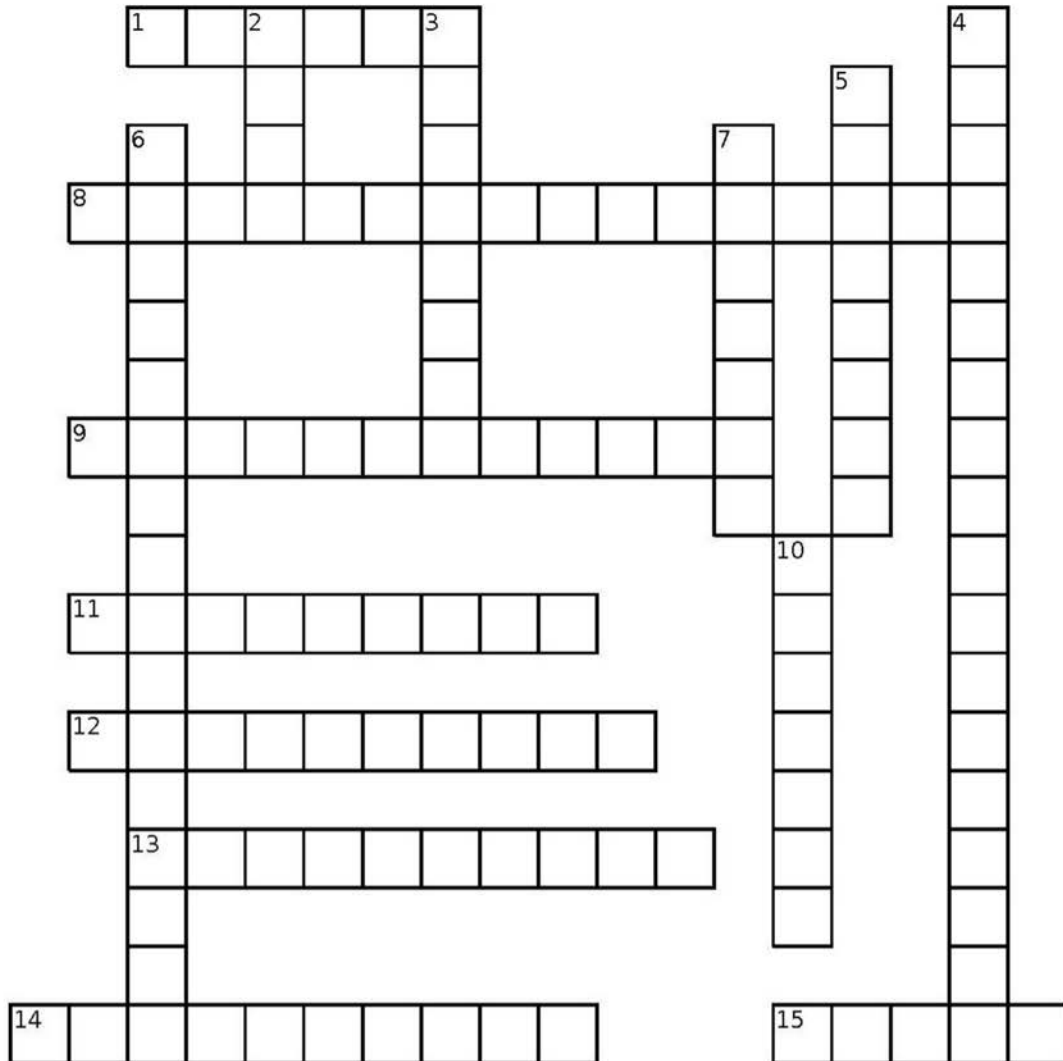

## CROSSWORD PUZZLE CLUES

### ACROSS

1. a specialized type of working model (2 words)
8. appeals to all five senses (2 words)
9. video, which lacks cadet involvement (2 words)
11. one type of projected material (2 words)
12. the most effective visual aid (2 words)
13. video presentations should not replace the ...
14. an example of a realistic image
15. copy of the real object

### DOWN

2. a limiting factor in developing models
3. use of projected material requires planning and ...
4. instructional aids are most effective when they are ... (5 words)
5. can effectively replace a lengthy explanation
6. software that responds quickly to commands (2 words)
7. an example of a graphic instructional aid
10. a model that can be taken apart (2 words)

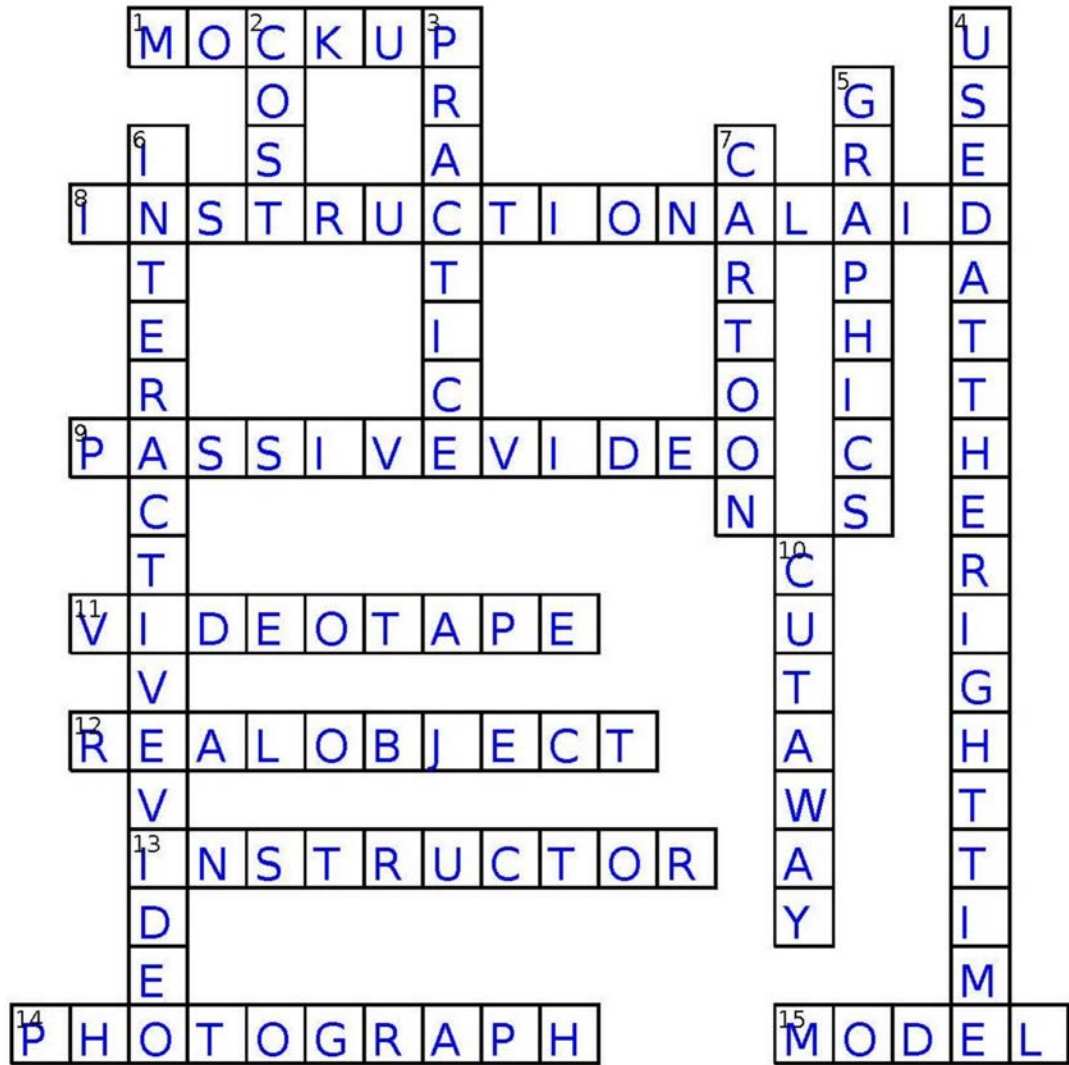

# SIMULATORS AND TRAINING EQUIPMENT

## Worksheet

1. What do simulators provide the cadets?

---

---

---

---

2. List four concerns about simulators.

---

---

---

---

3. What is the main advantage of training equipment as an instructional aid?

---

---

---

4. List four concerns about training equipment.

---

---

---

---

# SELECT AN INSTRUCTIONAL AID Worksheet

Using the "Select an Instructional Aid" information sheet, select an instructional aid you would consider appropriate for each of the topics listed below.

Lesson Topic	Type of Instructional Aid
Participate in a Discussion on Hygienic Practices During Physical Activity	
Identify the Parts and the Characteristics of the Daisy 853C Air Rifle	
Apply Basic Marksmanship Techniques	
Participate in a Discussion on Year One Training	
Wear the Army Cadet Uniform	
Participate in a Discussion of Year One Summer Training Opportunities	
Describe the History and Traditions of the Affiliated Unit	
Tie Knots and Lashings	
Assemble a Survival Kit	
Erect a Group Tent	
Discuss Leadership Within A Peer Setting	
Identify Types of Maps	
Orient a Map by Inspection	
Select Trekking Gear	
Identify the Rank Structure of the Royal Canadian Sea, Army and Air Cadets	

THIS PAGE INTENTIONALLY LEFT BLANK

## LESSON SPECIFICATION AND INSTRUCTIONAL GUIDE HANDOUT

### ENABLING OBJECTIVE AND LESSON SPECIFICATION

Performance objectives are broken down into a series of enabling objectives and lesson specifications. The enabling objective consists of Paragraphs 1. to 3. (as illustrated in Figure 9K-1). The information in these paragraphs will answer three questions:

1. What will the cadet be expected to be able to do by the end of this lesson?
2. Under what conditions will the cadet be expected to carry out the performance?
3. How well or to what standard will the cadet be expected to perform?

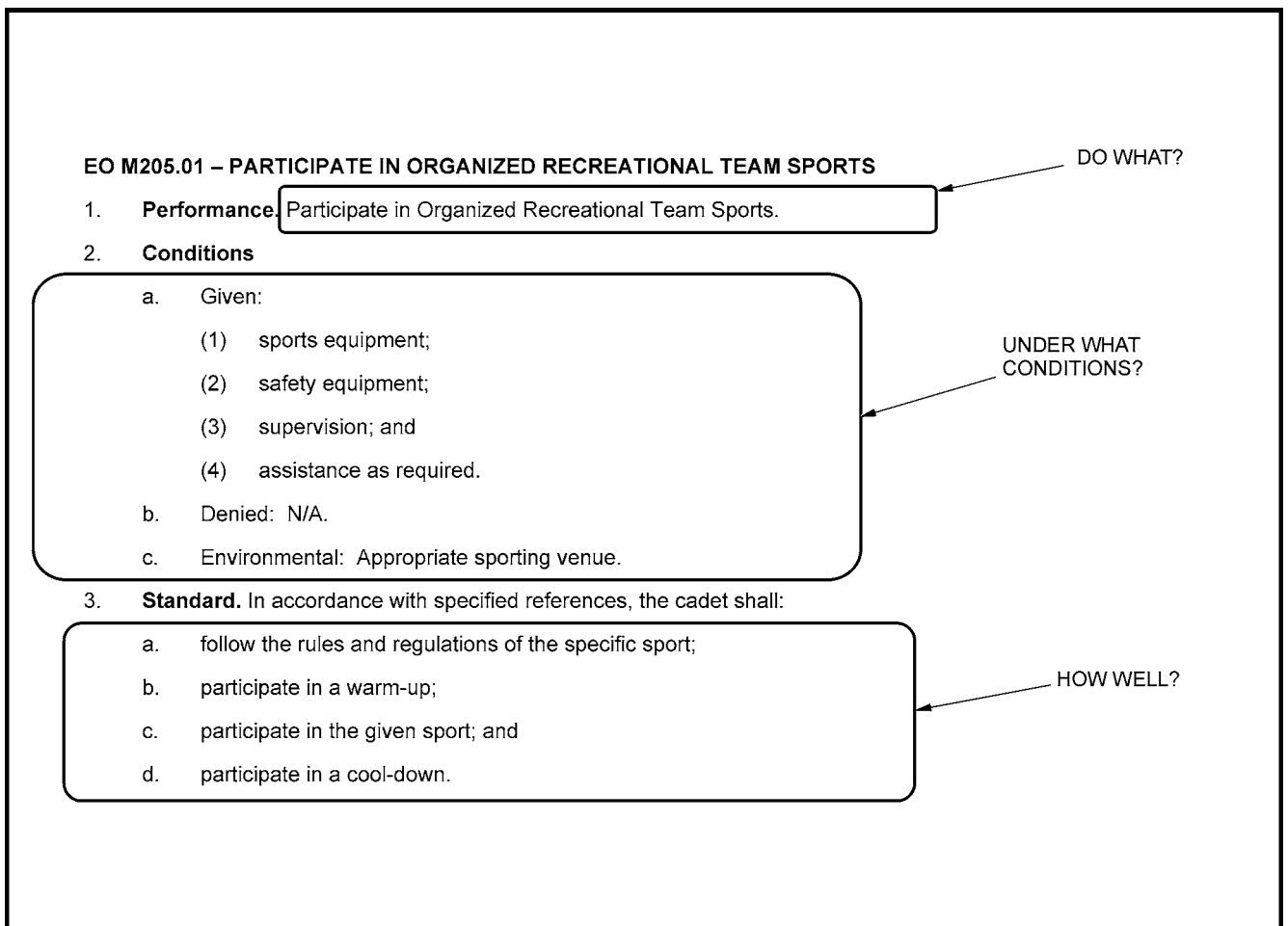

*Director Cadets 3, 2008, Ottawa, ON: Department of National Defence*

Figure 9K-1 Enabling Objective

Paragraphs 4. to 11. are known as the lesson specification. The lesson specification provides information about the content to be taught, teaching methods, time, references, training aids, learning aids, test details and remarks.

In Paragraph 4., the TPs are usually described in a table where information is provided on the content taught in each TP, the suggested teaching method, the time for each TP and references (as illustrated in Figure 9K-2).

4. Teaching Points

TP	Description	Method	Time	Ref
TP1	Introduce cadets to a specific sport's rules and regulations, to include: <ul style="list-style-type: none"> <li>a. an overview of how to play the sport; and</li> <li>b. rules and regulations of the sport.</li> </ul>	Interactive Lecture	10 min	C0-001
TP2	Conduct a warm-up session, composed of light cardiovascular exercises, meant to: <ul style="list-style-type: none"> <li>a. stretch the muscles;</li> <li>b. gradually increase respiratory action and heart rate;</li> <li>c. expand the muscles' capillaries to accommodate the increase in blood circulation; and</li> <li>d. raise muscle temperature to facilitate reactions in muscle tissue.</li> </ul>	Practical Activity	10 min	C0-002 (pp. 109 to 113) C0-089
TP3	Supervise the cadets' participation in a given sports activity.	Practical Activity	50 min	

*Director Cadets 3, 2008, Ottawa, ON: Department of National Defence*

Figure 9K-2 Teaching Points

Paragraph 5. outlines how much time is spent on the introduction/conclusion and the different teaching methods. Paragraph 6. offers substantiation or reasons why certain teaching methods were recommended for each TP. Paragraph 7. provides a list of references used to compile the content in Paragraph 4. (as illustrated in Figure 9K-3).



5. **Time**
  - a. Introduction/Conclusion: 10 min
  - b. Interactive Lecture: 10 min
  - c. Practical Activity: 70 min
  - d. Subtotal: 90 min
  - e. Total (three sessions): 270 min
6. **Substantiation**
  - a. An interactive lecture was chosen for TP1 to illustrate the application of rules, principles, or concepts of the specific sport to be played.
  - b. A practical activity was chosen for TP2 to TP4 as it allows cadets to participate in sports activities in a safe and controlled environment. This activity contributes to the development of sports skills in a fun and challenging setting.
7. **References**
  - a. C0-001 (ISBN 0-88011-807-5) Hanlon, T. (1998). *The Sports Rules Book: Essential Rules for 54 Sports*. USA: Human Kinetics Publishers, Inc.
  - b. C0-002 (ISBN 0-88962-630-8) LeBlanc, J., and Dickson, L. (1997). *Straight Talk About Children and Sport: Advice for Parents, Coaches, And teachers*. Oakville, ON and Buffalo, NY: Mosaic Press.

*Director Cadets 3, 2008, Ottawa, ON: Department of National Defence*

Figure 9K-3 Paragraphs 5. to 7.

Paragraphs 8. and 9. list the training aids and learning aids required for the lesson. Training aids are the materials that are required by the instructor to instruct the lesson and learning aids are the materials that will be required by the cadet to participate in the lesson (as illustrated in Figure 9K-4).

8. **Training Aids**
  - a. Sports/safety equipment appropriate for the activity;
  - b. First aid kit;
  - c. Whistles; and
  - d. Stopwatch.
9. **Learning Aids.** Sports equipment.

*Director Cadets 3, 2008, Ottawa, ON: Department of National Defence*

Figure 9K-4 Training Aids and Learning Aids

Paragraph 10. is test details, which is information about the evaluation to be conducted. Paragraph 11. is remarks, which describe any other information that may be useful to the Training Officer or instructor (as illustrated in Figure 9K-5).

10. <b>Test Details.</b> N/A.
11. <b>Remarks</b>
a. The CCO list of approved sports is located at A-CR-CCP-702/PF-001, Chapter 5, Annex A.
b. Recreational sports can be carried out as nine periods during a supported day or over three sessions of three periods each.

*Director Cadets 3, 2008, Ottawa, ON: Department of National Defence*

Figure 9K-5 Test Details and Remarks

## **INSTRUCTIONAL GUIDE**

The IG is used in conjunction with the QSP and other resources to conduct training. IGs should be reviewed in conjunction with lesson specifications so that the instructor can adequately plan and prepare their lesson. IGs do not replace lesson plans but offer written content, supporting figures and suggestions on how to instruct a lesson. The following are the six sections of an IG:

1. preparation,
2. introduction,
3. body,
4. conclusion,
5. references, and
6. annexes.

### **Preparation**





The preparation section provides information about where to find the lesson specification and any instructions to the instructor such as reviewing lesson content, photocopying handouts, pre-lesson assignments and the approach and substantiation as to why certain teaching methods were recommended for each TP.

### **Introduction**

The introduction section provides information to the instructor about review that may be necessary, what the cadet will be expected to do by the end of the lesson and why the knowledge/skills are important.

### **The Body**

The body of the IG contains all of the TPs and content listed in Paragraph 4. of the lesson specification in greater detail. The body provides suggested teaching methods, note boxes with special instructions or information (as illustrated in Figure 9K-6), lesson content, figures, activities and confirmation questions.

<b>Note Boxes:</b>	
	Special note to the instructor.
	key information to pass along to the cadets.
	Refer to the following CF regulations and policies.
	Points of interest or special instructions the instructor should pass along to the cadets.

*Director Cadets 3, 2008, Ottawa, ON: Department of National Defence*

Figure 9K-6 Note Boxes

### **The Conclusion**

The conclusion section states any homework/reading/practice that may be required of the cadet and the method of evaluation as stated in the lesson specification. The conclusion section also provides a closing statement to be spoken aloud to the cadets and any additional instructor notes/remarks.

### **References**

The reference section lists the references used to create the lesson specification and instructional guide. In some cases, an IG may direct the instructor to a specific reference to be used during a lesson. In most cases this section is only used to identify where the content of the lesson has been drawn from.

### **Annexes**

The annex section contains information that may range from pre-made training aids, learning aids such as handouts and additional information for activities.

THIS PAGE INTENTIONALLY LEFT BLANK





**PLAN A LESSON CHECKLIST**

<b>PREPARATION</b>	<b>NOTES</b>
<p>Have you:</p> <ul style="list-style-type: none"> <li><input type="checkbox"/> Selected an appropriate lesson location?</li> <li><input type="checkbox"/> Selected an appropriate method of instruction?</li> <li><input type="checkbox"/> Provided for a review of previous lesson materials?</li> </ul>	
<b>INTRODUCTION</b>	
<p>Does your introduction:</p> <ul style="list-style-type: none"> <li><input type="checkbox"/> State what the cadets will learn?</li> <li><input type="checkbox"/> Describe why the information is important to learn?</li> <li><input type="checkbox"/> Describe where and when the information / skill can be used?</li> </ul>	
<b>BODY</b>	
<p>Does the body of your lesson:</p> <ul style="list-style-type: none"> <li><input type="checkbox"/> Include the different principles of instruction?</li> <li><input type="checkbox"/> Include questions?</li> <li><input type="checkbox"/> Provide for the use of instructional aids?</li> <li><input type="checkbox"/> Used explanation and demonstration? (skill lesson only)</li> <li><input type="checkbox"/> Confirm each TP?</li> </ul>	
<b>END OF LESSON CONFIRMATION</b>	
<ul style="list-style-type: none"> <li><input type="checkbox"/> Did you conduct an end of lesson confirmation by using questions or by conducting an activity?</li> </ul>	
<b>CONCLUSION</b>	
<p>Does your conclusion:</p> <ul style="list-style-type: none"> <li><input type="checkbox"/> Summarize the lesson?</li> <li><input type="checkbox"/> Re-motivate the cadets by: <ul style="list-style-type: none"> <li><input type="checkbox"/> commenting on their progress; and</li> <li><input type="checkbox"/> re-stating why the information learned is important?</li> </ul> </li> <li><input type="checkbox"/> Describe the next lesson?</li> </ul>	

THIS PAGE INTENTIONALLY LEFT BLANK



### LIST OF APPROVED 15-MINUTE TOPICS

TP 1 of M104.01 (Identify Activities That Will Help Achieve a Healthy Active Lifestyle, A-CR-CCP-701/PG-001, Chapter 4, Section 4, A-CR-CCP-701/PF-001, Chapter 4, Section 1),

TP 1 of M106.01 (Identify the Parts and the Characteristics of the Daisy 853c Air Rifle, A-CR-CCP-701/PG-001, Chapter 4, Section 6, A-CR-CCP-701/PF-001, Chapter 6, Section 1),

TP 4 of M106.03 (Apply Basic Marksmanship Techniques, A-CR-CCP-701/PG-001, Chapter 4, Section 6, A-CR-CCP-701/PF-001, Chapter 6, Section 3),

TP 1 of M203.01 (Discuss Leadership Within A Peer Setting, A-CR-CCP-702/PG-001, Chapter 4, Section 3, A-CR-CCP-702/PF-001, Chapter 3, Section 1).

<p><b>Note:</b> The TPs in this list were selected because they best fit into the 15-minute format. The selected EOs are a variety of knowledge and skill-based lessons.</p>
--

THIS PAGE INTENTIONALLY LEFT BLANK

**MODIFIED LESSON SPECIFICATIONS AND INSTRUCTIONAL GUIDES – TP 1 OF EO M104.01**

A-CR-CCP-701/PG-001

**EO M104.01 – IDENTIFY ACTIVITIES THAT WILL HELP ACHIEVE A HEALTHY ACTIVE LIFESTYLE**

1. **Performance.** Identify Activities that Will Help Achieve a Healthy Active Lifestyle.
2. **Conditions**
  - a. Given:
    - (1) a copy of *Canada's Physical Activity Guide to Healthy Active Living*;
    - (2) supervision; and
    - (3) assistance as required.
  - b. Denied: N/A.
  - c. Environmental: Suitable classroom facilities/training area large enough to accommodate entire group.
3. **Standard.** In accordance with *Canada's Physical Activity Guide to Healthy Active Living*, the cadet shall identify activities that will help achieve a healthy and active lifestyle.
4. **Teaching Points**

TP	Description	Method	Time	Ref
TP1	Introduce cadets to <i>Canada's Physical Activity Guide to Healthy Active Living</i> , to include: <ol style="list-style-type: none"> <li>a. page 4 – Check Out What You Are Doing Now;</li> <li>b. page 5 – Benefits of Physical Activity;</li> <li>c. page 6 – What Are You Into;</li> <li>d. page 8 – Let's Get Active; and</li> <li>e. page 10 – Crank Up Your Activity.</li> </ol>	Interactive Lecture	10 min	C0-020 (pp. 4 to 10)

5. **Time**
  - a. Introduction/Conclusion: 5 min
  - b. Interactive Lecture: 10 min
  - c. Total: 15 min
6. **Substantiation.** For TP1, the interactive lecture method was chosen as it allows the instructor to make a semi-formal presentation of the material where the cadets can participate by asking or responding to questions and commenting on the material. For this lesson, this method is most effective as it matches well the taxonomic level of the material and is age-appropriate by virtue of its participatory nature.
7. **References.** C0-020 (ISBN 0-662-32899) Minister of Health. (2002). *Canada's Physical Activity Guide to Healthy Active Living* [Brochure].
8. **Training Aids**
  - a. Presentation aids (i.e. whiteboard/flipchart/OHP) appropriate for classroom/training area; and
  - b. *Canada's Physical Activity Guide to Healthy Active Living*.

9. **Learning Aids.** *Canada's Physical Activity Guide to Healthy Active Living.*
10. **Test Details.** N/A.
11. **Remarks.** N/A.

A-CR-CCP-701/PF-001



**COMMON TRAINING  
SILVER STAR  
INSTRUCTIONAL GUIDE**



**SECTION 1**

**EO M104.01 – IDENTIFY ACTIVITIES THAT WILL HELP ACHIEVE A HEALTHY ACTIVE LIFESTYLE**

---

Total Time: 15 min

---

---

**PREPARATION**

---

**PRE-LESSON INSTRUCTIONS**

A complete list of resources needed for the instruction of this EO is located at Chapter 4 of the QSP. Specific uses for said stores are identified throughout the Instructional Guide, within the teaching point for which they are required.

The instructor shall review the lesson content and become familiar with the material prior to the instruction of the lesson.

**PRE-LESSON ASSIGNMENT**

N/A.

**APPROACH**

For TP1, the interactive lecture method was chosen as it allows the instructor to make a semi-formal presentation of the material where the cadets can participate by asking or responding to questions and commenting on the material. For this lesson, this method is most effective as it matches well the taxonomic level of the material and is age-appropriate by virtue of its participatory nature.

---

**INTRODUCTION**

---

**REVIEW**

N/A.

**OBJECTIVES**

By the end of this lesson the cadet shall be expected to identify activities that will help them achieve a healthy and active lifestyle.

**IMPORTANCE**

Physical fitness is one of the three aims of the cadet program. Teaching the cadets what activities contribute to an active lifestyle will help them achieve physical fitness.

A-CR-CCP-701/PF-001

---

**Teaching Point 1**

**Introduce Cadets to *Canada's Physical Activity Guide to Healthy Active Living***

Time: 10 min

Method: Interactive Lecture

---

**CANADA'S PHYSICAL ACTIVITY GUIDE TO HEALTHY ACTIVE LIVING**

Hand out *Canada's Physical Activity Guide to Healthy Active Living*, highlighting the following pages and information detailed there:

- **Page 4 – Check Out What You Are Doing Now.** Is your exercise time more than 90 minutes per day? Less than 90 minutes but more than 60? Less than 60 but more than 30? Have each cadet write down their activities from yesterday and two days ago to add up their total time.
- **Page 5 – Benefits of Physical Activity.** Meet new friends, improve physical self-esteem, achieve a healthy weight, build strong bones and strengthen muscles, maintain flexibility, promote good posture and balance, improve fitness, strengthen the heart, increase relaxation and promote healthy growth and development.
- **Page 6 – What Are You Into.** Walking, running, hiking, cycling, swimming, jogging, gymnastics, ice-skating, skiing, basketball, volleyball, tobogganing, soccer, football, tennis, baseball, softball, dancing, yoga, climbing, bowling, hockey, skateboarding, badminton, etc. Have the cadets brainstorm all the activities they can think of that they may be interested in.
- **Page 8 – Let's Get Active.** Increase the time currently spent on physical activity and reduce non-active time.
- **Page 10 – Crank Up Your Activity.** Walking instead of taking the bus, playing ball at breaks, walking the dog, raking leaves, shovelling snow, carrying groceries, etc. Brainstorm ideas that will help increase current physical activity.

The purpose of highlighting these pages is to fuel the discussion for the next teaching point. The cadets may take home the guides and explore them further afterwards.

---

**END OF LESSON CONFIRMATION**

---

The confirmation of this lesson will occur in EO M104.02 (Section 2) as the cadets develop a personal activity plan.

---

**CONCLUSION**

---

**HOMEWORK/READING/PRACTICE**

N/A.

**METHOD OF EVALUATION**

There is no formal assessment of this EO.

**CLOSING STATEMENT**

As physical fitness is one of the aims of the cadet program, it is important that cadets learn what activities contribute to an active lifestyle to help them achieve physical fitness.

A-CR-CCP-701/PF-001

**INSTRUCTOR NOTES/REMARKS**

N/A.

---

**REFERENCES**

---

- C1-011 (ISBN 0-662-32899) Minister of Health (2002). *Canada's Physical Activity Guide to Healthy Active Living* [Brochure].
- C3-024 (ISBN 0-7627-0476-4) Roberts, H. (1989). *Basic Essentials Backpacking*. Guildford, CT: The Globe Pequot Press.

THIS PAGE INTENTIONALLY LEFT BLANK



**MODIFIED LESSON SPECIFICATIONS AND INSTRUCTIONAL GUIDES – TP 1 OF EO M106.01**

A-CR-CCP-701/PG-001

**EO M106.01 – IDENTIFY THE PARTS AND CHARACTERISTICS OF THE DAISY 853C AIR RIFLE**

1. **Performance.** Identify the Parts and Characteristics of the Daisy 853C Air Rifle.
2. **Conditions**
  - a. Given:
    - (1) Daisy 853C air rifle;
    - (2) assistance as required; and
    - (3) supervision.
  - b. Denied: N/A.
  - c. Environmental: Suitable classroom facility and/or air rifle range constructed IAW A-CR-CCP-177/PT-001, Chapter 1, sect 8.
3. **Standard.** In accordance with A-CR-CCP-177/PT-001, the cadet shall identify the parts and list the characteristics of the Daisy 853C air rifle.
4. **Teaching Points**

TP	Description	Method	Time	Ref
TP1	Identify the parts of the Daisy 853C air rifle, to include: <ol style="list-style-type: none"> <li>a. butt plate;</li> <li>b. spacers;</li> <li>c. small of the butt;</li> <li>d. stock;</li> <li>e. fore end;</li> <li>f. sling bracket;</li> <li>g. trigger;</li> <li>h. trigger guard;</li> <li>i. safety catch;</li> <li>j. bolt;</li> <li>k. pump handle;</li> <li>l. front sight;</li> <li>m. rear sight;</li> <li>n. muzzle;</li> <li>o. barrel with barrel weight;</li> <li>p. bore;</li> <li>q. feed track;</li> <li>r. chamber;</li> <li>s. sling;</li> <li>t. single shot adapter; and</li> </ol>	Interactive Lecture	10 min	A0-027 (p. 2-5, Diagram)

TP	Description	Method	Time	Ref
	u. five-shot clip.  <b>Note:</b> The instructor shall ensure that the cadet can identify the parts of the cadet air rifle by physically pointing to the proper part on the rifle or on an unlabeled diagram.			

5. **Time**

- a. Introduction/Conclusion: 5 min
- b. Interactive Lecture: 10 min
- c. Total: 15 min

6. **Substantiation.** The interactive lecture method was chosen as it best allows the instructor to make a semi-formal presentation of the material allowing the cadets to participate by asking or responding to questions, commenting on the material, or participating in short activities. This method appeals to auditory learners, with the potential for active participation in activities that appeal to tactile/kinaesthetic learners.

7. **References.** A0-027 A-CR-CCP-177/PT-001 D Cdts 3. (2001). *Canadian Cadet Movement: Cadet Marksmanship Programme Reference Manual*. Ottawa, ON: Department of National Defence.

8. **Training Aids**

- a. Daisy 853C air rifle; and
- b. Presentation aids (i.e. whiteboard/flipchart/OHP) appropriate for classroom/training area.

9. **Learning Aids.** Daisy 853C air rifle.

10. **Test Details.** Assessment of this EO shall be carried out during the end of lesson check. While there is no formal assessment of this EO, every cadet is required to successfully complete the Cadet Air Rifle Handling Test provided at Chapter 3, Annex C.

11. **Remarks.** N/A.

A-CR-CCP-701/PF-001



**COMMON TRAINING  
SILVER STAR  
INSTRUCTIONAL GUIDE**



**SECTION 1**

**EO M106.01 – IDENTIFY THE PARTS AND THE CHARACTERISTICS OF THE DAISY 853C AIR RIFLE**

---

Total Time: 15 min

---

**PREPARATION**

---

**PRE-LESSON INSTRUCTIONS**

A complete list of resources needed for the instruction of this EO is located at Chapter 4 of the QSP. Specific uses for said stores are identified throughout the Instructional Guide, within the teaching point for which they are required.

Prior to instructing this lesson the instructor shall:

- review the lesson content, and become familiar with the material;
- carry out a safety precaution check on all rifles to be used during this lesson; and
- state to cadets that the rifles have been inspected and are safe to handle.

**PRE-LESSON ASSIGNMENT**

N/A.

**APPROACH**

This lesson will be presented using the interactive lecture method. The interactive lecture method was chosen as it best allows the instructor to make a semi-formal presentation of the material allowing the cadets to participate by asking or responding to questions, commenting on the material, or participating in short activities. This method appeals to auditory learners, with the potential for active participation in activities that appeal to tactile/ kinaesthetic learners.

---

**INTRODUCTION**

---

**REVIEW**

N/A.

**OBJECTIVES**

By the end of this lesson the cadet shall be expected to identify the parts, and list the characteristics of the cadet air rifle.

A-CR-CCP-701/PF-001

### IMPORTANCE

Cadets must have a basic knowledge of the cadet air rifle in order to understand how the rifle works and to safely follow directions given on the range.

#### Teaching Point 1

#### Identify the Parts of the Daisy 853C Air Rifle

Time: 10 min

Method: Interactive Lecture

### PARTS



- Depending on the number of rifles available, distribute them with an optimum ratio of one rifle for every two cadets.
- When possible, have a second instructor in the room to assist.
- **For safety purposes, maintain strict class control at all times.**

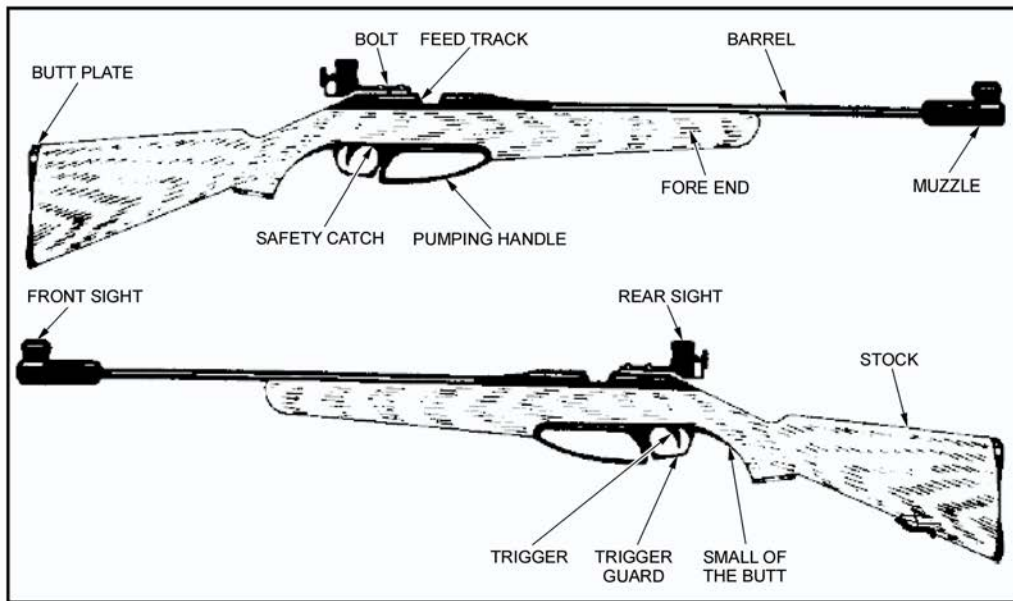

A-CR-CCP-177/PT-001

Figure 6-1-1 Parts of the Cadet Air Rifle

**Butt Plate (End of the Butt).** It is the part of the rifle directly in contact with the marksman's shoulder. When fitted properly, the butt plate aids in achieving a snug fit, and a consistent placement of the rifle into the shoulder. The addition of butt spacers allows for this adjustment in length.

**Spacers.** Plastic inserts that can be added or removed from the butt plate to vary its length. To add or take away butt spacers, use a Phillips screwdriver to loosen the butt plate and slide in/out the amount of spacers desired.

A-CR-CCP-701/PF-001

**Small of the Butt (Pistol Grip).** Curved area directly behind the trigger guard where the hand controlling the trigger grips the rifle.

**Stock.** Complete wooden portion of the rifle (from the butt plate end forward).

**Fore End (of the Stock).** Wooden portion of the stock from the trigger guard forward, in which the barrel and the rifle mechanism are encased.

**Sling.** It is a web sling made of nylon. Links the rifle to the marksman's arm to support most of the weight of the rifle. One end attaches to the sling bracket and the other to the upper arm.

**Sling Bracket (Hand Stop).** Adjustable metal clasp attached to the fore stock used to affix the sling to the rifle. It also acts as a hand stop, used to rest the left hand to prevent it from moving.

**Trigger.** Movable device that releases a spring and releases the rifle mechanism. This rifle has a single stage trigger that cannot be adjusted for weight.

**Trigger Guard.** Metal band that surrounds and protects the trigger.

**Safety Catch.** This is a mechanism that, once engaged, prevents the rifle from firing by locking the trigger in place. It is a cross bolt type device located on the trigger guard. The black side indicates that the rifle is unable to fire; the red side indicates the rifle is ready to fire. It should be ON (no red) at all times, unless firing.

**Bolt.** Metal lever used for opening or closing the rifle mechanism. It must be in the closed position in order to fire. For maximum safety when the rifle is uncased and not firing, the bolt should be kept open.

**Pump Handle.** Metal lever used to compress the air required to fire the pellet. Whenever the rifle is in a "safe rifle status", the pump lever should be left partially open.

**Front Sight.** Global front sight that uses aperture inserts.

**Rear Sight.** Micrometer sight adjustable for windage and elevation. It is easily attached to a metal rail located above the action. This rail allows for adjustment of the sight forward or backward, in order to maintain proper eye relief. The sight is attached using a small flat-blade screwdriver.

**Muzzle.** Front end of the barrel equipped with attachable barrel weight.

**Barrel With Barrel Weight.** Steel tube through which the pellet travels, extending from the muzzle to the chamber. The barrel weight ensures that the rifle's weight is evenly distributed and that the rifle's balance is maintained.

**Bore.** Interior of the barrel has spiral grooves cut into it. The lands are the ridges of metal between the grooves. Together, the grooves and lands are called rifling.

**Feed Track.** Delicate area where the pellet is inserted manually onto a single pellet adapter, or with a five-shot clip.

**Single Shot Adapter.** Plastic clip that aids in placing a pellet in the chamber.

**Five-shot Clip.** Plastic clip that holds a maximum of five pellets and used to place the pellets in the chamber.

**Chamber.** Location where the pellet is held before firing.

---

#### CONFIRMATION OF TEACHING POINT 1

---

The instructor shall ensure that the cadet can identify the parts of the cadet air rifle by physically pointing to the parts, and having the cadets properly name the part.

A-CR-CCP-701/PF-001

---

**END OF LESSON CONFIRMATION**

---

This EO may be confirmed with the handout found at Annex A. Allow cadets a few minutes to complete the annex, then have cadets switch sheets for correcting.

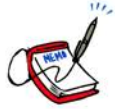

Correctly labelled diagram is located at page 6A-2.

---

**CONCLUSION**

---

**HOMEWORK/READING/PRACTICE**

Cadets are to take home the corrected handout to study the parts of the cadet air rifle.

**METHOD OF EVALUATION**

The instructor will confirm cadets' ability to identify the parts and characteristics of the cadet air rifle by asking questions during the end of lesson confirmation, and with the handout found at Annex A.

**CLOSING STATEMENT**

Knowing the parts and characteristics of the cadet air rifle is important in understanding how the rifle works. This allows the cadet to be able to follow directions given on the range, and properly perform a handling test whenever an air rifle is to be used.

**INSTRUCTOR NOTES/REMARKS**

Emphasis must be placed on the safety aspect of this lesson.

---

**REFERENCES**

---

A0-027 A-CR-CCP-177/PT-001 D Cdts 3. (2001). *Canadian Cadet Movement: Cadet Marksmanship Programme Reference Manual*. Ottawa, ON: Department of National Defence.

**PARTS AND CHARACTERISTICS OF THE CADET AIR RIFLE**

EO M106.01 Identify the Parts and Characteristics of the Cadet Air Rifle.

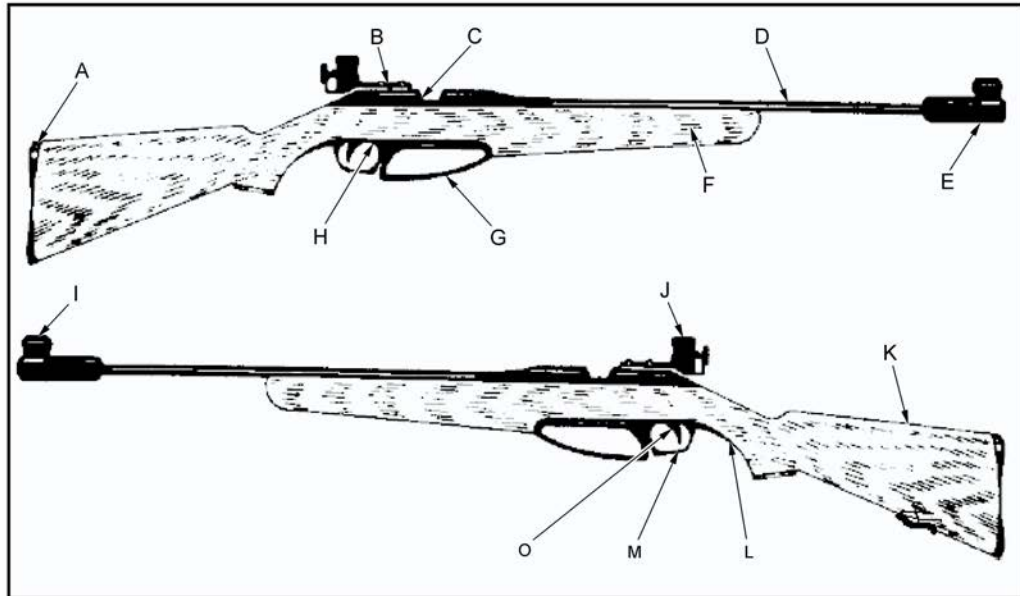

Put the letter next to the matching name of the part of the cadet air rifle.

- |                      |       |                   |       |
|----------------------|-------|-------------------|-------|
| 1. Feed Track        | _____ | 8. Safety Catch   | _____ |
| 2. Small of the Butt | _____ | 9. Muzzle         | _____ |
| 3. Barrel            | _____ | 10. Pump Lever    | _____ |
| 4. Fore End          | _____ | 11. Front Sight   | _____ |
| 5. Rear Sight        | _____ | 12. Trigger Guard | _____ |
| 6. Trigger           | _____ | 13. Butt Plate    | _____ |
| 7. Bolt              | _____ | 14. Stock         | _____ |

A-CR-CCP-701/PF-001  
 Chapter 6, Annex A

**ANSWER KEY**

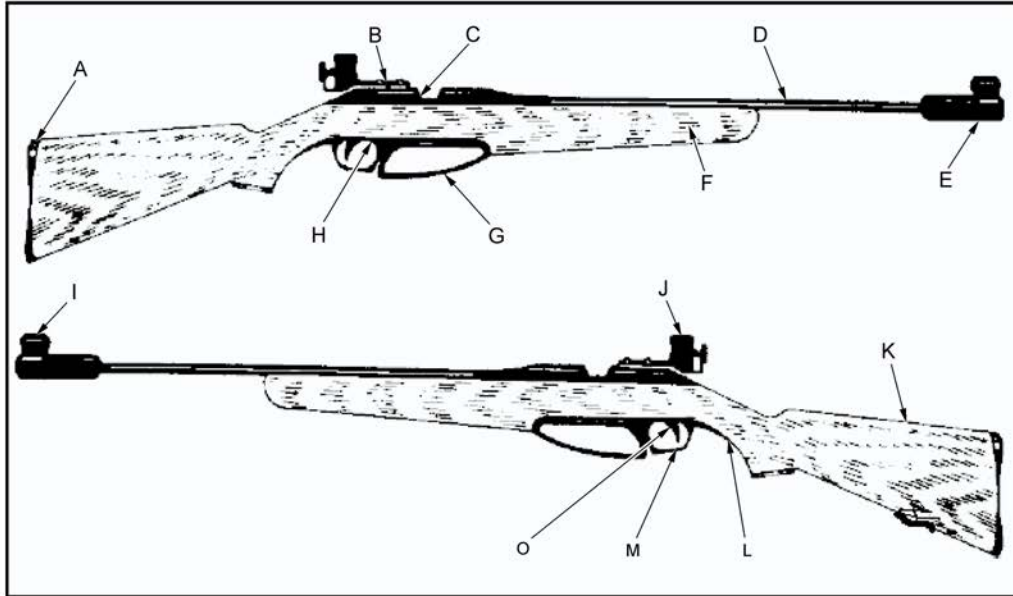

Put the letter next to the matching name of the part of the cadet air rifle.

- |                      |                          |                   |                          |
|----------------------|--------------------------|-------------------|--------------------------|
| 1. Feed Track        | <u>        C        </u> | 8. Safety Catch   | <u>        H        </u> |
| 2. Small of the Butt | <u>        L        </u> | 9. Muzzle         | <u>        E        </u> |
| 3. Barrel            | <u>        D        </u> | 10. Pump Lever    | <u>        G        </u> |
| 4. Fore End          | <u>        F        </u> | 11. Front Sight   | <u>        I        </u> |
| 5. Rear Sight        | <u>        J        </u> | 12. Trigger Guard | <u>        M        </u> |
| 6. Trigger           | <u>        O        </u> | 13. Butt Plate    | <u>        A        </u> |
| 7. Bolt              | <u>        B        </u> | 14. Stock         | <u>        K        </u> |



**MODIFIED LESSON SPECIFICATIONS AND INSTRUCTIONAL GUIDES – TP 4 OF EO M106.03**

A-CR-CCP-701/PG-001

**EO M106.03 – APPLY BASIC MARKSMANSHIP TECHNIQUES**

1. **Performance.** Apply Basic Marksmanship Techniques.
2. **Conditions**
  - a. Given:
    - (1) cadet air rifle;
    - (2) single pellet adaptor
    - (3) assistance as required; and
    - (4) supervision.
  - b. Denied: N/A.
  - c. Environmental: Suitable classroom facility and/or air rifle range constructed IAW A-CR-CCP-177/PT-001, Chapter 1, sect 8.
3. **Standard.** In accordance with A-CR-CCP-177/PT-001, the cadet shall apply basic marksmanship techniques, to include:
  - a. loading;
  - b. unloading; and
  - c. preparing for inspection.
4. **Teaching Points**

TP	Description	Method	Time	Ref
TP4	<p>Explain, demonstrate, and have the cadets load, unload, and prepare for inspection the cadet air rifle, as follows:</p> <ol style="list-style-type: none"> <li>a. loading the cadet air rifle, to include:               <ol style="list-style-type: none"> <li>(1) picking up the rifle with the left hand;</li> <li>(2) ensuring safety catch is in the ON position;</li> <li>(3) pumping the air rifle, pausing for three seconds;</li> <li>(4) bringing pump handle back to closed position;</li> <li>(5) loading a pellet; and</li> </ol> </li> <li>b. unloading the cadet air rifle, to include:               <ol style="list-style-type: none"> <li>(1) opening the bolt (do not insert a pellet);</li> <li>(2) pumping the air rifle, pausing for three seconds;</li> <li>(3) closing the bolt (do not insert a pellet);</li> </ol> </li> </ol>	Demonstration and Performance	10 min	A0-027 (p. 2-16)

TP	Description	Method	Time	Ref
	(4) placing the safety catch in the OFF position; (5) aiming the rifle at the target; (6) squeezing the trigger; (7) placing the safety catch in the ON position; and c. preparing for inspection, to include: (1) opening the bolt; (2) opening the pump handle slightly; (3) placing the rifle on the shoulder, muzzle pointed down range; (4) waiting to be cleared by the RSO; and (5) laying the rifle down.  <b>Note:</b> Cadets will be required to perform these skills during their air rifle handling test. The pellet guide shall be used for training, although cadets may be introduced to the five-round clip prior to actual firing.			

5. **Time**

- |    |                                |        |
|----|--------------------------------|--------|
| a. | Introduction/Conclusion:       | 5 min  |
| b. | Demonstration and Performance: | 10 min |
| c. | Total:                         | 15 min |

6. **Substantiation.** The demonstration-performance method was chosen to allow cadets to participate in supervised exploration of practical instructional material. This method provides the instructor the opportunity to introduce the subject matter, demonstrate and explain procedures, and supervise the cadets while they imitate the skill. This method appeals to all learning styles.

7. **References.** A0-027 A-CR-CCP-177/PT-001 D Cdts 3. (2001). *Canadian Cadet Movement: Cadet Marksmanship Programme Reference Manual*. Ottawa, ON: Department of National Defence.

8. **Training Aids**

- a. Presentation aids (i.e. whiteboard/flipchart/OHP) appropriate for classroom/training area; and
- b. Cadet air rifle.

9. **Learning Aids.** Cadet air rifle.

10. **Test Details.** N/A.

11. **Remarks.** N/A.

A-CR-CCP-701/PF-001



**COMMON TRAINING  
SILVER STAR  
INSTRUCTIONAL GUIDE**



**SECTION 3**

**EO M106.03 – APPLY BASIC MARKSMANSHIP TECHNIQUES**

---

Total Time: 15 min

---

**PREPARATION**

---

**PRE-LESSON INSTRUCTIONS**

Resources needed for the delivery of this lesson are listed in the lesson specification located at Chapter 4 of the QSP. Specific uses for said resources are identified throughout the Instructional Guide, within the teaching point for which they are required.

Review the lesson content, and become familiar with the material prior to delivering the lesson.

**PRE-LESSON ASSIGNMENT**

N/A.

**APPROACH**

This lesson will be presented using the demonstration and performance method. The demonstration and performance method was chosen to allow cadets to participate in supervised exploration of practical instructional material. This method provides the instructor the opportunity to introduce the subject matter, demonstrate and explain procedures, and supervise the cadets while they imitate the skill. This method appeals to all learning styles.



This lesson may be better presented using a round robin format for those units with large first year groups.

---

**INTRODUCTION**

---

**REVIEW**

The pertinent review for this lesson, from EO M106.02 (Section 2), will include:

**QUESTIONS**

- Q1. Why are the individual safety precautions performed?
- Q2. What is the purpose of the "safety catch"?

A-CR-CCP-701/PF-001

### ANTICIPATED ANSWERS

- A1. To confirm a rifle is safe.  
A2. It prevents a rifle from firing by locking its trigger into place.

### OBJECTIVES

By the end of this lesson the cadet shall be expected to apply basic marksmanship techniques to include:

- prone position;
- basic holding;
- basic aiming;
- loading;
- firing; and
- unloading.

Cadets will apply the knowledge gained during this lesson when they participate in any range practice.

### IMPORTANCE

These techniques must all be applied in harmony. Improving one while not working on another will not produce the best results in the long run. Perfecting these techniques takes time and concentration. Cadets should remember – PRACTICE MAKES PERFECT!

---

#### Teaching Point 4

#### Explain and Demonstrate How To Load and Unload the Cadet Air Rifle

Time: 10 min

Method: Demonstration and Performance

---

### LOADING THE AIR RIFLE



The instructor shall provide an EXPLANATION and DEMONSTRATION of the complete skill.

The instructor shall also provide an EXPLANATION and DEMONSTRATION of each step required to effectively complete the skill.

This will be conducted as a DRY FIRE EXERCISE ONLY.

Loading procedure:

1. Pick up the rifle with the left hand.
2. Ensure the safety catch is in the ON position.
3. Pump the air rifle, pausing for 3 seconds.
4. Bring the pump handle back to closed position.
5. Simulate loading a pellet, or load an auto indexing five-pellet clip into the feed track.

6. Close the bolt.



Cadets will IMITATE the demonstration provided by the instructor for each step within the skill. The instructor(s) will SUPERVISE the cadets during this imitation.



The following methods may be used when pumping the air rifle:

- **Option 1.** Grasp the pistol grip with the right hand. Grasp the pump handle with the left hand. Push downward with the left hand until the pump handle is fully extended. Wait for a few seconds. Using the left hand, bring the pump handle back to the stock of the rifle. The rifle should remain stationary during the pumping process and always point towards the targets.
- **Option 2.** Grasp the pistol grip with the right hand. Grasp the pump handle with the left hand. Place the butt of the rifle under the right arm or shoulder for support. Push downward with the left hand until the pump handle is fully extended. Wait for a few seconds. Using the left hand, bring the pump handle back to the stock of the rifle allowing the underarm and shoulder to help hold the rifle steady when closing the pump handle. Remember that the rifle must always point towards the targets.
- **Option 3 – Coach Assistance.** Point the rifle in a safe direction and request the assistance from a coach. The coach should move in and pump the rifle using both hands. This should be used as last resorts as any cadet can easily do the above two options.

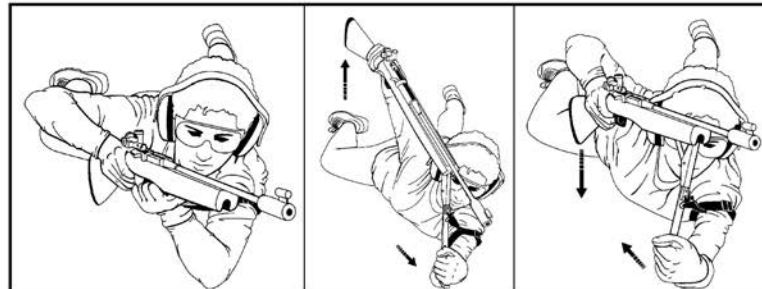

*Cadet Marksmanship Program Reference Manual*

Figure 6-3-7 Pumping the Air Rifle



Do not pump the rifle more than once per shot. This air rifle is designed to withstand the pressure based on a single pump stroke.



The instructor shall provide an EXPLANATION and DEMONSTRATION of the complete skill.

The instructor shall also provide an EXPLANATION and DEMONSTRATION of each step required to effectively complete the skill.

A-CR-CCP-701/PF-001

### UNLOADING THE CADET AIR RIFLE

Follow the unloading sequence of the cadet air rifle, to include:

#### UNLOAD

1. Pick up the air rifle.
2. Remove five-pellet clip (if used).
3. Open the bolt (do not insert a pellet).
4. Pump the air rifle, pausing for 3 seconds.
5. Close the bolt (do not insert a pellet).
6. Place the safety catch in the OFF position.
7. Aim the rifle at the target.
8. Squeeze the trigger.
9. Place the safety catch in the ON position.

#### PREPARE FOR INSPECTION

1. Open the bolt.
2. Open the pump handle slightly.
3. Place the rifle on shoulder, muzzle pointed down range.
4. Wait to be cleared by the RSO.
5. Lay the rifle down.



Cadets will IMITATE the demonstration provided by the instructor for each step within the skill. The instructor(s) will SUPERVISE the cadets during this imitation.

---

#### CONFIRMATION OF TEACHING POINT 4

---



The instructor will divide the group into two, or by the number of air rifles available. The instructor shall have one group imitate the actions of the sequence as demonstrated, while the remainder observe. Have them trade places, and repeat.

---

#### END OF LESSON CONFIRMATION

---

The instructor will divide the group into two, or by the number of air rifles available. The instructor shall have one group imitate the actions of the sequence for all teaching points as demonstrated, while the remainder observe, and then have them trade places, and repeat.

A-CR-CCP-701/PF-001

---

**CONCLUSION**

---

**HOMEWORK/READING/PRACTICE**

N/A.

**METHOD OF EVALUATION**

N/A.

**CLOSING STATEMENT**

The first principle of marksmanship is to find a comfortable shooting position. A comfortable shooting position will enable cadets to shoot safely and with much better results. The prone position is the most stable shooting position to use.

**INSTRUCTOR NOTES/REMARKS**

1. Emphasis must be placed on the safety aspects of this lesson.
2. Ensure thorough confirmation by stages.

---

**REFERENCES**

---

A0-027 A-CR-CCP-177/PT-001 D Cds 3. (2001). *Canadian Cadet Movement: Cadet Marksmanship Programme Reference Manual*. Ottawa, ON: Department of National Defence.

THIS PAGE INTENTIONALLY LEFT BLANK



**MODIFIED LESSON SPECIFICATIONS AND INSTRUCTIONAL GUIDES – TP 1 OF EO M203.01**

A-CR-CCP-702/PG-001

**EO M203.01 – DISCUSS LEADERSHIP WITHIN A PEER SETTING**

1. **Performance.** Discuss Leadership Within a Peer Setting.
2. **Conditions**
  - a. Given:
    - (1) supervision; and
    - (2) assistance as required.
  - b. Denied: N/A.
  - c. Environmental: Suitable classroom facilities or training area large enough to accommodate the entire group.
3. **Standard.** The cadet shall discuss leadership within a peer setting.

4. **Teaching Points**

TP	Description	Method	Time	Ref
TP1	Explain leadership within a peer setting, to include: <ol style="list-style-type: none"> <li>a. responsibilities of a Silver Star cadet, to include:               <ol style="list-style-type: none"> <li>(1) following the chain of command;</li> <li>(2) setting the example;</li> <li>(3) being firm, fair and friendly;</li> <li>(4) being respectful to superiors and subordinates;</li> <li>(5) being aware of safety hazards;</li> <li>(6) displaying initiative; and</li> <li>(7) setting goals; and</li> </ol> </li> <li>b. corps specific Silver Star cadet responsibilities.</li> </ol>	Interactive Lecture	10 min	C0-134

5. **Time**
  - a. Introduction/Conclusion: 5 min
  - b. Interactive Lecture: 10 min
  - c. Total: 15 min
6. **Substantiation.** An interactive lecture was chosen for TP1 to orient the cadets to junior leadership, to generate interest and present basic material.
7. **References.** C0-134 (ISBN 0-7852-7440-5) Maxwell, J. (1999). *The 21 Indispensable Qualities of a Leader: Becoming the Person Others Will Want to Follow*. Nashville, TN: Thomas Nelson Publishers.
8. **Training Aids.** Presentation aids (eg, whiteboard/flipchart/OHP) appropriate for the classroom/training area.
9. **Learning Aids.** N/A.

10. **Test Details.** N/A.
11. **Remarks.** The list of responsibilities in TP1 is not exhaustive. For each corps Silver Star cadet responsibilities may vary.



**COMMON TRAINING  
SILVER STAR  
INSTRUCTIONAL GUIDE**



**SECTION 1**

**EO M203.01 – DISCUSS LEADERSHIP WITHIN A PEER SETTING**

---

Total Time: 15 min

---

---

**PREPARATION**

---

**PRE-LESSON INSTRUCTIONS**

Resources needed for the delivery of this lesson are listed in the lesson specification located in A-CR-CCP-702/PG-001, Chapter 4. Specific uses for said resources are identified throughout the Instructional Guide within the TP for which they are required.

Review the lesson content and become familiar with the material prior to delivering the lesson.

The list of responsibilities of Silver Star cadets will vary for each corps. Information about the specific responsibilities should be available in the corps Standing Orders or by speaking to the corps Commanding Officer/Training Officer.

**PRE-LESSON ASSIGNMENT**

N/A.

**APPROACH**

An interactive lecture was chosen for TP1 to orient the cadets to leadership within a peer setting, to generate interest and to present basic material.

---

**INTRODUCTION**

---

**REVIEW**

N/A.

**OBJECTIVES**

By the end of this lesson the cadet shall be expected to discuss leadership within a peer setting.

**IMPORTANCE**

It is important for cadets to learn about leadership within a peer setting because there are responsibilities for second year cadets. Being aware of the responsibilities second year cadets perform will assist them in setting achievable goals and adapting to their new role as leaders in the corps.

A-CR-CCP-702/PF-001

---

**Teaching Point 1**

**Explain Leadership Within a Peer Setting**

Time: 10 min

Method: Interactive Lecture

---

Within junior leadership, there are responsibilities for a Silver Star cadet at the corps. To make the second year of cadets a fun, challenging and dynamic experience, second year cadets should know their responsibilities.



Have cadets brainstorm a list of what they think the responsibilities of a Silver Star cadet are. As you teach each of the following points, try to match them to the cadet generated list.

There are some responsibilities common to every Red Star cadet in the corps. They are:

- **Following the Chain of Command.** Following the chain of command ensures that all information that must be passed up and down the chain is delivered. Following the chain of command prevents gaps in the information flow.
- **Setting the Example.** A Silver Star cadet must set a personal example in dress and deportment. A good leader will never ask more of their followers and teammates than they are willing to give themselves.
- **Being Firm, Fair and Friendly with Everyone, Especially New Recruits.** No one is impressed with a Silver Star cadet who yells, least of all new cadets. A highly influential and respected Silver Star cadet is one who is consistent in their approach to people and each situation. Being approachable at all times should enable the cadet to fulfill all duties and responsibilities in an effective manner.
- **Being Respectful to Superiors and Subordinates.** Using a proper tone of voice, looking people in the eyes when they speak and standing up straight is a physical way to show respect. If the Silver Star cadet wishes to be treated with respect, they must display respect toward others.
- **Being Aware of Safety Hazards.**
- **Displaying Initiative.** Undertaking small matters, like cleaning up, before being told to do so is an example of using initiative. Superiors notice when small tasks are completed without any request to do so.
- **Setting Goals.** Every leader needs to set goals. Goals allow people the opportunity to turn ideas into results. A goal is a glimpse of the future. Setting goals like improving their drill, dress and deportment, gives Silver Star cadets something to strive for. By setting goals, and working towards them, a Red Star cadet will show commitment.



If the corps has no specific duties for Silver Star cadets, do not teach the following point.

There are specific responsibilities of a Silver Star cadet in this corps.



Explain the corps specific Silver Star cadet responsibilities.

A-CR-CCP-702/PF-001

---

**CONFIRMATION OF TEACHING POINT 1**

---

**QUESTIONS**

- Q1. List the responsibilities of Silver Star cadets in the corps.
- Q2. Why is setting goals important for a Silver Star cadet?
- Q3. List the specific Silver Star cadet duties and responsibilities for your corps.

**ANTICIPATED ANSWERS**

- A1. The responsibilities of every Silver Star cadet in the corps are:
- following the chain of command;
  - setting the example;
  - being firm, fair and friendly with everyone, especially new recruits;
  - being respectful towards your superiors and subordinates;
  - being aware of safety hazards;
  - displaying initiative; and
  - setting goals.
- A2. By setting goals and working towards them, the Silver Star cadet will show commitment.
- A3. Answers will vary.

---

**END OF LESSON CONFIRMATION**

---

The cadets' participation in TP1 will serve as the confirmation of this lesson.

---

**CONCLUSION**

---

**HOMEWORK/READING/PRACTICE**

N/A.

**METHOD OF EVALUATION**

N/A.

**CLOSING STATEMENT**

In order for a cadet to be successful in the role of a Silver Star, they must know their responsibilities. By setting personal short and long term goals, cadets have something to work toward and may be more motivated to complete the tasks ahead.

**INSTRUCTOR NOTES/REMARKS**

N/A.

A-CR-CCP-702/PF-001

---

**REFERENCES**

---

C0-134 (ISBN 0-7852-7440-5) Maxwell, J. (1999). *The 21 Indispensable Qualities of a Leader: Becoming the Person Others Will Want to Follow*. Nashville, TN: Thomas Nelson Publishers.

**MODIFIED LESSON SPECIFICATIONS AND INSTRUCTIONAL GUIDES – TP 1 OF EO M107.02**

A-CR-CCP-701/PG-001

**EO M107.02 – IDENTIFY ARMY CADET RANKS AND OFFICER RANKS**

1. **Performance.** Identify Army Cadet Ranks and Officer Ranks.
2. **Conditions**
  - a. Given:
    - (1) supervision; and
    - (2) assistance as required.
  - b. Denied: N/A.
  - c. Environmental: Suitable classroom facilities or training area large enough to accommodate the entire group.
3. **Standard.** In accordance with specified references, the cadet shall identify the rank structure of the Royal Canadian Army Cadets (RCAC).

4. **Teaching Points**

TP	Description	Method	Time	Ref
TP1	<p>Explain, and confirm through an educational game, the structure and rank insignia of the RCAC, to include:</p> <ol style="list-style-type: none"> <li>a. Private (Pte);</li> <li>b. Corporal (Cpl);</li> <li>c. Master Corporal (MCpl);</li> <li>d. Sergeant (Sgt);</li> <li>e. Warrant Officer (WO);</li> <li>f. Master Warrant Officer (MWO); and</li> <li>g. Chief Warrant Officer (CWO).</li> </ol> <p><b>Note:</b> Explain to cadets that the rank insignia of the Army Cadets is the same as the NCM rank insignia of the army element of the CF.</p>	Interactive Lecture	10 min	A2-030 (pp. 2/5 to 4/5)

5. **Time**
  - a. Introduction/Conclusion: 5 min
  - b. Interactive Lecture: 10 min
  - c. Total: 15 min
6. **Substantiation.** The interactive lecture method was chosen as it best allows the instructor to make a semi-formal presentation of the material allowing the cadets to participate by asking or responding to questions, commenting on the material, or participating in short activities. This method appeals to auditory learners, with the potential for active participation in activities that appeal to tactile/kinaesthetic learners.

A-CR-CCP-701/PG-001

7. **References**

- a. A0-001 A-AD-265-000/AG-001 DHH 3-2. (2001). *Canadian Forces Dress Instructions*. Ottawa, ON: The Department of National Defence.
- b. A0-009 A-AA-100-000/AA-003 Canadian Forces. (2006). *QR&O Chapter 3, Section 1 Ranks and Designations of Ranks*. Ottawa, ON: The Department of National Defence.
- c. A2-030 D Cdts. (2005). CATO 40-03, *Army Cadet Ranks and Cadet Corps Establishment*. In *Cadet Administrative and Training Orders (Vol. 4, 5 pages)*. Ottawa, ON.

8. **Training Aids**

- a. Presentation aids (i.e. whiteboard/flipchart/OHP) appropriate for classroom/training area; and
- b. Royal Canadian Army Cadet Symbols poster.

9. **Learning Aids.** Royal Canadian Army Cadet Symbols poster.

10. **Test Details.** There is no formal assessment of this EO. Instructors will confirm the cadets' knowledge of ranks during the end of lesson check.

11. **Remarks.** Where practical, instructors are encouraged to have the actual rank badges on hand so that the cadets can pass them around. Where not practical, a cut out of the badge could be used.





**ROYAL CANADIAN ARMY CADETS**

**GREEN STAR**

**INSTRUCTIONAL GUIDE**



**SECTION 2**

**EO M107.02 – IDENTIFY ARMY CADET RANKS AND OFFICER RANKS**

---

Total Time: 15 min

---

---

**PREPARATION**

---

**PRE-LESSON INSTRUCTIONS**

Resources needed for the delivery of this lesson are listed in the lesson specification located at Chapter 4 of the QSP. Specific uses for said resources are identified throughout the Instructional Guide, within the teaching point for which they are required.

Review the lesson content, and become familiar with the material prior to instruction of this lesson.

**PRE-LESSON ASSIGNMENT**

N/A.

**APPROACH**

This lesson will be presented using the interactive lecture method. The interactive lecture method was chosen as it best allows the instructor to make a semi-formal presentation of the material allowing the cadets to participate by asking or responding to questions, commenting on the material, or participating in short activities. This method appeals to auditory learners, with the potential for active participation in activities that appeal to tactile/ kinaesthetic learners.

---

**INTRODUCTION**

---

**REVIEW**

N/A.

**OBJECTIVES**

By the end of this lesson the cadet shall be expected to correctly identify the rank structure of the Royal Canadian Army Cadets (RCAC), as well as the ranks of Canadian Forces (CF) Army officers.

**IMPORTANCE**

Being familiar with the ranks of the Army Cadets and officers of the CF will help cadets understand the relationship between cadet ranks and officers at the corps. It will also aid them in interacting effectively with CF members when visiting other CF facilities or bases.

A-CR-CCP-701/PF-001

**Teaching Point 1**

**Explain the Structure and Rank Insignia of the RCAC**

Time: 10 min

Method: Interactive Lecture



It is interesting to note that Army Cadets have the same rank titles and insignia as Non-Commissioned Members (NCMs) in the Canadian Army. Once Army Cadets understand the structure of their own NCMs, they will be able to properly identify those in the Army NCM structure.

**CADET RANKS NON-COMMISSIONED MEMBERS (NCMS)**

Rank is a system of grading seniority and command within military organizations. The gold arrows are referred to as “chevrons”. The more chevrons used, the higher the seniority of the individual.

These chevrons are worn on the upper arm, on the right sleeve of the cadet tunic.



Figure 7-2-1 Non-commissioned Members: Pte – Cpl – MCpl – Sgt

The “Tudor” crown represents the rank of Warrant Officer (WO).

The “Tudor” crown surrounded by a laurel wreath represents the rank of Master Warrant Officer (MWO).

The Canadian Coat of Arms represents the rank of Chief Warrant Officer (CWO).

These ranks are worn low on the sleeve of the right arm of the cadet tunic.



Figure 7-2-2 Non-commissioned Members: WO – MWO – CWO

A-CR-CCP-701/PF-001



Cadet corps affiliated with Engineer Regiments utilize the term “**sapper**” to designate a Pte.

Cadet corps affiliated with Armoured Regiments utilize the term “**trooper**” to designate Pte.

Cadet corps affiliated with the Guard Regiments utilize the term “**guardsman**” to designate Pte.

In cadet corps affiliated with Artillery Regiments, the following terms are used:

- “**Gunner**” designates private;
- “**Bombardier**” designates corporal; and
- “**Master Bombardier**” designates master corporal.

---

### CONFIRMATION OF TEACHING POINT 1

---

#### QUESTIONS

- Q1. Which is more senior, the rank of MCpl or Cpl?
- Q2. Describe the MWO rank badge.
- Q3. What other names may be utilized to denote the rank of Pte?

#### ANTICIPATED ANSWERS

- A1. MCpl.
- A2. Tudor crown surround by a laurel wreath.
- A3. Gunner, guardsman, trooper, sapper or private.

---

### END OF LESSON CONFIRMATION

---

The cadets' participation in TP1 will serve as the confirmation of this lesson.

---

### CONCLUSION

---

#### HOMEWORK/READING/PRACTICE

N/A.

#### METHOD OF EVALUATION

N/A.

#### CLOSING STATEMENT

The cadet, by identifying the ranks of the RCAC and the officers of the CF, will be able to interact more effectively with the different members of each organization.

#### INSTRUCTOR NOTES/REMARKS

N/A.

A-CR-CCP-701/PF-001

---

**REFERENCES**

---

- A0-001 A-AD-265-000/AG-001 DHH 3-2. (2001). *Canadian Forces Dress Instructions*. Ottawa, ON: The Department of National Defence.
- A0-009 A-AA-100-000/AA-003 Canadian Forces. (2006). *QR&O, Chapter 3, Section 1, Ranks and Designations of Ranks*. Ottawa, ON: The Department of National Defence.
- A2-030 D Cdts. (2005). CATO 40-03, *Army Cadet Ranks and Cadet Corps Establishment*. In *Cadet Administrative and Training Orders* (Vol. 4, 5 pages). Ottawa, ON.

**MODIFIED LESSON SPECIFICATIONS AND INSTRUCTIONAL GUIDES – TP 1 OF EO M107.04**

A-CR-CCP-701/PG-001

**EO M107.04 – STATE THE AIMS AND MOTTO OF THE ARMY CADET PROGRAM**

1. **Performance.** State the Aims and Motto of the Army Cadet Program.
2. **Conditions**
  - a. Given:
    - (1) supervision; and
    - (2) assistance as required.
  - b. Denied: N/A.
  - c. Environmental: Suitable classroom facilities or training area large enough to accommodate the entire group.
3. **Standard.** In accordance with specified references, the cadet shall:
  - a. become familiar with the mission and vision of the Cadet Program;
  - b. state the aims of the Army Cadet Program; and
  - c. state the motto of the Army Cadet Program.

4. **Teaching Points**

TP	Description	Method	Time	Ref
TP1	State the mission of the Cadet Program, which is to contribute to the development and preparation of youth for the transition to adulthood, enabling them to meet the challenges of modern society, through a dynamic, community-based program.	Interactive Lecture	10 min	A0-003

5. **Time**
  - a. Introduction/Conclusion: 5 min
  - b. Interactive Lecture: 10 min
  - c. Total: 15 min
6. **Substantiation.** The interactive lecture method was chosen as it best allows the instructor to make a semi-formal presentation of the material allowing the cadets to participate by asking or responding to questions, commenting on the material, or participating in short activities. This method appeals to auditory learners, with the potential for active participation in activities that appeal to tactile/kinaesthetic learners.
7. **References**
  - a. A0-010 D Cdts. (1999). CATO 11-03, *Cadet Program Mandate*. In *Cadet Administrative and Training Orders* (Vol. 1). Ottawa, ON.
  - b. C2-040 The Army Cadet League of Canada. (2006). *Policy 3.1: Aim of the Canadian Cadet Organizations*. Retrieved 25 May 2006, from [http://www.armycadetleague.ca/templates/pdf/refmanual/english/pol\\_3\\_1.pdf](http://www.armycadetleague.ca/templates/pdf/refmanual/english/pol_3_1.pdf).

8. **Training Aids**
  - a. Presentation aids (i.e. whiteboards/flipcharts/OHP) appropriate for classroom/training area; and
  - b. Paper and markers suitable for activities.
9. **Learning Aids.** N/A.
10. **Test Details.** There is no formal assessment of this EO. Instructors will confirm cadets' comprehension of the material during the end of lesson check.
11. **Remarks.** N/A.



ROYAL CANADIAN ARMY CADETS  
GREEN STAR  
INSTRUCTIONAL GUIDE



SECTION 4

EO M107.04 – DESCRIBE THE THREE AIMS OF THE CADET PROGRAM

---

Total Time: 15 min

---

---

PREPARATION

---

**PRE-LESSON INSTRUCTIONS**

Resources needed for the delivery of this lesson are listed in the lesson specification located at Chapter 4 of the QSP. Specific uses for said resources are identified throughout the Instructional Guide, within the teaching point for which they are required.

Review the lesson content and become familiar with the material prior to delivering the lesson.

**PRE-LESSON ASSIGNMENT**

N/A.

**APPROACH**

This lesson will be presented using the interactive lecture method. The interactive lecture method was chosen as it best allows the instructor to make a semi-formal presentation of the material allowing the cadets to participate by asking or responding to questions, commenting on the material, or participating in short activities. This method appeals to auditory learners, with the potential for active participation in activities that appeal to tactile/ kinaesthetic learners.

---

INTRODUCTION

---

**REVIEW**

N/A.

**OBJECTIVES**

By the end of the lesson the cadet shall be expected to state the aims of the army cadet program.

**IMPORTANCE**

Knowing the aims of the army cadet program are fundamental for any cadet. This information will give a better understanding of how the Cadet Program can help them develop both as a cadet and an individual.



A-CR-CCP-701/PF-001

---

**Teaching Point 1**

**Describe the Three Aims of the Cadet Program**

Time: 10 min

Method: Interactive Lecture

---



The aims of the Cadet Program are to:

- develop in youth the attributes of good citizenship and leadership;
- promote physical fitness; and
- stimulate the interest of youth in the sea, land and air activities of the Canadian Forces (CF).

**DEVELOP IN YOUTH THE ATTRIBUTES OF GOOD CITIZENSHIP AND LEADERSHIP**

The Cadet Program aims to assist in the development of cadets as good citizens and leaders.

Through citizenship and community services activities, the cadet develops an appreciation for community membership and involvement within cadet, local, regional, provincial, national and global communities. Cadets' active involvement will have a positive impact on local communities, which will contribute to community strength and vibrancy.

Through leadership activities, cadets develop interpersonal skills and assume responsibility as effective team members, leaders and dynamic coaches. They will develop the ability to conduct themselves in an ethical and socially responsible way.

**PROMOTE PHYSICAL FITNESS**

The Cadet Program aims to promote physical well-being. Cadets develop an understanding of the benefits of fitness and a healthy lifestyle. This understanding, combined with on-going participation in fitness activities, aids in the development of positive attitudes and behaviours that build resiliency within cadets and enable them to meet challenges.

**STIMULATE THE INTEREST OF YOUTH IN THE SEA, LAND AND AIR ACTIVITIES OF THE CF**

The Cadet Program aims to expose youth to the sea, land and air activities of the CF. Cadets develop elemental skills through introduction and interaction with their respective CF communities. The Cadet Program educates and promotes liaison with civilian maritime, adventure and aviation communities. These combined experiences and interactions are essential to the unique identity of the sea, army and air cadet organizations. Also, they distinguish the Cadet Program as a whole from other youth development programs.

---

**CONFIRMATION OF TEACHING POINT 1**

---

**QUESTIONS**

- Q1. What are the three aims of the Cadet Program?
- Q2. How does the Cadet Program promote physical fitness?
- Q3. How does the Cadet Program stimulate an interest in the sea, land and air activities of the Canadian Forces?



A-CR-CCP-701/PF-001

#### ANTICIPATED ANSWERS

- A1. Develop in youth the attributes of good citizenship and leadership, promote physical fitness and stimulate the interest of youth in the sea, land and air activities of the CF.
- A2. The Cadet Program aims to promote physical well-being. Cadets develop an understanding of the **benefits of fitness** and a healthy lifestyle. This understanding, combined with on-going **participation in fitness activities**, aids in the development of **positive attitudes** and behaviours that build resiliency within cadets and enable them to meet challenges.
- A3. The Cadet Program aims to expose youth to the sea, land and air activities of the CF. Cadets develop elemental skills through introduction and interaction with their respective CF communities. The Cadet Program educates and promotes liaison with civilian maritime, adventure and aviation communities. These combined experiences and interactions are essential to the unique identity of the Sea, Army and Air Cadet Organizations. Also, they **distinguish the Cadet Program** as a whole from other youth development programs.

---

#### END OF LESSON CONFIRMATION

---

The cadets' participation in TP1 will serve as the confirmation of this lesson.

---

#### CONCLUSION

---

#### HOMEWORK/READING/PRACTICE

N/A.

#### METHOD OF EVALUATION

N/A.

#### CLOSING STATEMENT

The aims of the Army Cadet Program provide the cadet with a greater understanding of what it means to be an Army Cadet. The tenets of aim will contribute to the development of a sense of pride in belonging to the Army Cadet Program.

#### INSTRUCTOR NOTES/REMARKS

N/A.

---

#### REFERENCES

---

- A0-010 Cdts. (1999). CATO 11-03, *Cadet Program Mandate*. In Cadet Administrative and Training Orders (Vol. 1). Ottawa, ON.
- C2-040 The Army Cadet League of Canada. (2006). *Policy 3.1: Aim of the Canadian Cadet Organizations*. Retrieved 25 May 2006, from [http://www.armycadetleague.ca/templates/pdf/refmanual/english/pol\\_3\\_1.pdf](http://www.armycadetleague.ca/templates/pdf/refmanual/english/pol_3_1.pdf).

THIS PAGE INTENTIONALLY LEFT BLANK

**MODIFIED LESSON SPECIFICATIONS AND INSTRUCTIONAL GUIDES – TP 1 OF EO M222.02**

A-CR-CCP-702/PG-001

**EO M222.02 – DESCRIBE BEARINGS**

1. **Performance.** Describe Bearings.
2. **Conditions**
  - a. Given:
    - (1) compass rose;
    - (2) supervision; and
    - (3) assistance as required.
  - b. Denied: N/A.
  - c. Environmental: Suitable classroom facility or training area large enough to accommodate the entire group.
3. **Standard.** In accordance with B-GL-382-005/PT-001, the cadet shall describe bearings by identifying the 16 points of a compass.

4. **Teaching Points**

TP	Description	Method	Time	Ref
TP1	Identify and explain the 16 points of a compass, to include: <ol style="list-style-type: none"> <li>a. the 4 cardinal points;</li> <li>b. the 4 inter-cardinal points; and</li> <li>c. the 8 intermediate points.</li> </ol>	Interactive Lecture	10 min	A2-041 (p. 47)

5. **Time**
  - a. Introduction/Conclusion: 5 min
  - b. Interactive Lecture: 10 min
  - c. Total: 15 min
6. **Substantiation.** An interactive lecture was chosen for TP1 to present basic material, orient the cadets to bearings, and to generate interest.
7. **References.** A2-041 B-GL-382-005/PT-001 Canadian Forces. (2006). *Maps, Field Sketching, Compasses and the Global Positioning System*. Ottawa, ON: Department of National Defence.
8. **Training Aids**
  - a. Presentation aids (eg, whiteboard/flipchart/OHP) appropriate for classroom/training area;
  - b. Topographical map; and
  - c. Compass rose.
9. **Learning Aids**
  - a. Pencil; and
  - b. Compass rose.

- 10. **Test Details.** N/A.
- 11. **Remarks.** N/A.

A-CR-CCP-702/PF-001



**ROYAL CANADIAN ARMY CADETS**

**RED STAR**

**INSTRUCTIONAL GUIDE**



**SECTION 2**

**EO M222.02 – DESCRIBE BEARINGS**

---

Total Time: 15 min

---

---

**PREPARATION**

---

**PRE-LESSON INSTRUCTIONS**

Resources needed for the delivery of this lesson are listed in the lesson specification located in A-CR-CCP-702/PG-001, Chapter 4. Specific uses for said resources are identified throughout the Instructional Guide within the TP for which they are required.

Review the lesson content and become familiar with the material prior to delivering the lesson.

**PRE-LESSON ASSIGNMENT**

N/A.

**APPROACH**

This lesson will be presented using the interactive lecture method. The interactive lecture method was chosen as it best allows the instructor to make a semi-formal presentation of the material allowing the cadets to participate by asking or responding to questions, commenting on the material, or participating in short activities. This method appeals to auditory learners, with the potential for active participation in activities that appeal to tactile/ kinaesthetic learners.

---

**INTRODUCTION**

---

**REVIEW**

N/A.

**OBJECTIVES**

By the end of this lesson the cadet shall be expected to identify the 16 points of a compass.

**IMPORTANCE**

It is important for cadets to identify the 16 points on a compass as this will assist them in finding the direction of identifiable landmarks on a map. Cadets will rely on this skill set throughout navigation and expedition training.

A-CR-CCP-702/PF-001

**Teaching Point 1**

**Identify and Explain the 16 Points of a Compass**

Time: 10 min

Method: Interactive Lecture



Draw a compass rose (circle) on the board with the four cardinal points. Draw a new line each time you introduce the inter-cardinal and intermediate points.

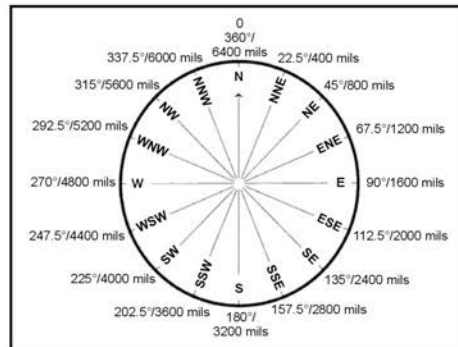

*D Cds 3, 2007, Ottawa, ON: Department of National Defence*

Figure 12-2-1 Compass Rose

**FOUR CARDINAL POINTS**

The four cardinal points of the compass, measured at right angles clockwise are north (N), east (E), south (S) and west (W). They can be easily remembered by the using mnemonics, such as "Never Eat Shredded Wheat".

**FOUR INTER-CARDINAL POINTS**

The four inter-cardinal points are located halfway between each of the cardinal points. Measured clockwise, they are:

1. north-east (NE);
2. south-east (SE);
3. south-west (SW); and
4. north-west (NW).

**EIGHT INTERMEDIATE POINTS**

The eight intermediate points are located halfway between each cardinal point and inter-cardinal point. Measured clockwise, they are:

1. north-north-east (NNE);
2. east-north-east (ENE);
3. east-south-east (ESE);

A-CR-CCP-702/PF-001

4. south-south-east (SSE);
5. south-south-west (SSW);
6. west-south-west (WSW);
7. west-north-west (WNW); and
8. north-north-west (NNW).

---

**CONFIRMATION OF TEACHING POINT 1**

---

**QUESTIONS**

- Q1. What is a mnemonic used to remember the four cardinal points?
- Q2. What are the four inter-cardinal points?
- Q3. How many intermediate points are there?

**ANTICIPATED ANSWERS**

- A1. "Never Eat Shredded Wheat".
- A2. North-east (NE), south-east (SE), south-west (SW) and north-west (NW).
- A3. There are eight intermediate points.

---

**END OF LESSON CONFIRMATION**

---

The cadets' participation in TP1 will serve as the confirmation of this lesson.

---

**CONCLUSION**

---

**HOMEWORK/READING/PRACTICE**

N/A.

**METHOD OF EVALUATION**

N/A.

**CLOSING STATEMENT**

Being able to identify the 16 points on the compass is an important aspect of navigation training, as it allows cadets to identify direction when travelling from one point to another.

**INSTRUCTOR NOTES/REMARKS**

N/A.

---

**REFERENCES**

---

- A2-041 B-GL-382-005/PT-001 Canadian Forces. (2006). *Maps, Field Sketching, Compasses and the Global Positioning System*. Ottawa, ON: Department of National Defence.

THIS PAGE INTENTIONALLY LEFT BLANK



**MODIFIED LESSON SPECIFICATIONS AND INSTRUCTIONAL GUIDES – TP 1 OF EO M222.03**

A-CR-CCP-702/PG-001

**EO M222.03 – IDENTIFY COMPASS PARTS**

1. **Performance.** Identify Compass Parts.
2. **Conditions**
  - a. Given:
    - (1) compass;
    - (2) supervision; and
    - (3) assistance as required.
  - b. Denied: N/A.
  - c. Environmental: Suitable classroom facility or training area large enough to accommodate the entire group.
3. **Standard.** In accordance with B-GL-382-005/PT-001, the cadet shall identify compass parts.
4. **Teaching Points**

TP	Description	Method	Time	Ref
TP1	Identify and describe the parts of the compass, to include: <ol style="list-style-type: none"> <li>a. sight;</li> <li>b. compass cover;</li> <li>c. sighting mirror;</li> <li>d. sighting line;</li> <li>e. luminous index point;</li> <li>f. compass dial;</li> <li>g. dial graduations;</li> <li>h. orienting arrow;</li> <li>i. romer 1:25 000;</li> <li>j. compass base plate;</li> <li>k. declination scale;</li> <li>l. compass meridian lines;</li> <li>m. magnetic needle;</li> <li>n. luminous orienting points;</li> <li>o. luminous index point;</li> <li>p. romer 1:50 000;</li> <li>q. safety cord or lanyard;</li> <li>r. adjustable wrist lock;</li> <li>s. screwdriver; and</li> <li>t. declination adjustment screw.</li> </ol>	Interactive Lecture	10 min	A2-041 (pp. 66 and 67)

5. **Time**

- |    |                          |        |
|----|--------------------------|--------|
| a. | Introduction/Conclusion: | 5 min  |
| b. | Interactive Lecture:     | 10 min |
| c. | Total:                   | 15 min |

6. **Substantiation.** An interactive lecture was chosen for TP1 to present basic material, orient the cadets to the compass, and generate interest.

7. **References**

- a. A2-036 A-CR-CCP-121/PT-001 D Cdts (2003). *Royal Canadian Army Cadet Reference Book*. Ottawa, ON: Department of National Defence.
- b. A2-041 B-GL-382-005/PT-001 Canadian Forces. (2006). *Maps, Field Sketching, Compasses and the Global Positioning System*. Ottawa, ON: Department of National Defence.

8. **Training Aids**

- a. Presentation aids (eg, whiteboard/flipchart/OHP) appropriate for classroom/training area; and
- b. Compass.

9. **Learning Aids.** Compass.

10. **Test Details.** N/A.

11. **Remarks.** N/A.



**ROYAL CANADIAN ARMY CADETS**

**RED STAR**

**INSTRUCTIONAL GUIDE**



**SECTION 3**

**EO M222.03 – IDENTIFY AND DESCRIBE THE PARTS OF THE COMPASS**

---

Total Time: 15 min

---

---

**PREPARATION**

---

**PRE-LESSON INSTRUCTIONS**

Resources needed for the delivery of this lesson are listed in the lesson specification located in A-CR-CCP-702/PG-001, Chapter 4. Specific uses for said resources are identified throughout the Instructional Guide within the TP for which they are required.

Review the lesson content and become familiar with the material prior to delivering the lesson.

**PRE-LESSON ASSIGNMENT**

N/A.

**APPROACH**

An interactive lecture was chosen for this lesson to present basic material, orient the cadets to the compass, and generate interest.

---

**INTRODUCTION**

---

**REVIEW**

N/A.

**OBJECTIVES**

By the end of this lesson the cadet shall have identified the parts of the compass.

**IMPORTANCE**

It is important for cadets to be able to use a compass while navigating during expedition training. Each part of the compass has a specific name used to identify the part and its function. Cadets will rely on this information throughout navigation and expedition training.

A-CR-CCP-702/PF-001

---

**Teaching Point 1**

**Identify and Describe the Parts of the Compass**

Time: 10 min

Method: Interactive Lecture

---



Divide cadets into equal groups according to the number of compasses available. Starting with the compass opened, use the diagram in [Figure 12-3-1](#) to identify the parts of the compass from the top (sight) to the bottom (screwdriver).

**PARTS OF THE COMPASS**

**A – Sight.** Located at the top of the compass cover, the sight is used to align an objective or bearing.

**B – Compass Cover.** The compass cover protects the compass dial and houses the sighting mirror.

**C – Sighting Mirror.** The sighting mirror is used to see the compass dial while setting a bearing.

**D – Sighting Line.** The sighting line is used when aligning the objective or bearing.

**E – Luminous Index Point.** The luminous index point at the top of the compass dial is where a bearing is set and read from.

**F – Compass Dial.** The compass dial houses the magnetic needle, the orienting arrow and the declination scale on the inside and the dial graduations on the outside.

**G – Dial Graduations.** The compass dial is graduated in 50 mil divisions from 0 to 6400 mils, or 2 degree divisions from 0 to 360 degrees. The dial is rotated by hand.

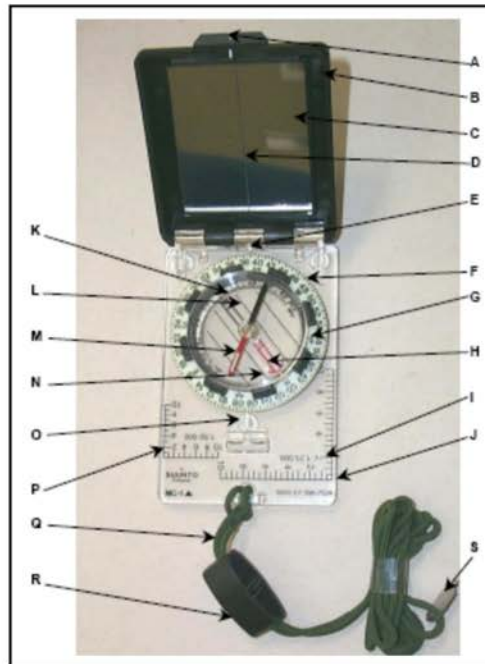

A-CR-CCP-121/PT-001 (p. 5-33)

Figure 12-3-1 Compass

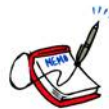

This Instructional Guide is good for use with compasses that have dial graduations in either mils or degrees.

**H – Orienting Arrow.** The red orienting arrow is located inside the compass dial and is used to line up the magnetic needle. The orienting arrow is always set at 00 mils/degrees.

**I – Romer 1:25 000.** This romer is used to measure GR on maps with a 1:25 000 scale.

**J – Compass Base Plate.** The compass base plate is a clear piece of flat plastic, to which the cover, dial and lanyard are attached.

**K – Declination Scale.** The declination scale is used to compensate for the variation of magnetic declination between the compass and the map being used.

**L – Compass Meridian Lines.** Compass meridian lines are black or red lines inside the compass dial and are used to line up the compass dial with the grid lines on a map.

**M – Magnetic Needle.** The magnetic needle spins freely and points to magnetic north. The south end of the compass needle is black and the north end, with a luminous patch, is red.

A-CR-CCP-702/PF-001



When the magnetic needle is lined up with the red orienting arrows, the mnemonic "Red in the Bed" is used to remember which end of the needle belongs between the arrows.

**N – Luminous Orienting Points.** There are two luminous orienting points located on either side of the orienting arrow.

**O – Luminous Index Point.** The luminous orienting point at the bottom of the compass dial is where a back bearing is read from.

**P – Romer 1:50 000.** This romer is used to measure GR on maps with a 1:50 000 scale.

**Q – Safety Cord or Lanyard.** The safety cord is used to fasten the compass to the body.

**R – Adjustable Wrist Lock.** The adjustable wrist lock is used to attach the compass to the wrist.

**S – Screwdriver.** The tiny screwdriver at the end of the safety cord is used to turn the screw to adjust the declination scale.

**T – Declination Adjustment Screw.** The declination adjustment screw is located on the back side of the compass dial and is used to adjust the declination scale (not shown).



When exposed to direct light, all luminous parts of the compass will glow in the dark making operating the compass at night possible.

---

#### CONFIRMATION OF TEACHING POINT 1

---

#### QUESTIONS

- Q1. What is the maximum number of mils or degrees on the dial graduations?
- Q2. What mnemonic is use for putting the magnetic needle between the orienting arrows?
- Q3. What direction does the red part of the magnetic needle point?

#### ANTICIPATED ANSWERS

- A1. 6400 mils or 360 degrees.
- A2. "Red in the Bed".
- A3. Magnetic north.

---

#### END OF LESSON CONFIRMATION

---

#### QUESTIONS

- Q1. What is the screwdriver on the compass used for?
- Q2. What two directions are used to describe declination?
- Q3. What direction is the declination adjusting screw turned to set an east declination?

A-CR-CCP-702/PF-001

**ANTICIPATED ANSWERS**

- A1. To turn the declination adjusting screw.
- A2. East and west.
- A3. Left.

---

**CONCLUSION**

---

**HOMEWORK/READING/PRACTICE**

N/A.

**METHOD OF EVALUATION**

N/A.

**CLOSING STATEMENT**

Compasses are used during navigation and trekking training exercises. Identification of the parts and the proper use of the compass is essential to ensuring accurate navigation.

**INSTRUCTOR NOTES/REMARKS**

N/A.

---

**REFERENCES**

---

- A2-036 A-CR-CCP-121/PT-001 D Cdts (2003). *Royal Canadian Army Cadet Reference Book*. Ottawa, ON: Department of National Defence.
- A2-041 B-GL-382-005/PT-001 Canadian Forces. (2006). *Maps, Field Sketching, Compasses and the Global Positioning System*. Ottawa, ON: Department of National Defence.

THIS PAGE INTENTIONALLY LEFT BLANK



**MODIFIED LESSON SPECIFICATIONS AND INSTRUCTIONAL GUIDES – TP 1 OF EO M122.01**

A-CR-CCP-701/PG-001

**EO M122.01 – IDENTIFY TYPES OF MAPS**

1. **Performance.** Identify Types of Maps.
2. **Conditions**
  - a. Given:
    - (1) examples of different types of maps;
    - (2) topographical map worksheet;
    - (3) supervision; and
    - (4) assistance as required.
  - b. Denied: N/A.
  - c. Environmental: Suitable classroom facilities or training area large enough to accommodate entire group during map work.
3. **Standard.** In accordance with specified references the cadet shall fold a topographical map worksheet, ensuring that the map identification located in the bottom right corner of the map is displayed for easy reference.
4. **Teaching Points**

TP	Description	Method	Time	Ref
TP1	Explain, demonstrate, and have cadets practice folding a map (worksheet) by: <ol style="list-style-type: none"> <li>a. laying the map face up and folding map in half by bringing the top of the map sheet down to the bottom of the map sheet;</li> <li>b. folding the top half of the map sheet up into half again, then turning map over and folding bottom half to match the top half;</li> <li>c. folding the ends of the map into half from left to right; and</li> <li>d. folding each of the open ends back into half again so that the map name and index to adjacent map sheets appear on the outside.</li> </ol>	Demonstration and Performance	10 min	A2-004

5. **Time**
  - a. Introduction/Conclusion: 5 min
  - b. Demonstration and Performance: 10 min
  - c. Total: 15 min
6. **Substantiation.** The demonstration-performance method was chosen for TP1 to allow cadets to participate in supervised exploration of practical instructional material. This method provides the instructor the opportunity to introduce the subject matter, demonstrate and explain procedures, and supervise the cadets while they imitate the skill. This method appeals to all learning styles.

7. **References.** A2-004 B-GL-382-005-FP-001 Canadian Forces. (1976). *Maps, Fields, Sketching, and Compasses* (Vol. 8). Ottawa, ON: The Department of National Defence.
8. **Training Aids**
  - a. Presentation aids (i.e. whiteboard/flipchart/OHP) appropriate for classroom/training area;
  - b. Examples of different types of maps, to include:
    - (1) topographical;
    - (2) orienteering;
    - (3) political;
    - (4) street and road;
    - (5) statistical;
    - (6) digital, including GPS;
    - (7) relief;
    - (8) outline; and
    - (9) air photo; and
  - c. Waterproofing agent for illustration purposes, (e.g. waterproof bags and zipper type).
9. **Learning Aids.** Topographical map worksheet.
10. **Test Details.** There is no formal assessment of this EO. Instructors will confirm the cadets' knowledge of types of maps, care of a map and their ability to fold a map during the end of lesson check.
11. **Remarks**
  - a. Types of maps will be limited to what is available at the corps level. Instructors should attempt to obtain as many examples as are available. Where local resources allow, products such as clear contact paper and chemical coating may be demonstrated.
  - b. Actual maps are not required to practice folding a map. A topographical map worksheet, 8-1/2-in. by 11-in. sheet of paper, newspaper, or retail flyer may be used to represent a map.



ROYAL CANADIAN ARMY CADETS  
GREEN STAR  
INSTRUCTIONAL GUIDE



SECTION 1

EO M122.01 – IDENTIFY TYPES OF MAPS

---

Total Time: 15 min

---

---

PREPARATION

---

**PRE-LESSON INSTRUCTIONS**

Resources needed for the delivery of this lesson are listed in the lesson specification located at Chapter 4 of the QSP. Specific uses for said resources are identified throughout the Instructional Guide, within the teaching point for which they are required.

Review the lesson content, and become familiar with the material prior to instruction of this lesson.

**PRE-LESSON ASSIGNMENT**

N/A.

**APPROACH**

The demonstration and performance method was chosen to allow cadets to participate in supervised exploration of practical instructional material. This method provides the instructor the opportunity to introduce the subject matter, demonstrate and explain procedures, and supervise the cadets while they imitate the skill. This method appeals to all learning styles.

---

INTRODUCTION

---

**REVIEW**

N/A.

**OBJECTIVES**

By the end of this period the cadet shall be expected to properly fold a topographical map sheet.

**IMPORTANCE**

It is important to know how to fold and maintain these maps properly so they will remain serviceable and in good condition.

---

**Teaching Point 1**

**Explain and Demonstrate How to Fold a Map**

Time: 10 min

Method: Demonstration and Performance

---

**FOLDING A MAP**

To properly fold a map, the following steps are to be followed:

A-CR-CCP-701/PF-001

1. Lay the map face up, then fold map in half by bringing the top (north) of the map sheet down to the bottom (south) of the map sheet. Crease where the bend in the map has occurred; this is the centre of the map (see Figure 11-1-1, Step 1).
2. Fold the top half of the map sheet into half again, then turn the map over and fold the bottom half to match the top half (see Figure 11-1-1, Step 2).
3. Fold the ends of the map into half from left to right (see Figure 11-1-1, Step 3).
4. Fold each of the open ends back into half again so that the map name and index to adjacent map sheet appears on the outside (the map should look like the letter M). (see Figure 11-1-1, Step 4).

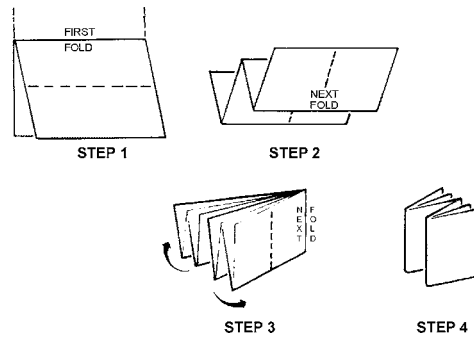

*A-CR-CCP-121/PT-001, Royal Canadian Army Cadets Reference Book*

Figure 11-1-1 Folding of a Map

---

#### CONFIRMATION OF TEACHING POINT 1

---

Have each cadet practice folding the topographical map sheet (located in the Green Star Handbook) in the method described above. An easy way to remember how to fold a map is north to south, south to north, east to west and west to east.

---

#### END OF LESSON CONFIRMATION

---

The cadets' participation in folding a map will serve as the confirmation of this lesson.

---

#### CONCLUSION

---

#### HOMEWORK/READING/PRACTICE

N/A.

#### METHOD OF EVALUATION

N/A.

#### CLOSING STATEMENT

It is important to know how to fold and maintain maps properly so they will remain in good condition for a long time.

A-CR-CCP-701/PF-001

**INSTRUCTOR NOTES/REMARKS**

N/A.

---

**REFERENCES**

---

A2-004 B-GL-382-005/FP-001 Canadian Forces. (1976). *Maps, Fields, Sketching, and Compasses* (Vol. 8). Ottawa, ON: National Defence.

THIS PAGE INTENTIONALLY LEFT BLANK

**MODIFIED LESSON SPECIFICATIONS AND INSTRUCTIONAL GUIDES – TP 1 OF EO M221.05**

A-CR-CCP-702/PG-001

**EO M221.05 – TIE KNOTS**

1. **Performance.** Tie Knots.
2. **Conditions**
  - a. Given:
    - (1) rope for tying knots;
    - (2) railing or dowel;
    - (3) supervision; and
    - (4) assistance as required.
  - b. Denied: N/A.
  - c. Environmental: Suitable classroom facilities or training area large enough to accommodate the entire group.
3. **Standard.** In accordance with specified references, the cadet shall:
  - a. tie and describe the uses of the following knots:
    - (1) bowline;
    - (2) fisherman’s knot;
    - (3) double fisherman’s knot; and
    - (4) double overhand running knot; and
  - b. coil a rope.
4. **Teaching Points**

TP	Description	Method	Time	Ref
TP1	Explain the uses of, demonstrate, and allow time for the cadets to practice tying the following knots: <ol style="list-style-type: none"> <li>a. bowline; and</li> <li>b. fisherman’s knot.</li> </ol> <b>Note:</b> Provide cadets with a handout with tying instructions.	Demonstration and Performance	10 min	C2-007 (p. 116, 117, pp. 162–163, and p. 177)

5. **Time**
  - a. Introduction/Conclusion: 5 min
  - b. Demonstration and Performance: 10 min
  - c. Total: 15 min
6. **Substantiation.** Demonstration and performance was chosen for TP1 as it allows the instructor to explain and demonstrate knot-tying while providing an opportunity for the cadets to practice knot-tying under supervision.

A-CR-CCP-702/PG-001

**7. References**

- a. C2-007 (ISBN 0-7858-1446-9) Pawson, D. (2001). *Pocket Guide to Knots and Splices*. Edison, NJ: Chartwell Books, Inc.
- b. C2-073 (ISBN 0-688-01226-4) Bigon, M. and Regazzoni, G. (1982). *The Morrow Guide to Knots*. New York: Quill/William Morrow.

**8. Training Aids**

- a. Rope for tying knots;
- b. Flipchart paper/blackboard/chalkboard; and
- c. Marker/chalk.

**9. Learning Aids**

- a. Rope for tying knots;
- b. Railing or dowel; and
- c. Knot tying handouts.

**10. Test Details.** N/A.

**11. Remarks**

- a. The rope used for tying knots should be 6 or 7 mm diameter.
- b. Cadets will require at least 6 m (20 feet) of rope for coiling.



A-CR-CCP-702/PF-001



ROYAL CANADIAN ARMY CADETS

RED STAR

INSTRUCTIONAL GUIDE

SECTION 5

EO M221.05 – TIE KNOTS



---

Total Time: 15 min

---

---

**PREPARATION**

---

**PRE-LESSON INSTRUCTIONS**

Resources needed for the delivery of this lesson are listed in the lesson specification located in A-CR-CCP-702/PG-001, Chapter 4. Specific uses for said resources are identified throughout the Instructional Guide within the TP for which they are required.

Review the lesson content and become familiar with the material prior to delivering the lesson.

Make copies of knot-tying instructions, located at [Annex C](#).

**PRE-LESSON ASSIGNMENT**

N/A.

**APPROACH**

Demonstration and performance was chosen for this lesson as it allows the instructor to explain and demonstrate knot-tying while providing an opportunity for the cadets to practice knot-tying under supervision.

---

**INTRODUCTION**

---

**REVIEW**

N/A.

**OBJECTIVES**

By the end of this lesson the cadet shall be expected to coil a rope and tie the following knots:

- bowline; and
- fisherman's knot.

**IMPORTANCE**

It is important for cadets to know how to tie knots. Knots can be used during field training, for building shelters, securing equipment, and also in everyday life.

A-CR-CCP-702/PF-001

---

**Teaching Point 1**

**Explain the Uses of, Demonstrate, and Allow Time to Practice Tying Knots**

Time: 10 min

Method: Practical Activity

---



Provide an explanation and demonstration of the complete knot and then break the knot down into its steps.

Provide a demonstration of each step and have the cadets complete each step. Ensure the cadets have enough time to complete each step.

Each knot must be instructed individually. Distribute handouts with tying instructions (located at [Annex C](#)).

**BOWLINE**

**Uses.** In climbing, it is used as a safety measure during ascent and is clipped into the carabiner. It is often called the rescue knot because it makes a simple loop that does not slip. It can be used to tie around yourself, to throw to someone who needs a lifeline, or to secure objects (such as canoes to a wharf).

**Qualities.** It does not slip, come loose, or jam.

**Faults.** It is difficult to untie when the rope is under strain.

**Procedure**

1. With the standing part of the rope away from you, take the working end in your right hand and place it on top of the standing part.
2. Put your thumb under the standing part.
3. Twist your right hand 180 degrees away from you, to form a simple over hand loop (looks like a number six), and pull the working end up through.
4. Take the working end round behind the standing part.
5. Bring the working end down through the loop. Tighten the bowline by holding on to the bight formed by the end and pulling hard on the standing part.

A-CR-CCP-702/PF-001

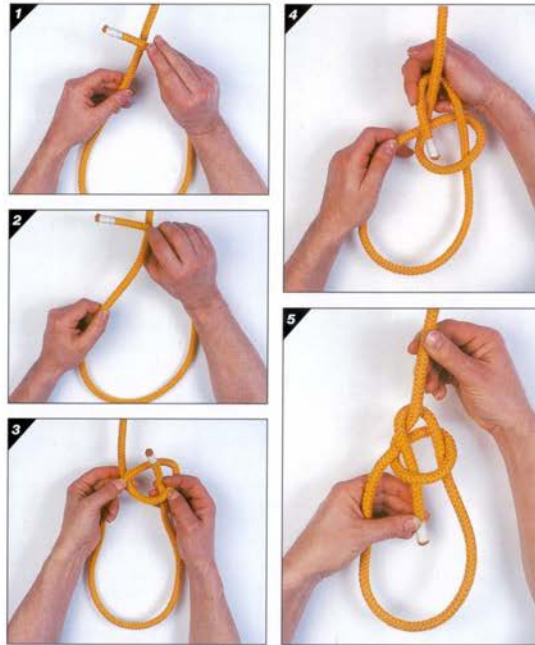

*Pawson, D., Pocket Guide to Knots & Splices, Chartwell Books, Inc. (p. 164)*

Figure 11-5-1 Bowline

### **FISHERMAN'S KNOT**

**Uses.** To join two pieces of rope together. It is commonly used by anglers and climbers.

**Qualities.** It does not slip, come loose, or jam.

**Faults.** It is difficult to untie when fine rope is used.

#### **Procedure**

1. Lay the ropes alongside each other, end to end. Take one of the ropes and bring it over the other and under itself.
2. Make an overhand knot around the second rope.
3. Make an overhand knot around the standing part of the first rope.
4. Slide together to complete the knot.
5. Tighten to finish the fisherman's knot.
6. Tape ends if used in climbing to avoid slipping.

A-CR-CCP-702/PF-001

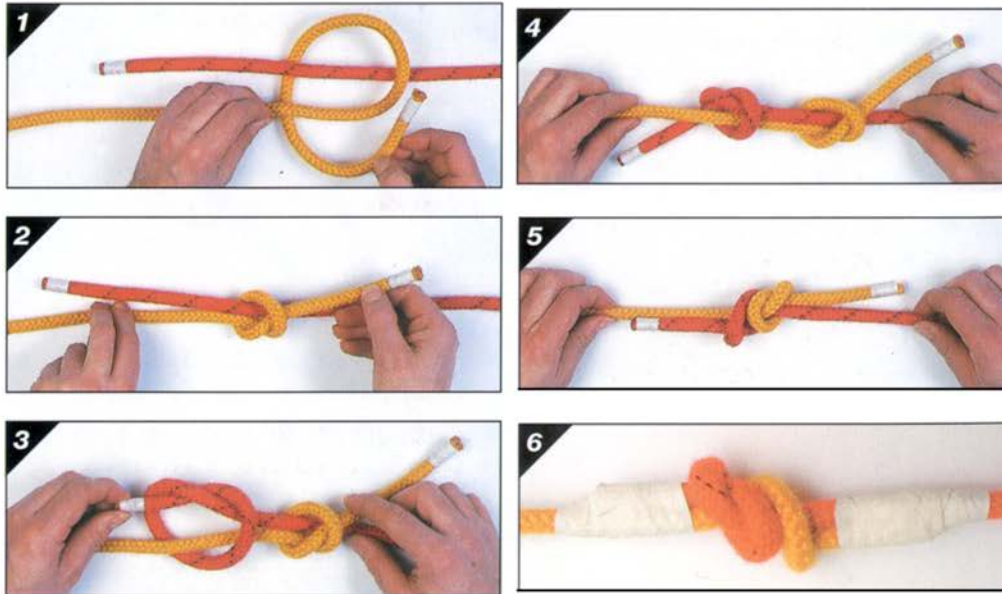

*Pawson, D., Pocket Guide to Knots & Splices, Chartwell Books, Inc. (p. 116)*

Figure 11-5-2 Fisherman's Knot

---

**CONFIRMATION OF TEACHING POINT 1**

---

Tie the following knots:

- bowline; and
- fisherman's knot.

---

**END OF LESSON CONFIRMATION**

---

The cadets' participation in tying knots will serve as the confirmation of this lesson.

---

**CONCLUSION**

---

**HOMEWORK/READING/PRACTICE**

N/A.

**METHOD OF EVALUATION**

N/A.

A-CR-CCP-702/PF-001

**CLOSING STATEMENT**

Knowing what knots to tie when situations arise is an important aspect of field training and can also be used in everyday life. Being able to construct a quality knot will prove useful in a variety of situations such as climbing, towing, and even making a glasses strap or a strap for sunglasses when other means are not available.

**INSTRUCTOR NOTES/REMARKS**

N/A.

---

**REFERENCES**

---

- C2-007 (ISBN 0-7858-1446-9) Pawson, D. (2001). *Pocket Guide to Knots and Splices*. Edison, NJ: Chartwell Books, Inc.
- C2-073 (ISBN 0-688-01226-4) Bigon, M. and Regazzoni, G. (1982). *The Morrow Guide to Knots*. New York, NY: Quill/William Morrow.

THIS PAGE INTENTIONALLY LEFT BLANK

**MODIFIED LESSON SPECIFICATIONS AND INSTRUCTIONAL GUIDES – TP 1 OF EO M221.09**

A-CR-CCP-702/PG-001

**EO M221.09 – MAINTAIN SECTION EQUIPMENT FOLLOWING A FIELD TRAINING EXERCISE (FTX)**

1. **Performance.** Maintain Section Equipment Following a Field Training Exercise (FTX).
2. **Conditions**
  - a. Given:
    - (1) two-burner naphtha stove;
    - (2) dual-generator naphtha lantern;
    - (3) pot set;
    - (4) 4-lb axe (36-inch handle);
    - (5) 24-inch bow saw;
    - (6) ground sheet;
    - (7) supervision; and
    - (8) assistance as required.
  - b. Denied: N/A.
  - c. Environmental: Suitable classroom facilities or training area large enough to accommodate the entire group, after a weekend bivouac exercise.
3. **Standard.** In accordance with *Camping and Wilderness Survival: The Ultimate Outdoors Book*, the cadet shall clean and a groundsheet.
4. **Teaching Points**

TP	Description	Method	Time	Ref
TP1	Explain, demonstrate and have the cadets practice cleaning and storing groundsheets, to include: <ol style="list-style-type: none"> <li>a. washing and drying;</li> <li>b. folding; and</li> <li>c. storing.</li> </ol>	Demonstration and Performance	10 min	

5. **Time**
  - a. Introduction/Conclusion: 5 min
  - b. Demonstration and Performance: 10 min
  - c. Total: 15 min
6. **Substantiation.** Demonstration and performance was chosen for this lesson as it allows the instructor to explain and demonstrate the cleaning and storing of section equipment while providing an opportunity for the cadets to practice these skills.
7. **References.** C0-111 978-0-9740820-2-8 Tawrell, P. (2006). *Camping and Wilderness Survival: The Ultimate Outdoors Book* (2<sup>nd</sup> ed.). Lebanon, NH: Leonard Paul Tawrell.
8. **Training Aids.** Groundsheet.

9. **Learning Aids.** Groundsheet.
10. **Test Details.** N/A.
11. **Remarks.** Equipment used on the previous weekend bivouac/survival FTX may be used for demonstration.





ROYAL CANADIAN ARMY CADETS

RED STAR

INSTRUCTIONAL GUIDE



SECTION 9

**EO M221.09 – MAINTAIN SECTION EQUIPMENT FOLLOWING A FIELD TRAINING EXERCISE (FTX)**

---

Total Time: 15 min

---

---

**PREPARATION**

---

**PRE-LESSON INSTRUCTIONS**

Resources needed for the delivery of this lesson are listed in the lesson specification located in A-CR-CCP-702/PG-001, Chapter 4. Specific uses for said resources are identified throughout the Instructional Guide within the TP for which they are required.

Review the lesson content and become familiar with the material prior to delivering the lesson.

During each TP each group should be given a groundsheet. Have cadets follow along with the instruction, maintaining the equipment as it is covered.

**PRE-LESSON ASSIGNMENT**

N/A.

**APPROACH**

Demonstration and performance was chosen for this lesson as it allows the instructor to explain and demonstrate the cleaning and storing of section equipment while providing an opportunity for the cadets to practice these skills.

---

**INTRODUCTION**

---

**REVIEW**

N/A.

**OBJECTIVES**

By the end of this lesson the cadet shall be expected to clean and store groundsheet.

**IMPORTANCE**

It is important for cadets to learn how to clean and store groundsheet. Cleaning and storing equipment prolongs the life of the equipment. Through regimented cleaning practices, equipment will be slow to corrode and rust ensuring a long life.

A-CR-CCP-702/PF-001

---

**Teaching Point 1**

**Explain, Demonstrate and Have the Cadets Practice  
Cleaning and Storing Groundsheets**

Time: 10 min

Method: Demonstration and Performance

---



Provide each group with a groundsheet. Have cadets follow along with the instruction, cleaning and folding the groundsheet as it is covered.

**WASHING AND DRYING**

Cleaning a groundsheet is only required when it is noticeably covered in dirt or clay. If the groundsheet must be washed, use only water. Any type of cleaning solution will remove the waterproofing elements of the groundsheet. Ensure to thoroughly dry the surfaces, as left over moisture may break down and weaken the groundsheet.

**FOLDING**

To fold the groundsheet complete the following steps:

1. Ensure the groundsheet is completely dry.
2. Lay the groundsheet out, with the inside facing up (Step 1, [Figure 11-9-1](#)).
3. Fold the ends in to make a rectangle (Step 2, [Figure 11-9-1](#)).
4. Fold in half by bringing the right side to the left side (Step 3, [Figure 11-9-1](#)).
5. Fold the ends to the centre – right end to the centre, left end to the centre (Step 4, [Figure 11-9-1](#)).
6. Fold in half bringing right side to the left side (Step 5, [Figure 11-9-1](#)).
7. If the storage bin is smaller make more folds following the same pattern to reach the desired size for storage.

A-CR-CCP-702/PF-001



**STEP 1**



**STEP 2**



**STEP 3**

Figure 11-9-1 (Sheet 1 of 2) Folding a Groundsheet  
*D Cdts 3, 2007, Ottawa, ON: Department of National Defence*

A-CR-CCP-702/PF-001



**STEP 4**



**STEP 5**

Figure 11-9-1 (Sheet 2 of 2) Folding a Groundsheet  
*D Cdts 3, 2007, Ottawa, ON: Department of National Defence*

A-CR-CCP-702/PF-001

### STORING

The groundsheet should be stored in a cool, dry location out of direct sunlight. Storage bins or large plastic containers work well to organize and store groundsheets.

---

### CONFIRMATION OF TEACHING POINT 1

---



The cadets' participation in folding a groundsheet will serve as the confirmation of this TP. Questions have been provided if additional confirmation is required.

### QUESTIONS

- Q1. What should be used to clean a groundsheet?
- Q2. What would a cleaning solution do to a groundsheet?
- Q3. Where should a groundsheet be stored?

### ANTICIPATED ANSWERS

- A1. Water should be used to clean a groundsheet.
- A2. A cleaning solution may damage or remove the waterproofing of the groundsheet.
- A3. A groundsheet should be stored in a cool dry location out of direct sunlight.

---

### END OF LESSON CONFIRMATION

---

The cadets' participation in cleaning and inspecting the equipment will serve as the confirmation of this lesson.

---

### CONCLUSION

---

### HOMEWORK/READING/PRACTICE

N/A.

### METHOD OF EVALUATION

N/A.

### CLOSING STATEMENT

The ability to clean and store groundsheets in the field will prolong its life. Allowing cadets to clean and maintain section equipment will develop a sense of ownership, ensure the items are well cared for and will ensure they last for others to use.

### INSTRUCTOR NOTES/REMARKS

N/A.

A-CR-CCP-702/PF-001

---

**REFERENCES**

---

C0-111 (ISBN 978-0-9740820-2-8) Tawrell, P. (2006). *Camping and Wilderness Survival: The Ultimate Outdoors Book* (2<sup>nd</sup> ed.). Lebanon, NH: Leonard Paul Tawrell.

**MODIFIED LESSON SPECIFICATIONS AND INSTRUCTIONAL GUIDES – TP 1 OF EO M122.05**

A-CR-CCP-701/PG-001

**EO M122.05 – DETERMINE A GRID REFERENCE**

1. **Performance.** Determine a Grid Reference.
2. **Conditions**
  - a. Given:
    - (1) topographical/military maps;
    - (2) material to construct a romer;
    - (3) supervision; and
    - (4) assistance as required.
  - b. Denied: N/A.
  - c. Environmental: Suitable classroom facilities or training area large enough to accommodate entire group during map work.
3. **Standard.** In accordance with specified references, the cadet shall determine four- and six-figure Grid References (GR) (within the correct grid, and to 100 metres accuracy, respectively), for a series of features on a topographical map.

4. **Teaching Points**

TP	Description	Method	Time	Ref
TP1	<p>Explain, demonstrate, and have the cadets practice determining a four-figure GR, in that:</p> <ol style="list-style-type: none"> <li>a. four-figure GRs will have four numerical digits derived from the numbers assigned to the eastings (X axis) and northings (Y axis) on the map sheet;</li> <li>b. the numbers are listed by recording the two-digit easting followed by the two-digit northing; and</li> <li>c. the grid lines that intersect in the bottom left corner of the grid square in question identify the grid square.</li> </ol> <p><b>Note:</b> Instructors will provide three-points for cadets to use to identify the four-figure GR, and three points for cadets to locate using a four-figure GR.</p>	Demonstration and Performance	10 min	A2-004 (Chapter 6, art 602)

5. **Time**
  - a. Introduction/Conclusion: 5 min
  - b. Demonstration and Performance: 10 min
  - c. Total: 15 min
6. **Substantiation.** The demonstration-performance method was chosen to allow cadets to participate in supervised exploration of practical instructional material. This method provides the instructor the

A-CR-CCP-701/PG-001

opportunity to introduce the subject matter, demonstrate and explain procedures, and supervise the cadets while they imitate the skill. This method appeals to all learning styles.

7. **References.** A2-004 B-GL-382-005-FP-001 Canadian Forces. (1976). *Maps, Fields, Sketching, and Compasses* (Vol. 8). Ottawa, ON: The Department of National Defence.
8. **Training Aids**
  - a. Presentation aids (i.e. whiteboard/flipchart/OHP) appropriate for classroom/training area;
  - b. Topographical/military maps;
  - c. Compass with romer; and
  - d. Example of constructed romer.
9. **Learning Aids**
  - a. Topographical/military maps (one per two cadets); and
  - b. Materials for the construction of a romer.
10. **Test Details.** There is no formal assessment of this EO. Instructors will confirm the cadets' knowledge of determining four- and six-figure GRs during the end of lesson check.
11. **Remarks.** Cadets are to be provided with adequate time during FTXs to practice this skill.



A-CR-CCP-701/PF-001



**ROYAL CANADIAN ARMY CADETS**

**GREEN STAR**

**INSTRUCTIONAL GUIDE**



**SECTION 5**

**EO M122.05 – DEMONSTRATE A GRID REFERENCE**

---

Total Time:

15 min

---

**PREPARATION**

---

**PRE-LESSON INSTRUCTIONS**

Resources needed for the delivery of this lesson are listed in the lesson specification located at Chapter 4 of the QSP. Specific uses for said resources are identified throughout the Instructional Guide, within the teaching point for which they are required.

Review the lesson content and become familiar with the material prior to delivering the lesson.

Prior to instructing this lesson the instructor shall pre-select grid references to be used in the practical components of this lesson.

**PRE-LESSON ASSIGNMENT**

N/A.

**APPROACH**

The demonstration and performance method was chosen to allow cadets to participate in supervised exploration of practical instructional material. This method provides the instructor the opportunity to introduce the subject matter, demonstrate and explain procedures, and supervise the cadets while they imitate the skill. This method appeals to all learning styles.

---

**INTRODUCTION**

---

**REVIEW**

N/A.

**OBJECTIVES**

By the end of this lesson the cadet shall be expected to determine four-figure Grid Reference (GR) (within +/- 1000 and 100 metres accuracy, respectively), for a series of features on a topographical map.

**IMPORTANCE**

As an army cadet it is important to know how to use the grid system. Since the grid system is the basis of map reading, the concept of a four-figure GR will be a stepping stone to becoming a strong map-reader. A GR details the location of a grid square on a map, and prevents confusion about location. Communication about exact locations over the radio is made possible with an understanding of a GR.

A-CR-CCP-701/PF-001

---

**Teaching Point 1**

**Explain and Demonstrate a Four-Figure GR**

Time: 10 min

Method: Interactive Lecture

---

**GRID REFERENCE**

The military traditionally identify grid lines by stating the two-digit number of each grid line. When a location is identified using the grid system it is called a "Grid Reference" (GR). When giving a GR to a square, the reference is always to the southwest (bottom left) corner of the square. GRs are always given with the easting value first, followed by the northing value.

**FOUR-FIGURE GR**

A four-figure GR is used to identify a specific 1000 metre by 1000 metres grid square. It will have four numerical digits derived from the numbers assigned to the eastings on the X-axis, and the northings on the Y-axis, where the grid lines intersect at the bottom left corner of the grid square.

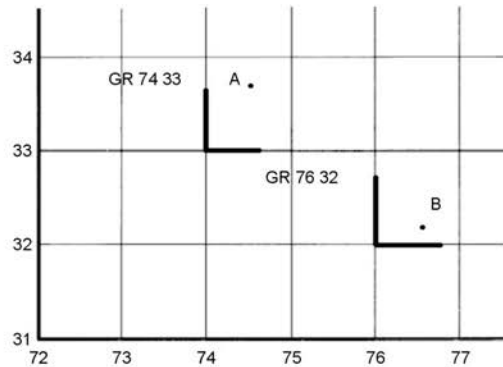

*B-GL-382-005/PF-001, Military Training, Volume 8, Maps, Field Sketching and Compasses*

Figure 11-5-1 Four-Figure GR



The instructor will provide a minimum of three practice points for the cadets to use in determining a four-figure GR. It is important for the cadet to be equally able to identify a location on a map when given the GR and to determine the GR for a location indicated on a map.

---

**CONFIRMATION OF TEACHING POINT 1**

---

**QUESTIONS**

- Q1. When giving a GR, the reference is always to which corner of the square?
- Q2. When giving a four-figure GR, in what order are the numbers given?
- Q3. A four-figure GR identifies a grid square of what size?

**ANTICIPATED ANSWERS**

- A1. Southwest or bottom left corner.

A-CR-CCP-701/PF-001

A2. Eastings then northings, or X-axis then Y-axis.

A3. 1000 metres by 1000 metres.

---

**END OF LESSON CONFIRMATION**

---

The instructor shall provide two points for the cadets to use in determining four-figure GRs.

---

**CONCLUSION**

---

**HOMEWORK/READING/PRACTICE**

N/A.

**METHOD OF EVALUATION**

N/A.

**CLOSING STATEMENT**

Knowing how to determine a four-figure GR is essential for functioning safely in the field, for determining the accurate location of an object or oneself, and for communicating that position to others.

**INSTRUCTOR NOTES/REMARKS**

N/A.

---

**REFERENCES**

---

A2-004 B-GL-382-005-FP-001 Canadian Forces. (1976). *Maps, Fields, Sketching, and Compasses* (Vol. 8). Ottawa, ON: National Defence.

THIS PAGE INTENTIONALLY LEFT BLANK

**MODIFIED LESSON SPECIFICATIONS AND INSTRUCTIONAL GUIDES – TP 1 OF EO M121.02**

A-CR-CCP-701/PG-001

**EO M121.02 – TRANSPORT PERSONAL EQUIPMENT**

1. **Performance.** Transport Personal Equipment.
2. **Conditions**
  - a. Given:
    - (1) examples of equipment;
    - (2) supervision; and
    - (3) assistance as required.
  - b. Denied: N/A.
  - c. Environmental:
    - (1) in-house training: suitable classroom facilities or training area large enough to accommodate entire group; and
    - (2) practical application: field setting, during a weekend bivouac FTX.
3. **Standard.** In accordance with specified references the cadet shall participate in a weekend bivouac FTX that will be of two full days and one evening's duration. They are required to pack and transport their personal equipment to and from the FTX area. Depending on the means by which they will travel to the training area, and the resources available to the cadet corps in terms of backpack availability, this could range from walking into the site carrying a rucksack to being transported by vehicle and dropped off at the site.
4. **Teaching Points**

TP	Description	Method	Time	Ref
TP1	Explain and demonstrate how to properly wear a backpack, by: <ol style="list-style-type: none"> <li>a. loosening shoulder straps;</li> <li>b. bending the knees and holding the shoulder straps;</li> <li>c. lifting and resting the pack on the right (left) thigh;</li> <li>d. putting the right (left) arm through the shoulder strap and swinging it onto the back;</li> <li>e. putting the left (right) arm through the other shoulder strap; and</li> <li>f. clipping the hip belt and tightening the shoulder straps.</li> </ol>	Demonstration and Performance	10 min	C2-017 (pp. 13,14, and 29 to 31)

A-CR-CCP-701/PG-001

TP	Description	Method	Time	Ref
	<p><b>Notes:</b></p> <ol style="list-style-type: none"> <li>1. When properly adjusted, the backpack should leave shoulders and hips free to move. This allows the individual wearing it to stand erect in a normal position and walk at a normal pace.</li> <li>2. If CF rucksacks are to be used, they should be assessed for proper assembly prior to being given to the cadets.</li> </ol>			

5. **Time**

- a. Introduction/Conclusion: 5 min
- b. Demonstration and Performance: 10 min
- c. Total: 15 min

6. **Substantiation.** The demonstration-performance method was chosen to allow cadets to participate in supervised exploration of practical instructional material. This method provides the instructor the opportunity to introduce the subject matter, demonstrate and explain procedures, and supervise the cadets while they imitate the skill. This method appeals to all learning styles.

7. **References**

- a. C2-004 (ISBN 1-896713-00-9) Tawrell, P. (1996). *Camping and Wilderness Survival: The Ultimate Outdoors Book*. Green Valley, ON: Paul Tawrell.
- b. C2-005 (ISBN 0-393-31334-4) Berger, K. (1995). *Hiking and Backpacking, A Trailside Guide*. New York, NY: Norton and Company, Inc.
- c. C2-009 (ISBN 0-684-85909-2) Harvey, M. (1999). *The National Outdoor Leadership School's Wilderness Guide*. New York, NY: Fireside.
- d. C2-017 (ISBN 0-7627-0476-4) Roberts, H. (1999). *Basic Essentials, Backpacking*. Guilford, CT: The Globe Pequot Press.

8. **Training Aids**

- a. Presentation aids (i.e. whiteboard/flipchart/OHP) appropriate for classroom/training area;
- b. Backpacks (external and internal frames); and
- c. Suitable examples of personal equipment.

9. **Learning Aids**

- a. Backpack; and
- b. Personal equipment.

10. **Test Details.** There is no formal assessment of this EO. Instructors will confirm the cadets' comprehension of the material during the end of lesson check. The instructor will also monitor the cadets during the bivouac FTX, advising/correcting as necessary.

A-CR-CCP-701/PG-001

11. **Remarks.** This lesson should be delivered prior to the bivouac FTX. Instructors are encouraged to arrange for cadets at the unit to have their backpacks checked over for proper packing on the night preceding the bivouac FTX.



**ROYAL CANADIAN ARMY CADETS**  
**GREEN STAR**  
**INSTRUCTIONAL GUIDE**



**SECTION 2**

**EO M121.02 – TRANSPORT PERSONAL EQUIPMENT**

---

Total Time: 15 min

---

---

**PREPARATION**

---

**PRE-LESSON INSTRUCTIONS**

Resources needed for the delivery of this lesson are listed in the lesson specification located at Chapter 4 of the QSP. Specific uses for said resources are identified throughout the Instructional Guide, within the TP for which they are required.

Review the lesson content and become familiar with the material prior to delivering the lesson lesson.

**PRE-LESSON ASSIGNMENT**

N/A.

**APPROACH**

The demonstration and performance method was chosen to allow cadets to participate in supervised exploration of practical instructional material. This method provides the instructor the opportunity to introduce the subject matter, demonstrate and explain procedures, and supervise the cadets while they imitate the skill. This method appeals to all learning styles.

---

**INTRODUCTION**

---

**REVIEW**

N/A.

**OBJECTIVES**

By the end of this lesson the cadets will be expected to properly wear a backpack.

**IMPORTANCE**

This lesson will allow cadets to train in the field, and carry their equipment safely and efficiently.



A-CR-CCP-701/PF-001

---

**Teaching Point 1****Explain and Demonstrate How to Properly Wear a Backpack**

Time: 10 min

Method: Demonstration and Performance

---

**DONNING A BACKPACK**

The instructor should inform the cadets that left-handed people might wish to follow these directions using opposite hands, in order to accommodate the dominant hand.

There are many different ways to pick up and don a backpack. If donning is done incorrectly, a back injury can occur. The following is a step-by-step method considered safe for donning a backpack:

1. unlatch hip belt and loosen both shoulder straps;
2. pick the backpack up with your right hand on the crossbar from which the shoulder straps are suspended and left hand on the right strap lift backpack high enough to rest it on your right knee;
3. slide right arm through the shoulder strap and swing it onto your back;
4. put left arm through the other strap;
5. tighten the hip belt and shoulder straps; and
6. ensure all loose belts or strap ends are tucked in and off you go.



When properly adjusted the backpack should leave shoulders and hips free to move. This allows the individual wearing it to stand erect in a normal position and walk at a normal pace.



- Give cadets the opportunity to practice donning the backpack, as time allows.
- If CF rucksacks are to be used, they should be assessed for proper assembly.

---

**CONFIRMATION OF TEACHING POINT 1**

---

**QUESTIONS**

- Q1. What should be loosened prior to donning the backpack?
- Q2. When the backpack is harnessed and on the back, what should one ensure is tucked in?
- Q3. When properly adjusted the backpack should leave the *(blank)* and the *(blank)* free to move.

**ANTICIPATED ANSWERS**

- A1. Unlatch hip belt and loosen both shoulder straps.
- A2. All loose belts or strap ends are tucked in.
- A3. Shoulders and hips.

---

**END OF LESSON CONFIRMATION**

---

The cadets' participation in donning a backpack will serve as the confirmation of this lesson.

---

**CONCLUSION**

---

**HOMEWORK/READING/PRACTICE**

N/A.

**METHOD OF EVALUATION**

N/A.

**CLOSING STATEMENT**

The cadets can now go into the field and carry their equipment and gear safely and effectively.

**INSTRUCTOR NOTES/REMARKS**

N/A.

---

**REFERENCES**

---

- C2-004 (ISBN 1-896713-00-9) Tawrell, P. (1996). *Camping and Wilderness Survival: The Ultimate Outdoors Book*. Green Valley, ON: Paul Tawrell.
- C2-005 (ISBN 0-393-31334-4) Berger, K. (1995). *Hiking and Backpacking, a Trail Side Guide*. New York, NY: Norton and Company, Inc.
- C2-009 (ISBN 0-684-85909-2) Harvey, M. (1999). *The National Outdoor Leadership School's Wilderness Guide*. New York, NY: Fireside.
- C2-017 (ISBN 0-7627-0476-4) Roberts, H. (1999). *Basic Essentials, Backpacking*. Guilford, CT: The Globe Pequot Press.

**MODIFIED LESSON SPECIFICATIONS AND INSTRUCTIONAL GUIDES – TP 1 OF EO M222.02**

A-CR-CCP-702/PG-001

**EO M222.02 – DESCRIBE BEARINGS**

1. **Performance.** Describe Bearings.
2. **Conditions**
  - a. Given:
    - (1) compass rose;
    - (2) supervision; and
    - (3) assistance as required.
  - b. Denied: N/A.
  - c. Environmental: Suitable classroom facility or training area large enough to accommodate the entire group.
3. **Standard.** In accordance with B-GL-382-005/PT-001, the cadet shall identify true, grid, and magnetic north.

4. **Teaching Points**

TP	Description	Method	Time	Ref
TP1	Identify and explain the three norths, to include: <ol style="list-style-type: none"> <li>a. true north;</li> <li>b. grid north; and</li> <li>c. magnetic north.</li> </ol>	Interactive Lecture	10 min	A2-041 (pp. 50-51)

5. **Time**
  - a. Introduction/Conclusion: 5 min
  - b. Interactive Lecture: 10 min
  - c. Total: 15 min
6. **Substantiation.** An interactive lecture was chosen for TP1 to present basic material, orient the cadets to bearings, and to generate interest.
7. **References.** A2-041 B-GL-382-005/PT-001 Canadian Forces. (2006). *Maps, Field Sketching, Compasses and the Global Positioning System*. Ottawa, ON: Department of National Defence.
8. **Training Aids**
  - a. Presentation aids (eg, whiteboard/flipchart/OHP) appropriate for classroom/training area;
  - b. Topographical map; and
  - c. Compass rose.
9. **Learning Aids**
  - a. Pencil; and
  - b. Compass rose.

- 10. **Test Details.** N/A.
- 11. **Remarks.** N/A.

A-CR-CCP-702/PF-001



ROYAL CANADIAN ARMY CADETS

RED STAR

INSTRUCTIONAL GUIDE



SECTION 2

EO M222.02 – DESCRIBE BEARINGS

---

Total Time: 15 min

---

---

PREPARATION

---

**PRE-LESSON INSTRUCTIONS**

Resources needed for the delivery of this lesson are listed in the lesson specification located in A-CR-CCP-702/PG-001, Chapter 4. Specific uses for said resources are identified throughout the Instructional Guide within the TP for which they are required.

Review the lesson content and become familiar with the material prior to delivering the lesson.

**PRE-LESSON ASSIGNMENT**

N/A.

**APPROACH**

An interactive lecture was chosen for this lesson to present basic material, orient the cadets to bearings, and to generate interest.

---

INTRODUCTION

---

**REVIEW**

N/A.

**OBJECTIVES**

By the end of this lesson the cadet shall be expected to identify true, grid, and magnetic north.

**IMPORTANCE**

It is important for cadets to identify and explain the three norths as this may assist them throughout navigation and expedition training.

---

**Teaching Point 1**

**Identify and Explain the Three Norths**

Time: 10 min

Method: Interactive Lecture

---

In navigation there are three different norths that are used – true north, grid north and magnetic north. Each north varies a small amount from each other and must be known for use in navigation. A diagram representing the three norths can be found in the margin of the map being used.

A-CR-CCP-702/PF-001



Draw Figure 12-2-1 on the board and draw the symbol for each north as it is explained to the cadets.

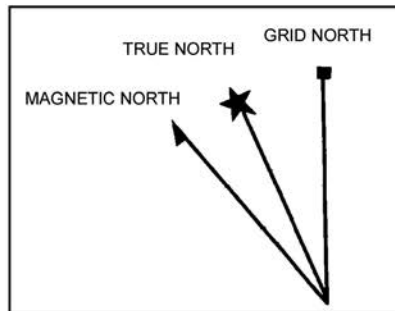

B-GL-382-005/PT-001 (p. 51)

Figure 12-2-1 Three Norths

**True North.** True north is located at the top of the earth where the geographic North Pole is found, and is where all lines of longitude meet. In the diagram on the map, true north is represented by a star (Polaris).

**Grid North.** Grid north is the north indicated by the grid lines (eastings) on a topographical map. The easting lines run parallel to each other and will never meet at the North Pole; because of this, grid north points off slightly from true north. In the diagram on the map, grid north is represented by a square (map grid).

**Magnetic North.** Magnetic north is the direction in which the compass needle points. This direction is to the magnetic pole which is located in the Canadian arctic and is slightly different from true north (North Pole). In the diagram on the map, magnetic north is represented by a needle (compass).

---

#### CONFIRMATION OF TEACHING POINT 1

---

#### QUESTIONS

- Q1. What symbol is used to represent true north?
- Q2. What symbol is used to represent grid north?
- Q3. What symbol is used to represent magnetic north?

#### ANTICIPATED ANSWERS

- A1. A star, as in Polaris.
- A2. A square, as in a grid square.
- A3. A needle, as in a compass.

---

#### END OF LESSON CONFIRMATION

---

The cadets identification of the three norths will serve as the confirmation of this lesson.

A-CR-CCP-702/PF-001

---

**CONCLUSION**

---

**HOMEWORK/READING/PRACTICE**

N/A.

**METHOD OF EVALUATION**

N/A.

**CLOSING STATEMENT**

Being able to identify the three norths is an important aspect of navigation training, as it allows cadets to identify direction when travelling from one point to another.

**INSTRUCTOR NOTES/REMARKS**

N/A.

---

**REFERENCES**

---

A2-041 B-GL-382-005/PT-001 Canadian Forces. (2006). *Maps, Field Sketching, Compasses and the Global Positioning System*. Ottawa, ON: Department of National Defence.

THIS PAGE INTENTIONALLY LEFT BLANK



**INSTRUCTIONAL TECHNIQUES – ASSESSMENT FORM**

Cadet's Name: \_\_\_\_\_

Platoon: \_\_\_\_\_

Lesson Topic: \_\_\_\_\_

Criteria	Comments	Incomplete	Completed With Difficulty	Completed Without Difficulty
<b>PREPARATION</b>				
Selected a lesson location.				
Set up the lesson location.				
Used a lesson plan.				
Selected an appropriate method(s) of instruction.				
Reviewed previous lesson material.				
<b>INTRODUCTION</b>				
Stated what the cadets will learn.				
Stated why it is important.				
Described where the knowledge/skill will be applied.				
<b>BODY</b>				
Applied the principles of instruction. (interest, comprehension, emphasis, participation, accomplishment and confirmation)				
Selected an appropriate instructional aid(s).				

Criteria	Comments	Incomplete	Completed With Difficulty	Completed Without Difficulty
<b>END OF LESSON CONFIRMATION</b>				
Used questions/activity to confirm knowledge or skills.				
<b>CONCLUSION</b>				
Summarized the lesson.				
Re-motivated the cadets.				
Described the next lesson.				
<b>EFFECTIVE-SPEAKING TECHNIQUES</b>				
Applied the elements of voice control. (pitch, tone, volume, speed, pause and articulation)				
Used appropriate body language.				
Maintaining appropriate dress and deportment.				
<b>QUESTIONING TECHNIQUES</b>				
Choose appropriate types of questions.				
Applied the questioning sequence. (pose, pause, pounce, ponder and praise)				
<b>FEEDBACK</b>				

\_\_\_\_\_  
 Assessor's Signature

\_\_\_\_\_  
 Date

\_\_\_\_\_  
 Cadet's Signature

### **LIST OF TOPICS**

1. Your personal involvement within the cadet corps.
2. One fun event in which you took part at a Cadet Summer Training Centre.
3. One subject or topic area you would like to see added to/expanded on in the current training program.
4. One goal you have set or attained while in cadets.
5. Where you see yourself within the corps in the future.
6. One fun event in which you took part with the corps.
7. Your first night as a cadet.
8. Your first trip with the corps.
9. Your first visit to the expedition centre.
10. Why you joined cadets.

THIS PAGE INTENTIONALLY LEFT BLANK

**VERBAL PRESENTATION – FEEDBACK FORM**

Name: \_\_\_\_\_ Date: \_\_\_\_\_

Length: 1 min Start: \_\_\_\_\_ End: \_\_\_\_\_ Total: \_\_\_\_\_

Criteria	Comments	Yes	No
Introduction			
Body			
Conclusion			
Voice			
Body Language			
Dress & Deportment			
Presentation Aid(s)			
<b>Comments:</b>			
<b>Strengths</b>		<b>Areas for Improvement</b>	

\_\_\_\_\_  
 Instructor's Signature

\_\_\_\_\_  
 Cadet's Signature

THIS PAGE INTENTIONALLY LEFT BLANK

## THE LESSON PLAN

The lesson plan is a way for the instructor to organize the lesson and summarize information included in the lesson specification, the IG and their personal ideas. Lesson plans provide a set of detailed directions for delivering one or more periods of instruction.

The lesson plan is arranged in this specific order:

Part	Purpose
1. Introduction	Builds the cadets' interest and motivation.
2. Body	Presents and explains each TP.
3. End of Lesson Confirmation	Confirms cadets' comprehension of the lesson.
4. Conclusion	Summarizes key points and identifies future lessons.

### Introduction

The introduction is the instructor's first verbal interaction with the cadets. It should capture the cadets' interest. The following should be included in the introduction of a lesson plan:

- **What.** A description of what the cadets will be expected to accomplish at the end of the lesson.
- **Why.** A description of how and where the lesson fits into the Cadet Program.
- **Where.** A description of why it is important for the cadets to achieve the objectives.



Read the "Objective" and "Importance" paragraphs in the IG for help in writing the introduction of the lesson plan.

### Body

The body of the lesson plan is where the content is presented, explained and supported. Each TP directs the instructor and the cadets.

Each TP in the lesson includes:

- **Introduction.** Briefly introduce the content to be taught during the TP.
- **Teaching Method.** Identifies which teaching method has been chosen for the given TP.
- **Lesson Content.** Presents the lesson content in a clear and logical order, from easy to difficult or known to unknown.
- **Confirmation.** Confirmation of the TP may be oral questions, games, role-play or an in-class or practical activity. Instructional guides offer suggestions on how to confirm TPs. Instructors may choose to use those confirmation suggestions or develop their own.

### End of Lesson Confirmation

The lesson plan should outline procedures to be used to confirm the learning of the TP. End of lesson confirmations are carried out to ensure that the cadets have understood the whole lesson and that any weaknesses in performance are identified so they may be corrected.

Confirmation activities are based on the lesson objectives. The end of lesson confirmation may be oral questions, games, role-play or an in-class or practical activity. IGs offer suggestions for how to conduct end of lesson confirmations. Instructors may choose to use those confirmation suggestions or develop their own.

## Conclusion

The conclusion of a lesson allows the instructor to give a summary of key points and link them to the coming lessons and their practical use.

- **A Summary of Important Points and Any Weak Areas.** The summary reviews the main TPs. The depth of the summary will be determined by the lesson objectives and the results of the cadets' end of lesson confirmation/test. If the cadets achieved the objectives successfully, the summary may be brief. If they experienced some difficulties, the instructor should summarize them here and indicate how the issue will be addressed.
- **Re-Motivation Statement.** The re-motivation statement restates the importance of the lesson (the "why") and re-motivates the cadets. The instructor should also take this time to give an overview of the next lesson and any precautions the cadets should be aware of when using the knowledge they have gained in a practical setting.



Read the "Closing Statement" paragraph in the IG for help in writing the conclusion of the lesson plan.







**PLAN A DRILL LESSON CHECKLIST**

<b>PREPARATION</b>	<b>NOTES</b>
Have you: <input type="checkbox"/> Selected an appropriate squad formation? <input type="checkbox"/> Written a lesson plan?	
<b>INTRODUCTION</b>	
Does your introduction: <input type="checkbox"/> Review previous lesson material? <input type="checkbox"/> State what the cadets will learn? <input type="checkbox"/> Describe why the movement is important to learn? <input type="checkbox"/> Describe where and when the movement can be used? <input type="checkbox"/> Describe how the cadets will be assessed?	
<b>BODY</b>	
Does the body of your lesson: <input type="checkbox"/> Demonstrate the complete movement with the instructor calling the time? <input type="checkbox"/> Explain the movement? <input type="checkbox"/> Demonstrate and explain the first part of the movement? <input type="checkbox"/> Provide time for the squad to ask questions? <input type="checkbox"/> Permit practice of the first part of the movement (collectively, individually, collectively)? <input type="checkbox"/> Teach the second and each subsequent movement following the sequence described above? <input type="checkbox"/> Permit practice of the complete movement with: <input type="checkbox"/> the instructor calling the time; <input type="checkbox"/> the cadets calling the time; and <input type="checkbox"/> the cadets judging the time? <input type="checkbox"/> Confirm each TP? <input type="checkbox"/> Include two complete demonstrations?	
<b>END OF LESSON CONFIRMATION</b>	
<input type="checkbox"/> Did you conduct an end of lesson confirmation?	
<b>CONCLUSION</b>	

<p>Does your conclusion:</p> <ul style="list-style-type: none"><li><input type="checkbox"/> Restate the movement taught and where or when it will be used?</li><li><input type="checkbox"/> Re-motivate the cadets by:<ul style="list-style-type: none"><li><input type="checkbox"/> comment on the cadets' progress; and</li><li><input type="checkbox"/> re-state why the drill movement just learned is important?</li></ul></li><li><input type="checkbox"/> Describe the next lesson?</li></ul>	
--	--

### **LIST OF APPROVED 15-MINUTE DRILL TOPICS**

Teach the movement of attention from stand at ease and stand at ease from attention, (M108.01 [Adopt the Positions of Attention, Stand at Ease and Stand Easy], A-CR-CCP-701/PG-001, Chapter 4, Section 8, A-CR-CCP-701/PF-001, Chapter 8, Section 1).

Teach the movement of stand easy from stand at ease, and stand at ease from stand easy, (M108.01, A-CR-CCP-701/PG-001, Chapter 4, Section 8, A-CR-CCP-701/PF-001, Chapter 8, Section 1).

Teach a salute to the front, (M108.02 [Execute a Salute at the Halt Without Arms], A-CR-CCP-701/PG-001, Chapter 4, Section 8, A-CR-CCP-701/PF-001, Chapter 8, Section 2).

Teach a salute to the right (left), (M108.02 [Execute a Salute at the Halt Without Arms], A-CR-CCP-701/PG-001, Chapter 4, Section 8, A-CR-CCP-701/PF-001, Chapter 8, Section 2).

Teach the right turn at the halt, (M108.03 [Execute Turns at the Halt], A-CR-CCP-701/PG-001, Chapter 4, Section 8, A-CR-CCP-701/PF-001, Chapter 8, Section 3).

Teach the left turn at the halt, (M108.03 [Execute Turns at the Halt], A-CR-CCP-701/PG-001, Chapter 4, Section 8, A-CR-CCP-701/PF-001, Chapter 8, Section 3).

Teach the about turn at the halt, (M108.03 [Execute Turns at the Halt], A-CR-CCP-701/PG-001, Chapter 4, Section 8, A-CR-CCP-701/PF-001, Chapter 8, Section 3).

THIS PAGE INTENTIONALLY LEFT BLANK

**MODIFIED LESSON SPECIFICATIONS AND INSTRUCTIONAL GUIDES – TP 1 AND 2 OF EO M108.01**

A-CR-CCP-701/PG-001

**EO M108.01 – ADOPT THE POSITIONS OF ATTENTION, STAND AT EASE, AND STAND EASY**

1. **Performance.** Adopt the Positions of Attention, Stand at Ease, and Stand Easy.
2. **Conditions**
  - a. Given:
    - (1) words of command;
    - (2) supervision; and
    - (3) assistance as required.
  - b. Denied: N/A.
  - c. Environmental: A drill hall or, in favourable weather, an outdoor parade square.
3. **Standard.** In accordance with A-PD-201-000/PT-000, the cadet shall perform the following individual drill movements:
  - a. attention from stand at ease; and
  - b. stand at ease from attention.

4. **Teaching Points**

TP	Description	Method	Time	Ref
TP1	Explain and demonstrate the movement of attention from stand at ease and allow cadets to practice.	Demonstration and Performance	5 min	A0-002 (pp. 2-2 to 2-8)
TP2	Explain and demonstrate the movement of stand at ease from attention and allow cadets to practice.	Demonstration and Performance	5 min	A0-002 (pp. 2-2 to 2-8)

5. **Time**
  - a. Introduction/Conclusion: 5 min
  - b. Demonstration and Performance: 10 min
  - c. Total: 15 min
6. **Substantiation.** The demonstration-performance method was chosen to allow cadets to participate in supervised exploration of practical instructional material. This method provides the instructor the opportunity to introduce the subject matter, demonstrate and explain procedures, and supervise the cadets while they imitate the skill. This method appeals to all learning styles.
7. **References.** A0-002 A-PD-201-000/PT-000 DHH 3-2. (2001). *The Canadian Forces Manual of Drill and Ceremonial*. Ottawa, ON: The Department of National Defence.
8. **Training Aids.** Assistant instructors as required.
9. **Learning Aids.** N/A.

A-CR-CCP-701/PG-001

10. **Test Details.** There is no formal assessment of this EO. Instructors will confirm the cadets' ability to perform the movements during the end of lesson check, and ongoing feedback will be provided during future drill practices, weekly parade nights, and ceremonial parades.
11. **Remarks.** N/A.



A-CR-CCP-701/PF-001



COMMON TRAINING  
GREEN STAR  
INSTRUCTIONAL GUIDE



SECTION 1

EO M108.01 – ADOPT THE POSITIONS OF ATTENTION, STAND AT EASE AND STAND EASY

---

Total Time: 15 min

---

---

PREPARATION

---

**PRE-LESSON INSTRUCTIONS**

A complete list of resources needed for the instruction of this EO is located at Chapter 4 of the QSP. Specific uses for said stores are identified throughout the Instructional Guide, within the teaching point for which they are required.

Prior to instructing this lesson the instructor shall:

- review the lesson content, and become familiar with the material; and
- select the most effective squad formation for the lesson being taught. A squad may be in a single rank, hollow square or semi-circle for elementary drill instruction. (Note: All cadets **must** be able to fully observe all demonstrations and explanations.)

**PRE-LESSON ASSIGNMENT**

N/A.

**APPROACH**

This lesson will be presented using the demonstration and performance method. The demonstration and performance method was chosen to allow cadets to participate in supervised exploration of practical instructional material. This method provides the instructor the opportunity to introduce the subject matter, demonstrate and explain procedures, and supervise the cadets while they imitate the skill. This method appeals to all learning styles.



The instructor shall develop and use a vocabulary of short, concise words to impress on the squad that the movements must be performed smartly. For example, the words “crack”, “drive”, “seize” and “grasp” suggest the degree of smartness required. Profanity or personal sarcasm shall never be used.

---

INTRODUCTION

---

**REVIEW**

N/A.

A-CR-CCP-701/PF-001

## OBJECTIVES

By the end of this lesson the cadet shall be expected to adopt the positions of attention and stand at ease.

## IMPORTANCE

As members of the Canadian Cadet Movement (CCM) cadets will be required to perform drill movements at a competent level, developing sharpness, esprit de corps, physical coordination, and alertness. These movements will be executed with ease and without hesitation. Ensuring that the cadets efficiently move together as one will promote discipline, alertness, precision, pride, steadiness, and cohesion. This develops the basis of teamwork that the CCM depends on.

---

### Teaching Point 1

### Adopting the Position of Attention From Stand at Ease

Time: 5 min

Method: Demonstration and Performance

---



Instructors are reminded that they are to present the example with regards to drill, from the moment they step onto the parade square. Proper drill movements, combined with a professional demeanour, are of paramount importance, and must be exemplified throughout the period of instruction.

### DEMONSTRATE THE COMPLETE MOVEMENT WITH TIMING

The instructor shall provide a complete demonstration of the drill movement, with timing. A practiced assistant instructor may carry out this demonstration.

The demonstration shall be provided from various vantage points, as required.

### DEMONSTRATE FIRST PART OF MOVEMENT (FIRST NUMBER)



For ease of instruction, drill commands have been broken down into individual movements, or numbers. The instructor(s) shall demonstrate and explain each number.

In order to adopt the position of attention from stand at ease, the cadet shall:

On the command ATTENTION BY NUMBERS, SQUAD – ONE, bend the left knee and shift the balance to the right foot.

### PRACTICE THE SQUAD ON THE FIRST MOVEMENT

Practice the squad on the first movement collectively, individually and collectively.

### DEMONSTRATE AND EXPLAIN THE SECOND PART OF THE MOVEMENT

On the command SQUAD – TWO:

1. straighten the left leg in double time, place the foot smartly on the ground, toe touching first, followed by the heel, and with heels aligned; and
2. simultaneously, with a quick motion, bring the arms and hands to the position of attention.

A-CR-CCP-701/PF-001

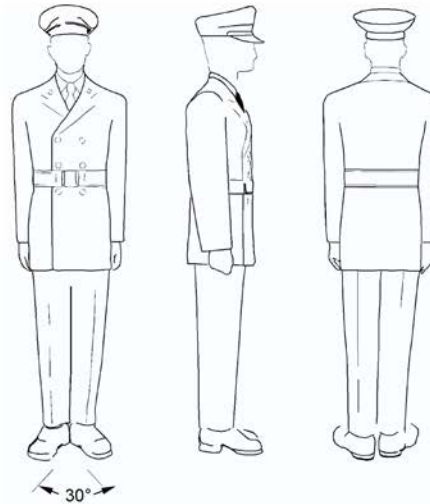

A-PD-201-000/PT-000, *The Canadian Forces Manual of Drill and Ceremonial, 2001*

Figure 8-1-1 The Position of Attention



A-PD-201-000/PT-000, *The Canadian Forces Manual of Drill and Ceremonial, 2001*

Figure 8-1-2 Fists at Position of Attention



Constant checking and correcting of all faults is essential. Faults shall be corrected immediately after they occur.

**GIVE TWO COMPLETE AND FINAL DEMONSTRATIONS**

On the command ATTEN – TION, combine the two movements. The timing is called as “one.”

The instructor(s) shall provide a full demonstration and allow time for practice.

---

**CONFIRMATION OF TEACHING POINT 1**

---

Cadet will adopt the position of attention as a squad.

A-CR-CCP-701/PF-001

---

**Teaching Point 2**

**Adopting the Position of Stand at Ease From Attention**

Time: 5 min

Method: Demonstration and Performance

---

**DEMONSTRATE THE COMPLETE MOVEMENT WITH TIMING**

The position of standing at ease is an intermediate position between attention and standing easy. It allows no relaxation, but can be maintained without strain for a longer time than the position of attention.

**DEMONSTRATE FIRST PART OF MOVEMENT (FIRST NUMBER)**



For ease of instruction, drill commands have been broken down into individual movements, or numbers. The instructor(s) shall demonstrate and explain each number.

On the command STAND AT EASE BY NUMBERS, SQUAD – ONE, the cadet shall bend the left knee.



*A-PD-201-000/PT-000, The Canadian Forces Manual of Drill and Ceremonial, 2001*

Figure 8-1-3 Squad One – Stand at Ease

**PRACTICE THE SQUAD ON THE FIRST MOVEMENT**

Practice the squad on the first movement collectively, individually and collectively.

**DEMONSTRATE AND EXPLAIN THE SECOND PART OF THE MOVEMENT (SECOND NUMBER)**

On the command SQUAD – TWO, the cadet shall:

1. carry the left foot to the left, straightening it in double time, and place it smartly flat on the ground with the inside of the heels 25 cm apart;
2. simultaneously, with a quick motion, bring the arms behind the back, stretched to their full extent, and place the back of the right hand in the palm of the left, with thumbs crossed right over left, the fingers together and extended; and
3. balance the body with the weight evenly distributed on both feet.

A-CR-CCP-701/PF-001

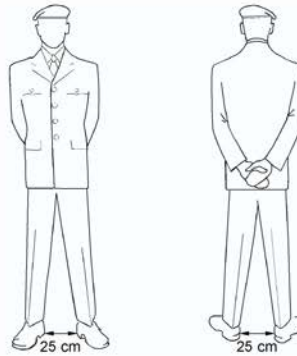

A-PD-201-000/PT-000, *The Canadian Forces Manual of Drill and Ceremonial, 2001*

Figure 8-1-4 The Position of Stand at Ease

**PRACTICE THE SQUAD ON THE SECOND MOVEMENT**

Practice the squad on the second movement collectively, individually and collectively.

**GIVE TWO COMPLETE AND FINAL DEMONSTRATIONS**

On the command STAND AT – EASE, combine the two movements. The timing is “one.”

The instructor(s) shall provide a full demonstration and allow time for practice



Constant checking and correcting of all faults is essential. Faults shall be corrected immediately after they occur.

---

**CONFIRMATION OF TEACHING POINT 2**

---

Cadets will adopt the position of stand at ease as a squad.

---

**END OF LESSON CONFIRMATION**

---

The confirmation for this lesson should consist of the cadets, as a squad, practicing the positions of attention, stand at ease and stand easy, and should emphasize movements that cadets showed difficulty with during the class.

**Practice the complete movement, with the:**

- **instructor** calling the time;
- **squad** calling the time; and
- squad **judging** the time.

A-CR-CCP-701/PF-001

---

**CONCLUSION**

---

**HOMEWORK/READING/PRACTICE**

Drill movements are skills that must be practiced individually, in order to make the cadet more proficient as a member of a unit. Cadets are encouraged to practice the movements, as opportunities are made available. Ongoing feedback will be provided, and should be heeded during any drill practice.

**METHOD OF EVALUATION**

In accordance with A-PD-201-000/PT-000, *The Canadian Forces Manual of Drill and Ceremonial*, the cadet shall participate in an Annual Ceremonial Review (ACR) parade. This movement will be used in preparation for, and in the execution of, the ACR parade.

**CLOSING STATEMENT**

The hallmarks of cadet drill are efficiency, precision, and dignity. These qualities are developed through self-discipline and practice. They lead to unit pride and cohesion. Good drill that is well rehearsed, closely supervised and precise, is an exercise in obedience and alertness. It sets the standard for the execution of any duty, both for the individual and the unit, and builds a sense of confidence between commander and subordinate that is essential to high morale. The personal qualities developed on the parade ground must be maintained in all aspects of life.

**INSTRUCTOR NOTES/REMARKS**

N/A.

---

**REFERENCES**

---

A0-002 A-PD-201-000/PT-000 DHH 3-2. (2001). *The Canadian Forces Manual of Drill and Ceremonial*. Ottawa, ON: The Department of National Defence.

**MODIFIED LESSON SPECIFICATIONS AND INSTRUCTIONAL GUIDES – TP 1 AND 2 OF EO M108.01**

A-CR-CCP-701/PG-001

**EO M108.01 – ADOPT THE POSITIONS OF ATTENTION, STAND AT EASE, AND STAND EASY**

1. **Performance.** Adopt the Positions of Attention, Stand at Ease, and Stand Easy.
2. **Conditions**
  - a. Given:
    - (1) words of command;
    - (2) supervision; and
    - (3) assistance as required.
  - b. Denied: N/A.
  - c. Environmental: A drill hall or, in favourable weather, an outdoor parade square.
3. **Standard.** In accordance with A-PD-201-000/PT-000, the cadet shall perform the following individual drill movements:
  - a. stand easy from stand at ease; and
  - b. stand at ease from stand easy.

4. **Teaching Points**

TP	Description	Method	Time	Ref
TP1	Explain and demonstrate the movement of stand easy from stand at ease and allow cadets to practice.	Demonstration and Performance	5 min	A0-002 (pp. 2-2 to 2-8)
TP2	Explain and demonstrate the movement of stand at ease from stand easy and allow cadets to practice.	Demonstration and Performance	5 min	A0-002 (pp. 2-2 to 2-8)

5. **Time**
  - a. Introduction/Conclusion: 5 min
  - b. Demonstration and Performance: 10 min
  - c. Total: 15 min
6. **Substantiation.** The demonstration-performance method was chosen to allow cadets to participate in supervised exploration of practical instructional material. This method provides the instructor the opportunity to introduce the subject matter, demonstrate and explain procedures, and supervise the cadets while they imitate the skill. This method appeals to all learning styles.
7. **References.** A0-002 A-PD-201-000/PT-000 DHH 3-2. (2001). *The Canadian Forces Manual of Drill and Ceremonial*. Ottawa, ON: The Department of National Defence.
8. **Training Aids.** Assistant instructors as required.
9. **Learning Aids.** N/A.



A-CR-CCP-701/PG-001

10. **Test Details.** There is no formal assessment of this EO. Instructors will confirm the cadets' ability to perform the movements during the end of lesson check, and ongoing feedback will be provided during future drill practices, weekly parade nights, and ceremonial parades.
11. **Remarks.** N/A.



A-CR-CCP-701/PF-001



COMMON TRAINING  
GREEN STAR  
INSTRUCTIONAL GUIDE



SECTION 1

EO M108.01 – ADOPT THE POSITIONS OF ATTENTION, STAND AT EASE AND STAND EASY

---

Total Time: 15 min

---

PREPARATION

---

PRE-LESSON INSTRUCTIONS

A complete list of resources needed for the instruction of this EO is located at Chapter 4 of the QSP. Specific uses for said stores are identified throughout the Instructional Guide, within the teaching point for which they are required.

Prior to instructing this lesson the instructor shall:

- review the lesson content, and become familiar with the material; and
- select the most effective squad formation for the lesson being taught. A squad may be in a single rank, hollow square or semi-circle for elementary drill instruction. (Note: All cadets **must** be able to fully observe all demonstrations and explanations.)

PRE-LESSON ASSIGNMENT

N/A.

APPROACH

This lesson will be presented using the demonstration and performance method. The demonstration and performance method was chosen to allow cadets to participate in supervised exploration of practical instructional material. This method provides the instructor the opportunity to introduce the subject matter, demonstrate and explain procedures, and supervise the cadets while they imitate the skill. This method appeals to all learning styles.



The instructor shall develop and use a vocabulary of short, concise words to impress on the squad that the movements must be performed smartly. For example, the words “crack”, “drive”, “seize” and “grasp” suggest the degree of smartness required. Profanity or personal sarcasm shall never be used.

---

INTRODUCTION

---

REVIEW

N/A.

A-CR-CCP-701/PF-001

### OBJECTIVES

By the end of this lesson the cadet shall be expected to adopt the positions of stand easy and stand at ease.

### IMPORTANCE

As members of the Canadian Cadet Movement (CCM) cadets will be required to perform drill movements at a competent level, developing sharpness, esprit de corps, physical coordination, and alertness. These movements will be executed with ease and without hesitation. Ensuring that the cadets efficiently move together as one will promote discipline, alertness, precision, pride, steadiness, and cohesion. This develops the basis of teamwork that the CCM depends on.

---

#### Teaching Point 1

#### Adopting the Position of Stand Easy

Time: 5 min

Method: Demonstration and Performance

---

### DEMONSTRATE THE COMPLETE MOVEMENT WITH TIMING



Instructors are reminded that they are to present the example with regards to drill, from the moment they step onto the parade square. Proper drill movements, combined with a professional demeanour, are of paramount importance, and must be exemplified throughout the period of instruction.

### DEMONSTRATE THE COMPLETE MOVEMENT WITH TIMING

The instructor shall provide a complete demonstration of the drill movement, with timing. A practiced assistant instructor may carry out this demonstration.

The demonstration shall be provided from various vantage points, as required.

The position of stand easy is ordered when it is desirable to permit cadets to relax. This command is only given when the squad is in the position of stand at ease.

On the command STAND – EASY, the cadet shall:

1. close the hands and bring the arms to the position of attention: and
2. relax.

A-CR-CCP-701/PF-001

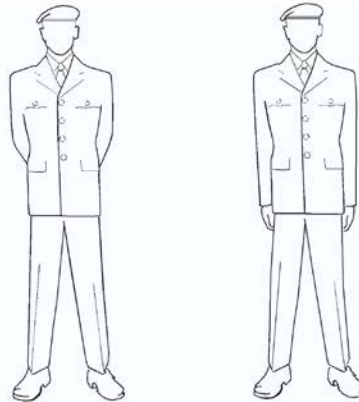

A-PD-201-000/PT-000, *The Canadian Forces Manual of Drill and Ceremonial, 2001*

Figure 8-1-1 Stand Easy From Stand at Ease



When standing easy, the cadet may, with permission, move all but the feet and adjust clothing and equipment, but shall not talk.

**PRACTICE THE COMPLETE MOVEMENT WITH TIMING**

Practice the squad on the first movement collectively, individually and collectively.

**GIVE TWO COMPLETE AND FINAL DEMONSTRATIONS**

Combine the preceding movements with timing. The instructor(s) shall provide a full demonstration and allow time for practice.



Constant checking and correcting of all faults is essential. Faults shall be corrected immediately after they occur.

---

**CONFIRMATION OF TEACHING POINT 1**

---

Cadets will adopt the position of stand easy as a squad.

---

**Teaching Point 2**

**Adopting the Position of Stand at Ease from Standing Easy**

Time: 5 min

Method: Demonstration and Performance

---

**DEMONSTRATE THE COMPLETE MOVEMENT WITH TIMING**

The instructor shall provide a complete demonstration of the drill movement, with timing. A practiced assistant instructor may carry out this demonstration.

A-CR-CCP-701/PF-001

The demonstration shall be provided from various vantage points, as required.

In order to adopt the position of stand at ease from easy the cadet shall, on the cautionary command SQUAD (or formation title), assume the position of stand at ease.

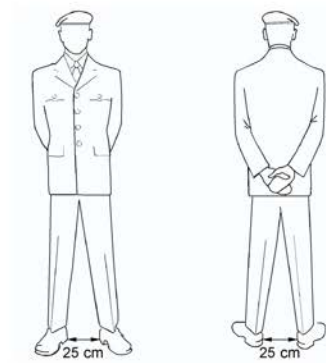

Figure 8-1-2 The Position of Stand at Ease



This TP is best taught as a group practice to ensure adherence to timings and togetherness of the squad.



Constant checking and correcting of all faults is essential. Faults shall be corrected immediately after they occur.

---

#### CONFIRMATION OF TEACHING POINT 2

---

Cadets will adopt the position of stand at ease as a squad.

---

#### END OF LESSON CONFIRMATION

---

The confirmation for this lesson should consist of the cadets, as a squad, practicing the positions of attention, stand at ease and stand easy, and should emphasize movements that cadets showed difficulty with during the class.

**Practice the complete movement, with the:**

- **instructor** calling the time;
- **squad** calling the time; and
- squad **judging** the time.

A-CR-CCP-701/PF-001

---

## CONCLUSION

---

### HOMEWORK/READING/PRACTICE

Drill movements are skills that must be practiced individually, in order to make the cadet more proficient as a member of a unit. Cadets are encouraged to practice the movements, as opportunities are made available. Ongoing feedback will be provided, and should be heeded during any drill practice.

### METHOD OF EVALUATION

In accordance with A-PD-201-000/PT-000, *The Canadian Forces Manual of Drill and Ceremonial*, the cadet shall participate in an Annual Ceremonial Review (ACR) parade. This movement will be used in preparation for, and in the execution of, the ACR parade.

### CLOSING STATEMENT

The hallmarks of cadet drill are efficiency, precision, and dignity. These qualities are developed through self-discipline and practice. They lead to unit pride and cohesion. Good drill that is well rehearsed, closely supervised and precise, is an exercise in obedience and alertness. It sets the standard for the execution of any duty, both for the individual and the unit, and builds a sense of confidence between commander and subordinate that is essential to high morale. The personal qualities developed on the parade ground must be maintained in all aspects of life.

### INSTRUCTOR NOTES/REMARKS

N/A.

---

## REFERENCES

---

A0-002 A-PD-201-000/PT-000 DHH 3-2. (2001). *The Canadian Forces Manual of Drill and Ceremonial*. Ottawa, ON: The Department of National Defence.

THIS PAGE INTENTIONALLY LEFT BLANK

**MODIFIED LESSON SPECIFICATIONS AND INSTRUCTIONAL GUIDES – TP 1 OF EO M108.02**

A-CR-CCP-701/PG-001

**EO M108.02 – EXECUTE A SALUTE AT THE HALT WITHOUT ARMS**

1. **Performance.** Execute a Salute at the Halt Without Arms.
2. **Conditions**
  - a. Given:
    - (1) words of command;
    - (2) supervision; and
    - (3) assistance as required.
  - b. Denied: N/A.
  - c. Environmental: A drill hall or, in favourable weather, an outdoor parade square.
3. **Standard.** In accordance with A-PD-201-000/PT-000, the cadet shall execute salutes at the halt without arms, to the front.

4. **Teaching Points**

TP	Description	Method	Time	Ref
TP1	Explain and demonstrate saluting to the front at the halt and allow cadets to practice.	Demonstration and Performance	10 min	A0-002 (pp. 2-10 to 2-12)

5. **Time**
  - a. Introduction/Conclusion: 5 min
  - b. Demonstration and Performance: 10 min
  - c. Total: 15 min
6. **Substantiation.** The demonstration-performance method was chosen to allow cadets to participate in supervised exploration of practical instructional material. This method provides the instructor the opportunity to introduce the subject matter, demonstrate and explain procedures, and supervise the cadets while they imitate the skill. This method appeals to all learning styles.
7. **References.** A0-002 A-PD-201-000/PT-000 DHH 3-2. (2001). *The Canadian Forces Manual of Drill and Ceremonial*. Ottawa, ON: The Department of National Defence.
8. **Training Aids.** Assistant instructors as required.
9. **Learning Aids.** N/A.
10. **Test Details.** There is no formal assessment of this EO. Instructors will confirm the cadets' ability to perform the movements during the end of lesson check, and ongoing feedback will be provided during future drill practices, weekly parade nights, and ceremonial parades.
11. **Remarks.** N/A.



COMMON TRAINING  
GREEN STAR  
INSTRUCTIONAL GUIDE



SECTION 2

EO M108.02 – EXECUTE A SALUTE AT THE HALT WITHOUT ARMS

---

Total Time: 15 min

---

PREPARATION

---

**PRE-LESSON INSTRUCTIONS**

A complete list of resources needed for the instruction of this EO is located at Chapter 4 of the QSP. Specific uses for said stores are identified throughout the Instructional Guide, within the teaching point for which they are required.

Prior to instructing this lesson the instructor shall:

- review the lesson content, and become familiar with the material; and
- select the most effective squad formation for the lesson being taught. A squad may be in a single rank, hollow square or semi-circle for elementary drill instruction. (Note: All cadets **must** be able to fully observe all demonstrations and explanations.)

**PRE-LESSON ASSIGNMENT**

N/A.

**APPROACH**

This lesson will be presented using the demonstration and performance method. The demonstration and performance method was chosen to allow cadets to participate in supervised exploration of practical instructional material. This method provides the instructor the opportunity to introduce the subject matter, demonstrate and explain procedures, and supervise the cadets while they imitate the skill. This method appeals to all learning styles.



The instructor shall develop and use a vocabulary of short, concise words to impress on the squad that the movements must be performed smartly. For example, the words “crack”, “drive”, “seize” and “grasp” suggest the degree of smartness required. Profanity or personal sarcasm shall never be used.

---

INTRODUCTION

---

**REVIEW**

N/A.



A-CR-CCP-701/PF-001

## OBJECTIVES

By the end of this lesson the cadet shall be expected to execute a salute at the halt without arms.

## IMPORTANCE

As members of the Canadian Cadet Organization (CCO) cadets will be required to perform drill movements at a competent level, developing sharpness, esprit de corps, physical coordination, and alertness. These movements will be executed with ease and without hesitation. Ensuring that the cadets efficiently move together as one will promote discipline, alertness, precision, pride, steadiness, and cohesion. This develops the basis of teamwork that the CCO depends on.

---

### Teaching Point 1

### Execute a Salute to the Front

Time: 10 min

Method: Demonstration and Performance

---

## DEMONSTRATE THE COMPLETE MOVEMENT WITH TIMING



Instructors are reminded that they are to present the example with regards to drill, from the moment they step onto the parade square. Proper drill movements, combined with a professional demeanour, are of paramount importance, and must be exemplified throughout the period of instruction.

The instructor shall provide a complete demonstration of the drill movement, with timing. A practiced assistant instructor may carry out this demonstration.

The demonstration shall be provided from various vantage points, as required.

The salute is given with the right hand. When physical incapacity or carrying of articles makes a salute with the right hand impracticable, compliments will be paid by turning the head and eyes to the left or right or standing to attention, as appropriate (see also A-PD-201-000/PT-000, Chapter 1, Section 2).

## DEMONSTRATE FIRST PART OF MOVEMENT (FIRST NUMBER)



For ease of instruction, drill commands have been broken down into individual movements, or numbers. The instructor(s) shall demonstrate and explain each number.

On the command TO THE FRONT SALUTE BY NUMBERS, SQUAD – ONE, the cadet shall:

1. bend the right elbow and open the palm of the right hand as it passes the shoulder; and
2. force the right hand by its shortest route to the front of the headdress so that the:
  - a. palm of the hand is facing down;
  - b. thumb and fingers are fully extended and close together;
  - c. tip of the second finger is in line with the outside of the right eyebrow and touching the outside edge of the headdress or arm of glasses, if worn;
  - d. hand, wrist and forearm are in a straight line and at a 45-degree angle to the upper arm;
  - e. elbow is in line with the shoulders; and

- f. upper arm is parallel to the ground.

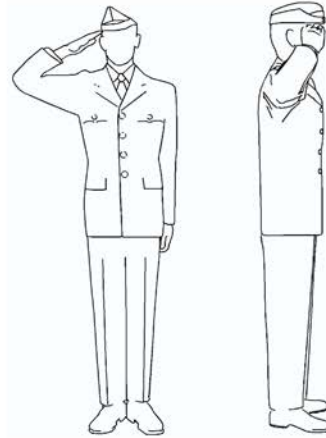

A-PD-201-000/PT-000, *The Canadian Forces Manual of Drill and Ceremonial*, 2001

Figure 8-2-1 Saluting to the Front Without Arms

#### **PRACTICE THE SQUAD ON THE FIRST MOVEMENT**

Practice the squad on the first movement collectively, individually and collectively.



Constant checking and correcting of all faults is essential. Faults shall be corrected immediately after they occur.

#### **DEMONSTRATE AND EXPLAIN THE SECOND PART OF THE MOVEMENT**

On the command SQUAD – TWO, the hand is:

1. brought sharply to the position of attention by the shortest route, without slapping the thigh; and
2. closed after the forearm is lowered below shoulder level.

#### **PRACTICE THE SQUAD ON THE SECOND MOVEMENT**

Practice the squad on the second movement collectively, individually and collectively.

#### **GIVE TWO COMPLETE AND FINAL DEMONSTRATIONS**

On the command TO THE FRONT – SALUTE, the two movements are combined. The standard pause shall be observed between movements.

The instructor(s) shall provide a full demonstration and allow time for practice.

**Note:** When wearing headdress, other than a cap with a peak, the second finger is 2 cm above and in line with the outer tip of the right eyebrow.

A-CR-CCP-701/PF-001



**Standard Pause:** The standard pause between each movement is two beats in quick time. For example, on the command MOVE TO THE RIGHT IN FILE, RIGHT – TURN, the squad:

1. executes the first movement of the turn on the executive order and simultaneously calls out “ONE”;
2. after completing the first movement, calls “TWO”, “THREE” while observing the standard pause; and
3. when executing the final movement, calls out “ONE”.

---

#### CONFIRMATION OF TEACHING POINT 1

---

Cadets will execute salutes to the front as a squad.

---

#### END OF LESSON CONFIRMATION

---

The cadets' participation in TP1 will serve as the confirmation of this lesson.

---

#### CONCLUSION

---

#### HOMEWORK/READING/PRACTICE

N/A.

#### METHOD OF EVALUATION

In accordance with A-PD-201-000/PT-000, *The Canadian Forces Manual of Drill and Ceremonial*, the cadet shall participate in an Annual Ceremonial Review (ACR) parade. This movement will be used in preparation for, and execution of, the ACR parade.

#### CLOSING STATEMENT

The hallmarks of cadet drill are efficiency, precision, and dignity. These qualities are developed through self-discipline and practice. They lead to unit pride and cohesion. Good drill, that is well rehearsed, closely supervised and precise, is an exercise in obedience and alertness. It sets the standard for the execution of any duty, both for the individual and the unit, and builds a sense of confidence between commander and subordinate that is essential to high morale. The personal qualities developed on the parade ground must be maintained in all aspects of life.

#### INSTRUCTOR NOTES/REMARKS

N/A.

---

#### REFERENCES

---

A0-002 A-PD-201-000/PT-000 DHH 3-2. (2001). *The Canadian Forces Manual of Drill and Ceremonial*. Ottawa, ON: The Department of National Defence.

THIS PAGE INTENTIONALLY LEFT BLANK

**MODIFIED LESSON SPECIFICATIONS AND INSTRUCTIONAL GUIDES – TP 1 OF EO M108.02**

A-CR-CCP-701/PG-001

**EO M108.02 – EXECUTE A SALUTE AT THE HALT WITHOUT ARMS**

1. **Performance.** Execute a Salute at the Halt Without Arms.
2. **Conditions**
  - a. Given:
    - (1) words of command;
    - (2) supervision; and
    - (3) assistance as required.
  - b. Denied: N/A.
  - c. Environmental: A drill hall or, in favourable weather, an outdoor parade square.
3. **Standard.** In accordance with A-PD-201-000/PT-000, the cadet shall execute salutes at the halt without arms, to the left and right.

4. **Teaching Points**

TP	Description	Method	Time	Ref
TP1	Explain and demonstrate saluting to the left and right at the halt and allow cadets to practice.	Demonstration and Performance	10 min	A0-002 (pp. 2-10 to 2-12)

5. **Time**
  - a. Introduction/Conclusion: 5 min
  - b. Demonstration and Performance: 10 min
  - c. Total: 15 min
6. **Substantiation.** The demonstration-performance method was chosen to allow cadets to participate in supervised exploration of practical instructional material. This method provides the instructor the opportunity to introduce the subject matter, demonstrate and explain procedures, and supervise the cadets while they imitate the skill. This method appeals to all learning styles.
7. **References.** A0-002 A-PD-201-000/PT-000 DHH 3-2. (2001). *The Canadian Forces Manual of Drill and Ceremonial*. Ottawa, ON: The Department of National Defence.
8. **Training Aids.** Assistant instructors as required.
9. **Learning Aids.** N/A.
10. **Test Details.** There is no formal assessment of this EO. Instructors will confirm the cadets' ability to perform the movements during the end of lesson check, and ongoing feedback will be provided during future drill practices, weekly parade nights, and ceremonial parades.
11. **Remarks.** N/A.



COMMON TRAINING  
GREEN STAR  
INSTRUCTIONAL GUIDE



SECTION 2

EO M108.02 – EXECUTE A SALUTE AT THE HALT WITHOUT ARMS

---

Total Time: 15 min

---

PREPARATION

---

**PRE-LESSON INSTRUCTIONS**

A complete list of resources needed for the instruction of this EO is located at Chapter 4 of the QSP. Specific uses for said stores are identified throughout the Instructional Guide, within the teaching point for which they are required.

Prior to instructing this lesson the instructor shall:

- review the lesson content, and become familiar with the material; and
- select the most effective squad formation for the lesson being taught. A squad may be in a single rank, hollow square or semi-circle for elementary drill instruction. (Note: All cadets **must** be able to fully observe all demonstrations and explanations.)

**PRE-LESSON ASSIGNMENT**

N/A.

**APPROACH**

This lesson will be presented using the demonstration and performance method. The demonstration and performance method was chosen to allow cadets to participate in supervised exploration of practical instructional material. This method provides the instructor the opportunity to introduce the subject matter, demonstrate and explain procedures, and supervise the cadets while they imitate the skill. This method appeals to all learning styles.



The instructor shall develop and use a vocabulary of short, concise words to impress on the squad that the movements must be performed smartly. For example, the words “crack”, “drive”, “seize” and “grasp” suggest the degree of smartness required. Profanity or personal sarcasm shall never be used.

---

INTRODUCTION

---

**REVIEW**

N/A.



A-CR-CCP-701/PF-001

## OBJECTIVES

By the end of this lesson the cadet shall be expected to execute a salute at the halt without arms.

## IMPORTANCE

As members of the Canadian Cadet Organization (CCO) cadets will be required to perform drill movements at a competent level, developing sharpness, esprit de corps, physical coordination, and alertness. These movements will be executed with ease and without hesitation. Ensuring that the cadets efficiently move together as one will promote discipline, alertness, precision, pride, steadiness, and cohesion. This develops the basis of teamwork that the CCO depends on.

---

### Teaching Point 1

### Execute a Salute to the Right (Left)

Time: 10 min

Method: Demonstration and Performance

---

## DEMONSTRATE THE COMPLETE MOVEMENT WITH TIMING



Instructors are reminded that they are to present the example with regards to drill, from the moment they step onto the parade square. Proper drill movements, combined with a professional demeanour, are of paramount importance, and must be exemplified throughout the period of instruction.

The instructor shall provide a complete demonstration of the drill movement, with timing. A practiced assistant instructor may carry out this demonstration.

The demonstration shall be provided from various vantage points, as required.

The salute is given with the right hand. When physical incapacity or carrying of articles makes a salute with the right hand impracticable, compliments will be paid by turning the head and eyes to the left or right or standing to attention, as appropriate (see also A-PD-201-000/PT-000, Chapter 1, Section 2).

## DEMONSTRATE FIRST PART OF MOVEMENT (FIRST NUMBER)



For ease of instruction, drill commands have been broken down into individual movements, or numbers. The instructor(s) shall demonstrate and explain each number.

On the command TO THE RIGHT (LEFT) SALUTE BY NUMBERS, SQUAD – ONE, saluting shall:

1. bend the right elbow and open the palm of the right hand as it passes the shoulder; and
2. force the right hand by its shortest route to the front of the headdress so that the:
  - a. palm of the hand is facing down;
  - b. thumb and fingers are fully extended and close together;
  - c. tip of the second finger is in line with the outside of the right eyebrow and touching the outside edge of the headdress or arm of glasses, if worn;
  - d. hand, wrist and forearm are in a straight line and at a 45 degree angle to the upper arm; and
  - e. upper arm is parallel to the ground.

3. the head and eyes shall be turned smartly to the right (left) as far as possible without straining, remembering the following:
  - a. when saluting to the left, the right hand, wrist and arm are brought further over to the left to the correct position in line with the outside edge of the right eyebrow; and
  - b. when saluting to the right, the arm is moved to the rear, with the tip of the second finger remaining in line with the outside edge of the right eyebrow.

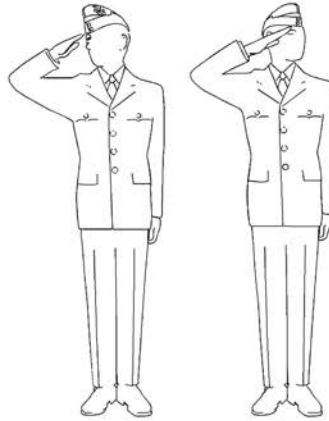

*A-PD-201-000/PT-000, The Canadian Forces Manual of Drill and Ceremonial, 2001*

Figure 8-2-1 Saluting to the Right and Left

#### **PRACTICE THE SQUAD ON THE FIRST MOVEMENT**

Practice the squad on the first movement collectively, individually and collectively.



Constant checking and correcting of all faults is essential. Faults shall be corrected immediately after they occur.

#### **DEMONSTRATE AND EXPLAIN THE SECOND PART OF THE MOVEMENT**

On the command SQUAD – TWO, the hand is brought sharply to the position of attention, and simultaneously the head and eyes are turned smartly to the front.

#### **PRACTICE THE SQUAD ON THE SECOND MOVEMENT**

Practice the squad on the second movement collectively, individually and collectively.

#### **GIVE TWO COMPLETE AND FINAL DEMONSTRATIONS**

On the command TO THE RIGHT (LEFT) – SALUTE, the two movements are combined. The standard pause shall be observed between movements.

The instructor(s) shall provide a full demonstration and allow time for practice.



A-CR-CCP-701/PF-001



**Standard Pause:** The standard pause between each movement is two beats in quick time. For example, on the command MOVE TO THE RIGHT IN FILE, RIGHT – TURN, the squad:

1. executes the first movement of the turn on the executive order and simultaneously calls out "ONE";
2. after completing the first movement, calls "TWO", "THREE" while observing the standard pause; and
3. when executing the final movement, calls out "ONE".

---

#### CONFIRMATION OF TEACHING POINT 1

---

Cadets will execute salutes to the left and left as a squad.

---

#### END OF LESSON CONFIRMATION

---

The cadets' participation in TP1 will serve as the confirmation of this lesson.

---

#### CONCLUSION

---

#### HOMEWORK/READING/PRACTICE

N/A.

#### METHOD OF EVALUATION

In accordance with A-PD-201-000/PT-000, *The Canadian Forces Manual of Drill and Ceremonial*, the cadet shall participate in an Annual Ceremonial Review (ACR) parade. This movement will be used in preparation for, and execution of, the ACR parade.

#### CLOSING STATEMENT

The hallmarks of cadet drill are efficiency, precision, and dignity. These qualities are developed through self-discipline and practice. They lead to unit pride and cohesion. Good drill, that is well rehearsed, closely supervised and precise, is an exercise in obedience and alertness. It sets the standard for the execution of any duty, both for the individual and the unit, and builds a sense of confidence between commander and subordinate that is essential to high morale. The personal qualities developed on the parade ground must be maintained in all aspects of life.

#### INSTRUCTOR NOTES/REMARKS

N/A.

---

#### REFERENCES

---

A0-002 A-PD-201-000/PT-000 DHH 3-2. (2001). *The Canadian Forces Manual of Drill and Ceremonial*. Ottawa, ON: The Department of National Defence.

THIS PAGE INTENTIONALLY LEFT BLANK

**MODIFIED LESSON SPECIFICATIONS AND INSTRUCTIONAL GUIDES – TP 1 OF EO M108.03**

A-CR-CCP-701/PG-001

**EO M108.03 – EXECUTE TURNS AT THE HALT**

1. **Performance.** Execute Turns at the Halt.
2. **Conditions**
  - a. Given:
    - (1) words of command;
    - (2) supervision; and
    - (3) assistance as required.
  - b. Denied: N/A.
  - c. Environmental: A drill hall or, in favourable weather, an outdoor parade square.
3. **Standard.** In accordance with A-PD-201-000/PT-000, the cadet shall perform the movement of right turn at the halt.
4. **Teaching Points**

TP	Description	Method	Time	Ref
TP1	Explain and demonstrate the movement of right turn at the halt and allow cadets to practice.	Demonstration and Performance	10 min	A0-002 (pp. 2-12 to 2-13)

5. **Time**
  - a. Introduction/Conclusion: 5 min
  - b. Demonstration and Performance: 10 min
  - c. Total: 15 min
6. **Substantiation.** The demonstration-performance method was chosen to allow cadets to participate in supervised exploration of practical instructional material. This method provides the instructor the opportunity to introduce the subject matter, demonstrate and explain procedures, and supervise the cadets while they imitate the skill. This method appeals to all learning styles.
7. **References.** A0-002 A-PD-201-000/PT-000 DHH 3-2. (2001). *The Canadian Forces Manual of Drill and Ceremonial*. Ottawa, ON: The Department of National Defence.
8. **Training Aids.** Assistant instructors as required.
9. **Learning Aids.** N/A.
10. **Test Details.** There is no formal assessment of this EO. Instructors will confirm the cadets' ability to perform the movements during the end of lesson check, and ongoing feedback will be provided during future drill practices, weekly parade nights, and ceremonial parades.
11. **Remarks.** N/A.



COMMON TRAINING  
GREEN STAR  
INSTRUCTIONAL GUIDE



SECTION 3

EO M108.03 – EXECUTE TURNS AT THE HALT

---

Total Time: 15 min

---

PREPARATION

---

**PRE-LESSON INSTRUCTIONS**

A complete list of resources needed for the instruction of this EO is located at Chapter 4 of the QSP. Specific uses for said stores are identified throughout the Instructional Guide, within the teaching point for which they are required.

Prior to instructing this lesson the instructor shall:

- review the lesson content, and become familiar with the material; and
- select the most effective squad formation for the lesson being taught. A squad may be in a single rank, hollow square or semi-circle for elementary drill instruction. (Note: All cadets **must** be able to fully observe all demonstrations and explanations.)

**PRE-LESSON ASSIGNMENT**

N/A.

**APPROACH**

This lesson will be presented using the demonstration and performance method. The demonstration and performance method was chosen to allow cadets to participate in supervised exploration of practical instructional material. This method provides the instructor the opportunity to introduce the subject matter, demonstrate and explain procedures, and supervise the cadets while they imitate the skill. This method appeals to all learning styles.



The instructor shall develop and use a vocabulary of short, concise words to impress on the squad that the movements must be performed smartly. For example, the words “crack”, “drive”, “seize” and “grasp” suggest the degree of smartness required. Profanity or personal sarcasm shall never be used.

---

INTRODUCTION

---

**REVIEW**

N/A.

A-CR-CCP-701/PF-001

## OBJECTIVES

By the end of this lesson the cadet shall be expected to execute right turns at the halt.

## IMPORTANCE

As members of the Canadian Cadet Movement (CCM) cadets will be required to perform drill movements at a competent level, developing sharpness, esprit de corps, physical coordination, and alertness. These movements will be executed with ease and without hesitation. Ensuring that the cadets efficiently move together as one will promote discipline, alertness, precision, pride, steadiness, and cohesion. This develops the basis of teamwork that the CCM depends on.

---

### Teaching Point 1

### Execute Right Turns

Time: 10 min

Method: Demonstration and Performance

---

## DEMONSTRATE THE COMPLETE MOVEMENT WITH TIMING



Instructors are reminded that they are to present the example with regards to drill, from the moment they step onto the parade square. Proper drill movements, combined with a professional demeanour, are of paramount importance, and must be exemplified throughout the period of instruction.

The instructor shall provide a complete demonstration of the drill movement, with timing. A practiced assistant instructor may carry out this demonstration.

The demonstration shall be provided from various vantage points, as required.

Turns and inclines are made to change direction: right or left turns change direction by 90°, about turns by 180°, and right and left inclines (not instructed in this lesson) by 45°.

## DEMONSTRATE FIRST PART OF MOVEMENT (FIRST NUMBER)



For ease of instruction, drill commands have been broken down into individual movements, or numbers. The instructor(s) shall demonstrate and explain each number.

The cadet shall execute a right turn, by:

On the command RIGHT TURN BY NUMBERS, SQUAD – ONE, turning 90° to the right by pivoting on the right heel and left toe and raising the left heel and right toe simultaneously. Both knees will be kept braced during the turn, arms at the sides and body erect. On the completion of the movement, the weight of the body is placed on the right foot and the left leg is braced with the heel off the ground.

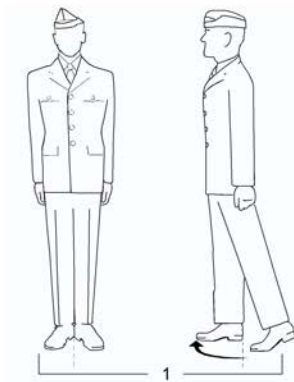

*A-PD-201-000/PT-000, The Canadian Forces Manual of Drill and Ceremonial, 2001*

Figure 8-3-1 Squad One – Right Turn at the Halt

**PRACTICE THE SQUAD ON THE FIRST MOVEMENT**

Practice the squad on the first movement collectively, individually and collectively.



Constant checking and correcting of all faults is essential. Faults shall be corrected immediately after they occur.

**DEMONSTRATE AND EXPLAIN THE SECOND PART OF THE MOVEMENT**

On the command SQUAD – TWO, the cadets shall bend the left knee, straightening it in double time and smartly placing the left foot beside the right to assume the position of attention.

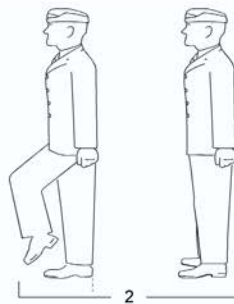

*A-PD-201-000/PT-000, The Canadian Forces Manual of Drill and Ceremonial, 2001*

Figure 8-3-2 Squad Two – Right Turn at the Halt

**PRACTICE THE SQUAD ON THE SECOND MOVEMENT**

Practice the squad on the second movement collectively, individually and collectively.



A-CR-CCP-701/PF-001

### GIVE TWO COMPLETE AND FINAL DEMONSTRATIONS

On the command RIGHT – TURN, combine the two movements. The standard pause shall be observed between the movements.

The instructor(s) shall provide a full demonstration and allow time for practice.



**Standard Pause:** The standard pause between each movement is two beats in quick time. For example, on the command MOVE TO THE RIGHT IN FILE, RIGHT – TURN, the squad:

1. executes the first movement of the turn on the executive order and simultaneously calls out "ONE";
2. after completing the first movement, calls "TWO", "THREE" while observing the standard pause; and
3. when executing the final movement, calls out "ONE".

---

### CONFIRMATION OF TEACHING POINT 1

---

Cadets will execute right turns as a squad.

---

### END OF LESSON CONFIRMATION

---

The cadets' participation in TP1 will serve as the confirmation of this lesson.

---

### CONCLUSION

---

### HOMEWORK/READING/PRACTICE

N/A.

### METHOD OF EVALUATION

In accordance with A-PD-201-000/PT-000, *The Canadian Forces Manual of Drill and Ceremonial*, the cadet shall participate in an Annual Ceremonial Review (ACR) parade. This movement will be used in preparation for, and in the execution of, the ACR parade.

### CLOSING STATEMENT

The hallmarks of cadet drill are efficiency, precision, and dignity. These qualities are developed through self-discipline and practice. They lead to unit pride and cohesion. Good drill that is well rehearsed, closely supervised and precise, is an exercise in obedience and alertness. It sets the standard for the execution of any duty, both for the individual and the unit, and builds a sense of confidence between commander and subordinate that is essential to high morale. The personal qualities developed on the parade ground must be maintained in all aspects of life.

### INSTRUCTOR NOTES/REMARKS

N/A.

---

**REFERENCES**

---

- A0-002 A-PD-201-000/PT-000 DHH 3-2. (2001). *The Canadian Forces Manual of Drill and Ceremonial*.  
Ottawa, ON: The Department of National Defence.



**MODIFIED LESSON SPECIFICATIONS AND INSTRUCTIONAL GUIDES – TP 1 OF EO M108.03**

A-CR-CCP-701/PG-001

**EO M108.03 – EXECUTE TURNS AT THE HALT**

1. **Performance.** Execute Turns at the Halt.
2. **Conditions**
  - a. Given:
    - (1) words of command;
    - (2) supervision; and
    - (3) assistance as required.
  - b. Denied: N/A.
  - c. Environmental: A drill hall or, in favourable weather, an outdoor parade square.
3. **Standard.** In accordance with A-PD-201-000/PT-000, the cadet shall perform the movement of left turn at the halt.

4. **Teaching Points**

TP	Description	Method	Time	Ref
TP1	Explain and demonstrate the movement of left turn at the halt and allow cadets to practice.	Demonstration and Performance	10 min	A0-002 (pp. 2-12 to 2-13)

5. **Time**
  - a. Introduction/Conclusion: 5 min
  - b. Demonstration and Performance: 10 min
  - c. Total: 15 min
6. **Substantiation.** The demonstration-performance method was chosen to allow cadets to participate in supervised exploration of practical instructional material. This method provides the instructor the opportunity to introduce the subject matter, demonstrate and explain procedures, and supervise the cadets while they imitate the skill. This method appeals to all learning styles.
7. **References.** A0-002 A-PD-201-000/PT-000 DHH 3-2. (2001). *The Canadian Forces Manual of Drill and Ceremonial*. Ottawa, ON: The Department of National Defence.
8. **Training Aids.** Assistant instructors as required.
9. **Learning Aids.** N/A.
10. **Test Details.** There is no formal assessment of this EO. Instructors will confirm the cadets' ability to perform the movements during the end of lesson check, and ongoing feedback will be provided during future drill practices, weekly parade nights, and ceremonial parades.
11. **Remarks.** N/A.



COMMON TRAINING  
GREEN STAR  
INSTRUCTIONAL GUIDE



SECTION 3

EO M108.03 – EXECUTE TURNS AT THE HALT

---

Total Time: 15 min

---

PREPARATION

---

**PRE-LESSON INSTRUCTIONS**

A complete list of resources needed for the instruction of this EO is located at Chapter 4 of the QSP. Specific uses for said stores are identified throughout the Instructional Guide, within the teaching point for which they are required.

Prior to instructing this lesson the instructor shall:

- review the lesson content, and become familiar with the material; and
- select the most effective squad formation for the lesson being taught. A squad may be in a single rank, hollow square or semi-circle for elementary drill instruction. (Note: All cadets **must** be able to fully observe all demonstrations and explanations.)

**PRE-LESSON ASSIGNMENT**

N/A.

**APPROACH**

This lesson will be presented using the demonstration and performance method. The demonstration and performance method was chosen to allow cadets to participate in supervised exploration of practical instructional material. This method provides the instructor the opportunity to introduce the subject matter, demonstrate and explain procedures, and supervise the cadets while they imitate the skill. This method appeals to all learning styles.



The instructor shall develop and use a vocabulary of short, concise words to impress on the squad that the movements must be performed smartly. For example, the words “crack”, “drive”, “seize” and “grasp” suggest the degree of smartness required. Profanity or personal sarcasm shall never be used.

---

INTRODUCTION

---

**REVIEW**

N/A.

A-CR-CCP-701/PF-001

## OBJECTIVES

By the end of this lesson the cadet shall be expected to execute left turns at the halt.

## IMPORTANCE

As members of the Canadian Cadet Movement (CCM) cadets will be required to perform drill movements at a competent level, developing sharpness, esprit de corps, physical coordination, and alertness. These movements will be executed with ease and without hesitation. Ensuring that the cadets efficiently move together as one will promote discipline, alertness, precision, pride, steadiness, and cohesion. This develops the basis of teamwork that the CCM depends on.

---

### Teaching Point 1

### Execute Left Turns

Time: 10 min

Method: Demonstration and Performance

---

## DEMONSTRATE THE COMPLETE MOVEMENT WITH TIMING



Instructors are reminded that they are to present the example with regards to drill, from the moment they step onto the parade square. Proper drill movements, combined with a professional demeanour, are of paramount importance, and must be exemplified throughout the period of instruction.

The instructor shall provide a complete demonstration of the drill movement, with timing. A practiced assistant instructor may carry out this demonstration.

The demonstration shall be provided from various vantage points, as required.

Turns and inclines are made to change direction: right or left turns change direction by 90°, about turns by 180°, and right and left inclines by 45°.

## DEMONSTRATE FIRST PART OF MOVEMENT (FIRST NUMBER)



For ease of instruction, drill commands have been broken down into individual movements, or numbers. The instructor(s) shall demonstrate and explain each number.

The cadet shall execute a left turn, by:

On the command LEFT TURN BY NUMBERS, SQUAD – ONE, turning 90° to the left by pivoting on the left heel and right toe and raising the right heel and left toe simultaneously. Both knees will be kept braced during the turn, arms at the sides and body erect. On the completion of the movement, the weight of the body is placed on the left foot and the right leg is braced with the heel off the ground.

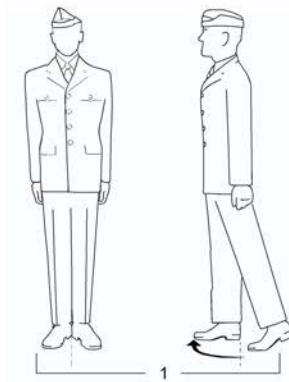

*A-PD-201-000/PT-000, The Canadian Forces Manual of Drill and Ceremonial, 2001*

Figure 8-3-1 Squad One – Turn at the Halt

**PRACTICE THE SQUAD ON THE FIRST MOVEMENT**

Practice the squad on the first movement collectively, individually and collectively.



Constant checking and correcting of all faults is essential. Faults shall be corrected immediately after they occur.

**DEMONSTRATE AND EXPLAIN THE SECOND PART OF THE MOVEMENT (NUMBER TWO)**

On the command SQUAD – TWO, bend the right knee, straightening it in double time and smartly placing the right foot beside the left to assume the position of attention.

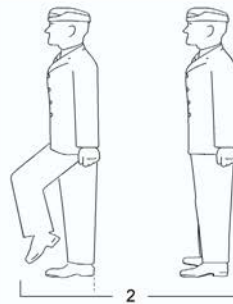

*A-PD-201-000/PT-000, The Canadian Forces Manual of Drill and Ceremonial, 2001*

Figure 8-3-2 Squad Two – Turn at the Halt

**PRACTICE THE SQUAD ON THE SECOND MOVEMENT**

Practice the squad on the second movement collectively, individually and collectively.

A-CR-CCP-701/PF-001

### GIVE TWO COMPLETE AND FINAL DEMONSTRATIONS

On the command LEFT – TURN, combine the two movements. The standard pause shall be observed between the movements.

The instructor(s) shall provide a full demonstration and allow time for practice.



**Standard Pause:** The standard pause between each movement is two beats in quick time. For example, on the command MOVE TO THE LEFT IN FILE, LEFT – TURN, the squad:

1. Executes the first movement of the turn on the executive order and simultaneously calls out "ONE".
2. After completing the first movement, calls "TWO", "THREE" while observing the standard pause.
3. When executing the final movement, calls out "ONE".

---

### CONFIRMATION OF TEACHING POINT 1

---

Cadets will execute LEFT turns as a squad.

---

### END OF LESSON CONFIRMATION

---

The cadets' participation in TP1 will serve as the confirmation of this lesson.

---

### CONCLUSION

---

### HOMEWORK/READING/PRACTICE

N/A.

### METHOD OF EVALUATION

In accordance with A-PD-201-000/PT-000, *The Canadian Forces Manual of Drill and Ceremonial*, the cadet shall participate in an Annual Ceremonial Review (ACR) parade. This movement will be used in preparation for, and in the execution of, the ACR parade.

### CLOSING STATEMENT

The hallmarks of cadet drill are efficiency, precision, and dignity. These qualities are developed through self-discipline and practice. They lead to unit pride and cohesion. Good drill that is well rehearsed, closely supervised and precise, is an exercise in obedience and alertness. It sets the standard for the execution of any duty, both for the individual and the unit, and builds a sense of confidence between commander and subordinate that is essential to high morale. The personal qualities developed on the parade ground must be maintained in all aspects of life.

### INSTRUCTOR NOTES/REMARKS

N/A.

---

**REFERENCES**

---

- A0-002 A-PD-201-000/PT-000 DHH 3-2. (2001). *The Canadian Forces Manual of Drill and Ceremonial*.  
Ottawa, ON: The Department of National Defence.

**MODIFIED LESSON SPECIFICATIONS AND INSTRUCTIONAL GUIDES – TP 1 OF EO M108.03**

A-CR-CCP-701/PG-001

**EO M108.03 – EXECUTE TURNS AT THE HALT**

1. **Performance.** Execute Turns at the Halt.
2. **Conditions**
  - a. Given:
    - (1) words of command;
    - (2) supervision; and
    - (3) assistance as required.
  - b. Denied: N/A.
  - c. Environmental: A drill hall or, in favourable weather, an outdoor parade square.
3. **Standard.** In accordance with A-PD-201-000/PT-000, the cadet shall perform the movement of about turn at the halt.
4. **Teaching Points**

TP	Description	Method	Time	Ref
TP1	Explain and demonstrate the movement of about turn at the halt and allow cadets to practice.	Demonstration and Performance	10 min	A0-002 (pp. 2-12 to 2-13)

5. **Time**
  - a. Introduction/Conclusion: 5 min
  - b. Demonstration and Performance: 10 min
  - c. Total: 15 min
6. **Substantiation.** The demonstration-performance method was chosen to allow cadets to participate in supervised exploration of practical instructional material. This method provides the instructor the opportunity to introduce the subject matter, demonstrate and explain procedures, and supervise the cadets while they imitate the skill. This method appeals to all learning styles.
7. **References.** A0-002 A-PD-201-000/PT-000 DHH 3-2. (2001). *The Canadian Forces Manual of Drill and Ceremonial*. Ottawa, ON: The Department of National Defence.
8. **Training Aids.** Assistant instructors as required.
9. **Learning Aids.** N/A.
10. **Test Details.** There is no formal assessment of this EO. Instructors will confirm the cadets' ability to perform the movements during the end of lesson check, and ongoing feedback will be provided during future drill practices, weekly parade nights, and ceremonial parades.
11. **Remarks.** N/A.





COMMON TRAINING  
GREEN STAR  
INSTRUCTIONAL GUIDE



SECTION 3

EO M108.03 – EXECUTE TURNS AT THE HALT

---

Total Time: 15 min

---

PREPARATION

---

**PRE-LESSON INSTRUCTIONS**

A complete list of resources needed for the instruction of this EO is located at Chapter 4 of the QSP. Specific uses for said stores are identified throughout the Instructional Guide, within the teaching point for which they are required.

Prior to instructing this lesson the instructor shall:

- review the lesson content, and become familiar with the material; and
- select the most effective squad formation for the lesson being taught. A squad may be in a single rank, hollow square or semi-circle for elementary drill instruction. (Note: All cadets **must** be able to fully observe all demonstrations and explanations.)

**PRE-LESSON ASSIGNMENT**

N/A.

**APPROACH**

This lesson will be presented using the demonstration and performance method. The demonstration and performance method was chosen to allow cadets to participate in supervised exploration of practical instructional material. This method provides the instructor the opportunity to introduce the subject matter, demonstrate and explain procedures, and supervise the cadets while they imitate the skill. This method appeals to all learning styles.



The instructor shall develop and use a vocabulary of short, concise words to impress on the squad that the movements must be performed smartly. For example, the words “crack”, “drive”, “seize” and “grasp” suggest the degree of smartness required. Profanity or personal sarcasm shall never be used.

---

INTRODUCTION

---

**REVIEW**

N/A.



A-CR-CCP-701/PF-001

## OBJECTIVES

By the end of this lesson the cadet shall be expected to execute about turns at the halt.

## IMPORTANCE

As members of the Canadian Cadet Movement (CCM) cadets will be required to perform drill movements at a competent level, developing sharpness, esprit de corps, physical coordination, and alertness. These movements will be executed with ease and without hesitation. Ensuring that the cadets efficiently move together as one will promote discipline, alertness, precision, pride, steadiness, and cohesion. This develops the basis of teamwork that the CCM depends on.

### Teaching Point 1

### Execute About Turn

Time: 10 min

Method: Demonstration and Performance

### DEMONSTRATE THE COMPLETE MOVEMENT WITH TIMING



Instructors are reminded that they are to present the example with regards to drill, from the moment they step onto the parade square. Proper drill movements, combined with a professional demeanour, are of paramount importance, and must be exemplified throughout the period of instruction.

The instructor shall provide a complete demonstration of the drill movement, with timing. A practiced assistant instructor may carry out this demonstration.

The demonstration shall be provided from various vantage points, as required.

### DEMONSTRATE FIRST PART OF MOVEMENT (FIRST NUMBER)

On the command ABOUT TURN BY NUMBERS, SQUAD – ONE, turning 180° to the right by pivoting on the right heel and left toe and raising the left heel and right toe simultaneously. Both knees will be kept braced during the turn, arms at the sides and body erect. On the completion of the movement, the weight of the body is placed on the right foot and the left leg is braced with the heel off the ground.

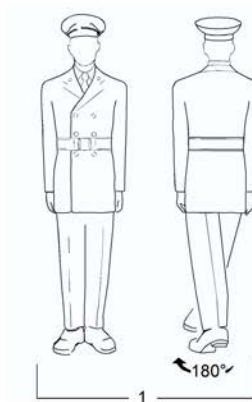

A-PD-201-000/PT-000, *The Canadian Forces Manual of Drill and Ceremonial*, 2001

Figure 8-3-1 Squad One – About Turn at the Halt

**PRACTICE THE SQUAD ON THE FIRST MOVEMENT**

Practice the squad on the first movement collectively, individually and collectively.



Constant checking and correcting of all faults is essential. Faults shall be corrected immediately after they occur.

**DEMONSTRATE AND EXPLAIN THE SECOND PART OF THE MOVEMENT (SECOND NUMBER)**

On the command SQUAD – TWO, bending the left knee, straightening it in double time and smartly placing the left foot beside the right to assume the position of attention.

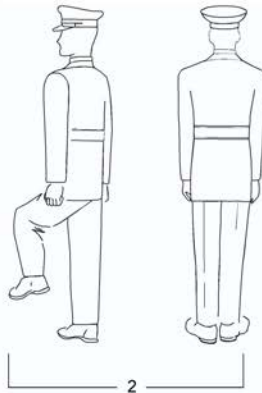

*A-PD-201-000/PT-000, The Canadian Forces Manual of Drill and Ceremonial, 2001*

Figure 8-3-2 Squad Two – About Turn at the Halt

**PRACTICE THE SQUAD ON THE SECOND MOVEMENT**

Practice the squad on the second movement collectively, individually and collectively.

**GIVE TWO COMPLETE AND FINAL DEMONSTRATIONS**

On the command ABOUT – TURN, combine the two movements. The standard pause shall be observed between the movements.

The instructor(s) shall provide a full demonstration and allow time for practice.

A-CR-CCP-701/PF-001



**Standard Pause:** The standard pause between each movement is two beats in quick time. For example, on the command ABOUT – TURN, combine the two movements. The standard pause shall be observed between the movements:

1. Executes the first movement of the turn on the executive order and simultaneously calls out "ONE".
2. After completing the first movement, calls "TWO", "THREE" while observing the standard pause.
3. When executing the final movement, calls out "ONE".

---

#### CONFIRMATION OF TEACHING POINT 1

---

Cadets will execute about turns as a squad.

---

#### END OF LESSON CONFIRMATION

---

The cadets' participation in TP1 will serve as the confirmation of this lesson.

---

#### CONCLUSION

---

#### HOMEWORK/READING/PRACTICE

N/A.

#### METHOD OF EVALUATION

In accordance with A-PD-201-000/PT-000, *The Canadian Forces Manual of Drill and Ceremonial*, the cadet shall participate in an Annual Ceremonial Review (ACR) parade. This movement will be used in preparation for, and in the execution of, the ACR parade.

#### CLOSING STATEMENT

The hallmarks of cadet drill are efficiency, precision, and dignity. These qualities are developed through self-discipline and practice. They lead to unit pride and cohesion. Good drill that is well rehearsed, closely supervised and precise, is an exercise in obedience and alertness. It sets the standard for the execution of any duty, both for the individual and the unit, and builds a sense of confidence between commander and subordinate that is essential to high morale. The personal qualities developed on the parade ground must be maintained in all aspects of life.

#### INSTRUCTOR NOTES/REMARKS

N/A.

---

#### REFERENCES

---

A0-002 A-PD-201-000/PT-000 DHH 3-2. (2001). *The Canadian Forces Manual of Drill and Ceremonial*. Ottawa, ON: The Department of National Defence.

THIS PAGE INTENTIONALLY LEFT BLANK

**DRILL INSTRUCTIONAL TECHNIQUES – ASSESSMENT FORM**

Cadet's Name: \_\_\_\_\_

Platoon: \_\_\_\_\_

Lesson Topic: \_\_\_\_\_

Criteria	Comments	Incomplete	Completed With Difficulty	Completed Without Difficulty
<b>PREPARATION</b>				
Maintained dress and deportment.				
Selected an appropriate squad formation.				
Used a lesson plan.				
Reviewed previous lesson.				
<b>INTRODUCTION</b>				
Stated what the cadets will learn.				
Stated why it is important.				
Stated where/when this skill will be applied.				
<b>BODY</b>				
Demonstrated complete movement, calling the time.				
Demonstrated and explained the first part of the movement (Squad 1).				
Had the squad practice the first part of the movement collectively, individually and collectively again.				
Taught the second part of the movement and each subsequent part in the same manner.				
Gave two complete demonstrations.				
Practiced the complete movement with: <ul style="list-style-type: none"> <li>• the instructor calling the time,</li> <li>• the cadets calling the time, and</li> <li>• the cadets judging the time.</li> </ul>				

Criteria	Comments	Incomplete	Completed With Difficulty	Completed Without Difficulty
Used clear words of command and correct pauses.				
Gave appropriate and immediate feedback.				
Allowed questions after each movement.				
<b>END OF LESSON CONFIRMATION</b>				
Demonstrated the movement taught.				
Confirmation was conducted as a squad.				
Emphasized aspects of the movement with which the cadets experienced difficulty.				
<b>CONCLUSION</b>				
Summarized the lesson.				
Re-motivated the cadets.				
<b>FEEDBACK</b>				

\_\_\_\_\_  
 Assessor's Signature

\_\_\_\_\_  
 Date

\_\_\_\_\_  
 Cadet's Signature

**CHAPTER 10**

**PO 311 – PARTICIPATE IN A RECREATIONAL SUMMER BIATHLON ACTIVITY**







**COMMON TRAINING  
SILVER STAR  
INSTRUCTIONAL GUIDE**



**SECTION 1**

**EO C311.01 – PRACTICE AIMING AND FIRING THE  
CADET AIR RIFLE FOLLOWING PHYSICAL ACTIVITY**

---

Total Time:

90 min

---

**PREPARATION**

---

**PRE-LESSON INSTRUCTIONS**

Resources needed for the delivery of this lesson are listed in the lesson specification located in A-CR-CCP-703/PG-001, Chapter 4. Specific uses for said resources are identified throughout the instructional guide within the TP for which they are required.

Review the lesson content and become familiar with the material prior to delivering the lesson.

**PRE-LESSON ASSIGNMENT**

N/A.

**APPROACH**

An interactive lecture was chosen for TPs 1 and 2 to review aiming and firing techniques.

A practical activity was chosen for TPs 3–6 as it is an interactive way to allow the cadets to experience aiming and firing the cadet air rifle following physical activity.

---

**INTRODUCTION**

---

**REVIEW**

N/A.

**OBJECTIVES**

By the end of this lesson the cadet shall have practiced aiming and firing the cadet air rifle following physical activity.

**IMPORTANCE**

It is important for cadets to practice aiming and firing the cadet air rifle following physical activity because these skills are essential to summer biathlon training.

**Teaching Point 1****IAW EO C206.02 (Practice Aiming Techniques, A-CR-CCP-702/PF-001, Chapter 6, Section 3), Review Breathing Techniques**

Time: 5 min

Method: Interactive Lecture

Breathing supplies the blood stream with oxygen and eliminates waste elements (such as carbon dioxide) from the blood. While breathing, the oxygen inhaled is used to supply muscles with energy, ensuring optimal potential of the muscles. Just like in sports, controlled breathing can affect marksmanship outcomes.

**CONTROLLED BREATHING**

Once a stable prone position is established, integrate the principles of controlled breathing. For maximum stability when firing, hold the breath for five to seven seconds. It is very important not to hold the breath for more than seven seconds, as tension will increase in the chest, muscles will lack oxygen and stability will be reduced. When the body lacks oxygen, muscles will quiver and eyesight will be negatively affected.

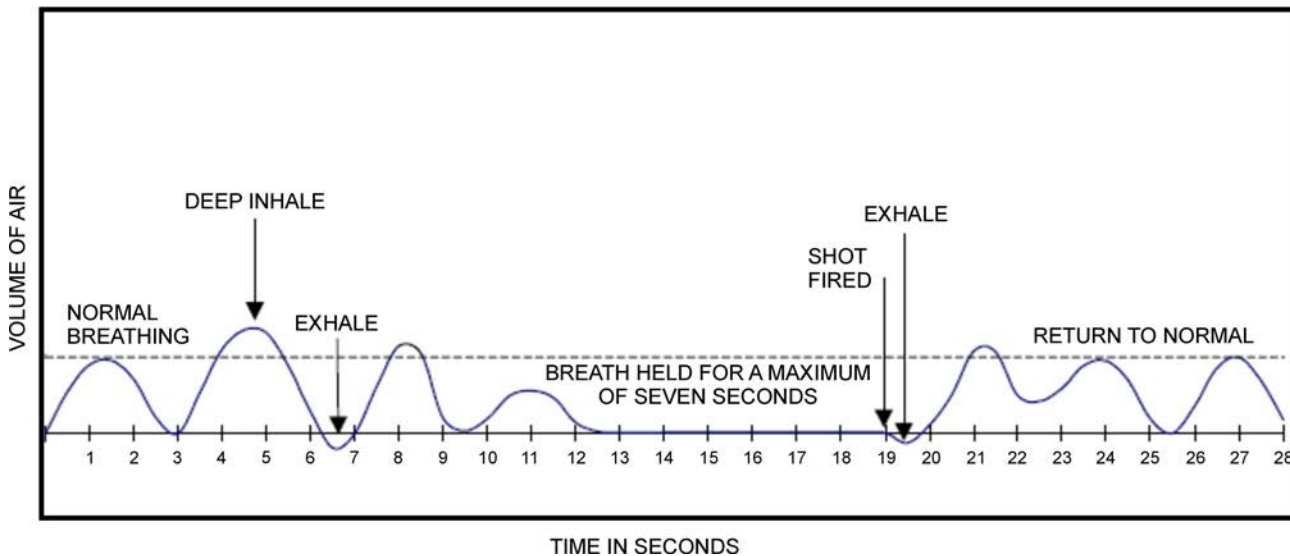

A-CR-CCP-177/PT-001 (p. 1-5-9)

Figure 10-1-1 Marksmanship Breathing Cycle

**ACHIEVING A CONTROLLED BREATHING SEQUENCE**

The following is the recommended method for achieving a controlled breathing sequence:

1. Adopt the prone position.
2. Relax and breathe normally.
3. Obtain a sight picture.
4. Inhale and exhale deeply.
5. Inhale deeply and exhale normally.
6. Relax the chest muscles, hold a breath for five to seven seconds and squeeze the trigger.
7. Exhale completely and resume normal breathing.

---

**CONFIRMATION OF TEACHING POINT 1**

---

**QUESTIONS**

- Q1. Breathing supplies the blood stream with what?
- Q2. Oxygen supplies what with energy?
- Q3. For how long should the breath be held while firing?

**ANTICIPATED ANSWERS**

- A1. Oxygen.
- A2. The muscles.
- A3. Five to seven seconds.

---

**Teaching Point 2**

**IAW EO C206.03 (Practice Firing Techniques, A-CR-CCP-702/PF-001, Chapter 6, Section 4), Review Natural Sight Alignment**

Time: 5 min

Method: Interactive Lecture

---

Natural alignment describes the direction that the cadet air rifle is aimed when the marksman is in the prone position with the cadet air rifle at the ready. When in a comfortable position, the cadet air rifle should not be forced to point at the target. Even with a perfect prone position and sight alignment, forcing the air rifle can cause muscle tension and will affect the accuracy of each shot.

Natural alignment is obtained by:

- 1. adopting a comfortable prone position;
- 2. acquiring a sight picture;
- 3. closing both eyes;
- 4. taking several normal breaths to relax the muscles;
- 5. looking through sights when comfortable;
- 6. adjusting body position until a proper sight picture is achieved; and
- 7. proceeding to fire.

---

**CONFIRMATION OF TEACHING POINT 2**

---

**QUESTIONS**

- Q1. What is natural alignment?
- Q2. What can happen if the air rifle is forced to point at the target?
- Q3. What is the first step to obtaining natural alignment?

## ANTICIPATED ANSWERS

- A1. The direction that the cadet air rifle is aimed when the marksman is in the prone position with the cadet air rifle at the ready.
- A2. Forcing the air rifle can cause muscle tension and will affect the accuracy of each shot.
- A3. Adopting a comfortable prone position.

---

### Teaching Point 3

### Conduct a Warm-Up Session, Composed of Light Cardiovascular Exercises

Time: 5 min

Method: Practical Activity

---



The following information will be explained to the cadets during the warm-up session.

## PURPOSE OF A WARM-UP

A warm-up session is composed of stretches and light cardiovascular exercises designed to:

- stretch the muscles;
- gradually increase respiratory action and heart rate;
- expand the muscles' capillaries to accommodate the increase in blood circulation which occurs during physical activity; and
- raise the muscle temperature to facilitate reactions in muscle tissue.

## GUIDELINES FOR STRETCHING

The following guidelines should be followed while stretching to prepare for physical activity and to help prevent injury:

- Stretch all major muscle groups, including the back, chest, legs, and shoulders.
- Never bounce while stretching.
- Hold each stretch for 10–30 seconds to let the muscles release fully.
- Repeat each stretch two to three times.
- When holding a stretch, support the limb at the joint.
- Static stretching, which is stretching a muscle and holding it in position without discomfort for 10–30 seconds, is considered the safest method.
- Stretching helps to relax the muscles and improve flexibility, which is the range of motion in the joints.
- As a guide, allow 10 minutes to warm up for every hour of physical activity.



The stretches chosen should focus on the areas of the body that will be used the most during the physical activity.

---

## ACTIVITY

---

### OBJECTIVE

The objective of this warm-up activity is to stretch the muscles and perform light cardiovascular exercises to prepare the body for physical activity and to help prevent injuries.

### RESOURCES

N/A.

### ACTIVITY LAYOUT

N/A.

### ACTIVITY INSTRUCTIONS

1. Arrange the cadets in either a warm-up circle or in rows (as illustrated in Figures 10-1-2 and 10-1-3).

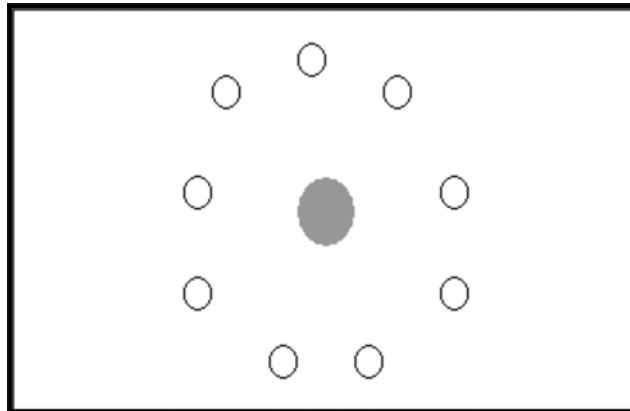

*Director Cadets 3, 2006, Ottawa, ON: Department of National Defence*

Figure 10-1-2 Instructor in the Centre of a Warm-Up Circle

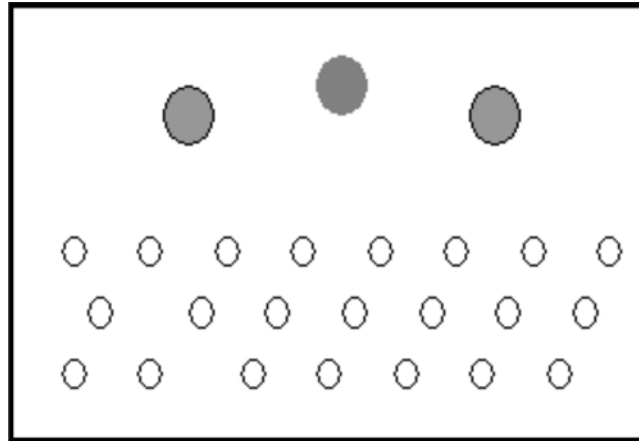

Director Cadets 3, 2006, Ottawa, ON: Department of National Defence

Figure 10-1-3 Instructor at the Front With Two Assistant Instructors

2. Demonstrate before having the cadets attempt each stretch/light cardiovascular exercise.
3. Assistant instructors may help demonstrate the exercises and ensure the cadets are performing them correctly.
4. Have cadets perform each stretch/light cardiovascular exercise.



Light cardiovascular exercises should be done to warm up the muscles prior to stretching to avoid injury to or tearing of the muscles. For example, running on the spot for 30 seconds or performing jumping jacks should be performed prior to conducting the stretches located at Annex A.

**SAFETY**

- Ensure there are at least two arm lengths between the cadets so they can move freely.
- Ensure the cadets perform the stretches and light cardiovascular exercises in a safe manner, following the guidelines for stretching listed in this TP.

---

**CONFIRMATION OF TEACHING POINT 3**

---

The cadets' participation in the warm-up session will serve as the confirmation of this TP.

---

**Teaching Point 4**

**Conduct an Activity Where the Cadets Will Aim and Fire the Cadet Air Rifle Following Physical Activity**

Time: 60 min

Method: Practical Activity

---

**ACTIVITY**

---

**OBJECTIVE**

The objective of this activity is to have the cadets aim and fire the cadet air rifle following physical activity, practicing breathing techniques and natural alignment.

## RESOURCES

- Cadet air rifles (one per firing lane),
- Safety glasses/goggles (two per firing lane),
- Shooting mats (two per firing lane),
- Biathlon Air Rifle Targets (BARTs) (one per firing lane), and
- Coins (one per firing lane).



If resources are available, the number of firing lanes may be increased.

## ACTIVITY LAYOUT

A range IAW Part 1, Section 8 of A-CR-CCP-177/PT-001.

## ACTIVITY INSTRUCTIONS

1. Divide the cadets into pairs.
2. Have one cadet from each pair run or participate in some sort of activity to elevate their heart rate for five to ten minutes.
3. Have the same cadet from each pair approach the firing point and prepare to fire.
4. Have the cadet adopt the prone position and their partner balance a coin on the barrel of the cadet air rifle, just behind the front sight.
5. While practicing a controlled breathing sequence and natural alignment, the cadet shall dry fire the cadet air rifle while keeping the coin balanced.
6. Circulate throughout the training area and coach the cadets on their breathing techniques and natural alignment.
7. Have the cadets switch positions and repeat steps 2. to 5. until the activity time is complete.

## SAFETY

Range activities will be conducted IAW A-CR-CCP-177/PT-001.

---

### CONFIRMATION OF TEACHING POINT 4

---

The cadets' participation in the activity will serve as the confirmation of this TP.

---

**Teaching Point 5**

**Conduct a Cool-Down Session, Composed of Light Cardiovascular Exercises**

Time: 5 min

Method: Practical Activity

---



The following information will be explained to the cadets during the cool-down session.

**PURPOSE OF A COOL-DOWN**

A cool-down is composed of stretches and light cardiovascular exercises designed to:

- allow the body time to slowly recover from physical activity and to help prevent injury;
- prepare the respiratory system to return to its normal state; and
- stretch the muscles to help relax and restore them to their resting length.



The stretches chosen should focus on the areas of the body that were used the most during the sports activity.

---

**ACTIVITY**

---

**OBJECTIVE**

The objective of the cool-down is to stretch the muscles and perform light cardiovascular exercises that allow the body time to recover from physical activity, and to prevent injury.

**RESOURCES**

N/A.

**ACTIVITY LAYOUT**

N/A.

**ACTIVITY INSTRUCTIONS**

1. Arrange the cadets in either a warm-up circle or in rows (as illustrated in Figures 10-1-2 and 10-1-3).
2. Demonstrate before having the cadets attempt each stretch/light cardiovascular exercise.
3. Assistant instructors may help demonstrate the movements and ensure the cadets are performing them correctly.
4. Have cadets perform each stretch/light cardiovascular exercise.

**SAFETY**

- Ensure there are at least two arm lengths between the cadets so they can move freely.



- Ensure the cadets perform the stretches and light cardiovascular exercises in a safe manner, following the guidelines for stretching listed in TP 3.

---

### CONFIRMATION OF TEACHING POINT 5

---

The cadets' participation in the cool-down session will serve as the confirmation of this TP.

---

### END OF LESSON CONFIRMATION

---

The cadets' participation in the activity in TP 4 will serve as the confirmation of this lesson.

---

### CONCLUSION

---

#### HOMework/READING/PRACTICE

N/A.

#### METHOD OF EVALUATION

N/A.

#### CLOSING STATEMENT

Being able to use breathing techniques and natural alignment while firing following physical activity may help to improve marksmanship skills for summer biathlon.

#### INSTRUCTOR NOTES/REMARKS

This lesson shall be taught prior to conducting EO C311.02 (Participate in a Recreational Summer Biathlon Activity, Section 2).

---

### REFERENCES

---

- |        |  |
|--------|--|
| A0-027 | A-CR-CCP-177/PT-001 Director Cadets 3. (2001). <i>Canadian Cadet Movement: Cadet Marksmanship Program Reference Manual</i> . Ottawa, ON: Department of National Defence.       |
| C0-002 | (ISBN 0-88962-630-8) LeBlanc, J., & Dickson, L. (1997). <i>Straight Talk About Children and Sport: Advice for Parents, Coaches, and Teachers</i> . Oakville, ON: Mosaic Press. |
| C0-089 | (ISBN 0-936070-22-6) Anderson, B. (2000). <i>Stretching: 20<sup>th</sup> Anniversary</i> (Rev. ed.). Bolinas, CA: Shelter Publications, Inc.                                   |
| C0-149 | Biathlon Canada. (2005). <i>Biathlon Bears: Community Coaching</i> . Ottawa, ON: Biathlon Canada.  |

THIS PAGE INTENTIONALLY LEFT BLANK



**COMMON TRAINING**  
**SILVER STAR**  
**INSTRUCTIONAL GUIDE**



**SECTION 2**

**EO C311.02 – PARTICIPATE IN A RECREATIONAL SUMMER BIATHLON ACTIVITY**

Total Time:

180 min

---

**PREPARATION**

---

**PRE-LESSON INSTRUCTIONS**

Resources needed for the delivery of this lesson are listed in the lesson specification located in A-CR-CCP-703/PG-001, Chapter 4. Specific uses for said resources are identified throughout the instructional guide within the TP for which they are required.

Review the lesson content and become familiar with the material prior to delivering the lesson.

Ensure that all members involved in conducting this activity are familiar with the competition guidelines located at Annex B.

Set up a first aid station.

Set up a running route of 1000 m.

Set up a range IAW A-CR-CCP-177/PT-001, Part 1, Section 8.

Photocopy Annexes C, D and E.

**PRE-LESSON ASSIGNMENT**

N/A.

**APPROACH**

A practical activity was chosen for this lesson as it is an interactive way for the cadets to participate in recreational summer biathlon. This activity contributes to the development of biathlon skills and knowledge, and promotes physical fitness in a fun and challenging setting.

---

**INTRODUCTION**

---

**REVIEW**

N/A.

**OBJECTIVES**

By the end of this lesson the cadet shall have participated in a recreational summer biathlon activity.

## IMPORTANCE

It is important for the cadets to participate in a recreational summer biathlon activity because it requires personal discipline, develops marksmanship skills and promotes physical fitness.

---

### Teaching Point 1

### Explain the Components of a Recreational Summer Biathlon Activity

Time: 10 min

Method: Practical Activity

---



Describe the components of the recreational summer biathlon activity. Ensure that the cadets understand the course layout, rules and regulations, scoring, penalties and out of bound areas before the activity is conducted. The cadets should be made aware of the start area, the course, the firing range and the finish area.

## COMPOSITION

Cadets will be divided into teams for the summer biathlon activity. For a group of 25 cadets, the cadets should be divided into groups of five.

## COURSE LAYOUT

Each cadet will:

- run a route of approximately 1000 m;
- fire five to eight rounds in an effort to knock down all five targets on the biathlon air rifle target (BART);
- run a second route of approximately 1000 m;
- fire five to eight rounds in an effort to knock down all five targets on the BART;
- run a third route of approximately 1000 m; and
- finish the race.



The 1000 m route should be clearly marked prior to the start of this lesson.

## RULES AND REGULATIONS

Rules and regulations for the recreational summer biathlon activity include the following:

- The cadets must remain in their own teams throughout the activity.
- The cadets must use the same firing lane for the duration of the activity.
- The run must be completed in the proper sequence and on the marked route.
- Cadet air rifles must be placed at the firing point by the range staff and will remain there for the duration of the activity.
- All firing will be done in the prone position.
- The cadet air rifle must be made safe upon completion of firing.

- An inoperable cadet air rifle will be replaced by the range staff, the target will be reset, and the cadet will fire five to eight rounds with the new cadet air rifle.
- Safety infractions will result in time penalties.
- Missed targets will result in time penalties.

## SCORING

The team's final score is determined by adding the total time for all run routes plus any penalties issued. The team with the lowest final score is considered the winning team.

Scoring will be calculated as follows:

- **Time.** The team's final time is the time from the start to finish, and any penalties.
- **Targets.** For each relay of firing, the number of hit and missed targets will be recorded on the range recording sheet by the lane scorekeeper (located at Annex C). There is no positive point value for each hit target; competitors will be deducted points for each missed target.

## PENALTIES

The following penalties will be added to the team's time:

- Each violation of the principles of fair play or good sportsmanship will result in a one-minute penalty, to include:
  - not giving way in an area of congestion;
  - pushing or shoving;
  - using profanity; and
  - interfering with other competitors.
- Each missed target will result in a 10-second penalty.
- Each safety infraction on the firing point will result in a two-minute penalty, to include:
  - not keeping control of the cadet air rifle;
  - moving forward of the firing point; and
  - intentionally firing rounds at objects other than the BART.
- Each team member that does not cross the finish line will receive a two-minute penalty.

## OUT OF BOUNDS AREAS

Make cadets aware of all out of bounds areas and safety considerations depending on the training area.

---

### CONFIRMATION OF TEACHING POINT 1

---

## QUESTIONS

- Q1. What are two rules/regulations for this recreational summer biathlon activity?
- Q2. How will the recreational summer biathlon activity be scored?
- Q3. What is one violation of the principles of fair play/good sportsmanship?

## ANTICIPATED ANSWERS

A1. Rules and regulations for the recreational summer biathlon activity include the following:

- The cadets must remain in their own teams throughout the activity.
- The cadets must use the same firing lane for the duration of the activity.
- The run must be completed in the proper sequence and on the marked route.
- Cadet air rifles must be placed at the firing point by the range staff and will remain there for the duration of the activity.
- All firing will be done in the prone position.
- The cadet air rifle must be made safe upon completion of firing.
- An inoperable cadet air rifle will be replaced by the range staff, the target will be reset, and the cadet will fire five to eight rounds with the new rifle.
- Safety infractions will result in time penalties.
- Missed targets will result in time penalties.

A2. The activity will be scored based on time and penalties.

A3. Violations of the principles of fair play/good sportsmanship include:

- not giving way in an area of congestion;
- pushing or shoving;
- using profanity; and
- interfering with other competitors.

---

### Teaching Point 2

### Conduct a Warm-Up Session Composed of Light Cardiovascular Exercises

Time: 10 min

Method: Practical Activity

---



The following information will be explained to the cadets during the warm-up session.

### PURPOSE OF A WARM-UP

A warm-up session is composed of stretches and light cardiovascular exercises designed to:

- stretch the muscles;
- gradually increase respiratory action and heart rate;
- expand the muscles' capillaries to accommodate the increase in blood circulation which occurs during physical activity; and
- raise the muscle temperature to facilitate reactions in muscle tissue.

## GUIDELINES FOR STRETCHING

The following guidelines should be followed while stretching to prepare for physical activity and to help prevent injury:

- Stretch all major muscle groups, including the back, chest, legs, and shoulders.
- Never bounce while stretching.
- Hold each stretch for 10–30 seconds to let the muscles release fully.
- Repeat each stretch two to three times.
- When holding a stretch, support the limb at the joint.
- Static stretching, which is stretching a muscle and holding it in position without discomfort for 10–30 seconds, is considered the safest method.
- Stretching helps to relax the muscles and improve flexibility, which is the range of motion in the joints.
- As a guide, allow 10 minutes to warm up for every hour of physical activity.



The stretches chosen should focus on the areas of the body that will be used the most during the physical activity.

---

## ACTIVITY

---

### OBJECTIVE

The objective of this warm-up activity is to stretch the muscles and perform light cardiovascular exercises to prepare the body for physical activity and to help prevent injuries.

### RESOURCES

N/A.

### ACTIVITY LAYOUT

N/A.

### ACTIVITY INSTRUCTIONS

1. Arrange the cadets in either a warm-up circle or in rows (as illustrated in Figures 10-2-1 and 10-2-2).

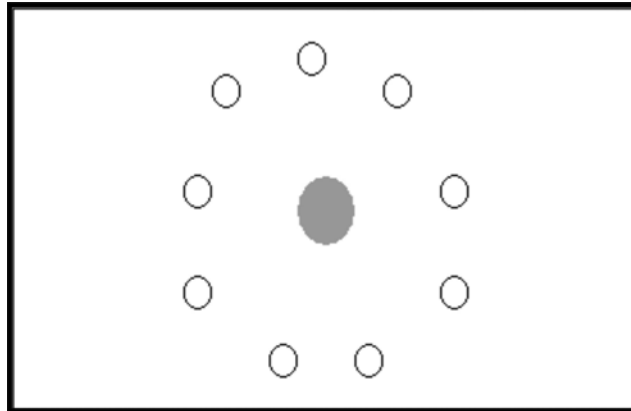

*Director Cadets 3, 2006, Ottawa, ON: Department of National Defence*

Figure 10-2-1 Instructor in the Centre of a Warm-Up Circle

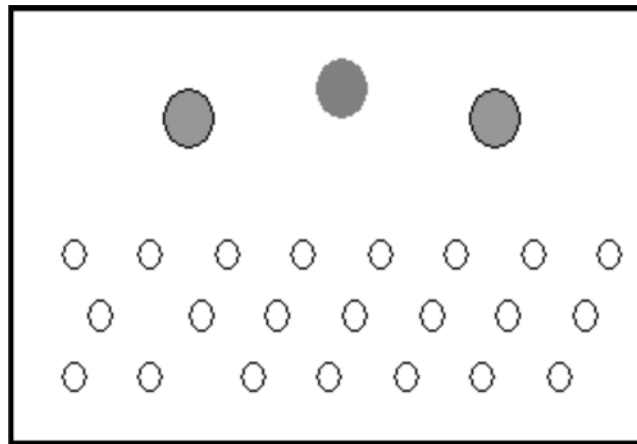

*Director Cadets 3, 2006, Ottawa, ON: Department of National Defence*

Figure 10-2-2 Instructor at the Front With Two Assistant Instructors

2. Demonstrate before having the cadets attempt each stretch/light cardiovascular exercise.
3. Assistant instructors may help demonstrate the exercises and ensure the cadets are performing them correctly.
4. Have cadets perform each stretch/light cardiovascular exercise.



Light cardiovascular exercises should be done to warm up the muscles prior to stretching to avoid injury to or tearing of the muscles. For example, running on the spot for 30 seconds or performing jumping jacks should be performed prior to conducting the stretches located at Annex A.

## SAFETY

- Ensure there are at least two arm lengths between the cadets so they can move freely.
- Ensure the cadets perform the stretches and light cardiovascular exercises in a safe manner, following the guidelines for stretching listed in this TP.



---

## CONFIRMATION OF TEACHING POINT 2

---

The cadets' participation in the warm-up session will serve as the confirmation of this TP.

---

### Teaching Point 3

### Conduct a Recreational Summer Biathlon Activity

Time: 140 min

Method: Practical Activity

---

## ACTIVITY

---

### OBJECTIVE

The objective of this activity is to have the cadets participate in a recreational summer biathlon activity.

### RESOURCES

Based on 25 cadets per group, the equipment required to conduct the recreational summer biathlon activity shall include, but is not limited to, the following:

- Cadet air rifles (6),
- Shooting mats (10),
- Air rifle pellets (a minimum of 875 pellets),
- Container to hold pellets (5),
- Stopwatches (6),
- BART (5),
- Safety glasses/goggles (10),
- Notice board,
- Biathlon scoresheets located at Annex C,
- Course control sheets located at Annex D, and
- Range recording sheets located at Annex E.

### ACTIVITY LAYOUT

- Set up a first aid station.
- Set up a running route of approximately 1000 m.
- Set up an air rifle range IAW A-CR-CCP-177/PT-001, Part 1, Section 8, with a minimum of five lanes for 25 cadets.
- Set up BARTs.
- Place two shooting mats per firing lane (a minimum of five firing lanes for 25 cadets).
- Place a cadet air rifle at each firing point.
- Place a pair of safety glasses/goggles at each firing point.

### ACTIVITY INSTRUCTIONS

Activity instructions are located at Annex B.

## SAFETY

- Ensure all range safety procedures are followed.
- Ensure cadets drink fluids and apply sunscreen.
- Ensure the running route is clearly marked and crossing points are monitored anywhere a road may be crossed.
- Ensure a first-aider is identified at the start of the activity and is available at all times.
- Ensure water is available for the cadets during and after the activity.

---

### CONFIRMATION OF TEACHING POINT 3

---

The cadets' participation in the activity will serve as the confirmation of this TP.

---

#### Teaching Point 4

#### Conduct a Cool-Down Session Composed of Light Cardiovascular Exercises

Time: 10 min

Method: Practical Activity

---



The following information will be explained to the cadets during the cool-down session.

#### PURPOSE OF A COOL-DOWN

A cool-down is composed of stretches and light cardiovascular exercises designed to:

- allow the body time to slowly recover from physical activity and to help prevent injury;
- prepare the respiratory system to return to its normal state; and
- stretch the muscles to help relax and restore them to their resting length.



The stretches chosen should focus on the areas of the body that were used the most during the sports activity.

---

### ACTIVITY

---

#### OBJECTIVE

The objective of the cool-down is to stretch the muscles and perform light cardiovascular exercises that allow the body time to recover from physical activity, and to prevent injury.

#### RESOURCES

N/A.

**ACTIVITY LAYOUT**

N/A.

**ACTIVITY INSTRUCTIONS**

1. Arrange the cadets in either a warm-up circle or in rows (as illustrated in Figures 10-2-1 and 10-2-2).
2. Demonstrate before having the cadets attempt each stretch/light cardiovascular exercise.
3. Assistant instructors may help demonstrate the movements and ensure the cadets are performing them correctly.
4. Have cadets perform each stretch/light cardiovascular exercise.

**SAFETY**

- Ensure there are at least two arm lengths between the cadets so they can move freely.
- Ensure the cadets perform the stretches and light cardiovascular exercises in a safe manner, following the guidelines for stretching listed in TP 1.

---

**CONFIRMATION OF TEACHING POINT 4**

---

The cadets' participation in the cool-down session will serve as the confirmation of this TP.

---



---

**END OF LESSON CONFIRMATION**

---

The cadets' participation in a recreational summer biathlon activity will serve as the confirmation of this lesson.

---



---

**CONCLUSION**

---

**HOMEWORK/READING/PRACTICE**

N/A.

**METHOD OF EVALUATION**

N/A.

**CLOSING STATEMENT**

Recreational summer biathlon is an activity that requires personal discipline, develops marksmanship skills and promotes physical fitness. Participation in a recreational summer biathlon activity may improve personal fitness level.

**INSTRUCTOR NOTES/REMARKS**

EO C311.01 (Practice Aiming and Firing the Cadet Air Rifle Following Physical Activity, Section 1) shall be taught prior to conducting this activity.

---



---

**REFERENCES**



---

A0-027 A-CR-CCP-177/PT-001 Director Cadets 3. (2001). *Cadet Marksmanship Program: Reference Manual*. Ottawa, ON: Department of National Defence.

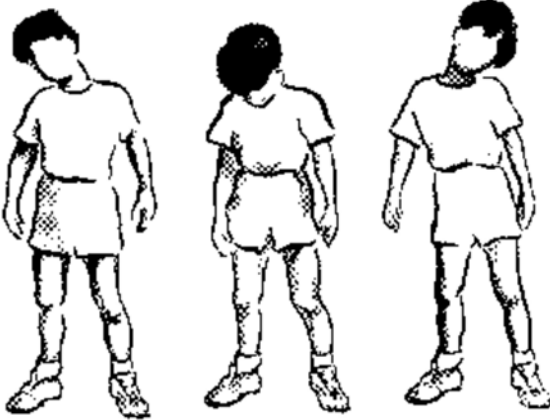

- A0-036 Cadets Canada. (n.d.). *Canadian Cadet Movement: Biathlon Championship Series*. Ottawa, ON: Department of National Defence.
- A0-098 Director Cadets 4. (2007). CATO 14-42, *Biathlon Common Program*. Ottawa, ON: Department of National Defence.
- C0-002 (ISBN 0-88962-630-8) LeBlanc, J., & Dickson, L. (1997). *Straight Talk About Children and Sport: Advice for Parents, Coaches, and Teachers*. Oakville, ON: Mosaic Press.
- C0-089 (ISBN 0-936070-22-6) Anderson, B. (2000). *Stretching: 20<sup>th</sup> Anniversary* (Rev. ed.). Bolinas, CA: Shelter Publications, Inc.

### SAMPLE STRETCHES

a. Neck:

 <p><i>B. Hanson, Moving on the Spot: A Collection of 5 Minute Stretch and Movement Sessions, Toronto Public Health. Retrieved October 26, 2006, from <a href="http://www.lin.ca/resource/html/dn3.htm#1">http://www.lin.ca/resource/html/dn3.htm#1</a></i></p> <p>Figure 10A-1 Neck Stretch</p>	<p>Slowly roll your head across your chest from shoulder to shoulder. Do not roll your head backwards.</p>
---	--

b. Shoulders:

 <p><i>B. Hanson, Moving on the Spot: A Collection of 5 Minute Stretch and Movement Sessions, Toronto Public Health. Retrieved October 26, 2006, from <a href="http://www.lin.ca/resource/html/dn3.htm#1">http://www.lin.ca/resource/html/dn3.htm#1</a></i></p> <p>Figure 10A-2 Shoulder Push</p>	<p>Stand and extend your arms behind you, interlocking your fingers. Push up and back with your shoulders.</p> <p>Hold this position for a minimum of 10 seconds.</p>
 <p><i>B. Hanson, Moving on the Spot: A Collection of 5 Minute Stretch and Movement Sessions, Toronto Public Health. Retrieved October 26, 2006, from <a href="http://www.lin.ca/resource/html/dn3.htm#1">http://www.lin.ca/resource/html/dn3.htm#1</a></i></p> <p>Figure 10A-3 Shoulder Shrug</p>	<p>Stand and raise your shoulders as high as possible and then lower your shoulders, stretching your neck up.</p> <p>Pull your shoulders back as far as possible and then round your shoulders forward by pushing your shoulders forward as far as possible.</p> <p>Hold each position for a minimum of 10 seconds.</p>



Warm Ups, by Martha Jefferson Hospital, Copyright 2001 by Martha Jefferson Hospital. Retrieved October 26, 2006, from <http://www.marthajefferson.org/warmup.php>

Figure 10A-4 Arm Circles

Hold your arms straight out, palms up. Make small circles with your arms, gradually increasing the size.

Reverse the direction of your circles.



Smart Start: A Flexible Way to Get Fit. Retrieved October 26, 2006, from <http://www.in-motion.ca/walkingworkout/plan/flexibility/>

Figure 10A-5 Shoulder Stretch

Either standing or sitting, take your right arm in your left hand and bring it across your chest, supporting the joint by holding it behind the elbow. Pull lightly on the elbow towards your chest. You should feel the stretch in your right shoulder.

Hold this position for a minimum of 10 seconds and repeat on the opposite side.

c. Arms:



Exercises. Copyright 1998 by Impacto Protective Products Inc. Retrieved October 26, 2006, from <http://www.2protect.com/home.htm>

Figure 10A-6 Wrist Rotations

Rotate your hands in circular motions at the wrist.

Change direction and repeat on both sides.



Smart Start: A Flexible Way to Get Fit. Retrieved October 26, 2006, from <http://www.in-motion.ca/walkingworkout/plan/flexibility/>

Figure 10A-7 Triceps Stretch

Stand and bring your right arm over your head, bent at the elbow. Use your left hand to gently pull your arm down.

Hold this position for a minimum of 10 seconds and repeat on the opposite side.



*Exercise Programme for Squash, Tennis, Softball, Handball. Retrieved October 26, 2006, from <http://www.physionline.co.za/conditions/article.asp?id=49>*

Figure 10A-8 Forearm Stretch

In a kneeling position, place your hands on the floor in front of you turned so that your fingers are pointing toward your knees, and your thumbs are pointing out. Keeping your hands flat on the floor, lean back.  
Hold this position for a minimum of 10 seconds.

d. Chest and Abdominals:



*Smart Start: A Flexible Way to Get Fit. Retrieved October 26, 2006, from <http://www.in-motion.ca/walkingworkout/plan/flexibility/>*

Figure 10A-9 Chest Stretch

Stand facing a wall. With your right arm bent and your elbow at shoulder height, place your palm against the wall. Turn your body away from your right arm. You should feel the stretch on the front side of your armpit and across the front of your chest.

Hold this position for a minimum of 10 seconds and repeat on the opposite side.



*B. Hanson, Moving on the Spot: A Collection of 5 Minute Stretch and Movement Sessions, Toronto Public Health. Retrieved October 26, 2006, from <http://www.lin.ca/resource/html/dn3.htm#1>*

Figure 10A-10 Side Stretch

Stand with your left arm up over your head. Bend at your waist towards the right side of your body.

Hold this position for a minimum of 10 seconds and repeat on the opposite side.

e. Back:



*Smart Start: A Flexible Way to Get Fit. Retrieved October 26, 2006, from <http://www.in-motion.ca/walkingworkout/plan/flexibility/>*

Figure 10A-11 Lower Back Stretch

Lie on your back and bring your knees toward your chest. Grasp the back of your knees.  
Hold this position for a minimum of 10 seconds.

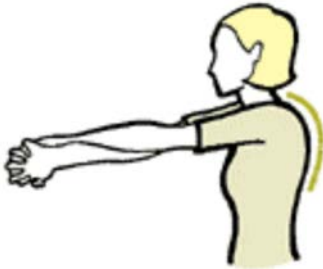

*Smart Start: A Flexible Way to Get Fit. Retrieved October 26, 2006, from <http://www.in-motion.ca/walkingworkout/plan/flexibility/>*

Figure 10A-12 Upper Back Stretch

Extend your arms straight in front of you at shoulder height crossing one arm over the other. With the palms facing each other, intertwine your fingers and press out through your arms. Let your chin fall to your chest as you exhale. You should feel the stretch in the upper back.  
Hold this position for a minimum of 10 seconds and repeat on the opposite side.

f. Legs:





*Smart Start: A Flexible Way to Get Fit. Retrieved October 26, 2006, from <http://www.in-motion.ca/walkingworkout/plan/flexibility/>*

Figure 10A-13 Hamstring Stretch

Lie flat on the floor with your knees bent and your back flat on the floor. Slowly raise and straighten one leg, grasping it behind your thigh with both hands.

Hold this position for a minimum of 10 seconds.



*Smart Start: A Flexible Way to Get Fit. Retrieved October 26, 2006, from <http://www.in-motion.ca/walkingworkout/plan/flexibility/>*

Figure 10A-14 Inner Thigh Stretch

Sit on the floor with your knees bent and the soles of your feet together. Grab your toes and pull yourself forward while keeping your back and neck straight.

Hold this position for a minimum of 10 seconds.

Grab your ankles and push your knees down toward the floor with your elbows.

Hold this position for a minimum of 10 seconds.



*Smart Start: A Flexible Way to Get Fit. Retrieved October 26, 2006, from <http://www.in-motion.ca/walkingworkout/plan/flexibility/>*

Figure 10A-15 Hip Flexor

Kneel on your right knee. Position your left foot in front of you, bending your knee and placing your left hand on that leg for stability. Keep your back straight and abdominal muscles tight. Lean forward, shifting more body weight onto your front leg. You should feel the stretch in the front of your hip and the thigh of the leg you are kneeling on. Cushion your kneecap with a folded towel if necessary.

Hold this position for a minimum of 10 seconds and repeat on the opposite side.



*Running Exercises. Retrieved October 26, 2006, <http://www.physionline.co.za/conditions/article.asp?id=46>*

Figure 10A-16 Ankle Rotations

From a sitting position, rotate your foot in a clockwise, and then a counter-clockwise, direction.

Switch and repeat on the opposite side.



*Smart Start: A Flexible Way to Get Fit. Retrieved October 26, 2006, from <http://www.in-motion.ca/walkingworkout/plan/flexibility/>*

Figure 10A-17 Calf Stretch

Stand three steps away from and facing a wall. Step in towards the wall with your right leg, bending your right knee and keeping your left leg straight. Extending your arms with your palms forward, reach out to the wall and let your body fall toward the wall. Keep your toes forward and your heels down. Lean your body into the wall with your left leg straight behind your body. You should feel the stretch in your left calf.

Hold this position for a minimum of 10 seconds and repeat on the opposite side.



*Smart Start: A Flexible Way to Get Fit. Retrieved October 26, 2006, from <http://www.in-motion.ca/walkingworkout/plan/flexibility/>*

Figure 10A-18 Quadriceps Stretch

Stand with your hand against a wall for balance. Lift your left foot off the ground, bending your knee as if you are trying to kick your bottom with your heel. Do not lean forward at the hips. Grab and hold your ankle with your left hand. You should feel the stretch in your left thigh.

Hold this position for a minimum of 10 seconds and repeat on the opposite side.

## GUIDELINES TO CONDUCT A RECREATIONAL SUMMER BIATHLON ACTIVITY

### OBJECTIVES

The objectives of the recreational summer biathlon activity are:

- to practice and improve marksmanship skills;
- to improve personal fitness level; and
- to introduce the cadets to the sport of summer biathlon.

### COMPOSITION

Cadets will be divided into teams for the summer biathlon activity. For a group of 25 cadets, the cadets should be divided into groups of five.

### FACILITIES

The facilities required to conduct a recreational summer biathlon activity are:

- a route, approximately 1000 m with the start and finish lines located close to the range. The route should be wide enough to accommodate a maximum of 10 cadets running at one time. When roads are to be crossed, they must be clearly marked and a central crossing point established with traffic control provided, and

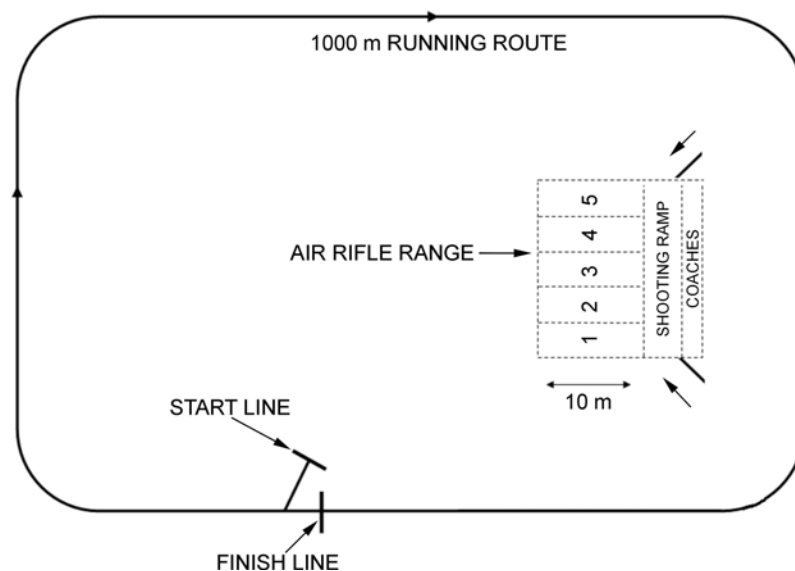

*Director Cadets 3, 2008, Ottawa, ON: Department of National Defence*

Figure 10B-1 Recreational Summer Biathlon Activity Course Layout

- an air rifle range constructed IAW A-CR-CCP-177/PT-001, Part 1, Section 8, with a minimum of one firing lane per cadet per group.

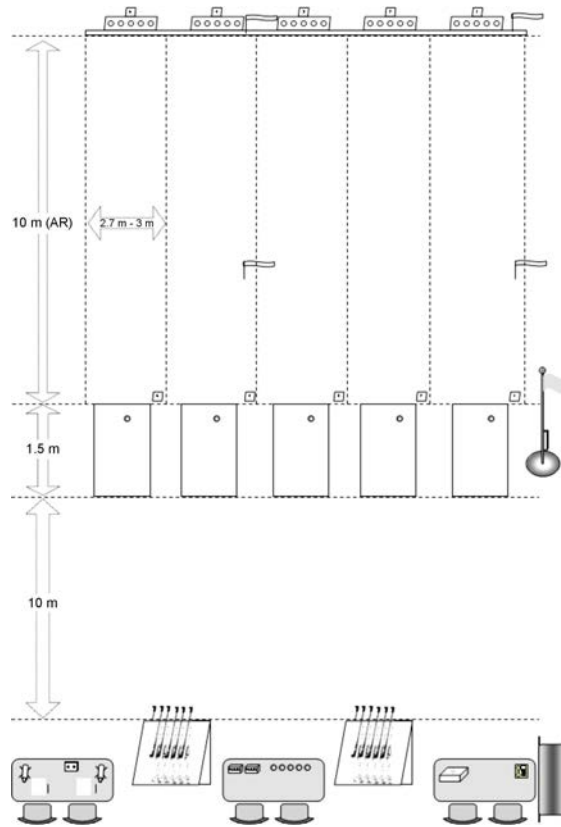

*Director Cadets 3, 2008, Ottawa, ON: Department of National Defence*

Figure 10B-2 Recreational Summer Biathlon Air Rifle Range Layout

## STAFFING

Numerous staff are required to conduct a recreational summer biathlon activity. These appointments shall include:

- **Technical Delegate.** Responsible for the overall conduct of the competition, including issuing penalties, and interpreting the rules.
- **Range Safety Officer (RSO).** Responsible for the overall conduct of the activities on the range.
- **Assistant RSO.** Responsible for targets, issuing ammunition, and assisting the RSO, as required.
- **Lane Scorekeeper.** Responsible for scoring targets and recording results on the range recording sheet (located at Annex E).
- **Chief of Statistics.** Responsible for compiling all the event data (eg, range results, start/finish time, and any penalties assessed).
- **Runner.** Responsible for collecting the scoring sheets and delivering them to the chief of statistics.
- **Start and Finish Line Chief.** Responsible for starting the run and recording the finish times on the scoresheet (located at Annex C).
- **Course Controller.** Responsible for recording each time the cadet runs a route on the course control sheet (located at Annex D).
- **First-Aider.** Responsible for dealing with any injuries that may occur during the competition.

## **FORMAT**

### **Briefing**

All cadets will attend an initial briefing. This will include the essential information required by the cadets to participate in the recreational summer biathlon activity. The cadets are given:

- start times,
- range lane assignments,
- weather updates, and
- an introduction to the competition staff.

### **The Running Route**

Each cadet will run three separate routes of approximately 1000 m. Each running route will consist of:

- each team assembling for a mass start (teams will have a two-minute interval between start times);
- each team finishing as a complete team; and
- crossing the finish line as a team.

### **The Range**

Each cadet will fire five to eight pellets in an effort to knock down all five targets on the BART. After each bout of firing, the appropriate lane scorer will record the team's results and reset the BART.

When all members of the team have completed firing, they will re-assemble for a mass start for the next running route.

## **SEQUENCE**

This recreational summer biathlon activity will be conducted in the following sequence:

- running a route of approximately 1000 m;
- firing five to eight pellets at the BART;
- running a route of approximately 1000 m;
- firing five to eight pellets at the BART;
- running a third route of approximately 1000 m; and
- crossing the finish line.

## **EQUIPMENT**

Based on 25 cadets, the equipment required to conduct the recreational summer biathlon activity shall include, but is not limited to, the following:

- Cadet air rifles (6),
- Shooting mats (10),
- Air rifle pellets (a minimum of 875 pellets),
- Container to hold pellets (5),
- Stopwatches (6),

- BART (5),
- Safety glasses/goggles (10),
- Notice board,
- Biathlon scoresheets located at Annex C,
- Course control sheets located at Annex D, and
- Range recording sheets located at Annex E.

## **DRESS**

Appropriate clothing according to the weather forecast.

## **RULES AND REGULATIONS**

- The cadets must remain in their own teams throughout the activity
- The cadets must use the same firing lane for the duration of the activity.
- The run must be completed in the proper sequence and on the marked route.
- Cadet air rifles must be placed on the firing point by the range staff and will remain there for the duration of the activity.
- All firing will be done in the prone position.
- The cadet air rifle must be made safe upon completion of firing.
- An inoperable cadet air rifle will be replaced by the range staff, the target will be reset, and the cadet will fire five to eight rounds with the new rifle.
- Safety infractions will result in time penalties.
- Missed targets will result in time penalties.

## **SCORING**

The team's final score is determined by adding the total time for all run routes plus any penalties issued. The team with the lowest final score is considered the winning team.

Scoring will be calculated as follows:

- **Time.** The team's final time is the time from the start to finish, and any penalties.
- **Targets.** For each relay of firing, the number of hit and missed targets will be recorded on the range recording sheet by the lane scorekeeper (located at Annex C). There is no positive point value for each hit target; competitors will be deducted points for each missed target.

## **PENALTIES**

The following penalties will be added to the team's time:

- Each violation of the principles of fair play or good sportsmanship will result in a one-minute penalty, to include:
  - not giving way in an area of congestion;
  - pushing or shoving;
  - using profanity; and
  - interfering with other competitors.

- Each missed target will result in a 10-second penalty.
- Each safety infraction on the firing point will result in a two-minute penalty, to include:
  - not keeping control of the cadet air rifle;
  - moving forward of the firing point; and
  - intentionally firing rounds at objects other than the BART.
- Each team member not crossing the finish line will result in a two-minute penalty.

### **OUT OF BOUNDS AREA**

Out of bounds areas will be clearly identified prior to the start of the recreational summer biathlon activity.

### **NOTES**

- Course control staff will record each time a team completes a route. See course control sheet located at Annex D.
- The start and finish line chief will keep records for each team. When the sheet is full or nearly full the runner will take the sheet to the chief of statistics. See scoresheet located at Annex C.
- Bibs may be used to identify cadets, if available.

THIS PAGE INTENTIONALLY LEFT BLANK





THIS PAGE INTENTIONALLY LEFT BLANK



THIS PAGE INTENTIONALLY LEFT BLANK

**RANGE RECORDING SHEET**

Scorekeeper's Name: \_\_\_\_\_

Cadet Name:	Lane	Shots Fired	X = Miss	Misses	Comments/Penalties
Cadet Name:	Lane	Shots Fired			
		3 Spare	○ ○ ○ ○ ○ ○ ○ ○ ○ ○		
Cadet Name:	Lane	Shots Fired	X = Miss	Misses	
		3 Spare	○ ○ ○ ○ ○ ○ ○ ○ ○ ○		
Cadet Name:	Lane	Shots Fired	X = Miss	Misses	
		3 Spare	○ ○ ○ ○ ○ ○ ○ ○ ○ ○		
Cadet Name:	Lane	Shots Fired	X = Miss	Misses	
		3 Spare	○ ○ ○ ○ ○ ○ ○ ○ ○ ○		
Cadet Name:	Lane	Shots Fired	X = Miss	Misses	
		3 Spare	○ ○ ○ ○ ○ ○ ○ ○ ○ ○		
Cadet Name:	Lane	Shots Fired	X = Miss	Misses	
		3 Spare	○ ○ ○ ○ ○ ○ ○ ○ ○ ○		
Cadet Name:	Lane	Shots Fired	X = Miss	Misses	
		3 Spare	○ ○ ○ ○ ○ ○ ○ ○ ○ ○		
Cadet Name:	Lane	Shots Fired	X = Miss	Misses	
		3 Spare	○ ○ ○ ○ ○ ○ ○ ○ ○ ○		

THIS PAGE INTENTIONALLY LEFT BLANK



## ROYAL CANADIAN ARMY CADETS

BOOK 2 OF 2

# SILVER STAR INSTRUCTIONAL GUIDES

(ENGLISH)

(Supersedes A-CR-CCP-703/PF-001 dated 2015-09-01)

Cette publication est disponible en français sous le numéro A-CR-CCP-703/PF-002.

**Issued on Authority of the Chief of the Defence Staff**

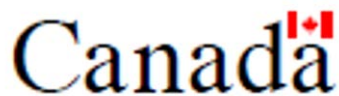



### NOTICE

This documentation has been reviewed by the technical authority and does not contain controlled goods. Disclosure notices and handling instructions originally received with the document shall continue to apply.

### AVIS

Cette documentation a été révisée par l'autorité technique et ne contient pas de marchandises contrôlées. Les avis de divulgation et les instructions de manutention reçues originalement doivent continuer de s'appliquer.





## ROYAL CANADIAN ARMY CADETS

BOOK 2 OF 2

# SILVER STAR INSTRUCTIONAL GUIDES

(ENGLISH)

(Supersedes A-CR-CCP-703/PF-001 dated 2015-09-01)

Cette publication est disponible en français sous le numéro A-CR-CCP-703/PF-002.

**Issued on Authority of the Chief of the Defence Staff**

**LIST OF EFFECTIVE PAGES**

Insert latest changed pages; dispose of superseded pages in accordance with applicable orders.

**NOTE**

On a changed page, the portion of the text affected by the latest change is indicated by a vertical line in the margin of the page. Changes to illustrations by miniature pointing hands, or black vertical lines.

Dates of issue for original and changed pages are:

Original .....	0 .....	2016-09-01	Change .....	3 .....
Change .....	1 .....		Change .....	4 .....
Change .....	2 .....		Change .....	5 .....

Zero in Change No. column indicates an original page. Total number of pages in this publication is 651, consisting of the following:

Page No.	Change No.	Page No.	Change No.
<b>BOOK 2</b>			
Cover page .....	0	14-M324.01-1 to 14-M324.01-10.....	0
Title .....	0	14-M324.02-1 to 14-M324.02-10.....	0
A to C .....	0	14-M324.03-1 to 14-M324.03-12.....	0
i to vi .....	0	14-M324.04-1 to 14-M324.04-14.....	0
11-X20-1/2 .....	0	14-M324.05-1 to 14-M324.05-14.....	0
11-X20-1 to 11-X20-2 .....	0	14-C324.01-1 to 14-C324.01-14.....	0
12-321-1/2 .....	0	14-C324.02-1 to 14-C324.02-12.....	0
12-M321.01-1 to 12-M321.01-6.....	0	14-C324.03-1 to 14-C324.03-14.....	0
12-M321.02-1 to 12-M321.02-12.....	0	14-C324.04-1 to 14-C324.04-22.....	0
12-C321.01-1 to 12-C321.01-14.....	0	14-C324.05-1 to 14-C324.05-16.....	0
12-C321.02-1 to 12-C321.02-10.....	0	14A-1 to 14A-2 .....	0
12-C321.03-1 to 12-C321.03-24.....	0	14B-1 to 14B-2 .....	0
12A-1 to 12A-2 .....	0	14C-1 to 14C-2 .....	0
12B-1 to 12B-6 .....	0	14D-1 to 14D-2 .....	0
13-322-1/2 .....	0	14E-1 to 14E-2 .....	0
13-M322.01-1 to 13-M322.01-14.....	0	14F-1 to 14F-8 .....	0
13-M322.02-1 to 13-M322.02-10.....	0	14G-1 to 14G-2 .....	0
13-M322.03-1 to 13-M322.03-10.....	0	14H-1 to 14H-2 .....	0
13-M322.04-1 to 13-M322.04-10.....	0	14I-1 to 14I-2 .....	0
13-M322.05-1 to 13-M322.05-16.....	0	14J-1 to 14J-6 .....	0
13-M322.06-1 to 13-M322.06-14.....	0	15-325-1/2 .....	0
13-C322.01-1 to 13-C322.01-8.....	0	15-M325.01-1 to 15-M325.01-12.....	0
13-C322.02-1 to 13-C322.02-12.....	0	15-M325.02-1 to 15-M325.02-14.....	0
13-C322.03-1 to 13-C322.03-12.....	0	15-M325.03-1 to 15-M325.03-10.....	0
13-C322.04-1 to 13-C322.04-4.....	0	15-C325.01-1 to 15-C325.01-18.....	0
13A-1 to 13A-2 .....	0	15-C325.02-1 to 15-C325.02-8.....	0
13B-1 to 13B-2 .....	0	15A-1 to 15A-2 .....	0
13C-1 to 13C-2 .....	0	15B-1 to 15B-2 .....	0
13D-1 to 13D-2 .....	0	15C-1 to 15C-2 .....	0
13E-1 to 13E-2 .....	0	15D-1 to 15D-2 .....	0
13F-1 to 13F-2 .....	0	15E-1 to 15E-2 .....	0
14-324-1/2 .....	0	15F-1 to 15F-6 .....	0
		15G-1 to 15G-4 .....	0

**LIST OF EFFECTIVE PAGES (CONT)**

<b>Page No.</b>	<b>Change No.</b>	<b>Page No.</b>	<b>Change No.</b>
15H-1 to 15H-2 .....	0	16-M326.02C-1 to 16-M326.02C-24 .....	0
15I-1 to 15I-2 .....	0	16-M326.03-1 to 16-M326.03-12 .....	0
15J-1 to 15J-6 .....	0	16-M326.04-1 to 16-M326.04-12 .....	0
16-326-1/2 .....	0	16-M326.05-1 to 16-M326.05-14 .....	0
16-M326.01-1 to 16-M326.01-10 .....	0	16-M326.06-1 to 16-M326.06-16 .....	0
16-M326.02A-1 to 16-M326.02A-38 .....	0	16-M326.07-1 to 16-M326.07-8 .....	0
16-M326.02B-1 to 16-M326.02B-32 .....	0	16A-1 to 16A-6 .....	0

THIS PAGE INTENTIONALLY LEFT BLANK

## FOREWORD AND PREFACE

1. **Issuing Authority.** This Instructional Guide (IG) A-CR-CCP-703/PF-001 was developed under the authority of the Director Cadets and Junior Canadian Rangers, and issued on the authority of the Chief of Defence Staff.
2. **Development.** Development of this IG was in accordance with the performance oriented concept of training outlined in the A-P9-050 Series, Canadian Forces Individual Training and Education System, with modifications to meet the needs of the Canadian Cadet Organization.
3. **Purpose of the IG.** The IG to be used by Royal Canadian Army Cadet Corps in conjunction with other resources to conduct the Silver Star Program. The IG provides instructors with the base means from which to deliver training. Individual IGs are to be reviewed in conjunction with the Lesson Specifications (LSs) found in A-CR-CCP-703/PG-001, *Royal Canadian Army Cadets – Silver Star – Qualification Standard and Plan*, Chapter 4, before instructing, so that each instructor can adequately plan for and prepare each lesson. Instructors may be required to develop instructional materials to support training in addition to any that may be provided, eg, posters, videos, handouts, models, etc, supplemental to training control and support documents. Suggested instructional activities are included in most IGs to maximize learning and fun. Instructors are also encouraged to modify and/or enhance the activities, as long as they continue to contribute to enabling objective achievement.
4. **Use of the IG.** Throughout these instructional guides, a series of information boxes are used to highlight information; they include:



Note to the Instructor.



Key information to pass along to cadets.



Refer to the following CF regulations and policies.

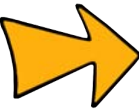

Points of interest or special instructions the instructor should pass along to cadets.

5. **Suggested Changes.** Suggested changes to this document may be sent directly to [cadetraining@canada.ca](mailto:cadetraining@canada.ca).

THIS PAGE INTENTIONALLY LEFT BLANK

## TABLE OF CONTENTS

## PAGE

## BOOK 2

<b>CHAPTER 11</b>	<b>PO X20 – PARTICIPATE IN CAF FAMILIARIZATION</b>	11-X20-1/2
<b>CHAPTER 12</b>	<b>PO 321 – PERFORM THE DUTIES OF A TEAM LEADER ON A WEEKEND BIVOUAC EXERCISE</b>	12-321-1/2
Section 1	EO M321.01 – PERFORM THE DUTIES OF A TEAM LEADER IN THE FIELD.....	12-M321.01-1
Section 2	EO M321.02 – CONSTRUCT COMPONENTS OF A BIVOUAC SITE....	12-M321.02-1
Section 3	EO C321.01 – IDENTIFY METHODS OF WASTE DISPOSAL IN THE FIELD.....	12-C321.01-1
Section 4	EO C321.02 – IDENTIFY SAFETY CONSIDERATIONS WHEN TRAVELLING OVER SNOW AND ICE.....	12-C321.02-1
Section 5	EO C321.03 – CONSTRUCT FIELD AMENITIES.....	12-C321.03-1
Annex A	SAMPLE BIVOUAC SITE DIAGRAM HANDOUT.....	12A-1
Annex B	FIELD AMENITIES.....	12B-1
<b>CHAPTER 13</b>	<b>PO 322 – PLOT LOCATION ON A TOPOGRAPHICAL MAP USING A GLOBAL POSITIONING SYSTEM RECEIVER</b>	13-322-1/2
Section 1	EO M322.01 – REVIEW RED STAR NAVIGATION.....	13-M322.01-1
Section 2	EO M322.02 – CALCULATE MAGNETIC DECLINATION.....	13-M322.02-1
Section 3	EO M322.03 – IDENTIFY COMPONENTS OF THE GLOBAL POSITIONING SYSTEM (GPS).....	13-M322.03-1
Section 4	EO M322.04 – IDENTIFY FEATURES OF A GLOBAL POSITIONING SYSTEM (GPS) RECEIVER.....	13-M322.04-1
Section 5	EO M322.05 – SET A MAP DATUM ON A GLOBAL POSITIONING SYSTEM (GPS) RECEIVER.....	13-M322.05-1
Section 6	EO M322.06 – IDENTIFY LOCATION USING A GLOBAL POSITIONING SYSTEM (GPS) RECEIVER.....	13-M322.06-1
Section 7	EO C322.01 – PRACTICE NAVIGATION AS A MEMBER OF A SMALL GROUP.....	13-C322.01-1
Section 8	EO C322.02 – IDENTIFY FACTORS THAT IMPACT NAVIGATION IN THE WINTER.....	13-C322.02-1
Section 9	EO C322.03 – IDENTIFY THE PRINCIPLES OF MAP-MAKING.....	13-C322.03-1
Section 10	EO C322.04 – DRAW A MAP OF AN AREA IN THE LOCAL TRAINING FACILITY.....	13-C322.04-1
Annex A	DECLINATION PROBLEM WORKSHEET.....	13A-1
Annex B	ANSWER KEY TO DECLINATION PROBLEM WORKSHEET.....	13B-1
Annex C	SIMULATED MAP DATUM.....	13C-1
Annex D	GRID OVERLAY.....	13D-1
Annex E	CANADIAN UTM ZONES.....	13E-1

## TABLE OF CONTENTS (Cont)

		<b>PAGE</b>
Annex F	GRAPH PAPER.....	13F-1
<b>CHAPTER 14</b>	<b>PO 324 – SURVIVE WHEN LOST</b>	14-324-1/2
Section 1	EO M324.01 – CONSTRUCT AN IMPROVISED SHELTER.....	14-M324.01-1
Section 2	EO M324.02 – COLLECT DRINKING WATER.....	14-M324.02-1
Section 3	EO M324.03 – LIGHT A FIRE WITHOUT MATCHES.....	14-M324.03-1
Section 4	EO M324.04 – PREDICT WEATHER.....	14-M324.04-1
Section 5	EO M324.05 – DETERMINE WHEN TO SELF-RESCUE.....	14-M324.05-1
Section 6	EO C324.01 – IDENTIFY ANIMAL AND INSECT FOOD SOURCES.....	14-C324.01-1
Section 7	EO C324.02 – CONSTRUCT SNARES.....	14-C324.02-1
Section 8	EO C324.03 – CATCH A FISH.....	14-C324.03-1
Section 9	EO C324.04 – COLLECT EDIBLE PLANTS.....	14-C324.04-1
Section 10	EO C324.05 – PREPARE A MEAL FROM FIELD FOOD SOURCES.....	14-C324.05-1
Annex A	BOW AND DRILL.....	14A-1
Annex B	FIRE SAW.....	14B-1
Annex C	FLINT AND STEEL.....	14C-1
Annex D	SUN AND GLASS.....	14D-1
Annex E	COMMON TYPES OF CLOUDS.....	14E-1
Annex F	COMMON HABITAT.....	14F-1
Annex G	INSECT NUTRITIONAL VALUE CHART.....	14G-1
Annex H	COMMON POISONOUS PLANTS.....	14H-1
Annex I	COMMON POISONOUS PLANTS.....	14I-1
Annex J	METHODS OF FIELD COOKING HANDOUT.....	14J-1
<b>CHAPTER 15</b>	<b>PO 325 – IDENTIFY THE COMPETENCIES OF AN OUTDOOR LEADER</b>	15-325-1/2
Section 1	EO M325.01 – PARTICIPATE IN A DISCUSSION ON ARMY CADET EXPEDITION TRAINING.....	15-M325.01-1
Section 2	EO M325.02 – LIST THE COMPETENCIES OF AN OUTDOOR LEADER (OL).....	15-M325.02-1
Section 3	EO M325.03 – DISCUSS SELF-AWARENESS AND PROFESSIONAL CONDUCT AS A COMPETENCY OF AN OUTDOOR LEADER (OL).....	15-M325.03-1
Section 4	EO C325.01 – COMMUNICATE DURING AN EXPEDITION.....	15-C325.01-1
Section 5	EO C325.02 – PARTICIPATE IN A PRESENTATION ON THE DUKE OF EDINBURGH AWARD PROGRAM.....	15-C325.02-1
Annex A	SCENARIO.....	15A-1
Annex B	INFORMATION CARD A.....	15B-1
Annex C	INFORMATION CARD B.....	15C-1
Annex D	INFORMATION CARD C.....	15D-1



**TABLE OF CONTENTS (Cont)**

		<b>PAGE</b>
Annex E	EXPERT ACTIVITY SHEET.....	15E-1
Annex F	COMPETENCIES OF AN OUTDOOR LEADER HANDOUT.....	15F-1
Annex G	HOMEWORK ASSIGNMENT.....	15G-1
Annex H	SCENARIO.....	15H-1
Annex I	PHONETIC ALPHABET AND PRONUNCIATION OF NUMBERS HANDOUT.....	15I-1
Annex J	RADIO COMMUNICATION EXERCISE.....	15J-1
<b>CHAPTER 16</b>	<b>PO 326 – PERFORM EXPEDITION SKILLS</b>	<b>16-326-1/2</b>
Section 1	EO M326.01 – PREPARE FOR EXPEDITION TRAINING.....	16-M326.01-1
Section 2	EO M326.02A – PADDLE A CANOE.....	16-M326.02A-1
Section 3	EO M326.02B – RIDE A MOUNTAIN BIKE.....	16-M326.02B-1
Section 4	EO M326.02C – HIKE ALONG A ROUTE.....	16-M326.02C-1
Section 5	EO M326.03 – PRACTICE ENVIRONMENTAL STEWARDSHIP AS A TEAM LEADER.....	16-M326.03-1
Section 6	EO M326.04 – NAVIGATE ALONG A ROUTE USING A MAP AND COMPASS.....	16-M326.04-1
Section 7	EO M326.05 – USE EXPEDITION EQUIPMENT.....	16-M326.05-1
Section 8	EO M326.06 – FOLLOW DAILY ROUTINE.....	16-M326.06-1
Section 9	EO M326.07 – RECORD ENTRIES IN A JOURNAL.....	16-M326.07-1
Annex A	SILVER STAR EXPEDITION JOURNAL.....	16A-1

THIS PAGE INTENTIONALLY LEFT BLANK

**CHAPTER 11**  
**PO X20 – PARTICIPATE IN CAF FAMILIARIZATION**





**COMMON TRAINING**  
**ALL TRAINING LEVELS**  
**INSTRUCTIONAL GUIDE**  
**CANADIAN ARMED FORCES**  
**(CAF) FAMILIARIZATION**



**PO X20 – PARTICIPATE IN CAF FAMILIARIZATION**

---

Total Time:

---

For the following EOs, refer to the lesson specifications located in A-CR-CCP-701/PG-001, *Royal Canadian Army Cadets Green Star Qualification Standard and Plan*:

- MX20.01A – Participate in a CAF Activity,
- MX20.01B – Participate in a CAF Familiarization Tour,
- MX20.01E – Attend a CAF Presentation,
- MX20.01F – Attend a CAF Commemorative Ceremony, and
- CX20.01 – Participate in CAF Familiarization Activities.

For the following EOs, refer to the instructional guides located in A-CR-CCP-701/PF-001, *Royal Canadian Army Cadets Green Star Instructional Guides*:

- MX20.01C – Fire the C7 Rifle,
- MX20.01D – Participate in a Mess Dinner,
- MX20.01G – Participate in CAF Familiarization Video Activities, and
- MX20.01H – Participate in CAF Familiarization Learning Stations.

THIS PAGE INTENTIONALLY LEFT BLANK

**CHAPTER 12**

**PO 321 – PERFORM THE DUTIES OF A TEAM LEADER ON A WEEKEND BIVOUAC EXERCISE**







**ROYAL CANADIAN ARMY CADETS**  
**SILVER STAR**  
**INSTRUCTIONAL GUIDE**



**SECTION 1**

**EO M321.01 – PERFORM THE DUTIES OF A TEAM LEADER IN THE FIELD**

---

Total Time: 30 min

---

**PREPARATION**

---

**PRE-LESSON INSTRUCTIONS**

Resources needed for the delivery of this lesson are listed in the lesson specification located in A-CR-CCP-703/PG-001, Chapter 4. Specific uses for said resources are identified throughout the instructional guide within the TP for which they are required.

Review the lesson content and become familiar with the material prior to delivering the lesson.

**PRE-LESSON ASSIGNMENT**

N/A.

**APPROACH**

An interactive lecture was chosen for this lesson to introduce the cadets to the duties of a team leader in the field.

---

**INTRODUCTION**

---

**REVIEW**

N/A.

**OBJECTIVES**

By the end of this lesson the cadet shall be expected to perform the duties of a team leader in the field during a weekend bivouac field training exercise (FTX).

**IMPORTANCE**

It is important for cadets to learn that being a team leader requires them to provide specific guidance to junior cadets and pass on the knowledge and skills experienced over their participation in the Cadet Program. Recognizing what a junior cadet finds challenging, defines the true meaning of a team leader who supervises their subordinates and identifies problems, offering guidance for a solution.

**Teaching Point 1****Discuss the Duties of a Team Leader During a Weekend Bivouac FTX**

Time: 10 min

Method: Interactive Lecture



As team leaders, Silver Star cadets are now expected to perform leadership roles, supervise, guide and provide assistance to junior cadets.

During this instruction, impress upon the cadets that their role as team leaders is not only to command but to assist, supervise, provide guidance and work together to aid training.

**DUTIES OF A TEAM LEADER****Supervising**

As team leaders, Silver Star cadets will be working with peers during field training activities. Their role will be to work as a team to supervise junior cadets during daily routine activities. To successfully supervise, they will have to share responsibility and aim toward accomplishing particular goals and outcomes.

At the beginning of an FTX, a group will typically require a lot of additional direction from the team leader as well as constant guidance and assistance. Team leaders will have to impart their knowledge and experiences to their subordinates to guide them through their challenges. As training progresses, the amount of supervision they provide can be scaled back. Through the guidance of the team leader, junior cadets will begin to understand what is required of them during an FTX. Daily routine becomes instinctive reducing the requirement for constant guidance and assistance.



**Scenario:** A new group of Green Star cadets are participating in their first FTX. They arrive at the bivouac site and are issued tents. Some senior cadets take their tents and locate the ideal tent site; perfect shelter, excellent view and situated with easy access to the rest of the site.

Upon returning to the group and their peers, they notice the cadets are still experiencing difficulty erecting their tents. There are few staff to help the cadets experiencing trouble, and the tents are finally erected well past the scheduled timing.

By looking after themselves first and neglecting their duties, the senior cadets failed to help their subordinates when the requirement to brief and help the junior cadets on the proper set-up of their tents was obvious. While the cadets work on their tents, senior cadets should be monitoring and assisting subordinates to speed up the task and finish on time with properly erected tents.

**Note:** By providing guidance to the subordinates before and during the set-up of the tents, subordinates are able to learn routine procedures on erecting their tents effectively the first time, therefore requiring less guidance and supervision the next time. It is important to meet the needs of junior cadets to prepare them for future challenges.

Team leaders should discuss and plan what actions they will take to encourage learning among cadets during an FTX. Junior cadets will face many challenges during daily routine activities and an agreed upon and unified approach to tasks will make these challenges easier. The following daily routine activities have to be supervised:

- meals,

- lights out and reveille,
- free time,
- personal hygiene routine,
- equipment use, and
- equipment maintenance.

---

### CONFIRMATION OF TEACHING POINT 1

---

#### QUESTIONS

- Q1. Who supervises junior cadets?
- Q2. Is supervision an individual task?
- Q3. What activities of daily routine have to be supervised?

#### ANTICIPATED ANSWERS

- A1. The entire group of team leaders.
- A2. No. Supervision of cadets should be planned and completed as a team.
- A3. The activities of daily routine that have to be supervised are meals, lights out and reveille, free time, personal hygiene routine, equipment use, and equipment maintenance.

---

#### Teaching Point 2

#### Discuss Supervising the Preparation of Meals

Time: 10 min

Method: Interactive Lecture

---



Team leaders will be responsible to oversee the preparation of meals. It is common for junior cadets to experience confusion and disorganization among the group. Assigning tasks and organizing a routine will help reduce confusion during meal preparation. Discuss types of tasks team leaders can assign when organizing the preparation of meals. Have the team leaders identify:

- what concerns they may have if they were supervising junior cadets preparing a meal;
- some of the difficulties junior cadets may face when they prepare a meal; and
- how they would, as a team establish a routine for the junior cadets during meal preparation.

The goal is to have the team leaders realize how they can help as a team and make preparation of meals safe and routine.

During meal preparation team leaders will be required to provide close supervision, and make and monitor a routine with specific tasks to coordinate the preparation of meals. The various aspects of meal preparation and the role of the team leader includes:

**Lighting Stoves.** Red Star cadets may be assigned to light stoves. A stove should be monitored at all times by one person. Team leaders will supervise the fuelling and approve the location for use. When lighting the stove, watch for improper lighting procedures and flare ups. Provide guidance when necessary.

**Boiling Water.** Assign cadets to collect water for boiling. Cadets should have a partner when going near a natural water source. Boiling water is used for drinking and heating IMPs. When boiling water, determine the purpose and adjust the water level per pot. Boiling water requires fuel – water that is boiled but unused wastes fuel.

**Field Stripping (IMPs).** Red Star cadets learned how to field strip IMPs. However, there will be occasions when cadets missed being briefed on how to field strip an IMP. Team leaders should gather cadets in a group and identify the appropriate method to field strip an IMP before consumption.

**Preparing Food.** Meal hours and the preparation of food can be simplified through planning. Team leaders shall assign personnel to specific tasks such as, cook, water gatherer, stove lighter and food distributor. The idea is to make food preparation as organized as possible.

**Coordinating Clean-Up of Garbage.** Follow the “Leave No Trace” principles any time cadets use a site. It is our responsibility to try to leave the site clean with no trace of our presence. Be proactive, identify garbage points for cadets to dispose refuse during meals. Organize a garbage sweep after every meal.

---

## CONFIRMATION OF TEACHING POINT 2

---

### QUESTIONS

- Q1. What tasks could be assigned when establishing a routine for meal preparation?
- Q2. When lighting stoves, what will a team leader do?
- Q3. What should be conducted after a meal has been consumed?

### ANTICIPATED ANSWERS

- A1. The components of meal preparation team leaders will supervise are:
- lighting stoves;
  - boiling water;
  - field stripping IMPs;
  - preparing food; and
  - coordinating clean-up of garbage.
- A2. The team leader will approve the location for use, supervise fuelling and watch for improper lighting procedures.
- A3. A garbage sweep should be conducted after a meal.

---

### Teaching Point 3

### Discuss How a Team Leader Maintains the Bivouac Site

Time: 5 min

Method: Interactive Lecture

---



Bivouac sites become very busy and it takes leadership and supervision from all personnel to ensure the routine runs smoothly. Remind team leaders how they must step forward and be proactive, planning and assigning tasks to establish a routine for the bivouac site.

Bivouac sites present specific challenges to a team leader. While personnel are using resources and creating waste around the site, team leaders have to constantly monitor the site. Team leaders will maintain the bivouac site by:

**Completing Routine Shelter Inspections.** Once shelters have been erected and cadets continue the daily routine, team leaders will have to inspect shelters. Shelters may appear to be erected properly. However, an inspection may reveal problems. Problems could range from strings not attached and tents not securely pegged down, to rips or holes in a tent. Identifying and correcting these problems will avoid bigger problems when they are least desired (at night with no light).

**Tracking and Storing Equipment.** The daily use of a bivouac site depends on the supplies and equipment the unit has brought to the site. Team leaders will be responsible to track the equipment and stores. To track equipment and stores, make a record of the individuals who are in possession of the supplies. Returned equipment will be entered as returned. Review the record daily to identify if any items have gone missing. Notify supervisors if equipment is identified as missing.

**Replenishing Water Sources.** Bivouac sites will either have a natural water source nearby or have a storage reservoir for personnel to use. Natural sources will always be plentiful and will not require replenishing however natural sources should be regularly monitored for contamination. Contamination can come in many forms however most notably are human waste or natural signs such as changes in water colour, dead fish or animals.

Bivouac sites that use a storage vessel for water, must have the water level monitored. If consumption is high, it will be necessary to schedule regular water refill runs. Restricting consumption to conserve water should be avoided unless in an emergency situation that requires water rationing.

**Emptying Garbage Points.** Personnel occupying a bivouac site use materials, consume resources and food rapidly. The waste generated from personnel is disposed of in designated refuse locations. Team leaders must regularly monitor designated refuse locations and empty the receptacles when they are full and replenish the collection points for further use.

---

### CONFIRMATION OF TEACHING POINT 3

---

#### QUESTIONS

- Q1. How does a team leader maintain a bivouac site?
- Q2. How should team leaders track equipment in a bivouac site?
- Q3. Why should a team leader conduct routine shelter inspections?

#### ANTICIPATED ANSWERS

- A1. A team leader maintains a bivouac site by completing routine shelter inspections, tracking and storing equipment and replenishing water sources.
- A2. A team leader can track equipment in a bivouac site by recording issued equipment and reviewing logs of the present equipment status.
- A3. A team leader should conduct routine shelter inspections to look for problems with the set-up or for damage to tents.

---

### END OF LESSON CONFIRMATION

---

#### QUESTIONS

- Q1. What does being a team leader mean when you have to supervise cadets?

- Q2. New cadets participating on a weekend FTX may experience difficulties with daily routine. What areas of daily routine would you expect cadets to experience the most difficulty? What can you as a team leader do to help the new cadets?
- Q3. When meals are being prepared, what should team leaders do to organize and ensure the meal runs smoothly?

### **ANTICIPATED ANSWERS**

- A1. Being a team leader means that I will supervise cadets junior to me by working as a team with peers, providing guidance and knowledge to help junior cadets successfully complete challenges they are presented.
- A2. Answers will vary.
- A3. Team leaders should assign particular roles to cadets to ensure the meal preparation is organized.

---

### **CONCLUSION**

---

### **HOMEWORK/READING/PRACTICE**

N/A.

### **METHOD OF EVALUATION**

N/A.

### **CLOSING STATEMENT**

Cadets who find themselves in a team leader role may experience power of position. This position of authority may lead them to believe they are not required to assist with certain tasks. It is exactly the opposite as they are encouraged to take this role as a position of experience to provide guidance and assistance to junior cadets with the challenges they face. Supervision is not only watching out for problems or concerns of danger but providing knowledge and demonstration skills to others who can learn from this and successfully face the challenges presented to them.

### **INSTRUCTOR NOTES/REMARKS**

The cadet shall participate in the activity and where possible perform the duties of a team leader.

The team leader(s) will be debriefed on their performance as part of PO 303 (Perform the Role of a Team Leader, Chapter 3).

---

### **REFERENCES**

---

N/A.



**ROYAL CANADIAN ARMY CADETS**  
**SILVER STAR**  
**INSTRUCTIONAL GUIDE**



**SECTION 2**

**EO M321.02 – CONSTRUCT COMPONENTS OF A BIVOUAC SITE**

---

Total Time: 90 min

---

**PREPARATION**

---

**PRE-LESSON INSTRUCTIONS**

Resources needed for the delivery of this lesson are listed in the lesson specification located in A-CR-CCP-703/PG-001, Chapter 4. Specific uses for said resources are identified throughout the instructional guide within the TP for which they are required.

Review the lesson content and become familiar with the material prior to delivering the lesson.

Photocopy Annex A for each cadet.

**PRE-LESSON ASSIGNMENT**

N/A.

**APPROACH**

An interactive lecture was chosen for TP 1 to orient the cadets to the construction of a bivouac site.

Demonstration and performance was chosen for TPs 2 and 3 as it allows the instructor to explain and demonstrate constructing components of a bivouac site while providing an opportunity for the cadet to practice the skill under supervision.

---

**INTRODUCTION**

---

**REVIEW**

N/A.

**OBJECTIVES**

By the end of this lesson the cadet shall have constructed the components of a bivouac site.

**IMPORTANCE**

It is important for cadets to know as a team leader how to construct components of a bivouac site because on a weekend bivouac FTX, team leaders will be given small leadership roles to construct specific components of a bivouac site.

**Teaching Point 1****Discuss the Components of a Bivouac Site**

Time: 10 min

Method: Interactive Lecture



Hand out with the sample bivouac site diagram and identify each feature as it is discussed. Cadets should already know components however may need some review.

**COMPONENTS OF A BIVOUAC FEATURES**

There are a variety of components which make up a bivouac site. Each component is characterized by its features, required building materials and location requirements.



Bivouac site components are listed below with a short description of the component followed by a list of required building materials and location requirements.

**Headquarters (HQ).** This feature acts as the central hub of the bivouac site. Most of the administration is conducted here. The HQ is the location of the Officer in Charge (OIC) and supporting staff. Communications and safety equipment may be located here as well.

The HQ can be a designated location or an actual shelter. Commonly the HQ is constructed with modular tentage. The size of the tent can range from one section to many sections depending on the field training exercise (FTX) requirements.

Required Building Materials	Location Requirements
<ul style="list-style-type: none"> <li>• complete section of modular tentage including front and rear panels</li> <li>• grounding stakes</li> <li>• tables</li> <li>• chairs/benches</li> <li>• duty officer station</li> <li>• duty officer cot and sleeping area</li> </ul>	<ul style="list-style-type: none"> <li>• centrally located</li> <li>• flat ground</li> <li>• easily accessible</li> </ul>

**Supply.** The supply is the point where all equipment not in use is held. This location has a designated Quartermaster (senior cadet, supply officer, etc). This feature is often situated close to the HQ or is located within the HQ. It is considered a secure location and is out of bounds to all except designated personnel.



Required Building Materials	Location Requirements
<ul style="list-style-type: none"> <li>• complete section of modular tentage including front and rear panels</li> <li>• grounding stakes</li> <li>• table</li> <li>• chair(s)</li> </ul>	<ul style="list-style-type: none"> <li>• close to the HQ</li> <li>• flat ground</li> </ul>

**First Aid Point.** The first aid point is always placed at the centre of the bivouac site. Depending on the size of the bivouac site it may be reasonable to set up many points to quickly provide access to first aid equipment.



A primary first aid station may be set up to deal with more serious injuries. This location can be inside erected modular tentage and may contain a field first aid kit, spinal board, neck brace, stretcher, wool blankets and a cot.

Materials that make up a first aid point are:

Required Building Materials	Location Requirements
<ul style="list-style-type: none"> <li>• stretcher</li> <li>• emergency first aid kit</li> <li>• fire blanket x 2</li> <li>• spinal board</li> <li>• neck brace</li> <li>• table</li> <li>• chairs</li> </ul>	<ul style="list-style-type: none"> <li>• centre of bivouac site</li> </ul>

**Fire Point.** This feature is used to combat any fires that arise. The fire point, like the first aid point, is a first response point and must be centralized and accessible in an emergency. Fire points should be set up near the sleeping areas, cooking areas, and Petroleum, Oils and Liquids (POL) point. If the bivouac site is large and spread out, additional fire points shall be set up.

The fire point should contain Class A fire extinguishers, with the exception of the POL fire point where a Class B fire extinguisher should be available. Materials that make up a fire point are:

Required Building Materials	Location Requirements
<ul style="list-style-type: none"> <li>• fire broom</li> <li>• shovel</li> <li>• 13.7 L (3 gallon) bucket filled with sand</li> <li>• fire extinguisher</li> <li>• fire point beacon</li> <li>• fire siren</li> </ul>	<ul style="list-style-type: none"> <li>• centralized and easily accessible</li> <li>• more than one may be required</li> </ul>



It is not uncommon to be using areas that require a set amount of fire points with specific fire equipment. Be sure to check with the authority of the property being used.

There may be specific guidelines or regulations that must be followed with regards to fire safety equipment. These regulations are very common on Canadian Forces Bases.



Fire extinguishers labelled to the class of fire they can extinguish. The types of extinguishers are:

<p>Class A, Ordinary Combustibles:</p> <ul style="list-style-type: none"> <li>• trash</li> <li>• wood</li> <li>• paper</li> </ul>	<p>Class B, Flammable Liquids:</p> <ul style="list-style-type: none"> <li>• oils</li> <li>• grease</li> <li>• tar</li> <li>• gasoline</li> <li>• paint thinners</li> </ul>	<p>Class C, Electricity:</p> <ul style="list-style-type: none"> <li>• live electrical equipment</li> </ul>	<p>Class D, Combustible Metals:</p> <ul style="list-style-type: none"> <li>• magnesium</li> <li>• titanium</li> </ul>

**POL Point.** The POL point is a designated area for the storage of fuels, flammable and dangerous liquids. This area is to be clearly marked (white mine tape works well). A drip pan must be present to catch any spills during refuelling. Materials that make up a POL point are:

Required Building Materials	Location Requirements
<ul style="list-style-type: none"> <li>• mine tape</li> <li>• drip pan</li> <li>• marker tape</li> <li>• spill kit</li> <li>• identifying beacon</li> </ul>	<ul style="list-style-type: none"> <li>• 100 m from bivouac site</li> <li>• flat ground</li> <li>• clear and open area</li> <li>• no overhanging branches</li> <li>• minimum 200 m from natural water source</li> </ul>

**In/Out Route for a Safety Vehicle.** The feature is used to control vehicle traffic. It assists in keeping the site safe, and prevents undue wear and tear on the environment. An in/out route sign is all that is required for the materials for this feature.

Required Building Materials	Location Requirements
<ul style="list-style-type: none"> <li>signage</li> </ul>	<ul style="list-style-type: none"> <li>route should not travel through active areas</li> </ul>

**Parking Area.** This area is for parking exercise support vehicles and should be clearly identified. The parking area will be equipped with drip pans that are placed under the engine of every vehicle.

Required Building Materials	Location Requirements
<ul style="list-style-type: none"> <li>drip pans</li> <li>mine tape</li> <li>parking sign</li> </ul>	<ul style="list-style-type: none"> <li>clear area</li> <li>room for additional vehicles to park</li> <li>room to turn a vehicle around</li> </ul>

**Form-Up Point.** This point is a designated large area where personnel will gather when called to muster or during an emergency. Often times it is used for mass briefings. There are no materials required for this area, however it is a place that is verbally identified to the group during the safety briefing.

Required Building Materials	Location Requirements
<ul style="list-style-type: none"> <li>N/A</li> </ul>	<ul style="list-style-type: none"> <li>sheltered/unsheltered clear open area</li> </ul>

**Water Point.** This location is for the storage and drawing of drinking water. It is often placed in a centralized location. This can also be a natural water source. There are no materials required for this area. It is a place that is verbally identified to the group during the safety briefing.

Required Building Materials	Location Requirements
<ul style="list-style-type: none"> <li>water jerry cans</li> </ul>	<ul style="list-style-type: none"> <li>centralized area</li> <li>easily accessible if natural source is used</li> </ul>

**Ablutions Area.** This area is the designated washroom. Bivouac sites will have portable chemical toilets or designated facilities to use. This area will be located downwind at least 60 m (200 feet) away from the sleeping, eating and water areas. There are no materials required for this area, however it is a place that is verbally identified to the entire group upon arriving at the bivouac site.

Required Building Materials	Location Requirements
<ul style="list-style-type: none"> <li>portable chemical toilets or designated facilities</li> </ul>	<ul style="list-style-type: none"> <li>downwind at least 60 m (200 feet) away from sleeping, eating and water areas.</li> </ul>

**Cooking Area.** This area is designated for the preparation of food. The best location is a durable surface such as a flat rock or sandy area. The cooking area should be located no more than 10 m away from the eating area to prevent people from milling around hot stoves and boiling water. This area has no specific required materials to make a cooking site however it is verbally identified to the entire group upon arriving at the bivouac site.

Required Building Materials	Location Requirements
<ul style="list-style-type: none"> <li>N/A</li> </ul>	<ul style="list-style-type: none"> <li>durable surface (flat rock or sandy area)</li> <li>open area, no significant overhanging trees or branches</li> <li>close to the eating area</li> </ul>

**Eating Area.** This is a central point for all foods to be consumed. This will assist in the control of waste and garbage that is a by-product of food consumption, especially in areas with high animal activity. There are no materials required for this area, however it is verbally identified to the group upon arriving at the bivouac site.

Required Building Materials	Location Requirements
<ul style="list-style-type: none"> <li>N/A</li> </ul>	<ul style="list-style-type: none"> <li>sheltered area</li> </ul>

**Garbage Point.** This is the central point for the collection and storage of garbage. It is located away from the main bivouac site and is animal proof (garbage is stored in garbage bins, tree hangs or vehicles). Materials and equipment that make up the garbage point are:

Required Building Materials	Location Requirements
<ul style="list-style-type: none"> <li>garbage cans</li> <li>dumpster</li> <li>garbage hang</li> </ul>	<ul style="list-style-type: none"> <li>100 m (328 feet) away from the bivouac site</li> <li>animal proof</li> </ul>

**Sleeping Areas.** The sleeping areas should be placed upwind of the cooking area, on flat ground. The areas for sleeping will be divided into male and female lines and spread out. Female and male markers can be placed to identify tent location. There are no specific materials required for this area. Sleeping areas are verbally identified to the group upon arriving at the bivouac site.

Required Building Materials	Location Requirements
<ul style="list-style-type: none"> <li>female and male zone identification markers</li> </ul>	<ul style="list-style-type: none"> <li>flat ground</li> <li>clear of major debris</li> <li>female and male separation</li> </ul>

---

### CONFIRMATION OF TEACHING POINT 1

---

#### QUESTIONS

- Q1. What are five components of the bivouac site?
- Q2. Where should a first aid point be set up?
- Q3. What are the location requirements for a POL point?

#### ANTICIPATED ANSWERS

- A1. Any of the following five components will suffice:
- headquarters,

- supply,
- first aid point,
- fire point,
- POL point,
- in/out route for a safety vehicle,
- parking area,
- form-up point,
- water point,
- ablutions area,
- cooking area,
- eating area,
- garbage point, and
- sleeping areas (male and female).

A2. The first aid point is always placed at the centre of the bivouac site.

A3. Location requirements for a POL point are:

- 100 m from bivouac site,
- on a flat surface,
- in a clear and open area,
- no overhanging branches, and
- 200 m from natural water source.

---

### Teaching Point 2

### Explain, Demonstrate and Have the Cadets Establish Components of a Bivouac Site

Time: 15 min

Method: Demonstration and Performance

---



Cadets will be expected to establish specific components of a bivouac site in this lesson.

Explanations and demonstrations may be limited as most cadets will have a working knowledge of each component through their previous experiences on FTXs and from the descriptions in TP1.

Explain and demonstrate where necessary how to establish a component of a bivouac site.

---

### ACTIVITY

---

#### OBJECTIVE

The objective of this activity is to have the cadets establish and mark components of a bivouac site.

## RESOURCES

- Sample bivouac site diagram,
- Mine tape,
- White bristol board,
- Markers,
- Twine, and
- Pocket knife (one per group).

## ACTIVITY LAYOUT

Cadets will be responsible to lay out the components of a bivouac site.

## ACTIVITY INSTRUCTIONS

1. Divide the cadets into groups of no more than five.
2. Assign each group an equal number of bivouac components to establish from the following list:
  - (a) headquarters,
  - (b) supply,
  - (c) first aid point,
  - (d) fire point,
  - (e) POL point,
  - (f) in/out route for a safety vehicle,
  - (g) parking area,
  - (h) form-up point,
  - (i) water point,
  - (j) ablutions area,
  - (k) cooking area,
  - (l) eating area,
  - (m) garbage point, and
  - (n) sleeping areas (male and female).
3. To establish a component of bivouac site, have the cadets label each point using the bristol board and markers.
4. Give the groups a tour of the identified locations.
5. Five minutes will be used for a group tour of the identified locations.
6. Debrief the group about each component.

**SAFETY**

Cadets will be exploring the area that is expected to be the bivouac site. Set boundaries for the cadets to use as the bivouac site.

---

**CONFIRMATION OF TEACHING POINT 2**

---

The cadets participation in the activity will serve as the confirmation of this TP.

**Teaching Point 3****Explain, Demonstrate and Have the Cadets Construct Components of a Bivouac Site**

Time: 60 min

Method: Demonstration and Performance



Cadets will be expected to construct specific components of a bivouac site in this lesson.

Most cadets will have a working knowledge of each component through their previous experiences on FTXs.

Explain and demonstrate how to construct each component where necessary.

The set-up of a modular section may be the most difficult task to the cadets.

Take 20 minutes and demonstrate how to set up a modular section.

---

**ACTIVITY**

---

**OBJECTIVE**

The objective of this activity is to have the cadets construct specific components of a bivouac site.

**RESOURCES**

Resources for the following bivouac site components are listed in TP1:

- headquarters,
- supply,
- first aid point,
- fire point, and
- POL point.

**ACTIVITY LAYOUT**

Cadets will be required to physically construct the following components:

- headquarters,
- supply,
- first aid point,
- fire point, and

- POL point.

In the last activity, each component should have been previously assigned a position within the bivouac site. Cadets will position their component at its designated location.

### **ACTIVITY INSTRUCTIONS**

1. Divide the cadets into equal groups of no more than five.
2. Give a 20 minute demonstration on how to set up a section of modular tent.
3. Assign each group one component to construct.
4. Give each group 30 minutes to construct their component.
5. Ten minutes will be used for a group tour of the constructed components.
6. Debrief the group about each component.

### **SAFETY**

---

#### **CONFIRMATION OF TEACHING POINT 3**

---

The cadets participation in the activity will serve as the confirmation of this TP.

---

#### **END OF LESSON CONFIRMATION**

---

The cadets participation in constructing components of a bivouac site will serve as the confirmation of this lesson.

---

#### **CONCLUSION**

---

### **HOMEWORK/READING/PRACTICE**

N/A.

### **METHOD OF EVALUATION**

N/A.

### **CLOSING STATEMENT**

Team leaders who have been assigned to construct components of a bivouac site will be expected to have knowledge of a bivouac site layout and its components. Practicing how to situate the appropriate bivouac site component will prepare team leaders to lead a group of junior cadets in a similar task.

### **INSTRUCTOR NOTES/REMARKS**

Additional instructors may be required to assist the construction of each bivouac component in TP 3.

The cadet shall participate in the activity and where possible perform the duties of a team leader.

The team leader(s) will be debriefed on their performance where applicable as part of PO 303 (Perform the Role of a Team Leader, Chapter 3).



---

**REFERENCES**

---

A2-036 A-CR-CCP-121/PT-001 Director Cadets 3. (2000). *Royal Canadian Army Cadet Reference Book*. Ottawa, ON: Department of National Defence.

THIS PAGE INTENTIONALLY LEFT BLANK



**ROYAL CANADIAN ARMY CADETS**  
**SILVER STAR**  
**INSTRUCTIONAL GUIDE**



**SECTION 3**

**EO C321.01 – IDENTIFY METHODS OF WASTE DISPOSAL IN THE FIELD**

---

Total Time: 30 min

---

**PREPARATION**

---

**PRE-LESSON INSTRUCTIONS**

Resources needed for the delivery of this lesson are listed in the lesson specification located in A-CR-CCP-703/PG-001, Chapter 4. Specific uses for said resources are identified throughout the instructional guide within the TP for which they are required.

Review the lesson content and become familiar with the material prior to delivering the lesson.

Make slides or handouts of Figures 12-3-6 to 12-3-8.

Choose an area in which each pair of cadets can find alternative sources of toilet paper.

**PRE-LESSON ASSIGNMENT**

N/A.

**APPROACH**

An interactive lecture was chosen for TPs 1 and 2 as it allows the instructor to present background information about field hygiene and environmentally conscious waste disposal.

A practical activity was chosen for TP 3 as it is an interactive way to introduce the cadets to natural materials in the field that can be used in place of toilet paper.

---

**INTRODUCTION**

---

**REVIEW**

N/A.

**OBJECTIVES**

By the end of this lesson the cadet shall have identified methods of waste disposal in the field.

**IMPORTANCE**

It is important for cadets to understand how to safely dispose of waste in the field as wilderness areas are increasingly more populated and traditional waste disposal methods are being regarded as detrimental to the environment.

**Teaching Point 1****Discuss Field Hygiene**

Time: 5 min

Method: Interactive Lecture



By emphasizing these points, the cadets will understand the importance of individual hygiene in the field. Human waste is the most frequent conveyor of intestinal diseases.

**PRACTICING THE BASIC RULES OF HYGIENE****Change Clothes Regularly**

It is important to keep all clothing, especially undergarments and socks, as clean and dry as possible. Clothing, as well as the body, must stay clean and dry. Keeping clothes clean will lessen the chances of developing rashes and infections. Change clothes, especially socks and undergarments, regularly. Use foot powder when available.

**Properly Dispose of Waste Water**

There will always be a quantity of waste water from personal bathing and cooking in the field. Proper disposal of waste water will assist in preventing insect infestation.

Follow these steps to properly dispose of waste water:

1. Collect all large particles with a food strainer or cloth and place in the garbage.
2. Place the remaining waste water in a container.
3. Dig a small hole at least 60 m away from any water source.
4. Pour the waste water in the hole.
5. Fill in the hole with natural materials.

**Wash Regularly**

In order to minimize the spread of diseases, hand washing should be enforced when in the field. There are two common approaches to hand washing – soap and water and hand sanitizers.

It is important to always keep the hands clean. Although hand washing is preferred, having hand sanitizer is convenient when soap and water are not available. Dispose of all waste water.

Washing the body is very important and should be done daily. Pay special attention to areas of the body that are susceptible to rash and fungus infection (the scalp, the crotch, and between the toes).



All waste disposal (including human waste) should be a minimum of 60 m (200 feet) from water sources.

**DIARRHEA**

There are many ways one can develop diarrhea: viral or bacterial infection, contaminated food, food allergies, and soap in food.

While in the field, the major concern is how quickly diarrhea increases water loss.

### **Diarrhea Which Requires Evacuation**

Conditions that will require evacuation include:

- fever,
- presence of blood,
- shock,
- diarrhea or vomiting lasting longer than 24 hours,
- pain lasting longer than 24 hours, and
- any abdominal pain.

### **Treatment for Diarrhea**

The simplest treatment for diarrhea is:

1. Replace lost fluids orally with clear liquids. Encourage patient to drink slowly in small sips. If fluids are not replenished in this way, further dehydration will occur.
2. Once clear liquids are accepted, move the patient to simple carbohydrates: bread, rice and toast (BRAT).
3. Continue giving fluids. Tea may be included.
4. Slowly move back to normal diet, and continue giving fluids.

### **WATER PATHOGENS**

Water pathogens are micro-organisms living in water that are capable of causing human disease. They can be classified into three types: bacteria, viruses, and protozoan parasites.

Although bacteria are a natural part of life, some bacteria (particularly in water) lead to serious illness such as giardiasis or cryptosporidiosis.

Viruses and protozoa are found in surface water that has been contaminated by animal or human feces.



It is crucial to filter and/or purify all water in the wilderness.

---

### **CONFIRMATION OF TEACHING POINT 1**

---

#### **QUESTIONS**

- Q1. What are the basic rules of hygiene?
- Q2. How is diarrhea contracted?
- Q3. What are water pathogens?

#### **ANTICIPATED ANSWERS**

- A1. The basic rules of hygiene are:
  - change clothes regularly;

- properly dispose of waste water; and
- wash regularly.

A2. Diarrhea may develop through viral or bacterial infection, contaminated food, food allergies, and soap in food.

A3. Water pathogens are micro-organisms that can cause human disease.

---

**Teaching Point 2**

**Discuss Latrine Selection**

Time: 10 min

Method: Interactive Lecture

---



This TP is intended to familiarize cadets with the topic of outdoor toilets, and generate interest in using accepted forms.

**SURFACE DISPOSAL**

Surface disposal is the least accepted form of waste disposal in the wilderness. Surface disposal should be avoided at all costs. When training, cadets will be informed of the acceptable form of disposal.

**CATHOLES**

Catholes are the most acceptable form of waste disposal other than packing the waste out. Catholes should be located at least 60 m (200 feet) away from any water source, campsite or trail. The cathole should be 10–20 cm (4–8 inches) deep and approximately 10–15 cm (4–6 inches) in diameter. The most suitable area for a cathole would be in organic soil rich in micro-organisms in a moist area that still receives a fair amount of sunlight.

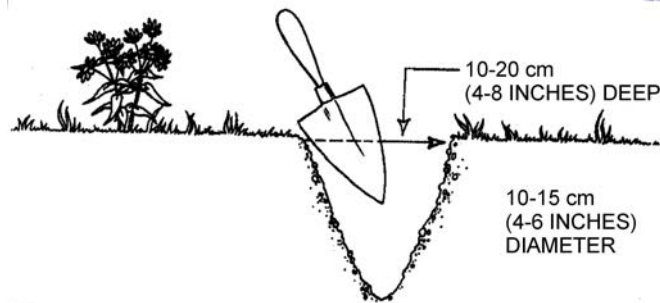

A. McGivney, *Leave No Trace: A Guide to the New Wilderness Etiquette*, Mountaineer Books. (p. 64)

Figure 12-3-1 Cathole



Demonstrate cathole digging.

**LATRINES**

Considered a multi-person cathole, latrines should only be built when occupying a site longer than two nights or when there are more than 10 people in a group.

Latrines should be a minimum of 60 m (200 feet) away from a water source, campsite, or trail. They should be wider than long and a minimum of 30 cm (1 foot) deep. Latrines should be filled in when the waste is 10–15 cm (4–6 inches) from the surface.



Human waste can take 1–3 years to decompose. Be aware of where waste is deposited.

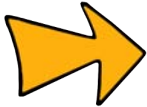

Human urine may cause leaf damage and browning on some plants. In addition, certain animals are attracted to the salt in human urine, often eating covered plants.

## WILDERNESS TOILETS

### Outhouses

In order to prevent the spread of disease, many provincial and national parks are building new outhouses with sustainable technology. Older outhouses in parks should be used whenever available, despite their sometimes undesirable appearance.



*<http://blogs.redding.com/redding/mbeauchamp/archives.gif>. Retrieved March 18, 2008, from <http://blogs.redding.com/redding/mbeauchamp/archives.gif>*

Figure 12-3-2 Outhouse

### Thunder Boxes

Often simply a box with a hole and seat, thunder boxes can be found in wilderness areas. Thunder boxes are built by earth-conscious hikers and area users to prevent human waste from littering the ground.



*barkingspace.wordpress.com. Retrieved March 18, 2008, from <http://www.figtography.com/Blog/thunderbox.jpg>*

Figure 12-3-3 Thunder Box

### **Ammo Cans**

Traditionally used by paddlers and river guides in wilderness where regulations require the removal of human waste, ammo cans, sometimes called groovers, are water tight and sealed. Ammo cans are particularly useful on water as the can is very durable and floats.



*Surplus & Outdoors. Retrieved March 18, 2007, from <http://www.surplusandoutdoors.com/shop/877/shopscr89.html>*

Figure 12-3-4 Ammo Can

### **Buckets**

In areas above the tree line, mountaineers often use large plastic buckets as toilets. The buckets are sometimes lined with a garbage bag while in use. When the trip is done, or when the bucket is full, the bag is tied off and the bucket is carried back down, and subsequently dumped in the proper facilities.



## COMMERCIAL WASTE UNITS

### Composting Toilets

The most popular commercial unit on the market, a composting toilet, comes in various models and can be seen in most provincial and national parks within Canada. The simplest forms of composting toilets use sawdust or mulch which is then placed over a deposit.

### Pack-It Toilet

Marketed as an ultra light personal toilet kit, the Pack-it Toilet was developed as a way to try to help the wilderness. People invariably do not want to waste time with packing out waste. With the Pack-it Toilet, people can take responsibility for their waste in a comfortable way.

## CONFIRMATION OF TEACHING POINT 2

### QUESTIONS

- Q1. What is the most acceptable form of waste disposal?
- Q2. When are latrines used?
- Q3. What is a composting toilet?

### ANTICIPATED ANSWERS

- A1. Catholes.
- A2. Latrines should only be built when occupying a site longer than two nights or when there are more than 10 people in a group.
- A3. Composting toilets use sawdust or mulch which is then placed over a deposit.

### Teaching Point 3

### Select Natural Toilet Paper

Time: 10 min

Method: Practical Activity



This TP is designed to give cadets the opportunity to select alternatives to toilet paper.

Cadets should be reminded that they do not need to remove sources from live trees or bushes.

There was once a time when there was no toilet paper. During this time, and in today's world during times of potty emergencies, natural toilet paper can be used.



With all the choices for substitute toilet paper, the choice of living plants should be a last resort. Pick a leaf here, a leaf there; do not pick clumps.

Do not pick vegetation or leaves in parks or restricted areas.

### LEAVES

Large, soft leaves are the best. If needed, small leaves can be used. Use sparingly.

Inspect the leaves before using. Leaves can sometimes hold sap or other sticky substances, be covered in bristles or barbs, or more seriously be covered in hispid (short stiff hairs) which can penetrate the skin.

Autumn foliage, in many colours, offers a selection of leaves, some of which will stay pliable through the winter months.

The most common trees and source of leaves in Canada are:

- alder,
- beech,
- birch,
- chestnut,
- elm,
- hickory,
- maple, and
- oak.



*Natural Resources Canada, 2002, Round Leaves. Retrieved March 22, 2007, from [http://www.cfi.scf.mcan.gc.ca/imfec-idecf/hosttrees/deciduous/leaves\\_round.html](http://www.cfi.scf.mcan.gc.ca/imfec-idecf/hosttrees/deciduous/leaves_round.html)*

Figure 12-3-5 Round Leaf



Review photos of poison ivy, poison oak, and poison sumac with cadets.



Poison ivy, poison oak, and poison sumac are not to be used for alternative sources for toilet paper.



*Canadian Weed Science Society. Retrieved March 18, 2008, from [www.cwss-scm.ca/weeds/images/F22\\_centralPoisonIvy.jpg](http://www.cwss-scm.ca/weeds/images/F22_centralPoisonIvy.jpg)*

Figure 12-3-6 Poison Ivy



*Agriculture and Agri-Food Canada. Retrieved March 18, 2008, from [http://res2.agr.gc.ca/ecorc/poison/vernix\\_e.htm](http://res2.agr.gc.ca/ecorc/poison/vernix_e.htm)*

Figure 12-3-7 Poison Sumac



*The Coloma Valley: Where the Gold Rush Began: Coloma Valley Nature Reference. Retrieved March 18, 2008, from [www.coloma.com/reference/401-1-18-poisonoak.jpg](http://www.coloma.com/reference/401-1-18-poisonoak.jpg)*

Figure 12-3-8 Poison Oak

## **MOSS**

Using moss has both advantages and disadvantages. The advantage with moss is the softness, but the disadvantage is that removing a small amount of moss will affect a large area of moss.

## **GRASSES**

Grasses will work well, but can be a hazard due to slicing leaves. Grasses can cut skin similar to a paper cut. If using bamboo, be extra careful to avoid such injuries.

## **EVERGREENS**

These have leaves that look like needles. Coniferous trees generally have persistent foliage (leaves) consisting of needles or scales. Found in certain areas, evergreens are often the only choice. Be sure to inspect the greens for sap before using.

The most common coniferous trees in Canada are:

- cedar,
- fir,
- hemlock,
- larch,
- pine,
- spruce, and
- tamarack.



*The Canadian Encyclopedia, 2007, Conifers, Copyright 2007 by Alberta Forest Service. Retrieved March 22, 2007, from <http://www.thecanadianencyclopedia.com/index.cfm?PgNm=TCE&Params=A1SEC818695>*

Figure 12-3-9 Coniferous Needles

## WATER

Regarded by some as the cleanest, water wiping has been practiced for years.

**The Water Wipe.** Using a small container, fill it with water. Bring the container to the chosen spot. When finished, simply trickle water into the free hand, never contaminating the fresh water, and use it to splash or wipe.

Snow is also an excellent alternative to toilet paper. There is an initial shock towards the feeling of the snow on the area, but will leave the area clean.



In certain countries, it is customary to wipe only with the left hand and eat with the right hand.

---

## ACTIVITY

Time: 5 min

### OBJECTIVE

The objective of this activity is to allow cadets to identify what natural materials may be used as a substitute for toilet paper.

### RESOURCES

N/A.

### ACTIVITY LAYOUT

Choose an area in which each pair of cadets can find alternative sources of toilet paper.

### ACTIVITY INSTRUCTIONS

1. Divide the cadets into pairs (same gender).

2. Inform cadets of the boundaries.
3. Have cadets identify natural sources of toilet paper.
4. Cadets should check the source to ensure:
  - (a) there are no sticky substances attached to the source;
  - (b) there are no insects; and
  - (c) the source is appropriate.

### **SAFETY**

- Cadets will respect boundaries for the activity.
- Cadets will remain within eyesight of their partner at all times.

---

### **CONFIRMATION OF TEACHING POINT 3**

---

The cadets participation in the activity in TP 3 will serve as the confirmation of this TP.

---

### **END OF LESSON CONFIRMATION**

---

The cadet's participation in identifying natural sources of toilet paper will serve as the confirmation of this lesson.

---

### **CONCLUSION**

---

### **HOMEWORK/READING/PRACTICE**

N/A.

### **METHOD OF EVALUATION**

N/A.

### **CLOSING STATEMENT**

Properly disposing of waste in the field is essential to personal hygiene, preventing illness and protecting the wilderness setting we all enjoy.

### **INSTRUCTOR NOTES/REMARKS**

N/A.

---

### **REFERENCES**

---

- A2-063 A-CR-CCP-107/PT-001 Director Cadets 3. (1978). *Royal Canadian Army Cadet Course Training Plan: Corps Training Program Adventure Training*. Ottawa, ON: Department of National Defence.
- C0-111 (ISBN 0-9740820-2-3) Tawrell, P. (2006). *Camping and Wilderness Survival: The Ultimate Outdoors Book* (2<sup>nd</sup> ed.). Lebanon, NH: Paul Tawrell.
- C2-011 (ISBN 0-89886-910-2) McGiveny, A. (2003). *Leave No Trace: A Guide to the New Wilderness Etiquette* (2<sup>nd</sup> ed.). Seattle, WA: Mountaineer Books.

- C2-016 (ISBN 1-4000-5309-9) Curtis, R. (2005). *The Backpacker's Field Manual: A Comprehensive Guide to Mastering Backcountry Skills*. New York, NY: Three Rivers Press.
- C2-156 (ISBN 0-89815-627-0) Meyer, K. (1994). *How to Shit in the Woods*. Berkeley, CA: Ten Speed Press.

THIS PAGE INTENTIONALLY LEFT BLANK





**ROYAL CANADIAN ARMY CADETS**  
**SILVER STAR**  
**INSTRUCTIONAL GUIDE**



**SECTION 4**

**EO C321.02 – IDENTIFY SAFETY CONSIDERATIONS WHEN TRAVELLING OVER SNOW AND ICE**

---

Total Time: 60 min

---

**PREPARATION**

---

**PRE-LESSON INSTRUCTIONS**

Resources needed for the delivery of this lesson are listed in the lesson specification located in A-CR-CCP-703/PG-001, Chapter 4. Specific uses for said resources are identified throughout the instructional guide within the TP for which they are required.

Review the lesson content and become familiar with the material prior to delivering the lesson.

**PRE-LESSON ASSIGNMENT**

N/A.

**APPROACH**

An interactive lecture was chosen for this lesson, as it introduces travelling over snow and ice and generates interest in being outside in the winter.

---

**INTRODUCTION**

---

**REVIEW**

N/A.

**OBJECTIVES**

By the end of this lesson the cadet shall have identified safety considerations when travelling over snow and ice.

**IMPORTANCE**

It is important for cadets to understand the safety implications when travelling over snow and ice in order to remain safe when on a winter FTX or while enjoying winter sports.

**Teaching Point 1****Describe Types of Snow and Ice**

Time: 20 min

Method: Interactive Lecture



Snow and ice change with heating and cooling, and are largely affected by weather. This TP is intended to introduce cadets to the different types of snow and ice.

**SNOW**

**Snow.** A type of precipitation in the form of crystalline water ice (snowflake). Snow is granular with an open soft structure and will remain on the ground until it melts into water.

**Snow Pack.** The accumulation of snow in an area.

**TYPES OF SNOW**

**New Fallen Snow.** Very loose and light. The snowflakes still have their multiple branches. This type of snow is excellent insulation.

**Powder Snow.** New, untouched freshly fallen soft snow. It can give the feeling of floating in a weightless environment. Powder can be packed in thick layers that form a natural pillow. Powder snow has low moisture content almost 97 percent of it being air and is favoured among skiers to perfect skills. In coastal regions, where there is higher humidity, the snow is heavier than in a continental region.

**Wind-Packed Snow.** Snow blown from one direction, compacted by the force of the wind. Wind packed snow is caused by the pressure exerted by wind causing a form of cold-heat hardening. In some areas, the snow surface is strong enough to hold weight and snowshoes are particularly useful.



Wind-packed snow is great for cutting blocks for igloos and other snow structures.

**Sun Crust.** Snow that had the upper layer melted and then refrozen. Usually on top of powder snow, sun crust snow is stronger than the powder snow below it due to the refreezing.

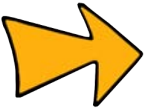

Sun crust is not very stable on a slope and can be dangerous when weighted.

**Corn Snow.** After thawing, corn snow occurs. The structure of the snow is very grainy at this point. Corn snow usually occurs in the spring, and can be strong enough to carry weight. Corn snow is produced during the cycle of melting and refreezing in the accumulated snow.

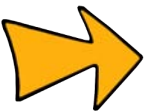

A layer of snow that has been sun crusted will become corn snow.

**Rotten Snow.** Caused by repeat melting and freezing and is found mostly on the south side of hills, or in lower levels of snow. Water will seep to the lower layers and will not freeze because it is insulated from the weather

by the covering snow layer. Rotten snow can resemble very small icicles, or candle ice. This snow is dangerous due to a risk of falling through.

**Slush Snow.** When the air temperature becomes warmer than the freezing point, the snow begins to melt and the water content becomes high. Slush snow absorbs water from melting snow. Slush snow is recognizable by depressions in the snow with darker or bluish snow areas. These areas show holes in the ice or an accumulation of water on the surface of the ice.

## ICE

As water cools, it contracts in volume, reaching greatest density at 4 degrees Celsius (39 degrees Fahrenheit) where it begins the freezing process. Ice is a densely packed material formed from snow without air bubbles, or a crystalline solid which is brittle and transparent.

Ice can be frozen water or cold-heat packed snow like that of glaciers and icebergs.

## TYPES OF ICE

**Surface Ice.** Found on land, over different surfaces, including man-made materials.

**Candle Ice.** Suspended vertical needles of ice that do not have a solid structure. Stepping on candle ice is like stepping on slush.

**Lake Ice.** The layer of frozen water that forms on the surface of the lake. Often the ice strength is dependent upon the conditions under which it was formed.



Lake ice 10 cm (4 inches) in thickness is generally considered safe to walk on. However, caution should always be used, as this is still dependent on the type of ice, how it was formed and how many layers there are. Ice thickness can also change depending on where one is on the lake, this is especially true where water is running into the lake, eg, from a stream, river, or man made discharge.

---

## CONFIRMATION OF TEACHING POINT 1

---

### QUESTIONS

- Q1. What is rotten snow?
- Q2. What is the best snow for building snow structures?
- Q3. What are the three kinds of ice?

### ANTICIPATED ANSWERS

- A1. Rotten snow is snow found on the south side of hills, or lower levels of snow. It is caused by repeated melting and freezing.
- A2. Wind packed snow.
- A3. Surface ice, candle ice and lake ice.

---

**Teaching Point 2****Discuss Characteristics of Snow and Ice**

Time: 5 min

Method: Interactive Lecture

---

**CHARACTERISTICS OF SNOW AND ICE****Weight-Carrying Capacity**

Weight-carrying capacity is defined as the capacity of weight that can be supported by the snow. When the snow is packed hard, weight-carrying capacity is greater and movement is easier. Ice is often stronger, but movement is more difficult due to the slippery surface.

**Sliding Characteristics**

Important to skiers and snowboarders, sliding characteristics are how a material glides over the snow. The sliding characteristic varies greatly due to the type of snow.

**Holding Capacity**

Holding capacity is the ability to act upon ski wax to avoid backslapping. Backslapping is when the ski does not slide on the snow, but lifts from the snow causing a slapping noise. Holding capacity changes greatly with different types of snow, making different versions of wax a necessity.

---

**CONFIRMATION OF TEACHING POINT 2**

---

**QUESTIONS**

- Q1. What is weight-carrying capacity?
- Q2. Explain sliding characteristics.
- Q3. Define holding capacity.

**ANTICIPATED ANSWERS**

- A1. Weight-carrying capacity is defined as the capacity of weight that can be supported by the snow.
- A2. Sliding characteristics are how a material glides over snow.
- A3. Holding capacity is the ability to act upon ski wax to avoid backslapping.

---

**Teaching Point 3****Discuss Water Dangers**

Time: 10 min

Method: Interactive Lecture

---



This TP is designed to introduce cadets to the dangers of travelling over ice and snow in winter. This introduction does not provide cadets with skills or training to effectively select a route for a group.

**WATER DANGERS**

In the winter, hiking can be enjoyable, but like all outdoor activities there are dangers that need to be considered.

### Frozen Waterway Travel

Frozen bodies of water including lakes, rivers and creeks are the most suitable routes for trails. Frozen waterway travel is an advantage as they are relatively flat and have little snow accumulation due to blowing wind.

The primary disadvantage of travelling on waterways is that the route can become unstable with sudden temperature changes.

### Ice Route Selection

When travelling on ice, the most experienced person in the group should select the travel route.

Ice conditions can change quickly and should always be treated with suspicion, as there may be water under the snow surface (rotten snow). Areas where rotten snow is found should be bypassed.

Rivers with a stronger current will continue to flow below the ice cover even through the coldest temperatures.

### Weak Ice

The strength of the ice varies with its structure and temperature. Snow cover or a warm period will weaken the ice. A sudden thaw can create cracks in the ice and weaken it more.



Weak ice should be avoided at all times.

---

### CONFIRMATION OF TEACHING POINT 3

---

### QUESTIONS

- Q1. What is the primary disadvantage when travelling over frozen waterways?
- Q2. What should be remembered when travelling on an ice route?
- Q3. When should weak ice be avoided?

### ANTICIPATED ANSWERS

- A1. The route may become unstable.
- A2. There could be flowing water under the surface.
- A3. Weak ice should be avoided at all times.

---

### Teaching Point 4

Time: 20 min

### Discuss Winter Travel

Method: Interactive Lecture

---



This TP is designed to introduce cadets to the dangers to consider when travelling in winter conditions.

Instructors should present the information emphasizing the importance of safe travel.

## **WINTER TRAVEL**

Winter travel is more complicated and more difficult than summer travel. Snow pack affects mobility in a variety of ways, and winter requires cold weather equipment.

Planning for the cold and preparing for a winter trip does not just mean planning for what will happen. It is important to pack extra equipment (eg, an extra pair of socks, emergency blanket, or fire starter) that will be beneficial should something unexpected arise.

Heavy snow cover impedes movement, both cross-country and on road. A route which was passable during the day may become impassable at night due to falling temperatures re-freezing the surroundings.

### **Basic Rules for Winter Travel**

There are some basic rules everyone travelling outdoors in the winter should follow:

- Plot the route on a map and highlight key landmarks.
- Ensure all members of the group are fully prepared and aware of the route and possible difficulties.
- Have a trail breaking rotation so the lead person does not get tired.
- Travel in single file.
- Ensure equipment is checked and evenly distributed.
- Dress consistent with the weather to reduce sweating.
- Stop 15 minutes into the hike to adjust equipment.
- Use the buddy system in northern climates.
- Watch carefully for signs of frostbite.

### **Use of Snowshoes or Skis**

Snowshoes and skis both provide floatation (ability to stay on the top layer) on snow. They are often useful for cross-country travel and have gained popularity with those travelling in winter. Depth and type of snow will determine the level of support and the speed of movement.

Snowshoes are particularly useful in confined areas. Carrying and transporting snowshoes is simple due to their size and weight. On steep slopes however, snowshoes have limited traction and the snowshoe will often slide, causing the wearer to lose their footing.

Skiing is often harder in deeper snow, and the trail breaker must be switched often. Skiing is versatile in most terrains, particularly in areas with hills as skiers are able to gain speed on the downward slope.

## WINTER TRAVEL TIME

	Unbroken Trail	Broken Trail
On Foot:		
• Up to 1 foot of snow	1–2 mph	1.5–2 mph
• Over 1 foot of snow	0.24–0.75 mph	1.25–2 mph
Snowshoeing	1–2 mph	2–2.5 mph
Skiing	1–3.5 mph	3–3.5 mph

### Tripping and Falling in the Snow

Snow cover blankets many terrain features and hides obstacles, such as stumps, brush, rocks, and ditches, that may cause tripping and falling.

A long pole or hiking stick should be carried and used to find obstacles. Any obstacles, including the smallest ones, should be avoided to prevent injury.

### Best Time to Travel

In winter, travel time will vary from hour to hour. Generally the best time to travel is early in the morning after a cold night. This is when snow and ice are most stable.

Some travel guidelines include:

- Travel in shaded areas to avoid disturbing the stability of the snow in sunny spots.
- Days are shorter in winter, so timings should be adjusted to avoid overnight stays in dangerous areas.
- Avoid travel in snow higher than calf deep. Travelling in deep snow wastes energy and it is very difficult to see potential obstacles.
- Travelling in late winter should be given special consideration as the snow pack may be more unstable because of the warmer temperatures.

### Trail Selection

Forest travel provides protection from wind. It is particularly important to plan routes in the winter to ensure a safe and protected route is followed. Special attention should be given to trail markings and signs.

### Dangers of Winter Travel

Winter travel is more difficult than summer travel, and snow conditions will dictate when and how far a group moves.

Deep snow could hide trail markers and be prone to avalanches and ice patches.



If travelling in mountain areas, an avalanche course should be completed and the necessary equipment, such as an avalanche beacon, should be taken on all trips.

---

## CONFIRMATION OF TEACHING POINT 4

---

### QUESTIONS

- Q1. What is the purpose of snowshoes?
- Q2. When is the best time of day to travel in winter?
- Q3. What are the basic rules for winter travel?

### ANTICIPATED ANSWERS

- A1. Snowshoes provide floatation (ability to stay on the top layer of snow) in the snow.
- A2. Early in the morning after a cold night is the best time to travel.
- A3. The basic rules of winter travel are:
- Plot the route on a map and highlight key landmarks.
  - Ensure all members of the group are fully prepared and aware of the route and possible difficulties.
  - Have a trail breaking rotation so the lead person does not get overly tired.
  - Travel in single file.
  - Ensure equipment is checked and evenly distributed.
  - Dress consistent with the weather to reduce sweating.
  - Stop 15 minutes into hike to adjust equipment.
  - Use the buddy system in northern climates.
  - Watch carefully for signs of frostbite.

---

## END OF LESSON CONFIRMATION

---

### QUESTIONS

- Q1. What is powder snow?
- Q2. What are the considerations for ice route selection?
- Q3. What causes falling or tripping in the snow?

### ANTICIPATED ANSWERS

- A1. Powder is new, untouched freshly fallen soft snow.
- A2. Ice conditions can change easily and should always be treated with suspicion, as there may be water under the snow surface. Areas where rotten snow is found should be bypassed.
- A3. Snow cover blankets many terrain features and hides obstacles to movement. Stumps, brush, rocks, ditches are all covered, obscuring potential obstacles.



---

**CONCLUSION**

---

**HOMEWORK/READING/PRACTICE**

N/A.

**METHOD OF EVALUATION**

N/A.

**CLOSING STATEMENT**

Travelling on snow and ice can be hazardous to both personnel and equipment. Knowing the different types of snow and ice as well as the dangers inherent with winter travel, will assist cadets in making decisions on winter travel.

**INSTRUCTOR NOTES/REMARKS**

N/A.

---

**REFERENCES**

---

- C2-004 (ISBN 1-896713-00-9) Tawrell, P. (1996). *Camping and Wilderness Survival: The Ultimate Outdoors Book*. Green Valley, ON: Paul Tawrell.
- C2-012 (ISBN 0-89886-643-X) Weiss, H. (1988). *Secrets of Warmth for Comfort or Survival*. Seattle, WA: The Mountaineers.

THIS PAGE INTENTIONALLY LEFT BLANK



**ROYAL CANADIAN ARMY CADETS**  
**SILVER STAR**  
**INSTRUCTIONAL GUIDE**



**SECTION 5**

**EO C321.03 – CONSTRUCT FIELD AMENITIES**

---

Total Time:	180 min
-------------	---------

---

**PREPARATION**

---

**PRE-LESSON INSTRUCTIONS**

Resources needed for the delivery of this lesson are listed in the lesson specification located in A-CR-CCP-703/PG-001, Chapter 4. Specific uses for said resources are identified throughout the instructional guide within the TP for which they are required.

Review the lesson content and become familiar with the material prior to delivering the lesson.

**PRE-LESSON ASSIGNMENT**

Photocopy handouts of field amenities located at Annex B. Each cadet should have a copy of each field amenity.

A selection of sticks, boughs and logs in different sizes should be gathered in order to aid cadets in construction and to prevent using live boughs.

**APPROACH**

Demonstration and performance was chosen for TP 1 as it allows the instructor to explain and demonstrate knots and lashings while providing an opportunity for the cadets to practice tying knots and lashings under supervision.

A practical activity was chosen for TP 2 as it is an interactive way to allow the cadet to experience building field amenities in a safe, controlled environment. This activity contributes to the development of building skills in a fun and challenging setting.

---

**INTRODUCTION**

---

**REVIEW**

N/A.

**OBJECTIVES**

By the end of this lesson the cadet, as a member of a group of four, shall have constructed two field amenities.

**IMPORTANCE**

It is important for cadets to understand the value of field amenities. Constructing field amenities is a fun way to incorporate knot tying in the field training site and make the site more comfortable. If ever in a survival situation, field amenities are also a way to combat boredom which is one of the seven enemies of survival.

---

**Teaching Point 1**

**Explain, Demonstrate and Have the Cadets Practice Tying Lashings**

Time: 45 min

Method: Demonstration and Performance

---



For this skill lesson it is recommended that instruction take the following format:

1. Explain and demonstrate the complete skill while cadets observe.
2. Explain and demonstrate each step required to complete the skill. Monitor cadets as they imitate each step.
3. Monitor the cadets' performance as they practice the complete skill.

**Note:** Assistant instructors may be employed to monitor cadet performance.

**ROUND LASHING**

Also called a sheer lashing, the round lashing has two distinct uses. First, it creates an A-frame or set of sheer legs. Second, two or three round lashings can be used to bind poles together to make a longer horizontal pole.

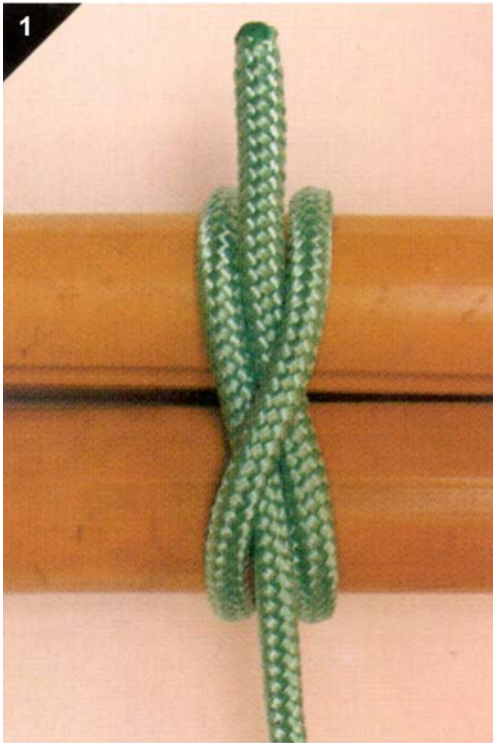

**STEP ONE.** MAKE A CLOVE HITCH AROUND BOTH POLES.

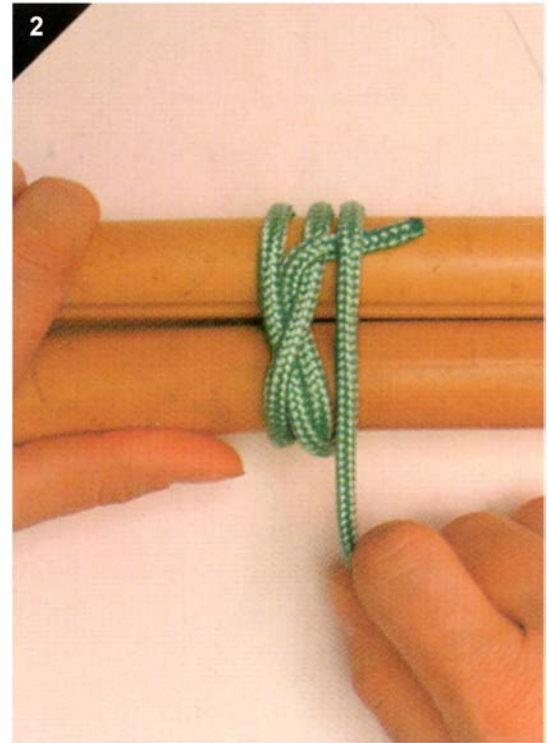

**STEP TWO.** WRAP THE STANDING END AROUND BOTH POLES, TRAPPING THE WORKING END OF THE CLOVE HITCH UNDERNEATH.

*D. Pawson, Pocket Guide to Knots & Splices, Chartwell Books, Inc. (p. 184–185)*

Figure 12-5-1 (Sheet 1 of 3) Round Lashing

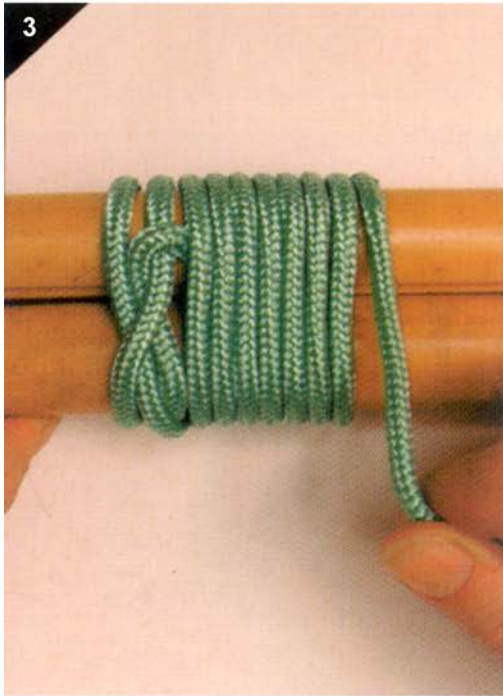

**STEP THREE.** MAKE EIGHT TO TEN MORE WRAPS AROUND THE POLES.

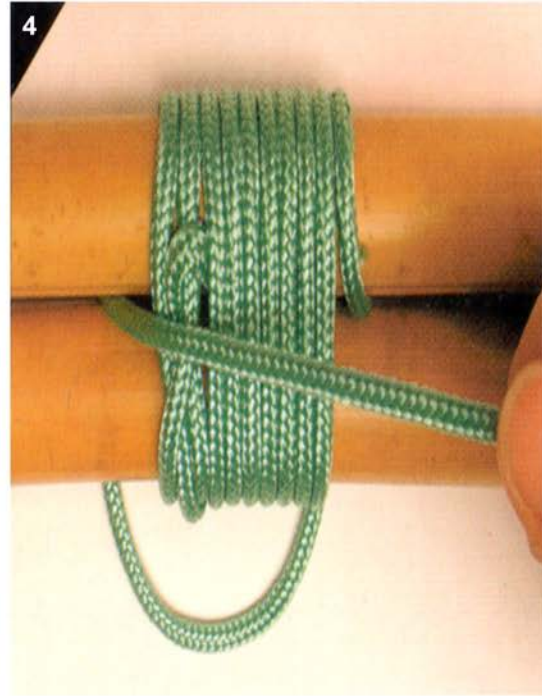

**STEP FOUR.** BRING THE ROPE UP BETWEEN THE POLES AND MAKE TWO TIGHT TURNS PARALLEL TO THE POLES.

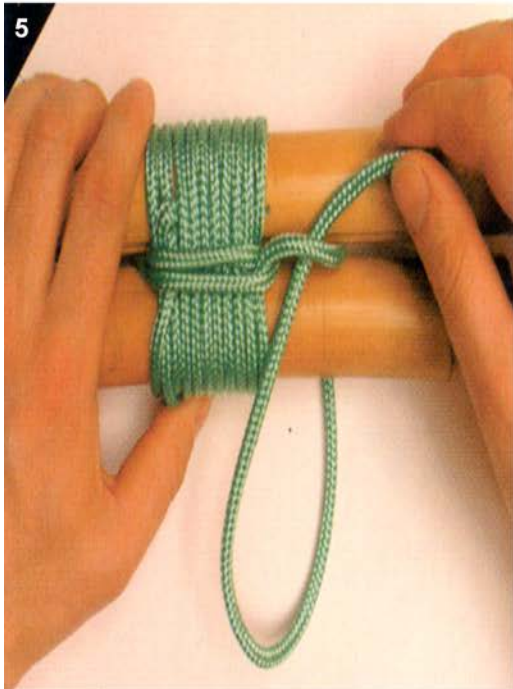

**STEP FIVE.** MAKE A CLOVE HITCH AROUND ONE OF THE POLES.



**STEP SIX.** ENSURE THE LASHING IS TIGHT AND SECURE.

*D. Pawson, Pocket Guide to Knots & Splices, Chartwell Books, Inc. (p. 184–185)*

Figure 12-5-1 (Sheet 2 of 3) Round Lashing



**STEP SEVEN. OPEN THE LASHING TO CREATE AN A-FRAME.**

*D. Pawson, Pocket Guide to Knots & Splices, Chartwell Books, Inc. (p. 184–185)*

Figure 12-5-1 (Sheet 3 of 3) Round Lashing

## **SQUARE LASHING**

A square lashing secures two poles together at 90 degrees. The rope used to make the lashing should be considerably smaller than the size of the poles. For the lashing to be effective, each turn must be pulled as tight as possible as it is made.





**STEP ONE.** WITH THE VERTICAL POLE ON TOP OF THE HORIZONTAL POLE, MAKE A CLOVE HITCH. THE VERTICAL POLE RUNS UP AND DOWN, AND THE HORIZONTAL POLE LEFT TO RIGHT.

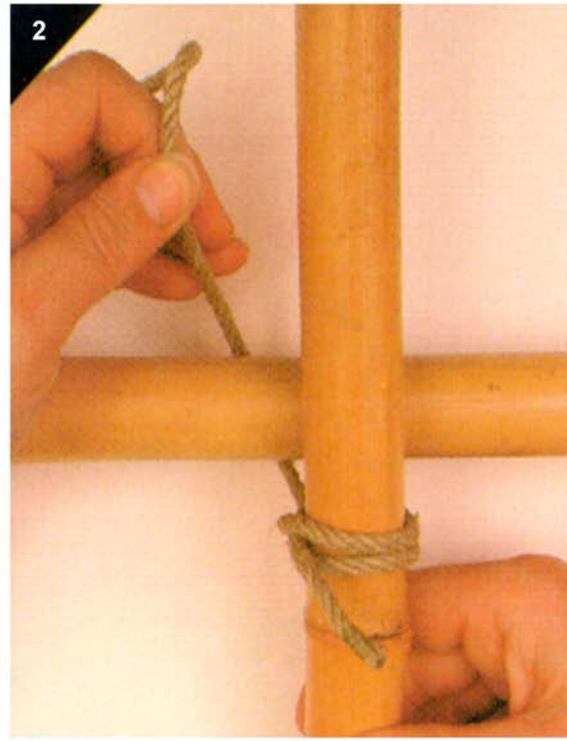

**STEP TWO.** BRING ALL OF THE ROPE AROUND AND BEHIND THE HORIZONTAL POLE.

*D. Pawson, Pocket Guide to Knots & Splices, Chartwell Books, Inc. (p. 180-181)*

Figure 12-5-2 (Sheet 1 of 4) Square Lashing





**STEP THREE.** TIGHTLY BRING THE ROPE OVER THE VERTICAL POLE AND BACK BEHIND THE HORIZONTAL POLE, BACK TO THE CLOVE HITCH.



**STEP FOUR.** CONTINUE TO MAKE THREE COMPLETE TURNS AROUND THE POLES, PULLING THE ROPE TIGHT AFTER EACH TURN.

*D. Pawson, Pocket Guide to Knots & Splices, Chartwell Books, Inc. (p. 180-181)*

Figure 12-5-2 (Sheet 2 of 4) Square Lashing

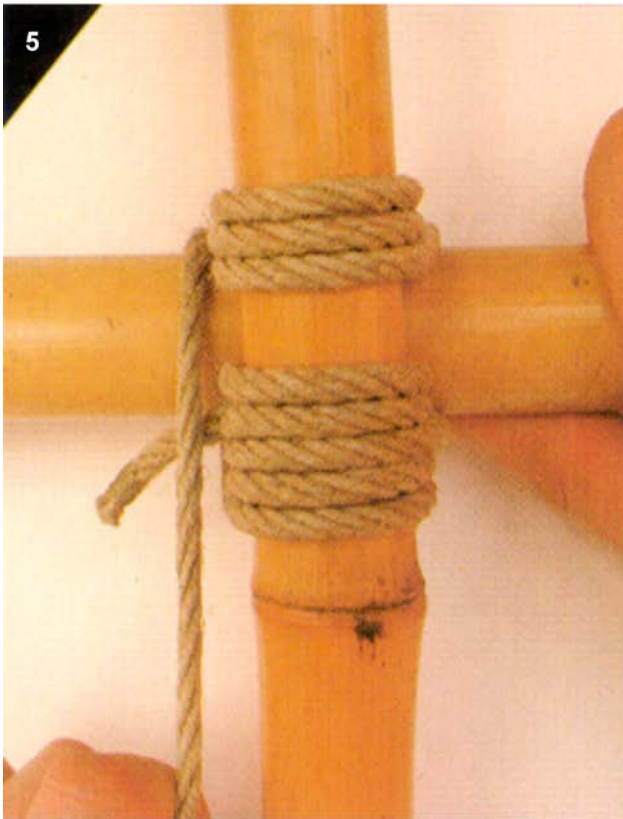

**STEP FIVE.** AFTER PASSING THE CLOVE HITCH, TIGHTLY BRING THE ROPE TO THE HORIZONTAL POLE FROM BEHIND AND START WRAPPING AROUND THE TWO SIDES OF THE POLE. THESE WRAPS ARE CALLED FRAPPING TURNS.



**STEP SIX.** MAKE TWO COMPLETE SETS OF FRAPPING TURNS.

*D. Pawson, Pocket Guide to Knots & Splices, Chartwell Books, Inc. (p. 180-181)*

Figure 12-5-2 (Sheet 3 of 4) Square Lashing



**STEP SEVEN. MAKE A CLOVE HITCH AROUND THE HORIZONTAL POLE.**



**STEP EIGHT. PULL TIGHT AND SECURE.**

*D. Pawson, Pocket Guide to Knots & Splices, Chartwell Books, Inc. (p. 180-181)*

Figure 12-5-2 (Sheet 4 of 4) Square Lashing

## TIMBER HITCH



The timber hitch is included because it is required for the diagonal lashing. It should not take a great amount of time to complete.



**STEP ONE.** TAKE THE STANDING END AND WRAP IT AROUND THE OBJECT, THEN AROUND THE STANDING PART OF THE ROPE.



**STEP TWO.** TWIST THE WORKING PART AROUND ITSELF BY WRAPPING IT AROUND THE WORKING END.

*D. Pawson, Pocket Guide to Knots & Splices, Chartwell Books, Inc. (p. 139)*

Figure 12-5-3 (Sheet 1 of 2) Timber Hitch





**STEP THREE.** CONTINUE MAKING TWISTS UNTIL THE TWISTED ROPE IS LONG ENOUGH TO GO AROUND THE OBJECT. PULL ON THE STANDING PART TO TIGHTEN THE HITCH.

*D. Pawson, Pocket Guide to Knots & Splices, Chartwell Books, Inc. (p. 139)*

Figure 12-5-3 (Sheet 2 of 2) Timber Hitch

### **DIAGONAL LASHING**

A diagonal lashing is used at a crossing point, to prevent poles from springing apart.



**STEP ONE.** MAKE A TIMBER HITCH AROUND THE TWO CROSSED POLES.



**STEP TWO.** MAKE A TURN AROUND THE TWO CROSSED POLES, PULLING THE TIMBER HITCH TIGHT.



**STEP THREE.** MAKE THREE MORE COMPLETE TURNS IN THE SAME DIRECTION, PULLING THEM TIGHT.



**STEP FOUR.** CHANGE DIRECTION BY COMING AROUND ONE OF THE POLES.

*D. Pawson, Pocket Guide to Knots & Splices, Chartwell Books, Inc. (p. 182-183)*

Figure 12-5-4 (Sheet 1 of 4) Diagonal Lashing

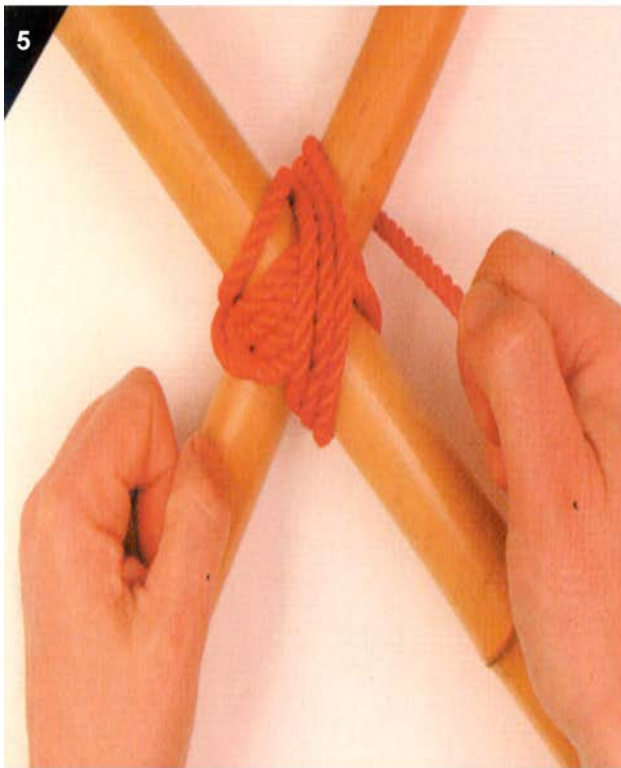

**STEP FIVE.** MAKE FOUR FULL TURNS AROUND THE TWO POLES AT RIGHT ANGLES TO THE ORIGINAL TURNS, PULLING THEM TIGHT.

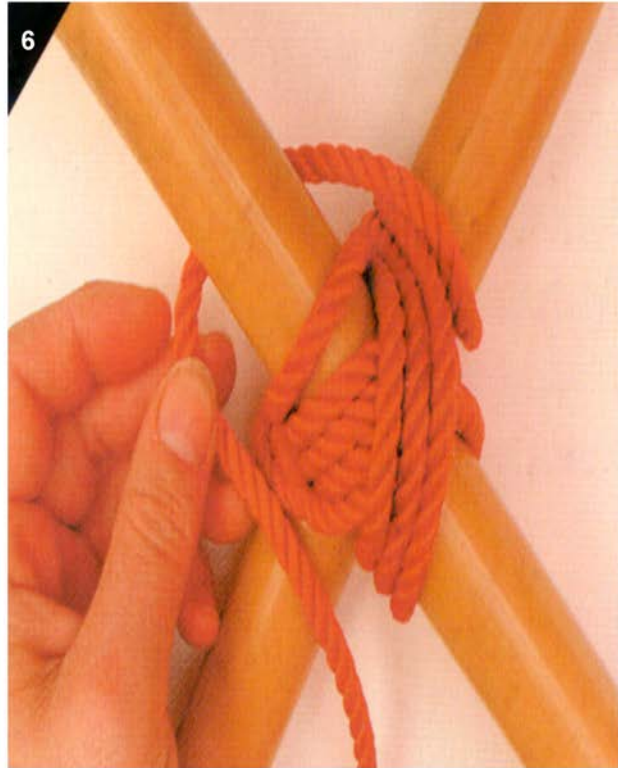

**STEP SIX.** TAKE THE WORKING END OF THE ROPE AROUND ONE OF THE POLES, MAKING A FRAPPING TURN.

*D. Pawson, Pocket Guide to Knots & Splices, Chartwell Books, Inc. (p. 182-183)*

Figure 12-5-4 (Sheet 2 of 4) Diagonal Lashing



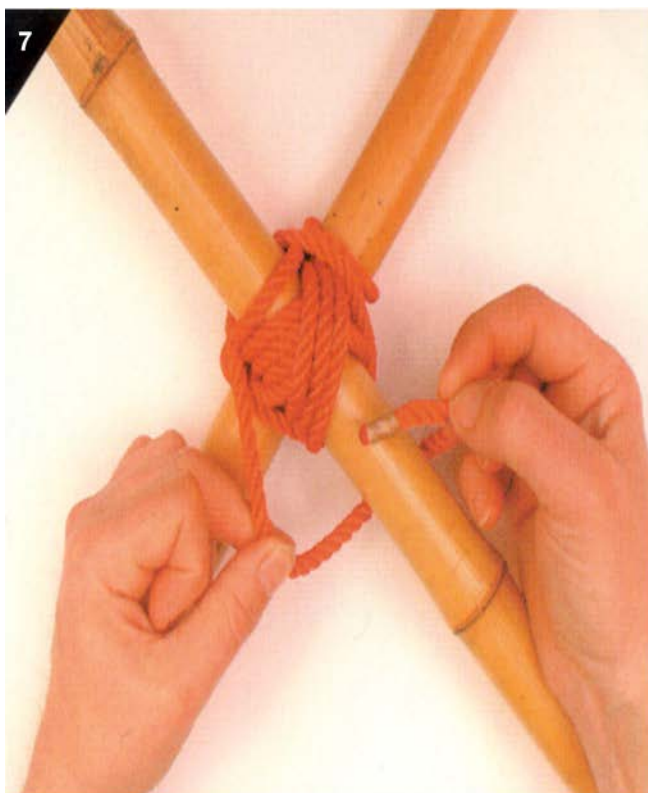

**STEP SEVEN. MAKE TWO COMPLETE FRAPPING TURNS.**



**STEP EIGHT. MAKE A CLOVE HITCH.**

*D. Pawson, Pocket Guide to Knots & Splices, Chartwell Books, Inc. (p. 182-183)*

Figure 12-5-4 (Sheet 3 of 4) Diagonal Lashing

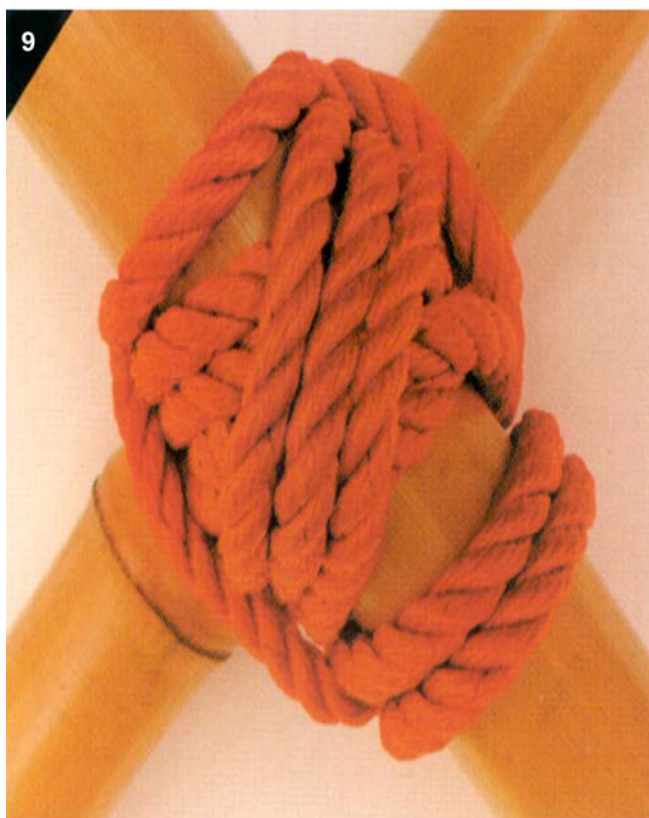

**STEP NINE. PULL THE LASHING TIGHT AND SECURE.**

*D. Pawson, Pocket Guide to Knots & Splices, Chartwell Books, Inc. (p. 182-183)*

Figure 12-5-4 (Sheet 4 of 4) Diagonal Lashing

### FIGURE-OF-EIGHT LASHING

The figure-of-eight lashing is used to join three poles together, to create a tripod.



When making a figure-of-eight lashing, the poles shall be placed staggered.

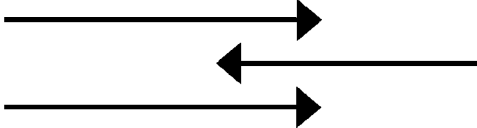

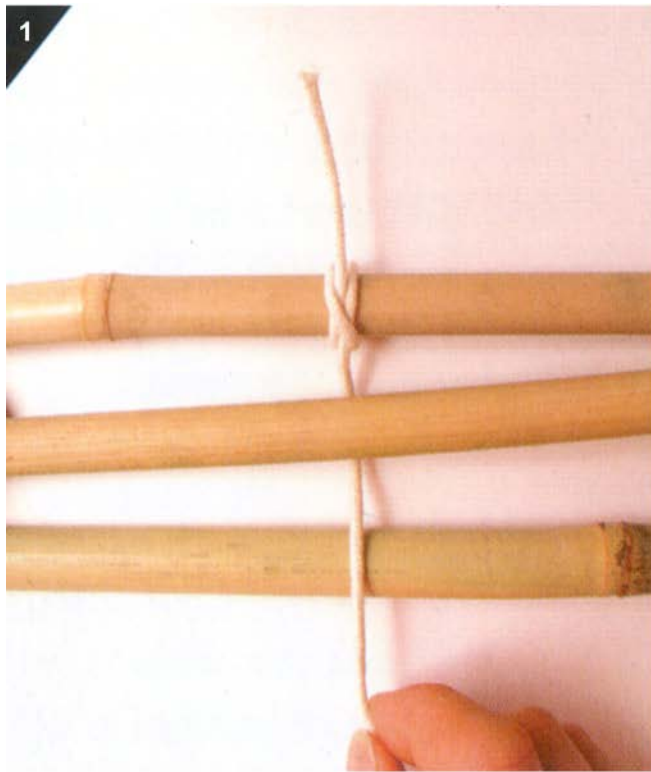

**STEP ONE.** MAKE A CLOVE HITCH AROUND ONE OF THE OUTSIDE POLES. BRING THE ROPE UNDER AND OVER THE OTHER POLES.

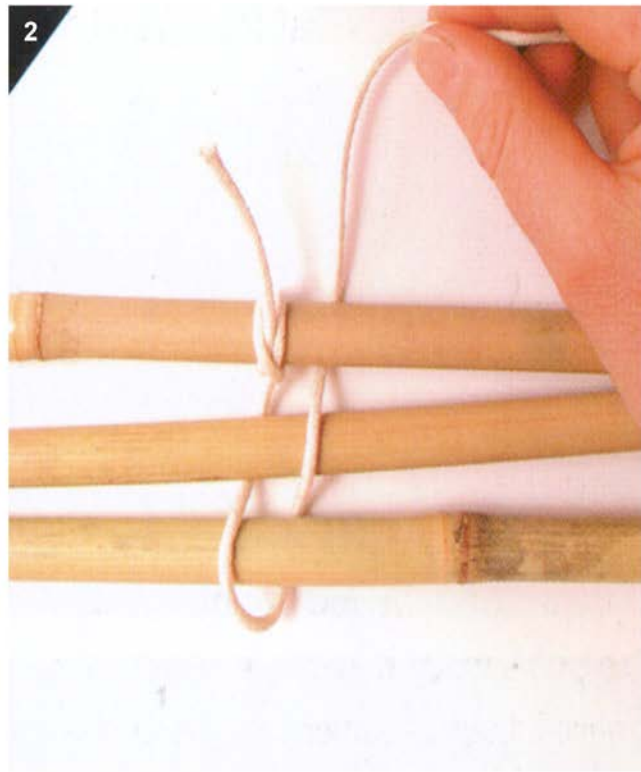

**STEP TWO.** GO AROUND THE POLE FURTHEST AWAY FROM THE START AND WEAVE THE ROPE BACK OVER AND UNDER.

*D. Pawson, Pocket Guide to Knots & Splices, Chartwell Books, Inc. (p. 187-188)*

Figure 12-5-5 (Sheet 1 of 4) Figure-of-Eight Lashing

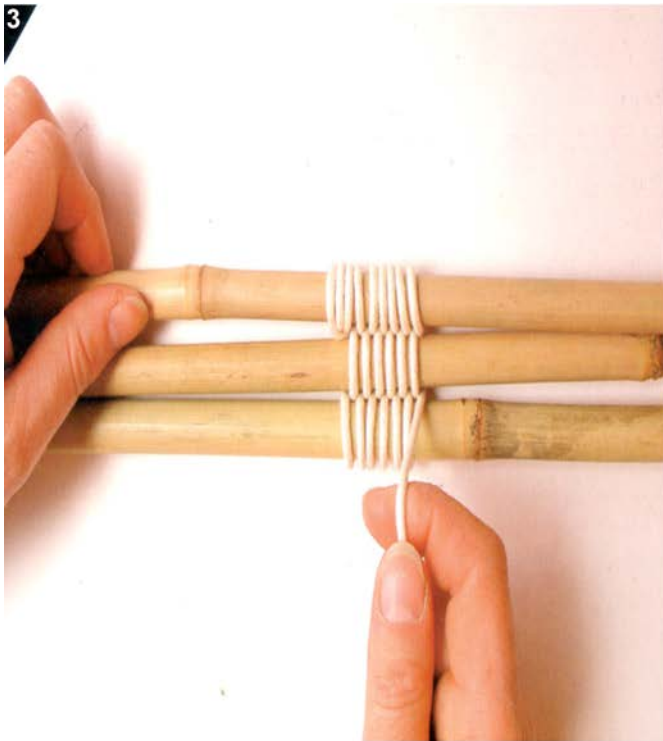

**STEP THREE.** CONTINUE TO WEAVE THE ROPE UNDER AND OVER EIGHT TIMES. BRING THE ROPE UP IN BETWEEN ANY TWO POLES.

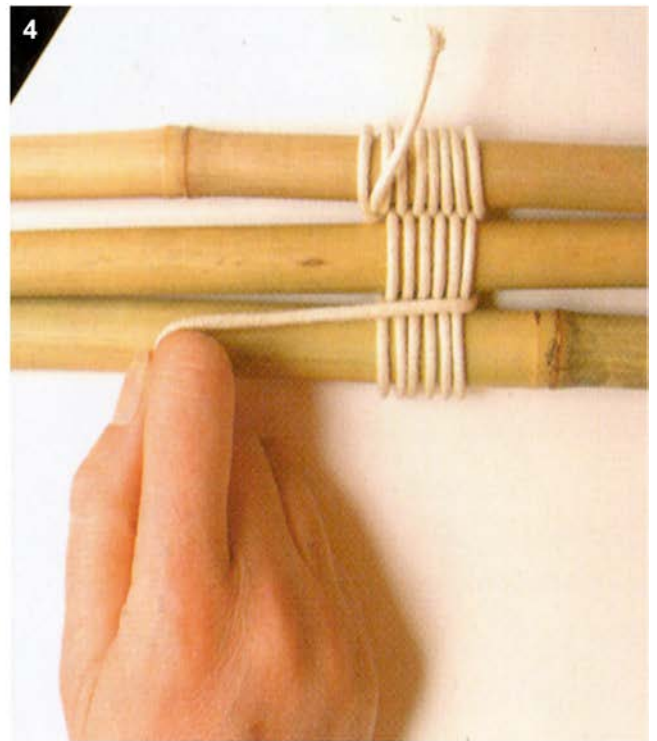

**STEP FOUR.** PULL THE ROPE PARALLEL TO THE POLES AND PUT IN TWO FRAPPING TURNS.

*D. Pawson, Pocket Guide to Knots & Splices, Chartwell Books, Inc. (p. 187-188)*

Figure 12-5-5 (Sheet 2 of 4) Figure-of-Eight Lashing

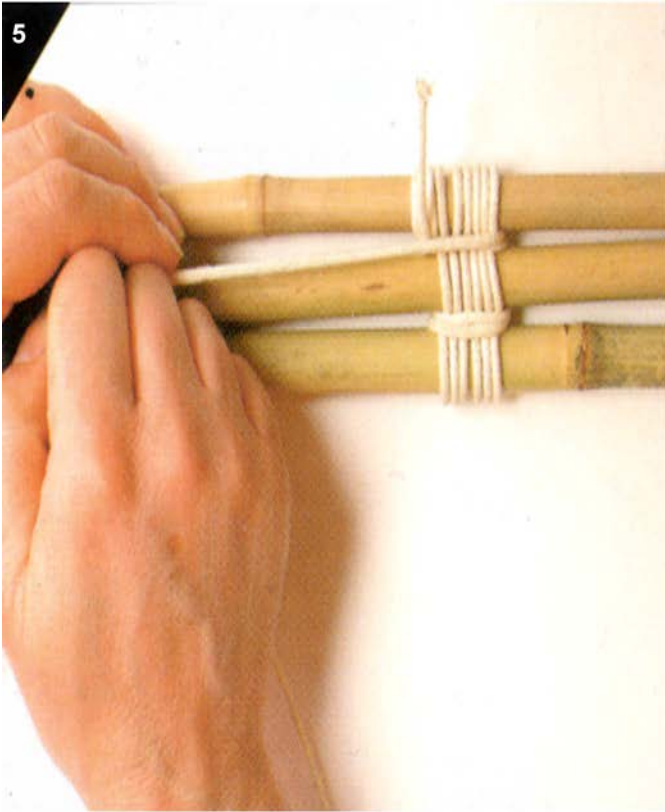

**STEP FIVE. MAKE THREE FRAPPING TURNS IN BETWEEN THE REMAINING POLES.**

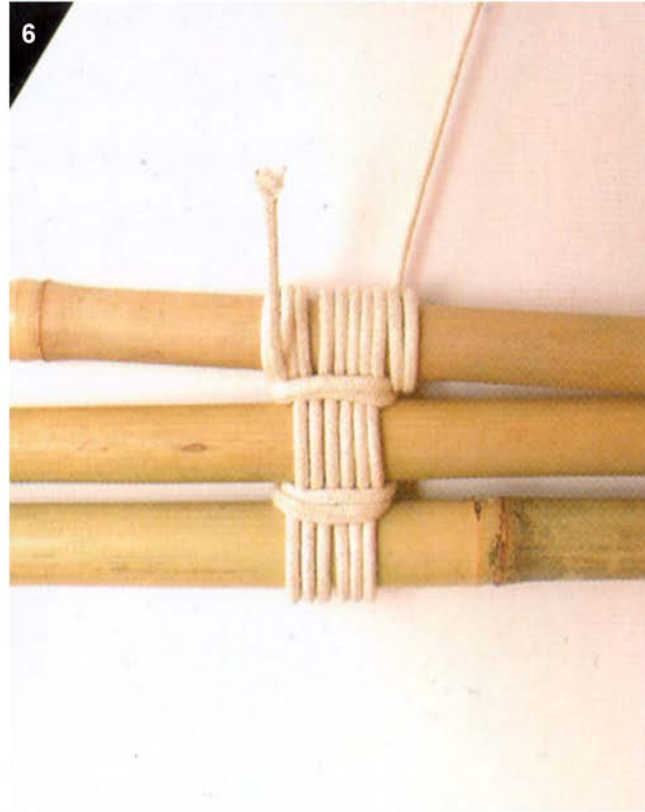

**STEP SIX. MAKE A CLOVE HITCH AROUND THE POLE THAT ALREADY HAS A CLOVE HITCH (FROM THE BEGINNING) AT THE OPPOSITE END.**

*D. Pawson, Pocket Guide to Knots & Splices, Chartwell Books, Inc. (p. 187-188)*

Figure 12-5-5 (Sheet 3 of 4) Figure-of-Eight Lashing





**STEP SEVEN. OPEN THE POLES.**

*D. Pawson, Pocket Guide to Knots & Splices, Chartwell Books, Inc. (p. 187–188)*

Figure 12-5-5 (Sheet 4 of 4) Figure-of-Eight Lashing

---

**CONFIRMATION OF TEACHING POINT 1**

---

The cadets' participation in tying the lashings will serve as the confirmation of this TP.

---

**Teaching Point 2**

**Have the Cadets Construct Two Field Amenities**

Time: 130 min

Method: Practical Activity

---

**FIELD AMENITIES**

Field amenities will be chosen from the following:

- a swamp bed,
- a pack frame,
- a meat-drying rack,
- a raft, and
- a tool rack.

---

## ACTIVITY

---

### OBJECTIVE

The objective of this activity is to construct field amenities for a bivouac site, using the knots and lashings previously taught.

### RESOURCES

- nylon rope,
- twine,
- utility cord,
- natural resources, found in the field,
- 1.8–kg (4-lb) axe with a .91–m (36-inch handle),
- .60–m (24-inch) bow saw, and
- diagrams detailing field amenities.

### ACTIVITY LAYOUT

N/A.

### ACTIVITY INSTRUCTIONS

1. Divide cadets into groups of no more than four.
2. Depending on need and availability of resources, have the cadets choose two field amenities to construct.
3. Distribute instructions located at Annex B. Have the cadets select and use the most effective knots and lashings to make their field amenity.
4. When amenities are completed, view all constructed amenities.
5. Additional resources for field amenities are listed in the Instructions.
6. Depending on local regulations, have the cadets redistribute all material used in the construction.

### SAFETY

- Ensure cadets are employing safe tool use at all times.
- The wood chosen for the field amenities must be strong enough to hold 50 kg of weight.
- Established boundaries shall be respected at all times.

---

### CONFIRMATION OF TEACHING POINT 2

---

The cadets' participation in the activity will serve as the confirmation of this TP.

---

### END OF LESSON CONFIRMATION

---

The cadets' participation in the construction of field amenities in TP 2 will serve as the confirmation of this lesson.



---

**CONCLUSION**

---

**HOMEWORK/READING/PRACTICE**

N/A.

**METHOD OF EVALUATION**

N/A.

**CLOSING STATEMENT**

Field amenities will enhance any base camp. They are relatively easy to construct and are a fun way to reinforce usage of knots. They can make cadets comfortable in the field when it is a home away from home.

**INSTRUCTOR NOTES/REMARKS**

Natural resources found in the field such as fallen or dead wood, are to be used for construction.

Instructors are to confirm with local authorities that natural resources may be used for this activity.

Each cadet must gather three sticks or poles approximately 2.54 cm (one inch) in diameter prior to this lesson.

Field amenities will be disassembled, following construction.

The content of this EO is similar to content in C221.02 (Construct Field Amenities, A-CR-CCP-702/PF-001, Chapter 10, Section 11) and C121.01 (Construct Field Amenities, A-CR-CCP-701/PF-001, Chapter 10, Section 10). It is recommended that these lessons be conducted concurrently.

---

**REFERENCES**

---

- C2-007 (ISBN 0-7858-1446-9) Pawson, D. (2001). *Pocket Guide to Knots and Splices*. Edison, NJ: Chartwell Books Inc.
- C2-008 (ISBN 0-00-265314-7) Wiseman, J. (1999). *The SAS Survival Handbook*. Hammersmith, London: HarperCollins Publishers.
- C2-046 PioneeringProjects.org. (2004). *PioneeringProjects.org*. Retrieved February 20, 2008, from <http://www.pioneeringprojects.org/projects/index.htm>.

THIS PAGE INTENTIONALLY LEFT BLANK

**SAMPLE BIVOUCAC SITE DIAGRAM HANDOUT**

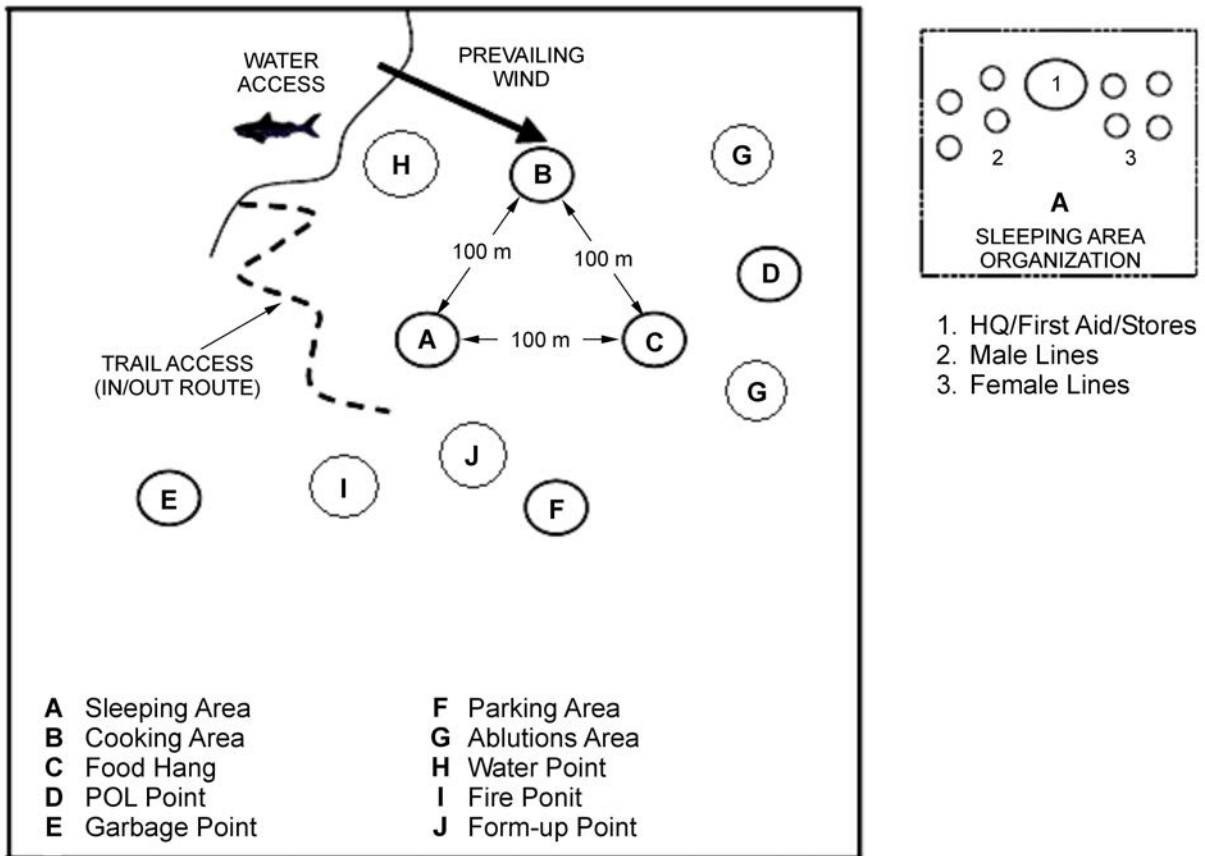

*Director Cadets 3, 2007, Ottawa ON: Department of National Defence*

Figure 12A-1 Sample Bivouac Site

 Areas that will be used after dark should be lit using Glow Sticks, lanterns or flashlights.

THIS PAGE INTENTIONALLY LEFT BLANK

## FIELD AMENITIES

### SWAMP BED

Using natural resources and cord, a ladder bed can be constructed. Steps to constructing a ladder bed are:

1. Collect natural resources, to include:
  - (a) four poles 75–100 cm long to construct the A-frames,
  - (b) two sturdy poles approximately 180 cm long to make the frame. Length will depend on the height of the person, and
  - (c) several cross pieces 50–60 cm long, the more flexible the better; number will depend on the size of the person.
2. Construct two A-frame supports using round lashings.
3. Attach the two frame poles to the A-frames, ensuring that the knots and wood are strong and will hold the weight of the individual.
4. Tie the cross pieces making a ladder along the frame.
5. Lay a bedding of boughs, leaves or moss, as desired. Ensure there is enough material to prevent heat being transferred away from the body during the night.

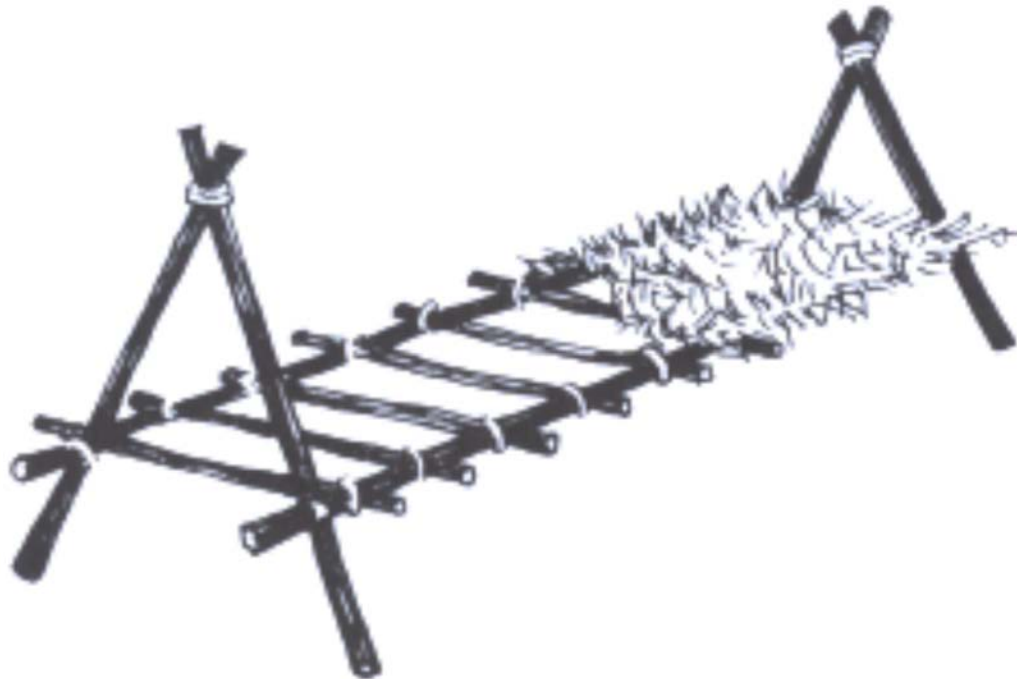

*J. Wiseman, The SAS Survival Handbook, HarperCollins Publishers (p. 309)*

Figure 12B-1 Swamp Bed

## PACK FRAME

Using natural resources, cord and two straps, a pack frame can be constructed. Steps to constructing a pack frame:

1. Collect natural resources, including:
  - (a) two poles to make the frame 75–100 cm long, (length will depend on the height of the person),
  - (b) several cross pieces 50–60 cm long, (length and number will depend on the size of the person), and
  - (c) five pieces (two 15–20 cm long , two 50 cm long and one 50–60 cm long) to construct the right angle projection at the bottom.
2. Construct the ladder frame to the size of the individual.
3. Construct the right angle projection at the bottom and ensure the knots and wood are strong and will not break with a load.
4. Attach straps made from cord or from improvisation and adjust it to a comfortable position.

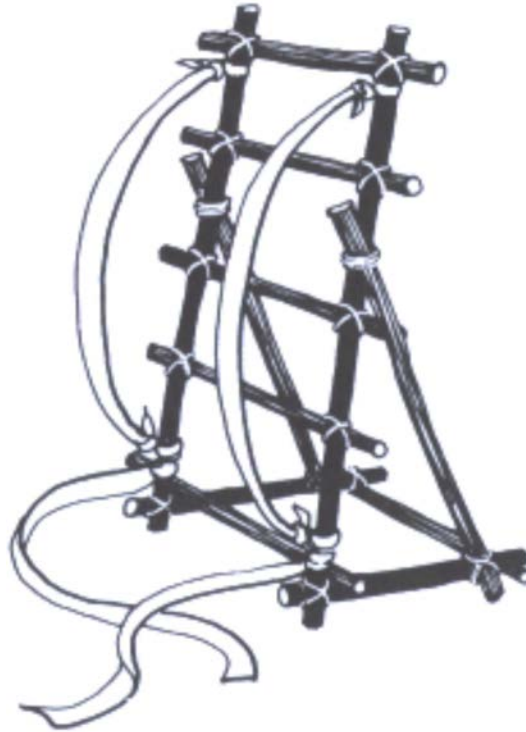

*J. Wiseman, The SAS Survival Handbook, HarperCollins Publishers (p. 372)*

Figure 12B-2 Pack Frame

## MEAT-DRYING RACK



*J. Wiseman, The SAS Survival Handbook, HarperCollins Publishers (p. 372)*

Figure 12B-3 Meat-Drying Rack

Using natural materials and cord a meat-drying rack can be constructed (as illustrated in Figure 12B-3).

1. Collect natural resources, to include:
  - (a) three poles approximately 3 m long,
  - (b) three poles approximately 2 m long,
  - (c) two poles approximately 1.5 m long, and
  - (d) fourteen poles approximately 0.5 m long.
2. Construct a figure-of-eight lashing around the three long pieces of wood, to make a tripod.
3. Construct the drying rack, using square lashings.
4. Attach the drying rack portion to the long poles, using square lashings.

## RAFT

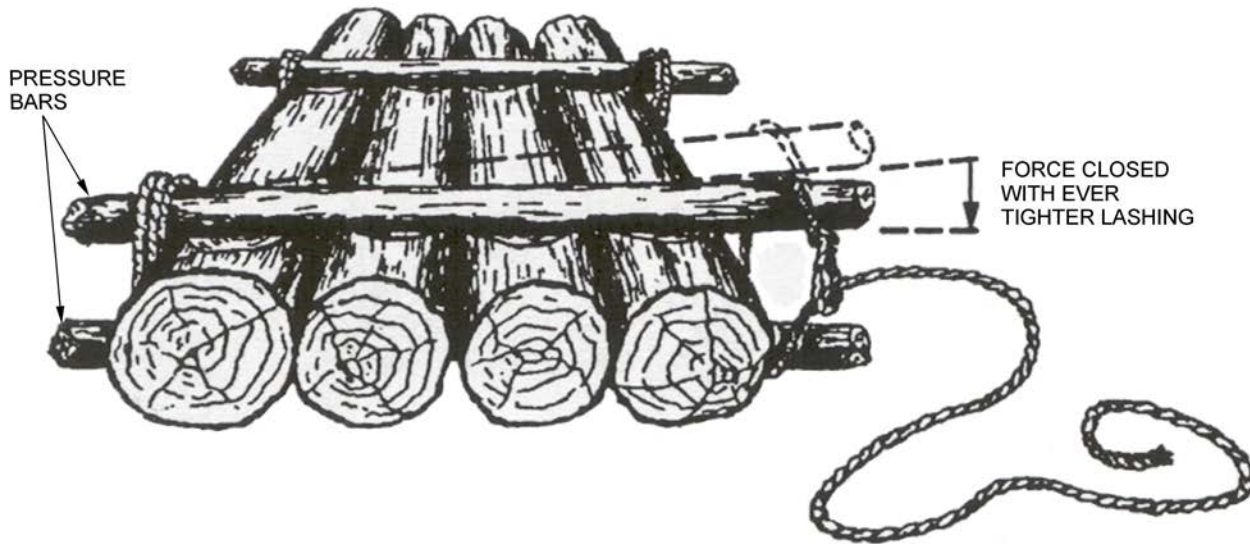

*The Department of the Army, U.S. Army Survival Handbook, The Lyons Press (p. 278)*

Figure 12B-4 Raft

1. Find a large area.
2. Obtain the following resources:
  - (a) three to six 3 m (9.84 feet) dry logs,
  - (b) two smaller logs 1.5 m (7–8 feet), and
  - (c) large quantity of twine.
3. Begin by placing three to five logs parallel to each other.
4. Lash the logs together using a figure-of-eight lashing.
5. Place smaller logs at each end of the logs perpendicular to the logs. Lash the pressure bars to the raft body.



Dry, dead, standing trees are the best logs for making rafts.



## TOOL RACK

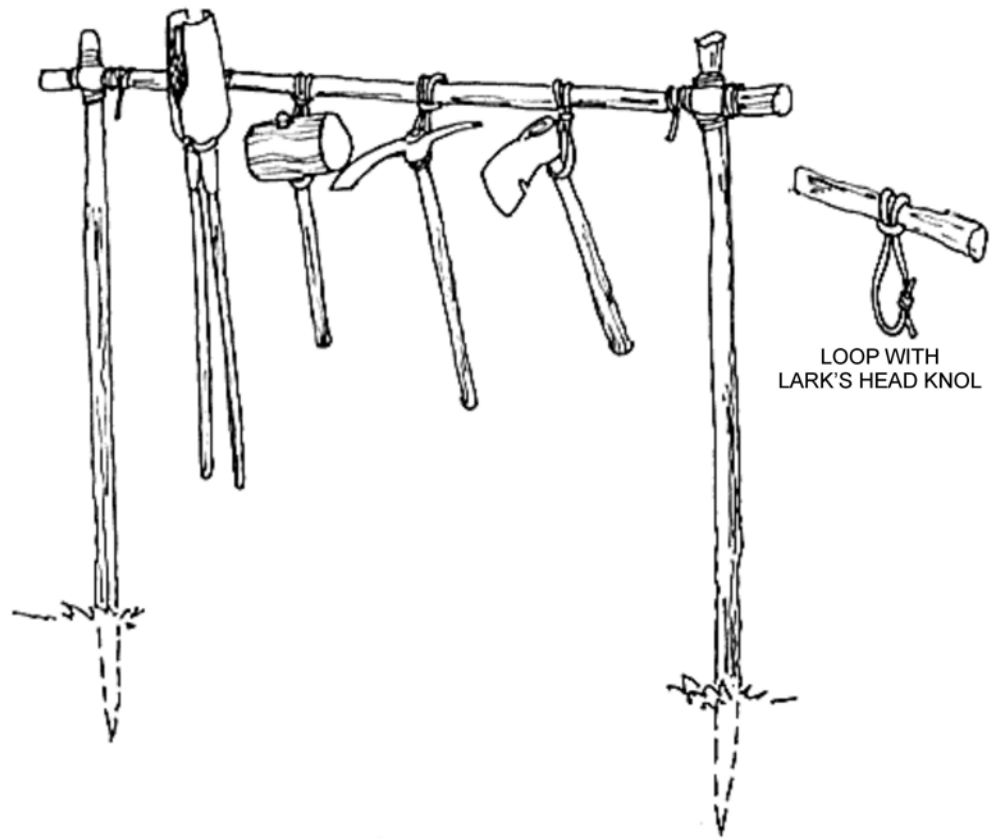

*Pioneering Projects.org by A. Miller, 2004, Projects, Copyright 2001 from PioneeringProjects.org.  
Retrieved March 5, 2008, from <http://www.pioneeringprojects.org/projects/index.htm>*

Figure 12B-5 Tool Rack

A tool rack will keep tools off of the ground and prevent them from rusting or becoming dull too quickly. By having tools kept in one place they are less likely to go missing and site safety is increased.

Using natural resources and cord, a tool rack can be constructed. Steps to constructing a tool rack:

1. Collect the three poles 180 cm (5.9 feet) long from natural resources.
2. Start by driving two uprights into the ground or use two trees.
3. Lash a ridge pole between the two uprights to hang the tools from.
4. Tie pieces of cord into a loop using a reef knot and then loop it over the ridge pole (as illustrated in Figure 12B-5).

Another example (as illustrated in Figure 12B-6) has two crosspieces of wood for increased stability.



*Scoutmaster, Knots and Pioneering, Copyright 2007 by Amazon.com, Inc. Retrieved November 18, 2007, from [http://scoutmaster.typepad.com/.shared/image.html?/photos/uncategorized/chip5\\_copy\\_copy.jpg](http://scoutmaster.typepad.com/.shared/image.html?/photos/uncategorized/chip5_copy_copy.jpg)*

Figure 12B-6 Tool Rack 2

**CHAPTER 13**

**PO 322 – PLOT LOCATION ON A TOPOGRAPHICAL MAP  
USING A GLOBAL POSITIONING SYSTEM RECEIVER**





**ROYAL CANADIAN ARMY CADETS**  
**SILVER STAR**  
**INSTRUCTIONAL GUIDE**



**SECTION 1**

**EO M322.01 – REVIEW RED STAR NAVIGATION**

---

Total Time: 30 min

---

**PREPARATION**

---

**PRE-LESSON INSTRUCTIONS**

Resources needed for the delivery of this lesson are listed in the lesson specification located in A-CR-CCP-703/PG-001, Chapter 4. Specific uses for said resources are identified throughout the instructional guide within the TP for which they are required.

Review the lesson content and become familiar with the material prior to delivering the lesson.

**PRE-LESSON ASSIGNMENT**

Mark off 100 m for pacing.

**APPROACH**

An interactive lecture was chosen for this lesson to review the basic and background material covered during Red Star navigation.

---

**INTRODUCTION**

---

**REVIEW**

N/A.

**OBJECTIVES**

By the end of this lesson the cadet shall have reviewed Red Star navigation, to include:

- describing bearings;
- identifying compass parts;
- setting declination;
- determining distance on a map;
- determining individual pace;
- orienting a map using a compass; and
- taking a magnetic bearing using a compass.

**IMPORTANCE**

It is important for cadets to participate in a review of Red Star navigation as it is a foundation for building subsequent navigation skills. The review will clarify any areas in question, providing an opportunity for cadets to work on their skills and retard progressive skill decay. Red Star navigation is an important aspect of expedition training and before learning new skills, the skills already taught should be reviewed. All cadets should take every opportunity to practice and refine these skills.

**Teaching Point 1****Conduct a Review of Red Star Navigation**

Time: 25 min

Method: Interactive Lecture



Briefly review Red Star navigation without spending too much time on any one point.

**POINTS OF THE COMPASS ROSE**

**Four Cardinal Points.** Measured at right angles clockwise, they are:

1. north (N),
2. east (E),
3. south (S), and
4. west (W).

**Four Inter-Cardinal Points.** Located halfway between each of the cardinal points. Measured clockwise, they are:

1. northeast (NE),
2. southeast (SE),
3. southwest (SW), and
4. northwest (NW).

**Eight Intermediate Points.** Located halfway between each cardinal point and inter-cardinal point. Measured clockwise, they are:

1. north-northeast (NNE),
2. east-northeast (ENE),
3. east-southeast (ESE),
4. south-southeast (SSE),
5. south-southwest (SSW),
6. west-southwest (WSW),
7. west-northwest (WNW), and
8. north-northwest (NNW).

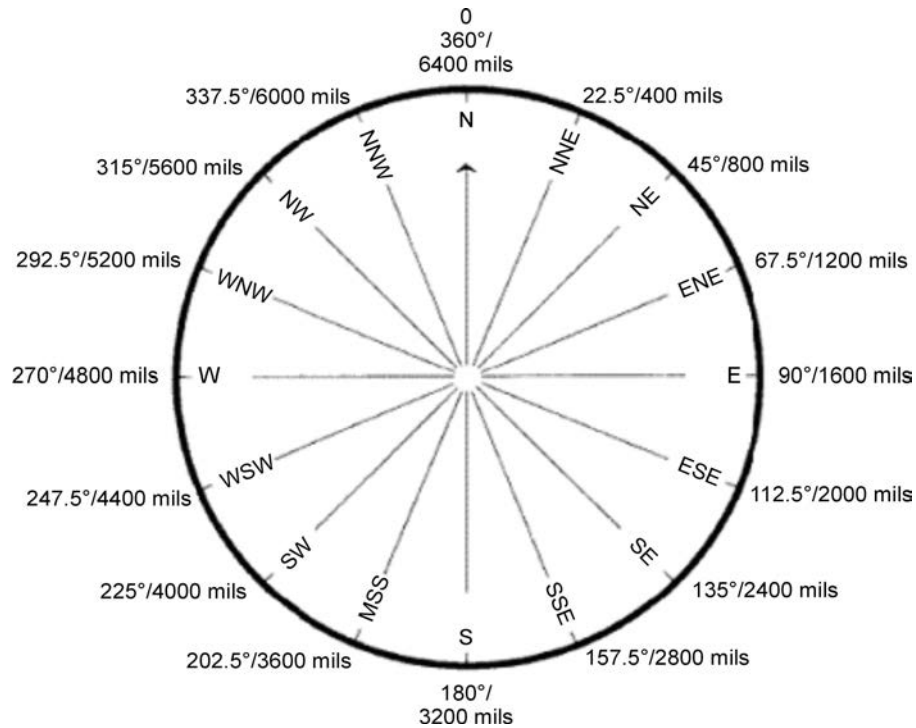

*Director Cadets 3, 2007, Ottawa, ON: Department of National Defence*

Figure 13-1-1 Compass Rose

## SCALES ON A COMPASS

To express direction in an accurate and precise method, the full circle of the compass rose is divided into equal measures of angle. This measurement starts and ends at north (top) and always moves in a clockwise rotation. There are two main scales used to measure a circle – degrees and metric milli-radian (mils).

**Degrees.** The most common method of dividing a circle. There are 360 equal angles in a complete circle and they are represented by the degree symbol (eg, 360°). On the compass rose, north is located at 0 and 360 degrees, east is located at 90 degrees, south is located at 180 degrees and west is located at 270 degrees.

**Mils.** When a more accurate division of the same circle is required, the mils method is used. The mils method has a military background and is based on the metric system with 6400 equal angles in a complete circle. On the compass rose, north is located at 0 and 6400 mils, east is located at 1600 mils, south is located at 3200 mils and west is located at 4800 mils.

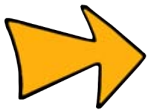

There are 22.5 degrees or 400 mils between each point on a compass rose.

## DEFINITION OF A BEARING

**Bearing.** An angle that is measured clockwise, from a fixed zero line; north is always this zero line. Simply, a bearing is just another name for an angle.

## TYPES OF BEARINGS

Bearings are divided into three different types:

**Grid Bearing.** A bearing that is measured between two points on a map. The ability to measure a bearing from a map allows a map user to plan routes or activities before going into the field, and provides an easy method of communicating location or movement.

**Magnetic Bearing.** A bearing that is measured between two points using a compass. A magnetic bearing is a quick and efficient method of describing a route to take. The bearing alone is usually not enough information to navigate with and must also have distance or a target object.

**Back Bearing.** A bearing that is in the exact opposite direction of the bearing that has been measured. A back bearing can be useful for different reasons; to return to the start location after a hike, or to calculate the bearing from an object to one's current location. Depending on the compass being used, the steps to calculate a back bearing are:

1. When the bearing is less than 3200 mils or 180 degrees, add 3200 mils or 180 degrees.
2. When the bearing is greater than 3200 mils or 180 degrees, subtract 3200 mils or 180 degrees.

## COMPASS PARTS



Refer to Figure 13-1-2 or an actual compass to identify the parts of a compass with the cadets.

**A - Sight.** Located at the top of the compass cover, used to align an objective or bearing.

**B - Compass Cover.** Protects the compass dial and houses the sighting mirror.

**C - Sighting Mirror.** Used to see the compass dial while setting a bearing.

**D - Sighting Line.** Used when aligning the objective or bearing.

**E - Luminous Index Point.** Located at the top of the compass dial and is where a bearing is set and read from.

**F - Compass Dial.** Houses the magnetic needle, the orienting arrow and the declination scale on the inside and the dial graduations on the outside.

**G - Dial Graduations.** The compass dial is graduated in 50 mil divisions from 0 to 6400 mils, or two degree divisions from 0 to 360 degrees. The dial is rotated by hand.

**H - Orienting Arrow.** The red orienting arrow is located inside the compass dial and is used to line up the magnetic needle. The orienting arrow is always set at 00 mils/degrees.

**I - Romer 1 : 25 000.** Used to measure a grid reference (GR) on a map with a 1 : 25 000 scale.

**J - Compass Base Plate.** Clear piece of flat plastic, to which the cover, dial and lanyard are attached.

**K - Declination Scale.** Used to compensate for the variation of magnetic declination between the compass and the map being used.

**L - Compass Meridian Lines.** Black or red lines inside the compass dial and are used to line up the compass dial with the grid lines on a map.

**M - Magnetic Needle.** Spins freely and points to magnetic north. The south end of the compass needle is black and the north end, with a luminous patch, is red. When the magnetic needle is lined up with the red orienting arrows, the mnemonic "Red in the Bed" is used to remember which end of the needle belongs between the arrows.



**N - Luminous Orienting Points.** There are two luminous orienting points located on either side of the orienting arrow.

**O - Luminous Index Point.** The luminous orienting point at the bottom of the compass dial, where a back bearing is read from.

**P - Romer 1 : 50 000.** Used to measure a GR on a map with a 1 : 50 000 scale.

**Q - Safety Cord or Lanyard.** Used to fasten the compass to the body.

**R - Adjustable Wrist Lock.** Used to attach the compass to the wrist.

**S - Screwdriver.** The tiny screwdriver at the end of the safety cord is used to turn the screw to adjust the declination scale.

**T - Declination Adjustment Screw.** Located on the back side of the compass dial and is used to adjust the declination scale (not shown).

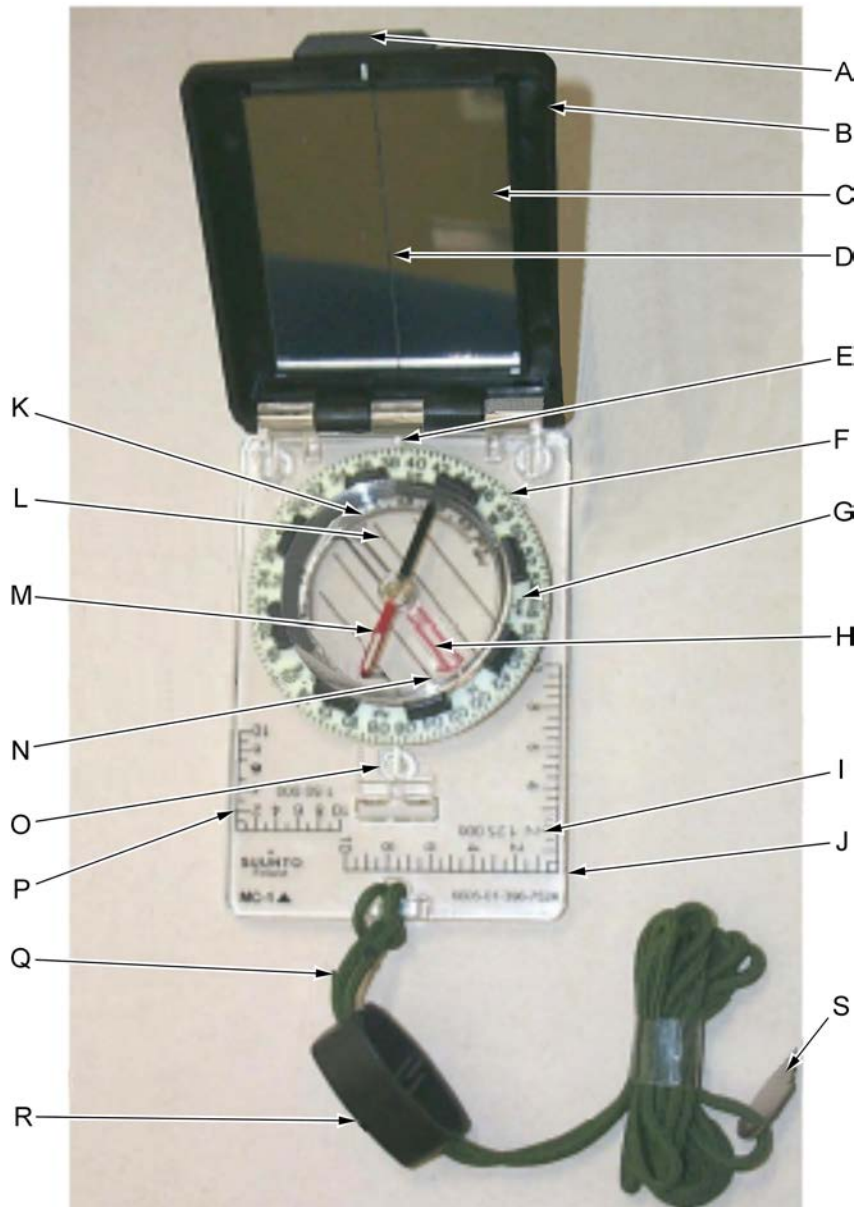

A-CR-CCP-121/PT-001, Royal Canadian Army Cadet Reference Book (p. 5-33)

Figure 13-1-2 Compass

### SET DECLINATION ON A COMPASS

The compass's declination scale must be set to compensate for the difference between true north and magnetic north. To set declination on a compass the amount of declination adjustment in degrees east or west is needed. Turn the compass over and look at the back of the dial.

From the zero point, use the screwdriver on the end of the safety cord and turn the declination screw to the right for west and to the left for east declination. Each small black line is two degrees.



When setting declination on a compass, it is easier to hold the screwdriver and turn the compass, especially in cold weather. The declination shall never be turned past 90 degrees on the declination scale.

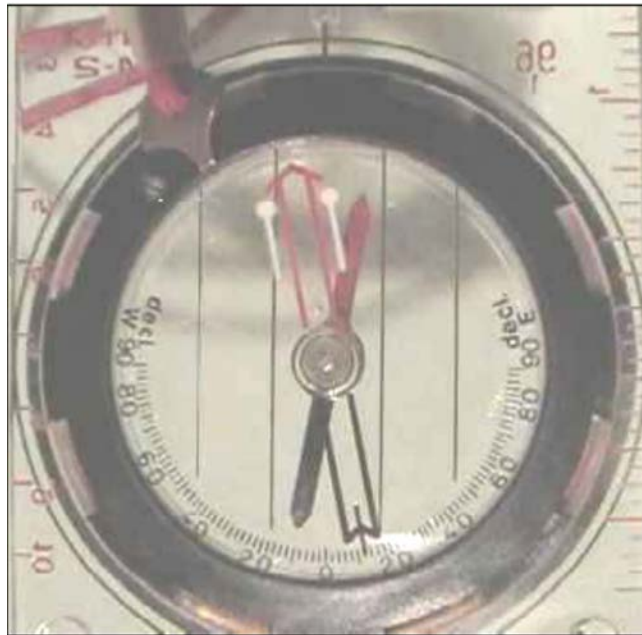

*Director Cadets 3, 2007, Ottawa, ON: Department of National Defence*

Figure 13-1-3 Declination Screw

## **DETERMINE DISTANCE**

### **Determining Distance on a Map**

Cadets can use their maps to measure the distance between two points on the ground. All maps are drawn to scale; therefore, a specified distance on a map equals a specified distance on the ground. The scale of a map is printed at the top and bottom of each map (eg, Scale 1 : 50 000). This means that 1 cm on the map equals 50 000 cm (500 m) on the ground.

There are two ways to determine distance on a topographical map – point-to-point and along a route.

**Measuring Point-to-Point.** To measure a distance point-to-point:

1. Lay the straight edge of a piece of paper against the two points.
2. With a sharp pencil, mark the paper at the A (start) and B (finish) points.
3. Lay the paper just under the scale bar (metres) and move the B mark backwards to each thousands mark until the A mark falls within the subdivided thousands (hundreds) to the left of the zero.
4. To calculate the total distance, add the number of thousands where the B mark is, plus the number of subdivided thousands where the A mark is to the left of the zero.

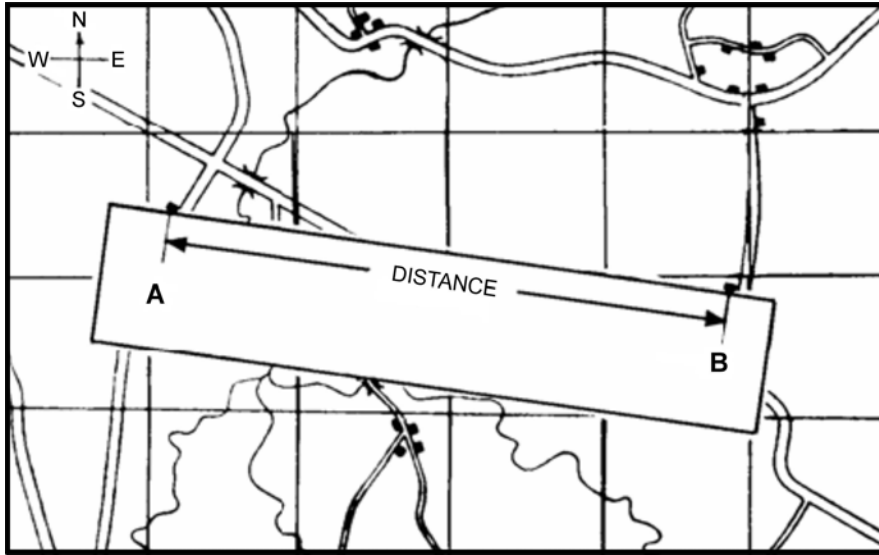

A-CR-CCP-121/PT-001 (p. 5-24)

Figure 13-1-4 Measuring Distance Point-to-Point

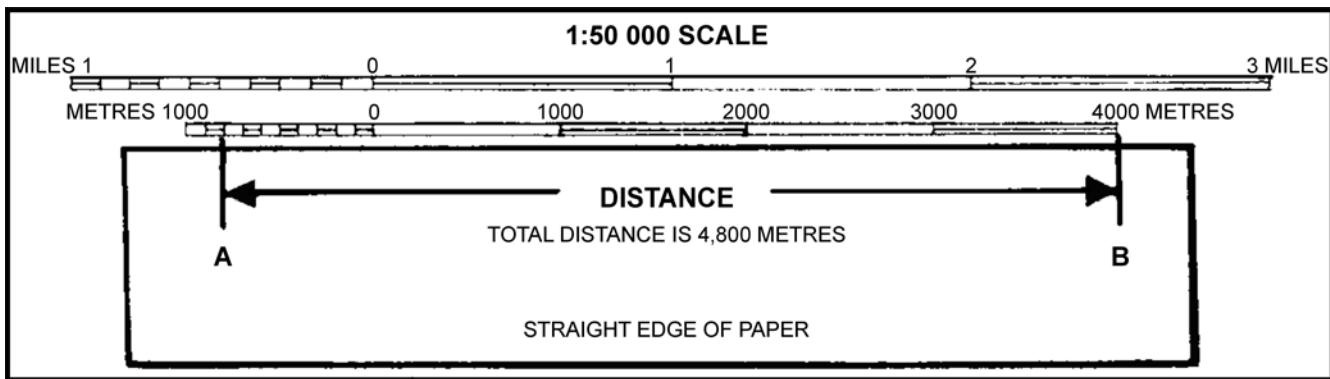

A-CR-CCP-121/PT-001 (p. 5-25)

Figure 13-1-5 Calculating Distance



For a distance that is longer than 5 000 m, measure the first 5 000 m and mark the paper with a new line and label it '5 000 m'. Place the new mark at the zero or thousands mark until the A mark fits within the subdivided thousands bar. Add the total of that distance to the 5 000 m and that will be the total distance.

**Measuring Along a Route.** Sometimes the cadets need to find the distance between A and B around curves in a road or along a planned route. To measure a distance along a route between two points:

1. Lay the straight edge of a piece of paper against point A.
2. With a sharp pencil, mark point A on the paper and the map.
3. Line up the paper with the edge of the road until you come to a curve and make another mark on the paper and on the map.
4. Pivot the paper so that it continues to follow the road edge. Repeat until you reach point B.
5. Mark your paper and the map at point B.

6. Lay the paper just under the scale bar (metres) and move the B mark backwards to each thousands mark until the A mark falls within the subdivided thousands to the left of the zero.
7. Adding the number of thousands where the B mark is, plus the number of subdivided thousands where the A mark is to the left of the zero, will determine the total distance.

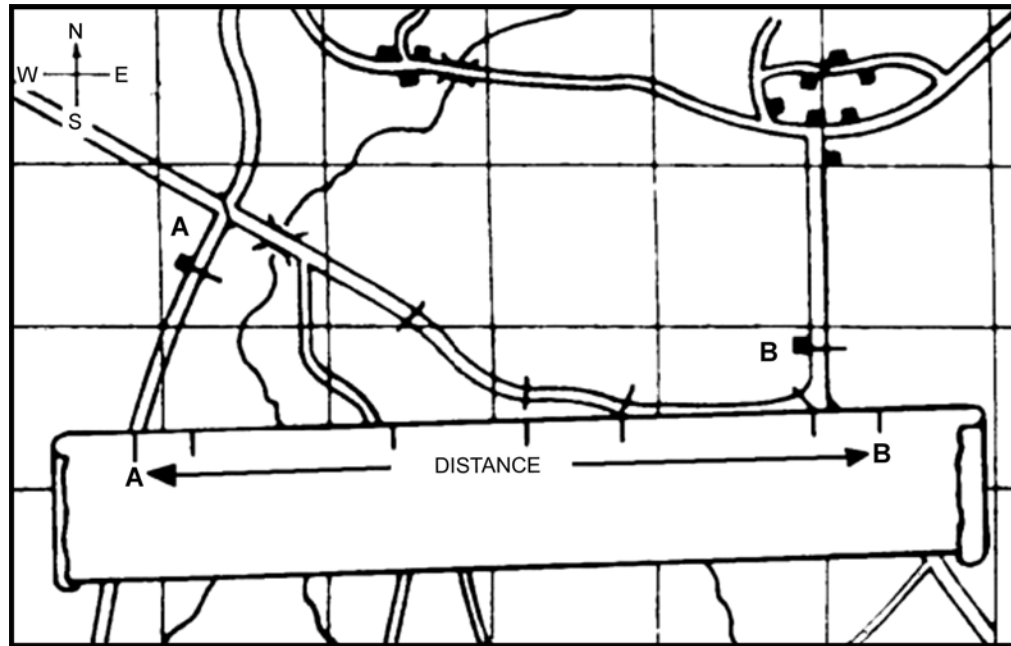

*A-CR-CCP-121/PT-001 (p. 5-25)*

Figure 13-1-6 Measuring Distance Along a Route

### Determining Individual Pace

**Pace Counting Method (Pacing).** Used for measuring a given distance by counting every other step. Two steps equal one pace. Pacing is a very important skill in navigation, as each person has a different pace and needs to establish their pace before it can become a useful measurement tool. Pacing varies between individuals as it uses a natural stride – an average adult will pace about 60–70 paces in 100 m.

To determine an individual pace, practice taking uniform, comfortable steps over a measured distance (100 m) counting every second step of the dominant foot. Do this three to five times to get an average. This will be the individual's pace number and should be remembered.

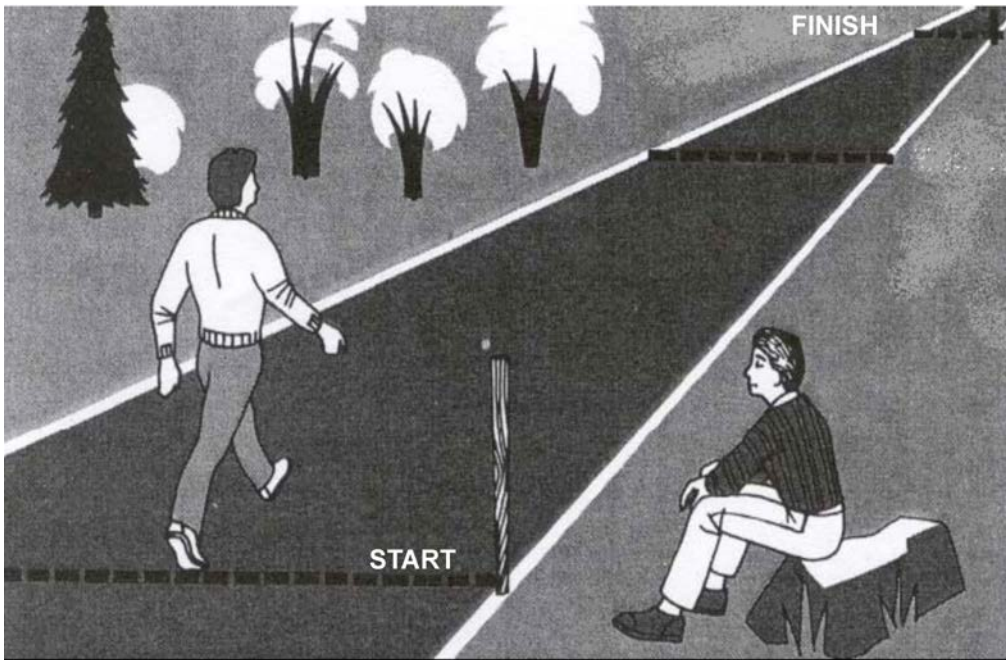

*B. Kjellstrom, Be Expert with Map & Compass, Hungry Minds, Inc. (p. 53)*

Figure 13-1-7 Determining Distance Using Pacing

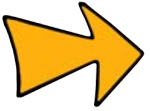

Remember, pacing is an approximation. A margin of error of 1–2 percent is considered reasonable (eg, 10–20 m for every 1 km walked).

### Factors That Affect Pacing

Pacing can be affected by different factors and the count may vary. Some of the factors and the affect on individual pacing are:

- **Topography.** This is the most common factor. Walking through mud, thick bush and tall vegetation can shorten the paces.
- **Slopes.** Walking uphill will shorten paces, while walking downhill can lengthen paces.
- **Fatigue.** Pacing may change from natural in the morning, when cadets are rested, to shorter in the afternoon as they start to get tired.
- **Equipment.** Equipment could affect pacing, such as the wrong type of footwear. Too much or too little clothing and the amount of equipment being carried can shorten the paces.
- **Weather.** Heavy rain, wind velocity, temperature and snow can shorten the paces.



Pacing beads can be used to keep track of the distance walked. One bead is moved for every 100 m walked. If pacing beads are not available, stones can be used by moving them from one pocket to another to count every 100 m.

### ORIENT A MAP USING A COMPASS

To orient a map using a compass:

1. set the current declination on the compass;



2. set the compass dial to read 00 (zero) mils or 0 degrees (north);
3. lay the compass flat on the map with the cover open;
4. point the mirror to north (top of the map);
5. align one side of the base plate with an easting line; and
6. turn the map and compass together until the red end of the magnetic needle is over the orienting arrow.



The mnemonic used to remember putting the magnetic needle over the orienting arrow is “Red in the Bed”.



*Director Cadets 3, 2007, Ottawa,  
ON: Department of National Defence*

Figure 13-1-8 Set Declination



*Director Cadets 3, 2007, Ottawa,  
ON: Department of National Defence*

Figure 13-1-9 Set Compass to 00



*Director Cadets 3, 2007, Ottawa,  
ON: Department of National Defence*

Figure 13-1-10 Turn  
Until Red is in the Bed

## TAKE A MAGNETIC BEARING

A compass can be used to identify the cardinal points such as north and south, the direction of travel and the bearing from one's current location to a prominent object. However, the ability to take a magnetic bearing of a prominent object and to use that information to help identifying one's general location can save hours when trekking. A magnetic bearing is a quick method for determining the direction of travel.

There are two ways to determine a magnetic bearing.

To determine the magnetic bearing of a prominent object:

1. Check and set the predetermined declination on the compass.
2. Hold the compass at eye level, at arms length, and face the prominent object.

3. Aim at the object using the compass sight, ensuring the sighting line is in line with the index pointer.
4. Adjust the compass cover so the compass dial is seen in the sighting mirror.
5. Look in the mirror and turn the compass dial until the magnetic needle is over the orienting arrow (red in the bed).
6. Read the number on the compass dial at the luminous index pointer. The magnetic bearing of the prominent object is read at the luminous index pointer.



A-CR-CCP-121/PT-001 (p. 5-42)

Figure 13-1-11 Taking a Magnetic Bearing

To determine a magnetic bearing on a map:

1. Set the predetermined declination on the compass.
2. Identify and mark the start (point A) and finish (point B) points on a map.
3. Draw a plotting line from point A to point B.
4. Lay the fully opened compass with the edge of the compass base plate along the plotting ray, in the direction of travel (point A to point B).
5. Hold the compass in place, rotate the compass dial so that the compass meridian lines align with the easting lines on the map, ensuring north on the dial indicates north on the map.
6. Read the number on the compass dial at the luminous index pointer.



Prior to determining a magnetic bearing on a map, it is good practice to first estimate the bearing by drawing a quick compass rose and looking at where the bearing would be on the compass rose. This serves as a good check to ensure the cadet has not accidentally measured the back bearing.



If the bearing is taken from point B to point A, the compass will be pointing 180 degrees or 3200 mils in the exact opposite direction of travel wanted. This is also called a back bearing.



---

**CONFIRMATION OF TEACHING POINT 1**

---

The cadets' participation in the review will serve as the confirmation of this TP.

---

**END OF LESSON CONFIRMATION**

---

The cadets' participation in the review will serve as the confirmation of this lesson.

---

**CONCLUSION**

---

**HOMEWORK/READING/PRACTICE**

N/A.

**METHOD OF EVALUATION**

N/A.

**CLOSING STATEMENT**

Map-reading skills take a great deal of practice in order for a person to become efficient using them in the field. Throughout expeditions, cadets will always be required to navigate routes. Take each and every opportunity to practice map and compass skills, whether it is navigating a route or even riding a bike. The skills learned in Green and Red Star navigation are building blocks. There are still many more navigation skills to acquire.

**INSTRUCTOR NOTES/REMARKS**

Assistant instructors may be required for this lesson.

---

**REFERENCES**

---

- |        |  |
|--------|--|
| A2-041 | B-GL-382-005/PT-001 Canadian Forces. (2006). <i>Maps, Field Sketching, Compasses and the Global Positioning System</i> . Ottawa, ON: Department of National Defence. |
| C0-011 | Canadian Orienteering Federation. (1985). <i>Orienteering Level Two Coaching Certification</i> . Ottawa, ON: Canadian Orienteering Federation.                       |
| C2-041 | (ISBN 0-07-136110-3) Seidman, D., & Cleveland, P. (1995). <i>The Essential Wilderness Navigator</i> . Camden, ME: Ragged Mountain Press.                             |

THIS PAGE INTENTIONALLY LEFT BLANK



**ROYAL CANADIAN ARMY CADETS**  
**SILVER STAR**  
**INSTRUCTIONAL GUIDE**



**SECTION 2**

**EO M322.02 – CALCULATE MAGNETIC DECLINATION**

---

Total Time: 60 min

---

**PREPARATION**

---

**PRE-LESSON INSTRUCTIONS**

Resources needed for the delivery of this lesson are listed in the lesson specification located in A-CR-CCP-703/PG-001, Chapter 4. Specific uses for said resources are identified throughout the instructional guide within the TP for which they are required.

Review the lesson content and become familiar with the material prior to delivering the lesson.

Photocopy the handout located at Annex A for each cadet.

**PRE-LESSON ASSIGNMENT**

N/A.

**APPROACH**

An interactive lecture was chosen for TP 1 to orient the cadet to calculating magnetic declination and to present basic material.

Demonstration and performance was chosen for TP 2 as it allows the instructor to explain and demonstrate calculating magnetic declination while providing an opportunity for the cadets to practice calculating magnetic declination under supervision.

An in-class activity was chosen for TP 3 as it is an interactive way to reinforce calculating magnetic declination.

---

**INTRODUCTION**

---

**OBJECTIVES**

By the end of this lesson the cadet shall have calculated magnetic declination.

**IMPORTANCE**

It is important for cadets to know how to calculate magnetic declination and set it on a compass as it provides the cadet with confidence that they will arrive at their destination when navigating on a bearing. Not accounting for declination may affect navigation, as the cadet may travel off route. For every one degree of error in declination setting, a person would be approximately 52 m off of for every km travelled.

**Teaching Point 1****IAW M222.02 (Describe Bearings) Review Magnetic Declination and the Three Norths**

Time: 5 min

Method: Interactive Lecture



Magnetic declination was identified in M222.03 (Identify Compass Parts, A-CR-CCP-702/PF-001, Chapter 12, Section 3) however, it must be discussed again to support calculating magnetic declination.

**Magnetic Declination**

Magnetic declination is the difference between true north (map) and magnetic north (compass). It is caused by the different locations of the geographic north pole and the magnetic north pole plus any local anomalies such as iron deposits.

Map users will identify the declination in the marginal information through a declination diagram depicting the true, grid, and magnetic bearing of any line within the area of the map sheet.

Declination will change annually due to the shifting magnetic pole. There are only two lines in the northern hemisphere where magnetic and true north line up equalling declination of zero degrees. One line runs through central Canada and the other through Russia.

**Grid Magnetic Angle**

Grid magnetic angle is the horizontal angular difference between grid north and magnetic north. This is the number that is applied when converting from magnetic to grid bearings.

**Annual Magnetic Change**

Due to the dynamic forces on the earth, magnetic north continually migrates. Subsequently an annual adjustment/calculation must be made to obtain the correct grid angle at the date of use. The amount of adjustment, to be made, is provided in the declination diagram.

This change is significant as adjustments to a compass may be required. This is known as “setting the declination.” Bearings and directions taken from the map would not be accurate if the magnetic change is not taken into account. All maps have the required information to calculate the declination and this information is found in the margin of the map.



Review the three norths. This material was covered in M222.02 (Describe Bearings, A-CR-CCP-702/PF-001, Chapter 12, Section 2).

In navigation, there are three different norths – true north, grid north and magnetic north. Each north varies from each other and must be known for navigation. A diagram representing the three norths can be found in the margin of the map being used.



Draw Figure 13-2-1 on a visual aid and draw the symbol for each north as it is explained to the cadets.

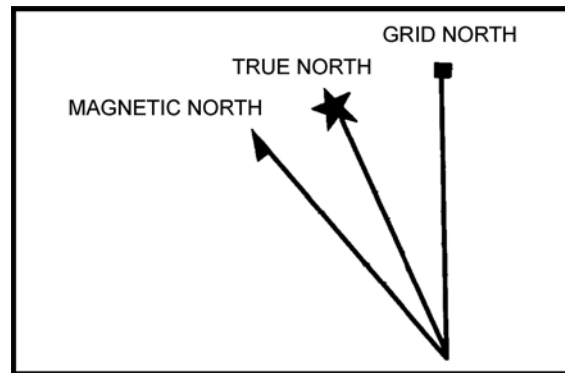

*B-GL-382-005/PT-001, Canadian Forces, Maps, Field Sketching, Compasses and the Global Positioning System (p. 51)*

Figure 13-2-1 Three Norths

**True North.** True north is located at the top of the earth where the geographic North Pole is found. It is the point at which the earth rotates on its axis and is where all lines of longitude meet. In the diagram on the map, true north is represented by a star (Polaris).

**Grid North.** Grid north is the north indicated by the grid lines (eastings) on a topographical map. Eastings are lines that run parallel to each other and will never meet at the North Pole; because of this, grid north points off slightly from true north. Grid north is symbolized by a square on the declination diagram.

**Magnetic North.** Magnetic north is the direction in which the compass needle points. This direction is to the magnetic pole which is located in the Canadian arctic and is slightly different from true north (North Pole). Magnetic north is symbolized by an arrow or half arrow head on the declination diagram.

---

### CONFIRMATION OF TEACHING POINT 1

---

#### QUESTIONS

- Q1. Explain true north.
- Q2. What symbol on a declination diagram represents magnetic north?
- Q3. What is annual magnetic change?

#### ANTICIPATED ANSWERS

- A1. It is the point at which the earth rotates on its axis. The geographic north pole or true north is located at the top of the earth where the lines of longitude converge. On a map, the direction of true north is shown by the lines of longitude. True north is symbolized by a star on the declination diagram.
- A2. Magnetic north is represented by an arrow.
- A3. Due to the dynamic forces on the Earth magnetic north continually migrates. Subsequently an annual adjustment/calculation must be made to obtain the correct grid angle at the date of use.

**Teaching Point 2****Demonstrate, Explain and Have the Cadet Practice  
Calculating Magnetic Declination**

Time: 20 min

Method: Interactive Lecture



Provide guidance to the cadets when learning to calculate magnetic declination. Use the provided steps and follow the sample calculations provided below.

**CALCULATE THE MAGNETIC DECLINATION****Locate the Declination Diagram and Information**

Calculating current declination uses the information provided by the declination diagram on a map and the information printed directly underneath. This diagram is most often found, on the right side of the map in the marginal information.

**Calculate Declination**

To calculate declination use the angle between magnetic north and grid north – ignoring true north. This is because bearings taken from a map use grid north as their point of reference. The annual change noted under the diagram will be either “increasing” (the declination is getting larger), or “decreasing” (getting smaller). The total annual change will then be added or subtracted from the declination printed on the map, to get the current declination.

The degree system of bearings shares some structure and terminology with units of time. There are:

- 360 degrees in a circle, written as **360°**,
- 60 minutes in a degree, written as **60'**, and
- 60 seconds in a minute, written as **60"**.

It is common to divide degrees into minutes, instead of seconds (eg, 1.5' instead of 1'30").

The steps to calculate magnetic declination are:

**Step 1.** Identify how long it has been since the map information was current by:

1. **Identifying the Current Year.** This is the actual current calendar year.
2. **Identifying Year of Declination Information.** This date is found under the declination diagram defined as the “approximate mean declination”.
3. **Recording the Difference in Years.** Subtract the approximate mean declination year from the current year.

**Step 2.** Determine how much declination has changed since the map was current by:

4. **Multiplying the Difference in Years by the Annual Change.** Take the difference in years and multiply it by the annual change.

**Step 3.** Update the map declination with the amount of change calculated by:

5. **Determining if the Annual Change is Increasing or Decreasing.** The annual change found under the declination diagram also indicates whether the annual change is increasing or decreasing in degrees and minutes.
6. **Adding or Subtracting the Annual Change from the Original Declination.** The original declination is found on the declination diagram. It is the numbers represented in minutes and degrees between grid north and magnetic north. Were the change is increasing add to the map declination, if the change is decreasing subtract from the map declination.

**Step 4.** Set the current declination on the compass by:

7. **Determining if Declination is East or West.** This determines what direction the declination must be set on a compass. East or west is determined by looking at the declination diagram and identifying true north and magnetic north. The side magnetic north falls on represents east or west declination. Right side is east, left side is west.
8. **Setting the Calculated Declination on a Compass.** On the back side of the compass there is a declination adjusting screw, adjust the declination adjusting screw to the calculated declination east or west.



The zero declination line (agonic line) runs west of Hudson Bay, near Churchill, Manitoba. Therefore, maps east of here can assume a declination to the west and maps west will assume a declination to the east.

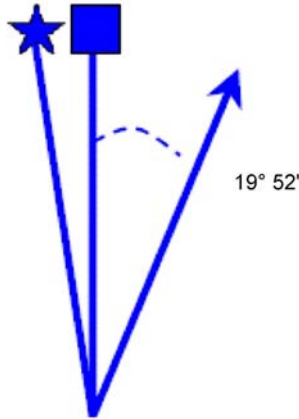

USE DIAGRAM TO OBTAIN NUMERIC VALUES  
 APPROXIMATE MEAN DECLINATION 1991  
 FOR CENTRE OF MAP  
 ANNUAL CHANGE (DECREASING) 7.0'

*Department of National Defence, Instructional Guide (IG) DP1—Cadet Instructors Cadre (CIC)  
 Environmental Performance Requirements—Land, Department of National Defence (p. 84)*

Figure 13-2-2 Declination Diagram Sample



When the declination is recorded in writing, it is written in degrees and minutes. Degrees is represented by a number followed by a small circular symbol (eg, 19°) The same is true for minutes as the number is followed by an apostrophe (eg, 52').

**Example With East Declination (Figure 13-2-2).** The declination as of 1991 is 19° 52' East and the annual change is decreasing 7.0'. The magnetic declination is calculated as:

Current year:	2010
Year of declination information:	<u>- 1991</u>
Difference in years:	19
Difference in years:	19
Annual change:	<u>x 7.0'</u>
Total change:	133' or 2° 13'



The total change is converted from 133' minutes to 2° 13' because there are 60' in a degree.

Annual change is decreasing so it is subtracted from the original declination:



Original declination:	E 19° 52'
Total change:	<u>- 2° 13'</u>
Current declination:	E 17° 39'

This tells us that the magnetic needle on a compass will point to the east of grid north by 17 degrees and 39 minutes, for the area depicted on this map in 2010.

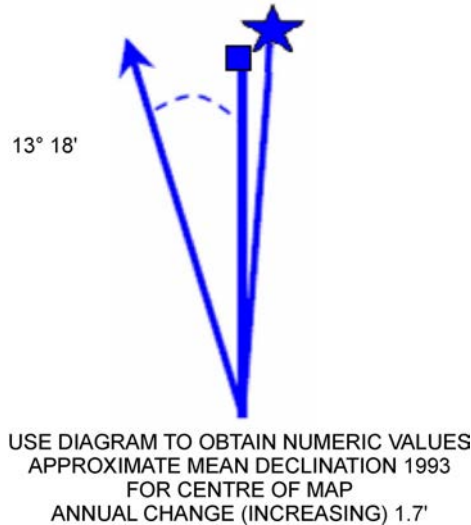

*Department of National Defence, Instructional Guide (IG) DP1—Cadet Instructors Cadre (CIC)  
Environmental Performance Requirements—Land, Department of National Defence (p. 84)*

Figure 13-2-3 Declination Diagram Sample



Convert to degrees and minutes when there are 60' (minutes) or more.

**Example With West Declination (Figure 13-2-3).** The declination as of 1993 is 13° 18' West and the annual change increasing 1.7'. The magnetic declination is calculated as:

Current year:	2010
Year of declination information:	<u>- 1993</u>
Difference in years:	17
Difference in years:	17
Annual change:	<u>x 1.7'</u>
Total change:	28.9'

Annual change is increasing so it is added to the original declination:

Original declination:	W 13° 18'
Total change:	+ <u>28.9'</u>
Current declination:	W 13° 46.9' (rounded to 47)



Round minutes up or down as required during calculations. (eg, at or over 0.5 minutes round up, under 0.5 minutes round down).

This tells us that the magnetic needle on a compass will point to the west of grid north by 13 degrees and 47 minutes, for the area depicted by this map in 2010.

It is possible to have a very small original declination and a larger total annual change, so that when calculated the current declination actually changed from what was originally a West declination to an East declination, or vice versa.



When subtracting, there are times when the equation cannot be completed without borrowing from the next figure in the line.

$$\begin{array}{r} 13^{\circ} 12' \\ - 45' \\ \hline \end{array}$$

To complete this equation, one degree (sixty minutes) must be borrowed from 13° to allow subtraction from 12'. When borrowing a degree (1° equals 60') reduce the degree portion by one and add 60' to the minute numbers.

$$\begin{array}{r} 12^{\circ} 72' \\ - 45' \\ \hline = 12^{\circ} 27' \end{array}$$

The equation can now be completed as seen above.

---

## CONFIRMATION OF TEACHING POINT 2

---

### QUESTIONS

- Q1. Where is the declination diagram found on a topographical map?
- Q2. How many minutes are in a degree?
- Q3. When the annual change is decreasing what difference will this make to your calculations?

### ANTICIPATED ANSWERS

- A1. The declination diagram is located on the right side of the map in the marginal information.
- A2. There are 60 minutes.
- A3. When the annual change is decreasing it is subtracted from the original declination.

---

**Teaching Point 3****Have the Cadet Calculate Magnetic Declination Using East and West Declination Examples**

Time: 30 min

Method: In-Class Activity

---

---

**ACTIVITY**

---

**OBJECTIVE**

The objective of this activity is to have the cadets practice calculating magnetic declination.

**RESOURCES**

Declination problem worksheet located at Annex A.

**ACTIVITY LAYOUT**

N/A.

**ACTIVITY INSTRUCTIONS**

1. Distribute a worksheet to each cadet.
2. Have the cadets individually complete as many problems on the worksheet as possible in 20 minutes.
3. Correct the declination worksheet with the cadets using the answer key located at Annex B.
4. Answer questions, and calculate declination on a visual aid to clarify questions.

**SAFETY**

N/A.

---

**CONFIRMATION OF TEACHING POINT 3**

---

The cadets' participation in the in-class activity will serve as the confirmation of this TP.

---

**END OF LESSON CONFIRMATION**

---

The cadets' calculation of magnetic declination will serve as the confirmation of this lesson.

---

**CONCLUSION**

---

**HOMEWORK/READING/PRACTICE**

Cadets are encouraged to complete or retry any problems that they have experienced trouble with.

**METHOD OF EVALUATION**

This EO will be assessed IAW A-CR-CCP-703/PG-001, Chapter 3, Annex B, Appendix 5 (322 PC).

## **CLOSING STATEMENT**

Knowing how to calculate magnetic declination adds to basic map and compass skills and will allow cadets to plan route marches and navigate confidently during field training exercises. Calculating magnetic declination builds on the essential navigation skills required of a cadet in the expedition stream.

## **INSTRUCTOR NOTES/REMARKS**

Cadets may use a calculator for calculating declination.

---

## **REFERENCES**

---

A2-041 B-GL-382-005/PT-001 Canadian Forces. (2006). *Maps, Field Sketching, Compasses and the Global Positioning System*. Ottawa, ON: Department of National Defence.



**ROYAL CANADIAN ARMY CADETS**  
**SILVER STAR**  
**INSTRUCTIONAL GUIDE**



**SECTION 3**

**EO M322.03 – IDENTIFY COMPONENTS OF THE GLOBAL POSITIONING SYSTEM (GPS)**

---

Total Time: 30 min

---

**PREPARATION**

---

**PRE-LESSON INSTRUCTIONS**

Resources needed for the delivery of this lesson are listed in the lesson specification located in A-CR-CCP-703/PG-001, Chapter 4. Specific uses for said resources are identified throughout the instructional guide within the TP for which they are required.

Review the lesson content and become familiar with the material prior to delivering the lesson.

**PRE-LESSON ASSIGNMENT**

N/A.

**APPROACH**

An interactive lecture was chosen for this lesson to orient the cadets to the components of the GPS and to present background material.

---

**INTRODUCTION**

---

**REVIEW**

N/A.

**OBJECTIVES**

By the end of this lesson the cadet shall have identified the components of the GPS.

**IMPORTANCE**

It is important for cadets to be able to identify the components of the GPS so they have the background knowledge and information required to effectively operate a GPS receiver when navigating.

**Teaching Point 1****Discuss the GPS**

Time: 10 min

Method: Interactive Lecture



Determine the level of understanding cadets have of the GPS by carrying out a short discussion.

It is expected that most cadets will assume the GPS is the unit a person looks at to determine position. Prior to moving to TP 2 ensure cadets understand that the GPS is a constellation of satellites and is comprised of many components.

**WHAT THE GPS IS**

Global Navigation Satellite System (GNSS) is the generic term for satellite navigation systems that provide autonomous geo-spatial positioning with global coverage. The Global Positioning System (GPS) is a constellation of satellites, ground stations and receivers created, owned and operated by the United States. This system is used to navigate and enables anyone with a GPS receiver to know where they are 24 hours a day in any kind of weather.

The GPS is a group of 21 satellites (and three spares) that orbits the Earth and sends radio signals from their positions above the Earth back to Earth's surface. A GPS receiver is an electronic device that detects the radio signals from the satellites and calculates the receiver's position on the Earth. It is capable of giving location, speed, time and altitude.

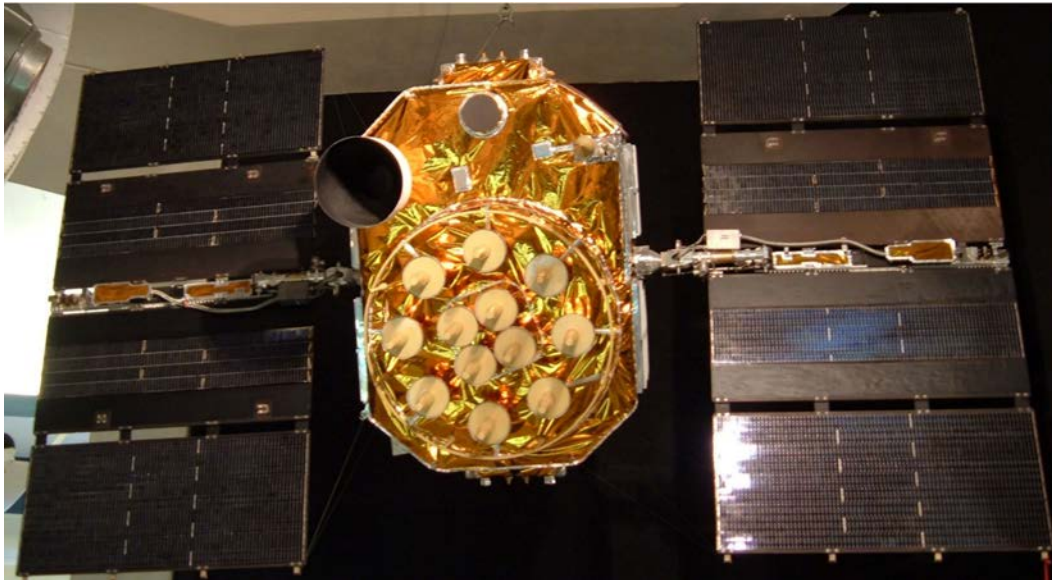

*"Wikipedia", Global Positioning System Satellite. Retrieved March 27, 2008, from [http://en.wikipedia.org/wiki/Image:Global\\_Positioning\\_System\\_satellite.jpg](http://en.wikipedia.org/wiki/Image:Global_Positioning_System_satellite.jpg)*

Figure 13-3-1 GPS Satellite

The United States GPS is not the only satellite navigation system currently deployed in space. Other nations that have begun or have established a similar satellite navigation system are:

- European Union – GALILEO Satellite System,
- Russian – GLONASS System, and

- Chinese – Beidou System.

## HOW THE GPS WORKS

The system is divided into three parts or segments: space, ground control and users. The space segment consists of 24 satellites that orbit 20 200 km above the Earth and send radio signals toward Earth. The radio signals broadcast the position of each satellite in the sky with an electronic code.

Each satellite performs a relatively simple primary task: it transmits a timing signal using its built-in atomic clock. When a device on the ground receives that signal, it can determine its distance from the satellite.

That single measurement alone does not accomplish much, but when a GPS receiver collects timing signals from three different satellites the receiver can determine two precise coordinates: latitude and longitude. With four satellite signals, the GPS receiver is able to determine altitude as well.



A GPS receiver is also capable of determining more than latitude, longitude, and altitude. It can also determine other variables such as speed and heading.

## COMPONENTS OF THE GPS

### Satellites

The GPS and its satellites have the following characteristics:

- The minimum number of satellites that are required to cover the entire Earth is 18, however the number of satellites in orbit fluctuates between 24 and 29 satellites due to spares and upgrading.
- Satellites orbit in a semi-synchronous orbit (orbits are coordinated, but not identical).
- Each satellite completes an orbit every 12 hours.
- Satellites orbit the Earth at 20 200 km (12 552 miles) (airplanes routinely fly at 11–13 km [37 000–43 000 feet], the shuttle orbits at 370 km [230 miles]).
- Each satellite has three key pieces of hardware:
  - **Computer.** Controls its flight and order functions.
  - **Atomic Clock.** Keeps accurate time within three nanoseconds (approximately three-billionths of a second).
  - **Radio Transmitter.** Sends signals to Earth.

### Ground Stations

The ground control segment of the GPS is comprised of five ground stations that track the satellites, monitor their condition and make any necessary adjustments to keep the system accurate. The entire system functions and is monitored by the US Department of Defence. Information from the stations are sent to a master control station – the Consolidated Space Operations Centre (CSOC) at Schriever Air Force Base in Colorado where the data is processed and adjustments are made. The five ground stations are in Hawaii, Colorado, Diego Garcia, Ascension Island and Kwajalein.

### Receivers

GPS receivers make up the user segment. It is the GPS receiver, whether it is in an airplane, a truck, a boat or in a hiker's hand, that detects the radio signals from the satellites and calculates the receiver's position.

When a receiver is turned on, it interprets the radio signals and extracts the satellite location information. The GPS signal broadcasts information that tells the receiver the location of each satellite in the system. The receiver then interprets the radio signal to determine the exact time. This is required to calculate position.

The orbits of the GPS satellites ensure that there will be a minimum of four satellites covering any spot on the globe at all times. The receiver uses the signal from one satellite to continuously monitor and be synchronized with the time maintained by the other satellites. The receiver collects the signals from the other satellites and calculates the difference between them. This calculation positions the receiver from each satellite and triangulates its location. Based on a four satellite fix, the receiver will identify location giving the user latitude, longitude and altitude (altitude is only possible with a four satellite fix).

---

## CONFIRMATION OF TEACHING POINT 1

---

### QUESTIONS

- Q1. What does GPS stand for?
- Q2. What are ground stations responsible for?
- Q3. How does a receiver calculate your position?

### ANTICIPATED ANSWERS

- A1. GPS stands for Global Positioning System.
- A2. Ground stations are responsible for tracking the satellites, monitoring their condition and making any necessary adjustments to keep the system accurate.
- A3. The receiver uses the signal from one satellite to continuously monitor and be synchronized with the time maintained by the satellites. The receiver collects the signals from the other satellites and calculates the difference between them. This calculation positions the receiver from each satellite and triangulates its location. This location gives the user latitude, longitude and altitude.

---

### Teaching Point 2

### Explain GPS Terminology

Time: 5 min

Method: Interactive Lecture

---



As cadets are introduced to and continue to use GPS receivers they may encounter the following terms. Explain the terms to the cadets and give examples where possible.

**GPS.** Global Positioning System, a constellation of 21 satellites (and three spares) used to determine location, speed, time and altitude.

**Three-Dimensional (3D) Coordinate.** Requires a four satellite signal lock, giving a position as determined by latitude, longitude, and altitude.

**Assisted GPS (A-GPS).** GPS with assistance from cellular technology. Found mostly in new GPS-equipped phones. A-GPS relies on cellular networks to help do some of the tracking because GPS signals will not penetrate indoors.

**Differential GPS (DGPS).** A stationary receiver working in conjunction with the satellites to correct errors in the timing signals, resulting in a more precise measurement of location.



**Latitude.** Imaginary parallel horizontal lines encircling the Earth, measuring 90 degrees north and 90 degrees south from the equator. The line at the equator represents zero degrees of latitude.

**Longitude.** Imaginary vertical lines running from the North Pole to the South Pole. The prime meridian (zero degrees longitude) runs through Greenwich, England, and serves as the reference line from which longitude is measured. Latitude and longitude create a grid covering the planet from which one can extrapolate coordinates.

**Triangulation.** What GPS receivers do to determine position based on data received from three or more GPS satellites.

**Wide Area Augmentation Service (WAAS).** Improves GPS accuracy and availability. WAAS was designed with aviation in mind as it improves a GPS receiver's accuracy to within three metres.

**Waypoint.** An intermediate position between the starting and destination points along a navigational route. If one makes three stops along the route to the final destination, the GPS receiver will consider each one of these stops a waypoint.

---

## CONFIRMATION OF TEACHING POINT 2

---

### QUESTIONS

- Q1. What is a 3D coordinate?
- Q2. What is triangulation?
- Q3. What is a waypoint?

### ANTICIPATED ANSWERS

- A1. A 3D coordinate is one's position as determined by latitude, longitude, and altitude.
- A2. Triangulation is what a GPS receiver does to determine position based on data received from three or more GPS satellites.
- A3. A waypoint is an intermediate position between the starting and destination points along a navigational route.

---

### Teaching Point 3

### Discuss GPS Receivers and the Information They Provide

Time: 10 min

Method: Interactive Lecture

The GPS receiver is a piece of equipment that processes the signals sent from satellites. The information the receiver calculates from the signals can be used in many ways.

### ACCURACY

The accuracy of a GPS receiver depends on the number of satellites from which signals are being received, and the use of augmentation systems. A GPS receiver without WAAS measures to an accuracy of 5 m (16.4 feet) 95 percent of the time, and with WAAS to an accuracy of 3 m (9.8 feet).

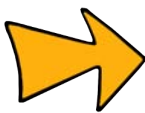

WAAS is most often found on GPS receivers for aircraft. Landing safely in fog is difficult without an accurate location of the runway.

## TIME

A GPS receiver receives time information from atomic clocks, so it is more accurate than a wristwatch. Receivers report a variety of times as navigation statistics, to include:

- **Estimated Time of Arrival (ETA).** The ETA is the time of day one will arrive at the destination (eg, 1230 hrs).
- **Estimated Time Enroute (ETE).** ETE tells how much longer one must travel before arriving at the destination and is measured in minutes or hours.



ETA and ETE are only useful when travelling in a straight line like in a boat or on a plane. However if a route is planned with waypoints to guide the route, the ETA and ETE timings will be accurate to follow.

- **Trip Time.** Also known as elapsed time, the trip timer measures time from the last time it was reset. This can be used to calculate average speed because it continues counting time regardless if a person is moving or not.
- **Time Moving.** The amount of time that speed is not zero. When you come to a stop, the timer stops counting. The time moving is used to calculate the average moving speed.
- **Time Not Moving.** The time not moving timer counts only when you are standing still. It represents the time you sit motionless. If the times on the time moving and the time not moving timers are added together, they should equal the trip timer.
- **Time of the Day.** All receivers provide the time of the day. The GPS satellites keep what is known as GPS time.

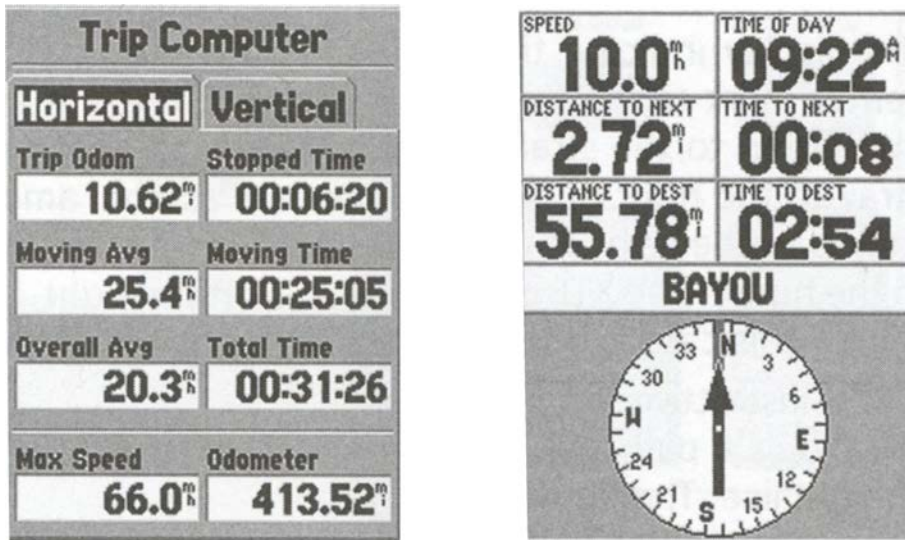

L. Letham, *GPS Made Easy (4<sup>th</sup> ed.)*, *The Mountaineers* (p. 54–55)

Figure 13-3-2 Time Screens

## LOCATION

GPS provides location in three dimensions:

- latitude (X-coordinate),
- longitude (Y-coordinate), and

- altitude.

The location can be displayed in a number of coordinate systems (eg, latitude/longitude, Universal Transverse Mercator [UTM]).



The altitude calculation of a consumer GPS receiver is not very accurate (+/- 15 m [49.2 feet]).

## SPEED

A receiver measures the time and distance between the point where a person is and the point where the person was a short time ago, then divides the distance by the time it takes to travel there (speed = distance/time). Some of the speed statistics are:

- **Speed Over Ground (SOG).** The SOG (also known as ground speed) is just like the speed displayed by the speedometer in a car. It measures how fast you are going at that moment. Speed does not take into consideration if you are on course. It is a measurement of speed regardless of direction.
- **Velocity Made Good (VMG).** The speed at which the destination is approached. VMG takes into account the present course and destination.
- **Average Speed.** Divides the distance by the amount of time it took to travel that distance.
- **Average Moving Speed.** The average speed excluding the time the receiver stands still.
- **Maximum Speed.** The fastest speed travelled during the trip.
- **Vertical Speed.** The instantaneous speed measured for up and down movements only.
- **Average Ascent and Descent.** Much like average speed, the average ascent and descent is the distance of vertical movement divided by the amount of time to make the movement. It is the average rate of change in altitude.
- **Maximum Ascent and Descent.** The maximum rate of a vertical change in position.

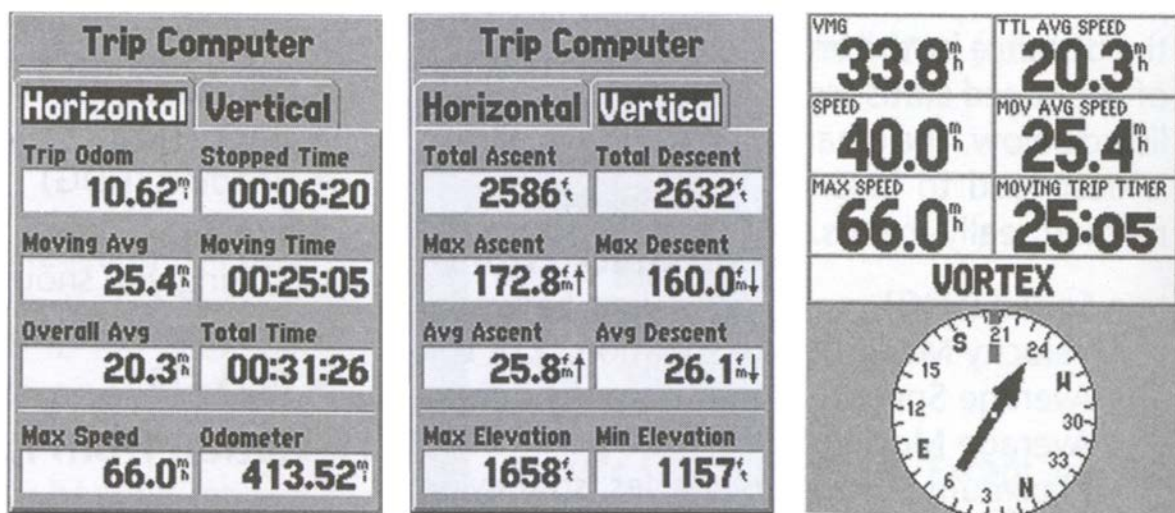

*L. Latham, GPS Made Easy (4th ed.), The Mountaineers (p. 54–55)*

Figure 13-3-3 Speed Screens

## **DIRECTION OF TRAVEL**

A GPS receiver can display the direction of travel if the receiver is moving. If the unit is stationary, it can not use satellite signals to determine which direction a person is facing.

Some GPS units have a electronic compass that shows the direction the receiver is pointed, whether moving or standing still. All directions calculated by a receiver can be expressed as a bearing or in degrees.

## **STORED LOCATION**

Locations can be stored in the GPS receiver. It can store where a person has been and where a person wants to go. These location positions are waypoints. A GPS receiver can provide a person with directions and information on how to get to a waypoint.

## **CUMULATIVE DATA**

A GPS receiver can keep track of information such as the route travelled, total distance travelled, average speed, minimum speed, elapsed time, and time to arrival at a specific location.

---

### **CONFIRMATION OF TEACHING POINT 3**

---

#### **QUESTIONS**

- Q1. What is the accuracy of a GPS receiver without WAAS?
- Q2. What three dimensions will a GPS receiver report location in?
- Q3. How does a GPS receiver calculate speed?

#### **ANTICIPATED ANSWERS**

- A1. A GPS receiver without WAAS measures to an accuracy of 5 m, 95 percent of the time.
- A2. A GPS receiver provides location in the following three dimensions:
- latitude (X-coordinate),
  - longitude (Y-coordinate), and
  - altitude.
- A3. A GPS receiver measures the time and distance between the point where a person is and the point where the person was a short time ago then divides the distance by the time it takes to travel there (speed = distance/time).

---

### **END OF LESSON CONFIRMATION**

---

#### **QUESTIONS**

- Q1. What is the GPS?
- Q2. What is triangulation?
- Q3. What is a waypoint?

**ANTICIPATED ANSWERS**

- A1. The GPS is a constellation of 24 satellites orbiting the Earth, receivers and ground stations. They are used to determine location, speed and time.
- A2. Triangulation is what GPS receivers do to determine their position based on data received from three or more GPS satellites.
- A3. A waypoint is an intermediate position between the starting and destination points along a navigational route. If one makes three stops along the route to the final destination, the GPS receiver will consider each one of these stops a waypoint.

---

**CONCLUSION**

---

**HOMEWORK/READING/PRACTICE**

N/A.

**METHOD OF EVALUATION**

N/A.

**CLOSING STATEMENT**

GPS training will introduce cadets to a new tool to use while navigating. The GPS is a technological advancement that is continuously evolving to present new ways and methods of navigating. As these advances become available for the Cadet Program, cadets will be challenged to learn and apply them while navigating.

**INSTRUCTOR NOTES/REMARKS**

It is recommended that this EO be instructed outside.

---

**REFERENCES**

---

- C2-142 (ISBN 0-7645-6933-3) McNamara, J. (2004). *GPS for Dummies*. Hoboken, NJ: Wiley Publishing, Inc.
- C2-143 (ISBN 1-58923-145-7) Featherstone, S. (2004). *Outdoor Guide to Using Your GPS*. Chanhassen, MN: Creative Publishing International, Inc.
- C2-144 (ISBN 0-07-223171-8) Broida, R. (2004). *How to Do Everything With Your GPS*. Emerville, CA: McGraw-Hill.

THIS PAGE INTENTIONALLY LEFT BLANK



**ROYAL CANADIAN ARMY CADETS**  
**SILVER STAR**  
**INSTRUCTIONAL GUIDE**



**SECTION 4**

**EO M322.04 – IDENTIFY FEATURES OF A GLOBAL POSITIONING SYSTEM (GPS) RECEIVER**

Total Time:

30 min

**PREPARATION**

**PRE-LESSON INSTRUCTIONS**

Resources needed for the delivery of this lesson are listed in the lesson specification located in A-CR-CCP-703/PG-001, Chapter 4. Specific uses for said resources are identified throughout the instructional guide within the TP for which they are required.

Review the lesson content and become familiar with the material prior to delivering the lesson.

Ensure GPS receivers are available and ready to use (eg, batteries charged).

**PRE-LESSON ASSIGNMENT**

N/A.

**APPROACH**

An interactive lecture was chosen for TP 1 to orient the cadets to components of a GPS receiver and to present background material.

Demonstration and performance was chosen for TP 2 as it allows the instructor to explain and demonstrate how to scroll through the different screen pages of a GPS receiver while providing an opportunity for the cadets to practice under supervision.

**INTRODUCTION**

**REVIEW**



Choose three to five of the questions provided to review the material covered in EO M322.03 (Identify Components of the Global Positioning System [GPS], Section 3). If additional review is required to confirm understanding, continue with questions. Be mindful of the time remaining to complete this lesson.

**QUESTIONS**

- Q1. What does the acronym GPS stand for?
- Q2. What are ground stations responsible for?
- Q3. How does a receiver calculate your position?

- Q4. What is a 3D coordinate?
- Q5. What is triangulation?
- Q6. What is a waypoint?
- Q7. What is the accuracy of a GPS receiver without WAAS?
- Q8. What three dimensions will a GPS receiver provide location in?
- Q9. How does a GPS receiver calculate speed?

### **ANTICIPATED ANSWERS**

- A1. GPS stands for Global Positioning System.
- A2. Ground stations are responsible for tracking the satellites, monitoring their condition and making any necessary adjustments to keep the system accurate.
- A3. The receiver uses the signal from one satellite to continuously monitor, and be synchronized with, the time maintained by the satellites. The receiver collects signals from the other satellites and calculates the difference between them. This calculation positions the receiver from each satellite and triangulates its location. This location gives the user latitude, longitude and altitude.
- A4. A 3D coordinate is one's position as determined by latitude, longitude, and altitude.
- A5. Triangulation is what a GPS receiver does to determine position based on data received from three or more GPS satellites.
- A6. A waypoint is an intermediate position(s) between the starting and destination points along a navigational route.
- A7. A GPS receiver without WAAS measures to an accuracy of 5 m, 95 percent of the time.
- A8. A GPS receiver provides location in the following three dimensions:
- latitude (X coordinate),
  - longitude (Y coordinate), and
  - altitude.
- A9. To calculate speed a GPS receiver measures the time and distance between the point where a person was and the point where the person is and then divides the distance by the time to get to that speed (speed = distance/time).

### **OBJECTIVES**

By the end of this lesson the cadet shall have identified features of a GPS receiver.

### **IMPORTANCE**

It is important for cadets to know the features of a GPS receiver because GPS receivers will be used during expeditions for navigation and planning. The GPS is a navigational aid that will be used regularly.



**Teaching Point 1****Identify and Briefly Describe Components of a GPS Receiver**

Time: 10 min

Method: Interactive Lecture



Distribute GPS receivers. If there is not a receiver for each cadet, divide the cadets into groups so they may share.

Allow cadets to practice locating the information and pages being discussed.



The two terms “Point of Interest” and “Waypoints” mean the same thing – an intermediate position on a navigation map. In this lesson, the term “Point of Interest” will be used.

**COMPONENTS OF A GPS RECEIVER**

**Antenna.** Allows the GPS receiver to receive satellite signals.

**Screen.** Displays information.



Some GPS receivers use an arrow joystick that acts as a mouse, providing a simple to use interface with the GPS receiver.

**Battery Compartment.** Stores the receiver power supply.



The buttons in the following list are found on the Magellan eXplorist 200 GPS receiver. Other makes and models of GPS receivers may have different function buttons. Consult user manual for GPS receiver button functions.

**BUTTONS**

**On/Off.** Turns the receiver on and off.

**Backlight.** Turns the display backlight on and off and changes intensity.

**Enter.** Used to access highlighted menu items or highlighted page menu options.

**Escape.** Cancels, data inputs. Closes the accessed function and goes back to the previous screen and moves backward through the navigation screens.

**Zoom In.** Used on the map screen to zoom in on the map displayed. The map display can be zoomed in to 35 m (100 feet). Also used to move through the list of waypoints when using an alphabetical search.

**Zoom Out.** Used on the map screen to zoom out on the map displayed. The map display can be zoomed out to 2736 km (1700 miles). Also used to move through the list of waypoints when using an alphabetical search.

**Menu.** Displays a menu with available options. Options may be selected by using the arrow joystick to highlight the option and pressing “enter” to access it.

**NAV.** Moves through the navigation screens (Map screen, Compass screen, Position screen, Satellite screen).

**Mark.** Used to save present position as a waypoint. Waypoints are saved and stored in “My Points of Interest”.

**GOTO.** Creates a one-leg route from the present position to a destination selected from the POI database or by using the cursor on the background map and pressing GOTO on a point.

**Arrow Joystick.** Moves the cursor on the map screen. It also moves the highlighted bar to select menu options and data-entry fields.



*Thales Navigation, Inc. Magellan eXplorist 200 Reference Manual, Thales Nav, Inc. (p. 1)*

Figure 13-4-1 eXplorist 200 GPS Receiver

---

### CONFIRMATION OF TEACHING POINT 1

---

#### QUESTIONS

Q1. Name three components of a GPS receiver.

Q2. What is the purpose of the NAV button on the GPS receiver?

Q3. What is the GOTO button used for on the GPS receiver?

### ANTICIPATED ANSWERS

A1. Three components of a GPS receiver may be any of the following:

- antenna,
- screen,
- battery compartment, and
- buttons, to include:
  - on/off,
  - backlight,
  - enter,
  - escape,
  - zoom in,
  - zoom out,
  - menu,
  - NAV,
  - mark,
  - GOTO, and
  - arrow joystick.

A2. The NAV button moves through the navigation screens (Map screen, Compass screen, Position screen, Satellite screen).

A3. The GOTO button creates a one-leg route from the present position to a destination selected from the POI database or by using the cursor on the background map.

---

### Teaching Point 2

### Explain and Have the Cadets Scroll Through the Screen Pages on a GPS Receiver

Time: 15 min

Method: Demonstration and Performance

---



GPS receivers may differ in the way they present information, from unit to unit. Identify the screens that are similar to those contained in this TP, and have the cadets practice finding the different pages and the information they display.

Allow the cadets time to become familiar with the GPS receiver and its functions.

**Note:** The term “Page” refers to the different screens an operator can scroll through to locate different information in a GPS receiver.

## SATELLITE STATUS

The satellite status screen displays the acquisition of satellites (satellite signal strength and satellite geometry) and the progress of the collection of satellite data. The receiver is constantly monitoring satellites. The display on the satellite status page graphically depicts the activity.

As new satellites come into view, a new bar appears in the graph. Bars that were solid minutes ago disappear as satellites pass over the horizon. If a satellite is being monitored but not used, the bar will appear hollow. On Wide Area Augmentation System (WAAS) enabled GPS receivers, the WAAS satellite signal strength is indicated on its own bar on the graph. On this page it is common for GPS receivers to display the following information:

- satellite signal strengths,
- battery strength, and
- estimated position error (EPE).

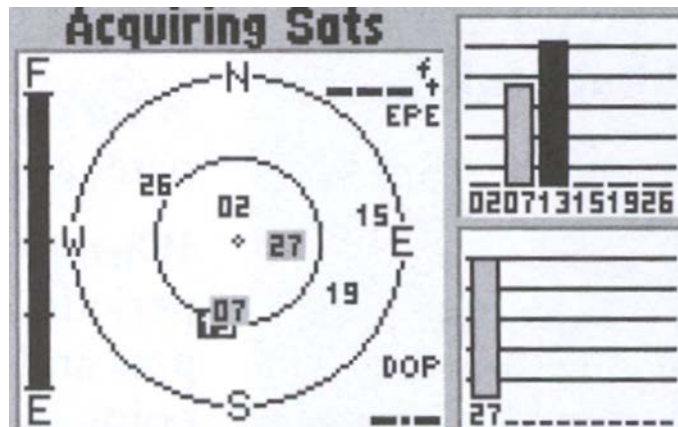

*S. Featherstone, Outdoor Guide to Using Your GPS, Creative Publishing International, Inc. (p. 45)*

Figure 13-4-2 Satellite Status Page

## MENU

This page is used for customizing the GPS receiver. All data fields can be changed to give a person the information they require including waypoints, routes, time and speed, etc. On this page it is common for GPS receivers to display the following information:

- customization options for the GPS receiver,
- waypoints and routes, and
- map datum.

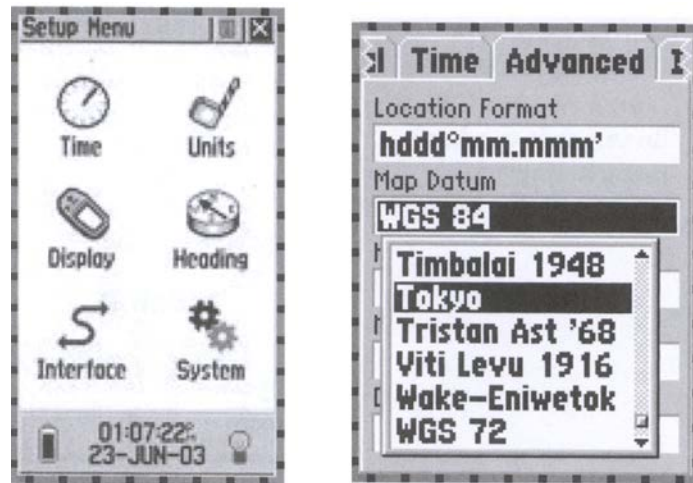

*S. Featherstone, Outdoor Guide to Using Your GPS, Creative Publishing International, Inc. (p. 54)*

Figure 13-4-3 Menu Page

## POSITION

The position page is used for confirming coordinates, datum, time, date, and the EPE. This page is used infrequently, for brief periods, mostly in planning and after marking a waypoint. No easy-to-understand graphics, like a compass rose, are displayed. This page is not ideally laid out for user-friendly navigation.

After acquiring enough satellites to begin navigating, many GPS receivers automatically go to the position page or the map page. In addition to the information mentioned above, an operator may find current speed, heading and a trip odometer. On some GPS receivers the information displayed can be changed.

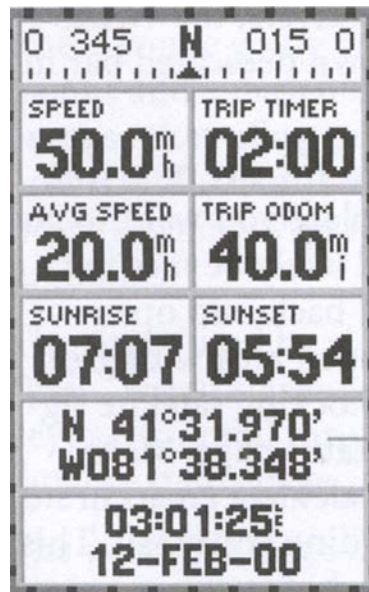

*S. Featherstone, Outdoor Guide to Using Your GPS, Creative Publishing International, Inc. (p. 46)*

Figure 13-4-4 Position Page

## COMPASS NAVIGATION

This page shows the direction of travel (track) as it relates to the direction of the destination (bearing). It will show the distance from the destination and time to the destination. This page is used frequently when navigating from point to point and for navigating around obstacles.



The digital compass graphic should not be confused with a real compass. Although they look the same, it can give a very different reading because without movement GPS receivers cannot display direction. Read the owners manual and determine if the compass is an electronic compass capable of identifying a compass heading while the operator is standing still.



*S. Featherstone, Outdoor Guide to Using Your GPS, Creative Publishing international, Inc. (p. 47)*

Figure 13-4-5 Compass Navigation Page

## MAP

This page identifies position. A GPS without a built-in map will identify where a person is in relation to another waypoint. A GPS receiver with a built-in map will identify where a person is in relation to landmarks, such as roads, cities and bodies of water. A GPS receiver with downloadable maps will identify where a person is in relation to city streets and topographical features.

The advantage of this screen is its ability to identify the current position by looking at the features on a map rather than just the coordinates. Depending on the zoom level – which is shown at the bottom of the page – these features could be roads or cities or entire continents.

The map page allows an operator to pinpoint where one is and create a waypoint on the map the cursor over a feature and pressing “enter” or “mark”, making route building easier. The map page can also serve as an address book. By moving the cursor over a certain waypoint and pressing “enter”, information is displayed, such as phone numbers, addresses, and navigation information.



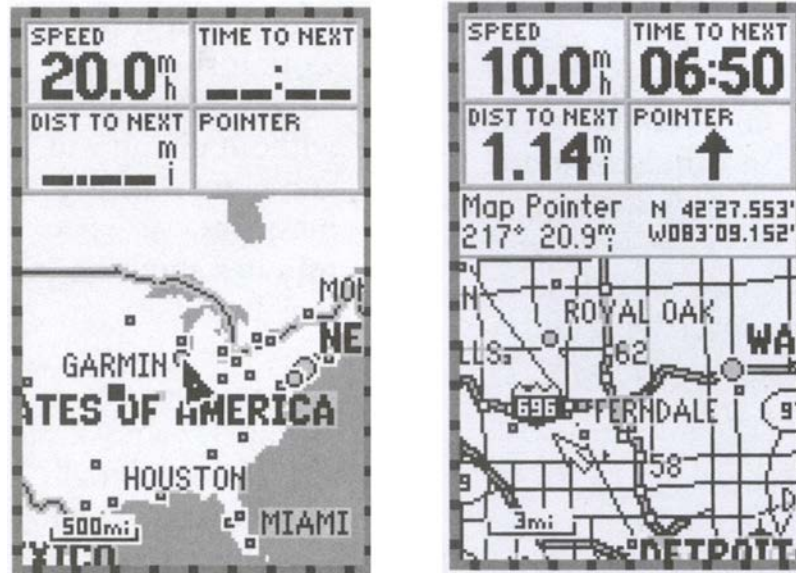

*S. Featherstone, Outdoor Guide to Using Your GPS, Creative Publishing International, Inc. (p. 50)*

Figure 13-4-6 Map Page

---

## CONFIRMATION OF TEACHING POINT 2

---

### QUESTIONS

- Q1. Where is the battery strength information located?
- Q2. What is the possible problem of using a GPS digital compass for navigating?
- Q3. Which screen identifies the coordinates and datum of the GPS?

### ANTICIPATED ANSWERS

- A1. The satellite status page identifies the battery strength information.
- A2. The possible problem of using a GPS digital compass for navigating is if the navigator is standing still some GPS receivers cannot display direction. It only knows how to identify direction when moving.
- A3. The position page identifies the coordinates and datum.

---

## END OF LESSON CONFIRMATION

---

### QUESTIONS

- Q1. What does the menu button display on the GPS receiver?
- Q2. On a GPS receiver's compass navigation page what information can you expect to find?
- Q3. On a GPS receiver's satellite status page what information can you expect to find?

### ANTICIPATED ANSWERS

- A1. The menu button displays a menu with available options. Options can be selected by using the arrow joystick to highlight the option and pressing "enter" to access it.
- A2. On the compass navigation page, a person can expect to find the following information:

- direction of travel,
- bearing,
- distance from destination,
- CDI, and
- time to destination.

A3. On the satellite status page a person can expect to find the following information:

- satellite signal strengths,
- battery strength, and
- EPE.

---

### CONCLUSION

---

### HOMEWORK/READING/PRACTICE

N/A

### METHOD OF EVALUATION

This EO is assessed IAW A-CR-CCP-703/PG-001, Chapter 3, Annex B, Appendix 5 (322 PC).

### CLOSING STATEMENT

GPS receivers have become a very common tool for navigating. Receivers vary from make to model, each offering its own method of use. By identifying the common features offered on a GPS receiver, cadets will be familiar with the information a GPS receiver can provide. Cadets who have an understanding of this information should be able to retrieve the required information from any make or model of GPS receiver.

### INSTRUCTOR NOTES/REMARKS

N/A.

---

### REFERENCES

---

- C2-142 (ISBN 0-7645-6933-3) McNamara, J. (2004). *GPS for Dummies*. Hoboken, NJ: Wiley Publishing, Inc.
- C2-143 (ISBN 1-58923-145-7) Featherstone, S. (2004). *Outdoor Guide to Using Your GPS*. Chanhassen, MN: Creative Publishing International, Inc.





**ROYAL CANADIAN ARMY CADETS**  
**SILVER STAR**  
**INSTRUCTIONAL GUIDE**



**SECTION 5**

**EO M322.05 – SET A MAP DATUM ON A GLOBAL POSITIONING SYSTEM (GPS) RECEIVER**

---

Total Time: 60 min

---

**PREPARATION**

---

**PRE-LESSON INSTRUCTIONS**

Resources needed for the delivery of this lesson are listed in the lesson specification located in A-CR-CCP-703/PG-001, Chapter 4. Specific uses for said resources are identified throughout the instructional guide within the TP for which they are required.

Review the lesson content and become familiar with the material prior to delivering the lesson.

Photocopy and create OHP slides of Annexes C and D.

Photocopy Annex E and distribute to each cadet.

Ensure there is a GPS receiver and topographical map of the area for each group in TP 2.

**PRE-LESSON ASSIGNMENT**

N/A.

**APPROACH**

An interactive lecture was chosen for TPs 1–3 to orient the cadets to map datums.

Demonstration and performance was chosen for TP 2 as it allows the instructor to explain and demonstrate how to set a map datum while providing an opportunity for the cadets to practice under supervision.

---

**INTRODUCTION**

---

**REVIEW**

N/A.

**OBJECTIVES**

By the end of this lesson the cadet shall have identified map datum on a topographical map and set it on a GPS receiver.

**IMPORTANCE**

It is important for cadets to know how to set a map datum because if an incorrect datum is set on the GPS receiver and the user identifies the coordinates from a GPS receiver on a map, an incorrect location will be given.

**Teaching Point 1****Explain Map Datum**

Time: 10 min

Method: Interactive Lecture

**MODEL PROJECTION OF THE EARTH**

The Earth is represented in many different forms including models, globes, maps, atlases, etc. When these items are designed they are drawn using a reference point called datum.



**Map Datum.** The reference point used to draw a map.

All maps are drawn using a reference point. A grid is a series of lines on a map that helps describe a location in reference to the datum point. A map can have several grids, but only one datum. If one were to consider a map to be a two-dimensional picture of the ground covered by a grid, the datum tells where to line up the grid on the map – the grid represents the lines of latitude and longitude used to define a location on a map.

Most datums only cover a portion of the earth. The North American Datum of 1927 (NAD-27), covers only the continent of North America. There are many different kinds of datum in the world and each country may use a different datum to draw maps. Countries often issue maps that have been created using a different datum to describe their own land area.



Depending on the datum used, the coordinates you read can differ by almost 200 m.

Datums are important to the user because if the datum in the GPS receiver does not match the map's datum, the coordinates will look the same but be describing two different places on the map.



When using a GPS receiver, any time a coordinate is plotted using a map or manually inputted from some other source, change the GPS receiver datum to match the map's datum. The map's datum can be found in the legend area.



**Ellipsoid.** Is a solid of which all the plane sections normal to one axis are circles and all the other plane sections are ellipses.

**NAD-27**

NAD-27 is a datum based on the Clarke ellipsoid of 1866. The reference is located at Meads Ranch in Kansas. There are over 50 000 survey monuments used as starting points for more local surveying and mapping. Use of this datum is gradually being replaced by the North American Datum 1983 (NAD-83).

**NAD-83**

NAD-83 is an earth-centred datum based on the Geodetic Reference System of 1980. It was created to meet requirements for better accuracy and precision. The size and shape of the earth was determined through

measurements made by satellites and other sophisticated electronic equipment. The measurements accurately represent the earth within 2 m.

### **WORLD GEODETIC SYSTEM 1984 (WGS-84)**

WGS-84 is the standard physical model of the Earth used for GPS applications. The unified system became essential in the 1950s for several reasons:

- the beginning of international space science and of astronautics;
- the lack of intercontinental geodetic information;
- the inability of the large geodetic systems to provide a worldwide geo-data basis; and
- a need for a global map for navigation, aviation and geography.



Geodetic is a branch of earth sciences. It is the scientific discipline that deals with the measurement and representation of the earth including its gravitational field in a three-dimensional time varying space.

Previous World Geodetic Systems have been in place; WGS-60, WGS-66 and WGS-72 and the current WGS-84. A new model is now being created to replace WGS-84 tentatively called Earth Gravity Model 06.



Use Annex C (Simulated Map Datum) and Annex D (Grid Overlay), to illustrate a datum.

- Place the two slides on an OHP, laying the grid over the map.
- Identify a fictitious fixed point (mountain, lake, boulder) as the map datum (reference point, eg, NAD-27).
- Discuss how the reference point determines the grid's base point.
- Make another fictitious map datum (reference point, eg, WGS-84).
- Show how the uses of different datums relate to different positions dependant on the datum used as a reference point. This will reinforce the importance of setting the appropriate datum before identifying position on a GPS receiver.

---

## **CONFIRMATION OF TEACHING POINT 1**

---

### **QUESTIONS**

- Q1. What is a map datum?
- Q2. What is the NAD-27?
- Q3. What is the WGS-84?

### **ANTICIPATED ANSWERS**

- A1. A map datum is the reference point used to draw maps.
- A2. The NAD-27 is the North American Datum 1927 based on the Clarke ellipsoid of 1866. The reference is located at Meads Ranch in Kansas.
- A3. The WGS-84 is the standard physical model of the Earth used for GPS applications. The unified system became essential in the 1950s.

**Teaching Point 2****Discuss the Universal Transverse Mercator (UTM) Grid System**

Time: 10 min

Method: Interactive Lecture

Because the world is round, any type of representation of its surface on a flat piece of paper will have distortions. These are relatively insignificant on maps that show only small parts of the earth, like city maps or 1 : 50 000 scale maps, but quite considerable for maps of countries or continents.

**UTM GRID****Map Projection**

Map projection is a geometrical method of reducing the amount of distortion on a flat map. In very large countries such as Canada, mapmakers divide the country into strips from north to south, called zones, and project each zone. One system of strip projection is the UTM projection. All National Topographical System (NTS) maps use this system.

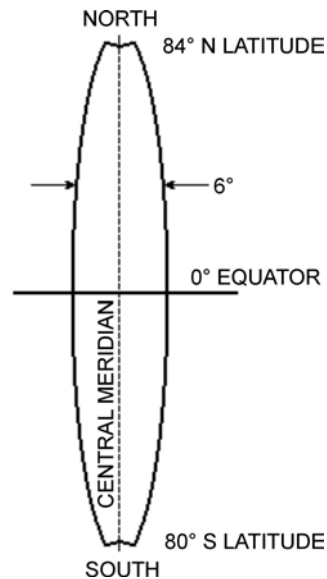

*Director Cadets 3, 2008, Ottawa, ON: Department of National Defence*

Figure 13-5-1 Shape of a UTM Zone – Six Minutes of Longitude Wide

**UTM ZONE**

To picture a UTM zone, imagine the earth as an orange. All the geographical features are drawn on the peel. Take a knife and after slicing small circles at each pole, cut the peel into many narrow strips from pole to pole. Then take the strip of peel and press it flat against a smooth surface. Even though the details in the middle of the peel might become a little distorted, the strip is narrow enough for the details to remain accurate enough for regular map users.

**UTM PROJECTION**

For the UTM Projection, the Earth's surface has been divided into 60 zones. Sixteen of these zones, numbered 7 through 22, cover Canada from west to east. Shown below are the numbered zones with their centre meridian marked with a dotted line. Each zone is divided into sections, and these sections are published as 1 : 250 000 scale maps by the NTS. Each 1 : 250 000 scale map can then be divided into smaller areas,

like 1 : 50 000 scale maps. The location of the topographical map zone number can be found in the marginal information, in the grid zone designator box as seen in Figure 13-5-3.

 Have cadets identify their location in Canada from the handout in Annex E and identify what zone they would be located in.

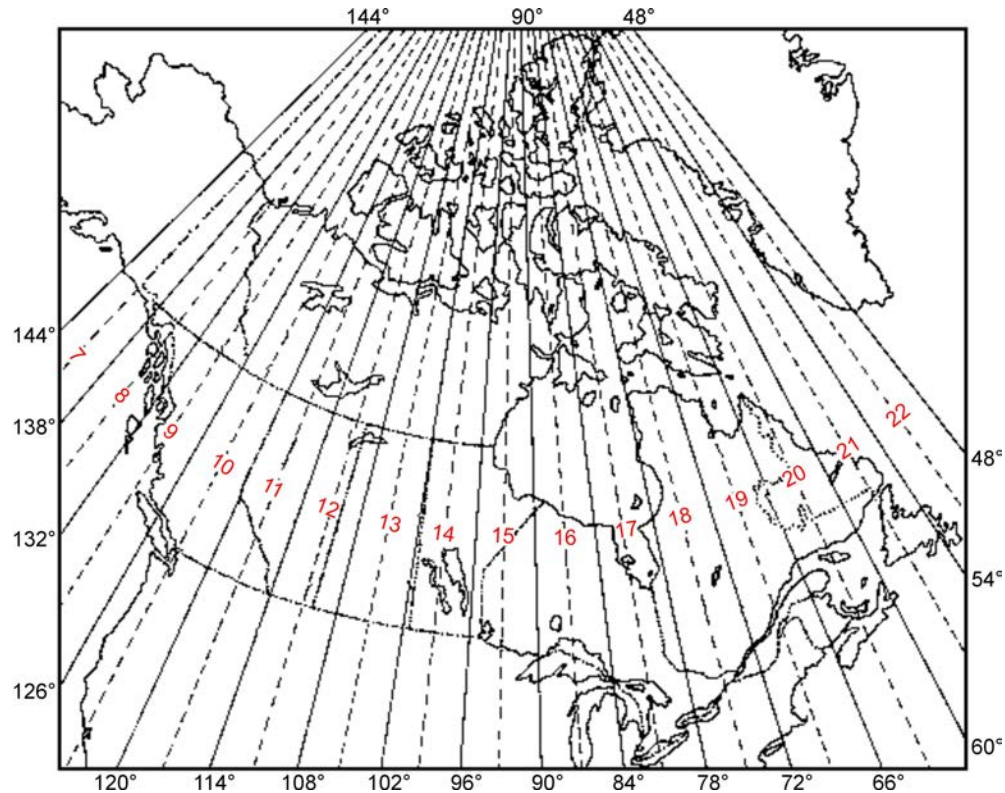

"Natural Resources Canada", *The Universal Transverse Mercator Grid*, Copyright 1969 by Department of Energy, Mines and Resource Canada, Surveys and Mapping Branch. Retrieved April 4, 2008, from [http://maps.nrcan.gc.ca/topo101/utm2\\_e.php](http://maps.nrcan.gc.ca/topo101/utm2_e.php)

Figure 13-5-2 Canadian UTM Zones

**ONE THOUSAND METRE  
UNIVERSAL TRANSVERSE MERCATOR GRID  
ZONE 18**

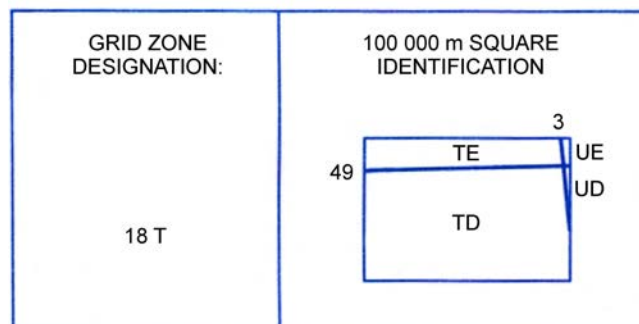

Director Cadets 3, 2008, Ottawa, ON: Department of National Defence

Figure 13-5-3 Grid Zone Identifier

## GRID REFERENCE SYSTEMS

When a map-maker has projected a zone, and divided it into sections, a rectangular grid is laid over top of the projection as seen in Figure 13-5-4. These grid lines are shown in blue on a topographical map. The grid lines are exactly parallel to each other. The vertical grid lines are printed parallel to the meridian of the zone, and the horizontal grid lines are parallel to the equator. These horizontal parallel lines to the equator make up the sub UTM grid zones as seen in Figure 13-5-4.

The largest of the grids are squares 100 km by 100 km. Each of these 100-km squares is identified by a letter which is stated after the UTM zone number. In Figure 13-5-3, the Grid Zone Designation is 18 T. Each large square is further divided into smaller squares of 10 km, and then again into 1 km. It is these 1 km by 1 km (1 000 m by 1 000 m) squares that is depicted on a 1 : 50 000 scale topographical map.

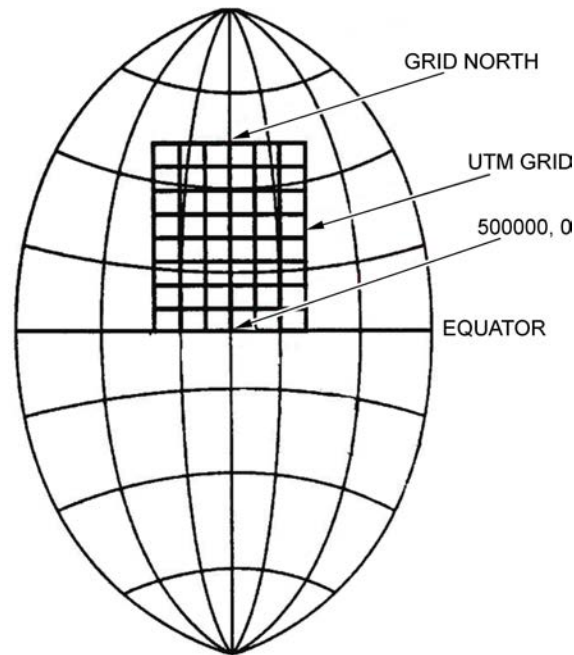

*"Geology 350y – Field Studies", Geological Mapping. Retrieved May 1, 2008, from <http://instruct.uwo.ca/earth-sci/350y-001/acadimages/utm2.jpg>*

Figure 13-5-4 Grid Overlay



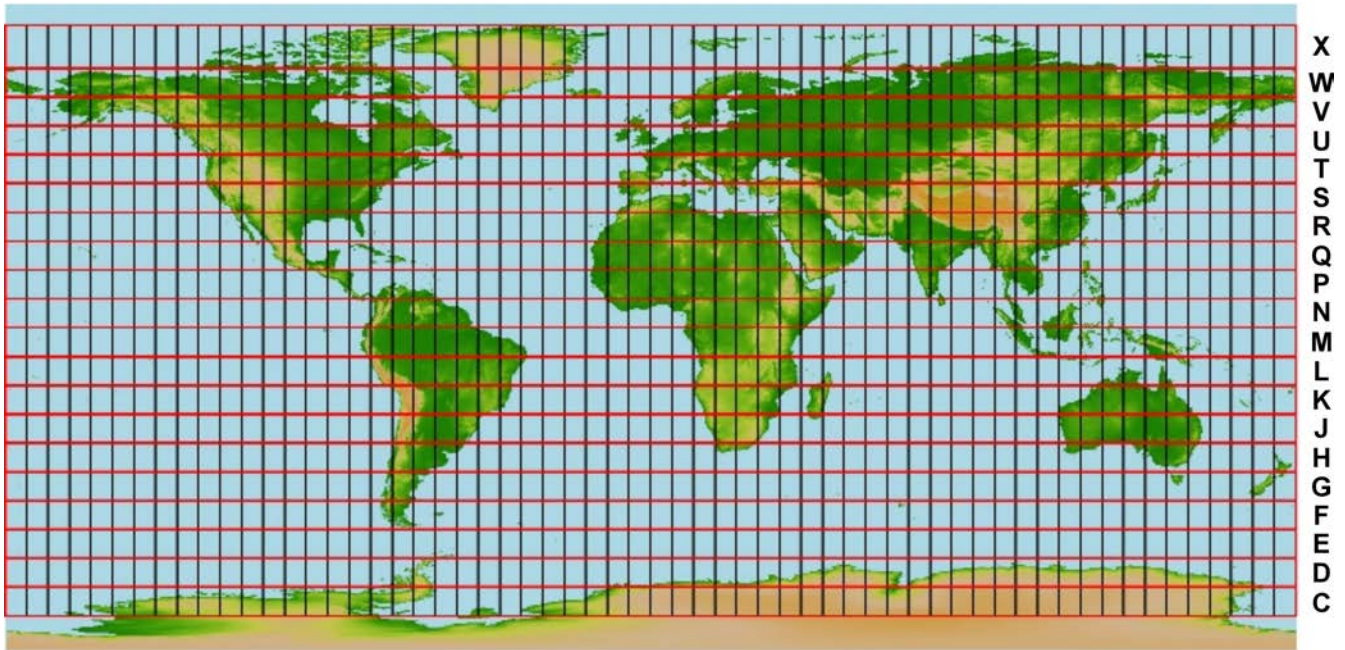

"Warner College of Natural Resources", UTM Sub Zones, Copyright 2007 Colorado State University. Retrieved May 2, 2008, from [http://welcome.warnercnr.colostate.edu/class\\_info/nr502/lg3/datums\\_coordinates/utm.html](http://welcome.warnercnr.colostate.edu/class_info/nr502/lg3/datums_coordinates/utm.html)

Figure 13-5-5 UTM Sub Zones

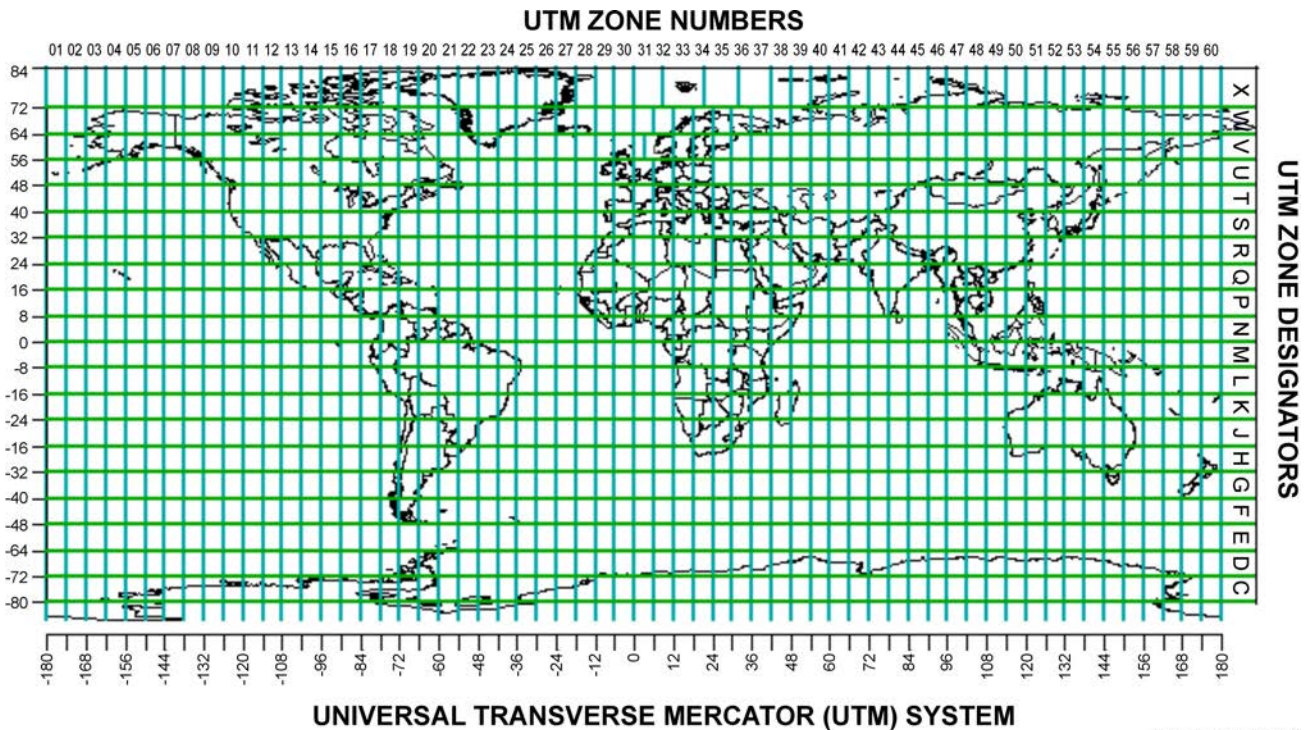

UNIVERSAL TRANSVERSE MERCATOR (UTM) SYSTEM

Peter H. Dana 9/7/94

"Department of Geography, The University of Colorado at Boulder", The Geographer's Craft Project, Copyright 1999 by Peter H. Dana. Retrieved May 1, 2008, from <http://w3.impa.br/~pcezar/cursos/GIS/mapproj.htm>

Figure 13-5-6 UTM Zone Numbers

Each grid line in the 1 000 m grid is numbered.



Have a topographical map available for viewing purposes when presenting information about eastings and northings.

### Eastings

The vertical lines are numbered from an imaginary line 500 000 m west of the zone's centre meridian. Each zone then starts at zero in the west and each 1 000-m line is numbered going toward the east. Each vertical grid line's number, usually a two-digit number at the top and bottom ends of the line, is located in the bottom and top margins. The full number, represented with an E printed behind it, is located in the bottom left corner. This number explains how many metres east the grid line is from the start point. These lines are called eastings because they are numbered from west towards the east.

### Northings

The horizontal line is numbered starting with zero at the equator. In the left and right margins there are two-digit numbers at the ends of each horizontal line. The full number of metres from the equator with the letter N printed behind it can be found in the bottom left. These lines are called northings because they are numbered from the equator towards the north.

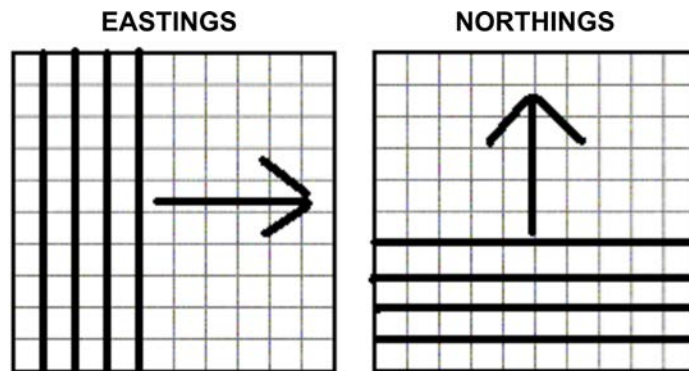

*Director Cadets 3, 2008, Ottawa, ON: Department of National Defence*

Figure 13-5-7 Eastings and Northings

**Military Grid Reference System (MGRS).** The military traditionally identifies grid lines by stating the two-digit short form of the grid line numbers. These two-digit numbers repeat over a large area (every 100 km) so the military has established a letter code for each 100 km by 100 km square. The military grid codes come from the UTM projection that is broken down into smaller 100 000 m square identification (as per Figure 13-5-8). The military grid code is found in the right margin underneath the UTM zone number.



Have cadets identify the MGRS code on the topographical map.



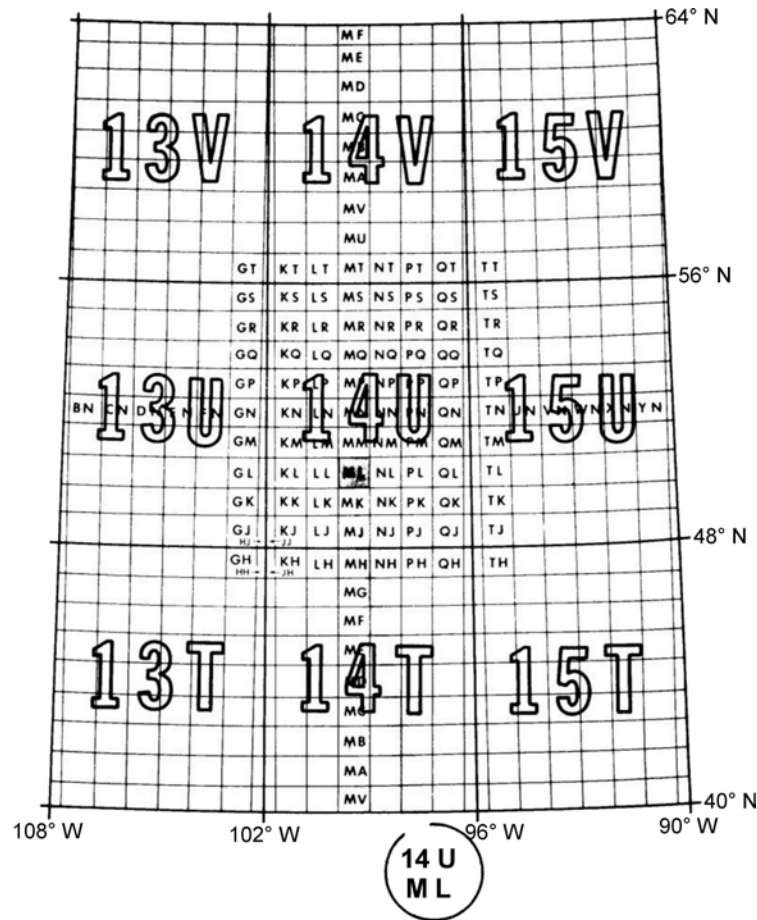

*Department of National Defence, Military Training Volume 8, Map Field Sketching and Compasses, Department of National Defence, 1976, Department of National Defence (p. 75)*

Figure 13-5-8 Layout of MGRS

---

## CONFIRMATION OF TEACHING POINT 2

---

### QUESTIONS

- Q1. UTM projection divides Canada into strips from north to south. What do these strips represent?
- Q2. How many UTM zones is the Earth's surface divided into?
- Q3. Where is the 100 000 m square identifier found on a topographical map?

### ANTICIPATED ANSWERS

- A1. The UTM projection that divides Canada into strips from north to south, represent UTM zones.
- A2. The Earth's surface is divided into 60 zones.
- A3. The 100 000 m square identifier is found in the marginal information.

**Teaching Point 3****Discuss Using a GPS Receiver in Conjunction With a Topographical Map**

Time: 15 min

Method: Interactive Lecture



This TP will provide cadets with the knowledge on how to use a GPS receiver in conjunction with a topographical map.

The provided examples correspond to the Trenton, Ont., 1:50 000 map, # 31 C/4. The map datum for this map is NAD-27.

These examples should be reproduced using a GPS receiver and a local topographical map of the area. This will provide cadets with realistic examples and hands-on experience.



Ensure that the GPS receiver coordinate system is set to MGRS.

**IDENTIFYING MGRS GRID SYSTEM ON A GPS RECEIVER**

GPS receivers will identify the UTM coordinates when reading location, to include:

- grid zone designator,
- 100 000 m square identifier, and
- grid reference (GR).



GPS receivers, depending on the make and model, are capable of selecting a MGRS accuracy of four-, six-, eight-, and ten-figure GR. If the GPS receiver being used for this TP is enabled with this capability, it is suggested that it be set to a 6-figure GR.



Director Cadets 3, 2008, Ottawa, ON: Department of National Defence

Figure 13-5-9 GPS Receiver Coordinates

The coordinates displayed on the GPS receivers in Figure 13-5-9, are set to MRGS. Each GPS receiver is set with a different datum for the same location.

GPS Receiver Datum set to NAD-27	GPS Receiver Datum set to NAD-83
<p>The coordinates are identified as:</p> <ul style="list-style-type: none"> <li>• Grid Zone Designator – 18 T,</li> <li>• 100 000 m square identifier – TD, and</li> <li>• 10-figure GR as –96785 86748</li> </ul>	<p>The coordinates are identified as:</p> <ul style="list-style-type: none"> <li>• Grid Zone Designator – 18 T,</li> <li>• 100 000 m square identifier – TP, and</li> <li>• 10-figure GR as – 96830 86973</li> </ul>



Note the difference between the coordinates of the same location using a different datum.

### PROCESS FOR CONFIRMING CORRECT MGRS COORDINATES

MGRS coordinates allow a GPS receiver to work in conjunction with a topographical map. To confirm the MGRS coordinates correspond with the topographical map the user will have to:

1. Identify the MGRS grid system on the topographical map.
2. Locate the grid zone designator.
3. Confirm the 100 000 m square identifier.

## Identifying MGRS Grid System on a Topographical Map

Locating the MGRS grid system on topographical maps provides the navigator with another method to confirm the GPS receiver is reporting coordinates that correspond with the map being used. If the coordinates are different, the navigator will know that the GPS receiver is set to another datum and will have to be adjusted to provide the correct coordinates.

### Locating the Grid Zone Designator

The location of the grid zone designator is found in the marginal information. The zone for the example in Figure 13-5-10, is 18 T.

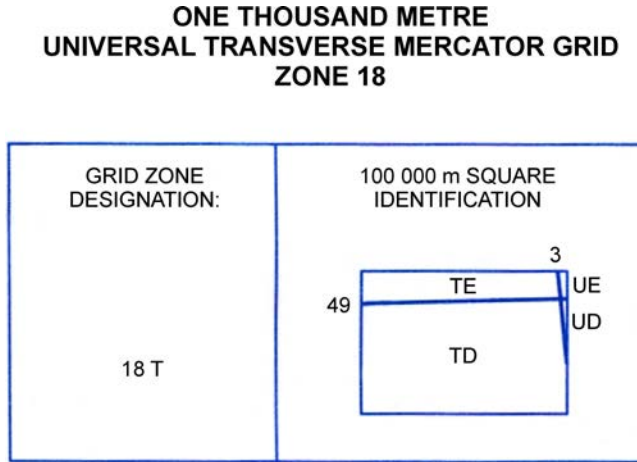

*Director Cadets 3, 2008, Ottawa, ON: Department of National Defence*

Figure 13-5-10 Grid Zone Designator

### Confirming the 100 000 m Square Identifier

The 100 000 m square identifier is located in the same marginal information area as the grid zone designator. The example in Figure 13-5-10 states that the map is adjacent to the 100 000 m square identifications UE and UD. Additionally when the 100 000 m square identifier on a topographical map joins an adjacent grid zone, the identifier will be noted on the map in the 00 00 grid square. This is illustrated in Figure 13-5-11.

31 C/4

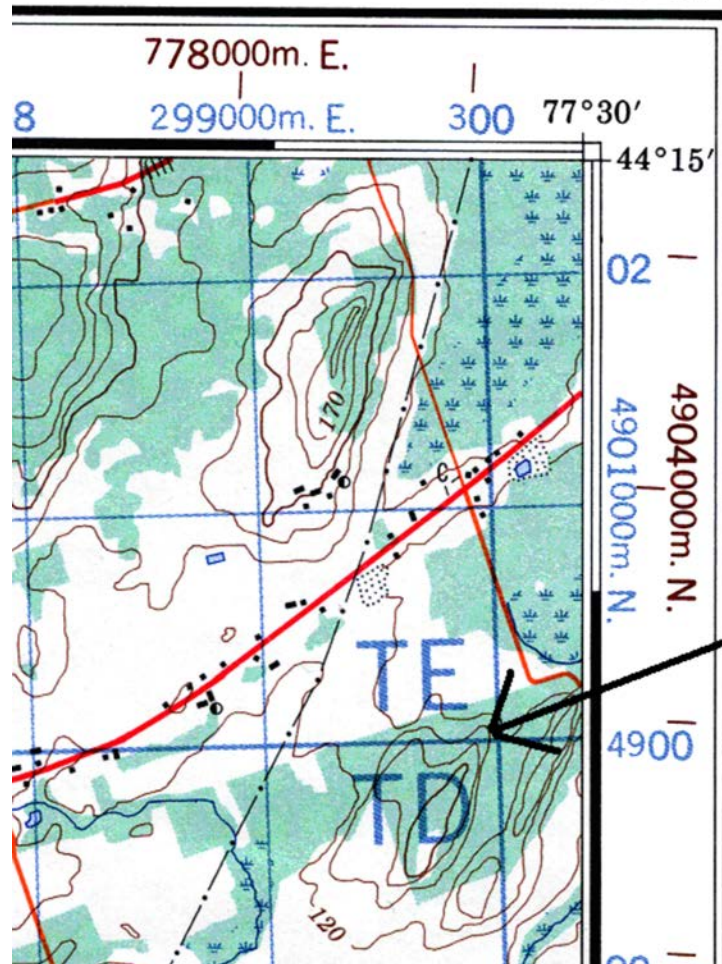

*Director Cadets 3, 2008, Ottawa, ON: Department of National Defence*

Figure 13-5-11 Topographical Map 100 000 m Square Identifier

### CONFIRMATION OF TEACHING POINT 3

#### QUESTIONS

- Q1. What MGRS coordinates are identified by a GPS receiver?
- Q2. What is the process for confirming correct MGRS coordinates?
- Q3. Where is the 100 000 m square identifier located on a topographical map?

#### ANTICIPATED ANSWERS

- A1. The GPS receiver will identify:
- grid zone designator,
  - 100 000 m square identifier, and
  - GR.

- A2. The process for confirming correct MGRS coordinates is to:

- Identify the MGRS grid system on the topographical map.
- Locate the grid zone designator.
- Confirm the 100 000 m square identifier.

A3. The 100 000 m square identifier is located in the marginal information on the topographical map.

**Teaching Point 4**

**Explain, Demonstrate and Have the Cadets Practice  
Setting the Map Datum on the GPS Receiver**

Time: 15 min

Method: Demonstration and Performance



For this TP, it is recommended that instruction take the following format:

1. Explain and demonstrate the complete skill while cadets observe.
2. Explain and demonstrate each step required to complete the skill. Monitor cadets as they imitate each step.
3. Monitor the cadets' performance as they practice the complete skill.

**Note:** Assistant instructors may be employed to monitor the cadets' performance.



Divide cadets into groups based on the number of GPS receivers and topographical maps available. Distribute a GPS receiver and a topographical map to each group.

**IDENTIFYING THE MAP DATUM FROM A TOPOGRAPHICAL MAP**

The map datum of a topographical map is located in the lower right side of the marginal information, under the conversion scale for elevations.

INFORMATION CONCERNING BENCH MARKS AND HORIZONTAL SURVEY MONUMENTS CAN BE OBTAINED FROM GEODETIC SURVEY, CANADA CENTRE FOR SURVEYING, OTTAWA.

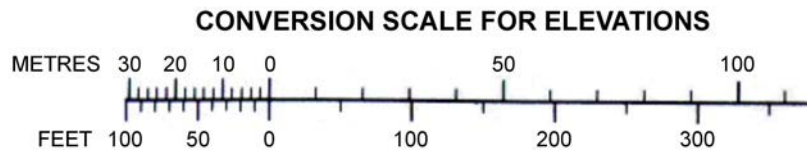

CONTOUR INTERVAL 10 METRES  
ELEVATIONS IN METRES ABOVE MEAN SEA LEVEL  
NORTH AMERICAN DATUM 1927  
TRANSVERSE MERCATOR PROJECTION

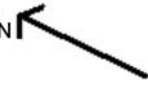

*Director Cadets 3, 2008, Ottawa, ON: Department of National Defence*

Figure 13-5-12 Map Datum



Have the cadets locate the map datum on the topographical map.

### SETTING A DATUM ON A GPS

To set a datum on a GPS:

1. Identify the map datum of the topographical map being used as the reference.
2. With the GPS, go to the set-up menu then, “navigation”, then “system” or “units”.
3. Highlight the map datum’s box.
4. Scroll through the list of datums and find the map datum being used.
5. Set the correct datum.



To set the datum of the eXplorist 200 GPS receiver:

1. Power up the receiver.
2. Press the ENTER button.
3. Press MENU button.
4. Highlight the preferences and press ENTER.
5. Highlight the map units and press ENTER.
6. Highlight the map datum and press ENTER.
7. Highlight the correct datum and press ENTER.

---

### ACTIVITY

Time: 10 min

---

#### OBJECTIVE

The objective of this activity is have the cadets practice setting the map datum on a GPS receiver.

#### RESOURCES

- Topographical map (one per group), and
- GPS receiver (one per group).

#### ACTIVITY LAYOUT

N/A.

#### ACTIVITY INSTRUCTIONS

1. Divide cadets into groups, based on the amount of GPS receivers and topographical maps available.

2. Provide one GPS receiver and topographical map to each group.
3. Have cadets identify the map datum on the topographical map.
4. Have each cadet in the group power up the GPS receiver and set the map datum.
5. Choose a random map datum in the list provided within the GPS receiver and have each cadet in the group set a different datum.
6. If outside and the map is of the area, have the cadets set the correct datum of the map and identify their position on the map using the coordinates provided by the GPS receiver.
7. Once the location is identified, have the cadets set a different datum and note the difference in their position.
8. Discuss the importance of having the correct datum set on the GPS receiver when using maps.

### **SAFETY**

N/A.

---

### **CONFIRMATION OF TEACHING POINT 4**

---

The cadets' participation in the activity will serve as the confirmation of this TP.

---

### **END OF LESSON CONFIRMATION**

---

The cadets' setting the datum on a GPS receiver will serve as the confirmation of this lesson.

---

### **CONCLUSION**

---

### **HOMEWORK/READING/PRACTICE**

N/A.

### **METHOD OF EVALUATION**

This EO is assessed IAW A-CR-CCP-703/PG-001 Chapter 3, Annex B, Appendix 5 (322 PC).

### **CLOSING STATEMENT**

Setting the correct datum on a GPS receiver ensures the position identified on the GPS will correspond with the map being used. The simple mistake of using a different datum when identifying position on a GPS will result in errors when trying to identify position on a map.

### **INSTRUCTOR NOTES/REMARKS**

N/A.

---

### **REFERENCES**

---

- A2-036 A-CR-CCP-121/PT-001 Director Cadets 3. (2003). *Royal Canadian Army Cadet Reference Book*. Ottawa, ON: Department of National Defence.
- C2-143 (ISBN 1-58923-145-7) Featherstone, S. (2004). *Outdoor Guide to Using Your GPS*. Chanhassen, MN: Creative Publishing International, Inc.





**ROYAL CANADIAN ARMY CADETS**  
**SILVER STAR**  
**INSTRUCTIONAL GUIDE**



**SECTION 6**

**EO M322.06 – IDENTIFY LOCATION USING A GLOBAL POSITIONING SYSTEM (GPS) RECEIVER**

---

Total Time: 120 min

---

**PREPARATION**

---

**PRE-LESSON INSTRUCTIONS**

Resources needed for the delivery of this lesson are listed in the lesson specification located in A-CR-CCP-703/PG-001, Chapter 4. Specific uses for said resources are identified throughout the instructional guide within the TP for which they are required.

Review the lesson content and become familiar with the material prior to delivering the lesson.

Ensure GPS receivers have fully-charged batteries.

Prepare a navigational route of six legs.

**PRE-LESSON ASSIGNMENT**

N/A.

**APPROACH**

A practical activity was chosen for this lesson as it is an interactive way to allow the cadets to identify location using a GPS receiver.

---

**INTRODUCTION**

---

**REVIEW**

The review for this lesson is from EO M322.05 (Set a Map Datum on a Global Positioning System [GPS] Receiver, Section 5). Review how to use the GPS receiver to identify position by:

1. confirming the correct map datum is set on the GPS receiver;
2. locating the geographical position page on the GPS receiver;
3. reading the current 10-figure grid reference (GR), extract the six-figure GR from the 10-figure GR shown; and
4. plotting the six-figure GR on the topographical map of the area.

**OBJECTIVES**

By the end of this lesson the cadet shall have identified their location using a GPS receiver.

## IMPORTANCE

It is important for cadets to be able to identify location using a GPS receiver because it provides a more accurate position. Being able to identify the position on a GPS receiver and translate and plot that position onto a topographical map will support one's location and provide a backup in the case of a GPS receiver failure.

### Teaching Point 1

### Have the Cadets Navigate Along a Predetermined Route Using a Topographical Map

Time: 110 min

Method: Practical Activity

## BACKGROUND INFORMATION



Cadets have covered the following material in EOs M322.03 (Identify Components Of The Global Positioning System [GPS], Section 3), M322.04 (Identify Features Of A Global Positioning System [GPS] Receiver, Section 4) and M322.05 (Set A Map Datum On A Global Positioning System [GPS] Receiver, Section 5).

If required, complete a quick review on:

- the components of a GPS receiver,
- GPS screen pages,
- identifying the map datum from a topographical map, and
- setting a map datum on a GPS receiver.

## COMPONENTS OF A GPS RECEIVER

**Antenna.** Allows the GPS receiver to receive satellite signals.

**Screen.** Location where all information is displayed.



Some GPS receivers use an arrow joystick that acts as a mouse, providing a simple to use interface with the GPS receiver.

**Battery Compartment.** Stores the receiver power supply.



The buttons in the following list are found on the Magellan eXplorist 200 GPS receiver. Other makes and models of GPS receivers may have different function buttons. Consult the owner's manual for GPS receiver button functions.

**On/Off.** Turns the receiver on and off.

**Backlight.** Turns the display backlight on and off and changes intensity.

**Enter.** Used to access highlighted menu items or highlighted page menu options.

**Escape.** Cancels data inputs. Closes the accessed function and goes back to the previous screen and moves backward through the navigation screens.

**Zoom In.** Used on the map screen to zoom in on the map displayed. The map display can be zoomed in to 35 m (100 feet). Also used to move through the list of waypoints when using an alphabetical search.

**Zoom Out.** Used on the map screen to zoom out on the map displayed. The map display can be zoomed out to 2736 km (1700 miles). It is also used to move through the list of waypoints when using an alphabetical search.

**Menu.** Displays a menu with available options. Options may be selected by using the arrow joystick to highlight the option and pressing “enter” to access it.

**NAV.** Moves through the navigation screens (Map screen, Compass screen, Position screen, Satellite screen).

**Mark.** Used to save present position as a waypoint. Waypoints are saved and stored in “My Points of Interest” (POI).

**GOTO.** Creates a one-leg route from the present position to a destination selected from the POI database or by using the cursor on the background map and pressing GOTO on a point.

**Arrow Joystick.** Moves the cursor on the map screen. It also moves the highlighted bar to select menu options and data-entry fields.



Thales Navigation, Inc., Magellan eXplorist 200 Reference Manual, Thales Nav, Inc. (p. 1)

Figure 13-6-1 eXplorist 200 GPS Receiver

**GPS SCREEN PAGES**



GPS receivers may differ in the way they present information, from unit to unit. Identify the screens that are similar to those contained in this TP.

**Note:** The term “Page” refers to the different screens an operator can scroll through to locate different information in a GPS receiver.

**Satellite Status.** The satellite status screen displays the acquisition of satellites (satellite signal strength and satellite geometry) and the progress of the collection of satellite data. The receiver is constantly monitoring satellites. The display on the satellite status page graphically depicts the activity.

As new satellites come into view, a new bar appears in the graph. Bars that were solid minutes ago disappear as satellites pass over the horizon. If a satellite is being monitored but not used, the bar will appear hollow. On Wide Area Augmentation System (WAAS) enabled GPS receivers, the WAAS satellite signal strength is indicated on its own bar on the graph. On this page it is common for GPS receivers to display the following information:

- satellite signal strengths,
- battery strength, and
- estimated position error (EPE).

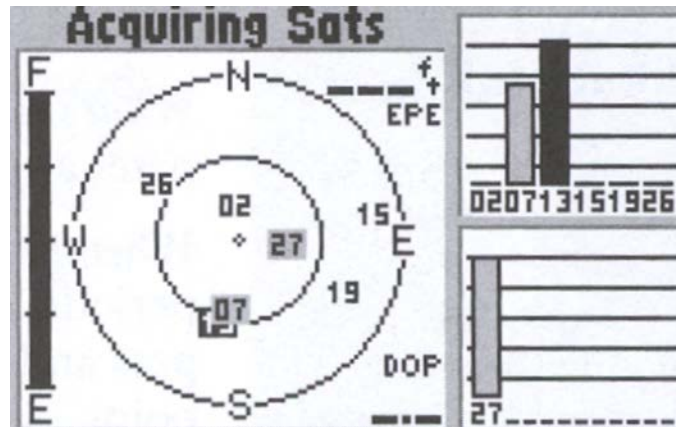

*S. Featherstone, Outdoor Guide to Using Your GPS, Creative Publishing International, Inc. (p. 45)*

Figure 13-6-2 Satellite Status Page

**Menu.** This page is used for customizing the GPS receiver. All data fields can be changed to give a person the information they require including waypoints, routes, time and speed, etc. On this page it is common for GPS receivers to display the following information:

- customization options for the GPS receiver,
- waypoints and routes, and
- map datum.

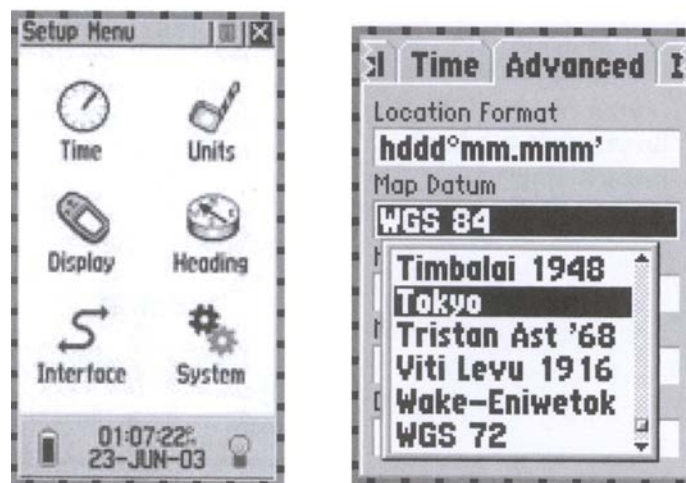

*S. Featherstone, Outdoor Guide to Using Your GPS, Creative Publishing International, Inc. (p. 54)*

Figure 13-6-3 Menu Page

**Position.** The position page is used for confirming coordinates, datum, time, date, and the EPE. This page is used infrequently, for brief periods, mostly in planning and after marking a waypoint. No easy-to-understand graphics, like a compass rose, are displayed.

After acquiring enough satellites to begin navigating, many GPS receivers automatically go to the position page or the map page. In addition to the information mentioned above, an operator may find current speed, heading and a trip odometer. On some GPS receivers the information displayed can be changed.

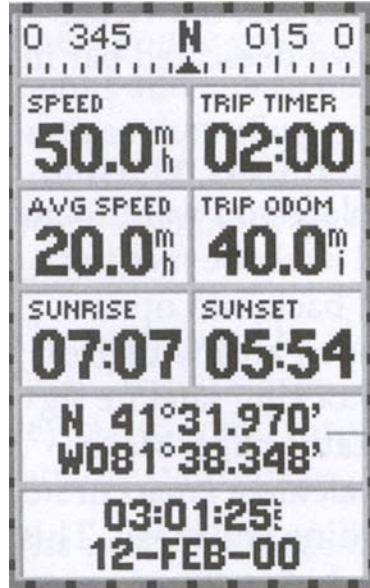

*S. Featherstone, Outdoor Guide to Using Your GPS, Creative Publishing International, Inc. (p. 46)*

Figure 13-6-4 Position Page

**Compass Navigation.** This page shows the direction of travel (track) as it relates to the direction of the destination (bearing). It will show the distance from the destination and time to the destination. This page is used frequently when navigating from point-to-point and for navigating around obstacles.



The digital compass graphic should not be confused with a real compass. Although they look the same it can give a very different reading because without movement GPS receivers cannot display direction. Read the owner's manual and determine if the compass is an electronic compass capable of identifying compass heading while standing still.



*S. Featherstone, Outdoor Guide to Using Your GPS, Creative Publishing International, Inc. (p. 47)*

Figure 13-6-5 Compass Navigation Page

**Map.** This page identifies position. A GPS without a built-in map will identify where a person is in relation to another waypoint. A GPS receiver with a built-in map will identify where a person is in relation to landmarks, such as roads, cities and bodies of water. A GPS receiver with downloadable maps will identify where a person is in relation to city streets and topographical features.

The advantage of this screen is its ability to identify the current position by looking at the features on a map rather than just the coordinates. Depending on the zoom level – which is shown at the bottom of the page – these features might be roads or cities or entire continents.

The map page allows an operator to pinpoint where one is and create a waypoint over a feature by pressing “enter” or “mark”, making route building easier. The map page can also serve as an address book. By moving the cursor over a certain waypoint and pressing “enter”, information is displayed such as phone numbers, addresses, and navigation information.



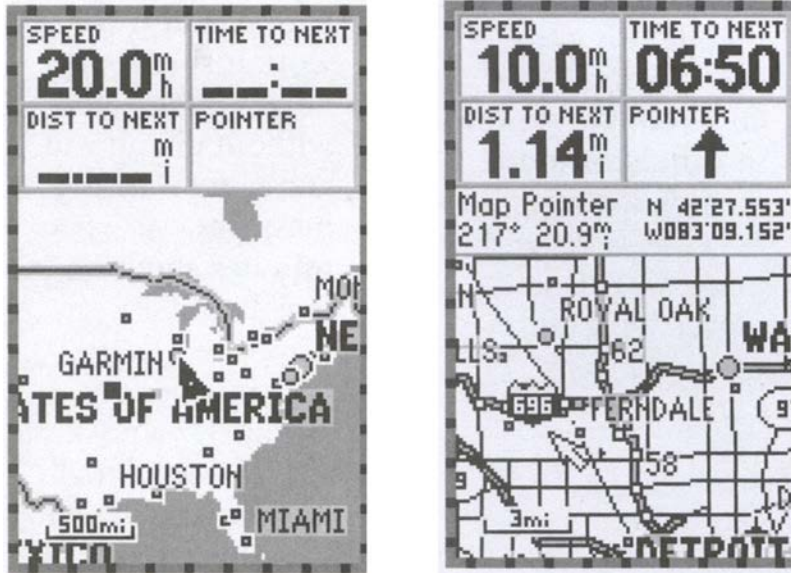

S. Featherstone, *Outdoor Guide to Using Your GPS*, Creative Publishing International, Inc. (p. 50)

Figure 13-6-6 Map Page

**IDENTIFY THE MAP DATUM FROM A TOPOGRAPHICAL MAP**

The map datum of a topographical map is located in the lower right side of the marginal information, under the conversion scale for elevations.

INFORMATION CONCERNING BENCH MARKS AND HORIZONTAL SURVEY MONUMENTS CAN BE OBTAINED FROM GEODETIC SURVEY, CANADA CENTRE FOR SURVEYING, OTTAWA.

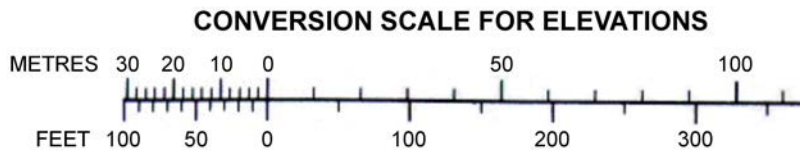

CONTOUR INTERVAL 10 METRES  
 ELEVATIONS IN METRES ABOVE MEAN SEA LEVEL  
 NORTH AMERICAN DATUM 1927  
 TRANSVERSE MERCATOR PROJECTION



Director Cadets 3, 2008, Ottawa, ON: Department of National Defence

Figure 13-6-7 Map Datum



Have the cadets locate the map datum on the topographical map.



## SETTING A DATUM ON A GPS

To set a datum on a GPS:

1. Identify the map datum of the topographical map being used as the reference.
2. With the GPS, go to the set-up menu then “navigation” then “system” or “units”.
3. Highlight the map datum’s box.
4. Scroll through the list of datums and find the map datum being used.
5. Set the correct datum.



To set the datum of the eXplorist 200 GPS receiver:

1. Power up the receiver.
2. Press the ENTER button.
3. Press MENU button.
4. Highlight preferences and press ENTER.
5. Highlight map units and press ENTER.
6. Highlight map datum and press ENTER.
7. Highlight correct datum and press ENTER.

## EXTRACTING A 6-FIGURE GR FROM A 10-FIGURE GR

A 10-figure grid reference given from a GPS receiver has 10 digits and is accurate to 1 m. To extract the 6-figure GR from the 10-figure GR one must understand how the figures work.

GRID REFERENCE WRITTEN FIGURES		
Definition	Easting	Northing
A 10-figure GR accurate to 1 m is written as	96779	86744
A 8-figure GR accurate to 10 m is written as	9677	8674
A 6-figure GR accurate to 100 m of the same coordinates is written as	967	867
A 4-figure GR accurate to 1 000 m of the same coordinates is written as	96	86

As illustrated in the above chart the 10-figure GR has two sets of numbers. The first five digits are eastings and the last five digits are the northing coordinates. When taking a GR from a GPS receiver is important to identify the 10 digits and extract the first three numbers from the easting portion and the first three numbers from the northing portion (eg, **96779 86744**). The 6-figure grid reference can then be plotted on a map as GR 967 867.

## IDENTIFYING MGRS GRID SYSTEM ON A GPS RECEIVER



The provided examples correspond to the Trenton, Ont., 1 : 50 000 map, # 31 C/4. The map datum for this map is NAD-27.

These examples should be reproduced using a GPS receiver and a local topographical map of the area. This will provide cadets with realistic examples and hands on experience.



Ensure that the GPS receiver coordinate system is set to Military Grid Reference System (MGRS).

GPS receivers will identify the MGRS coordinates when reading location, to include:

- grid zone designator,
- 100 000 m square identifier, and
- GR.

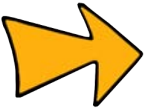

GPS receivers, depending on the make and model, are capable of selecting a MGRS accuracy of four-, six-, eight-, and ten-figure GRs. If the GPS receiver being used for this TP is enabled with this capability, it is suggested that it be set to a six-figure GR.



*Director Cadets 3, 2008, Ottawa, ON: Department of National Defence*

Figure 13-6-8 GPS Receiver Coordinates



### Confirming the 100 000 m Square Identifier

The 100 000 m square identifier is located in the same marginal information area as the grid zone designator. The example in Figure 13-6-9 states that the map is adjacent to the 100 000 m square identifications UE and UD. Additionally, the 100 000 m square identifier on a topographical map joins an adjacent grid zone, the identifier will be noted on the map in the 00 00 grid square. This is illustrated in Figure 13-6-10.

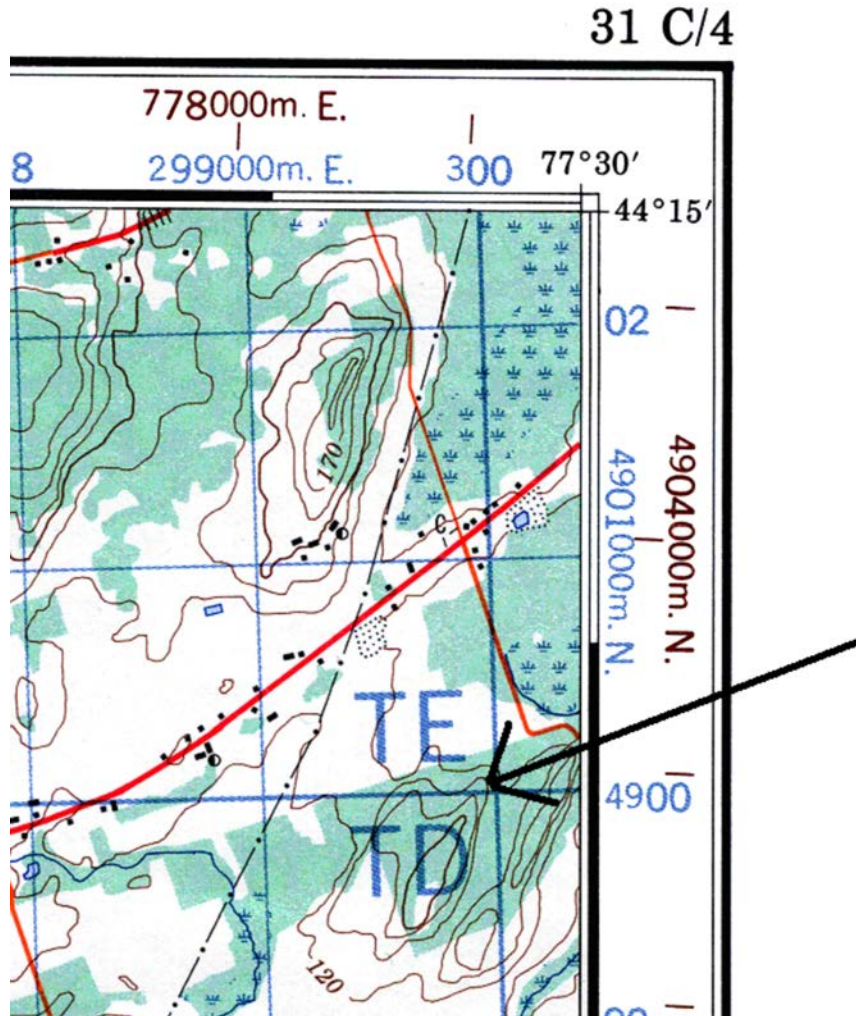

*Director Cadets 3, 2008, Ottawa, ON: Department of National Defence*

Figure 13-6-10 Topographical Map 100 000 m Square Identifier

---

### ACTIVITY

---

#### OBJECTIVE

The objective of this activity is to have the cadets identify location using a GPS receiver and plot that position on a topographical map.

## RESOURCES

- GPS receiver,
- Topographical map of the area,
- Compass,
- Pen/pencil,
- First aid kit, and
- Communication equipment.

## ACTIVITY LAYOUT

1. Prepare a route along Class 1 or 2 terrain that does not exceed 6 km (3.7 miles).
2. Along the route mark off six specific checkpoints. Record the six-figure GR off of the topographical map and the 10-figure GR from the GPS for every point.

## ACTIVITY INSTRUCTIONS

1. Divide the cadets into groups of no more than six.
2. Assign each cadet in the group one of the six checkpoints.
3. Have each cadet lead the group to their designated checkpoint navigating with a topographical map.
4. Before moving to the next sequential checkpoint, have the designated cadet identify their current location using a topographical map through a six-figure GR.
5. At the checkpoint have the cadet identify position using a GPS receiver, to include:
  - (a) confirming the correct map datum is set on the GPS receiver,
  - (b) locating the geographical position page on the GPS receiver and confirm:
    - (1) grid zone is the same as printed on the topographical map,
    - (2) the 100 000 m square identifiers are the same; and
  - (c) reading the current 10-figure GR and extracting the 6-figure GR; and
  - (d) plotting the 6-figure GR on the topographical map of the area.
6. Confirm the plotted six-figure GR corresponds with the assigned checkpoint.



Remember that a 6-figure GR is accurate to 100 m. The plotted GR should be within 100 m of the actual group location.

## SAFETY

Communications and emergency first aid equipment shall be carried with each group in case of emergency.

---

## CONCLUSION

---

### HOMEWORK/READING/PRACTICE

N/A.

### METHOD OF EVALUATION

This EO is assessed IAW A-CR-CCP-703/PG-001, Chapter 3, Annex B, Appendix 5 (322 PC).

### CLOSING STATEMENT

Being able to use a GPS receiver to identify position and plot that position on a map provides the the cadet a secondary means to confirm position and backs up the location of the cadet in the case of a GPS receiver failure.

### INSTRUCTOR NOTES/REMARKS

322 PC shall be scheduled on the weekend bivouac/survival FTX.

The route will consist of Class 1 or 2 terrain and will not exceed 4 km (2.5 miles).

---

## REFERENCES

---

- A2-036 A-CR-CCP-121/PT-001 Director Cadets 3. (2003). *Royal Canadian Army Cadet Reference Book*. Ottawa, ON: Department of National Defence.
- C2-143 (ISBN 1-58923-145-7) Featherstone, S. (2004). *Outdoor Guide to Using your GPS*. Chanhassen, MN: Creative Publishing International, Inc.



**ROYAL CANADIAN ARMY CADETS**  
**SILVER STAR**  
**INSTRUCTIONAL GUIDE**



**SECTION 7**

**EO C322.01 – PRACTICE NAVIGATION AS A MEMBER OF A SMALL GROUP**

---

Total Time: 90 min

---

**PREPARATION**

---

**PRE-LESSON INSTRUCTIONS**

Resources needed for the delivery of this lesson are listed in the lesson specification located in A-CR-CCP-703/PG-001, Chapter 4. Specific uses for said resources are identified throughout the instructional guide within the TP for which they are required.

Review the lesson content and become familiar with the material prior to delivering the lesson.

Review the activities in TP 2 to confirm local resources required and prepare the route to be used to include grid references and bearings.

Prepare a route based on the area and activity.

If assistant instructors are not available, determine a safety bearing to a known location.

**PRE-LESSON ASSIGNMENT**

N/A.

**APPROACH**

An interactive lecture was chosen for TP 1 to give direction on procedures and to illustrate the application of rules for the navigation exercise.

A practical activity was chosen for TP 2 as it is an interactive way to allow cadets to experience navigation in a safe, controlled environment. This activity contributes to physical fitness and to the development of navigation skills and knowledge in a fun and challenging setting.

A group discussion was chosen for TP 3 as it allows the cadets to interact with their peers and share their knowledge, experiences, opinions, and feelings about navigation training.

---

**INTRODUCTION**

---

**REVIEW**

N/A.

**OBJECTIVES**

By the end of this lesson the cadet shall have practiced navigation as a member of a small group.



**IMPORTANCE**

It is important for cadets to practice navigation skills taught in Silver Star using a map, compass and a GPS receiver. Participation in these activities contributes to the development of navigation skills and knowledge in a fun and challenging setting. Cadets will rely on this skill set throughout navigation and expedition training.

**Teaching Point 1****Attend a Safety Briefing**

Time: 10 min

Method: Interactive Lecture



This briefing is being conducted to pass on vital information and to answer any questions regarding the safe conduct of a navigation activity, to include:

- actions that can be taken if they become lost, may include:
  - returning to the previous checkpoint;
  - using a radio, if available; or
  - following a safety bearing to a known location;
- a time limit for the activity of 55 minutes;
- boundaries set for the conduct of the activity;
- rules and safety procedures for the activity; and
- a narrative of the activity being conducted.

**CONFIRMATION OF TEACHING POINT 1****QUESTIONS**

- Q1. What actions shall be taken if a group becomes lost?
- Q2. What is the time limit for this activity?
- Q3. What are the boundaries for this activity?

**ANTICIPATED ANSWERS**

- A1. If a group becomes lost, they should return to the previous checkpoint, use a radio, if available or follow a safety bearing to a known location.
- A2. This activity will last no more than 55 minutes.
- A3. The answers to this question will vary based on the local area used.



**Teaching Point 2****Have the Cadets Participate in a Navigation Activity**

Time: 55 min

Method: Practical Activity



Conduct one of the following activities in the time allocated. If time permits, conduct both activities. Prepare for each activity in advance using available resources.

**NAVIGATION TRAIL**

Cadets will be given a map, compass and GPS receiver. Upon arrival at each point, cadets will be given directions by a staff member travelling with the group or at a checkpoint. (magnetic or grid bearing and distance in metres or paces) to follow from one checkpoint to the next. The course will consist of a minimum of six legs, approximately 100–200 m in length. When each group arrives at the checkpoint, they will compare the grid reference (GR) on the map with that on the GPS receiver, determine the distance between each checkpoint and be given directions to the next checkpoint. The group with the most accurate GRs and distance between each checkpoint and the fastest time is the winning group.

**NAVIGATION BRAIN TEASER**

Using a map, compass and GPS receiver, cadets will navigate to predetermined points on the map. The course will consist of a minimum of six legs, approximately 100–200 m in length. Following the clues provided, when each group arrives at the checkpoint, they will record the GR on the GPS receiver (to ensure they were at each checkpoint) and be given clues (magnetic bearing, GR, or distance) directing them to another checkpoint. The clues should make the cadets think about and use their navigations skills to find the next checkpoint. The group that locates the most checkpoints and has the fastest time is the winning group.

**PHOTO FINISH**

Create a sheet of 12 - 20 prominent but relatively small landmarks within the immediate area of the cadet training area. Each landmark should be given a point value based on the difficulty to locate the object. Instructions must include the Datum (NAD 83) and the reference system (MGRS) to set on the GPS. Groups of cadets will then seek out the landmark and upon finding one record the 10 figure MGRS grid reference of the object. The group that gives the correct GR of landmarks to achieve the highest point score in the time allocated wins.



Depending on terrain selected and complexity of the navigation instructions, a navigation trail can be as easy or as challenging as you wish to make it.

**ACTIVITY 1 – NAVIGATION TRAIL****OBJECTIVE**

The objective of the Navigation Trail activity is to have the cadets, as a member of a small group, use navigation training taught during Silver Star.

**RESOURCES**

- GPS receiver (one per group),

- Topographical map of the area (one per group),
- Compass (one per group), and
- A predetermined navigation route.

### ACTIVITY LAYOUT

Clearly mark the start and finish lines.

### ACTIVITY INSTRUCTIONS



To keep things interesting, interchange the type of bearing and distance directions for each checkpoint (eg, magnetic or grid, paces or metres).

1. Divide the cadets into groups by the number of GPS receivers available.
2. Issue each group a map, compass and GPS receiver.
3. Have the cadet leading the group plot the bearing and distance onto the map.
4. Start groups at two-minute intervals and record start times.
5. Have cadets record GRs and distance for each leg.
6. Have cadets alternate turns leading the group at least once.
7. Record the finish time for each group.
8. Compare the results of each group.
9. The group with the most accurate GRs and distances between each checkpoint and the fastest time is the winning group.



If available, use an assistant instructor at each checkpoint to answer questions and to prevent groups from following each other or sharing answers.

### SAFETY

N/A.

---

## ACTIVITY 2 – NAVIGATION BRAIN TEASER

---

### OBJECTIVE

The objective of the Navigation Brain Teaser activity is to have the cadets, as members of a small group, use their navigations skills to find as many checkpoints as possible.

### RESOURCES

- GPS receiver (one per group),
- Topographical map (one per group),

- Compass (one per group), and
- A predetermined navigation route.

### ACTIVITY LAYOUT

- Clearly mark the start and finish lines.
- Position a clue at each point to direct the groups to the next point.

### ACTIVITY INSTRUCTIONS



To keep things interesting, the clues should not be too easy or too hard for the cadets to find each checkpoint. Stagger the clues to prevent groups from following each other or sharing answers.

1. Divide the cadets into groups by the number of GPS receivers available.
2. Issue each group a map, compass and GPS receiver.
3. Give the clue for the first checkpoint to the cadet leading the group.
4. Start groups at two-minute intervals and record start times.
5. On a piece of paper, have cadets record clues in the order they complete the checkpoints.
6. Have cadets alternate turns leading the group at least once.
7. Collect sheets and record the finish time for each group.
8. The group that locates the most checkpoints and has the fastest time is the winning group.



If available, use an assistant instructor at each checkpoint to give cadets the next clue and answer questions.

### SAFETY

N/A.

---

## ACTIVITY 3 – PHOTO FINISH

---

### OBJECTIVE

The objective of the Photo Finish activity is to have the cadets, as members of a small group, use a GPS to locate a series of ten figure GRs.

### RESOURCES

- GPS receiver (one per group),
- Photo Hunt activity sheet including 12 to 20 landmark photos and GPS setup information (one per group),

## ACTIVITY LAYOUT

- Create a photo hunt activity sheet to include 12 to 20 photos of prominent landmarks in the area of the training location. Landmarks should be small enough that an accurate grid reference can be obtained for the location (+/- 15 m), eg, an intersection street sign, legion cenotaph, advertising sign, etc. Landmarks must not be on private property without the express permission of the landowner. The sheet must also include the applicable GPS setup information, eg, Datum (NAD 83) and grid system (MGRS).
- Create an answer sheet using a GPS with the same setup information as prescribed on the photo hunt activity sheet.
- Establish a finish time for the activity, which may include a point score penalty system for late arrivals.
- Ensure GPS units are not set to the same setup information as listed on the photo hunt activity sheet.
- Establish a finish location.

## ACTIVITY INSTRUCTIONS



To keep things interesting, the difficulty of finding the landmarks should vary and point values should be based on difficulty, eg, distance and/or obscurity of the landmark.

1. Divide the cadets into groups by the number of GPS receivers available.
2. Issue each group a photo hunt activity sheet and GPS receiver.
3. Have the cadets assign a peer leader for the group.
4. Groups may start at the same time or at intervals depending on the number of groups.
5. On a piece of paper, have cadets record the GR of each landmark as they find it.
6. Have cadets alternate using the GPS to identify the GR.
7. Collect sheets and record the point score less any time penalty for each group.
8. The group that has the highest point score is the winning group.

## SAFETY

Cadets shall be briefed on boundaries which must take into account any dangerous obstacles or crossings. If radios are available each group should be given a radio.

---

## CONFIRMATION OF TEACHING POINT 2

---

The cadets' participation in the navigation activities will serve as the confirmation of this TP.

**Teaching Point 3****Conduct a Debriefing**

Time: 15 min

Method: Group Discussion

**BACKGROUND KNOWLEDGE****GROUP DISCUSSION****TIPS FOR ANSWERING/FACILITATING DISCUSSION**

- Establish ground rules for discussion, eg, everyone should listen respectfully; don't interrupt; only one person speaks at a time; no one's ideas should be made fun of; you can disagree with ideas but not with the person; try to understand others as much as you hope they understand you; etc.
- Sit the group in a circle, making sure all cadets can be seen by everyone else.
- Ask questions that will provoke thought; in other words avoid questions with yes or no answers.
- Manage time by ensuring the cadets stay on topic.
- Listen and respond in a way that indicates you have heard and understood the cadet. This can be done by paraphrasing their ideas.
- Give the cadets time to respond to your questions.
- Ensure every cadet has an opportunity to participate. One option is to go around the group and have each cadet answer the question with a short answer. Cadets must also have the option to pass if they wish.
- Additional questions should be prepared ahead of time.

**SUGGESTED QUESTIONS**

- Q1. What navigation skills were required to complete the activity?
- Q2. What was the hardest part of the activity to complete?
- Q3. What was the most exciting part of the activity?
- Q4. How will the activity help you with navigation in the future?



Other questions and answers will develop throughout the group discussion. The group discussion should not be limited to only those suggested.



Reinforce those answers given and comments made during the group discussion, ensuring the teaching point has been covered.

---

**CONFIRMATION OF TEACHING POINT 3**

---

The cadets' participation in the group discussion will serve as the confirmation of this TP.

---

**END OF LESSON CONFIRMATION**

---

The cadets' participation in the navigation activities and the group discussion will serve as the confirmation of this lesson.

---

**CONCLUSION**

---

**HOMEWORK/READING/PRACTICE**

N/A.

**METHOD OF EVALUATION**

N/A.

**CLOSING STATEMENT**

Navigating using a GPS receiver or a map and compass are skills that can also be used in situations outside the Cadet Program. True proficiency in the skills used during these activities can only be achieved by practicing. These activities allow the cadets the opportunity to develop their navigation skills and knowledge in a fun and challenging setting.

**INSTRUCTOR NOTES/REMARKS**

The intent of this activity is to give the cadet experience navigating with a map and compass, determine distance and follow a bearing from point-to-point.

This activity may be conducted using any available map appropriate for this activity.

This complementary activity can be conducted up to three times during supported complementary days or sessions. Participation is limited to a maximum of nine periods.

---

**REFERENCES**

---

A2-041 B-GL-382-005/PT-001 Canadian Forces. (2006). *Maps, Field Sketching, Compasses and the Global Positioning System*. Ottawa, ON: Department of National Defence.



**ROYAL CANADIAN ARMY CADETS**  
**SILVER STAR**  
**INSTRUCTIONAL GUIDE**



**SECTION 8**

**EO C322.02 – IDENTIFY FACTORS THAT IMPACT NAVIGATION IN THE WINTER**

---

Total Time: 120 min

---

**PREPARATION**

---

**PRE-LESSON INSTRUCTIONS**

Resources needed for the delivery of this lesson are listed in the lesson specification located in A-CR-CCP-703/PG-001, Chapter 4. Specific uses for said resources are identified throughout the instructional guide within the TP for which they are required.

Review the lesson content and become familiar with the material prior to delivering the lesson.

**PRE-LESSON ASSIGNMENT**

N/A.

**APPROACH**

An in-class activity was chosen for TP 1 as an interactive way to provoke thought and stimulate an interest on how terrain features are affected in the winter.

An interactive lecture was chosen for TPs 2 and 3 to present background information to the cadet on the factors that affect visibility and weather conditions which can impact navigation in the winter.

A group discussion was chosen for TP 4 as it allows the cadet to interact with their peers and share their knowledge, experiences, opinions and feelings about navigating in the winter.

A practical activity was chosen for TP 5 as it is an interactive way to allow the cadet to experience navigating in the winter. This activity contributes to the development of winter navigational skills in a fun and challenging setting under supervision.

---

**INTRODUCTION**

---

**REVIEW**

N/A.

**OBJECTIVES**

By the end of this lesson the cadet shall be expected to identify factors that impact navigation in the winter.

**IMPORTANCE**

It is important for cadets to understand the impact of weather on winter navigation skills. Navigating in the winter can become very confusing when the surroundings and weather conditions change unexpectedly. Applying

some simple routine navigation techniques will ensure the cadets stay on course while enroute to their desired destination.

---

**Teaching Point 1****Conduct a Brainstorming Activity Where the Cadet Will Discuss How Terrain Features Are Affected in the Winter**

Time: 15 min

Method: In-Class Activity

---

---

**BACKGROUND KNOWLEDGE**

---

Winter weather conditions have a direct impact on how people travel during the winter months. When participating in a winter hiking activity, there are some key factors which must be considered.

**TRAILS/FOOTPATHS**

Popular trails are easier to follow in winter than little-used trails, because staying on an unbroken trail can be extremely challenging. Just a few inches of snow can obscure the footpath and can be as bewildering as scanning a forest or open meadow; despite thinking or knowing that the trail is there somewhere, it all looks the same.

**TRAIL MARKERS**

A trail has specific details about it that tell the hiker they are on the trail. The trail will show signs of previous travel, a corridor through the trees, blazes, cairns and other markers. When following a trail in the winter, whether on a track that previous hikers have broken in the snow or on a trail you are breaking, remain vigilant to watch for signs of the trail.

**Cairns.** Cairns are piles of rocks. They vary in size from a small grouping of three or four rocks to large piles that can be seen in thick fog. During the winter with snow covering the ground, trails marked with cairns may require more concentration to locate than a marking at eye level. They are easy to miss.



*K. Berger, Backpacking and Hiking, DK Publishing Inc. (p. 158)*

Figure 13-8-1 Sample Cairn

**Paint Blazes.** Paint blazes are markings on trees, pieces of wood, rocks, etc. The markings will differ from trail to trail. A trail may have its own specific logo, which could be something as simple as a rectangle, a circle or a triangle. Paint blazes are the most common type of trail marking and during winter, windblown snow may stick to the trees covering the markers.





*Director Cadets 3, 2008, Ottawa, ON: Department of National Defence*

Figure 13-8-2 Sample Trail Blaze

## PROMINENT LANDMARKS

Winter conditions change the way features may have looked in summer. Snow masks and covers the normal route features by covering worn down paths, masking slight elevation changes and covering streams, marshes and valleys. Navigators will have to resort to using more prominent and sometimes distant features to orient the map, locate their position and follow a desired route. The prominent features can be ridges, peaks and communication towers.

**Ridges.** A long narrow hilltop, mountain range, or watershed can easily be identified on a map and also be easily visible during winter conditions.

**Peaks.** Mountaintops that form a point. Peaks of mountains are defined and easily seen during trekking and can be good prominent landmarks for orienting the map during winter travel.

**Communication Towers.** Cellular and radio communications towers are found on most current topographical maps and are good aids when orienting a map during winter navigation.

---

## ACTIVITY

---

### OBJECTIVE

The objective of this activity is to have the cadets in a group discuss how terrain features are affected in the winter.

### RESOURCES

- Flip chart paper, and
- Markers.

### ACTIVITY LAYOUT

N/A.

### ACTIVITY INSTRUCTIONS

1. Divide the cadets into groups of no more than four.

2. Provide each group with a sheet of flip chart paper and a marker.
3. Read the scenario in the note box to the cadets.



**Scenario**

Your cadet unit decided to conduct a three-day expedition in late fall. Prior to departure the weather and temperature was forecasted to be cool and partly sunny for most of the time but above the freezing point.

Starting out on the trek, the group travels for the first day. Camp is set up for the night and before lights out, some precipitation begins to fall. It is a cool night and all members decide to call it an early night and go to ground.

Waking up in the morning, the group is surprised to find 20 cm of snow on the ground. Luckily all members are prepared for the cool weather, and clothing and equipment will not be a problem. It is decided to continue the trek.

Before departing on the second day from base camp, it is noticeable that the snow is hanging in the trees and makes a solid layer of cover on the ground. While navigating, some members are finding it difficult, to identify features to orient the map.

4. Ask the cadets the following question and have them record their answers in point form on the flip chart paper, large enough to read from a distance.
  - (a) When navigating, a person uses specific features to orient and guide their route of travel. If you were on the trek in the scenario, what navigation catching features would you expect to be difficult, if not impossible, to use because of the layer of snowfall?
  - (b) Have the cadets brainstorm for 10 minutes then have each group post their flip chart paper on the wall and present the work to the group. Have one cadet from each group explain how they think snow will affect each of their answers.

**SAFETY**

N/A.

---

**CONFIRMATION OF TEACHING POINT 1**

---

The cadets' participation in the activity will serve as the confirmation of this TP.

**Teaching Point 2**

**Discuss the Three Most Common Factors That Can Reduce Visibility**

Time: 10 min

Method: Interactive Lecture

**VISIBILITY**

Visibility is the range or possibility of vision as determined by the conditions of light and atmosphere. In winter, people will experience a loss of visibility in blizzard conditions and at night.

**Darkness.** Typically most people will not be navigating after dark, but may choose to in the event they need to make up time. On nights when the moon is not visible, surroundings become shadowless, the horizon and distant features blend into the darkness and the snow absorbs light. Navigating on an overcast night is very difficult – if not impossible.

**Blowing Snow.** During this condition the wind picks up snow and whirls it about. The strength of the wind combined with snow creates a thick barrier that limits visibility.

**Falling Snow.** Falling snow can be so heavy at times that the milky colour of the air blends seamlessly into the equally milky and featureless snow-covered ground. If this occurs on terrain lacking trees or other vegetation, conditions of zero visibility occur. This condition is amplified with wind, creating a whiteout condition. During a whiteout in mountainous regions, a person may not be able to see sudden drop-offs.

---

## CONFIRMATION OF TEACHING POINT 2

---

### QUESTIONS

- Q1. What are three common factors which reduce visibility ?
- Q2. How does blowing snow affect visibility?
- Q3. What can create a whiteout condition?

### ANTICIPATED ANSWERS

- A1. Three common factors that reduce visibility are darkness, blowing snow, and falling snow.
- A2. Blowing snow affects visibility when the wind picks up snow and whirls it about. The strength of the wind combined with snow, creates a thick barrier that limits visibility.
- A3. A whiteout condition can be caused by falling snow that is so heavy at times that the milky colour of the air blends seamlessly into the equally milky and featureless snow-covered ground.

---

### Teaching Point 3

### Identify Weather Conditions and Discuss Their Impacts on Navigation in the Winter

Time: 10 min

Method: Interactive Lecture

**Wind.** Wind combined with cold temperatures is a marriage of harsh elements that can make a navigation exercise uncomfortable. Wind transports moisture into a storm at the surface and aloft which allows the storm to intensify and continue unabated. As a result, wind impacts navigation by contributing to the development of ground blizzards, falling snow blizzards and whiteouts.

**Fog.** Fog occurs when the air is unable to hold any more moisture and is caused when the temperature reaches the dew point. During this weather condition, a milky white mist forms above the surface of the ground. Fog is common during early mornings as the sun rises and will not dissipate until the sun heats the surface of the earth, causing an increase in air temperature. Fog will affect navigation by restricting visibility and obscuring navigational features.

**Snow.** Snow is a type of precipitation in the form of crystalline water that falls from clouds. As snow falls, it accumulates on the ground. This accumulation over time will affect navigation by:

- covering well-defined paths and routes; and
- reducing visibility during snowfall.

**Ground Blizzards.** Ground blizzards occur when the wind is strong enough to pick up snow from open surfaces and whirl it through the air causing blinding conditions. Typically, such ground blizzards occupy the air to a height of 9–12 m (30–40 feet). It is actually possible to look straight up and see perfectly clear, blue sky overhead.

Ground blizzards can negatively affect navigation by:

- reducing visibility to the point that you may be able to see only from 100 metres ahead.
- reducing the visibility of prominent landmarks or features visible to effectively determine position and direction through map orientation; and
- forcing the navigator to be more cautious and vigilant when map reading. The concentration required because of these conditions reduces speed and increases travel time.

**Falling Snow Blizzards.** Falling snow blizzards occur when a considerable amount of snow is falling. It can be so heavy at times that the milky colour of the air blends seamlessly into the equally milky and featureless snow-covered ground. This condition is amplified with wind and creates whiteout conditions.

Falling snow blizzards can negatively affect navigation by:

- creating dangerous situations of very poor visibility, to the point that one may be able to see only metres ahead of oneself;
- making it impossible to see surrounding prominent landmarks or features for navigation. A GPS or compass is all that can be relied upon; and
- forcing the navigator to be more cautious and vigilant when map reading. The concentration required because of these conditions reduces speed and increases travel time exponentially.

**Whiteouts.** Whiteouts are weather conditions of heavy, wind-driven snowstorms that obliterate all natural landmarks and are not uncommon in the mountains. Visibility and vegetation contrasts are severely reduced by snow and diffused lighting caused from an overcast cloud layer.

Whiteouts can negatively affect navigation by:

- creating dangerous situations of very poor visibility, to the point that one may be able to see only metres ahead of oneself;
- making it impossible to see surrounding prominent landmarks or features for navigation. A GPS or compass is all that can be relied upon; and
- forcing the navigator to be more cautious and vigilant when map reading. The concentration required because of these conditions reduces speed and increases travel time exponentially.

---

### CONFIRMATION OF TEACHING POINT 3

---

#### QUESTIONS

- Q1. What is a ground blizzard and how will it impact navigation?
- Q2. What causes a whiteout?
- Q3. How will wind impact navigation?

#### ANTICIPATED ANSWERS

- A1. A ground blizzard is wind that is strong enough to pick up snow from open surfaces and whirl it through the air causing blinding conditions. Typically, such ground blizzards occupy the air to a height of 9–12 m (30–40 feet). Ground blizzards can negatively affect navigation by:
- reducing visibility to the point that one may be able to see only 100 m ahead of oneself;
  - reducing the visibility of prominent landmarks or features that are used to determine position and direction through map orientation; and
  - forcing the navigator to be more cautious and vigilant when map reading. The concentration required because of these conditions reduces speed and increases travel time.

- A2. A whiteout is caused by weather conditions of heavy, wind-driven snowstorms, obliterating all natural landmarks. Visibility and contrast are severely reduced by snow and diffused lighting from an overcast cloud layer.
- A3. Wind impacts navigation by contributing to the development of blizzards, falling snow blizzards and whiteouts.

---

**Teaching Point 4**
**Discuss the Application of Individual Navigation Skills in the Winter**

Time: 20 min

Method: Group Discussion

---

**BACKGROUND KNOWLEDGE**

---

**USING A TOPOGRAPHICAL MAP**

Winter conditions mask, distort and blend together many prominent features a navigator would use to orient a map. When navigating during winter conditions, a navigator will have to look beyond the simple easy to find features such as the trail ahead, a stream running nearby, or the cluster of boulders up ahead. All of these features are either covered by snow or have blended in with their surroundings making them indistinguishable. The features that can be used are:

- the mountains in the distance (contour lines),
- large bodies of water (open areas that are covered in ice),
- ridge lines,
- visible archways of known paths, and
- definable vegetation changes (open fields that change into forest).

When orienting the map, the navigator will now have to look beyond the immediate surroundings and view the distant landscape for identifiable features.

**IDENTIFYING OBJECTS ON THE GROUND WITH OBJECTS ON THE MAP**

Winter conditions distort navigation features. A well-defined island in a lake in the summer may blend into the background and look like the mainland in the winter. Seen from a distance, a bunch of small islands blend together and look like part of the mainland or like a big island that does not appear on the map.

In such situations where features become tricky to identify, good habits will help. For complicated areas full of bewildering features, keep checking position and progress by lining up, isolating, and checking ground features with the map. Predict what should come next; if the predictions are wrong stop and locate position.

**TAKING BEARINGS**

Before heading across a large body of frozen water, an open field, a valley or thick brush, take a bearing to the next checkpoint or destination from the current known position. Do this even in clear weather, whenever it is possible to support the direction of travel. If the winds build while crossing an open area or the weather changes, a group may become disoriented.



Taking a bearing before making the journey across a valley will ensure the person reaches their desired destination. If a person becomes disoriented because of a sudden change in

weather conditions, attempting to take a bearing on something they almost see will not work if they cannot identify where they are.

**Aiming Off.** Aiming off is a method to ensure the navigator will not get disoriented or lost by planning a deliberate error in direction.

When taking a bearing, the navigator identifies the desired destination (eg, a path at the end of a wide open field) and selects a point to shoot the bearing a few degrees left or right of the path. If a navigator shoots a bearing directly to the desired destination (the path at the end of a wide open field) and follows the bearing under conditions of poor visibility and the navigator travels off course just slightly, the navigator upon arrival at the end of the field will be in a position that is unknown. Trying to identify what side of the path they are on will be impossible and a guess will have to be made.

If the navigator follows the bearing directly to a point left of the desired destination, the navigator knows where the location of the path is (to the right of the current location). Aiming off is used when the navigator will lose site of the final destination or sudden loss of visibility is expected because of weather. The navigator, even if some error is made during travel, can be assured to travel one direction to find the desired destination (path, trail, road way etc).

## PACING

The pace counting method (pacing) is used for measuring a given distance by counting every other step. Two steps equal one pace. Pacing is a very important skill in navigation as each person has a different pace and needs to establish their pace before it can become a useful measurement tool. Pacing varies between individuals as it uses a natural stride – an average adult will pace about 60 to 70 paces in 100 m.

While navigating over snow-covered terrain, use pacing to help track distances covered. To determine an individual pace similar to summer treks, practice taking uniform, comfortable steps over a measured snow-covered distance (100 m) counting every second step of the dominant foot. Do this three to five times to get an average. This will be the individual's pace number and should be remembered.

## PLANNING A ROUTE

To plan a route during the winter, the navigator must consider the changes winter brings. Speed of travel, prominent features, and desired shelter all change. Routes will change; even arriving at the starting point may change. Consider the following:

- Where is the destination?
- How much snow has fallen and accumulated on the route?
- What are the snow conditions?
- Is it a defined well-travelled path?
- Is the path groomed?
- Will the route have readily identifiable navigational features (lakes, mountains, valleys, etc)?
- What is the weather forecast?
- Is the distance to the destination a possible goal considering the conditions?
- What is the skill level of the group?
- What is the mode of travel (foot, skis or snowshoe)?
- What will be the anticipated travelling speed of the group?
- Are there shelter options along the route in case of a storm?

## ENFORCING GROUP TRAVEL TECHNIQUES

Travelling on a clear day, maintaining direction and staying within sight of party members is simple. However, consider walking across a 5-km (3-mile) stretch of an open lake in a blizzard with only a few metres of visibility, and trying to maintain direction without getting lost or losing sight of party members. This can be very difficult; however, the following practices can make such a trek a little easier:

- **Staying Within Sight of Each Other.** In a well-led, considerate group, members will adjust their pace to the slowest member. If caught in a storm, it is best to put the slowest person first in line. This way, normal stride and pacing will keep the group bunched up. Each person in line must be responsible to keep in sight, one person behind and one person ahead of them. No one should move until the last, or sweep, person is within sight of the second to last, and so on up the line. When each person is in sight of the next, the whole line can continue to move. Following this rule, the line functions even when visibility is so poor that each person can see only one person in each direction.
- **Assigning Numbers.** Groups travelling may find it more comforting to use numbers to identify each member in a group. Once the order is established, the person in the rear of the party is assigned the first number. This is sequentially followed to the lead person. At any time, any member of the group can call out for numbers and the group will number off starting with the rear person. Any numbers that are not accounted for indicates a missing person. The group can then stop and sort out the problem.
- **Taking Breaks as Required.** While trekking along a route, the leader can schedule routine rest stops. During these stops count the group members. This ensures all members are accounted for and provides time to address any issues.

## GROUP DISCUSSION



### TIPS FOR ANSWERING/FACILITATING DISCUSSION

- Establish ground rules for discussion, eg, everyone should listen respectfully; don't interrupt; only one person speaks at a time; no one's ideas should be made fun of; you can disagree with ideas but not with the person; try to understand others as much as you hope they understand you; etc.
- Sit the group in a circle, making sure all cadets can be seen by everyone else.
- Ask questions that will provoke thought; in other words avoid questions with yes or no answers.
- Manage time by ensuring the cadets stay on topic.
- Listen and respond in a way that indicates you have heard and understood the cadet. This can be done by paraphrasing their ideas.
- Give the cadets time to respond to your questions.
- Ensure every cadet has an opportunity to participate. One option is to go around the group and have each cadet answer the question with a short answer. Cadets must also have the option to pass if they wish.
- Additional questions should be prepared ahead of time.

## SUGGESTED QUESTIONS

- Q1. How would using a topographical map in the winter be different than in the summer?
- Q2. What features are more noticeable during winter months?

- Q3. You come upon a open field that stretches 5 km (3 miles) long. Your destination is a small inlet along the vegetation line directly across the field. There are definable mountains all around that make orienting the map easy. There is light snow falling; visibility at the moment is good. If you were handed the map and asked to lead the group across the field to the inlet, how would you proceed across the field safely, to arrive at your destination?
- Q4. How would pace be affected in the winter? How would you test your pace prior to leaving on a trek in the winter?
- Q5. What are some techniques a group could use when in a storm to ensure members do not get separated from the group? What are some other methods you may have used?

### ANTICIPATED ANSWERS

- A1. Using a topographical map in the winter would be different because when orienting the map the navigator will now have to look beyond the immediate surroundings and view the distant landscape for identifiable features.
- A2. The features that are more noticeable during winter months are:
- the mountains in the distance (contour lines),
  - large bodies of water (open areas that are covered in ice),
  - ridge lines,
  - visible archways of known paths, and
  - definable vegetation changes (open fields that change into forest).
- A3. The safest method to navigate across the field would be to shoot a bearing aiming off to one side of the destination. Once arriving at the vegetation line, follow the edge opposite the direction you aimed off (left or right) to the destination. At any time, the winds could pick up and without a bearing you would not know what direction to travel.
- A4. Pacing would be affected in winter by the different conditions of the terrain being covered. Snow conditions, depth and the personal equipment you are using will all affect pace. To determine an individual pace similar to summer treks, practice taking uniform, comfortable steps over a measured snow-covered distance (100 m) counting every second step of the dominant foot. Do this three to five times to get an average. This will be the individual's pace number and should be remembered.
- A5. The techniques that can be used to ensure no members get separated from the group are making sure members stay in sight of each other, assigning numbers and taking scheduled breaks.



Other questions and answers will develop throughout the group discussion. The group discussion should not be limited to only those suggested.



Reinforce those answers given and comments made during the group discussion, ensuring the teaching points have been covered.



---

### CONFIRMATION OF TEACHING POINT 4

---

The cadets' participation in the group discussion will serve as the confirmation of this TP.

---

#### Teaching Point 5

#### Conduct an Activity Where the Cadet Will Practice Navigating in the Winter

Time: 60 min

Method: Practical Activity

---

### ACTIVITY

---

#### OBJECTIVE

The objective of this activity is to have the cadets practice navigating in the winter.

#### RESOURCES

- Topographical map (one per cadet),
- Magnetic compass (one per cadet), and
- Prepared navigation route.

#### ACTIVITY LAYOUT

The navigational activity must take place in an area with snow-covered surroundings away from most man-made features.

#### ACTIVITY INSTRUCTIONS

1. Provide each cadet with a topographical map and a compass.
2. Have cadets navigate a short predetermined route that crosses open terrain.
3. Have cadets practice aiming off of their destinations when trekking across the open area.
4. Have cadets practice group travel techniques.
5. Periodically stop cadets and have them orient their maps. Point out conflicting features and discrepancies between visual features compared to map based features. Identify the prominent features that will identify position.

#### SAFETY

First aid equipment and a device for communicating with base camp are to be carried in case of emergency.

---

### END OF LESSON CONFIRMATION

---

The cadets' participation in the navigation activity will serve as the confirmation of this lesson.

---

### CONCLUSION

---

#### HOMEWORK/READING/PRACTICE

N/A.

## **METHOD OF EVALUATION**

N/A.

## **CLOSING STATEMENT**

Cadets who a participating in a trek in the winter may suddenly experience a rapid deterioration in weather conditions. Using winter navigational skills can ensure the group remains on course and arrives safely at their destination.

## **INSTRUCTOR NOTES/REMARKS**

Corps may choose to schedule and instruct only TPs 1–4.

---

## **REFERENCES**

---

- C2-158 (ISBN 0-07-136417-X) Conover, G., & Conover, A. (2001). *The Winter Wilderness Companion: Traditional and Native AMERICAN Skills for the Undiscovered Season*. Camden, ME: Ragged Mountain Press.
- C2-160 (ISBN 0-89886-947-1) Lanza, M. (2003). *Winter Hiking and Camping: Managing for Comfort and Safety*. Emmaus, PA: The Mountaineers Books.
- C2-161 (ISBN 1-878239-09-0) Gorman, S. (1991). *AMC Guide to Winter Camping: Wilderness Travel and Adventure in the Cold-Weather Months*. Boston, MA: Appalachian Mountain Club Books.



**ROYAL CANADIAN ARMY CADETS**  
**SILVER STAR**  
**INSTRUCTIONAL GUIDE**



**SECTION 9**

**EO C322.03 – IDENTIFY THE PRINCIPLES OF MAP-MAKING**

---

Total Time:

30 min

---

**PREPARATION**

---

**PRE-LESSON INSTRUCTIONS**

Resources needed for the delivery of this lesson are listed in the lesson specification located in A-CR-CCP-703/PG-001, Chapter 4. Specific uses for said resources are identified throughout the instructional guide within the TP for which they are required.

Review the lesson content and become familiar with the material prior to delivering the lesson.

Collect examples of different types of maps.

If available, photocopy an early explorer's map of the local area as a handout.

**PRE-LESSON ASSIGNMENT**

N/A.

**APPROACH**

An interactive lecture was chosen for this lesson to present background information on maps and map-making.

---

**INTRODUCTION**

---

**REVIEW**

N/A.

**OBJECTIVES**

By the end of this lesson the cadet shall have identified the principles of map-making.

**IMPORTANCE**

It is important for cadets to be able to identify the principles of map-making because using maps is an integral component of expedition activities. Cadets will be required to use a variety of maps throughout their cadet career. Knowing how maps are made will provide the cadets with additional background information that they can use to assist them in navigating. As well, maps are something used in everyday life, whether travelling from home to a relative's house or hiking in a provincial park. Maps show a user where they are going and how they are going to get there.

**Teaching Point 1****Discuss Maps**

Time: 5 min

Method: Interactive Lecture



This TP is a review of material presented in previous star levels. Cadets should already have a clear understanding of what a map is. Guide the cadets, through leading questions, to ensure that they understand the main concepts.

Once a person understands the “language” of a map, they will be able to go anywhere.

**WHAT IS A MAP**

A map is a scale, or proportionately smaller, representation of the ground that uses universally accepted symbols to represent both natural and man-made features found on the ground.

**TYPES, CHARACTERISTICS AND FEATURES OF MAPS**

There are many types of maps, each determined by the purpose for which it is designed.

**Topographical Map.** A topographical map is the most common map used by the military. The purpose of a topographical map is to present a picture of the ground as it really exists. Topographical maps show as much detail as the scale allows, generally 1 : 25 000, 1 : 50 000, or 1 : 250 000. Features on a topographical map include physical features of the ground – rivers, woods, contours, roads, buildings, etc – as well as names of specific features – towns, villages, rivers, etc.

**Orienteering Map.** Through the International Orienteering Federation (IOF), specific rules and standards have been set for the production of an orienteering map, including colour, symbols, and scales. It is more detailed than a topographical map, both with reference to vegetation and landforms. They are usually produced in a scale smaller than 1 : 10 000.

**Street and Road Map.** A street and road map is designed to assist commuters and tourists to locate key sites such as roads and highways, police stations, fire halls, hospitals, schools and parks.

**Relief Map.** A relief map is a three-dimensional representation, usually of terrain. The terrain elevation is usually exaggerated by a factor between five and ten. This helps to recognize the terrain features.

**Digital Map.** A digital map, such as those found on computer programs and when using a GPS receiver, is useful as a reference tool as it is updated regularly. This allows a digital map to be a more accurate reference than other types of maps.

**Political Map.** A political map shows countries, provinces or other political borders—eg, globes and atlases.

**Statistical Map.** A statistical map shows statistical information such as the population, and production levels of crops or minerals across a country.

**Outline Map.** An outline map shows only borders, rivers, coastlines, etc.

**CONFIRMATION OF TEACHING POINT 1****QUESTIONS**

Q1. What is a map?

Q2. What type of map is most commonly used by the military?

Q3. What type of map provides a three dimensional representation of terrain?

### ANTICIPATED ANSWERS

- A1. A map is a scale, or proportionately smaller, representation of the ground that uses universally accepted symbols to represent both natural and man-made features.
- A2. A topographical map is the most common map used by the military.
- A3. A relief map is a three-dimensional representation, usually of terrain.

---

### Teaching Point 2

### Discuss Cartography

Time: 5 min

Method: Interactive Lecture

---



Cartography will be a new concept for most cadets. Have a flip chart detailing the main headings of the TP as a visual aid for cadets.

### CARTOGRAPHY

Cartography, as defined by the International Cartographic Association, is a discipline which deals with the conception, production, dissemination and study of maps. In essence, cartography is the entire process of mapping. Cartography is also an academic discipline, which deals not only with the people who make maps, but also with the people who teach about, and complete research on maps. It is an ever-changing, complex field, which has the process of map-making at its centre and all functions related to map-making surrounding it.

### TWO ESSENTIAL CHARACTERISTICS OF CARTOGRAPHY

#### Level of Importance to Society

The Canadian Cartographic Society states that maps perform a fundamental and indispensable role as one of the key elements of civilization. Few, if any, activities related to the earth's surface – property ownership, road construction, emergency response, and navigation – would be possible without maps.

#### Dynamic Nature

The discipline of cartography is continuously changing. Map-making has always been impacted by technological change; however, the speed with which technology is advancing has enormous implications. While there are still some who use pen and ink techniques for map-making, the majority of maps have been developed using the very latest computer hardware and graphic software. Today images are being generated faster and with less cost, and this will continue to improve with further advances in technology.

### ROLE OF A CARTOGRAPHER

Most cartographers are employed in map-making occupations, although, that does not mean they do the same job. A cartographer's job depends on individual specialties and areas of interest.

The following are basic tasks that are generally performed, in some capacity, by all cartographers:

**Liaising.** Cartographers do not work in isolation. There is a requirement for them to work with outside agencies. It is their responsibility to discuss and set guidelines for the project with the client.

**Editing.** Editing encompasses a number of tasks, including the evaluation and processing of data; selecting scales and projections; making design decisions; drawing up flow charts and specifications; preparing compilations; and checking the final product.

**Drafting.** This is the process of constructing the map image. It is completed using a combination of hand – pen and ink work, scribing, etc – and computer methods.

**Researching.** A cartographer will have to complete research: search out suitable data for a specific map; analyze output from Global Information Systems (GIS); scientifically study maps and map-making and map-reading processes; and develop new techniques for map-making.

**Teaching.** Many cartographers work as teachers in colleges and universities.

---

## CONFIRMATION OF TEACHING POINT 2

---

### QUESTIONS

- Q1. What is the definition of cartography?
- Q2. What activities would be impossible without maps?
- Q3. The process of constructing the map image is what job of a cartographer?

### ANTICIPATED ANSWERS

- A1. Cartography, as defined by International Cartographic Association, is a discipline which deals with the conception, production, dissemination and study of maps.
- A2. Any activities related to the earth's surface – property ownership, road construction, emergency response and navigation – would be impracticable without maps.
- A3. Drafting is the process of constructing the map image.

---

### Teaching Point 3

### Identify the Principles of Map-Making

Time: 15 min

Method: Practical Activity

---



Map-making has become a technologically based skill. Understanding the principles of making a map by hand is still very important. Cadets will be introduced to the four-step process used to develop a map during this TP.

Before people took pictures from airplanes, maps were drawn by someone travelling over the terrain and drawing by hand. With aerial photography, map-making has become much easier—but still requires a great deal of work from the map-maker (cartographer).

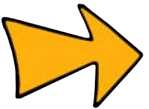

Much of Canada was mapped by hand by European explorers like Champlain, Tyrell, MacKenzie and Thompson.



If available, distribute a copy of an early explorer's map of the local area.

### STEP 1 – DETERMINING LOCATION

The first step in preparing a map is for the individual to determine their current location. The location of any point or place on the earth's surface can only be understood with reference to its distance from another point or place.

The easiest way to do this is to use landmarks. Landmarks are features that are man-made – houses, buildings, railroads, churches – or natural – a river, lakes, forested areas.



Have the cadets list 'landmarks' which could be in a classroom. These may include desks, chairs, windows, chalkboard, door, tables, OHP, etc.



The exact location of an object must be determined, to ensure that the map-user can easily find the site depicted without depending on another person for guidance. To make this possible, the earth's surface has been divided into a grid system of imaginary lines – lines of longitude (eastings) and lines of latitude (northings) – which provide map-makers with the ability to place and locate landmarks with precision.

#### LATITUDE (NORTHINGS)

LONGITUDE (EASTINGS)

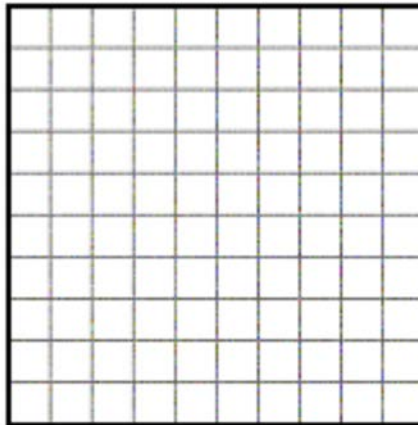

*Director Cadets 3, 2008, Ottawa, ON: Department of National Defence*

Figure 13-9-1 Representation of Lines of Longitude and Latitude

### STEP 2 – DETERMING PROJECTION AND SCALE

Any type of representation of the earth's surface on a flat piece of paper will have distortions because the world is round. These are relatively insignificant on maps that show only small parts of the earth, like street and road maps or 1 : 50 000 scale maps, but are quite considerable for maps of countries and continents.



Cadets will not be required to determine projection when developing a map. It is important that they are familiar with the concept, particularly Universal Transverse Mercator (UTM).

## Map Projection

Map projection is a geometrical method of reducing the amount of distortion on a flat map. In very large countries such as Canada, map-makers divide the country into strips from north to south, called zones, and project each zone.

**UTM.** UTM is a system of strip projection which is used by all National Topographical System maps. For UTM Projection, the earth's surface has been divided into 60 zones. Sixteen of these zones, numbered 7–22, cover Canada from west to east.

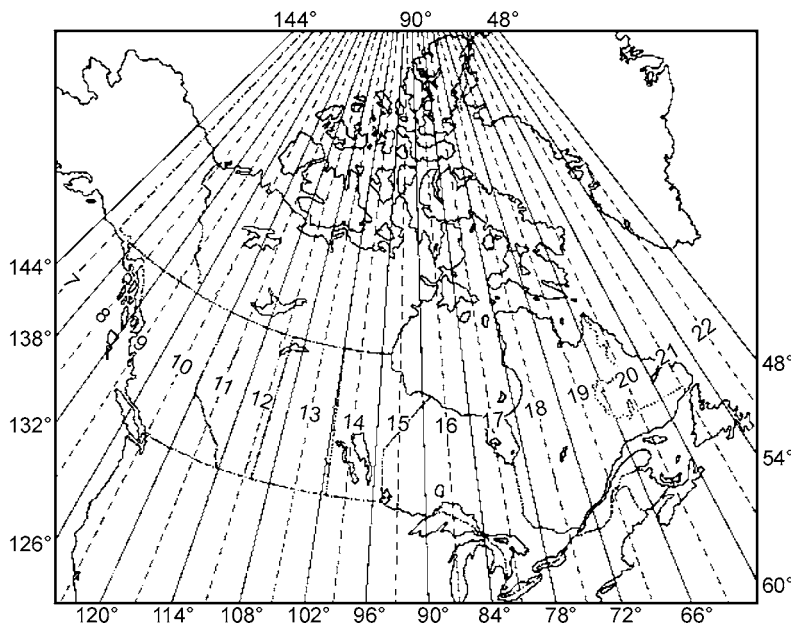

"Natural Resources Canada", *The Universal Transverse Mercator Grid*, Copyright 1969 by Department of Energy, Mines and Resource Canada, Surveys and Mapping Branch, Ottawa, ON. Retrieved April 4, 2008, from [http://maps.nrcan.gc.ca/topo101/utm2\\_e.php](http://maps.nrcan.gc.ca/topo101/utm2_e.php)

Figure 13-9-2 UTM Zones – Canada

## Scale

Modern maps share one thing in common, they are all drawn to scale – meaning they are exact representations of the area they illustrate. The scale of a map is an expression of the ratio between one unit on the map and the distance it covers, in the same units, on the ground.

For example:

If 2 cm on a map, represents 1 km on the ground, the scale is 2 cm = 1 km.



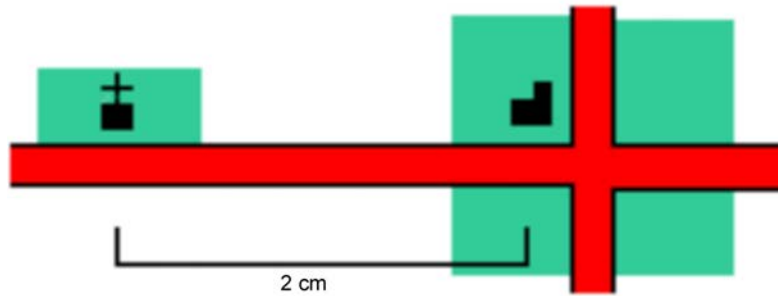

"Natural Resources Canada", Map Scale, Copyright 1969 by Department of Energy, Mines and Resource Canada, Surveys and Mapping Branch, Ottawa, ON. Retrieved April 4, 2008, from [http://maps.nrcan.gc.ca/topo101/scale\\_e.php](http://maps.nrcan.gc.ca/topo101/scale_e.php)

Figure 13-9-3 Scale – Map

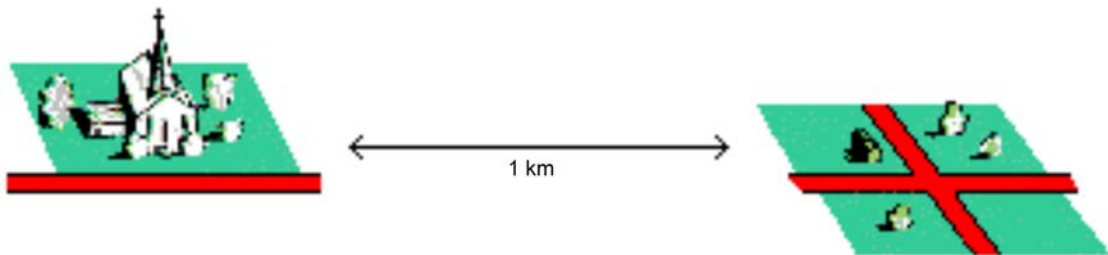

"Natural Resources Canada", Map Scale, Copyright 1969 by Department of Energy, Mines and Resource Canada, Surveys and Mapping Branch, Ottawa, ON. Retrieved April 4, 2008, from [http://maps.nrcan.gc.ca/topo101/scale\\_e.php](http://maps.nrcan.gc.ca/topo101/scale_e.php)

Figure 13-9-4 Scale – Real Distance

Another way to represent scale would be:

$$\frac{\text{DISTANCE ON THE MAP}}{\text{DISTANCE ON THE GROUND}} = \frac{2 \text{ cm}}{1 \text{ km}} = \frac{2 \text{ cm}}{100\,000 \text{ cm}}$$

$$= \frac{1}{50\,000}$$

$$= \mathbf{1: 50\,000 \text{ SCALE}}$$

"Natural Resources Canada", Map Scale, Copyright 1969 by Department of Energy, Mines and Resource Canada, Surveys and Mapping Branch, Ottawa, ON. Retrieved April 4, 2008, from [http://maps.nrcan.gc.ca/topo101/scale\\_e.php](http://maps.nrcan.gc.ca/topo101/scale_e.php)

Figure 13-9-5 Scale Representation



Ask cadets what scale should be used when drawing a map of the classroom. The scale should be in cm, given the size of a classroom. The scale ratio will be very small, as the map will show great detail. Figures 13-9-6 and 13-9-7 are examples of the scale.



For the map of the classroom the scale will be 1 : 50. This means that 1 cm on the map is equal to 0.5 m (50 cm) on the ground.

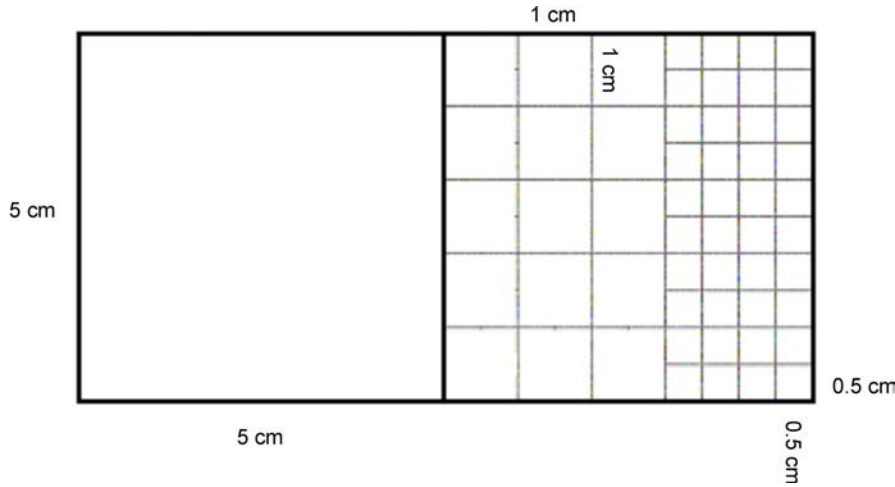

*Director Cadets 3, 2008, Ottawa, ON: Department of National Defence*

Figure 13-9-6 Grid Square

**SCALE 1/50**

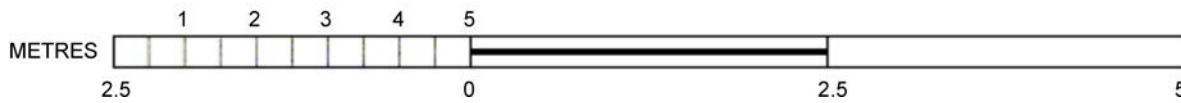

*Director Cadets 3, 2008, Ottawa, ON: Department of National Defence*

Figure 13-9-7 Map Scale

### STEP 3 – IDENTIFYING FEATURES AND ADDING SYMBOLS

Once the map's projection and scale are determined, the next step is to add features of the physical landscapes that will most accurately and vividly represent the area being mapped. This is done by simplifying the features using symbols and colours.

**Map Symbols.** Map symbols are graphic images that represent something else. They may be depicted by pictorial images, abstract combinations of points and lines, or tonal shading and colour tints.



Have a selection of maps available so cadets can see the types of symbols used.

Map-makers use a key or legend to indicate what symbols represent. On topographical maps, this legend is included on the back of the map and sometimes in the map margin.



Have the cadets brainstorm symbols which correspond to the features they previously identified in the classroom. An example is an "x" to symbolize a chair.

## Placing Symbols on the Map

Once the appropriate symbols have been identified, the map-maker must place them on the map. This is done by:

1. measuring the distance of the area/location which is to be mapped and marking this on the graph paper;
2. selecting a reference point. This could be the centre of the area being mapped, one of the four corners, etc;
3. selecting and plotting the first feature by placing the symbol on the map. This initial feature should be something that is known and easily transferred from the ground to the map;



All maps are drawn from a reference point. The reference point is called the datum. Most map datum only cover a portion of the earth, like the North American Datum of 1927 (NAD-27), which only covers the continent of North America.

4. selecting the next feature, measuring the distance and direction between it and the initial feature, and then placing the symbol on the map; and

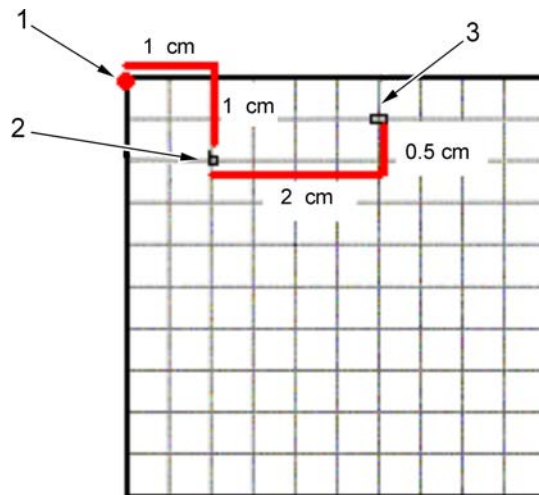

*Director Cadets 3, 2008, Ottawa, ON: Department of National Defence*

Figure 13-9-8 Adding Symbols to the Map



In the example in Figure 13-9-8, the map-maker:

1. selected the reference point – the northeast corner of the classroom;
  2. measured the actual position (0.5 m across, 0.5 m down), then plotted the symbol in the correct location using the scale (1 cm across, 1 cm down); and
  3. selected the next feature, the desk, and measured the actual distance across from the chair and then up to the desk (1 m [2 cm] by 0.25 m [0.5 cm]).
5. for each new feature added to the map, measuring its position in relation to those already added.

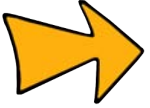

The map-maker should add symbols one grid square at a time.

#### **Step 4 – APPLYING GEOGRAPHICAL NAMES TO FEATURES**

The final step in the making of a map is selecting and applying geographical names that identify relevant features, landmarks, and places. Geographical names are fundamental elements of maps.



At this point most natural landmarks have already been named.

---

### **CONFIRMATION OF TEACHING POINT 3**

---

#### **QUESTIONS**

- Q1. Determining location is the first step in making a map. What is the easiest way to do this?
- Q2. What is map projection?
- Q3. The scale of a map is an expression of what type of ratio?

#### **ANTICIPATED ANSWERS**

- A1. The easiest way to determine location is to use landmarks. Landmarks are features that are man-made – houses, buildings, railroads, churches – or natural – a river, lakes, forested areas.
- A2. Map projection is a geometrical method of reducing the amount of distortion on a flat map. In very large countries such as Canada, map-makers divide the country into strips from north to south, called zones, and project each zone.
- A3. The scale of a map is an expression of the ratio between one unit on the map and the distance it covers, in the same units, on the real ground.

---

### **END OF LESSON CONFIRMATION**

---

#### **QUESTIONS**

- Q1. What is a map?
- Q2. What are the five basic functions that are generally performed, in some capacity, by all cartographers?
- Q3. What is the UTM?

#### **ANTICIPATED ANSWERS**

- A1. A map is a scale, or proportionately smaller, representation of the ground that uses internationally accepted symbols to represent both natural and man-made features.
- A2. The five basic functions that are generally performed, in some capacity by all cartographers are liaising, editing, drafting, researching and teaching.

- A3. The UTM is a system of strip projection which is used by all National Topographical System maps. For UTM projection, the earth's surface has been divided into 60 zones. Sixteen of these zones, numbered 7–22, cover Canada from west to east.

---

### CONCLUSION

---

#### HOMEWORK/READING/PRACTICE

N/A.

#### METHOD OF EVALUATION

N/A.

#### CLOSING STATEMENT

Being able to identify the principles of map-making is an important concept to understand because using maps is an integral component to the army cadet training program. Knowing how a map is made and developed will assist cadets in reading a map.

#### INSTRUCTOR NOTES/REMARKS

Cadets will be given the opportunity to create their own maps in EO C322.04 (Draw a Map of an Area in the Local Training Facility, Section 10).

---

### REFERENCES

---

- C2-166 Geomatics Yukon Kids. (2002). *Cartography*. Retrieved February 21, 2008, from <http://www.geomaticsyukpn.ca/kids/cartography1.html>.
- C2-168 EdGate. (2006). *Cartography Concepts: A Student's Guide to Mapmaking*. Retrieved February 21, 2008, from <http://www.edgate.com/lewisandclark/cartography.html>.
- C2-170 Gorman, J., & Morris, M. (Eds.). (1998, April). *You Are Here*. *The Backpacker*, April, 74–81.
- C2-190 The Canadian Cartographic Association. (2008). *Digital Pamphlet: Careers in Cartography*. Retrieved April 3, 2008, from <http://www.cca-acc.org/careers.asp>.

THIS PAGE INTENTIONALLY LEFT BLANK



**ROYAL CANADIAN ARMY CADETS**  
**SILVER STAR**  
**INSTRUCTIONAL GUIDE**



**SECTION 10**

**EO C322.04 – DRAW A MAP OF AN AREA IN THE LOCAL TRAINING FACILITY**

---

Total Time: 30 min

---

**PREPARATION**

---

**PRE-LESSON INSTRUCTIONS**

Resources needed for the delivery of this lesson are listed in the lesson specification located in A-CR-CCP-703/PG-001, Chapter 4. Specific uses for said resources are identified throughout the instructional guide within the TP for which they are required.

Review the lesson content and become familiar with the material prior to delivering the lesson.

Photocopy Annex F for each cadet.

**PRE-LESSON ASSIGNMENT**

N/A.

**APPROACH**

A practical activity was chosen for this lesson as it is an interactive way to allow the cadet to experience map-making in a safe, controlled environment. This activity contributes to the development of map-making skills in a fun and challenging setting.

---

**INTRODUCTION**

---

**REVIEW**

The following review is from EO C322.03 (Identify the Principles of Map-Making, Section 9):

**QUESTIONS**

- Q1. What are the four principles of map-making?
- Q2. Determine location is the first step in making a map. What is the easiest way to do this?
- Q3. The scale of a map is an expression of what type of ratio?

**ANTICIPATED ANSWERS**

A1. The four principles of map-making are:

- determine location;
- determine projection and scale;

- identify features and add symbols; and
- apply geographical names to features.

A2. The easiest way to determine location is to use landmarks. Landmarks can be in the form of manmade features – houses, buildings, railroads, churches—or natural features – rivers, lakes, forested areas.

A3. The scale of a map is an expression of the ratio between one unit on the map and the distance one unit covers on the ground.

## **OBJECTIVES**

By the end of this lesson the cadet shall have drawn a map of an area in the local training facility using the principles of map-making.

## **IMPORTANCE**

It is important for cadets to be able to draw a map of an area in the local training facility because understanding the concept of map-making will enhance the cadets' ability to read a map. Using maps is an integral component to the army cadet training program and it is critical that a cadet is able to use them effectively. Drawing a map, using the principles of map-making, will provide the cadet the opportunity to see a map as more than simply lines and symbols.

---

### **Teaching Point 1**

### **Have the Cadets Draw a Map of an Area in the Local Training Facility**

Time: 25 min

Method: Practical Activity

---

## **ACTIVITY**

---

### **OBJECTIVE**

The objective of this activity is for the cadet to draw a map of an area in the unit's local training facility.

### **RESOURCES**

- Graph paper located at Annex F,
- Paper (letter size),
- Measuring tape (one per group),
- Ruler (one per group),
- Pen/pencil,
- Markers/pencil crayons, and
- Notebook.

### **ACTIVITY LAYOUT**

N/A.

### **ACTIVITY INSTRUCTIONS**

1. Divide the cadets into groups of no more than three.
2. Assign each group an area in the local training facility to map.



3. Have each group draw a map, which includes:
  - (a) the name of the map,
  - (b) the scale of the map, and
  - (c) a legend of symbols.
4. Have each group present their map to the rest of the class.
5. Debrief the cadets discussing the practicality of making a map by hand, the difficulties they experienced, and what they learned from the activity.

### **SAFETY**

If cadets are mapping outside, there must be an adult supervisor with the group at all times.

---

### **CONFIRMATION OF TEACHING POINT 1**

---

The cadets' participation in the practical activity will serve as the confirmation of this TP.

---

### **END OF LESSON CONFIRMATION**

---

The cadets' participation in the practical map-making activity will serve as the confirmation of this lesson.

---

### **CONCLUSION**

---

### **HOMEWORK/READING/PRACTICE**

N/A.

### **METHOD OF EVALUATION**

N/A.

### **CLOSING STATEMENT**

Map reading is more than just looking at symbols and lines on a map. Participating in making a map will provide the cadet the opportunity to further understand how each symbol and line represents real features on the ground.

### **INSTRUCTOR NOTES/REMARKS**

This EO is to be scheduled after EO C322.03 (Identify the Principles of Map-Making, Section 9).

---

### **REFERENCES**

---

C2-168 EdGate. (2006). *Cartography Concepts: A Student's Guide to Mapmaking*. Retrieved February 21, 2008, from <http://www.edgate.com/lewisandclark/cartography.html>.

THIS PAGE INTENTIONALLY LEFT BLANK

### DECLINATION PROBLEM WORKSHEET

1. What is the declination for the following map where:

- a. the current year is 2010,
- b. the approximate mean declination is for 1998, and
- c. the annual change is increasing 10.0'?

12°22'

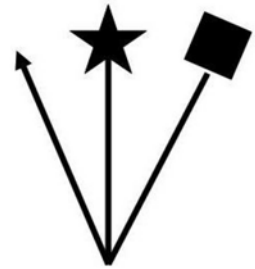

Answer: \_\_\_\_\_ East/West (circle one).

2. What is the declination for the following map where:

- the current year is 2011,
- the approximate mean declination is for 2001, and
- the annual change is decreasing 7.0'?

7°17'

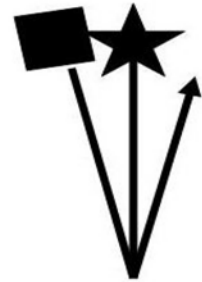

Answer: \_\_\_\_\_ East/West (circle one).

3. What is the declination for the following map:

- the current year is 2015,
- the approximate mean declination is for 2004, and
- the annual change is increasing 8.32'?

5°53'

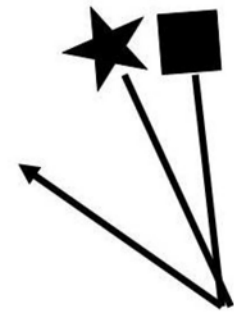

Answer: \_\_\_\_\_ East/West (circle one).

4. What is the declination for the following map:

- the current year is 2012,
- the approximate mean declination is for 1998, and
- the annual change is increasing 9.57'?

10°24'

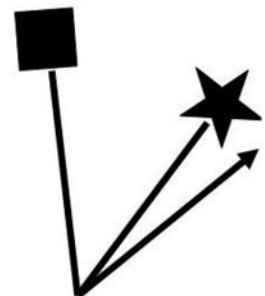

Answer: \_\_\_\_\_ East/West (circle one).

5. What is the declination for the following map:

- the current year is 2014,
- the approximate mean declination is for 2001, and
- the annual change is decreasing 18'.0?

9°30'

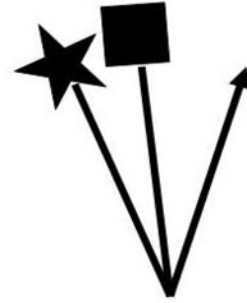

Answer: \_\_\_\_\_ East/West (circle one).

6. What is the declination for the following map:

- the current year is 2015,
- the approximate mean declination is for 2003, and
- the annual change increasing 2.0'?

17°45'



Answer: \_\_\_\_\_ East/West (circle one).

7. What is the declination for the following map:

- the current year is 2015,
- the approximate mean declination is for 2003, and
- the annual change is decreasing 11.0'?

14°12'

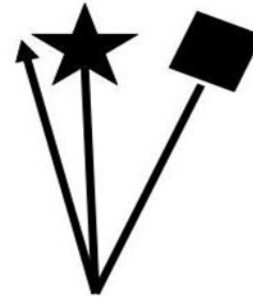

Answer: \_\_\_\_\_ East/West (circle one).

8. What is the declination for the following map:

- the current year is 2016,
- the approximate mean declination is for 2009, and
- the annual change is decreasing 2.7'?

7°39'



Answer: \_\_\_\_\_ East/West (circle one).

**ANSWER KEY TO DECLINATION PROBLEM WORKSHEET**

<b>DECLINATION WORKINGS</b>				<b>ANSWER</b>
1.	2010 - 1998 = 12	$12 \times 10 = 120^\circ$ $120 \div 60 = 2^\circ$	$12^\circ 22' + 2^\circ = 14^\circ 22'$	<b>14°22' W</b>
2.	2011 - 2001 = 10	$7^\circ \times 10 = 70'$ $70 \div 60 = 1^\circ 10'$	$7^\circ 17' - 1^\circ 10' = 6^\circ 07'$	<b>6°07' E</b>
3.	2015 - 2004 = 11	$11 \times 8.32 = 91.52$	$5^\circ 53' + 91'52'' = 5^\circ 144'52''$ $5^\circ 144'.52'' = 7^\circ 24'52'' = 7^\circ 25'$	<b>7°25' W</b>
4.	2012 - 1998 = 14	$14 \times 9.57' = 133.98$ $133.98 \div 60 = 2^\circ 13'98''$	$10^\circ 24' + 2^\circ 13.98' = 12^\circ 37.98''$	<b>12°38' E</b>
5.	2014 - 2001 = 13	$13 \times 18' = 234$ $234 \div 60 = 3^\circ 54'$	$9^\circ 30' - 3^\circ 54' = 5^\circ 36'$	<b>5°36' E</b>
6.	2015 - 2003 = 12	$12 \times 2' = 24'$	$17^\circ 45' + 24' = 18^\circ 09'$	<b>18°09' E</b>
7.	2015 - 2003 = 12	$12 \times 11' = 132'$ $132' \div 60 = 2^\circ 12'$	$14^\circ 12' - 2^\circ 12' = 12^\circ$	<b>12° W</b>
8.	2016 - 2009 = 7	$7 \times 2.7' = 18.9'$	$7^\circ 39' - 18.9' = 7^\circ 20'$	<b>7°20' W</b>

THIS PAGE INTENTIONALLY LEFT BLANK

**SIMULATED MAP DATUM**

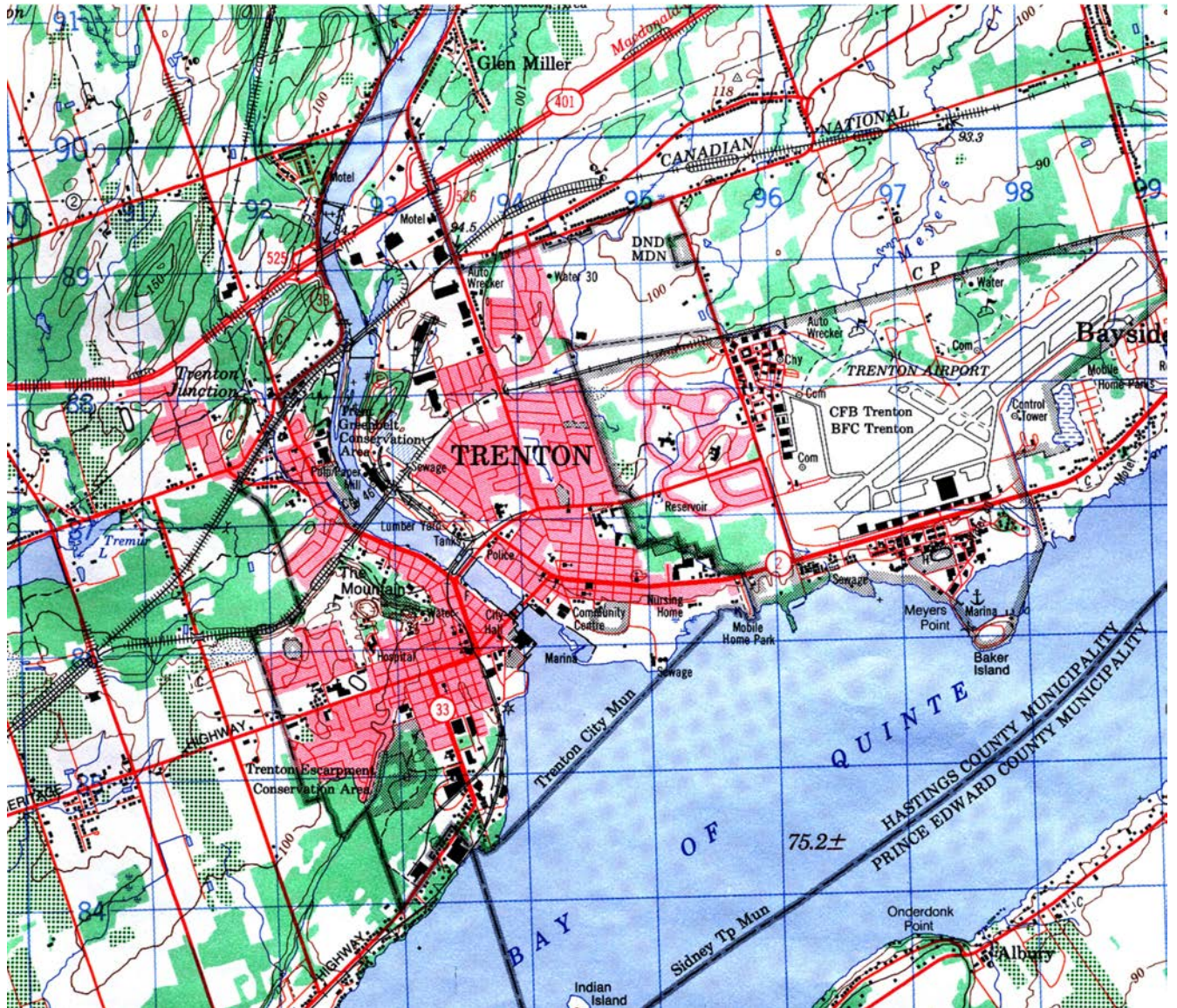

*Director Cadets 3, 2008, Ottawa, ON: Department of National Defence*

Figure 13C-1 Simulated Map for Making a Datum

THIS PAGE INTENTIONALLY LEFT BLANK



**GRID OVERLAY**

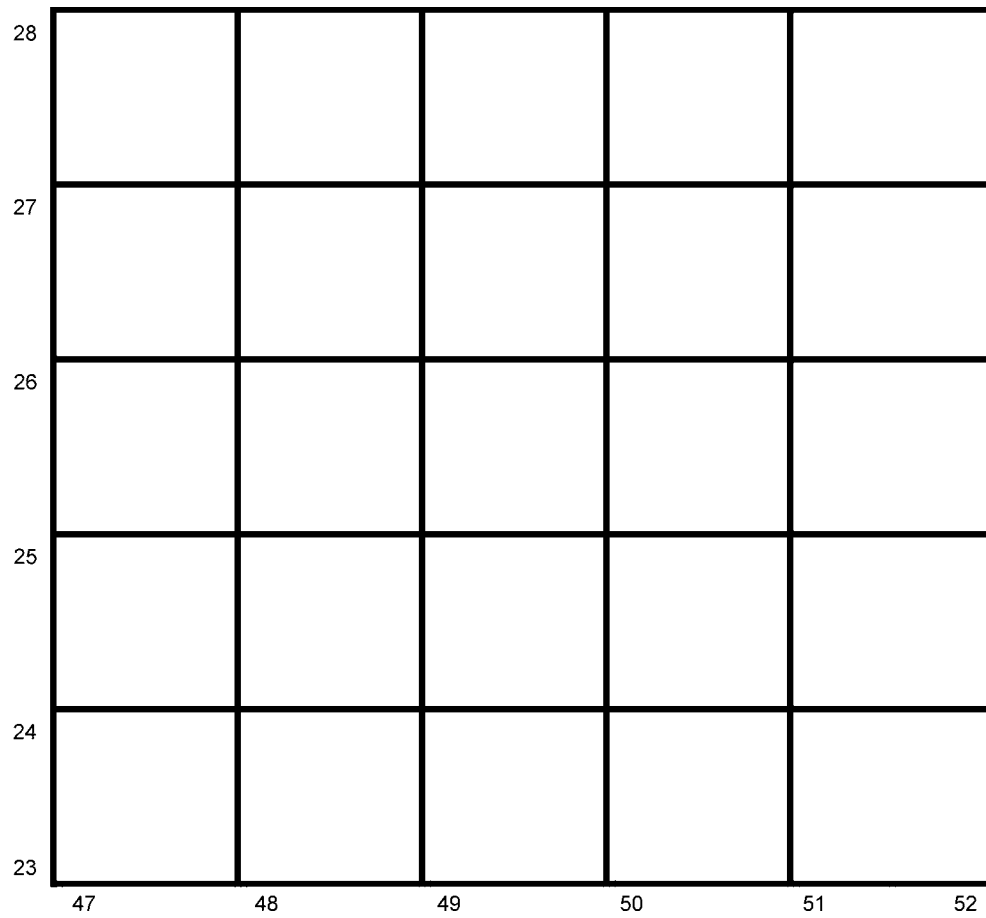

*Director Cadets 3, 2008, Ottawa, ON: Department of National Defence*

Figure 13D-1 Grid Overlay

THIS PAGE INTENTIONALLY LEFT BLANK

### CANADIAN UTM ZONES

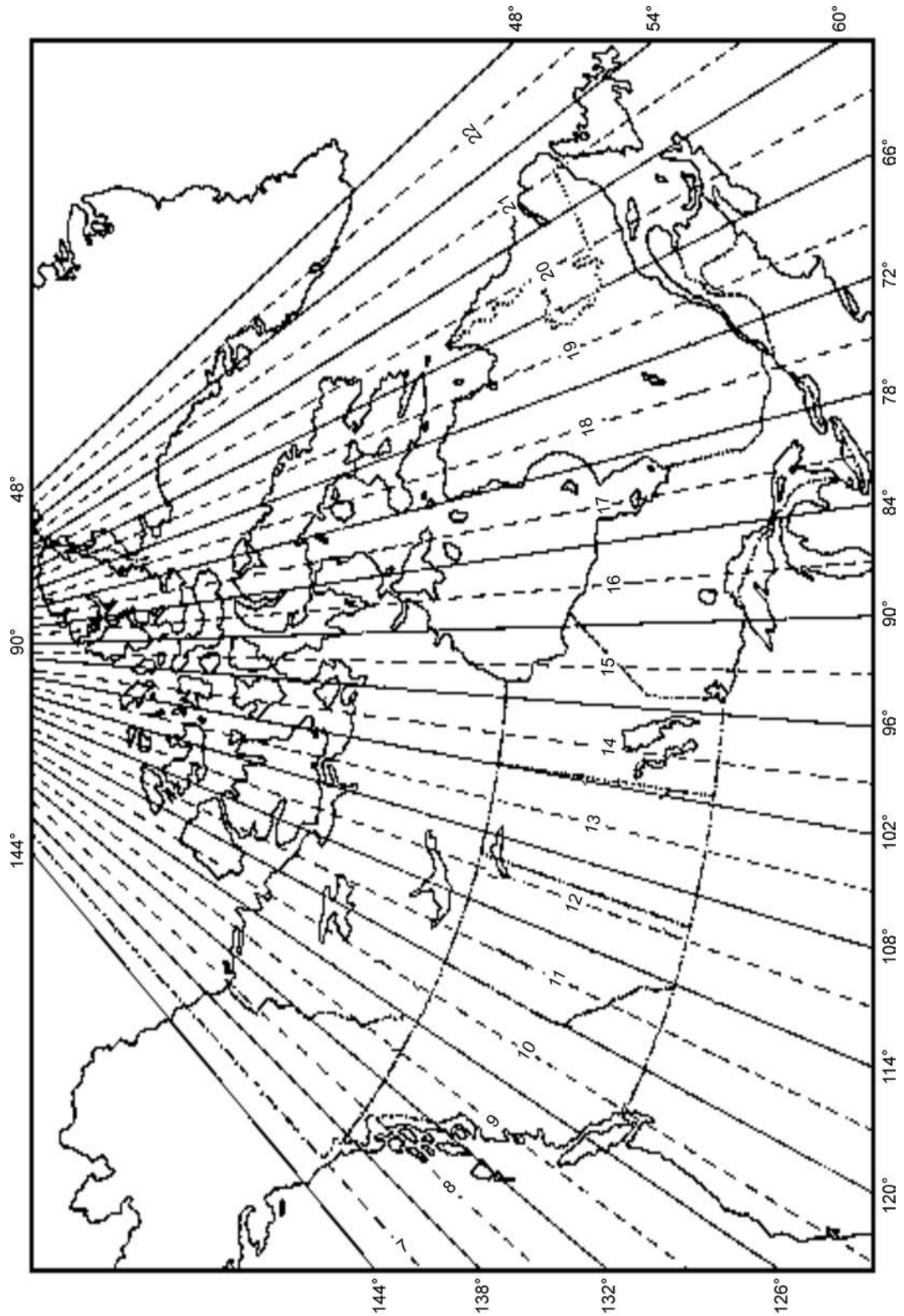

"Natural Resources Canada", *The Universal Transverse Mercator Grid*, Copyright 1969 by Department of Energy, Mines and Resource Canada, Surveys and Mapping Branch. Retrieved April 4, 2008, from [http://maps.nrcan.gc.ca/topo101/utm2\\_e.php](http://maps.nrcan.gc.ca/topo101/utm2_e.php)

Figure 13E-1 Canadian UTM Zones

THIS PAGE INTENTIONALLY LEFT BLANK

### GRAPH PAPER

Map of \_\_\_\_\_

Scale \_\_\_\_\_

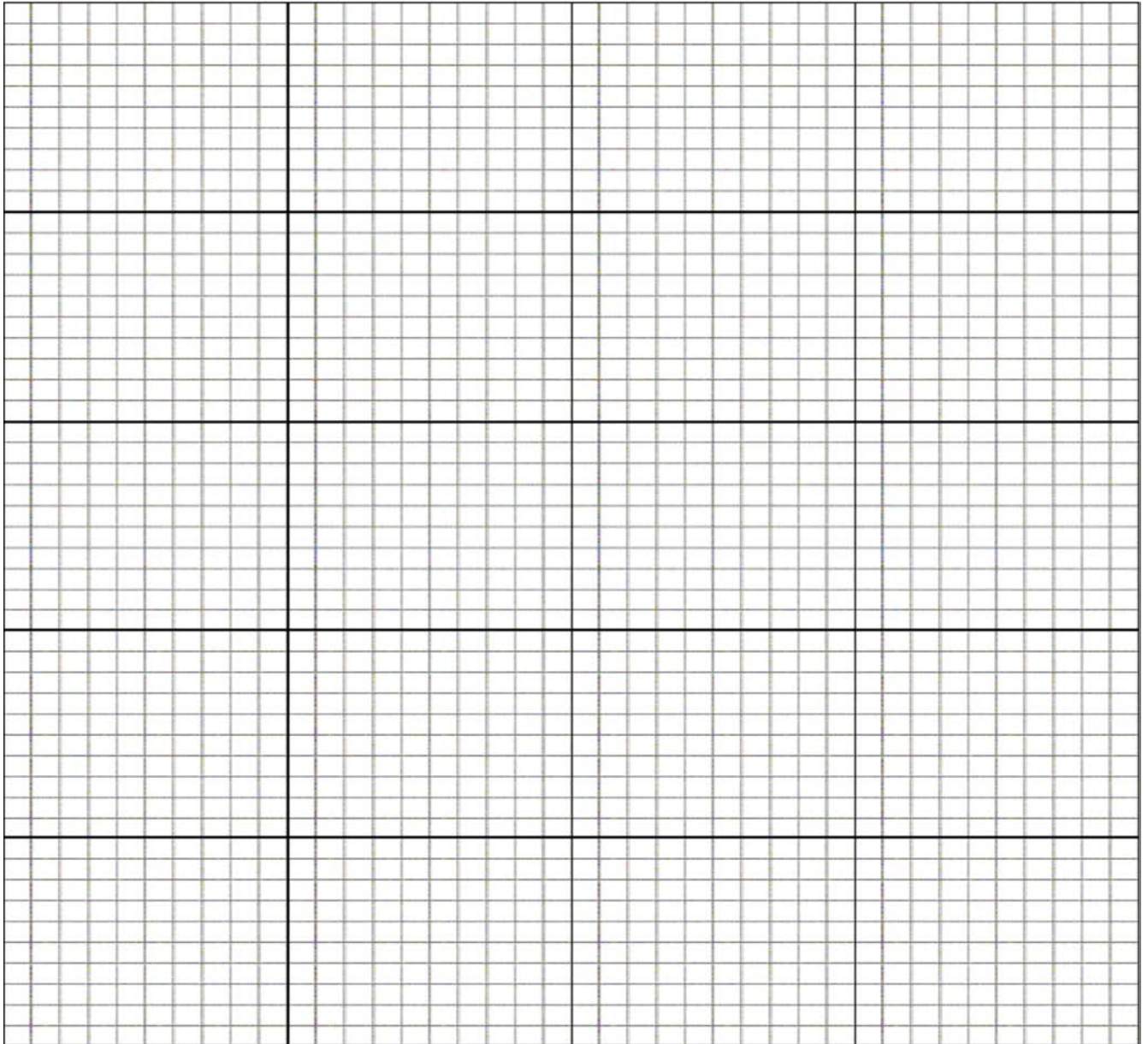

*Director Cadets 3, 2008, Ottawa, ON: Department of National Defence*

Figure 13F-1 Graph Paper

THIS PAGE INTENTIONALLY LEFT BLANK

**CHAPTER 14**  
**PO 324 – SURVIVE WHEN LOST**







**ROYAL CANADIAN ARMY CADETS**  
**SILVER STAR**  
**INSTRUCTIONAL GUIDE**



**SECTION 1**

**EO M324.01 – CONSTRUCT AN IMPROVISED SHELTER**

---

Total Time: 90 min

---

**PREPARATION**

---

**PRE-LESSON INSTRUCTIONS**

Resources needed for the delivery of this lesson are listed in the lesson specification located in A-CR-CCP-703/PG-001, Chapter 4. Specific uses for said resources are identified throughout the instructional guide within the TP for which they are required.

Review the lesson content and become familiar with the material prior to delivering the lesson.

Construct an example of each type of shelter. If adequate materials are unavailable, use a picture to illustrate the shelter.

**PRE-LESSON ASSIGNMENT**

N/A.

**APPROACH**

An interactive lecture was chosen for TP 1 to introduce factors to consider when selecting a site for an improvised shelter and present background information.

Demonstration and performance was chosen for TP 2 as it allows the instructor to explain and demonstrate constructing survival shelters while providing an opportunity for the cadets to practice under supervision.

---

**INTRODUCTION**

---

**REVIEW**

The review for this lesson will be from EO M224.01 (Identify Immediate Actions To Take When Lost, A-CR-CCP-702/PF-001, Chapter 14, Section 1).

**FIVE ELEMENTS OF SURVIVAL**

After successfully completing the S.T.O.P. (Sit, Think, Observe, Plan) action and recognizing a survival situation, the lost individual shall take inventory of all the food and equipment on hand and proceed to procure the five elements of survival. These are listed in order of priority:

1. **Attitude.** Maintaining a positive attitude is essential. One can survive by staying calm, using all available resources, and prioritizing personal needs.
2. **Shelter.** A shelter is designed to provide protection from the weather and, depending on the conditions, protect a person from either hot or cold temperatures. Hypothermia and hyperthermia are two of the

greatest dangers in a survival situation. A proper shelter can help prevent these from occurring. In a desert scenario, for example, the goal is to stay under a shelter, shaded from the effects of the sun. In cold weather situations, the shelter will provide insulation.

3. **Water.** Water is the most essential nutrient for the human body. Even when thirst is not extreme it can dull the mind. Lack of water will slowly degrade the ability to survive. With adequate shelter and water one can survive for weeks.
4. **Fire.** In a survival situation, fire provides heat and light, and signals for rescuers. Cold weather not only lowers the ability to think, but it also lowers one's will to do anything. Even a few degrees drop in body temperature can affect the ability to make reasonable decisions.
5. **Food.** Individuals in good physical condition can go for many days or even weeks without food. The goal in a wilderness survival situation is to be located in the shortest time possible, so in most cases one will be located long before food becomes a survival issue. However, it is always important to prepare for the worst and find ways to supply the body with substance, through berries, fish, animals, birds, etc.

### QUESTIONS

- Q1. What are the five elements of survival?
- Q2. What is the one essential nutrient the body requires to function?
- Q3. What does a shelter provide?

### ANTICIPATED ANSWERS

- A1. Attitude, shelter, water, fire and food.
- A2. Water.
- A3. Shelter provides protection from the weather and depending on the conditions, protects you from either hot or cold temperatures.

### OBJECTIVES

By the end of this lesson the cadet shall be expected to construct an improvised shelter.

### IMPORTANCE

It is important for cadets to know how to construct improvised shelters as a method of preventing boredom, as well as helping to combat the seven enemies of survival. Having a shelter that provides protection from the elements and is a source of motivation will increase chances of survival.

**Teaching Point 1****Select a Shelter Site**

Time: 25 min

Method: Interactive Lecture



The instruction area for this lesson should match the factors of site selection as detailed in TP 1 under terrain and location considerations.

By the end of this lesson cadets will be expected to construct an improvised shelter. Introduce this TP by presenting the cadets with a scenario where they have become lost in the field and they have only a few hours of daylight left.

Shelter is the first concern. The location chosen to demonstrate the selection of a site should meet most if not all considerations. Ask the cadets what they think about the location. These questions should get them thinking about considerations when choosing a site.

Continue this lesson by identifying the rest of the factors and considerations described in TP 1.

During the summer months the need for shelter is not thought of as a great concern. It should be, as the weather could change drastically, especially in hilly or mountainous areas. In winter, a survivor may be tempted to set up a fire first rather than tackle the job of building or finding a shelter. When discussing the five elements of survival, shelter is the second survival element. A shelter provides protection from the elements, particularly wind and precipitation. Shelters improve morale by providing comfort, security and a sense of accomplishment.

**TERRAIN CONSIDERATIONS**

There are several factors that must be considered when selecting a site. Locations to construct a shelter should meet certain criteria, to avoid being awoken during the night due to an overlooked problem.

**Select an Area Large Enough for the Shelter.** Possible sites that are perfect in their natural form may be too small to accommodate one person. Ensure that the site can comfortably, considering the situation, fit oneself for the duration of the survival situation.

**Select an Area That is Elevated and Provides Drainage.** A site should provide dry footing and drainage in the case of rain. Keep back from rivers or lakes which may flood after a rain fall.

**Identify Sheltered Areas That Protect From Wind, Rain and Sun.** Shelter from wind, rain and sun can be sought from boulders, hillsides, trees or other available sources. In the summer, a little breeze will reduce the number of insects and can keep one cool during hot summer days. During winter, a shelter will separate the body from wind and snow and provide warmth. If the entrance of the shelter faces leeward (away from the wind), rain or snow will swirl over and drop inside. If the entrance faces windward, smoke and ashes from the fire will blow into the shelter. Place the back of the shelter into the wind.

**LOCATION CONSIDERATIONS**

**Proximity to a Water Source.** The availability of a nearby water source will reduce the amount of energy expended while collecting water. A source of water may also provide fishing grounds that may supply food.

**Proximity to a Fuel Source.** Situating a shelter near a fuel source will reduce the amount of energy required to gather fuel for the fire.

**Proximity to Building Materials.** Although the shelter is an emergency shelter there is always the need to make what is natural more livable. Situating the shelter near building supplies will reduce the amount of energy required to build and secure the shelter.

**Proximity to Animal Trails or Holes.** In the wild, the food chain is active. Beware of locating your shelter near the natural paths animals create. Where there are animals, there may be danger.

**An Area That Can be Seen From the Air.** When lost in a wilderness area it is important to establish contact with or attract the attention of searchers and rescuers. Staying in a site that is easily seen from the air will increase the chance of being rescued.

**An Entrance That is Sheltered From the Wind and Preferably South Facing.** Situating the shelter so the prevailing wind is blowing against the rear will help ensure the occupant will be able to maintain some heat inside. Face the entrance, if possible, into the sun allowing sunshine into the shelter. This provides heat to the occupant.

### TIME REQUIRED TO BUILD THE SHELTER

Depending on the amount of time available, one may choose to construct a simple emergency shelter for the night. Estimate the amount of daylight left when constructing a shelter by looking at the horizon. If the sun is near the horizon, there is not much daylight left. One technique is to measure the number of hand widths between the sun and the horizon. Each hand will represent approximately one hour.

---

## CONFIRMATION OF TEACHING POINT 1

---

### QUESTIONS

- Q1. What are the terrain considerations one should take into account when selecting a shelter site?
- Q2. What are three location considerations that one should take into account?
- Q3. Which way should the entrance of a shelter face?

### ANTICIPATED ANSWERS

- A1. Select an area that is large enough for the shelter, elevated and provides drainage, and helps protect from the wind, rain and sun.
- A2. The location should be in close proximity to a water source, a fuel source, building materials, and in an area that can be seen from the air. It should also be far from animal trails or holes.
- A3. The entrance should face the leeward side (away from the wind).

---

### Teaching Point 2

### Demonstrate and Have the Cadet and a Partner Construct a Two Person Survival Shelter

Time: 60 min

Method: Demonstration and Performance

---



Cadets will construct the selected shelter using a groundsheet in place of a bough roof.

**BENT TREE SHELTER**

A bent tree shelter is prepared using a young sapling with a natural bend. Bend the tree and attach it to a second tree or secure to the ground with pegs. Place a groundsheet over the tree to protect the area from the weather. The curve of the sapling will drain water away from the shelter.

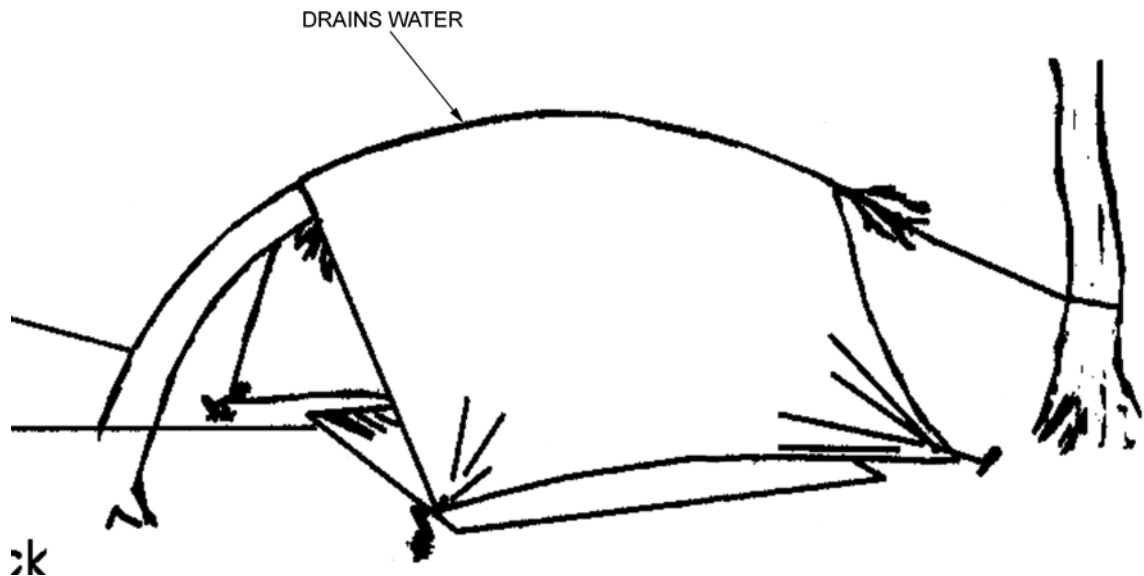

*P. Tawrell, Camping and Wilderness Survival: The Ultimate Outdoors Book, Paul Tawrell (p. 98)*

Figure 14-1-1 Bent Tree Shelter

## LEAN-TO WITH PONCHO

A poncho or groundsheet is perfect for constructing a lean-to. There are different variations on this shelter. The simplest form of a lean-to is secured to the ground and raised to allow enough head room for the tallest occupant to sit up. The groundsheet should be pulled tight between two trees or between two supports.

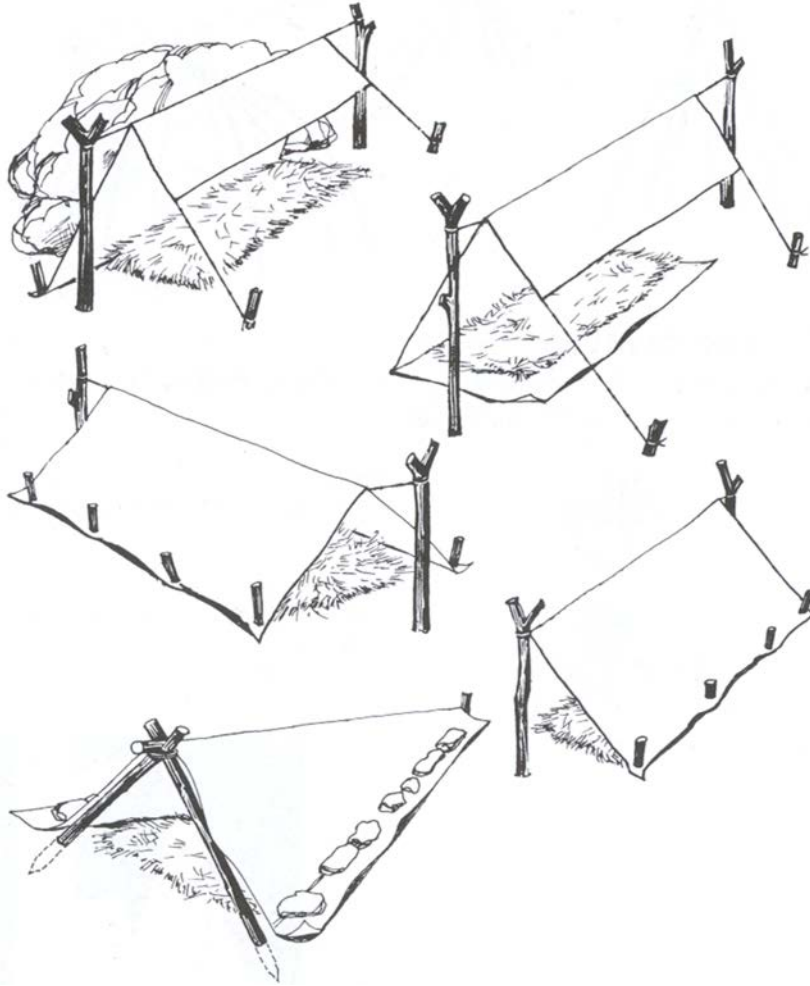

*J. Wiseman, The SAS Survival Handbook, HarperCollins Publishers (p. 245)*

Figure 14-1-2 Lean-To With Poncho

## BOUGH SHELTER

A bough shelter, also known as a lopped tree shelter, makes use of a fallen tree. With some preparation this shelter provides good cover from the elements. The fallen tree branches are cut from the centre of the tree, creating a hollow for shelter. The excess branches are woven through the remaining tree branches, making the shelter weatherproof.

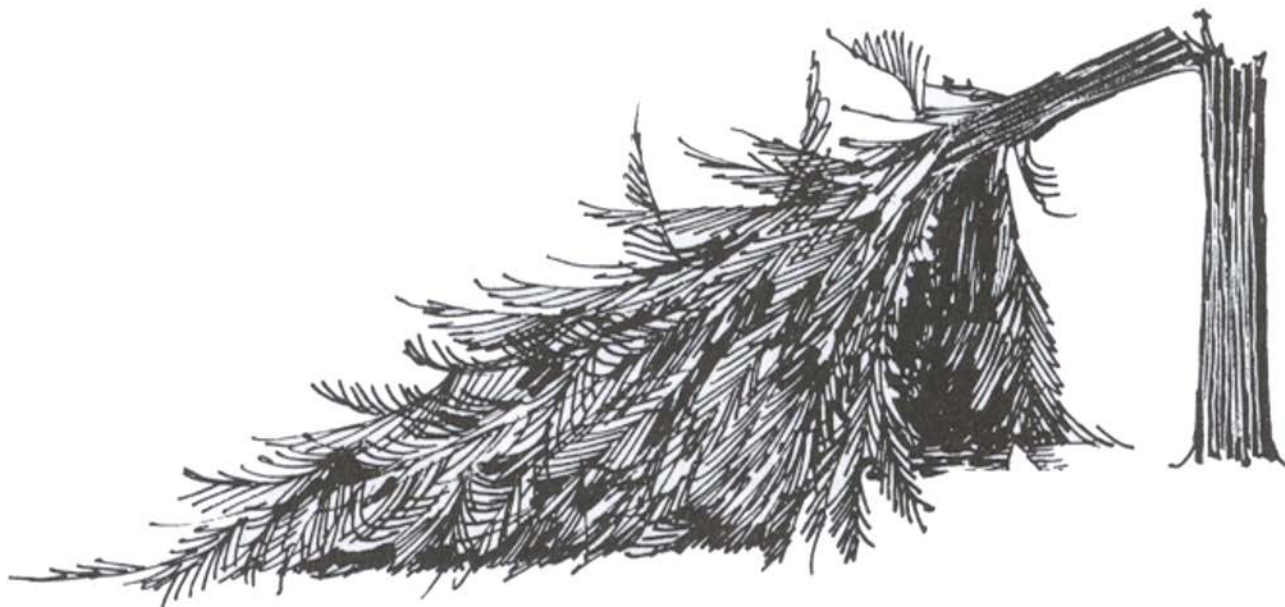

*J. Wiseman, The SAS Survival Handbook, HarperCollins Publishers (p. 245)*

Figure 14-1-3 Bough Shelter

## ROOT SHELTER

Protruding roots act as the frame for the shelter. Spreading roots and earth act as a wind barrier. Ideally a root shelter should be at a right angle to the wind. Digging into the remaining root system, or filling in the sides between the roots will make the shelter more effective.



*P. Tawrell, Camping and Wilderness Survival: The Ultimate Outdoors Book, Paul Tawrell (p. 98)*

Figure 14-1-4 Root Shelter

---

## ACTIVITY

Time: 40 min



Take time at the beginning of this activity to show the cadets the pre-constructed improvised shelters.

## OBJECTIVE

The objective of this activity is for the cadets to construct an improvised shelter.

## RESOURCES

- Groundsheet (one per cadet),
- Twine,
- Pocket knife (one per two cadets), and
- Sticks for pegging.

## ACTIVITY LAYOUT

An area in which each pair of cadets can build an improvised shelter.



**ACTIVITY INSTRUCTIONS**

1. Divide cadets into pairs (same gender).
2. Assign each pair the required resources.
3. Have cadets gather materials for building a shelter.
4. Have cadets construct a shelter. Cadets will check their shelters to ensure:
  - (a) there is room for two people to sleep and sit upright;
  - (b) the lines are secure; and
  - (c) it is waterproof.
5. Inspect the cadets' shelter to ensure it is well constructed and safe to sleep in.
6. Tear down shelters and distribute any materials back into the area.

**SAFETY**

- Cadets will respect boundaries for the activity.
- Cadets will ensure safe tool use at all times.

---

**CONFIRMATION OF TEACHING POINT 2**

---

The cadets' participation in the activity will serve as the confirmation of this TP.

---



---

**END OF LESSON CONFIRMATION**

---

The cadets' construction of an improvised shelter will serve as the confirmation of this lesson.

---



---

**CONCLUSION**

---

**HOMEWORK/READING/PRACTICE**

N/A.

**METHOD OF EVALUATION**

This EO is assessed IAW A-CR-CCP-703/PG-001, Chapter 3, Annex B, Appendix 6 (324 EC-01).

**CLOSING STATEMENT**

Knowing how to construct an improvised shelter in a survival situation will assist in maintaining the cadet's self-confidence and help in preventing the seven enemies of survival.

**INSTRUCTOR NOTES/REMARKS**

Prior to conducting this lesson the instructor shall locate an example of each type of shelter.

It is understood that seasonal differences and location may restrict the ability to construct all shelters; however cadets should be provided with as many visual examples as possible.

---

**REFERENCES**

---

- C2-004 (ISBN 1-896713-00-9) Tawrell, P. (1996). *Camping and Wilderness Survival: The Ultimate Outdoors Book*. Green Valley, ON: Paul Tawrell.
- C2-008 (ISBN 0-00-653140-7) Wiseman, J. (1999). *SAS Survival Handbook*. Hammersmith, London: HarperCollins Publishers.



**ROYAL CANADIAN ARMY CADETS**  
**SILVER STAR**  
**INSTRUCTIONAL GUIDE**



**SECTION 2**  
**EO M324.02 – COLLECT DRINKING WATER**

---

Total Time: 30 min

---

**PREPARATION**

---

**PRE-LESSON INSTRUCTIONS**

Resources needed for the delivery of this lesson are listed in the lesson specification located in A-CR-CCP-703/PG-001, Chapter 4. Specific uses for said resources are identified throughout the instructional guide within the TP for which they are required.

Review the lesson content and become familiar with the material prior to delivering the lesson.

**PRE-LESSON ASSIGNMENT**

N/A.

**APPROACH**

An interactive lecture was chosen for TPs 1 and 3 to give background information and introduce the cadets to methods of collecting water.

Demonstration was chosen for TP 2 as it allows the instructor to explain and demonstrate collecting water while providing an opportunity for the cadets to practice the skill under supervision.

---

**INTRODUCTION**

---

**REVIEW**

N/A.

**OBJECTIVES**

By the end of this lesson the cadet shall be expected to collect water using precipitation, dew or plant condensation.

**IMPORTANCE**

It is important for the cadets to understand the importance of collecting water in a survival situation, as thirst is one of the seven enemies of survival. As fresh water may not be readily available, cadets will have to use other sources to find water.

**Teaching Point 1****Identify Methods of Finding Water**

Time: 5 min

Method: Interactive Lecture



This TP is designed to give cadets an introduction to different methods of finding water.

Water is the one thing that almost everyone takes for granted. People are used to turning on the tap and having an endless supply of water. Until water shortages or drought occur it is scarcely thought about. Water is universally important and should be respected. It is essential to life and all life contain it.

In survival situations, it is important to conserve potable water and seek a freshwater source.



**Potable Water.** Water of higher quality, suitable for drinking.

**OBSERVING INSECTS, AMPHIBIANS, MAMMALS, AND BIRDS**

When in a survival situation, observing the behavior of mammals is the best indicator of the location of water.

**Insects**

Insects are good indicators of water. If bees are present, water is usually within several kilometres of your location. Bees fly a maximum of 6.5 km (4 miles) from their nests or hives. They do not have regular watering times, but drink when thirsty.

Ants are dependant on water. An ant nest will often be close to a source of water. A column of ants marching up a tree is likely going to a small reservoir of trapped water.

Most flies keep within 90 m (100 yards) of water. If mosquitoes and flies are swarming, there is most likely a good source of water close by.

**Amphibians**

Amphibians are not an indicator of water. They collect dew and draw moisture from prey.

**Mammals**

Most mammals require water regularly. Grazing mammals are usually close to water. Converging game trails often lead to water; follow them downhill.

**Birds**

Grain eaters, such as finches and pigeons are never far from water. They drink at dawn and dusk. When they fly straight and low, they are heading for water. When they return from water they fly from tree to tree, resting frequently. By plotting their direction, water can be found.

Water birds can travel long distances without stopping to feed or drink; they do not necessarily indicate water nearby.

Hawks, eagles and other birds of prey draw water from their victims and cannot be taken as a sign that water is nearby.

## SEARCHING FOR PLANTS

Watch for green leaf plants and trees that require a lot of water. These plants include cattails, bulrush, elderberries, and reeds. Trees include cottonwood, poplars, greasewood and willows. This type of growth indicates a high water table. These plants may be located on a dry river bed. To get to the water, dig into the ground 30–60 cm (1–2 feet) and water will accumulate in this pit.

An alternate place to search for water is at the base of a cliff where there is vegetation.

## SEARCHING IN VALLEY BOTTOMS

Look in valley bottoms where water will naturally drain. If there are no obvious streams or pools, look for patches of green vegetation and dig there. There may be water just below the surface, which will collect in the hole. Digging in gullies and dry streambeds may reveal a spring beneath the surface, especially in gravel areas. In mountain valleys, look for water trapped in crevices.



Pools or streams with no vegetation growing are likely to be polluted by a high concentration of minerals or chemicals that have been leached from the bedrock or close to the surface.

Any water collected from pools should be boiled prior to drinking.

---

## CONFIRMATION OF TEACHING POINT 1

---

### QUESTIONS

- Q1. What type of birds do not necessarily indicate that there is water nearby?
- Q2. What are the best indicators of water?
- Q3. What types of plants should you look for when seeking a water source?

### ANTICIPATED ANSWERS

- A1. Water birds can travel long distances without stopping to feed or drink so they do not necessarily indicate water nearby. Hawks, eagles and other birds of prey get water from their victims and cannot be taken as a sign that local water is nearby.
- A2. Mammals.
- A3. Look for green leaf plants and trees that require a lot of water. These plants include cattails, bulrush, elderberries, and reeds. Trees include cottonwood, poplars, greasewood, and willows.

---

### Teaching Point 2

### Explain and Demonstrate Methods of Collecting Water

Time: 15 min

Method: Demonstration

---



As each method is identified, explain and demonstrate it to the cadets.

Collecting water can be difficult and it is important to take into consideration the time of year and the weather when looking for and collecting water.

## DIGGING WELLS

Wells are dug in hopes of finding a reliable and ample supply of water. If a well is being dug in a survival situation, it must be done when the survivor has lots of strength and stamina.

Wells cannot be dug much deeper than the water table because it will continuously fill with water. In a dry season, when the water table falls, the well depth can be increased.



**Water Table.** The upper limit of groundwater that occurs naturally.

An example of a simple well is the soil moisture pit.



### Soil Moisture Pit

1. Dig a pit 2 m x 2 m deep x 1 m (6.5 feet x 6.5 feet x 3.2 feet).
2. Take an empty water bottle and cut the top off.
3. Make a small hole in the centre of the plastic for the bottle.
4. Cover the the pit with a sheet of plastic wrap.
5. Place a small rock on the plastic wrap over the water bottle.
6. Let the sun do its job.

The water bottle will fill at least once a day, which is enough to keep you alive. This method will most likely not work in cooler weather.

## COLLECTING PRECIPITATION

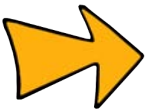

Precipitation can be in the form of rain, snow, hail, sleet, dew and frost.

Rainwater collected in clean containers or in plants is usually safe for drinking. However, purify water from lakes, ponds, swamps, springs, or streams, especially water found near populated areas or in the tropics.

Acid rain, or polluted rain can pollute soil, but generally all rain is drinkable.

Use as many containers as possible. Plastic, wood, bark and holes dug in clay can be used to catch water.

## COLLECTING DEW

Although dew does not provide a large quantity of water, it is still a good source of water. Dew accumulates on grass, leaves, rocks and equipment at dawn and dusk. This is also when dew should be collected before potential freezing or evaporation.

Heavy dew can provide water. Tie rags or tufts of fine grass around your ankles and walk through dew-covered grass before sunrise. As the rags or grass tufts absorb the dew, wring the water into a container. Repeat the process until you have a supply of water or until the dew is gone. Australian natives sometimes mop up as much as a litre an hour this way.

## COLLECTING CONDENSATION



**Condensation.** The process of water vapour in the air turning into liquid. Drops on the outside of a cold glass are condensed water. Condensation is the opposite of evaporation.

### Vegetation Bags

A vegetation bag is quite simply a container to collect condensation from vegetation. A section of shrubs, bushes and trees are covered in a vegetation bag and the condensation from the sun is collected within the bag.

To construct a vegetation bag, one will need a clear plastic bag and an ample supply of healthy, non-poisonous vegetation. A 1- to 2-m (4- to 6- foot) section of surgical tubing is also helpful.

1. Open the plastic bag and fill it with air.
2. Fill the bag one half to three quarters full with lush green vegetation. Be careful not to puncture the bag.
3. Place a small rock or similar item into the bag. If you have surgical tubing, slide one end inside and toward the bottom of the bag. Tie the other end with an overhand knot.
4. Tie off the bag as close to the opening as possible.
5. Place the bag on a sunny slope so that the opening is slightly higher than the bag's lowest point.
6. Position the rock and surgical tubing at the lowest point in the bag.
7. For best results, change the vegetation every two to three days.
8. If using surgical tubing, simply untie the knot and drink the water that has condensed in the bag. If no tubing is used, loosen the tie and drain off available liquid. Be sure to drain off all liquid prior to sunset each day, or it will be reabsorbed by the vegetation.

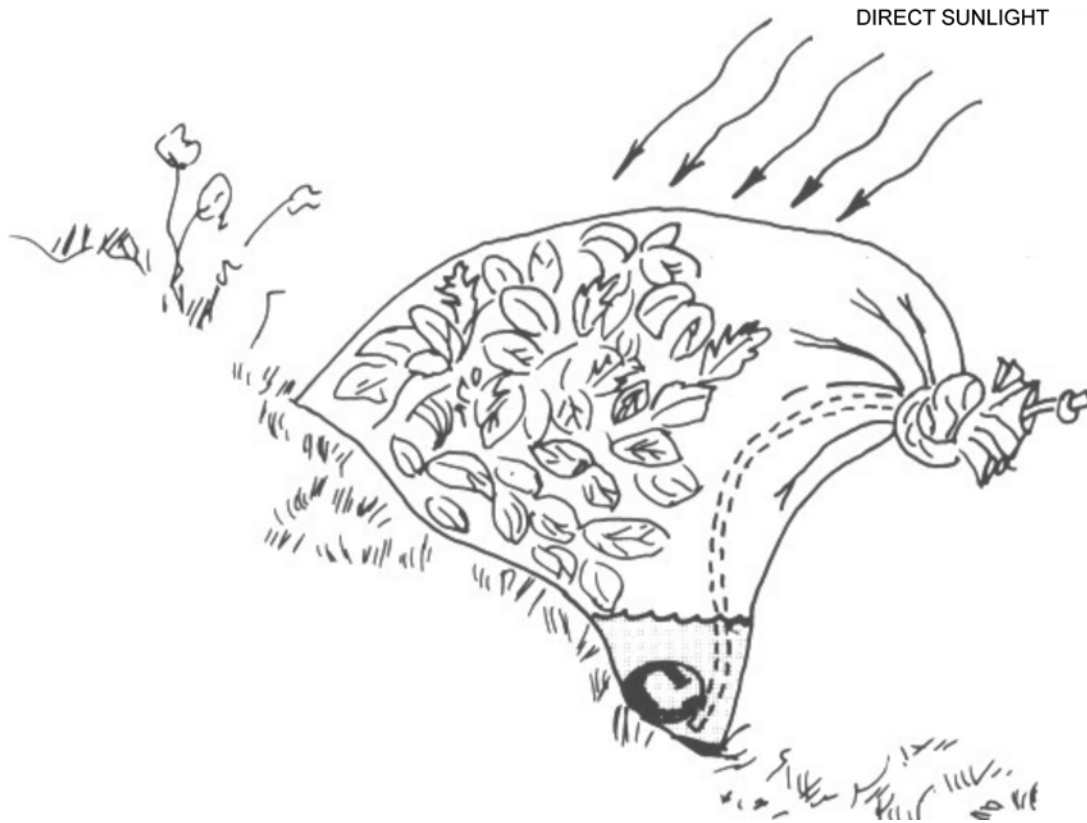

G. Davenport, *Wilderness Survival (2<sup>nd</sup> ed)*, Stackpole Books (p. 144)

Figure 14-2-1 Vegetation Bag

## Transpiration Bags



**Transpiration.** Process by which water absorbed by plants, usually through the roots, is evaporated into the atmosphere from the plant surface, such as leaf pores.

A transpiration bag is better than a vegetation bag because the same vegetation can be reused allowing time for it to rejuvenate. Water transpiration bags are beneficial because, they yield more, are easier to assemble, and often have a better taste.

To construct a transpiration bag, one will need a clear plastic bag and a non-poisonous bush or tree.

A 1- to 2-m (4- to 6- foot) section of surgical tubing is also helpful.

1. Open the plastic bag and fill it with air.
2. Place the bag over the lush leafy vegetation of a tree or bush, being careful not to puncture the bag. Be sure the bag is on the side of the tree or bush with the greatest exposure to the sun.
3. Place a small rock or similar item into the bag's lowest point, and if you have surgical tubing, place one end at the bottom of the bag next to the rock.
4. Tie the other end of the tubing with an overhand knot.
5. Tie off the bag as close to the opening as possible.



6. Change the bag's location every two to three days to ensure optimal outcome and to allow the previous site to rejuvenate so it might be used again later.
7. If using surgical tubing, simply untie the knot and drink the water that has condensed in the bag. Be sure to drain off all liquid prior to sunset each day, or it will be reabsorbed by the tree or bush.

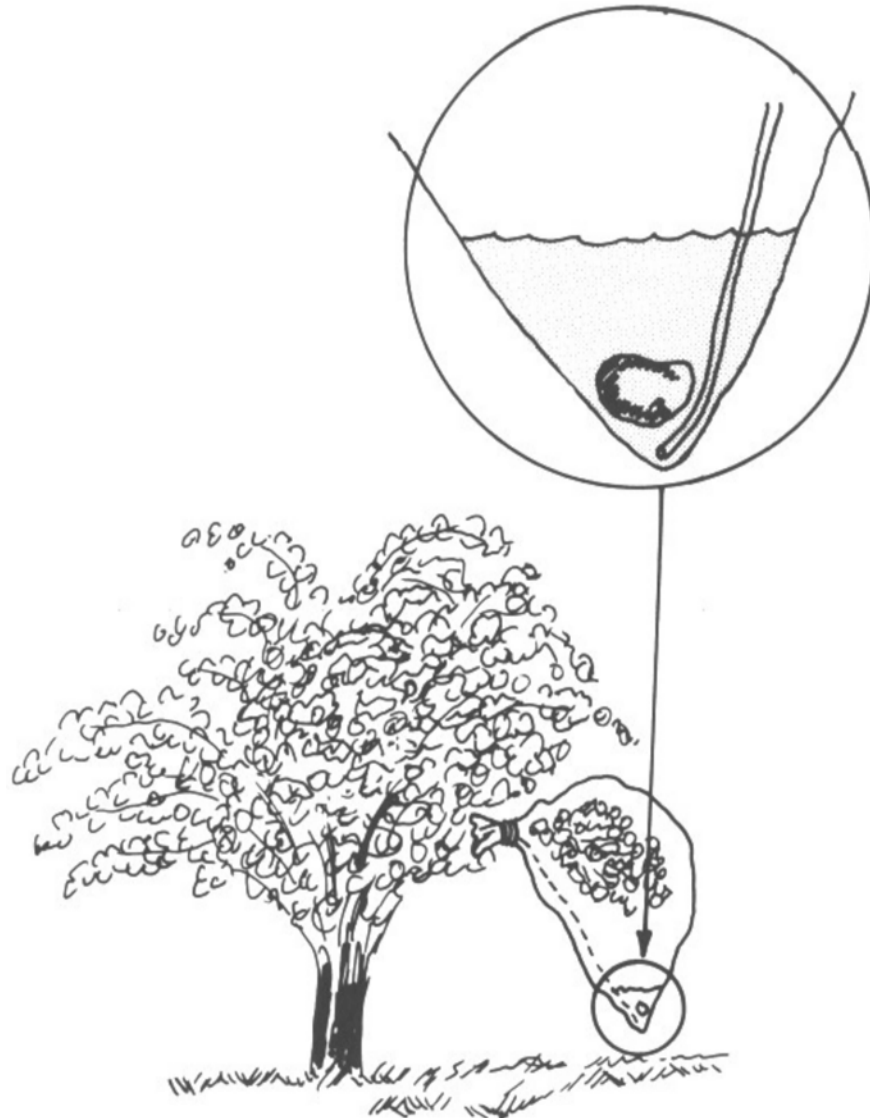

G. Davenport, *Wilderness Survival* (2<sup>nd</sup> ed), Stackpole Books (p. 144)

Figure 14-2-2 Transpiration Bag

---

## CONFIRMATION OF TEACHING POINT 2

---

### QUESTIONS

- Q1. How does the water table affect well depth?
- Q2. How is dew collected?
- Q3. What are the benefits of a transpiration bag?

## ANTICIPATED ANSWERS

- A1. Wells cannot be dug much deeper than the water table.
- A2. Dew is collected by tying rags or tufts of long grass to your ankles and walking through dew-covered grass before sunrise.
- A3. Transpiration bags are beneficial because they have a high yield, are easier to assemble, and often have a better taste.

---

### Teaching Point 3

### Explain Methods of Transporting Water

Time: 5 min

Method: Interactive Lecture

---



This TP is designed to introduce the cadets to the different methods of collecting water in a survival situation.

Water in a survival situation may require transportation from one location to another. If possible, having or finding a water container which can hold a minimum of one litre with a wide-mouth opening is ideal.

Improvised water containers are sometimes necessary. Anything sturdy can hold water.

### STORAGE CASE

Any container, including the case that holds a survival kit can be used. The storage case for matches, bags that contain food, and metal cases can hold water.

### CONDOM

Condoms are great for water storage provided they are non-lubricated and non-spermicidal. In addition, a condom will have to be placed in a scarf or other forming structure to give it extra strength.

### PONCHO

A poncho is made of a great material to transport water and is already watertight. The poncho can be folded, bent and rolled into shapes to collect and carry water. Create a bowl from the poncho by securing the corners to tree limbs.

### NATURAL CONTAINER

Natural containers such as hollowed-out wood pieces are excellent for storing water. The wood in the container will give strength and stability for larger quantities of water. Large leaves can be folded and held in the hand for smaller quantities of water.

### PLASTIC BAG

Plastic bags are a useful piece of equipment in survival situations. A large plastic bag such as a large polythene bag about 200 cm by 60 cm (7 feet by 2 feet) can be used in many ways, particularly to collect large amounts of water.

---

**CONFIRMATION OF TEACHING POINT 3**

---

**QUESTIONS**

- Q1. What are different ways to transport water?
- Q2. What is the benefit of using a poncho for transporting water?
- Q3. What are examples of natural containers?

**ANTICIPATED ANSWERS**

- A1. Transporting water can be done using a storage case, condom, poncho, natural container and plastic bag.
- A2. A poncho is beneficial to transport water as it is already watertight.
- A3. Natural containers are hollowed-out wood pieces and large leaves.

---

**END OF LESSON CONFIRMATION**

---

**QUESTIONS**

- Q1. What is potable water?
- Q2. What is the water table?
- Q3. How is a transpiration bag constructed?

**ANTICIPATED ANSWERS**

- A1. Potable water is water of higher quality which is suitable for drinking.
- A2. The water table is the upper limit of groundwater that occurs naturally.
- A3. To construct a transpiration bag:
- (1) Open the plastic bag and fill it with air.
  - (2) Place the bag over the lush leafy vegetation of a tree or bush, being careful not to puncture the bag. Be sure the bag is on the side of the tree or bush with the greatest exposure to the sun.
  - (3) Place a small rock or similar item into the bag's lowest point, and if you have surgical tubing, place one end at the bottom of the bag next to the rock.
  - (4) Tie the other end of the tubing with an overhand knot.
  - (5) Tie off the bag as close to the opening as possible.
  - (6) Change the bag's location every two to three days to ensure optimal outcome and to allow the previous site to rejuvenate so it might be used again later.
  - (7) If using surgical tubing, simply untie the knot and drink the water that has condensed in the bag. Be sure to drain off all liquid prior to sunset each day, or it will be reabsorbed by the tree or bush.

---

## CONCLUSION

---

### HOMEWORK/READING/PRACTICE

N/A.

### METHOD OF EVALUATION

This EO is assessed IAW A-CR-CCP-703/PG-001, Chapter 3, Annex B, Appendix 6 (324 EC-02).

### CLOSING STATEMENT

Collecting water may mean the difference between survival and death. Knowing how and where to collect water will assist the cadets in combating the enemies of survival and keep them healthy and hydrated during the experience.

### INSTRUCTOR NOTES/REMARKS

Cadets will be required to collect water during the bivouac FTX.

---

## REFERENCES

---

- C0-111 (ISBN 0-9740820-2-3) Tawrell, P. (2002). *Camping and Wilderness Survival: The Ultimate Outdoors Book*. Green Valley, ON: Paul Tawrell.
- C3-002 (ISBN 0-00-653140-7) Wiseman, J. (1999). *The SAS Survival Handbook*. Hammersmith, London: HarperCollins Publishers.
- C3-150 (ISBN 978-0-8117-3292-5) Davenport, G. (2006). *Wilderness Survival* (2<sup>nd</sup> ed.). Mechanicsburg, PA: Stackpole Books.



**ROYAL CANADIAN ARMY CADETS**  
**SILVER STAR**  
**INSTRUCTIONAL GUIDE**



**SECTION 3**

**EO M324.03 – LIGHT A FIRE WITHOUT MATCHES**

---

Total Time: 120 min

---

**PREPARATION**

---

**PRE-LESSON INSTRUCTIONS**

Resources needed for the delivery of this lesson are listed in the lesson specification located in A-CR-CCP-703/PG-001, Chapter 4. Specific uses for said resources are identified throughout the instructional guide within the TP for which they are required.

Review the lesson content and become familiar with the material prior to delivering the lesson.

Photocopy instructions located at Annexes A to D for each cadet.

**PRE-LESSON ASSIGNMENT**

N/A.

**APPROACH**

An interactive lecture was chosen for TP 1 to orient cadets to methods of lighting a fire without matches and generate interest in the topic.

Demonstration was chosen for TP 2 as it allows the instructor to demonstrate and explain different methods of lighting a fire without matches.

Performance was chosen for TP 3 as it allows the cadets to practice lighting a fire without matches while under supervision.

---

**INTRODUCTION**

---

**REVIEW**

The review for this lesson is taken from EO M224.05 (Prepare, Light, Maintain and Extinguish a Fire, A-CR-CCP-702/PF-001, Chapter 14, Section 5).



Before conducting training in provincial or national parks, one must confirm that fires are allowed. Open fires are normally only allowed in designated areas. Open fires are fires that are not contained in a structure or housing that ensures the fire will not spread (eg, barrel or fireplace).

Each park will clearly state their fire regulations and restrictions.

Parks commonly follow the Fire Weather Index, which provides an assessment of relative fire potential that is based solely on weather observations. Check with park administration for rules and regulations when planning to light fires within the park boundaries.

### CANADIAN FOREST FIRE DANGER RATING SYSTEM (CFFDRS)

The CFFDRS is Canada's national system for rating forest fire danger. The system evaluates and integrates data to help managers predict woodland fire potential.

The CFFDRS provides an index (as illustrated in Figure 14-3-1) on how easy it is to ignite vegetation, how difficult a fire may be to control, and how much damage a fire may do.

BLUE	GREEN	YELLOW	ORANGE	RED
LOW	MODERATE	HIGH	VERY HIGH	EXTREME

*Director Cadets 3, 2007, Ottawa, ON: Department of National Defence*

Figure 14-3-1 CFFDRS Fire Index

**Low.** Low chance of fires occurring. Fires that do occur are likely to be self-extinguishing and new ignitions are unlikely.

**Moderate.** Moderate chance of fires starting. These fires are creeping or gentle surface fires. They are easily contained by ground crews with water pumps.

**High.** High chance of fire starting. These fires are challenging for ground crews to handle and heavy equipment (tanker trucks and aircraft) are often required to contain the fire.

**Very High.** Very high chance of a fire starting. These fires are fast spreading and are of high intensity. They are hard to control and require aircraft support.

**Extreme.** The environment is very dry and chances of fire are extreme. These fires are fast spreading, of high intensity and very difficult to control.



Review this information by looking up the CFFDRS on the Internet at <https://nofc1.cfsnet.nfis.org/mapserver/cwfis/index.shtml>.

### MAINTAINING A SAFE FIRE SITE

Prior to starting a fire, ensure fire safety equipment is available.

**Shovel.** A shovel provides a means to smother the fire. Shovelling dirt, gravel or sand on a fire reduces oxygen, thus extinguishing the fire.

**Rake.** A rake allows one to disperse burning material away from the fire. A rake can also be used to smother the fire by raking dirt, gravel, or sand onto the fire.

**Pail Filled With Sand or Water.** A pail of water or sand can be immediately thrown over a fire if it starts to get out of control and can be refilled as many times as required.

**Fire Extinguisher.** A fire extinguisher is designed to tackle a fire for a short duration. It is very effective in extinguishing a small fire that is getting out of control.

### CHOOSING A SAFE FIRE LOCATION

Before beginning to build a fire, think about the location. It should be placed for maximum warmth and convenience without sacrificing safety. Consider the following when choosing a safe fire location:

- The fire site should be high and dry.
- The area should be sheltered and away from windy areas to reduce flare ups.
- The site should be clear of over-hanging boughs and branches.
- All combustible materials shall be cleared from the fire site.
- The site should be 1.8 m (4–6 feet) from the shelter entrance.

## OBJECTIVES

By the end of this lesson the cadet shall follow the process to light a fire without matches.

## IMPORTANCE

It is important for cadets to be able to light a fire without matches. The second element of the survival pattern is fire, which provides heat, light and comfort. A fire also provides a means to cook food, scare away animals and signal rescuers if the cadet becomes lost and is in a survival situation without a survival kit.

### Teaching Point 1

### Identify Methods of Lighting a Fire Without Matches

Time: 20 min

Method: Interactive Lecture



This information in this TP is background information relating to the different methods of lighting a fire without matches.

## ALTERNATIVE METHODS OF LIGHTING A FIRE

In a survival situation, there may not be matches available to light a fire. In these situations it is necessary to find alternative methods to light a fire.

### Bow and Drill

The bow and drill uses friction and pressure to heat a piece of wood and create a fine black powder that will light tinder. This method takes practice, but can easily be repeated over and over with materials found in the environment.

### Fire Saw

The fire saw is a method that involves rubbing the bevelled edge of a stick in the notch of a fireboard. This method is commonly used in the jungle or a moist environment.

### Flint and Steel

This is the best method to light tinder aside from matches. The flint and steel method uses shavings that have been struck from flint by a sharp knife to ignite timber.



A magnesium fire block is similar to flint and steel but incorporates a chunk of magnesium in aluminium that can be shaved off to assist in lighting. Cut or scratch shavings off the block which are ignited by striking the back of a knife on the flint rod. Magnesium generates tremendous heat. Be careful that no shavings land on skin or clothing.

## Sun and Glass

A convex lens (a lens where the centre bulges out) from binoculars, a lens from a camera or telescope, the bottom of an old pop bottle or can, a piece of ice or a magnifying glass may be used to light tinder with the help of the sun.

Fire can be created from an old pop can and a chocolate bar. The bottom of the pop can is shaped like a lens but is not very reflective. Polish the bottom of the can with chocolate, like polishing a pair of boots until it has a mirror finish. Use the sun to focus the light onto tinder. This method takes a lot of time, but it works.

---

### CONFIRMATION OF TEACHING POINT 1

---

## QUESTIONS

- Q1. What are different methods of lighting a fire?  
 Q2. How does the bow and drill method work?  
 Q3. How does the flint and steel method work?

## ANTICIPATED ANSWERS

- A1. Bow and drill, fire saw, flint and steel and sun and glass are different methods of lighting a fire.  
 A2. The bow and drill method uses friction and pressure to heat a piece of wood and create a fine black powder that will light tinder.  
 A3. The flint and steel method uses shavings that have been struck from flint by a sharp knife to ignite timber.

---

## Teaching Point 2

## Demonstrate Methods of Lighting a Fire

Time: 30 min

Method: Demonstration

---



Demonstrate the following methods of lighting a fire. There is no requirement to create fire, but each method should be explained and demonstrated.

## Bow and Drill (Spindle)

The following steps are required to light a fire with a bow and drill:

1. Collect the following materials:
  - (a) one hardwood shaft 2 cm thick and 30 cm long,
  - (b) one softwood base 5 cm wide, 20 cm long and 2 cm thick,
  - (c) one bearing block or socket,
  - (d) one stick 60–90 cm long to make the bow (green wood from a sapling is best), and
  - (e) one piece of cord.
2. Cut a groove in the bearing block or socket 3–5 cm deep for the hardwood shaft to fit (as illustrated in Figure 14-3-2).





*P. Tawrell, Camping and Wilderness Survival: The Ultimate Outdoors Book (2<sup>nd</sup> ed.), Paul Tawrell (p. 434)*

Figure 14-3-2 Bearing Block

3. Cut a groove into the softwood base in which the hardwood shaft will spin. The groove should be open on one end for the heat and embers to escape (as illustrated in Figure 14-3-3).

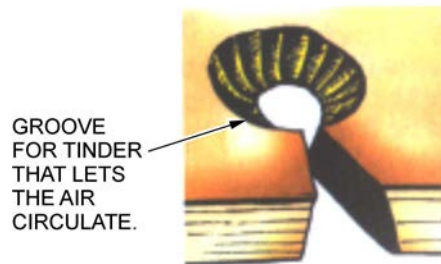

*P. Tawrell, Camping and Wilderness Survival: The Ultimate Outdoors Book (2<sup>nd</sup> ed.), Paul Tawrell (p. 434)*

Figure 14-3-3 Softwood Base

4. Carve one end of the hardwood shaft into a small point.
5. Place tinder in the opening in which the embers will fall.

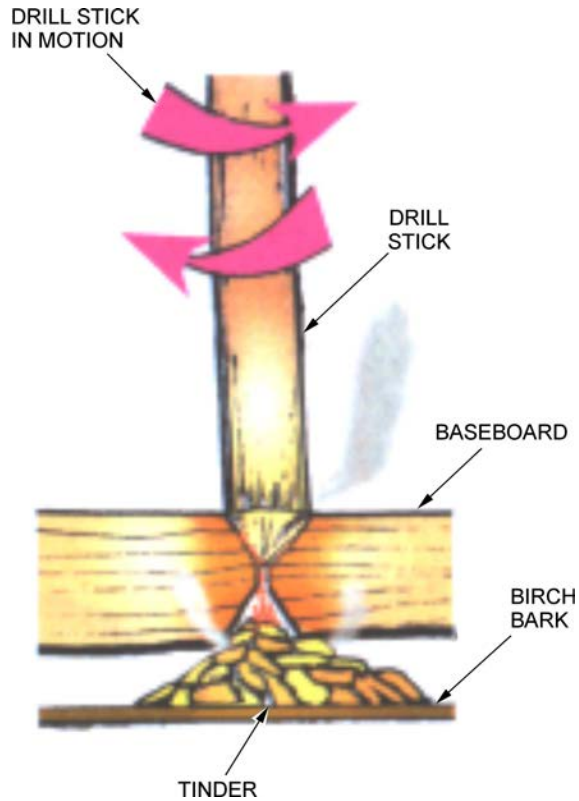

*P. Tawrell, Camping and Wilderness Survival: The Ultimate Outdoors Book (2nd ed.), Paul Tawrell (p. 434)*

Figure 14-3-4 Drill

6. Wrap the bow around the hardwood shaft and place it into the groove of the softwood base.
7. Place the bearing block on the top of the shaft.
8. Slowly at first, start a sawing motion with the bow back and forth so the hardwood shaft spins back and forth.

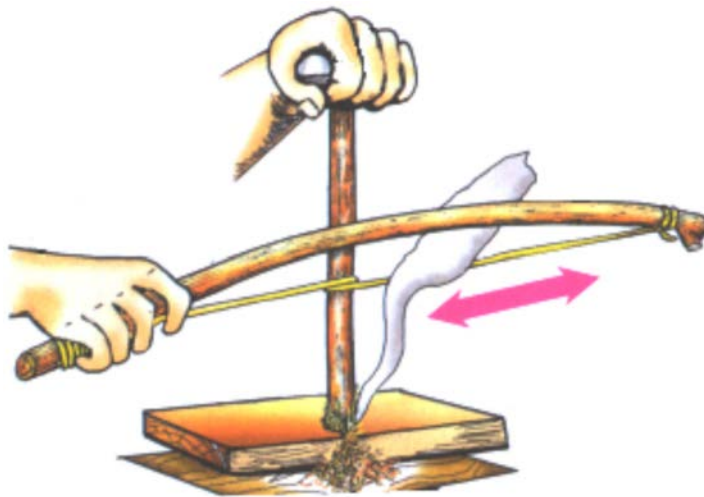

*P. Tawrell, Camping and Wilderness Survival: The Ultimate Outdoors Book (2nd ed.), Paul Tawrell (p. 434)*

Figure 14-3-5 Fire Bow and Drill

9. Maintain a constant motion back and forth; consistency is more important than speed.

10. Once smoke appears increase speed and look for embers to start to appear.
11. Once the tinder begins to smoke, stop and lightly blow on the tinder to start combustion.
12. When the tinder lights, apply gathered kindling and fuel as required.

### FIRE SAW

The fire saw consists of two pieces of dry wood: one rubbed vigorously against the other in a sawing motion.

Use a half a piece of split wood as the fireboard and a piece of softwood as a rub stick. Good tinder for the fire saw is material that is light and fluffy such as dried mosses or lichen such as old man's beard.

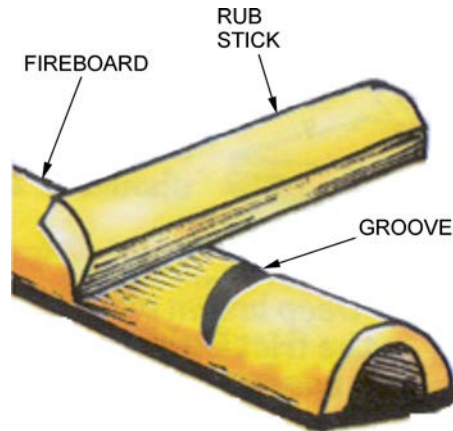

*P. Tawrell, Camping and Wilderness Survival: The Ultimate Outdoors Book (2<sup>nd</sup> ed.), Paul Tawrell (p. 434)*

Figure 14-3-6 Fire Saw

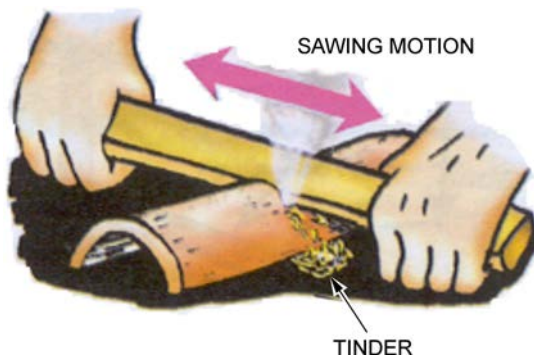

*P. Tawrell, Camping and Wilderness Survival: The Ultimate Outdoors Book (2<sup>nd</sup> ed.), Paul Tawrell (p. 434)*

Figure 14-3-7 Fire Saw in Motion

### FLINT AND STEEL

Hold the flint as close to the tinder as possible and strike it with the back of a knife blade or a small piece of carbon steel. Strike downward to scrape magnesium so that the sparks fall into the tinder. When the tinder begins to smoulder, fan or blow gently into a flame.

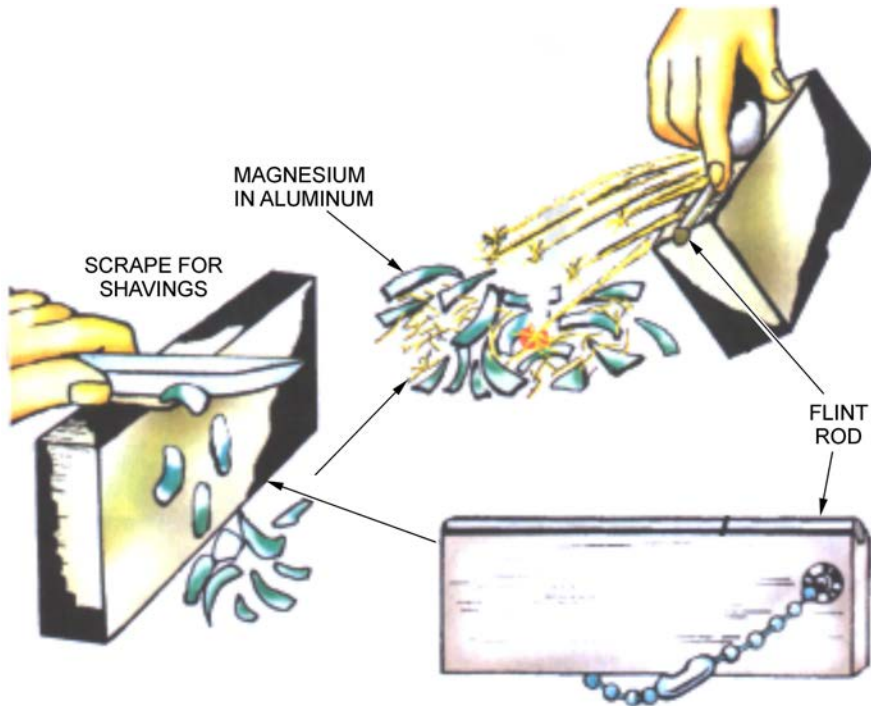

*P. Tawrell, Camping and Wilderness Survival: The Ultimate Outdoors Book (2<sup>nd</sup> ed.), Paul Tawrell (p. 436)*

Figure 14-3-8 Flint and Steel

### SUN AND GLASS

Use a piece of convex glass to concentrate rays of the sun on the tinder and hold until the tinder begins to smoke.

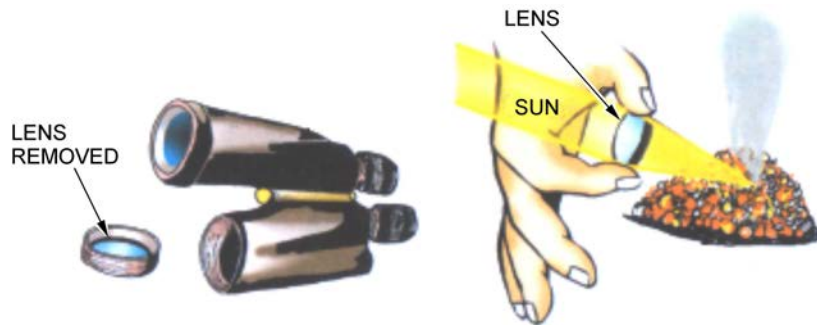

*P. Tawrell, Camping and Wilderness Survival: The Ultimate Outdoors Book (2<sup>nd</sup> ed.), Paul Tawrell (p. 437)*

Figure 14-3-9 Sun and Glass

---

### CONFIRMATION OF TEACHING POINT 2

---

The cadets' participation in the activity in TP 3 will serve as the confirmation of this TP.

---

**Teaching Point 3****Have the Cadets Practice Lighting a Fire**

Time: 60 min

Method: Performance

---



The cadets will practice lighting a fire without matches. There is no requirement for the cadet to create fire.

If time allows, a subsequent method should be attempted.

---

**ACTIVITY**

---

**OBJECTIVE**

The objective of this activity is to have the cadets construct and practice lighting a fire without matches.

**RESOURCES**

- Flint and steel,
- Glass,
- 1.8-kg (4-lb) axe with a 91-cm (36-inch) handle,
- 60-cm (24-inch) bow saw,
- Pail filled with sand or water,
- Tinder,
- Kindling,
- Knife,
- Hardwood shaft 2 cm thick and 30 cm long,
- Softwood base 5 cm wide, 20 cm long and 2 cm thick,
- One bearing block or socket,
- One stick 60–90 cm long to make the bow (green wood from a sapling is best),
- Cord,
- Water, and
- Shovel.

**ACTIVITY LAYOUT**

N/A.

**ACTIVITY INSTRUCTIONS**

1. Have the cadets attempt to light a fire without matches, using one of the following methods:
  - (a) bow and drill,
  - (b) fire saw,
  - (c) flint and steel, and

- (d) sun and glass.
2. Have the cadets choose a method from the ones listed above.
3. Distribute the handouts of instructions located at Annexes A to D.
4. Distribute materials to cadets.



There is no requirement for the cadets to light a fire, since it is a challenging skill to master. Cadets are only required to construct and attempt one method, but may attempt another, if time permits.

## SAFETY

- Firefighting equipment must be present during the lighting of fires.
- Additional instructors may be required to all cadets are attempting this activity simultaneously.

---

### CONFIRMATION OF TEACHING POINT 3

---

The cadets' participation in practicing to light a fire will serve as the confirmation of this TP.

---

### END OF LESSON CONFIRMATION

---

The cadets' participation in practicing to light a fire by bow and drill, fire saw, flint and steel or sun and glass will serve as the confirmation of this lesson.

---

### CONCLUSION

---

## HOMEWORK/READING/PRACTICE

N/A.

## METHOD OF EVALUATION

This EO is assessed IAW A-CR-CCP-703/PG-001, Chapter 3, Annex B, Appendix 6 (324 EC-03).

## CLOSING STATEMENT

It is important for cadets to be able to light a fire without matches. The second element of the survival pattern is fire, which provides heat, light and comfort. A fire also provides a means to cook food, scare away animals and signal rescuers if the cadet becomes lost.

## INSTRUCTOR NOTES/REMARKS

N/A.

---

### REFERENCES

---

- C0-111 (ISBN 0-9740820-2-3) Tawrell, P. (2002). *Camping and Wilderness Survival: The Ultimate Outdoors Book*. Green Valley, ON: Paul Tawrell.

- C2-008 (ISBN 0-00-265314-7) Wiseman, J. (1999). *The SAS Survival Handbook*. Hammersmith, London: HarperCollins Publishers.
- C2-148 (ISBN 978-0-8118-3292-5) Davenport, G. (2006) *Wilderness Survival* (2<sup>nd</sup> ed.). Mechanicsburg, PA: Stackpole Books.

THIS PAGE INTENTIONALLY LEFT BLANK





**ROYAL CANADIAN ARMY CADETS**  
**SILVER STAR**  
**INSTRUCTIONAL GUIDE**



**SECTION 4**

**EO M324.04 – PREDICT WEATHER**

---

Total Time: 30 min

---

**PREPARATION**

---

**PRE-LESSON INSTRUCTIONS**

Resources needed for the delivery of this lesson are listed in the lesson specification located in A-CR-CCP-703/PG-001, Chapter 4. Specific uses for said resources are identified throughout the instructional guide within the TP for which they are required.

Review the lesson content and become familiar with the material prior to delivering the lesson.

**PRE-LESSON ASSIGNMENT**

N/A.

**APPROACH**

An interactive lecture was chosen for TPs 1 and 2 to introduce the cadet to weather fronts and weather indicators that will influence predicting weather.

A practical activity was chosen for TP 3 as it is an interactive way to introduce cadets to predicting weather in a safe, controlled environment. This activity contributes to the development of survival skills and knowledge in a fun and challenging setting.

---

**INTRODUCTION**

---

**REVIEW**

N/A.

**OBJECTIVES**

By the end of this lesson the cadet shall be expected to predict weather for a 24-hour period.

**IMPORTANCE**

It is important for cadets to learn to predict weather so they can factor the weather into their survival plan if they become lost. The weather will play an important role when selecting the best action to take while waiting for assistance from rescuers, when deciding the type of shelter to seek and if/when making a decision to move.

**Teaching Point 1****Describe Weather Indicators**

Time: 10 min

Method: Interactive Lecture



This TP allows the cadets to view the clouds while learning their different characteristics.

Some information on types of clouds was taken from EO M224.03, (Predict Weather Using Cloud Formations, A-CR-CCP-702/PF-001, Chapter 14, Section 3).

Allow the cadets to view cloud formations for a short time before describing the characteristics of each one.

**CLOUDS**

**Cumulus.** These clouds are large, individual puffy clouds. They resemble cauliflower or cotton balls, with bottoms which often appear dark and flat. They can often be seen on a warm day. When these clouds are in the sky one can expect fair weather, unless they begin to extend upward.

Cumulus clouds may bring the following associated weather:

- black or grey – possible thunderstorm,
- may develop into cumulonimbus – possible storm, and
- small isolated patches – good weather.



*E. Brotak, Wild About Weather, Lark Books (p. 88)*

Figure 14-4-1 Cumulus Clouds

**Alto cumulus.** These clouds are very big and can be white or grey. They appear as a layer or a series of patches of rounded masses. Alto cumulus clouds can be seen before fair or bad weather and have little value as an indicator of future weather developments.

Alto cumulus clouds may bring the following associated weather:

- domed shape – possible thunderstorm, and
- small isolated patches – good weather.



*E. Brotak, Wild About Weather, Lark Books (p. 87)*

Figure 14-4-2 Altocumulus Clouds

**Stratocumulus.** These appear as sheets of big puffy white or grey clouds. Stratocumulus clouds often appear in dark patches or rolls and are often thin with blue sky showing through the breaks. Snow or showers of rain are possible and can be heavy.

Stratocumulus clouds may precede or follow a storm.



*E. Brotak, Wild About Weather, Lark Books (p. 88)*

Figure 14-4-3 Stratocumulus Clouds

**Cirrus.** These clouds are wispy and look like cotton candy being pulled. They appear to be whitish wisps of cloud and are usually an indicator of fair weather.

Cirrus clouds may bring the following associated weather:

- drifting slowly or standing still – fair weather; and
- moving rapidly, followed by more clouds – foul weather.



*E. Brotak, Wild About Weather, Lark Books (p. 87)*

Figure 14-4-4 Cirrus Clouds

**Cirrostratus.** These clouds are whitish sheets that completely cover the sky. Cirrostratus clouds are normally see-through. When these clouds are in the sky, one can expect precipitation in a day or two.

Cirrostratus clouds indicate changeable weather.



*E. Brotak, Wild About Weather, Lark Books (p. 87)*

Figure 14-4-5 Cirrostratus Clouds

**Nimbostratus.** These appear as dark grey layers of large, puffy clouds. When they produce precipitation, it is in the form of continuous rain or snow. The bottom of this cloud is often hidden by heavy falling rain or snow.

Nimbostratus clouds indicate upcoming rainfall.



*E. Brotak, Wild About Weather, Lark Books (p. 88)*

Figure 14-4-6 Nimbostratus Clouds



A figure illustrating the cloud types in the atmosphere is included at Annex E. Distribute Annex E to each cadet.



Being able to forecast weather using clouds is a great tool in a survival situation.

Ask cadets if they know any signs that indicate weather may change.

### **SIGNS OF BAD WEATHER**

When the weather is going to change for the worse, cloud formations will change. Signs of change for bad weather are:

- Clouds, regardless of their formation, are thicker (darker), increase in numbers or join together to form layers lower in the sky.
- Clouds form banks in the west with winds from the south.
- Clouds move in all directions or contrary to the wind on the ground.
- Altocumulus clouds move quickly across the sky or form towers in the morning.
- Cumulus clouds form in the morning and stack in the afternoon or move from the south or southwest.

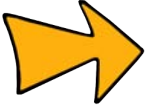

A halo around the sun or moon indicates bad weather.

## **SIGNS OF GOOD WEATHER**

When the weather is going to change for the better, cloud formations will change. Signs of a change for good weather are:

- Cloud cover lifts, becomes lighter and small patches of blue sky develop.
- Cumulus clouds form in the afternoon or float alone.
- Stratocumulus clouds drift with the prevailing wind and remain scattered.
- The condensation trail (contrail) left by high altitude aircraft disperses quickly.
- Morning fog is burnt off before noon.

## **THUNDERSTORMS**

Thunderstorms are most common in the summertime. They are formed by cumulus clouds, feeding off warm and moist air. These clouds grow quickly during the day, driven by the heat from the sun. When dark cumulonimbus clouds begin to approach, one can expect a thunderstorm. Thunderstorms not only have thunder, but very often lightning as well.

**Lightning.** Lightning is an electrical discharge in the atmosphere. When cumulus clouds grow tall, they develop an electrical field. The top of the cloud, where there are lots of ice crystals, is normally positive. The bottom part of the cloud, filled with rain droplets, is normally negative. The ground has a positive charge. An electrical charge builds up and the atmosphere produces lightning.

**Ground Lightning.** Ground lightning happens when the charges are exchanged by the clouds and ground. These flashes affect people greatly, often causing injury or death and disrupting power and communications and starting forest fires. People can be injured a significant distance from the point where the lightning strikes as the current travels through the ground.

**Thunder.** Thunder is the sound made when a lightning bolt heats the air and expands quickly. Since sound moves much slower than light, one can judge how far away a lightning bolt is by counting the seconds between seeing the flash and hearing the thunder. Each three-second interval equals about one km (0.6 miles).

### **Calculate the Speed of an Approaching Storm**

Count the seconds between the flash and the thunder clap. (Each second represents a 300 m [984 feet] distance) from the lightning strike. The speed and distance of the approaching storm can be calculated by comparing the time delay between the lightning and the thunder from several lightning strikes.

## **ACTIONS TO TAKE IN THE EVENT OF A THUNDERSTORM**

A thunderstorm can arrive quickly and lightning can strike in front of the storm. Seek shelter well before a storm hits.

### **Avoid High Points**

Make sure not to be the prominent high point in the area (in a field, on a beach, in the water) and not next to a prominent high point (next to an isolated tree, steeple, flag pole).

### Avoid Running

Walk fast, but do not run as rapid movement may cause air currents that attract an electric strike.

### Stay Low in Open Areas

If in the open, crouch very low and try to insulate the body from the ground by standing on a backpack (with no metal), raincoat, jacket or air mattress. The importance of this insulation is that the ground charge cannot rise through the body to attempt to reach the lightning discharge.

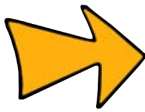

Keep hands off the ground especially if the ground is wet or if it is humid.

### Avoid Metal Objects

Stay away from any metal tent poles, backpack frames, walking poles, etc. Abandon these items, in a flat field, as they may create a better potential impact point other than the body. Avoid being in a boat or in water during a storm.

### Avoid Grouping Together

Do not group together during a storm. According to author Paul Tawrell, *Camping and Wilderness Survival: The Ultimate Outdoors Book*, Tawrell Books (p. 224) “a flash of lightning killed 504 sheep that had huddled together during a storm.”



Make sure that the storm has completely passed before moving so that you do not attract the last lightning strike.

## WIND

Defined as the horizontal motion of air across the earth's surface. Wind is produced by air pressure and is different from place to place. Local winds result from thermal differences that generate local pressure gradient. Wind speed is expressed in kilometres per hour (km/h), metres per second (mps) or knots (kt).

The two principle properties of wind are speed and direction. Winds are named for the direction from which they originate. For example, a wind from the west is a westerly wind (it blows eastward). The most important factor affecting wind is the Coriolis effect. The Coriolis effect is zero at the equator and increases as it reaches the poles. The effect is proportional to the wind speed.



Coriolis effect is the deflection of moving objects on earth from a straight path, in relation to the differential speed of rotation at varying latitudes.



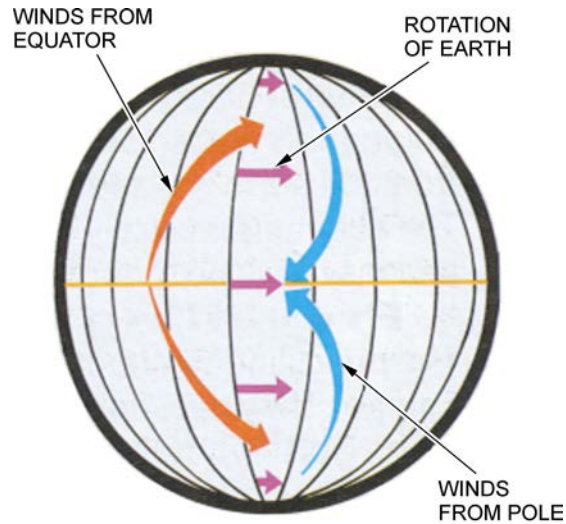

*P. Tawrell, Camping and Wilderness Survival, Tawrell Books (p. 607)*

Figure 14-4-7 Coriolis Effect

Wind will flow from a high air pressure area to a low air pressure area. Due to the rotation of the earth and friction, wind will flow around the outside of the high or low pressure areas. Wind strengths are directly related to the difference between high and low air pressure areas; the larger the difference, the stronger the winds.

## WEATHER LORE

Meteorologists use lots of equipment and science to forecast weather. However, people whose livelihoods depend on weather – farmers and sailors – often use the things around them to predict the weather. Nature, animals and even humans may give clues to future weather patterns. Certain species of plants and animals are affected by the slightest change in their environment. Weather lore is often considered to be old wives tales and superstitions.

## NATURE SIGNS

There are signs in nature that can show change in air pressure. Some are very obvious changes while others are of a more subtle nature.

**Smoke.** Smoke rising from a fire straight into the air means fair weather (high pressure) and smoke hanging low, (low pressure) means rain is on the way.

**Red Sky.** A red sky at either dusk or dawn is a beautiful natural sign one can use to predict weather. At dusk, a red sky indicates that the next day will be dry and clear day. This is due to the sun shining through dust particles being pushed ahead of a high pressure system bringing in dry air. A red sky at dawn often means that an approaching low pressure system is bringing in a lot of moisture. This is a fair indication that a storm is approaching. Do not confuse a red sky in the morning with a red sun in the morning. If the sun itself is red and the sky is a normal colour, the day will be fair.

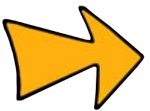

Remember the old rhyme:

“Red sky at night, sailor’s delight. Red sky at morning, sailors take warning”

**Sun Halo.** When a halo rings the moon or sun, rain is approaching.



## PLANTS

**Flowers.** Flowers and plants will close before a storm.

**Leaves.** When the leaves of trees turn over, windy conditions and severe storms will not be far behind.

**Pine Cones.** Pine cones close up in moist weather to protect their seeds. If the weather is dry, the pine cone will open.

**Seaweed.** In coastal areas, kelp shrivels and feels dry in fine weather, and swells and becomes damp if rain is in the air.

## ANIMALS

**Lying Cows.** When cows are lying down in a field, rain is on the way. The cows sense the moisture in the air and are making sure they have somewhere dry to lie down.

**Squirrels Tails.** If a squirrel's tail is very bushy, or they are collecting big stores of nuts in autumn, a severe winter may be expected (little scientific evidence supports this theory).

**Birds and Bats.** Birds and bats have a tendency to fly much lower to the ground right before rain due to the "thinning" of the air. They prefer to fly where the air is densest and where they get greater lift for their wings. With high pressure and dry air, the atmosphere becomes denser and birds can easily fly at higher altitudes. Some birds, like cockerels, sing when a thunderstorm approaches.

**Crickets.** When crickets are in cool grass, count the number of chirps they make. The number of chirps will indicate the temperature.

**Household Pets.** Cats and dogs in houses can sense storms and often seek a comfortable warm place to sleep.

## HUMAN OBSERVATIONS

**Senses.** Mountains and other faraway objects will appear to be much closer and more sharply focused as wet weather approaches and the air pressure drops. The dust particles in the air begin to settle to the ground and the air clears allowing one to see more details of faraway objects. As high pressure approaches and the air becomes thicker, more dust particles become suspended in the air and landmarks take on their normal hazy appearance.

Sounds become sharper and more focused prior to stormy weather. Instead of travelling upward and outward into the atmosphere, sound waves are bent back to the earth and their range extended. Even birdcalls sound sharper. This is why some people think the air is clean and fresh and bird songs and calls sound sharper before a rain.

**Aches and Pains.** When cold is expected, many humans claim to experience aches and pains in joints and muscles.

**Hair.** When there is a lot of humidity, human hair often becomes frizzy. When air is moist (indicating rain), hair swells and straightens.

---

## CONFIRMATION OF TEACHING POINT 1

---

## QUESTIONS

- Q1. What signs of cloud formation signal changes for bad weather?
- Q2. What should you do in an open field when a thunderstorm is approaching?
- Q3. What is weather lore?

## ANTICIPATED ANSWERS

A1. Signs of change for bad weather are:

- Clouds, regardless of their formation are thicker (darker), increase in numbers or join together to form layers, and/or lower in elevation.
- Clouds form banks in the west with winds from the south.
- Clouds move in all directions, or contrary to the wind on the ground.
- Altostratus clouds darken and lower.
- Altocumulus clouds move quickly across the sky or form towers in the morning.
- Cumulus clouds form in the morning and stack in the afternoon or move from the south or southwest.

A2. Make sure you are not the prominent high point in the area or that you are not next to a prominent high point.

A3. Weather lore is a way of predicting weather.

---

### Teaching Point 2

### Explain Weather Systems

Time: 5 min

Method: Interactive Lecture

---



The information in this TP is designed to give cadets background knowledge of weather systems which will aid them in predicting weather.

## FRONTS

**Weather Front.** A boundary that separates two air masses that have different characteristics. As two air masses collide they will mix along their boundary, but will retain their distinct characteristics.

**Cold Front.** Cold (more dense) air mass moving into a warmer (less dense) air mass and is characterized by the following:

- abrupt uplift along the frontal boundary;
- cumulus (flat based or anvil-shaped) development;
- short duration heavy rain and thunderstorms; and
- shown as a line of blue triangles on surface weather maps.

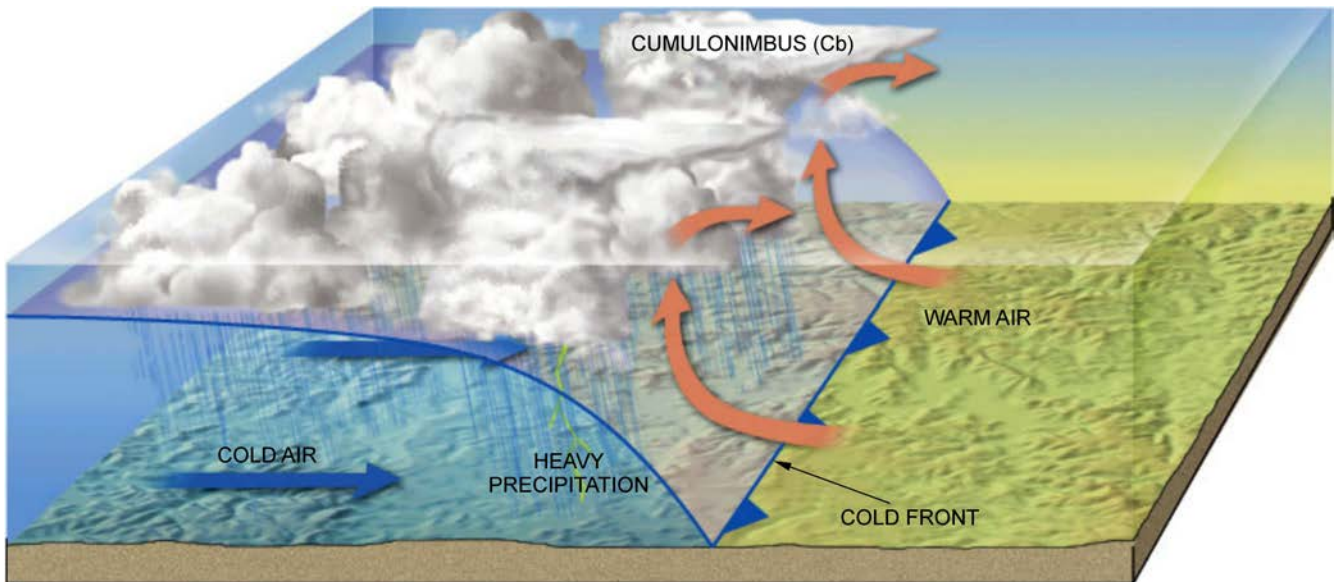

"Fronts", by *The Atmosphere*, Lutgens and Tarbuck, (8<sup>th</sup> ed). Copyright 2001 by John Stimac.  
Retrieved November 19, 2007, from <http://www.ux1.eiu.edu/~jpstimac/1400/fronts.html>

Figure 14-4-8 Cold Front

**Warm Front.** A warm (less dense) air mass moving into a cold air mass and is characterized by the following:

- gentle uplift;
- stratiform (stratus) cloud cover (the leading clouds, cirrus, are a good indicator of an impending change in the weather);
- long duration moderate rainfall; and
- shown as a line of red semicircles on surface weather maps.

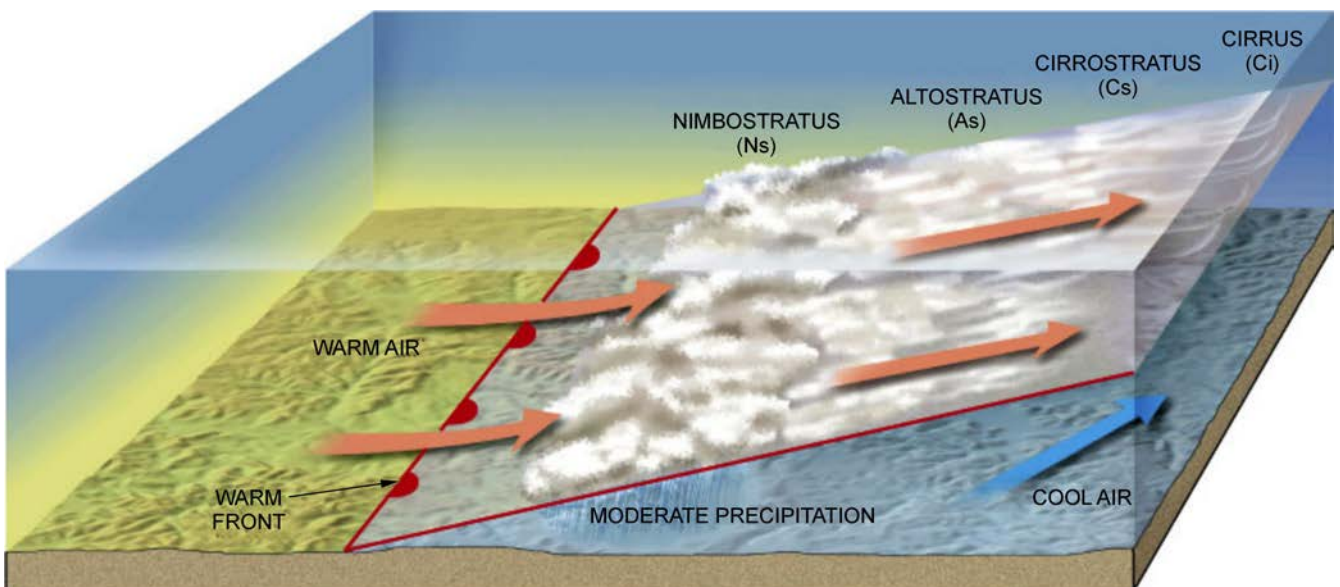

"Fronts", by *The Atmosphere*, Lutgens and Tarbuck, (8<sup>th</sup> ed.) Copyright 2001 by John Stimac.  
Retrieved November 19, 2007, from <http://www.ux1.eiu.edu/~jpstimac/1400/fronts.html>

Figure 14-4-9 Warm Front

## HIGHS AND LOWS

**Air Pressure.** The force of the air pushing down on the earth's surface. Air pressure is higher near sea level because there is more air at lower altitudes than on the top of a mountain. Changing weather is a result of changing air pressure. Understanding the effects of low and high air pressure is important in predicting weather.

**Low Pressure Area.** A low (an "L" on weather maps) is a region of air where the pressure is lowest in relation to the surrounding area. Lows are associated with stronger winds and rising air. This rising air expands and cools and cannot hold as much water, resulting in condensation and cloud formation.

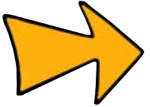

Think about the air rising above a campfire. The air molecules, as they are heated, begin to expand and leave the earth's surface, putting less pressure on it. On a large scale, this hot air creates an area of low pressure.

**High Pressure Area.** A high ("H" on weather maps) is a region where the air pressure is highest with relation to the surrounding area.

An area of high pressure is a section of air that is sinking. As the air sinks, it warms, allowing it to hold more water. Highs are often associated with fair weather.



Ask the cadets if they were to open a window on a cold winter night and stand in the middle of the room what part of their bodies would be first to feel the cold?

Answer: Feet.

This is because cold air is dense and the molecules are sinking. On a large scale, cold air masses push down on the earth's surface creating an area of high pressure.

---

## CONFIRMATION OF TEACHING POINT 2

---

### QUESTIONS

- Q1. What is a weather front?
- Q2. What is a low pressure area?
- Q3. What is high pressure?

### ANTICIPATED ANSWERS

- A1. A boundary that separates two air masses that have different characteristics. As two air masses collide, they mix along their boundary, but retain their distinct characteristics.
- A2. A low pressure area (an "L" shown on weather maps) is a region of air where the pressure is lowest in relation to the surrounding area.
- A3. An area of high pressure is a section of air that is sinking.

---

**Teaching Point 3****Have the Cadets Predict Weather for the Next 24-Hour Period**

Time: 10 min

Method: Practical Activity

---

---

**ACTIVITY**

---

**OBJECTIVE**

The objective of this activity is to have the cadet predict weather conditions for the next 24 hours.

**RESOURCES**

- Pen or pencil, and
- Paper.

**ACTIVITY LAYOUT**

N/A.

**ACTIVITY INSTRUCTIONS**

1. Have the cadets observe the clouds, weather and natural features around them.
2. Have the cadets write down what they think might happen in the next 24 hours.
3. Divide the cadets into small groups, of no more than four and have them discuss weather predictions over the next 24 hours.
4. Follow up with the cadets' predictions in a few days time.

**SAFETY**N/A.

---

**CONFIRMATION OF TEACHING POINT 3**

---

The cadets participation in the activity will serve as the confirmation of this TP.

---

**END OF LESSON CONFIRMATION**

---

The cadets' participation in predicting weather will serve as the confirmation of this lesson.

---

**CONCLUSION**

---

**HOMEWORK/READING/PRACTICE**

N/A.

**METHOD OF EVALUATION**

This EO is assessed IAW A-CR-CCP-703/PG-001, Chapter 3, Annex B, Appendix 6 (324 EC-04).

## CLOSING STATEMENT

Being able to predict weather is a great tool when in a survival situation. Weather is an important aspect of planning in any survival situation with respect to the type of shelter selected and the best course of action to take.

## INSTRUCTOR NOTES/REMARKS

Time shall be provided during a corps FTX to allow cadets to continue to practice the skill of predicting weather.

---

## REFERENCES

---

- C0-111 (ISBN 0-9740820-2-3) Tawrell, P. (2002). *Camping and Wilderness Survival: The Ultimate Outdoors Book*. Green Valley, ON: Paul Tawrell.
- C2-157 The Old Farmer's Almanac. *Cricket Chirps to Temperature*. Retrieved February 1, 2008, from <http://www.almanac.com/outdoors/crickets.php>.
- C2-162 Clouds R Us.com-Weather Features. *Weather Lore*. Retrieved February 1, 2008, from <http://www.rcn27.dial.pipex.com/cloudsrus/lore.html>.



**ROYAL CANADIAN ARMY CADETS**  
**SILVER STAR**  
**INSTRUCTIONAL GUIDE**



**SECTION 5**

**EO M324.05 – DETERMINE WHEN TO SELF-RESCUE**

---

Total Time: 30 min

---

**PREPARATION**

---

**PRE-LESSON INSTRUCTIONS**

Resources needed for the delivery of this lesson are listed in the lesson specification located in A-CR-CCP-703/PG-001, Chapter 4. Specific uses for said resources are identified throughout the instructional guide within the TP for which they are required.

Review the lesson content and become familiar with the material prior to delivering the lesson.

Prepare trail markings.

**PRE-LESSON ASSIGNMENT**

N/A.

**APPROACH**

An interactive lecture was chosen for this lesson to give background information on the factors to consider when deciding to break camp and search for help and generate interest in survival.

---

**INTRODUCTION**

---

**REVIEW**

The review for this lesson is from EO M224.01 (Identify Immediate Actions to Take When Lost, A-CR-CCP-702/PF-001, Chapter 14, Section 1).

**FIVE ELEMENTS OF SURVIVAL**

After successfully completing the S.T.O.P. action and recognizing a survival situation, the lost individual shall take inventory of all the food and equipment on hand and address the five elements of survival. The five elements of survival, listed in order of priority, are:

1. **Attitude.** Maintaining a positive attitude is essential. One can survive by staying calm, using all available resources, and prioritizing personal needs.
2. **Shelter.** A shelter is designed to provide protection from the weather and, depending on the conditions, protect a person from either hot or cold temperatures. Hypothermia and hyperthermia are two of the greatest dangers in a survival situation. A proper shelter can help prevent these from occurring. In a desert, for example, the goal is to stay under a shelter, shaded from the sun. In cold weather situations, the shelter will provide insulation.

3. **Water.** Water is the most essential nutrient for the human body. Even when thirst is not extreme it can dull the mind. Lack of water will slowly degrade the ability to survive. With adequate shelter and water one can survive for weeks.
4. **Fire.** In a survival situation, fire provides heat and light, and signals for rescuers. Cold weather not only lowers the ability to think, but it also lowers one's will to do anything. A drop of a few degrees in body temperature can affect the ability to make reasonable decisions.
5. **Food.** Individuals in good physical condition can go for many days or even weeks without food. The goal in a wilderness survival situation is to be located in the shortest time possible, so in most cases one will be located before food becomes a survival issue. However, it is always important to prepare for the worst and find ways to supply the body with substance, such as berries, fish, animals, birds, etc.

## QUESTIONS

- Q1. What are the five elements of survival?
- Q2. What is the one essential nutrient the body requires to function?
- Q3. What does a shelter provide?

## ANTICIPATED ANSWERS

- A1. Attitude, shelter, water, fire and food.
- A2. Water.
- A3. Shelter provides protection from the weather and depending on the conditions, protects you from either hot or cold temperatures.

## OBJECTIVES

By the end of this lesson the cadet shall be able to determine when to self-rescue.

## IMPORTANCE

It is important for cadets to be able to make the decision to move from their survival site and search for help. The decision to move is crucial and there are many considerations before changing location.

---

### Teaching Point 1

### Discuss the Factors to Consider When Deciding to Self-Rescue

Time: 10 min

Method: Interactive Lecture

---



This TP is designed to introduce the cadets to the factors to consider when deciding to self-rescue.



It is usually easier to locate food and water supplies from a permanent base than constantly being on the move. The first choice is to stay put.





Making the decision to self-rescue requires many considerations and should only happen as a last resort.

It is important to consider all the factors before leaving the survival site. When an analysis of the factors indicates that a site will not be able to provide resources critical to sustaining life, a move should be considered.

Behaviour in survival situations depends on the knowledge and attitude of the survivor. Hunters traditionally form the largest number of individuals lost. This is due to the adrenaline pushing them past their limits and being unprepared for adverse conditions.

Hikers and backpackers form the smallest group of lost individuals, yet they are prone to the hardships of being lost as they rarely carry survival equipment. This group typically goes out in good weather and gets stranded due to sudden storms.

## **FOOD AND WATER RESOURCES**

### **Time Without Water**

An area without water, or with a limited supply of water, will not be beneficial in the long run.

The body is estimated to be made up of two thirds water. Water is the most essential nutrient for survival and the human body can last just a few days without it.

During a normal non-strenuous day, a healthy individual will require 2 to 3 L of water. When physically active or in extreme hot or cold environments, that same person would need at least 4 to 6 L. Even when thirst is not extreme it can dull the mind. Lack of water will slowly degrade the ability to survive.

Drinking water wards off dehydration and environmental injuries. A person who is mildly dehydrated may become thirsty and become irritable and weak. As this becomes more serious, individuals will show a decrease in mental capacity and coordination.

In a survival situation, water is procured from the earth or from the sky, and sources can include surface water, groundwater, precipitation, condensation and plants.

### **Time Without Food**

The human body can last for a few weeks without food. In a survival situation, energy must be conserved and food resources planned and monitored.

In general, the requirements for food should be de-emphasized. Do not eat if water is not available. If water is available, more food can be taken in to sustain the energy level.

### **Proper Nutrition**

In a survival situation, getting the nutrients and vitamins a person needs is difficult. When choosing food sources, it is worthwhile to choose foods from four groups:

- carbohydrates,
- protein,
- fats, and
- minerals.

**Carbohydrates.** Easily digested foods that provide rapid energy. Fruits and vegetables are good sources of carbohydrates and should be checked for bug infestation before eating.

**Protein.** Builds body cells. Fish, game and poultry are good sources of protein but should be cooked thoroughly before eating.

**Fats.** Slowly-digestible food that provides long-lasting energy. Animal fats, eggs and nuts are excellent sources in survival situations.

**Minerals.** Aid in building and repairing the skeletal system. Water provides adequate minerals in survival situations.



Alternative food sources can be found in EO C324.01 (Identify Animal and Insect Food Sources, Section 6).

## FIRE AND SHELTER RESOURCES

Fire and shelter provides personal protection in survival situations; playing a vital role in protecting a cadet from the realities that can be dealt by nature. Fire and shelter serve many functions: removing the cadet from inclement weather, providing light, purifying water, drying clothes, warding off wildlife, and signalling. In addition, both fire and shelter reduce stress and keep the cadet comfortable.

It is important to have fire resources available in a survival situation. Hardwoods such as maple, ash, oak and hickory will burn longer and produce less smoke. If there are limited sources of hardwoods, softwoods can be used. Supplies will be used up quickly as softwoods burn hotter and faster.

As time passes and the need for wood dwindles the surrounding resources, survivors are required to go further and further to gather wood.



Information regarding shelter construction can be found in M224.04 (Identify Emergency Shelters, A-CR-CCP-702/PF-001, Chapter 14, Section 4), as well as M324.01 (Construct an Improvised Shelter, Section 1).



Information regarding fire construction can be found in M224.05 (Prepare, Light, Maintain and Extinguish a Fire, A-CR-CCP-702/PF-001, Chapter 14, Section 5) as well as M324.03 (Light a Fire Without Matches, Section 3).

## ENVIRONMENTAL DANGERS

Environmental dangers including weather, fire and wildlife will necessitate a move away from the danger.

## HEALTH OF PARTY MEMBERS

The health and well-being of all members must be considered prior to moving. If the cadet is alone and injured, moving should be a last resort.

Before moving, procure enough food and water to last at least two weeks.

In survival situations, there is a risk of disease from staying in one spot for too long. Even if the strictest sanitary management is kept, there is still a risk of illness or disease.

If injured members are staying behind, it is important to leave one healthy person behind to care for the injured and gather supplies.

### **RISK OF FURTHER INJURY**

Moving will be necessary if there is risk further injury to members of the group. As members get weaker, the risk of injury increases. Areas where there are hills, cliffs and large rocks are dangerous areas because of potential slides and avalanches.

### **THE STAY OR GO DECISION**

The decision to move away from the initial survival site is dependent on the many factors listed above; staying is the best scenario. Many lost people waste valuable energy and risk injury by panicking, running aimlessly, continuing to travel after dark, or walking in circles. If a lost person attempts to find their location, in most cases they will become more lost, increasing the distance between the last known point of their route. This wandering will only increase the size of the search area, time it will take for a rescue team to locate an individual or group. As long as there is no immediate danger, stay in one place.

Ideally, the survivor or group should establish a small area search. Complete the Star Compass Search to determine the decision to move.

#### **Star Compass Search**

To complete the Star Compass Search:

1. Visualize the starting point. Look around your current location. Make note of what is surrounding you such as obvious landmarks.
2. Mark the starting point using a stick or rock cairn.
3. Taking all your gear with you, walk 100 m (328 feet) in a straight line from the starting point along one of the cardinal compass points (N, S, E, W) and then back to the starting point.
4. Repeat step three for the remaining compass points.
5. Walk 200 m (656 feet) in a straight line from the starting point along one of the intercardinal compass points (NE, NW, SE, SW) and back again.
6. Repeat step five for the remaining compass points.

This will create a star pattern and allow the cadet to search the area for usable resources like water.

The decision to move will invariably depend on the survivors' experiences, knowledge and skills and answers to questions regarding:

- **Food and Water Resources.** Is there a water source? Are there food sources?
- **Fire and Shelter Resources.** Are there shelter-building resources? Is there wood for fire?
- **Environmental Dangers.** Is the area safe?
- **Health of Party Members.** Can everybody travel? Are there injured members who need to stay in one spot?
- **Risk of Further Injury.** Is there a risk of more injuries if we stay?

---

## CONFIRMATION OF TEACHING POINT 1

---

**QUESTIONS**

- Q1. What is the most important nutrient the body requires?
- Q2. How long can the human body last without food?
- Q3. What factors should be considered when deciding to move?

**ANTICIPATED ANSWERS**

- A1. The most important nutrient the body requires is water.
- A2. The human body can last a few weeks without food.
- A3. Factors to consider include food and water resources, fire and shelter resources, environmental dangers, health of party members and risk of further injury.

**Teaching Point 2****Discuss Planning a Route to Search for Help**

Time: 5 min

Method: Interactive Lecture



This TP is designed to introduce cadets to the factors for planning a route when the decision to self-rescue has been made.

When the decision to move has been made, it is important to leave signs that the group has been there and has decided to move.

Leaving a message or sign that the group has moved, will assist rescuers when they find the initial camp and try to follow the group.

**IDENTIFYING DIRECTION****Determine Direction Using a Shadow Stick**

In a survival situation one may not have a map of the area, a compass or a watch. It will be necessary to use natural phenomena, to determine direction. The sun can be used to find north using a branch or stick to cast a shadow on the ground.

A shadow stick works because the sun always travels east to west, even though it may not rise at exactly 90 degrees or set at exactly 270 degrees. The tip of the shadow stick's shadow moves in the opposite direction, so the first shadow tip is always west of the second, anywhere on earth. Improvised methods are only general indicators of direction. The shadow stick is more accurate and easier to read when the stick is narrow.



The line drawn in Figure 14-5-1 indicates the east-west line. The first mark made is west and the last mark made is east. A line perpendicular to the east-west line is a north-south line.

Steps to make a shadow stick:

1. Find a level, vegetation-free spot. Push the 45- to 60-cm straight stick into the ground about 10 cm so it will remain upright. Incline it by 5–10 degrees to get a longer, bigger shadow if necessary.
2. Mark the tip of the shadow with a stone. Wait until the shadow tip moves a few inches (10–15 minutes with a 45-cm stick).
3. Mark the new position of the shadow tip.
4. Draw a straight line from the first mark through the second mark, and about 30 cm past it.

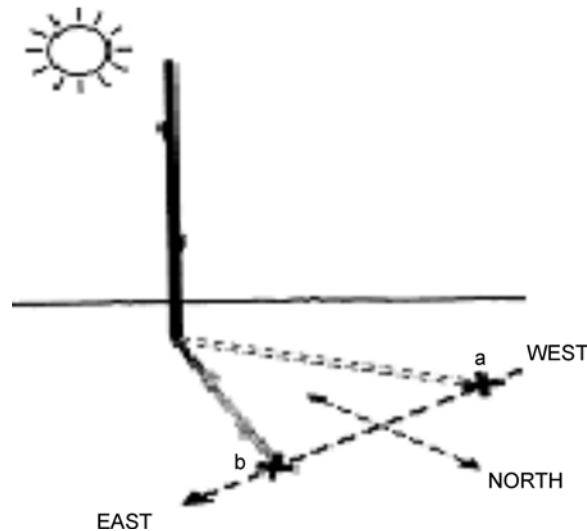

*J. Wiseman, The SAS Survival Handbook, HarperCollins Publishers (p. 353)*

Figure 14-5-1 Shadow Stick

### Determining Direction Using an Analog Watch

An analog watch can help determine direction using either standard or daylight savings time.

Point the hour hand towards the sun and determine the halfway point between the hour hand and 12 o'clock or 1 o'clock (daylight savings time). The halfway point indicates a north-south line (south in the northern hemisphere and north in the southern hemisphere).

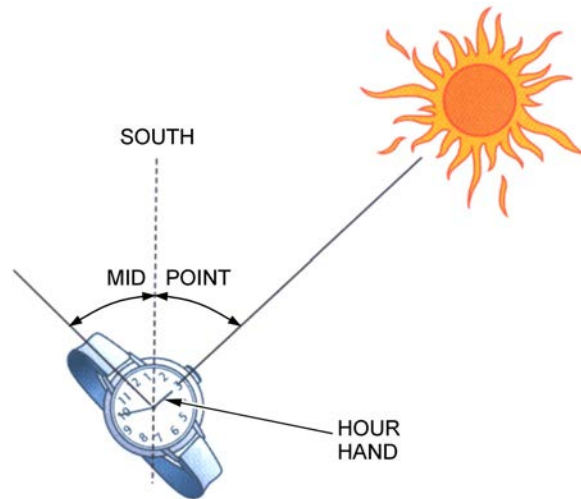

*National Association of Search and Rescue, Fundamentals of Search and Rescue, Jones and Bartlett Publishers, Inc. (p. 76)*

Figure 14-5-2 Analog Watch

## **FOLLOWING RIVERS**

Following rivers will automatically increase survival because it provides the necessary life-support of water. Most waterways will lead to civilization, inland lakes or an ocean.

Rivers offer clearly defined routes to follow although there may be difficult terrain on the shorelines. Steep, rocky and slippery routes along the shore should be avoided. Following the general course of the river will bring the survivor to the same location.

A river cutting through level ground will be easier to follow and most likely have animal trails.

## **MAINTAINING DIRECTION**

When a direction has been decided on, maintain it as best as possible. Choose a prominent feature in the distance and walk towards it.

In a group, use the relay system where one person moves forward, stops and rests and another takes over. This is both to maintain the direction and conserve energy.

## **Walking in a Straight Line**

**Indian Line.** A group of hikers in an open area become landmarks themselves. Hikers are spaced so that the last individual is far enough back to see the leader and the line. The last person lines up the leader with the people in the line. When the leader deviates, they can be signalled to fall back into line.

A distant noise can be followed to reach a destination. Verify direction by cupping the ears and rotating the head to determine the direction of the highest sound intensity.

## **Estimating Distance**

When walking in a straight line, the following table outlines the distances at which objects can be seen.

<b>DISTANCE</b>	<b>ITEM</b>
40 m (132 feet)	Mouth and eyes are clearly distinguished.
90 m (295 feet)	Eyes are dots.
180 m (590 feet)	General details of clothing can be distinguished.
270 m (885 feet)	Faces can be seen.
450 m (1476 feet)	Colours of clothing can be distinguished.
700 m (2297 feet)	People look like posts.
1.5 km (4921 feet)	Trunks of large trees can be seen.
4 km (13 123 feet)	Chimneys and windows can be distinguished.
8 km (26 246 feet)	Large houses, silos and towers can be recognized.
10 km (32 808 feet)	Average height church steeples can be seen.

### **Following Animal Trails**

Following animal trails will most likely lead to a water source. Animals have a set territory near suitable water sources and rarely stray from it.

### **Bushwhacking**

Bushwhacking is the most difficult form of keeping direction. Brush, forests and shores can be quite dense and in warmer climates the vegetation along river shores gets more light and water and is able to grow thicker and stronger. This will inhibit the survivor's ability to move smoothly.

---

## **CONFIRMATION OF TEACHING POINT 2**

---

### **QUESTIONS**

- Q1. What are two ways to determine direction?
- Q2. What are the benefits of following rivers?
- Q3. If one were to follow animal trails, where would they lead?

### **ANTICIPATED ANSWERS**

- A1. Using a shadow stick and an analog watch.
- A2. The benefits of following rivers are they offer clearly defined routes and lead to civilization, inland lakes or an ocean.
- A3. Following animal trails will most likely lead to a water source. Animals have a set territory that is near suitable water sources and rarely stray from it.

**Teaching Point 3****Identify Ways of Marking a Trail**

Time: 10 min

Method: Interactive Lecture



This TP is designed to introduce cadets to marking a trail.

**REASONS FOR MARKING A TRAIL**

Most trails are marked coming and going so that they can be seen from both directions of travel. Trails are also marked to ensure the people using them do not get lost or rerouted.

**Leaving and Returning to the Site**

When searching for water or finding higher ground to build a signal fire, the survivor may have to walk for a kilometre or more. Marking will help to establish the route one can follow to return to the survival site.

**Acting as a Guide to a Ground Search and Rescue Party**

Signs on the ground will draw attention to any presence or past presence and the direction markers will help rescuers follow the survivor's trail.

**TRAIL-MARKING TECHNIQUES**

A large arrow to indicate the direction in which one is travelling. It should be visible from the air. Other direction markers can be interpreted at ground level. Direction markers could include:

- rocks or debris placed in an arrow shape;
- a stick left in a crooked support, with the top pointing in the direction taken;
- grasses tied in an overhand knot with the end hanging in the direction followed;
- forked branches laid with the fork pointing in the direction of travel;
- arrowhead-shape notches cut out of tree trunks indicating a turn;
- small rocks set upon larger rocks, with small rocks beside indicating the direction; and
- a cross of sticks or stones meaning 'Not this way'.

When travelling, continue to mark trails, not only for people to follow but to establish a route to retrace and guide someone who needs to go back on the trail.

Leave a message or sure signs that the group has moved. Hang them from tripods or trees and draw attention to them with markers.



Show the cadets the previously prepared marked trail with grass and rocks. Allow the cadets to ask questions.



**Trees**

Trees are great for marking trails.

To mark a trail with branches:

1. Find a route to follow for 100 m (328 feet).
2. Gather branches which are already on the ground.
3. Place the branches along the route in the direction of travel for 100 m (328 feet).
4. Turn the branches around when returning to the starting point.
5. Return the branches to the environment.

**Saplings**

Saplings can be used to mark trails as they bend easily and can be contorted to indicate the direction of travel.

**Long Grass**

Long grass or straw can be tied together to indicate direction.

**Cairns**

Cairns are piles of rocks used to illustrate where the trail leads. They vary in size from a small grouping of three or four rocks to large piles that can be seen in thick fog. When a trail is marked by cairns, they may be harder to locate than a marking at eye level because they are easy to miss being lower to the ground. Cairns should be used to mark a trail in rocky terrain.



*K. Berger, Backpacking and Hiking, DK Publishing Inc. (p. 158)*

Figure 14-5-3 Cairn

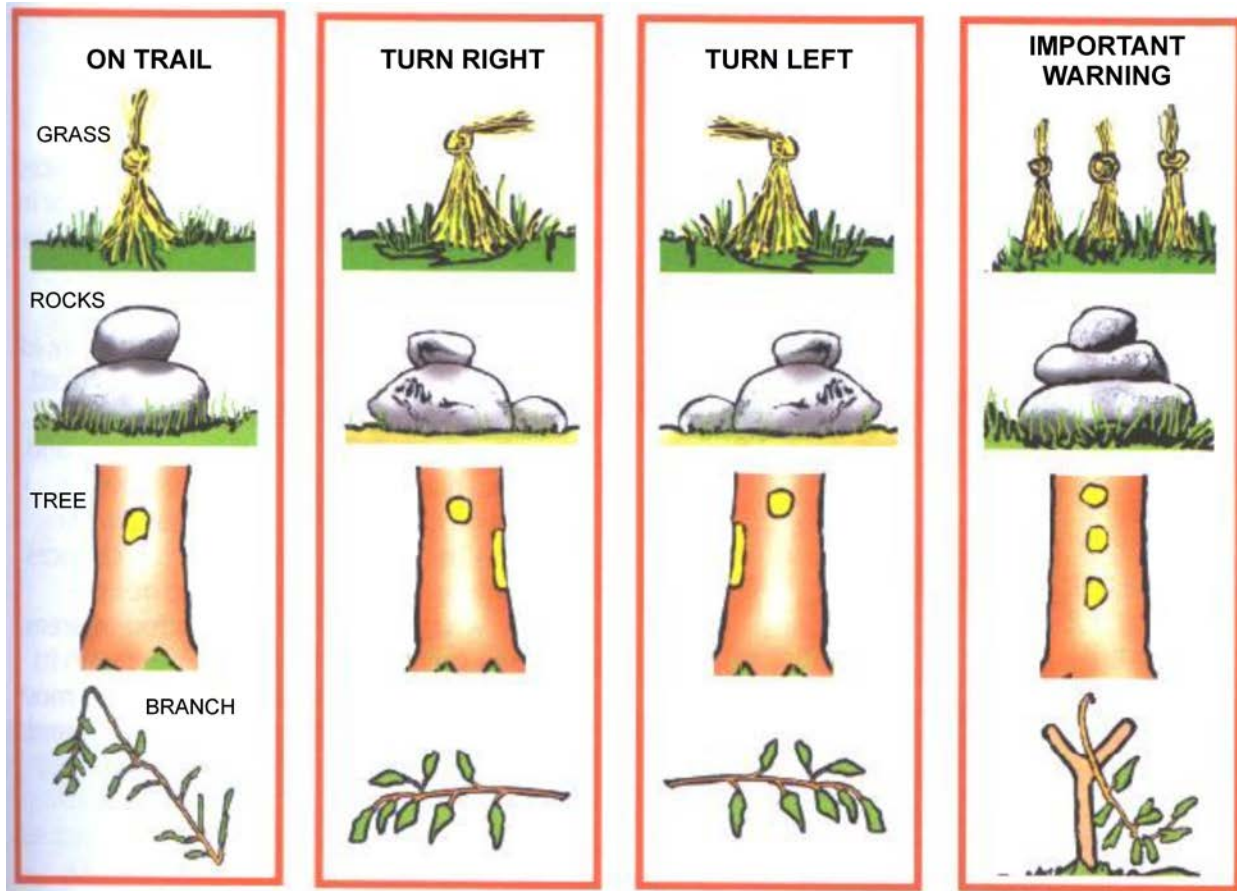

*P. Tawrell, Camping and Wilderness Survival, Paul Tawrell (p. 547)*

Figure 14-5-4 Trail-Marking Techniques

---

**CONFIRMATION OF TEACHING POINT 3**

---

**QUESTIONS**

- Q1. What are the different ways to mark a trail?
- Q2. How is a trail marked with branches?
- Q3. How is a trail marked in rocky terrain?

**ANTICIPATED ANSWERS**

- A1. The different ways to mark a trail are with trees, saplings, long grass and cairns.
- A2. To mark a trail with branches:
  - (1) Find a route to follow for 100 m (328 feet).
  - (2) Gather branches which are already on the ground.
  - (3) Place the branches along the route in the direction of travel for 100 m (328 feet).
  - (4) Turn the branches around when returning to the starting point.
  - (5) Return the branches to the environment.

A3. Trails in rocky terrain are marked by cairns.

---

### END OF LESSON CONFIRMATION

---

#### QUESTIONS

- Q1. What are the factors to consider when deciding to self-rescue?
- Q2. When planning a route to search for help, what are three things to consider?
- Q3. What are some direction markers used when leaving a survival site?

#### ANTICIPATED ANSWERS

- A1. Factors to consider include food and water resources, fire and shelter resources, environmental dangers, health of party members and risk of further injury.
- A2. Identifying direction, following rivers and maintaining direction.
- A3. Direction markers include:
- rocks or debris placed in an arrow shape;
  - a stick left in a crooked support, with the top pointing in the direction taken;
  - grasses tied in an overhand knot with the end hanging in the direction followed;
  - forked branches laid with the fork pointing in the direction of travel;
  - arrowhead-shape notches cut out of tree trunks indicating a turn;
  - small rocks set upon larger rocks, with small rocks beside indicating the direction; and
  - a cross of sticks or stones meaning 'Not this way'.

---

### CONCLUSION

---

#### HOMEWORK/READING/PRACTICE

N/A.

#### METHOD OF EVALUATION

N/A.

#### CLOSING STATEMENT

There are many factors to consider when making a decision to move and search for help in survival situations. Knowing the considerations and what to do when moving will assist the cadet in finding help or being rescued quicker.

#### INSTRUCTOR NOTES/REMARKS

N/A.

---

### REFERENCES

---

A2-046 B-GG-217-001/PT-001 Director Air Operations Training (1983). *Down But Not Out*. Ottawa, ON: Department of National Defence.

- C0-111 (ISBN 0-9740820-2-3) Tawrell, P. (2006). *Camping and Wilderness Survival: The Ultimate Outdoors Book* (2<sup>nd</sup> ed.). Green Valley, ON: Paul Tawrell.
- C2-008 (ISBN 0-00-653140-7) Wiseman, J. (1999). *SAS Survival Handbook*. Hammersmith, London: HarperCollins Publishers.
- C2-148 (ISBN 978-0-8118-3292-5) Davenport, G. (2006). *Wilderness Survival* (2<sup>nd</sup> ed.). Mechanicsburg, PA: Stackpole Books.
- C2-163 (ISBN 0-9694132-0-3) Ferri, G. (1989). *The Psychology of Wilderness Survival*. Hanover, ON: Skyway Printing.



**ROYAL CANADIAN ARMY CADETS**  
**SILVER STAR**  
**INSTRUCTIONAL GUIDE**



**SECTION 6**

**EO C324.01 – IDENTIFY ANIMAL AND INSECT FOOD SOURCES**

---

Total Time: 60 min

---

**PREPARATION**

---

**PRE-LESSON INSTRUCTIONS**

Resources needed for the delivery of this lesson are listed in the lesson specification located in A-CR-CCP-703/PG-001, Chapter, 4. Specific uses for said resources are identified throughout the instructional guide within the TP for which they are required.

Review the lesson content and become familiar with the material prior to delivering the lesson.

Complete a reconnaissance of area used to teach the lesson. Locate different signs of animals and their tracks for TP3

Photocopy the handouts located at Annexes F and G.

**PRE-LESSON ASSIGNMENT**

N/A.

**APPROACH**

An interactive lecture was chosen for TPs 1 and 2 to introduce daily energy requirements and orient the cadet to food sources when lost.

A demonstration was chosen for TP 3 as it allows the instructor to explain and demonstrate finding animal and insect food sources.

A practical activity was chosen for TP 4 as it is an interactive way to allow the cadets to demonstrate identifying animal and insect food sources in a safe, controlled environment. This activity contributes to the development of their outdoor survival skills in a fun and challenging setting.

---

**INTRODUCTION**

---

**REVIEW**

N/A.

**OBJECTIVES**

By the end of this lesson the cadet shall be expected to identify animal and insect food sources.

## IMPORTANCE

It is important for cadets to be able to identify animal and insect food sources in the field. For those participating in expedition training the need to live off natural resources while in the field may become a realistic situation. In a survival situation, a cadet may rely on and make appropriate choices to supplement nutrition and avoid a situation of accidental poisoning or illness.

### Teaching Point 1

### Discuss the Daily Energy Requirements for an Average Person When Surviving in the Field

Time: 10 min

Method: Interactive Lecture

## ENERGY REQUIREMENTS

The body needs food to:

- supply heat;
- supply energy;
- speed recovery after hard work or injury; and
- help fight off disease and maintain mental and physical capabilities.

A healthy body can survive for several days, even weeks without food, depending on environmental conditions. Food replenishes the nutritional substances that a body uses. It provides vitamins, minerals, salts, and other elements essential to good health.



A calorie is a unit of heat – it is the amount needed to raise the temperature of 1 L of water by one degree Celsius. It is the way energy is expressed when discussing nutrition.

## ENERGY NEEDS

The average person in a completely restful state requires 70 calories per hour to maintain their basic metabolism. The simplest activities that make up an ordinary day demand another 45 calories per hour (eg, standing up, sitting down, lighting a fire, etc). That makes a total of about 2040 calories a day without major activities. Participating in a strenuous activity could burn up a further 3500 calories daily. Even mental effort or anxiety will burn additional calories.

Calories are not produced equally by all foods. In general, the energy values of the basic food types are:

- **Carbohydrates.** 1 g produces 4 calories;
- **Fat.** 1 g produces 9 calories; and
- **Protein.** 1 g produces 4 calories.

Consuming more than one source of food will avoid the possibility of nutrient deficiencies. Nutrients must include a combination of carbohydrates, fats and proteins, minerals and other trace elements and vitamins. A balanced diet is important for long-term survival. Do not rely on the easiest source of food for a balanced diet.

### Carbohydrates

Carbohydrates form the bulk of our diets and are a primary source of energy for the body, not just for physical effort but also for fuelling the body and running the nervous system. There are two types of carbohydrates:

- **Fibre.** A complex carbohydrate, and

- **Sugar.** A simple carbohydrate.

### Fats

Fats contain the same elements as carbohydrates but are combined differently. They are a concentrated source of energy, providing twice as many calories as carbohydrates. Fat is stored in the body as a layer under the skin and around the organs. Fats heat and insulate the body, protect organs, lubricate the alimentary tract and build an energy reserve. They are found in meat, eggs, milk and nuts.



The alimentary tract is the passage along which food is passed from the mouth to the anus during digestion.

### Proteins

Proteins build muscles, bones, and teeth and are found in a variety of foods such as meat, poultry, fish, legumes, nuts, milk products, and grain products. Proteins are the only food ingredient containing nitrogen and are therefore essential for the growth and repair of the body. If carbohydrates and fats are missing from the diet, protein is used to generate energy but at the expense of the body's other needs; the body will burn its own tissue muscle for energy.

---

## CONFIRMATION OF TEACHING POINT 1

---

### QUESTIONS

- Q1. What nutrients provide calories for energy?
- Q2. How many calories will an average person at a completely restful state burn in a day?
- Q3. When doing strenuous work how many calories could the body burn?

### ANTICIPATED ANSWERS

- A1. Carbohydrates, fats, and proteins.
- A2. A average person at rest will burn approximately 2040 calories.
- A3. Strenuous work may burn upward of 3500 calories.

### Teaching Point 2

### Identify Edible Insects and Their Habitat

Time: 10 min

Method: Interactive Lecture



This TP should be conducted somewhere close to rotting logs, stones, boards or any other materials lying on the ground providing good nesting sites for insects. During the TP provide examples of insects and grubs found under one of the listed objects above.

Be cautious when overturning objects, as dangerous or poisonous insects or creatures may be found underneath (snakes, spiders, bees, wasps, etc).

### EDIBLE INSECTS

Insects are the most abundant life form on earth and are easily caught. They provide ample amounts of proteins, fats, carbohydrates, calcium and iron. This makes insects a valuable food source for survival.

Although a fair number of insects can be eaten raw, it is best to cook them in order to avoid ingesting parasites. Collect only living specimens. Avoid any that look sick or dead, have a bad smell or produce skin irritation or a rash when handled. The nutritional value per 100 g of various insects is illustrated in the chart at Figure 14-6-1.



Individuals with known allergies to insects or arthropods should exercise caution. Insects and shellfish are in the same category. People who suffer allergic reactions to lobster, shrimp, crayfish, and other such foods should avoid eating insects.

## NUTRITIONAL VALUE

One gram of carbohydrates equals four calories. This calculation relates to the amount of calories that must be consumed to maintain strength and basic functions when surviving in the field. Note that there is a significant amount of protein that comes from insects.



Distribute handout Annex G.

Have cadets, based on the chart, determine what two insects they would eat. Have them then calculate the amount of insects they would have to eat in order to make up half of their daily caloric intake (roughly 1020 calories).

Insect (per 100 g)	Protein (g)	Fats (g)	Carbohydrates (g)	Calcium (mg)	Iron (mg)
Crickets	12.9	5.5	5.1	75.8	9.5
Small grasshoppers	20.6	6.1	3.9	35.2	5.0
Giant water beetles	19.8	8.3	2.1	43.5	13.6
Red ants	13.9	3.5	2.9	47.8	5.7
Silkworm pupae	9.6	5.6	2.3	41.7	1.8
Termites	14.2	n/a	n/a	0.050	35.5
Weevils	6.7	n/a	n/a	0.186	13.1

*G. Davenport, Wilderness Survival, Stackpole Books (p. 161)*

Figure 14-6-1 Nutritional Value

## INSECT HABITAT

Rotting logs, stones, boards or any other materials lying on the ground provide good nesting sites and are excellent places to find a variety of insects including ants, termites, beetles and grubs. Grassy areas are good areas to search because insects are easily seen. The following insects can commonly be found in most locations.

**Grasshoppers.** Most commonly found in open fields. Watch for them jumping out of the way when walking. Eaten raw or cooked, remove the legs.





*Discover Entomology, by Carl D. Patrick, Grasshoppers and Their Control, Copyright 2008 by Texas A&M University Department of Entomology. Retrieved March 5, 2008, from <http://insects.tamu.edu/extension/bulletins/l-5201.html>*

Figure 14-6-2 Grasshopper

**Beetles.** Often found under rotting logs, stones, boards or any other material lying on the ground. Insects with hard outer shells will have parasites so cook them before eating.

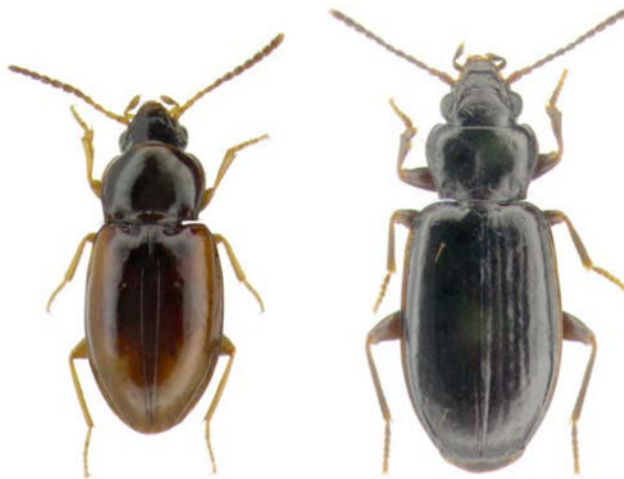

*Canadian Biodiversity Information Facility, Ground Beetles of Canada. Retrieved March 5, 2008, from [http://www.cbif.gc.ca/spp\\_pages/carabids/phps/image1\\_e.php#Bembidiini](http://www.cbif.gc.ca/spp_pages/carabids/phps/image1_e.php#Bembidiini)*

Figure 14-6-3 Beetles

**Worms.** Worms are an excellent source of protein, a large proportion of essential amino acids and are easily collected. Dig for them in damp soil or watch for them on the ground after rain. After collecting them, drop them into clean, potable water for a few minutes. The worms will naturally purge or wash themselves out, after which they can be eaten raw.



*Cheshire Wildlife Trust, Find Out About Earth Worms, Copyright 2004 by Cheshire Wildlife Trust. Retrieved March 5, 2008, from [http://www.wildlifetrust.org.uk/cheshire/watch\\_earthworms.htm](http://www.wildlifetrust.org.uk/cheshire/watch_earthworms.htm)*

Figure 14-6-4 Earth Worm

**Grubs.** Known as insect larva, grubs are often found under rotting logs, stones, boards or any other materials lying on the ground.



*Green Smiths, Grub Worms. Retrieved March 5, 2008, from <http://www.greensmiths.com/grubs.htm>*

Figure 14-6-5 Grubs

**Aquatic Insects.** Many species of edible insects exist around the edges of lakes, or ponds, or the ocean. Cook any hard shell insects.



*P. Tawrell, Camping and Wilderness Survival (2<sup>nd</sup> ed.), Paul Tawrell (p. 912)*

Figure 14-6-6 Water Insects

---

## CONFIRMATION OF TEACHING POINT 2

---

### QUESTIONS

- Q1. What nutritional value will insects provide for survival?
- Q2. Where would insects be generally located?
- Q3. How would someone find worms?

### ANTICIPATED ANSWERS

- A1. Insects will provide ample amounts of proteins, fats, carbohydrates, calcium and iron.
- A2. Under rotting logs, stones, boards or any other materials lying on the ground providing good nesting sites and are excellent places to find a variety of insects.
- A3. Dig for them in damp soil or watch for them on the ground after rain.

---

### Teaching Point 3

### Discuss Finding Small Animals

Time: 15 min

Method: Demonstration

---



During this TP move about the training area pointing out different signs of animals. Identify their tracks and habitat to the cadets.

### IDENTIFYING TRACKS AND HABITAT

All animals can be a source of nourishment. The more one knows about animals, the better the chances of locating an animal. To find an animal in the wild, one must be observant for signs. If a person can recognize the signs an animal leaves, and identify the animal, one can devise a method to hunt and trap it.

Most mammals are on the move at dawn and dusk (first light, last light), using regular routes between their watering spots, feeding places and homes. Animal tracks and trails can be identified by looking for specific signs.

The following are tips to locate and identify animals:

- Tracks are more obvious on wet ground snow and damp sand.
- The size of the impression is left from their tracks.
- The age of the track can be identified by its sharpness and moisture content.
- The clearer the track the more recent it is. If water or rain has seeped into it, it may be older.
- Heavy vegetation reveals regularly used routes or paths.
- Some animals never travel very far; any tracks likely mean they are in the area.
- Smaller animals make tunnels through dense underbrush.
- Broken twigs along a route, will identify direction of travel and the height of the animal.

### Rabbits and Hares

Rabbits and hares are easy to catch. They live either in burrows or above ground and most often use a specific run that they routinely retrace. Rabbits and hares have long hind legs with small front paws. When looking for rabbits or hares, keep the following in mind:

- They leave little detail on soft ground.
- They have a narrow hind foot with four toes.
- They leave tracks with their hind feet in front of the forefoot instead of side by side.
- They eat tree bark and may nibble the base of a tree.
- They warn other rabbits and hares by using their paws to create sounds. The sound emitted sounds like a thump or someone hitting a cushion.



*N. Bowers, R. Bowers, and K. Kaufman, Kaufman Focus Guides: Mammals of North America, Houghton Mifflin Company (p. 35)*

Figure 14-6-7 Rabbit and Tracks

### Squirrels

Squirrels are alert and very nimble. Most are active day and night – feeding on nuts, fruits, shoots and for some bird's eggs. Their nests are usually the size of a small day pack, made of sticks and leaves, high in

trees. However, squirrels seek out tree hollows for winter dens. Squirrels are small and their tracks are barely noticeable. Signs of squirrel presence include:

- chewed cones,
- cone scales piled about, and
- loud and almost continuous high-pitched squeals and chirps.



*N. Bowers, R. Bowers, and K. Kaufman, Kaufman Focus Guides: Mammals of North America, Houghton Mifflin Company (p. 49)*

Figure 14-6-8 Squirrel and Tracks

### Marmots (Groundhogs)

The groundhog is most commonly found in pastures, on roadsides, and overgrown fields. Groundhogs live alone in burrows up to 9 m long (30 feet), excavated under stumps, rocks or edges of buildings. Normally there are three entrances to the burrows. They are visible, measuring 20–30 cm (8–12 inches) across, with big mounds of dirt nearby.



*N. Bowers, R. Bowers, and K. Kaufman, Kaufman Focus Guides: Mammals of North America, Houghton Mifflin Company (p. 91)*

Figure 14-6-9 Marmot (Groundhog) and Tracks

### Porcupines

The porcupine is the second largest rodent. It has sharp quills that are solid at the base and barbed at the tip. This animal feeds mainly on grasses, acorns and twigs and is fond of salt. Their tracks and signs include:

- footprints, where the front paws have four toes and hind paws have five toes,
- trees with bark stripped in irregular patches, and
- nipped twigs littering the ground.





*N. Bowers, R. Bowers, and K. Kaufman, Kaufman Focus Guides: Mammals of North America, Houghton Mifflin Company (p. 109)*

Figure 14-6-10 Porcupine and Tracks

### Beavers

Beavers are known as dam builders. They are aquatic animals with scaly, padded-like tails. They can be found using regular runs along streams, lakes, or bogs/marshes and reside in a den known as a beaver house, where they can be trapped. Their tracks and signs include:

- fore footprints that have five toes with claw marks but, often only four show,
- rear footprints that are webbed, roundish and larger,
- water levels that are higher than normal in lakes, bogs or marshes,
- the presence of a beaver dam, lodges, fallen and chewed saplings, and
- the presence of bark shavings near water.



*N. Bowers, R. Bowers, and K. Kaufman, Kaufman Focus Guides: Mammals of North America, Houghton Mifflin Company (p. 110)*

Figure 14-6-11 Beaver and Tracks

### Raccoons

The “masked bandit” lives in a variety of habitats, from forests to prairies to city parks. They prefer to be in the vicinity of water and trees and are most abundant in wooded swamps. They reside in dens often in a hollow

tree or log, rock crevice, cave or abandoned building. A raccoon's diet from land sources includes nuts, fruit, insects, small rodents, and birds. Near water they will eat frogs, fish, molluscs and insects. Their tracks and signs include:

- a hind track that is about 7.62 cm (3 inches) long with 5 toes, and
- a front paw that is like a small hand with five fingers.



*N. Bowers, R. Bowers, and K. Kaufman, Kaufman Focus Guides: Mammals of North America, Houghton Mifflin Company (p. 99)*

Figure 14-6-12 Raccoon and Tracks

### DETECTING SIGNS OF FEEDING

A skilled eye can often identify the species of animal by the pattern left by teeth or beak marks on a nut, or the way in which a pine cone has been stripped to get at its seeds. Some signs of feeding that may be found in the wilderness include:

- bark stripped from trees,
- the gnawed shells of nuts,
- partially-eaten fruits,
- bitten-off shoots,
- the remains of prey, and
- remains of carnivores or the destruction of nests.

Discarded fruits or nuts are often found when food is plentiful – an animal finds one piece not to its liking and drops it to try another. They not only disclose an animal's presence but suggest bait for traps.

### FINDING DROPPINGS

Droppings (sometimes called scat) are one of the best indications of whether an animal is a herbivore or a carnivore. The size of the animal can be judged from the mass and quantity of droppings. The dropping's dryness is an indication of how long it has been since they were passed. Old droppings will be hard and odourless. Fresh droppings will be wet, still smell and may be covered by flies.

The composition of droppings can be used to figure out what kind of animal deposited it. Bits of plant material (stems, seeds, husks, and stalks) indicate a herbivore (plant eater). There is almost no scent to the droppings of a plant eater, although those that have gorged on berries leave sweet smelling scat.

Droppings filled with animal material (scales, bones, and fur) left by a carnivore, usually has a rank smell. A mass of flies indicate a pile of fresh droppings.

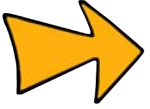

If flies can be heard buzzing but they can not be spotted, there may be fresh kill from a ferocious wild animal. Leave the area immediately.

### IDENTIFYING ROOTINGS

Some animals root up the ground in search of insects and tubers. If the earth is still crumbly and fresh an animal is likely to have been active on the spot. Small scratches may be where a squirrel or other rodents have been digging for shoots.

### DETECTING SCENTS AND SMELLS

Be alert and if you smell anything out of the ordinary. Try and register the smells. They may be indications of wildlife present. Where one kind of animal exists, there will also be others.

---

### CONFIRMATION OF TEACHING POINT 3

---

### QUESTIONS

- Q1. When are most animals moving about their environment?
- Q2. What route does a rabbit usually follow?
- Q3. If you were lost in a wooded area near a lake, what animals may you find?

### ANTICIPATED ANSWERS

- A1. Most animals move about their environment during dawn and dusk.
- A2. A rabbit will usually follow a specific route that they routinely retrace.
- A3. You may find beavers and racoons.

---

### Teaching Point 4

**Conduct an Activity Where Cadets, in Pairs, Will Search the Local Area for Animal and Insect Food Sources by Identifying Two Signs of Recent Activity That Will Lead Them to Food**

Time: 20 min

Method: Practical Activity

---

### ACTIVITY

---

### OBJECTIVE

The objective of this activity is to have the cadets identify animals and insect food sources by finding signs of recent activity in the field.

### RESOURCES

Animal and insect handout.



**ACTIVITY LAYOUT**

N/A.

**ACTIVITY INSTRUCTIONS**

1. Divide the cadets into pairs.
2. Distribute the handout located at Annex F.
3. Have the cadets search the training area and identify animals and/or insect food sources by finding signs of recent activity in the field.
4. Have the cadets describe the signs of recent activity, to include:
  - (a) type of animal and or insect; and
  - (b) estimated size of the animal or insect.

**SAFETY**

- Set boundaries around the areas of use.
- Additional staff can be used to help supervise during this task.

---

**CONFIRMATION OF TEACHING POINT 4**

---

The cadets' participation in the activity will serve as the confirmation of this TP.

---

**END OF LESSON CONFIRMATION**

---

**QUESTIONS**

- Q1. If a person was to consume 1 g of carbohydrates, how many calories would this produce?
- Q2. What is the danger of consuming only one type of food when in a survival situation?
- Q3. Where would you most likely find a beaver?

**ANTICIPATED ANSWERS**

- A1. 1 g of carbohydrates produces four calories.
- A2. Consuming only one type of food may limit the necessary nutrients the body needs to survive.
- A3. Beavers can be found using regular runs along streams, lakes, or bogs/marshes and residing in their den known as a beaver house.
- 

**CONCLUSION**

---

**HOMEWORK/READING/PRACTICE**

N/A.

**METHOD OF EVALUATION**

N/A.

## CLOSING STATEMENT

A person who becomes lost in the field will find themselves in a scary and dangerous situation if they are unaware of how to deal with the situation. Cadets have been provided with knowledge of where and how to locate edible animal and insect food sources that will provide the necessary nutrients to survive.

## INSTRUCTOR NOTES/REMARKS

N/A.

---

## REFERENCES

---

- C0-111 (ISBN 0-9740820-2-3) Tawrell, P. (2006). *Camping and Wilderness Survival: The Ultimate Outdoors Book* (2<sup>nd</sup> ed.). Lebanon, NH: Paul Tawrell.
- C2-008 (ISBN 0-00-653140-7) Wiseman, J. (1999). *The SAS Survival Handbook*. Hammersmith, London: HarperCollins Publishers.
- C2-148 (ISBN 978-0-8117-3292-5) Davenport, G. (2006). *Wilderness Survival*. Mechanicsburg, PA: Stackpole Books.
- C2-155 (ISBN 978-1-58574-556-2) The Lyons Press. (2002). *U.S. Army Survival Handbook*. Guilford, CT: The Lyons Press.



**ROYAL CANADIAN ARMY CADETS**  
**SILVER STAR**  
**INSTRUCTIONAL GUIDE**



**SECTION 7**  
**EO C324.02 – CONSTRUCT SNARES**

---

Total Time: 120 min

---

**PREPARATION**

---

**PRE-LESSON INSTRUCTIONS**

Resources needed for the delivery of this lesson are listed in the lesson specification located in A-CR-CCP-703/PG-001, Chapter 4. Specific uses for said resources are identified throughout the instructional guide within the TP for which they are required.

Review the lesson content and become familiar with the material prior to delivering the lesson.

Prepare 60 cm (2 feet) lengths of non-ferrous wire for each cadet.

Prepare examples of the different snares and traps for demonstrations on how they work.

**PRE-LESSON ASSIGNMENT**

N/A.

**APPROACH**

An interactive lecture was chosen for TP 1 to introduce constructing snares.

Demonstration and performance was chosen for TPs 2–4 as it allows the instructor to explain and demonstrate constructing snares while providing an opportunity for the cadet to practice these skills under supervision.

---

**INTRODUCTION**

---

**REVIEW**

N/A.

**OBJECTIVES**

By the end of this lesson the cadet shall have constructed snares.

**IMPORTANCE**

Non-ferrous wire is a common component in a survival kit. It is used in the construction of snares in a survival situation. It is important for cadets to know how to construct snares because in a survival situation, snares will trap game and provide nourishment.

**Teaching Point 1****Discuss Types of Snares**

Time: 10 min

Method: Interactive Lecture



Discuss the different types of snares that can be made to catch wild game.

Snares are the simplest traps and snare wire should be part of any survival kit. Snares are made from non-ferrous wire (wire that is not iron or steel) with a running eye at one end through which the other end of the wire passes before being firmly anchored to a stake, rock or tree. A snare is a free running noose which can catch small game around the throat and larger game around the leg.

**TYPES OF SNARES****Simple Snare**

A simple snare may be made of non-ferrous wire, string, plant cordage, roots, horse hair, rawhide, dried animal entrails, etc. The best material for constructing a simple snare is non-ferrous wire because it keeps its round shape and is easily twisted to make a loop through which the moving part of the wire will slide.

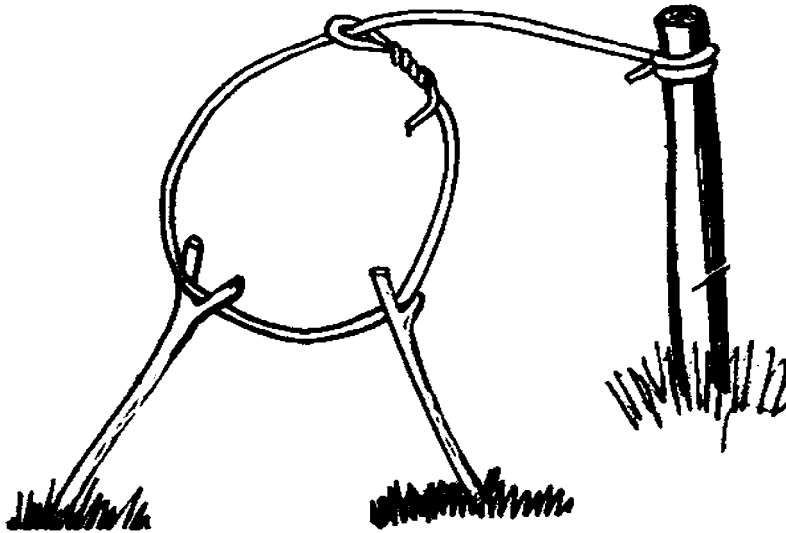

*P. Tawrell, Camping & Wilderness Survival: The Ultimate Outdoors Book, Paul Tawrell (p. 160)*

Figure 14-7-1 Simple Snare

**Squirrel Trap**

A squirrel trap is made with several small nooses on an inclined log. The squirrel will pass its head through the noose and fall off the log causing the snare to tighten. The dangling squirrel will not deter other squirrels from being caught.

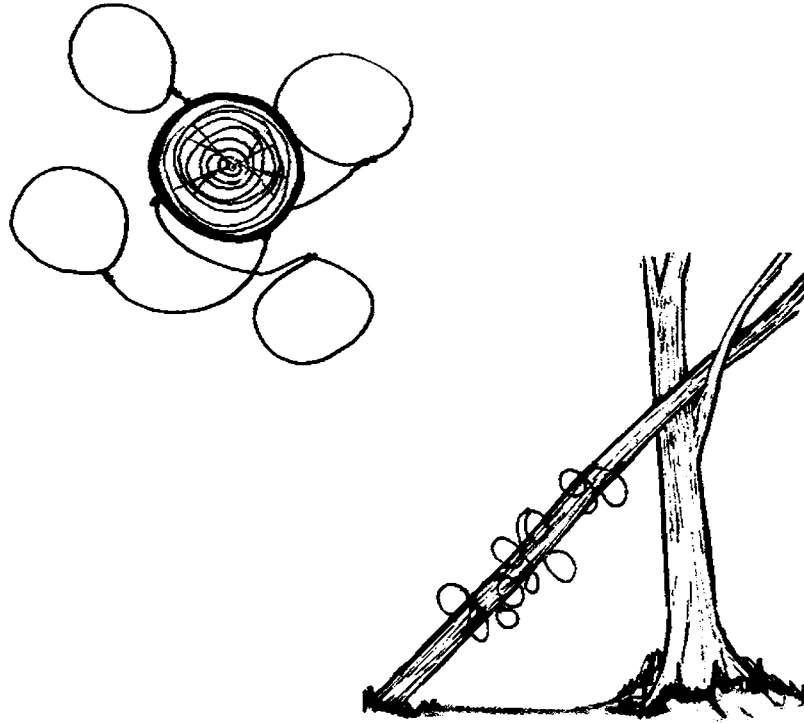

*P. Tawrell, Camping & Wilderness Survival: The Ultimate Outdoors Book, Paul Tawrell (p. 160)*

Figure 14-7-2 Squirrel Snare

### Baited Spring Snare

A baited spring snare tempts game with food. Once caught, the snare will lift game off the ground. The noose is laid on the ground and the bait strung above. As game takes the bait, the trigger is released. The baited spring snare is suited for medium-sized animals, such as foxes. This trap can be located in an open area as the bait will attract animals. A small clearing in the woods is a good site for the baited spring snare.

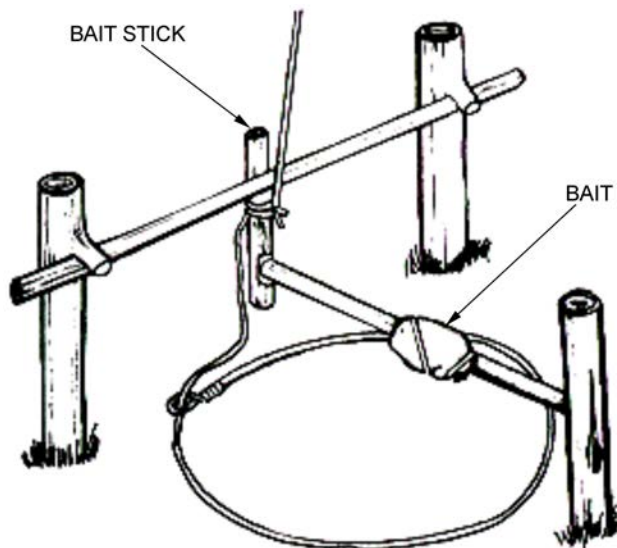

*P. Tawrell, Camping & Wilderness Survival: The Ultimate Outdoors Book, Paul Tawrell (p. 160)*

Figure 14-7-3 Baited Spring Snare

---

## CONFIRMATION OF TEACHING POINT 1

---

### QUESTIONS

- Q1. Name the three types of snares.
- Q2. Which snare is made with several small nooses on an inclined log?
- Q3. Which snare has a noose laid on the ground?

### ANTICIPATED ANSWERS

- A1. The three types of snares are a simple snare, a squirrel trap and a baited spring snare.
- A2. A squirrel trap is made with several small nooses on an inclined log.
- A3. The baited spring snare has a noose laid on the ground.

---

### Teaching Point 2

### Explain, Demonstrate and Have the Cadet Construct a Simple Snare

Time: 35 min

Method: Demonstration and Performance

---



For this TP, it is recommended that instruction take the following format:

1. Explain and demonstrate constructing a simple snare while cadets observe.
2. Explain and demonstrate each step required to construct a simple snare. Monitor cadets as they imitate each step.

**Note:** Assistant instructors may be employed to monitor the cadets' performance.

### SIMPLE SNARE

#### Constructing A Simple Snare

Instructions for constructing a simple snare:

1. **Select the Site.** Find the game trails or runs, which lead from the animal's home to where it feeds or waters. Look for natural bottlenecks along the route where it will have to pass through (deadwood fall or a place where the track goes under an obstruction). Guidelines to set a snare include:
  - **Avoid Disturbing the Environment.** Do not walk on the game trail. Do all preparation off the trail and do not leave any sign that you have been there.
  - **Hide Scent.** When constructing or handling traps do not leave a scent on them. Handle as little as possible and wear gloves. Make a trap of the same type of wood that is in the surrounding environment. Each tree gives off its own smell. Animals have an acute sense of smell and may be wary of a different scent. Exposing a snare to smoke can mask any human scent.
  - **Camouflage.** Hide freshly cut ends of wood with mud. Cover any snare on the ground to blend it as naturally as possible with its surroundings.
2. **Make the Snare From Wire.** Use non-ferrous wire, to make a loop, fist-width wide, and twist the end of the loop to ensure its stability while allowing the moving part to slide easily.

3. **Set the Snare.** Keep in mind the type of animal that is being trapped and set the snare above the ground, next to an obstruction on the trail (for a rabbit use four fingers above the ground and one hand width from the obstruction).
4. **Anchor Securely.** Check that the snare is anchored securely, with twigs to support the loop, if necessary. A snared animal is fighting for its life. It will exert a lot of energy in an attempt to escape. Any weakness in the trap will be exposed.
5. **Make a Funnel.** The animal run can be directed to the trap increasing the likelihood of a successful capture. To make a funnel place twigs and boughs and other obstructions that will guide animals into the snare.

---

## ACTIVITY

Time: 25 min

---

### OBJECTIVE

The objective of this activity is to have the cadets construct a simple snare.

### RESOURCES

- Non-ferrous wire, and
- Knife.

### ACTIVITY LAYOUT

N/A.

### ACTIVITY INSTRUCTIONS

1. Divide the cadets into pairs.
2. Provide each pair with non-ferrous snare wire and a knife.
3. Have the cadets construct a simple snare as demonstrated at the beginning of the lesson. Snares shall be constructed to simulate trapping rabbits.
4. Have the cadets tour each site. Debrief the cadets on each snare identifying strengths and weaknesses.
5. Have the cadets disassemble the snares and return materials.

### SAFETY

N/A.

---

## CONFIRMATION OF TEACHING POINT 2

---

The cadets' participation in the activity will serve as the confirmation of this TP.

**Teaching Point 3****Explain, Demonstrate and Have the Cadets Practice  
Constructing a Squirrel Trap**

Time: 35 min

Method: Demonstration and Performance



For this TP, it is recommended that instruction take the following format:

1. Explain and demonstrate constructing a squirrel trap while cadets observe.
2. Explain and demonstrate each step required to construct a squirrel trap. Monitor cadets as they imitate each step.
3. Monitor the cadets' performance as they practice the complete skill.

**Note:** Assistant instructors may be employed to monitor the cadets' performance.

**SQUIRREL TRAP**

Instructions for constructing a squirrel trap:

1. **Select the Site.** Find the game trails or runs, which lead from the animals' home to where it feeds or waters. When setting the squirrel trap identify the squirrel's run by locating a worn down route or tracks. Look for natural bottlenecks along the route where the squirrel will have to pass through or over and set the trap in combination with the following guidelines:
  - **Avoid Disturbing the Environment.** Do not walk on the game trail. Do all preparation off the trail and do not leave any sign that you have been there.
  - **Hide Scent.** When constructing or handling traps do not leave your scent on them. Handle as little as possible and wear gloves. Make a trap of the same type of wood that is in the surrounding environment. Each tree gives off its own smell. Animals have an acute sense of smell and may be wary of a different scent. Exposing a snare to smoke can mask any human scent.
  - **Camouflage the Trap.** Hide freshly cut ends of wood with mud. Cover any snare on the ground to blend it as naturally as possible with its surroundings.
2. **Make Several Small Nooses.** Use non-ferrous wire to make a loop, fist-width wide, and twist the end of the loop to ensure its stability while allowing the moving part to slide easily. Make several nooses as illustrated in Figure 14-7-4.



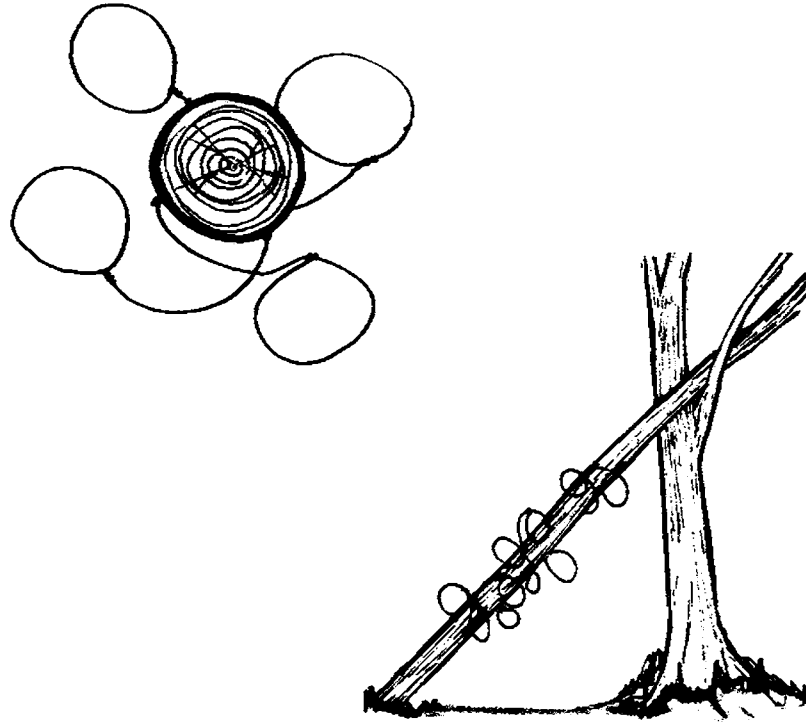

*P. Tawrell, Camping & Wilderness Survival: The Ultimate Outdoors Book, Paul Tawrell (p. 160)*

Figure 14-7-4 Squirrel Trap

3. **Arrange Nooses on an Inclined Trunk.** Arrange several small nooses on an inclined trunk. The squirrel will pass its head through the noose and fall off the log. The dangling squirrel will not deter other squirrels from being caught.

---

### ACTIVITY

Time: 25 min

---

### OBJECTIVE

The objective of this activity is to have the cadets construct a squirrel trap.

### RESOURCES

- Non-ferrous wire, and
- Knife.

### ACTIVITY LAYOUT

N/A.

### ACTIVITY INSTRUCTIONS

1. Divide the cadets into pairs.
2. Provide each pair with non-ferrous snare wire and a knife.
3. Have the cadets construct a squirrel trap as demonstrated at the beginning of the lesson.

4. Have the cadets tour each site. Debrief the cadets on each snare identifying strengths and weaknesses.
5. Have the cadets disassemble the snares and return materials.



During the debriefing ask cadets how many of them made the traps with their bare hands. Remind cadets how scent can deter animals, and how important it is to try and conceal their scent while setting traps.

## SAFETY

N/A.

---

### CONFIRMATION OF TEACHING POINT 3

---

The cadets participation in the activity will serve as the confirmation of this TP.

---

## Teaching Point 4

### Explain, Demonstrate and Have the Cadets Practice Constructing a Baited Spring Snare

Time: 35 min

Method: Demonstration and Performance

---



For this TP, it is recommended that instruction take the following format:

1. Explain and demonstrate constructing a baited spring snare while cadets observe.
2. Explain and demonstrate each step required to construct a baited spring snare. Monitor cadets as they imitate each step.
3. Monitor the cadets' performance as they practice the complete skill.

**Note:** Assistant instructors may be employed to monitor the cadets' performance.

## BAITED SPRING SNARE

A baited spring snare is situated in the open and lures animals to it with food. The bait is laid on the ground or strung above. As the game takes the bait, the trigger is released. When game is caught the trigger bar disengages and the game is lifted off the ground. This snare is good for animals such as rabbits and foxes, as it will trap game coming in both directions and is situated in an open area, as the bait will attract attention.

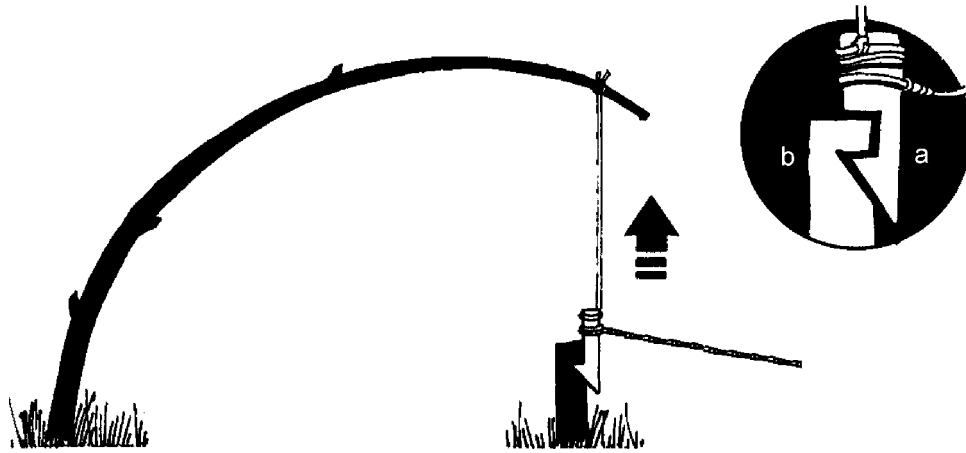

*J. Wiseman, The SAS Survival Handbook, HarperCollins Publishers (p. 188)*

Figure 14-7-5 Squirrel Snare

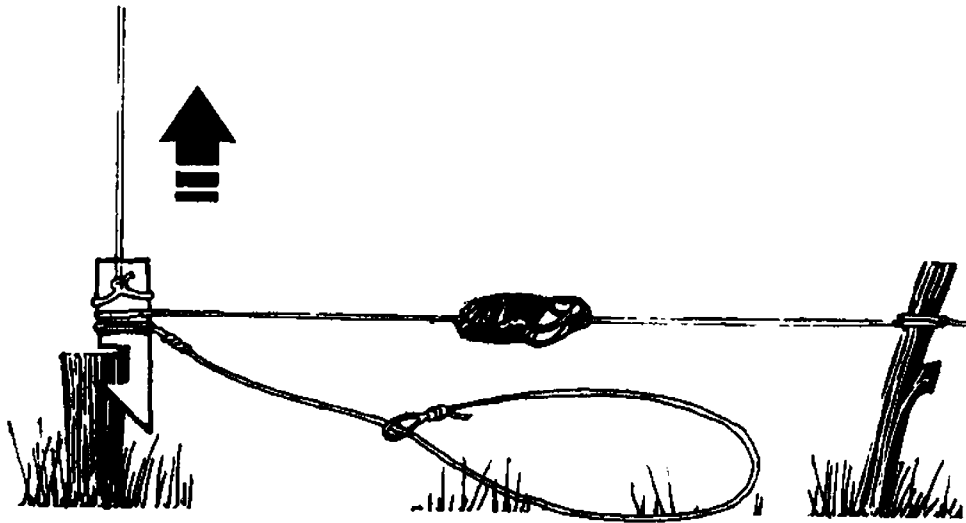

*J. Wiseman, The SAS Survival Handbook, HarperCollins Publishers (p. 188)*

Figure 14-7-6 Baited Spring Snare

Instructions for constructing a baited spring snare:

1. **Locate a Spring.** Find the game trail or run close to an open area close to a possible spring snare. The spring should be a small tree, two to five years old, that is flexible and can hold the weight of a small animal. The guidelines when constructing a baited spring snare are:
  - **Avoid Disturbing the Environment.** Do not walk on the game trail. Do all your preparation off the trail and do not leave any sign that you have been there.
  - **Hide Scent.** When constructing or handling traps do not leave a scent on them. Handle as little as possible and wear gloves. Make a trap of the same type of wood that is in the surrounding environment. Each tree gives off its own smell. Animals have an acute sense of smell and may be wary of a different scent. Exposing a snare to smoke can mask any human scent.
  - **Camouflage.** Hide freshly cut ends of wood with mud. Cover any snare on the ground to blend it as naturally as possible with its surroundings.

2. **Make a Trigger Bar.** A trigger bar is the string that stretches across and above the trap (this can be a stick as well). It is created by stretching a string from a stake to the release mechanism. Bait is placed or attached to the string and when moved will release the spring mechanism, catching the animal.
3. **Cut Release Notches.** The release notches are cut to resemble a sharp end with a notch located a few centimetres down from the tip. The notch locks the two bars together until the bar is moved as illustrated in Figure 14-7-5.
4. **Bait the Line.** Determine the animal to be caught and bait it accordingly. The bait should be wrapped tightly to the trigger bar or string, forcing the animal to bite the bait roughly. The movement will release the spring.
5. **Set the Noose.** Once all parts have been constructed set a snare on the ground under the bait and:
  - (a) Attach the snare to the release notch system (Part A as seen in Figure 14-7-5).
  - (b) Attach baited string to release (Notch A as seen in Figure 14-7-5).
  - (c) Drive a stake into the ground with Notch B. The stake must be able to handle the pulling of the spring. Drive the stake in on an angle to add strength to the stake.
  - (d) Set spring by attaching a string to the tip of the spring. The string should reach release Notch A however the spring must have a bend (bow) in it. When tripped it will release with force pulling the snare, trapping the animal and lifting the animal into the air.
  - (e) Pull the spring to the ground.
  - (f) Set release notches together and slowly allow the system to establish tension.
  - (g) Have the spring and lines hold under the tension of all parts. Any jolt to the system should release the notches and activate the spring, pull the snare and catch the animal.

---

### ACTIVITY

Time: 25 min

---

### OBJECTIVE

The objective of this activity is to have the cadets construct a baited spring snare.

### RESOURCES

- String,
- Simulated bait,
- Knife, and
- Non-ferrous snare wire.



Bait can be anything small that attaches to the line. The idea here is to attach something that will simulate the use of bait, luring the game to the trap.

**ACTIVITY LAYOUT**

N/A.

**ACTIVITY INSTRUCTIONS**

1. Divide the cadets into pairs.
2. Provide each pair with non-ferrous snare wire, string, simulated bait and a knife.
3. In pairs, have the cadets construct a baited spring snare as demonstrated at the beginning of the lesson.
4. Have the cadets tour each site. Debrief the cadets on each snare identifying the strengths and weaknesses.
5. Have the cadets disassemble the snares and return materials to the instructor.



During the debriefing ask cadets how many of them made the traps with their bare hands. Remind cadets of how scent can deter animals, and how important it is to try and conceal their scent while setting traps.

**SAFETY**

The spring snare can be dangerous when setting. Caution cadets to be careful not to accidentally release the spring on themselves. The spring should not lift cadets off the ground, however. the tree can afflict injury to an eye or other body parts.

---

**CONFIRMATION OF TEACHING POINT 4**

---

The cadets' participation in the activity will serve as the confirmation of this TP.

---

**END OF LESSON CONFIRMATION**

---

The cadets' participation in constructing snares will serve as the confirmation of this lesson.

---

**CONCLUSION**

---

**HOMEWORK/READING/PRACTICE**

N/A.

**METHOD OF EVALUATION**

N/A.

**CLOSING STATEMENT**

If a cadet is in a survival situation, the cadet may rely on their training to construct snares and traps to catch wild game to provide their nutritional requirements until rescue.

**INSTRUCTOR NOTES/REMARKS**

Additional instructors may be required to help with the construction of snares and supervision of cadets during activity sessions.

Instructors are to clearly communicate that the intent of this lesson is to prepare cadets for a survival situation. Cadets should not be encouraged to actually trap game during this lesson.

---

**REFERENCES**

---

- C2-004 (ISBN 1-896713-00-9) Tawrell, P. (1996). *Camping and Wilderness Survival: The Ultimate Outdoors Book*. Green Valley, ON: Paul Tawrell.
- C2-008 (ISBN 0-00-653140-7) Wiseman, J. (1999). *The SAS Survival Handbook*. Hammersmith, London: HarperCollins Publishers.



**ROYAL CANADIAN ARMY CADETS**  
**SILVER STAR**  
**INSTRUCTIONAL GUIDE**



**SECTION 8**  
**EO C324.03 – CATCH A FISH**

---

Total Time: 90 min

---

**PREPARATION**

---

**PRE-LESSON INSTRUCTIONS**

Resources needed for the delivery of this lesson are listed in the lesson specification located in A-CR-CCP-703/PG-001, Chapter 4. Specific uses for said resources are identified throughout the instructional guide within the TP for which they are required.

Review the lesson content and become familiar with the material prior to delivering the lesson.

Check provincial fishing regulations prior to conducting a fishing activity; a provincial permit must be purchased if required.

Prepare examples of each fishing instrument in TP 2 to aid in the explanations and demonstrations.

**PRE-LESSON ASSIGNMENT**

N/A.

**APPROACH**

An interactive lecture was chosen for TPs 1 and 2 to introduce and orient the cadet to catching a fish.

Demonstration and performance was chosen for TP 3 as it allows the instructor to explain and demonstrate constructing fishing instruments while providing an opportunity for the cadet to practice under supervision.

A practical activity was chosen for TP 4 as it is an interactive way to allow the cadets to practice fishing with constructed fishing instruments. This activity contributes to the development of their outdoor survival skills in a fun and challenging setting.

---

**INTRODUCTION**

---

**REVIEW**

N/A.

**OBJECTIVES**

By the end of this lesson the cadet shall have attempted to catch a fish.

## IMPORTANCE

Fishing equipment is a common component in a survival kit. This equipment is used to catch fish in a survival situation. It is important for cadets to learn how to catch fish because fish are a valuable food source, containing protein, vitamins and fats. Knowing when, where and how to catch fish will be a key survival skill in the event a cadet becomes lost.

### Teaching Point 1

### Explain Fishing

Time: 5 min

Method: Interactive Lecture



Some cadets may have experience fishing, allow them to provide their personal experiences.

## WHERE TO FISH

Fish constantly swim in bodies of water and can be found in locations where there is a food source. The location is affected by temperature and time of day.

**Hot Weather.** If it is a hot day and the water is low, fish will usually be found in deeper water where there is shade and it is cooler.

**Cold Weather.** In cold weather, fish choose a shallow area where the sun has warmed the water. Lake fish tend to keep to the edges, which are warmer.

**Rivers.** Fish are found in areas where a tributary feeds the mainstream with less flow, under shelter of banks, below rocks and under submerged logs. If a river is flooding, fish will stay where the water is not rushing – on the outside of a bend.

## WHEN TO FISH

In the summer it is more likely to catch fish in the morning between first light and 1030 hours. They tend to hit better if the water is dead calm and the skies are clear.



**Hit.** Fish bite the bait or strike the bait.

In early spring, fish tend to feed during different hours of the day. As a general rule, leave lines out overnight and check them just before first light, some fish will feed at night during a full moon. If a storm is imminent, fish before it breaks. Fishing is poor in a river after heavy rain.

Signs that fish are feeding, and therefore likely to take the bait, are when they jump out of the water, or there are frequent clear ring ripples breaking out where fish are taking flies off the surface. Lots of little fish darting about may mean larger fish are pursuing.





Arctic Alaska's Kiana Lodge. Retrieved April 11, 2008, from [http://www.alaskasheefishing.com/alaska\\_fishing.htm](http://www.alaskasheefishing.com/alaska_fishing.htm)

Figure 14-8-1 Fish Jumping



Ingram Publishing, by Ingram Publishing. Retrieved April 11, 2008, from <http://www.jupiterimages.com/popup2.aspx?navigationSubType=itemdetails&itemID=22741844>

Figure 14-8-2 Ripples on a Lake

---

## CONFIRMATION OF TEACHING POINT 1

---

### QUESTIONS

- Q1. If it is a hot day where would a person usually find fish?
- Q2. In cold weather where can fish be found in a lake?
- Q3. In the summer when would be the best time to go fishing?

### ANTICIPATED ANSWERS

- A1. If it is a hot day, fish will usually be found in deeper areas where the water is cooler.
- A2. Lake fish tend to keep to the edges which are warmer.
- A3. In the summer it is more likely to catch fish in the morning between first light and 1030 hours.

---

### Teaching Point 2

### Discuss Fishing

Time: 5 min

Method: Interactive Lecture



Discuss with cadets the materials that are required to go fishing and the different types of bait that can be used.

Some cadets may be experienced anglers, have them discuss their experiences and knowledge to encourage class participation during instruction.

### FISHING TACKLE

Fishing tackle is a general term that refers to the equipment used to fish with. The following are some types of tackle required to fish when in a survival situation:

**Hook.** Used to catch a fish, it is often found tied to the end of a fishing line. The hook is swallowed by a fish and impales the body allowing the angler to retrieve the fish.

Some commonly used hooks are skewers and shank hooks (made from bone, wood, or plastic) and safety pin hooks. Large hooks will catch large fish like salmon and pike. Small hooks will catch a range of sizes, but will also be able to catch small fish like perch, bass and trout.



*Welcome to Fishing Reports, Copyright 1996–2006 by Fish Reports.net. Retrieved April 11, 2008, from <http://www.fishreports.net/fishing-gear/images/fishing-hook.jpg>*

Figure 14-8-3 Fishing Hook



**Cast.** To throw out a fishing line into the water.

**Line.** A line is used to cast the hook into the water. When the fish is caught on the hook, the line allows the fisherman to retrieve the fish by pulling in the line. Lines can be made by twisting bark or cloth fibres together.



Although a line can be attached to a single pole it is more efficient to set multiple lines tied to the end of one or several long, straight branches. By sticking these poles into the ground, one can catch fish while attending to other chores.

**Float.** A float is a object that attaches to the fishing line and floats restricting the hook from resting on the bottom of the lake (eg, Styrofoam, plastic bottle, bobber, wood etc). The float should be easily seen from shore and identifies when a fish has taken the bait by bobbing in the water or moving about.

The float should be attached to the line where it will allow the bait to be suspended approximately 30 cm (12 inches) off of the bottom of the lake. The float's position will help control casting and where the line descends.

**Weight.** A weight is used to sink the hook. In a river, the current can cause the hook to float. By adding weights, the hook can trail in a deeper position. Weights can be made from anything heavy in comparison to the line and hook (pebbles, lead, wire, flat washer, nut or bolt).

Small weights between the float and the hook will stop the line from following a current while trailing. To obtain a deeper hook position, extend the line below the hook and attach weights to the end of the line.



*P. Tawrell, Camping and Wilderness Survival: The Ultimate Outdoors Book, Paul Tawrell (p. 16)*

Figure 14-8-4 Weights

## BAIT

Bait is what is used to lure fish to a hook. The bait increases the chances of catching a fish. Bait may be berries that hang over the water or insects that breed in and near the water. Scavenger fish will take pieces of meat, raw fish, ants and other insects. Using bait native to the fishes' water is most likely to be successful. If one type of bait is unsuccessful, change to another.

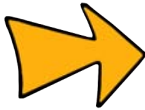

Once you have a catch, examine the stomach contents of the fish and eliminate the guess work as to diet.

**Live.** Worms, maggots, insects and small fish can be used as live bait. Cover the hook completely with the bait. You can place the hook through the meat part of a small fish without killing them, or through the body of a grasshopper. Their distressed movement in the water will attract the fish. Small fish are easy to catch, and can be used as bait to catch bigger fish.



*Discover Entomology, by C.D. Patrick, Grasshoppers and Their Control, Copyright 2008 by Texas A&M University Department of Entomology. Retrieved March 5, 2008, from <http://insects.tamu.edu/extension/bulletins/l-5201.html>*

Figure 14-8-5 Grasshopper



*Cheshire Wildlife Trust, Find Out About Earth Worms, Copyright 2004 by Cheshire Wildlife Trust. Retrieved March 5, 2008, from [http://www.wildlifetrust.org.uk/cheshire/watch\\_earthworms.htm](http://www.wildlifetrust.org.uk/cheshire/watch_earthworms.htm)*

Figure 14-8-6 Earth Worm

**Lures.** A lure is an object attached to the end of the fishing line and designed to resemble and move like prey. The purpose of the lure is to use movement, vibrations, and colour to catch the fish's attention and make them bite the hook. Lures are equipped with one or more single, double, or triple hooks that are used to hook fish when they attack the lure. Fishing with a hook and line is the common way of fishing. Hooks and lines are part of most survival kits. Hooks may also be constructed from wire, pins, bones, wood and even thorns.



*Canadian Tire, Copyright 1997–2008 by Canadian Tire Corporation, Limited. Retrieved April 15, 2008, from <http://www.canadiantire.ca/home.jsp>*

Figure 14-8-7 Fishing Lures

**Berries.** Wild berries that grow around the water's edge may be bait. When the wind blows over hanging trees drop berries into the water and fish will eat them. Baiting the line with the berries may increase the chances of catching a fish.

---

## CONFIRMATION OF TEACHING POINT 2

---

### QUESTIONS

- Q1. What materials can hooks be made from?
- Q2. What are the types of fishing tackle?
- Q3. What are the types of bait available?

## ANTICIPATED ANSWERS

- A1. Hooks can be made from bone, wood, or plastic. (Answers may vary, keep an open mind of the possible solutions when accepting answers to this question.)
- A2. The types of fishing tackle include hooks, line, floats and weights.
- A3. The types of bait are live, lures and berries.

### Teaching Point 3

### Explain, Demonstrate and Have the Cadets Practice Constructing Fishing Instruments

Time: 35 min

Method: Demonstration and Performance



For this TP, it is recommended that instruction take the following format:

1. Explain and demonstrate the complete skill while cadets observe.
2. Explain and demonstrate each step required to complete the skill.
3. Have the cadets practice the skill.

**Note:** Assistant instructors may be employed to monitor the cadets' performance.



Show the cadets how to exactly make and set up each instrument. Be thorough in the examples and demonstrations given. The cadets may experience difficulty making the automatic fishing rod.

## HOOK AND LINE

A person does not require a rod to fish. Using just a hook and line is effective and usually in a survival kit. Initially, people may find that fishing with a hook and line is the most effective for a given water source. This technique is familiar to most people, takes little time and skill. The only disadvantage is that it often requires a sizable length of line or cordage and proper bait. Hooks for this instrument may be made of bone, wood, plastic or any other suitable materials.

**Standard Hook.** This hook is manufactured and fashioned in a factory made of metal and has an eye loop on one end with a sharp barb on the other end as seen in Figure 14-8-9. Tie the fishing line to the hook securely using an improved clinch knot (as illustrated in Figures 14-8-8 and 14-8-9.)



To make a clinch knot complete the following steps:

1. Put the end of the line through the eye of the hook.
2. Twist the short end a round the main part of the line three or four times.
3. Tuck the end of the line back through the start of the twist.
4. Pull tight (practice line may need a little coaxing and nylon a little lubrication).

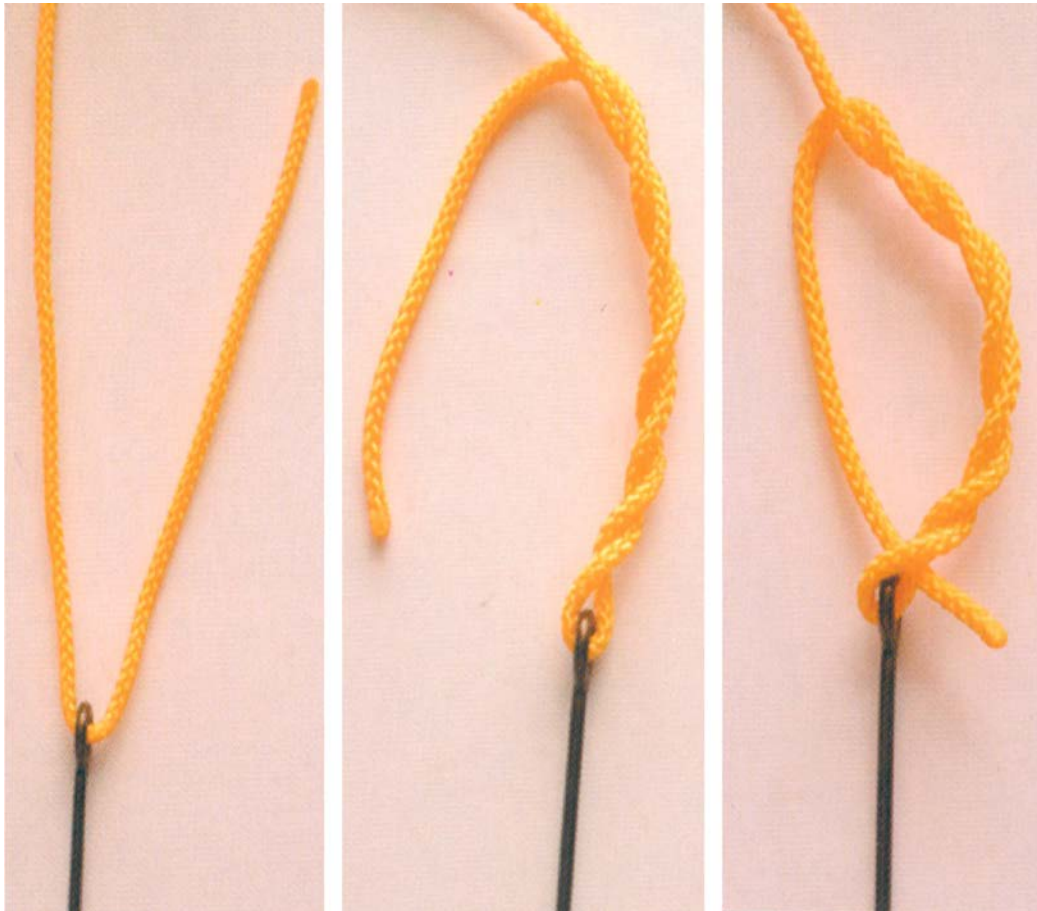

*D. Pawson, Pocket Guide to Knots and Splices, Chartwell Books, Inc. (p.158-159)*

Figure 14-8-8 Clinch Knot Steps 1, 2 and 3





*D. Pawson, Pocket Guide to Knots and Splices, Chartwell Books, Inc. (p.159)*

Figure 14-8-9 Clinch Knot Steps 4 and Finished Knot

**Skewer Hook.** A skewer hook is a sliver of wood or plastic that is notched and tied at the middle. When baited, this hook is turned parallel to the line making it easier for the fish to swallow. Once the fish takes the bait, a simple tug on the line will turn the skewer sideways, lodging it in the fish's mouth.



*Director Cadets 3, 2008, Ottawa, ON: Department of National Defence*

Figure 14-8-10 Skewer Hook

**Shank Hook.** A shank hook is made by carving a piece of wood or plastic until it takes on the shape of a hook that is notched and tied to the line at the top (Figure 14-8-11 depicts a piece of wood that has been carved down to a hook). When the fish swallows the hook, a tug on the line will set it by causing the hook end to lodge in the fish's throat.



*G. Davenport, Wilderness Survival, Stackpole Books (p. 167)*

Figure 14-8-11 Shank Hook

**Safety Pin Hook.** A safety pin can be manipulated to create a hook. Depending on the size of the safety pin, this system can catch fish of various sizes and is a good option.

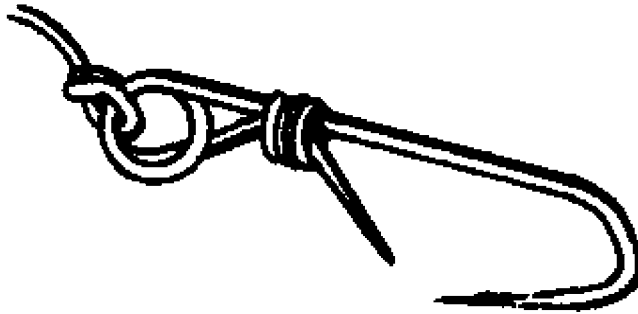

*J. Wiseman, The SAS Survival Handbook, HarperCollins Publishers (p. 225)*

Figure 14-8-12 Safety Pin Hook

## AUTOMATIC FISHING ROD

The automatic fishing rod works similarly to the baited spring snare in EO C324.02 (Construct Snares, Section 7). To construct an automatic fishing rod:

1. **Tying Several Hooks Onto a Line.** Make a hook and line. The line should have many hooks attached to it increasing the chances of a catch.
2. **Locating a Fishing Rod.** The automatic fishing rod requires a flexible tree, bush or branch close to the water's edge that is capable of, when released, pulling on the line hooking the fish.
3. **Setting the Fishing Rod With a Trigger.** The fishing rod will have to be set up to release when a fish eats the bait and attempts to swim away. The movement on the line should activate the spring and hook the fish.

Follow these steps to create a fishing rod with a trigger:

1. Find a small tree or flexible bush or branches close the water's edge that is suitable to lift a fish into the air.
2. Attach a string to the top of the tree or flexible bush or branches that will be used as the spring.
3. Construct a trigger release by:
  - (a) finding a stake you can drive into the ground that will be able to support the weight of the spring;
  - (b) making a notch in the stake (as illustrated in Figure 14-8-13); and
  - (c) finding a similar size piece of wood that will link to the stake as the trigger release, cut a release notch in it (as illustrated in Figure 14-8-13).
4. Make a hook and line. The line should have many hooks attached to it increasing the chances of a catch.



5. Bait the hooks.
6. Attach the hook and line to trigger release A.
7. Cast the hook and line into the water and then tie the string from the tree to trigger release A.
8. Set trigger release A into B and gradually release the tree allowing tension to arm the automatic fishing rod.
9. Wait for a fish to activate the release mechanism.

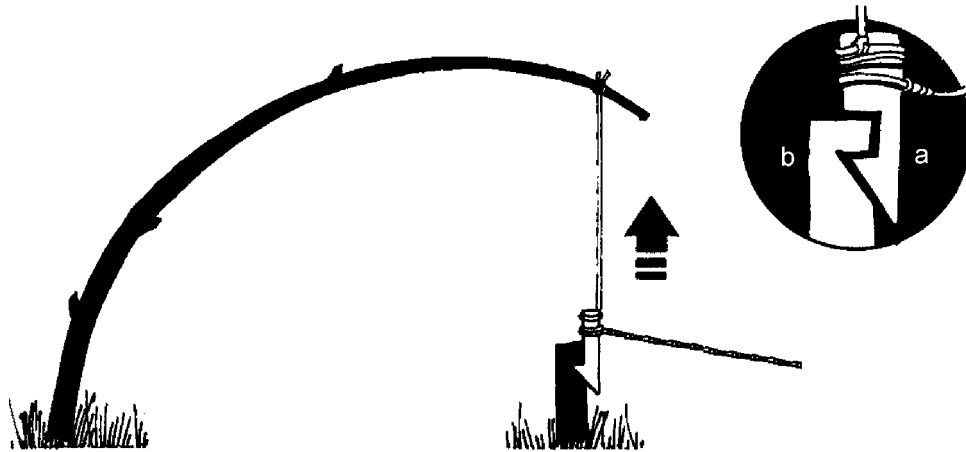

*J. Wiseman, The SAS Survival Handbook, HarperCollins publishers (p. 188)*

Figure 14-8-13 Automatic Fishing Rod

## SPEAR

The spear is the simplest of all fishing instruments to construct, however, the hardest to be successful with. It is a straight green stick or sapling with a sharpened point and barbs (as illustrated in Figure 14-8-14). Spearing a fish is difficult except when the stream is small or the body of water is shallow and the fish are large and numerous as during spawning season or when the fish congregate in pools. Shallow water makes it easier to see fish and spear them.

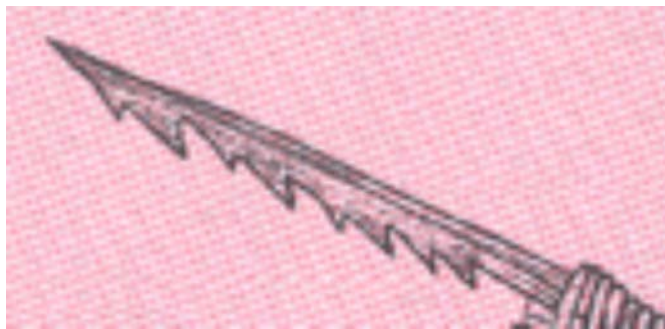

*P. Tawrell, Camping and Wilderness Survival: The Ultimate Outdoors Book, Paul Tawrell (p. 169)*

Figure 14-8-14 Barbed Spear

Follow these steps to make a spear:

1. **Sharpening a Long Stick.**
  - (a) Find or cut a long, straight sapling or stick.
  - (b) Sharpen the end to a point using a knife or the friction of a rock.

- (c) It is also possible to use the 'Y' of a hardwood branch. Cut the branch, sharpen the end and tie to the spear.



Some sticks may still be green and fragile. To make a spear more durable, harden the wood by holding the tip of the spear over an open flame to dry the wood. It is dry once the ends turn brown.

2. **Adding Barbs.** Barbs will stop the fish from sliding off the spear when impaled. To add barbs, on the sharp side cut angled notches into it. The notches will have to be cut in the direction of the sharp point (as illustrated in Figure 14-8-13).
3. **Aiming.** To aim a spear consider the following:
  - Aiming can be tricky as water diffracts light (similar to what a magnifying glass does to the view you see that is distorted) and the fish will not be where it looks like it is. The fish will actually be closer than it appears, so the person will have to aim low.
  - To learn how to judge the fish's position, point the spear at a rock under water and push toward it without throwing the spear into the water.
  - The chances of hitting the rock on the first attempt will be slim but the person will learn the angle which is required to spear the rock.

---

### CONFIRMATION OF TEACHING POINT 3

---

#### QUESTIONS

- Q1. What kind of hooks can you use for a hook and line fishing instrument?
- Q2. How does an automatic fishing rod work?
- Q3. How can you make a spear more durable?

#### ANTICIPATED ANSWERS

- A1. The hooks that can be used on a hook and line fishing instrument are a standard, skewer, shank and a safety pin hook.
- A2. An automatic fishing rod works similarly to the baited spring snare.
- A3. To make a spear more durable harden the wood by holding the tip of the spear over an open flame to dry the wood. It is dry once the ends turn brown.

---

#### Teaching Point 4

#### Have the Cadets Attempt to Catch a Fish Using One Type of Fishing Instrument

Time: 35 min

Method: Practical Activity

---

#### ACTIVITY

---

#### OBJECTIVE

The objective of this activity is to have cadets attempt to catch a fish using one type of fishing instrument.

## RESOURCES

- Fishing line,
- Hooks,
- Safety pin, and
- Knife.

## ACTIVITY LAYOUT

N/A.

## ACTIVITY INSTRUCTIONS

1. Have the cadets select one of the following fishing instruments:
  - (a) hook and line,
  - (b) automatic fishing rod, or
  - (c) a spear.



Cadets who choose to make an automatic fishing rod will be in a group of three to speed construction and save resources.

2. Have the cadets construct a fishing instrument and attempt to catch a fish.
3. Have the cadets who are successful at catching a fish, construct another instrument and attempt to catch another fish.
4. Have the cadets disassemble their fishing instrument.
5. Complete a group discussion about the cadets' experience and what they learned about using constructed fishing instruments.



Cadets are not required to keep the fish they catch. If a fish sustains only minor injuries during the catching process, release the fish back into the water. Catch and release practices will be encouraged.

## SAFETY

Cadets will be close to a body of water. Additional supervision is required to monitor the cadets.

---

### CONFIRMATION OF TEACHING POINT 4

---

The cadets' participation in the activity will serve as the confirmation of this TP.

---

**END OF LESSON CONFIRMATION**

---

The cadets' participation in fishing with constructed fishing instruments will serve as the confirmation of this lesson.

---

**CONCLUSION**

---

**HOMEWORK/READING/PRACTICE**

N/A.

**METHOD OF EVALUATION**

N/A.

**CLOSING STATEMENT**

By learning when, where and how to catch fish cadets can rely on fishing as a means of providing a valuable food source. Fish contain protein, vitamins and fats, the key ingredients for nourishment. This food source will prolong survival while waiting to be rescued.

**INSTRUCTOR NOTES/REMARKS**

Cadets are not required to keep the fish they catch. If a fish sustains only minor injuries during the catching process, release the fish back into the water. Catch and release practices will be encouraged.

---

**REFERENCES**

---

- C2-008 (ISBN 0-00-653140-7) Wiseman, J. (1999). *The SAS Survival Handbook*. Hammersmith, London: HarperCollins Publishers.
- C2-148 (ISBN 978-0-8117-3292-5) Davenport, G. (2006). *Wilderness Survival*. Mechanicsburg, PA: Stackpole Books.



**ROYAL CANADIAN ARMY CADETS**  
**SILVER STAR**  
**INSTRUCTIONAL GUIDE**



**SECTION 9**  
**EO C324.04 – COLLECT EDIBLE PLANTS**

---

Total Time:	120 min
-------------	---------

---

**PREPARATION**

---

**PRE-LESSON INSTRUCTIONS**

Resources needed for the delivery of this lesson are listed in the lesson specification located in A-CR-CCP-703/PG-001, Chapter 4. Specific uses for said resources are identified throughout the instructional guide within the TP for which they are required.

Review the lesson content and become familiar with the material prior to delivering the lesson.

Instructors are recommended to research local flora and provide examples where necessary throughout the lesson.

Conduct a reconnaissance of the surrounding area and collect examples for this lesson.

Locate edible plants in the surrounding area to use as examples for TP 2.

Photocopy Annexes H and I for each cadet.

**PRE-LESSON ASSIGNMENT**

N/A.

**APPROACH**

An interactive lecture was chosen for TPs 1 and 3 to orient cadets to poisonous plants and illustrate the application of rules when identifying poisonous plants.

Demonstration was chosen for TPs 2 as it allows the instructor to explain and demonstrate ways to determine if plants are edible.

A practical activity was chosen for TP 4 as it is an interactive way to allow the cadets to demonstrate identifying edible plants in a safe, controlled environment. This activity contributes to the development of their outdoor survival skills in a fun and challenging setting.

Demonstration and performance was chosen for TP 5 as it allows the instructor to explain and demonstrate how to conduct the universal edibility test while providing an opportunity for the cadets to practice this skill under supervision.

---

## INTRODUCTION

---

**REVIEW**

N/A.

**OBJECTIVES**

By the end of this lesson the cadet shall be expected to collect edible plants.

**IMPORTANCE**

It is important for the cadets to know how to identify and collect edible plants. In a survival situation, plants are an excellent source of nutrition that can be beneficial to nutritional requirements.

**Teaching Point 1****Discuss Ways to Determine if Plants are Edible**

Time: 25 min

Method: Interactive Lecture

In a survival situation, a person should always be on the lookout for familiar wild foods. Even in the most static survival situation, maintaining health through a complete and nutritious diet is essential to maintaining strength and peace of mind.

Nature can provide food that will enable a cadet to survive any ordeal. Cadets should therefore learn as much as possible about the flora of the region where they will be training.



The critical factor in using plants for food is to avoid accidental poisoning. Eat only those plants that can be positively identified and are known to be safe to eat.

**THE BERRY RULE**

In general, the edibility of berries can be classified according to their colour and composition. The berry rule is a general guide to determine whether the edibility test needs to be performed. The only berries that should be eaten without testing are those that can be positively identified as non-poisonous.

The following is the berry rule:

- Green, yellow and white berries are 10 percent edible.
- Red berries are 50 percent edible.
- Purple, blue and black berries are 90 percent edible.
- Aggregate berries (berries that are a collection of units formed into one body) such as thimbleberries, raspberries and blackberries are considered 99 percent edible.

**EDIBLE PARTS OF A PLANT**

Some plants are completely edible, whereas others have both edible and poisonous parts. Plants can be broken down into several distinct components.

**Stems, Roots and Leaves**

Plants that have stems, roots and leaves are probably the most abundant source of edible vegetation in the world. Their high vitamin content makes them a valuable component of our daily diet. Shoots grow like

asparagus and are best when boiled twice (boiled five minutes, drained off and boiled again until done). Some examples of these plants are bracken fern, young bamboo and cattail (as per Figure 14-9-1).

Leaves may be eaten raw or cooked but to achieve the highest nutritional value, they are best eaten raw. The pith, found inside the stem of some plants, has a very high food value. Some examples are sago, rattan, coconut and sugar. Cambium is the inner bark found between the bark and the wood of a tree (as per Figure 14-9-2). It can be eaten raw, cooked, or dried and then pulverized into flour.



*"Cattails", Aquasprings, 2007, Retrieved November 15, 2007, from <http://www.aquaspringsinfo.com/cattails.jpg>*

Figure 14-9-1 Cattail

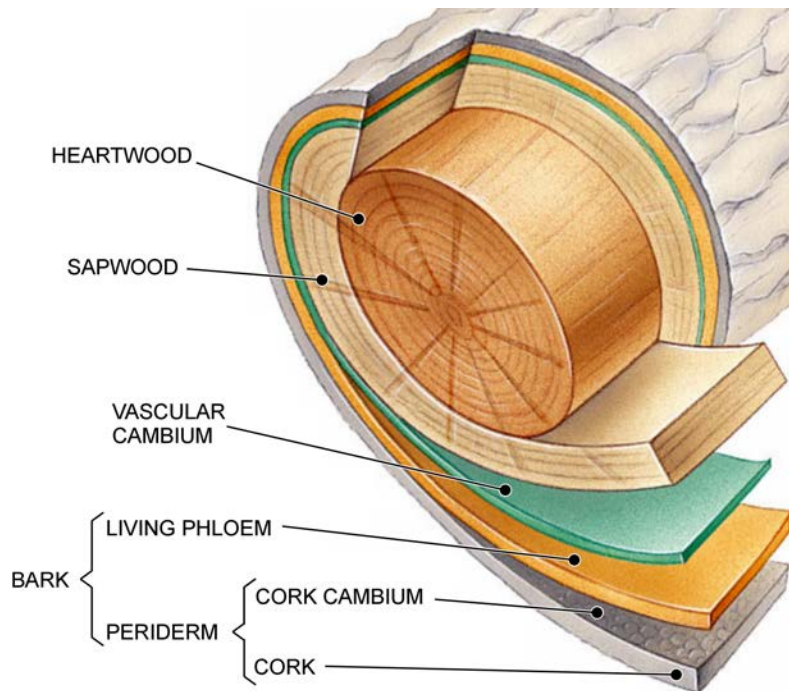

*UIC, Plant Structures and Function: UIC. Retrieved November 15, 2007, from <http://uic.edu/classes/bios/bios100/lectf03am/treetrunk.jpg>*

Figure 14-9-2 Cambium

### Flowers, Buds and Pollen

Flowers, buds and pollens are high in food value and are often eaten raw or in a salad. Some examples include hibiscus (flower), rosehips (buds), and cattail (pollen).





*About .com, Holistic Healing, Copyright 2007 by About, Inc. Retrieved November 15, 2007, from <http://healing.about.com/od/floweressences/ig/Flower-Essence-Gallery/Hibiscus.htm>*

Figure 14-9-3 Hibiscus

### **Fruits (Sweet and Non-Sweet)**

Fruits are the seed-bearing part of the plant and can be found in all areas of the world. They are best eaten raw to retain all of their nutritional value, but may also be cooked. Examples of sweet fruits are apples, prickly pears, saskatoon berries and wild strawberries. Examples of non-sweet fruits include tomatoes, cucumber, plantains and horseradish.

### **Nuts**

Nuts are high in fat and protein and can be found around the world. Most can be eaten raw but some, like acorns, require leaching (soaking in water), with several changes of water, to remove their tannic acid.

### **Seeds and Grains**

The seeds and grains of many plants are a valuable food resource and should not be overlooked. Some examples are grasses and millet, best eaten when ground into flour or roasted. Purple or black grass seeds should not be eaten; they often contain a fungal contamination.

### **Seaweed and Algae**

One plant that should never be overlooked is seaweed. It is a form of marine algae found on or near shores. There are also some edible freshwater varieties. Seaweed is a valuable source of iodine, other minerals, and vitamin C.

When gathering seaweed for food, find living plants attached to rocks or that are floating free. Seaweed washed ashore for any length of time may be spoiled or decayed. Freshly harvested seaweed can be dried for later use.

Preparation for eating depends on the type of seaweed. Thin and tender varieties can be dried in the sun or over a fire until crisp. Crush and add to soups or broths. Boil thick, leathery seaweeds for a short time to soften

them. Eat them as a vegetable or with other foods. Some varieties can be eaten raw after testing for edibility. Some examples are dulse, green seaweed, irish moss, kelp, laver, mojaban, and sugar wrack.

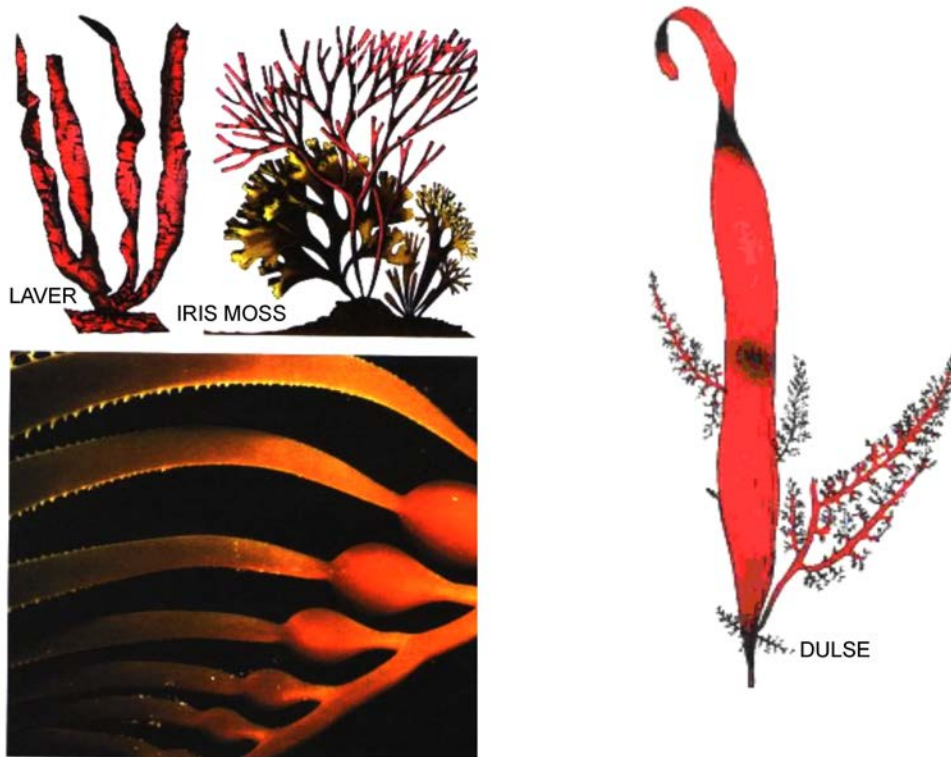

*Wilderness Survival, "Plants", Copyright 2007 Jalic Inc. Retrieved November 15, 2007, from <http://www.wilderness-survival.net/plants-1.php>*

Figure 14-9-4 Seaweed

---

### CONFIRMATION OF TEACHING POINT 1

---

#### QUESTIONS

- Q1. Which berries are 99 percent edible?
- Q2. Which grass seeds should not be eaten?
- Q3. What should you look for when gathering seaweed?

#### ANTICIPATED ANSWERS

- A1. Aggregate berries such as thimbleberries, raspberries and blackberries are 99 percent edible.
- A2. Purple or black seeds should not be eaten.
- A3. Living plants attached to rocks or that are floating free should be looked for when gathering seaweed.

---

**Teaching Point 2****Identify Edible Plants**

Time: 15 min

Method: Demonstration

---



Demonstrate to the cadets where these plants are located and what they look like.

When available, fruits and nuts are one of the survivor's most important foods.

**FRUITS**

**Blackberries/Raspberries.** These berries grow in scrub, woods and on open ground. They have leaves that are toothed and flowers that are white or sometimes pinkish in blackberries. Look for straggly bushes with arching thorny stems and juicy segmented berries, which ripen from green through red to purplish blackberries in late summer. Raspberries are less straggly, have fewer prickles, and ripen to a rich red earlier in the summer. All are edible raw.



*J. Wiseman, The SAS Survival Handbook, HarperCollins Publishers (p. 142)*

Figure 14-9-5 Blackberry

**Wild Strawberries.** Wild strawberries grow on small scrambling plants in dry grassy places and woodland areas. The fruits resemble small cultivated strawberries and are sometimes found underneath the leaves. These fruits are rich in vitamin C and are best eaten fresh.



*J. Wiseman, The SAS Survival Handbook, HarperCollins Publishers (p. 142)*

Figure 14-9-6 Wild Strawberries

**Crab Apples.** Crab apples are short spiny trees found in scrubland and woods. They can be identified by oval, toothed, often downy leaves, usually reddish-brown twigs and white, pink or red flowers. The fruit, often very bitter, looks like cultivated apples. Too many of the yellowish-green, pectin-rich apples will cause diarrhea and are best cooked with other fruits.



*J. Wiseman, The SAS Survival Handbook, HarperCollins Publishers (p. 143)*

Figure 14-9-7 Crab Apples

**Plums.** Plums exist in many varieties, in scrub and woodland, and in virtually all temperate areas. Small scrubs or tress, similar to wild cherries, are larger fruit, downy, blackish-purple, red or yellow in colour. Some are too tart to eat.



*Food Network, Plums, Copyright 2008 by CW Media INC. Retrieved May 2, 2008, from <http://www.foodtv.ca/content/recipes/ContentDetail.aspx?ContentId=2661&Category=Recipes>*

Figure 14-9-8 Plums

**Wild Cherries.** This fruit grows in woodland areas, growing to 24 m (80 feet) tall with small, pale green to reddish leaves, usually shiny-reddish brown bark, and white or pinkish flowers. The fruit is red or black in colour and depending on the kind may taste sour.



*J. Wiseman, The SAS Survival Handbook, HarperCollins Publishers (p. 143)*

Figure 14-9-9 Wild Cherries

**Blueberries.** This berry is abundant on northern moors, bogs, tundra, and sometimes in wooded areas. Bushes vary in size, but all are woody and shrubby with small oval leaves and small globe-shaped flowers varying from white to pink or greenish.





*J. Wiseman, The SAS Survival Handbook, HarperCollins Publishers (p. 144)*

Figure 14-9-10 Blueberry

### **ROOTS, LEAVES AND STEMS**

In spring and summer young shoots are tender and easy to pick. Some can be eaten raw, but many are better cooked. Wash them in clean water, rub off any hairs and boil in a small amount of water so that they cook in the steam. The leaves are very rich in vitamins and minerals. Together with young shoots, they are the survivor's easiest source of food. Most shoots taste better cooked, however avoid overcooking because it destroys the vitamins.

**Dandelion.** This plant grows in many forms almost everywhere. Look for large yellow to orange flower heads or the rosette of deeply-lobed leaves. Eat the young leaves raw, but boil the older ones, changing the water to remove the bitter taste. Boil the roots or roast for coffee. Dandelion juice is rich in vitamins and minerals.



*J. Wiseman, The SAS Survival Handbook, HarperCollins Publishers (p. 132)*

Figure 14-9-11 Dandelions

**Cattail or Reedmace.** This plant is found in and around swamps and marshy areas. Peeled roots can be eaten raw or cooked. They are an excellent survival food as they can be extracted from the ground if it is not frozen. Roots can be dried and ground into flour. Heads, when green, can be cooked and eaten as corn.



*Aquasprings, 2007, Cattails. Retrieved November 15, 2007, from <http://www.aquaspringsinfo.com/cattails.jpg>*

Figure 14-9-12 Cattail

**Reed.** This plant is located in fresh water almost everywhere, growing to 4 m (13 feet) high, with greyish-green leaves and spreading, brownish-purple flower heads on tall canes. When cooked, if the cane is punctured it will exude an edible sugar-rich gum.



*J. Wiseman, The SAS Survival Handbook, HarperCollins Publishers (p. 136)*

Figure 14-9-13 Reed

**Pine.** Found in North America, it has needles that can be chewed. During the spring, the inner bark can be eaten raw or cooked. To cook, cut the bark lengthwise into strips and cook like spaghetti. It can also be dried and ground into flour.



*P. Tawrell, Camping and Wilderness Survival, Paul Tawrell (p. 972)*

Figure 14-9-14 Pine

**Maple.** Found in the forests of North America, its seeds can be eaten after removing the shell. Maple can be dried and stored. Young leaves are rich in sugar and can be eaten raw, or cooked after being cut into spaghetti-like strips. To collect maple sap, cut a “V” into the tree and drill a 5 cm (2 inch) deep hole and insert a spout.



*P. Tawrell, Camping and Wilderness Survival, Paul Tawrell (p. 972)*

Figure 14-9-15 Maple

**Sweet Flag.** Found in wetlands and lakes, this flower, stem and leaves can be eaten raw in the spring.





*P. Tawrell, Camping and Wilderness Survival, Paul Tawrell (p. 975)*

Figure 14-9-16 Sweet Flag

**Willow.** The young leaves of this plant and its inner bark can be eaten raw.



*P. Tawrell, Camping and Wilderness Survival, Paul Tawrell (p. 975)*

Figure 14-9-17 Willow

## NUTS

**Pine Nut.** This nut comes from the familiar cone-bearing pine tree, seen with clusters of slim evergreen needles found in most temperate and northerly areas. Heat matures the pine cone to release the nuts. They are tasty raw, but delicious roasted. Roasted nuts can be stored.



*J. Wiseman, The SAS Survival Handbook, HarperCollins Publishers (p. 146)*

Figure 14-9-18 Pine Nut

**Chestnut.** This nut is found on the tree, ranging from 5–30 m (15–90 feet) high, with large, toothed hairless leaves and bearing catkins. Nuts are borne in globe-shaped, thick prickly green husks. Smash open the husks, peel the nuts, boil and mash to eat.



Do not confuse the chestnut with the horse chestnut which has large palmate leaves, like the fingers on a hand. The horse chestnut is poisonous.



*J. Wiseman, The SAS Survival Handbook, HarperCollins Publishers (p. 146)*

Figure 14-9-19 Chestnuts

**Hazelnut.** This nut is found on tall shrubs of thickets and waste ground. It has toothed–oval–heart– shaped leaves and brownish-yellow catkins. The highly nutritious nuts come in ovoid, leafy, bristly, or hairy husks.



*J. Wiseman, The SAS Survival Handbook, HarperCollins Publishers (p. 146)*

Figure 14-9-20 Hazelnut

---

## CONFIRMATION OF TEACHING POINT 2

---

### QUESTIONS

- Q1. What fruits are edible?
- Q2. What releases nuts (seeds) from a pine cone?
- Q3. What do the blackberry bushes look like?

### ANTICIPATED ANSWERS

- A1. The fruits that are edible are:
- blackberries/raspberries,
  - wild strawberries,
  - crab apples,
  - plums,
  - wild cherries, and
  - blueberries.
- A2. Heat releases the nuts (seeds) from a pine cone.
- A3. Blackberry bushes have leaves that are toothed and flowers of white or sometimes pink in blackberries. Look for straggly bushes with arching thorny stems and juicy segmented berries.

**Teaching Point 3****Identify How People are Poisoned by Plants**

Time: 15 min

Method: Interactive Lecture



Distribute Annexes H and I to the cadets.

**HOW PEOPLE ARE POISONED BY PLANTS**

There are two common poisons in the plant world:

**Hydrocyanic Acid.** It has the taste and smell of bitter almonds or peaches. The most notable example is the cherry laurel.

**Oxalic Acid.** Its salts occur naturally in some plants, for instance, wild rhubarb and wood sorrel. It is recognized by the sharp, dry, stinging or burning sensation when applied to the skin or tongue.

Plants generally poison by:

**Ingestion.** When a person eats a part of a poisonous plant.

**Contact.** When a person makes contact with a poisonous plant that causes any type of skin irritation or dermatitis.



Dermatitis is the inflammation of the skin.

**Absorption and Inhalation.** When a person either absorbs poison through the skin or inhales it into the respiratory system.

**POISONOUS PLANTS****Plants to Avoid**

- |  |  |
|--|--|
| <ul style="list-style-type: none"> <li>plants with a milky sap, unless positively identified as safe (such as dandelion).</li> <li>red plants. The red-streaked stalk of wild rhubarb is edible but its leaf is poisonous. Hemlock has reddish-purple splotches on its stem.</li> <li>fruits which are divided into five segments.</li> <li>bulbs (resembling onion or garlic).</li> <li>carrot like leaves, roots or tubers.</li> <li>bean and pea like appearance.</li> <li>shiny leaves or fine hairs.</li> </ul> | <ul style="list-style-type: none"> <li>grasses and other plants with tiny barbs on their stems and leaves.</li> <li>old or wilted leaves. The leaves of some trees and plants develop deadly hydrocyanic acid when they wilt – including blackberry, raspberry, cherry, peach and plum. All may be safely eaten when young, fresh and dry.</li> <li>all mushrooms. Mushroom identification is very difficult and must be precise, even more so than with other plants. Two types of mushroom poisoning are gastrointestinal and central nervous system.</li> </ul> |
|--|--|

### Plants Which Cause Dermatitis

The following plants cause dermatitis:

- poison ivy,
- poison oak, and
- poison sumac.

### Plants Which Cause Ingestion Poisoning

The following plants cause ingestion poisoning:

- castor bean,
- death camas,
- oleander,
- poison and water hemlock,
- skunk cabbage, and
- stinging nettle.

## CONFIRMATION OF TEACHING POINT 3

### QUESTIONS

- Q1. What are the names of two fairly common poisons in the plant world?
- Q2. What colour plant should be avoided?
- Q3. Name three plants which cause dermatitis.

### ANTICIPATED ANSWERS

- A1. Two names of fairly common poisons in the plant world are hydrocyanic acid and oxalic acid.
- A2. Red plants should be avoided.
- A3. Three plants that cause dermatitis are poison ivy, poison oak and poison sumac.

### Teaching Point 4

**Conduct an Activity Where the Cadets, in Pairs, Will Search and Collect Two Types of Edible Plants Within the Local Area**

Time: 30 min

Method: Practical Activity

### ACTIVITY



If poison ivy or other poisonous plants are known to be in the search area, ensure the area is kept off limits to the cadets.

## OBJECTIVE

The objective of this activity is to have the cadets collect two types of edible plants.

## RESOURCES

Gloves.

## ACTIVITY LAYOUT

N/A.

## ACTIVITY INSTRUCTIONS

1. Divide the cadets into pairs and distribute a pair of gloves to each cadet.
2. Have the cadets search for edible plants.
3. Gather cadets into a group and have them present their plants to the group.
4. Have the group confirm if the plant presented is edible and why.
5. Supervise and give feedback on the cadets' findings.

## SAFETY

- Cadets should wear gloves when collecting plants. This will avoid any accidental contact with poisonous plants.
- Ensure the cadets do not eat any of their findings until they have been inspected by the instructor.

---

### CONFIRMATION OF TEACHING POINT 4

---

The cadets' participation in the activity will serve as the confirmation of this TP.

---

#### Teaching Point 5

#### Demonstrate and Have the Cadet Perform the Universal Edibility Test

Time: 25 min

Method: Demonstration and Performance

---



Always adopt the following procedure when trying potential food sources. NEVER take short cuts and complete the whole test. If in any doubt, do NOT eat the plant.

## UNIVERSAL EDIBILITY TEST

The universal edibility test is a method a person can use when it is unknown if a plant is safe to eat. This test is not a guarantee that the plant will be safe; however, it will provide some certainty of the plant's edibility. To conduct the test, follow this sequence:

1. **Inspect.** Separate the plant into its basic sections (leaves, stems, roots and flowers). Inspect each section one at a time. Ensure that the plant is not slimy or worm-eaten. Some plants, when old, change their chemical content and become toxic.
2. **Smell.** Crush a small portion. Smell the plant for strong or acid odours. If it smells of bitter almonds or peaches DISCARD.

3. **Rub the Plant on the Skin.** Rub slightly or squeeze some of the juice onto a tender part of the body (under the arm between the armpit and the elbow, for instance). If any discomfort, rash or swelling is experienced DISCARD and reject for future use. Wait 15 minutes and if there is not a reaction, continue.
4. **Place the Plant on the Lips, Mouth and Tongue.** If there is no irritation to the skin proceed with the following steps, going on to the next step after waiting three minutes if there is not an unpleasant reaction:
  - (a) Place a small portion on the lips.
  - (b) Place a small portion in the corner of the mouth.
  - (c) Place a small portion on the tip of the tongue.
  - (d) Place a small portion under the tongue.
  - (e) Chew a small portion.

In all cases, if any discomfort is felt, such as soreness to the throat, irritation, stinging or burning sensations discard.

1. **Swallow.** Swallow a small amount and wait eight hours. During this period do not eat or drink anything else.
2. **Eat.** If there is no reaction, such as soreness to the mouth, repeated belching, nausea, sickness, stomach pains, griping pains in the lower abdomen or any other distressing symptoms, the plant may be considered safe. Eat a larger portion and wait eight hours again.

---

## ACTIVITY

Time: 15 min

---

### OBJECTIVE

The objective of this activity is to have the cadets perform the universal edibility test.

### RESOURCES

- Local vegetation plants,
- Lemons,
- Celery stalks,
- Onions,
- Berries (in season), and
- Spinach leaves.

### ACTIVITY LAYOUT

N/A.

## ACTIVITY INSTRUCTIONS



The cadets do not have to wait the eight hours before being able to eat again for this TP.

Ensure the cadets follow the format for testing for poison. Have the cadets:

1. take a piece of fruit or vegetable;
2. inspect the fruit or vegetable;
3. smell the fruit or vegetable;
4. rub the fruit or vegetable on their arm or underside of the wrist;
5. place a small portion of the fruit or vegetable on their lips;
6. place a small portion of the fruit or vegetable in the corner of their mouths;
7. place a small portion of the fruit or vegetable on the tip of their tongue;
8. place a small portion of the fruit or vegetable under their tongue;
9. chew a small portion of the fruit or vegetable;
10. choose another piece of fruit or vegetable; and
11. repeat Steps 1. to 10. until all have had a chance to try at least three different textures and tastes.

## SAFETY

Ensure the cadets do not share the fruits and vegetables being used in the activity.

---

### CONFIRMATION OF TEACHING POINT 5

---

The cadets' participation in the activity will serve as the confirmation of this TP.

---

### END OF LESSON CONFIRMATION

---

The cadets' participation in the collecting of edible plants and completing the universal edibility test will serve as the confirmation of this lesson.

---

### CONCLUSION

---

## HOMEWORK/READING/PRACTICE

N/A.

## METHOD OF EVALUATION

N/A.



**CLOSING STATEMENT**

It is important for the cadets to know how to perform the universal edibility test, identify both poisonous and non-poisonous plants and be able to collect plants in a survival situation. Plants are an excellent source of nutrition when animals are not abundant. Many plants have health benefits which are also important in a survival situation.

**INSTRUCTOR NOTES/REMARKS**

Instructors will research any plants they anticipate to use for a test. Ensure the plants have no known poisons or toxins.

---

**REFERENCES**

---

- C0-111 (ISBN 0-9740820-2-3) Tawrell, P. (2006). *Camping and Wilderness Survival: The Ultimate Outdoors Book*. Lebanon, NH: Paul Tawrell.
- C2-008 (ISBN 0-00-653140-7) Wiseman, J. (1999). *The SAS Survival Handbook*. Hammersmith, London: HarperCollins Publishers.
- C2-155 (ISBN 978-1-58574-556-2) The Lyons Press. (2002). *U.S. Army Survival Handbook*. Guilford, CT: The Lyons Press.

THIS PAGE INTENTIONALLY LEFT BLANK



**ROYAL CANADIAN ARMY CADETS**  
**SILVER STAR**  
**INSTRUCTIONAL GUIDE**



**SECTION 10**

**EO C324.05 – PREPARE A MEAL FROM FIELD FOOD SOURCES**

---

Total Time: 90 min

---

**PREPARATION**

---

**PRE-LESSON INSTRUCTIONS**

Resources needed for the delivery of this lesson are listed in the lesson specification located in A-CR-CCP-703/PG-001, Chapter 4. Specific uses for said resources are identified throughout the instructional guide within the TP for which they are required.

Review the lesson content and become familiar with the material prior to delivering the lesson.

Photocopy Annex J for each cadet.

Prepare all resources for TPs 2 and 3.

Choose a cooking method and set up area for TP 3.

Cadets who feel uncomfortable observing the skinning of a small animal do not have to attend that portion of the class but should be present for the TP on preparing a fish.

Only one rabbit should be caught or purchased and skinned for demonstration purposes. Check provincial regulations on catching and killing small animals.

Parents shall be made aware of the training and when it will take place.

Instructors will have to use purchased or caught fish. Fish will have to be properly stored in a cool area (cooler with ice) to ensure they do not spoil.

**PRE-LESSON ASSIGNMENT**

N/A.

**APPROACH**

A demonstration was chosen for TP 1 as it allows the instructor to explain and demonstrate skinning a small animal.

A demonstration and performance was chosen for TP 2 as it allows the instructor to explain and demonstrate preparing and cooking a small animal or fish in the field while providing an opportunity for the cadet to practice under supervision.

A practical activity was chosen for TP 3 as it is an interactive way to allow the cadet to experience cooking a small animal or fish. This activity contributes to the development of survival skills in a fun and challenging setting under supervision.

---

## INTRODUCTION

---

### REVIEW

N/A.

### OBJECTIVES

By the end of this lesson the cadet shall have prepared a meal from field food sources.

### IMPORTANCE

It is important for cadets to prepare a meal from field food sources because in a survival situation, cadets may be required to prepare and cook fresh food that they have caught. Having the confidence and ability to cook food, will help a cadet maintain nutrition and energy when in a survival situation.

---

### Teaching Point 1

### Explain and Demonstrate Skinning a Small Animal

Time: 25 min

Method: Demonstration

---



For this TP, it is recommended that instructor explain and demonstrate each step required to complete the skill.

It is required that the instructor have experience skinning an animal prior to this lesson.

It is important to know how to prepare fish and game for cooking in a survival situation. Improper cleaning or storing can result in inedible fish or game, as well as creating a health hazard.

### SKINNING A SMALL ANIMAL

Once a small animal has been caught there are some important steps that have to be completed to prepare the animal prior to eating.



The process of skinning most small animals does not vary much. A rabbit will be used in this lesson for the demonstration.

**Step 1 – Bleeding the Animal.** Upon catching a rabbit, bleed the rabbit by cutting its throat. If possible, clean the carcass near a stream but downstream from your water source and at a minimum of 100 m from the campsite.



*RiverCottage.net, How to Skin a Rabbit. Retrieved April 15, 2008, from <http://forum.rivercottage.net/viewtopic.php?t=12605>*

Figure 14-10-1 Skinning a Small Animal – Step 2

**Step 2 – Preparing Materials.** Lay the rabbit on a flat surface and gather required materials (knife or small hatchet and water) (as per Figure 14-10-1).



*RiverCottage.net, How to Skin a Rabbit. Retrieved April 15, 2008, from <http://forum.rivercottage.net/viewtopic.php?t=12605>*

Figure 14-10-2 Skinning a Small Animal – Step 3

**Step 3 – Removing Legs.** Remove each leg at the joint with a clean cut.



*RiverCottage.net, How to Skin a Rabbit. Retrieved April 15, 2008, from <http://forum.rivercottage.net/viewtopic.php?t=12605>*

Figure 14-10-3 Skinning a Small Animal – Step 4

**Step 4 – Removing the Skin.** Lay the rabbit on its back on a flat surface and pinch the skin at the loose part of the lower belly. Cut a hole in the skin with the knife and cut all the way to just below the front legs. Be careful not to puncture the stomach lining.



*RiverCottage.net, How to Skin a Rabbit. Retrieved April 15, 2008, from <http://forum.rivercottage.net/viewtopic.php?t=12605>*

Figure 14-10-4 Skinning a Small Animal – Step 5

**Step 5 – Separating the Skin.** Separate the muscle covering the gut from the skin starting at the opening, (it comes away quite easily) and continue around to the back.



*RiverCottage.net, How to Skin a Rabbit. Retrieved April 15, 2008, from <http://forum.rivercottage.net/viewtopic.php?t=12605>*

Figure 14-10-5 Skinning a Small Animal – Step 6

**Step 6 – Removing Skin From the Hind Legs.** Pull the skin over the back legs as if taking off a sock.





*RiverCottage.net, How to Skin a Rabbit. Retrieved April 15, 2008, from <http://forum.rivercottage.net/viewtopic.php?t=12605>*

Figure 14-10-6 Skinning a Small Animal – Step 7

**Step 7 – Removing Skin From the Front Legs.** Pull the skin forwards and ease out each front leg in turn.



*RiverCottage.net, How to Skin a Rabbit. Retrieved April 15, 2008, from <http://forum.rivercottage.net/viewtopic.php?t=12605>*

Figure 14-10-7 Skinning a Small Animal – Step 8

**Step 8 – Exposing the Neck.** Pull the skin forward exposing the neck.



*RiverCottage.net, How to Skin a Rabbit. Retrieved April 15, 2008, from <http://forum.rivercottage.net/viewtopic.php?t=12605>*

Figure 14-10-8 Skinning a Small Animal – Step 9

**Step 9 – Removing the Head and Remaining Skin.** Sever the head and remove any remaining skin.



*RiverCottage.Net, How to Skin a Rabbit. Retrieved April 15, 2008, from <http://forum.rivercottage.net/viewtopic.php?t=12605>*

Figure 14-10-9 Skinning a Small Animal – Step 10

**Step 10 – Removing Entrails and Glands.** Make a cut using a knife along the rabbit's belly through the rib cage and pelvis. Open the sides of the belly and grasp the windpipe below the severed neck and pull it out. Clean the rabbit's chest cavity thoroughly by rinsing it with water. Be sure to pay special attention to areas like the chest cavity and folds in the skin.



Dig a hole and bury all discarded animal parts to avoid attracting scavenging animals.

---

### CONFIRMATION OF TEACHING POINT 1

---

#### QUESTIONS

Q1. What position should the animal be placed in when preparing to skin it?



- Q2. What area of the animal's body is first cut?  
 Q3. What is the last step in skinning an animal?

### ANTICIPATED ANSWERS

- A1. The animal should be laid out flat.  
 A2. The first part that should be cut is the neck to bleed the animal.  
 A3. The last step in skinning the animal is cleaning the small animal and rinsing the chest cavity thoroughly by rinsing with water.

---

### Teaching Point 2

### Explain, Demonstrate and Have the Cadet Prepare a Fish

Time: 25 min

Method: Demonstration and Performance

---



For this TP, it is recommended that instruction take the following format:

1. Explain and demonstrate each step required to complete the skill one at a time.
2. Monitor cadets as they imitate each step.

Background information has been provided to support the demonstration and performance. Assistant instructors may be employed to monitor the cadets' performance.

---

### BACKGROUND INFORMATION

---

#### PREPARING A FISH

All freshwater fish are edible. Those under 5 cm (2 inches) long need no preparation and can be eaten whole. Larger fish must be gutted. To prevent spoilage, prepare the fish as soon as possible. The innards can be used as bait or buried in the ground, as the odour will attract insects and scavengers.

It may be some time from when the fish is caught to when it is cooked. Keep the fish cool, out of the sunlight, and away from insects. Cover in forest moss or place in a pool of cool water.



Different types of fish may require different methods of preparing. Determine the common local fish and describe the cleaning method for that type of fish.

**Bleeding.** As soon as a fish is caught, cut its throat and allow it to bleed. Wipe the slime off the fish to make it less slippery. Do not let any slime get in your eyes. Cut out the gills.

**Gutting.** Make an incision from the anal orifice to where the throat was cut. Remove the entrails – you can use them for hook bait. Keep the roe (fish eggs); it is very nutritious.

**Scaling.** Scaling is not necessary and fish can be cooked with scales on, but if there is time, scrape them off. Remove scales by holding the tail and pushing a dull knife across the skin at a 45-degree angle. Draw the knife from tail to head.

**Filleting.** Filleting is one way of preparing a fish. Pass the knife along the top side of the backbone. Cut behind the fin down to the backbone. Push the knife through and cut the fillet free from the tail. Cut the flesh away from the bones. Remove the fillet by cutting the skin at the stomach area.

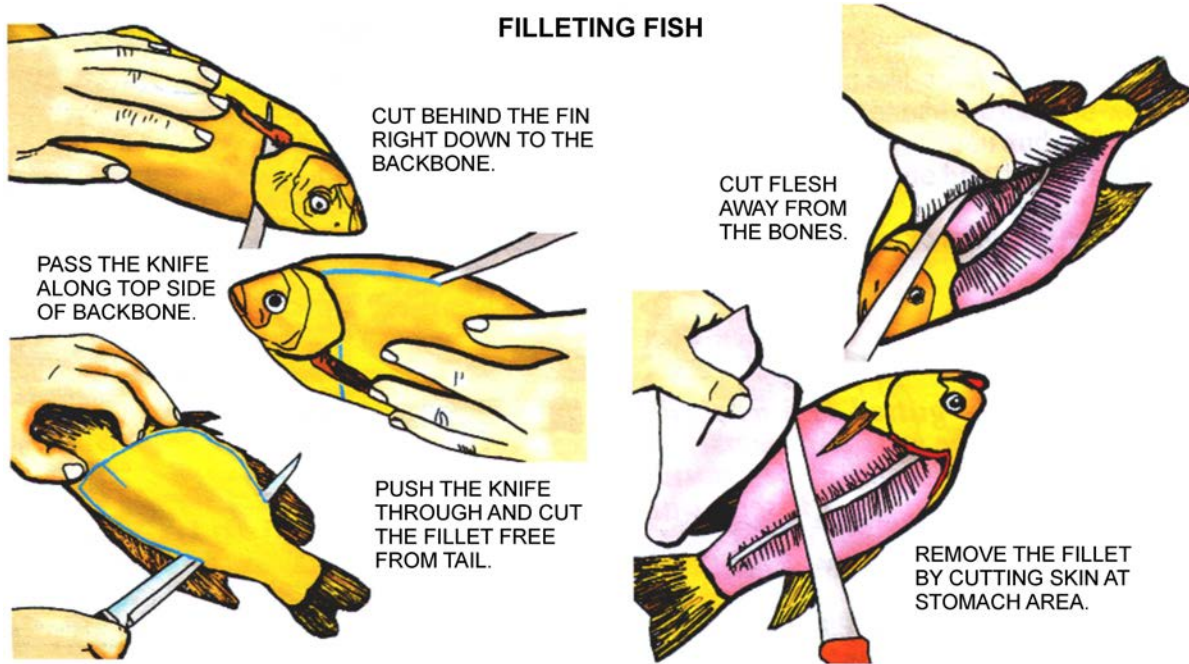

*P. Tawrell, Camping and Wilderness Survival, Paul Tawrell (p. 144)*

Figure 14-10-10 Filleting a Fish

---

## ACTIVITY

---

### OBJECTIVE

The objective of this activity is to have cadets prepare a fish.

### RESOURCES

- Fish, and
- Knife.

### ACTIVITY LAYOUT

Have cadets prepare an open area with a clean table or flat surface to prepare fish.

### ACTIVITY INSTRUCTIONS

Cadets will prepare a fish as each step is demonstrated by the instructor.

### SAFETY

Cadets shall be reminded to always cut away from their body.

---

## CONFIRMATION OF TEACHING POINT 2

---

The cadets' participation in the activity will serve as the confirmation of this TP.

**Teaching Point 3****Explain and Demonstrate Cooking a Small Animal and Have the Cadet Practice Cooking a Fish**

Time: 30 min

Method: Practical Activity



This lesson incorporates material covered in EO C224.01 (Cook in the Field, A-CR-CCP-702/PF-001, Chapter 14, Section 7). Background information has been provided in this lesson as the possibility exists that some cadets may have not participated in the complementary training.

Distribute the handout located at Annex J to each cadet.

The instructor will give a demonstration of one cooking method. The method chosen should already be set up and lit. Demonstrate how to cook the fish.

Concurrently cook the rabbit, while the cadets cook their fish. Instructors may choose to use a different method than the cadets.

**COOKING**

Cooking food can make it more palatable and kills parasites and bacteria. However, when food is heated it loses nutritional value – the more the heat, the greater the loss – so nothing should be cooked longer than necessary. The methods chosen for cooking a small animal or fish simulate the ways that can be used in a survival situation.



All of the methods listed require prior preparation of the food being cooked. This involves peeling/skinning, cleaning and wrapping. When cooking in the field, food must be properly prepared.

**BACKGROUND KNOWLEDGE**

Cooking in the field is an important skill for people who find themselves in a survival situation. Since the human body needs nutrients and energy, cooking is essential to kill harmful bacteria. There are many different ways to cook in the field.

**BAKING**

The best way to bake in the field is in the ground. When food is buried, it will cook faster. To do this:

1. Dig a shallow pit in the ground.
2. Line the pit with rocks.
3. Burn a small fire to get a bed of coals.
4. Place a layer of wet grass on the embers when there are no more open flames and only hot, red embers remaining (if the grass is dry, use water).
5. Place the food (already prepared to be cooked) on top of the wet grass.
6. Use a stick to move around the hot coals to get them as close to the food as possible. Try to put some coals on top of the food.

7. Cover the food with the earth that was dug from the pit.

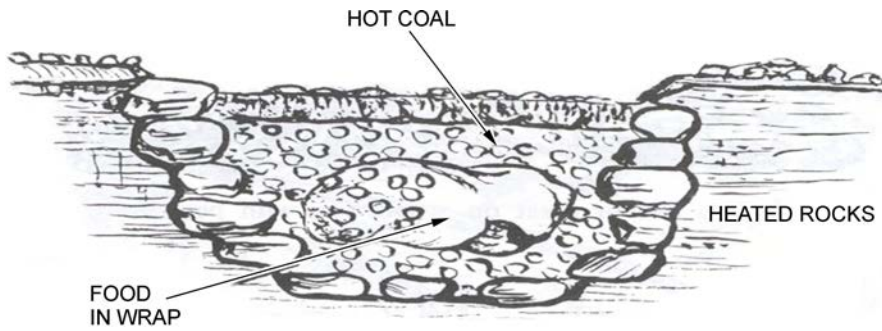

*Department of National Defence, Down But Not Out, Department of National Defence (p.130)*

Figure 14-10-11 Baking in the Ground



When using this method, it is very difficult to check and see if the food is cooked. Cooking time will vary, depending on what is being cooked. Ensure food is completely cooked before consuming. Place it back in the ground and allow more time if unsure.

## ROASTING

Roasting is an easy method that produces tasty results. Unfortunately, it also produces a lot of grease when cooking meat. To minimize waste, place a pot or container under the roasting food to catch grease. Place the object being cooked on the end of a stick, beside an open fire. The food should not be placed directly over the fire and direct contact with smoke and flame should be avoided as much as possible.

The food will need to be rotated or turned to ensure it is cooked throughout. If hanging the food from above the fire, a rotor, made with plastic or heavy paper, can be attached (as per Figure 14-10-13). The rotor will catch and turn in the wind, turning the food.

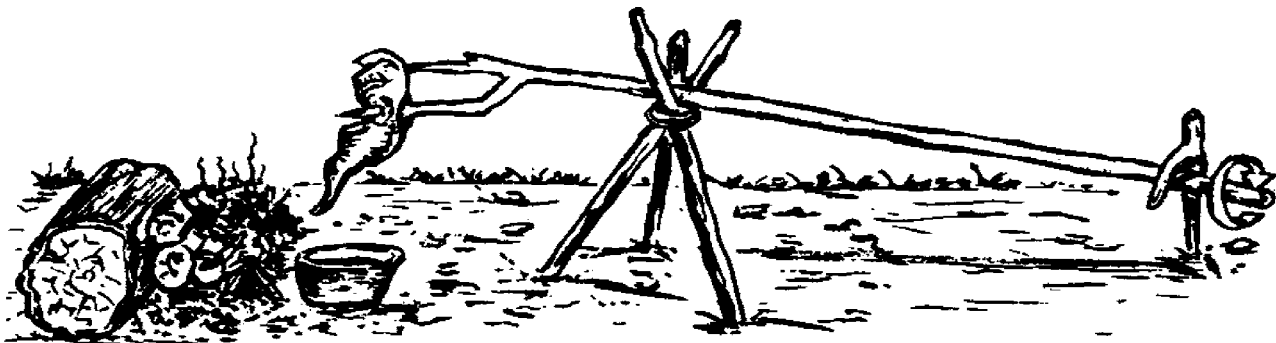

*Department of National Defence, Down But Not Out, Department of National Defence (p.129)*

Figure 14-10-12 Roasting

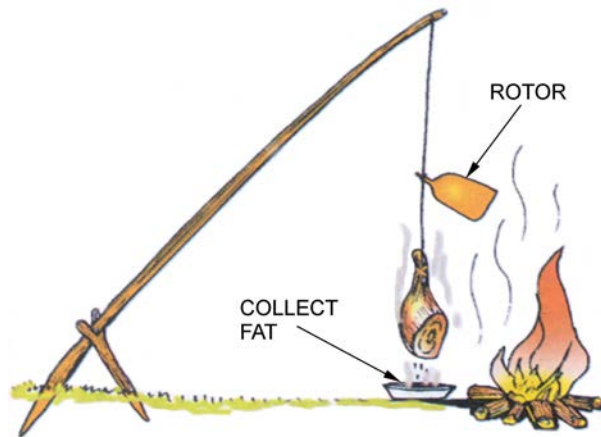

*P. Tawrell, Camping and Wilderness Survival, Paul Tawrell (p. 442)*

Figure 14-10-13 Roasting With a Rotor

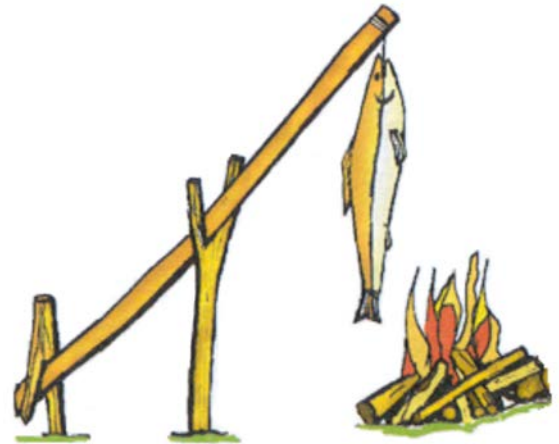

*P. Tawrell, Camping and Wilderness Survival, Paul Tawrell (p. 448)*

Figure 14-10-14 Roasting Fish

## BOILING

Boiling in a pot can be done over an open fire, the same as on a stove. When boiling in a pot, ensure the pot is sitting straight up on the fire. This can be done by using a grill, wedging it between two pieces of thick wood or placing rocks around to stabilize it. There are many ways to place a pot over a fire using wood (as per Figures 14-10-15 and 14-10-16). It is important to ensure the pot is stable and does not have a risk of falling into the fire.



Seeing bubbles is an easy way to tell that water is boiling.



Boiling over an open fire will normally cause soot to form on the outside of the pot. A coating of soapy water on the outside of the pot will make cleaning much easier.

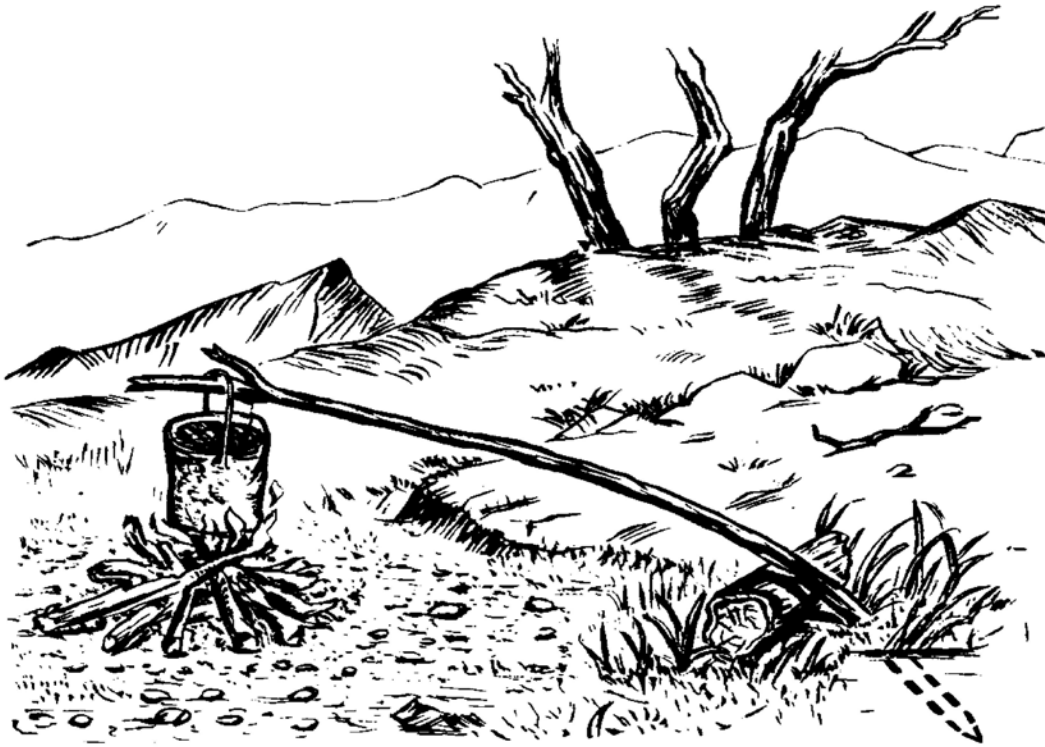

*Department of National Defence, Down But Not Out, Department of National Defence (p.128)*

Figure 14-10-15 Boiling

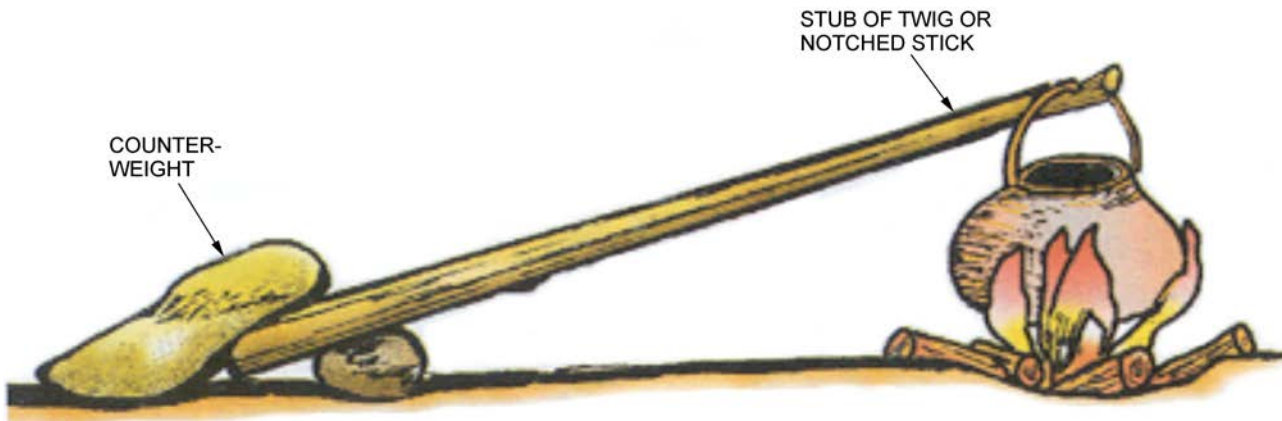

*P. Tawrell, Camping and Wilderness Survival, Paul Tawrell (p. 442)*

Figure 14-10-16 Boiling Using a Counterweight



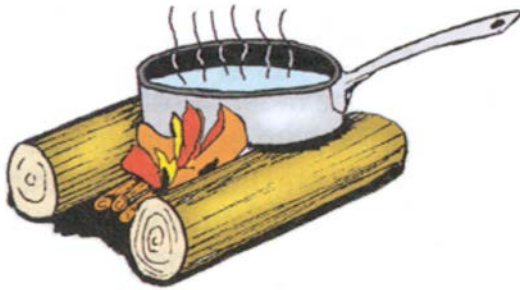

*P. Tawrell, Camping and Wilderness Survival, Paul Tawrell (p. 444)*

Figure 14-10-17 Boiling on an Open Flame With Wood



*P. Tawrell, Camping and Wilderness Survival, Paul Tawrell (p. 442)*

Figure 14-10-18 Boiling on an Open Flame With Rocks

### FRYING

Food can be easily fried on a rock or sheet of metal. A rock will hold a lot of heat for a very long time. When using this method to cook, food may easily stick if there is not a sufficient amount of grease.

STONE  
GRIDDLE

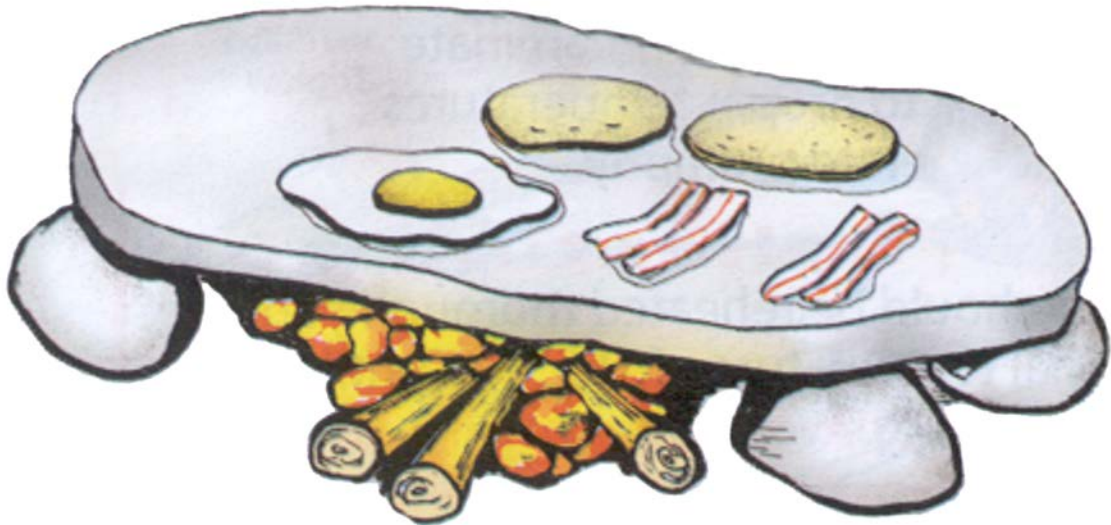

*P. Tawrell, Camping and Wilderness Survival, Paul Tawrell (p. 442)*

Figure 14-10-19 Frying on a Flat Rock

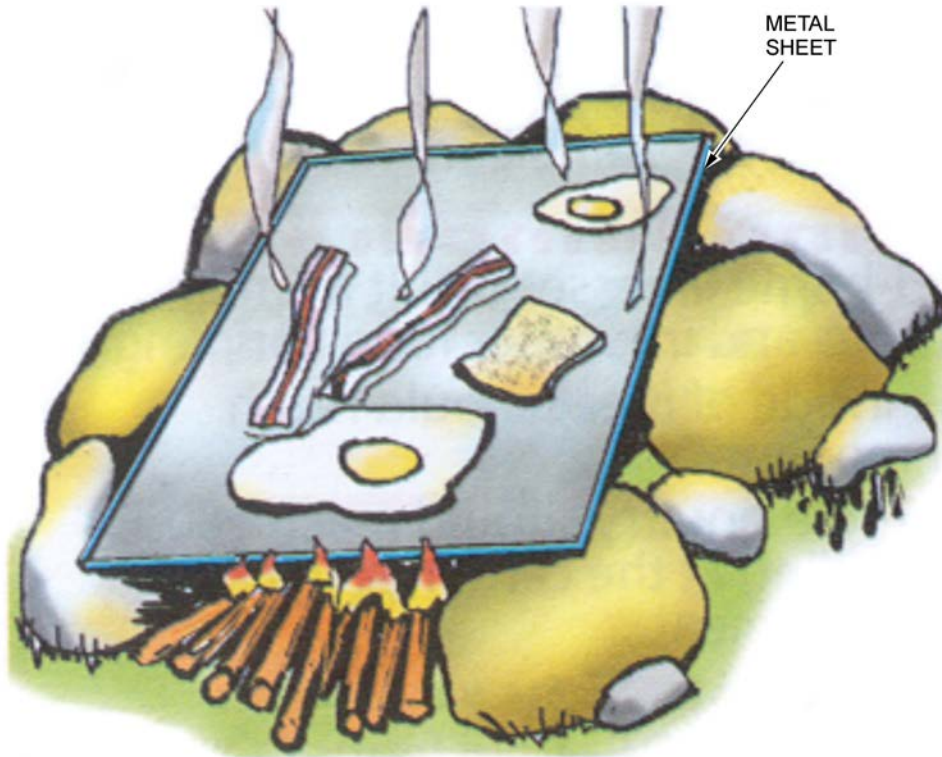

*P. Tawrell, Camping and Wilderness Survival, Paul Tawrell (p. 442)*

Figure 14-10-20 Frying With a Metal Sheet

---

### ACTIVITY

Time: 20 min

---

#### OBJECTIVE

The objective of this activity is to have the cadet cook fish using one of the following methods chosen by the instructor:

- baking,
- roasting,
- boiling, or
- frying.

#### RESOURCES

- Water,
- Fish prepared in TP 2,
- Matches, and
- Shovels.



**ACTIVITY LAYOUT**

An open area that is suitable for lighting small fires should be used for the cadets to cook food.

**ACTIVITY INSTRUCTIONS**

1. Divide the cadets into pairs.
2. Distribute a fish (use the prepared fish from TP2) to each cadet.
3. Have the cadets prepare the assigned method to cook their fish.
4. Have the cadets carry out preparing a heat source and cooking food.
5. Have the cadets sample cooked food, with approval from supervising staff.
6. Have the cadets ensure the fire is out when finished and no hot embers remain.

**SAFETY**

- Cadets will be lighting fires. Review fire orders and procedures.
- Fire safety equipment must be on hand.
- Additional supervision will have to be present during this lesson.
- In the event of an out of control fire contact emergency fire services.

---

**CONFIRMATION OF TEACHING POINT 3**

---

The cadets' participation in the activity will serve as the confirmation of this TP.

---



---

**END OF LESSON CONFIRMATION**

---

The cadets' participation in cooking a fish will serve as the confirmation of this lesson.

---



---

**CONCLUSION**

---

**HOMEWORK/READING/PRACTICE**

N/A.

**METHOD OF EVALUATION**

N/A.

**CLOSING STATEMENT**

Knowing how to cook in the field is a great skill to have when lost. Knowing the many different ways to cook in the field could mean in a person making it through a survival situation. Being able to use different methods of cooking in the field is also a fun way to cook food when on a weekend bivouac FTX.

**INSTRUCTOR NOTES/REMARKS**

Cadets who feel uncomfortable observing the skinning of a small animal do not have to attend that portion of the class but should be present for the TP on preparing a fish.

Only one rabbit should be caught or purchased and skinned for demonstration purposes. Check provincial regulations on catching and killing small animals.

Parents shall be made aware of the training and when it will take place.

---

### REFERENCES

---

- C0-111 (ISBN 0-9740820-2-3) Tawrell, P. (2006). *Camping and Wilderness Survival: The Ultimate Outdoors Book* (2<sup>nd</sup> ed.). Lebanon, NH: Paul Tawrell.
- C2-004 (ISBN 1-896713-00-9) Tawrell, P. (1996). *Camping and Wilderness Survival: The Ultimate Outdoors Book*. Green Valley, ON: Paul Tawrell.
- C2-008 (ISBN 0-00-653140-7) Wiseman, J. (1999). *The SAS Survival Handbook*. Hammersmith, London: HarperCollins Publishers.

## BOW AND DRILL

Construct and use a bow and drill using the following steps:

1. Cut a groove into the bearing block or socket 3–5 cm deep for the hardwood shaft to fit.
2. Cut a groove into the softwood base in which the hardwood shaft will spin.
3. Carve one end of the hardwood shaft into a small point.
4. Collect kindling, tinder and fuel as required.
5. Place tinder into the opening of the softwood base for the embers to fall onto.
6. Wrap the bow around the hardwood shaft and place into the groove on the softwood base.
7. Gather kindling and fuel as required.
8. Place the bearing block on the top of the shaft.
9. Saw the bow back and forth so the hardwood shaft spins.
10. Maintain a constant motion back and forth.
11. Increase speed and look for embers, once smoke appears.
12. Stop and lightly blow on the tinder to start combustion, once the tinder begins to smoke.
13. Apply gathered kindling and fuel as required, when the tinder ignites.

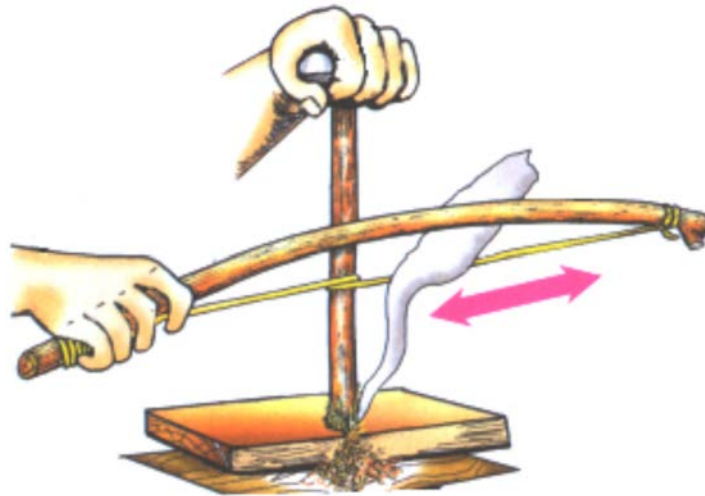

*P. Tawrell, Camping and Wilderness Survival: The Ultimate Outdoors Book (2<sup>nd</sup> ed.), Paul Tawrell (p. 434)*

Figure 14A-1 Fire Bow and Drill

THIS PAGE INTENTIONALLY LEFT BLANK

## FIRE SAW

Construct and use a fire saw using the following steps:

1. On the inside of the fireboard, pick and splinter stringy fibres in order for them to catch a spark.
2. On the outside opposite to the direction of the fibres, cut a narrow groove in which the sawing will be done.
3. Rub the rub stick in a sawing motion in the groove of the fireboard until sparks appear.
4. Collect kindling, tinder and fuel as required.
5. Stop and lightly blow on the tinder to start combustion, once the tinder begins to smoke.
6. Apply gathered kindling and fuel as required, when the tinder ignites.

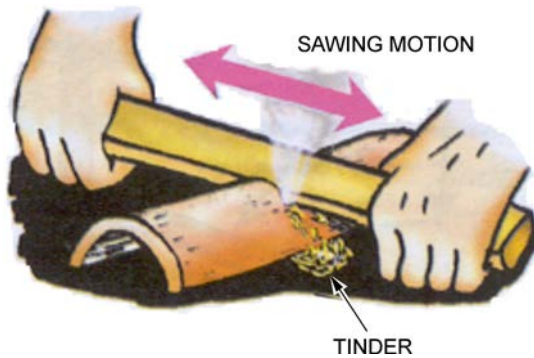

*P. Tawrell, Camping and Wilderness Survival: The Ultimate Outdoors Book (2<sup>nd</sup> ed.), Paul Tawrell (p. 434)*

Figure 14B-1 Fire Saw in Motion

THIS PAGE INTENTIONALLY LEFT BLANK

## FLINT AND STEEL

Construct and use flint and steel using the following steps:

1. Hold the flint as close to the tinder as possible.
2. Strike it with the back of a knife blade or a small piece of carbon steel.
3. Collect kindling, tinder and fuel as required.
4. Strike downward so that the sparks fall into the tinder.
5. When the tinder begins to smoulder, fan or blow it gently into a flame.
6. Stop and lightly blow on the tinder to start combustion, once the tinder begins to smoke.
7. Apply gathered kindling and fuel as required, when the tinder ignites.

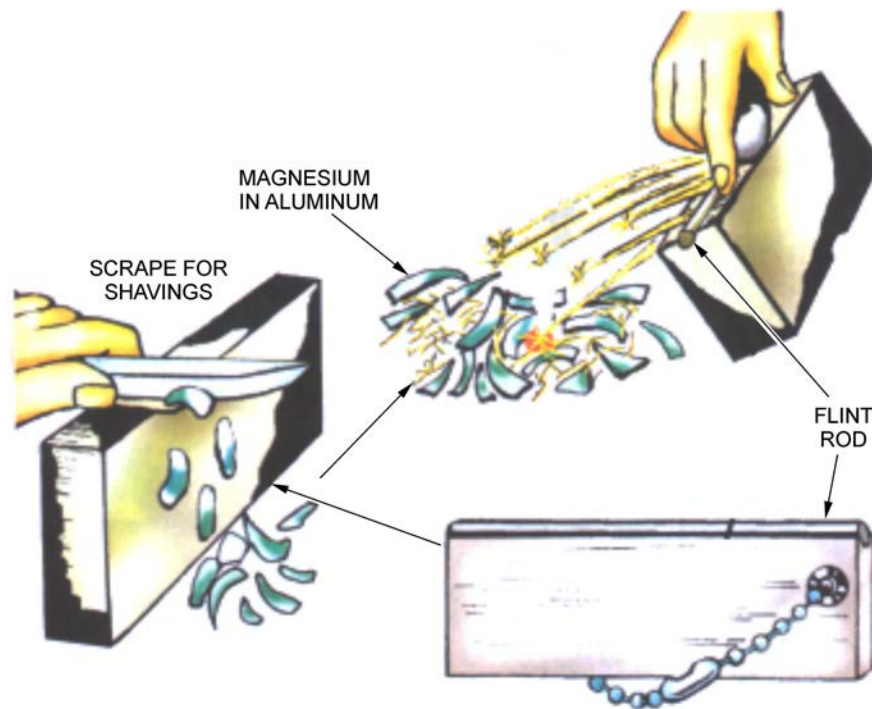

*P. Tawrell, Camping and Wilderness Survival: The Ultimate Outdoors Book (2<sup>nd</sup> ed.), Paul Tawrell (p. 436)*

Figure 14C-1 Flint and Steel

THIS PAGE INTENTIONALLY LEFT BLANK



## SUN AND GLASS

Construct and use sun and glass using the following steps:

1. Locate a sunny spot in an open area.
2. Gather tinder and kindling in a small pile.
3. Point a piece of glass or convex lens to concentrate the rays of sun on the tinder.
4. When the tinder begins to smolder, fan or blow it gently into a flame.
5. Stop and lightly blow on the tinder to start combustion, once the tinder begins to smoke.
6. Apply gathered kindling and fuel as required, when the tinder ignites.

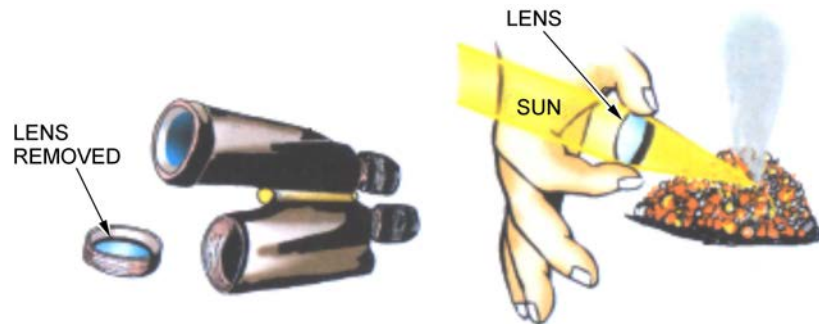

*P. Tawrell, Camping and Wilderness Survival: The Ultimate Outdoors Book (2<sup>nd</sup> ed.), Paul Tawrell (p. 437)*

Figure 14D-1 Sun and Glass

THIS PAGE INTENTIONALLY LEFT BLANK

### COMMON TYPES OF CLOUDS

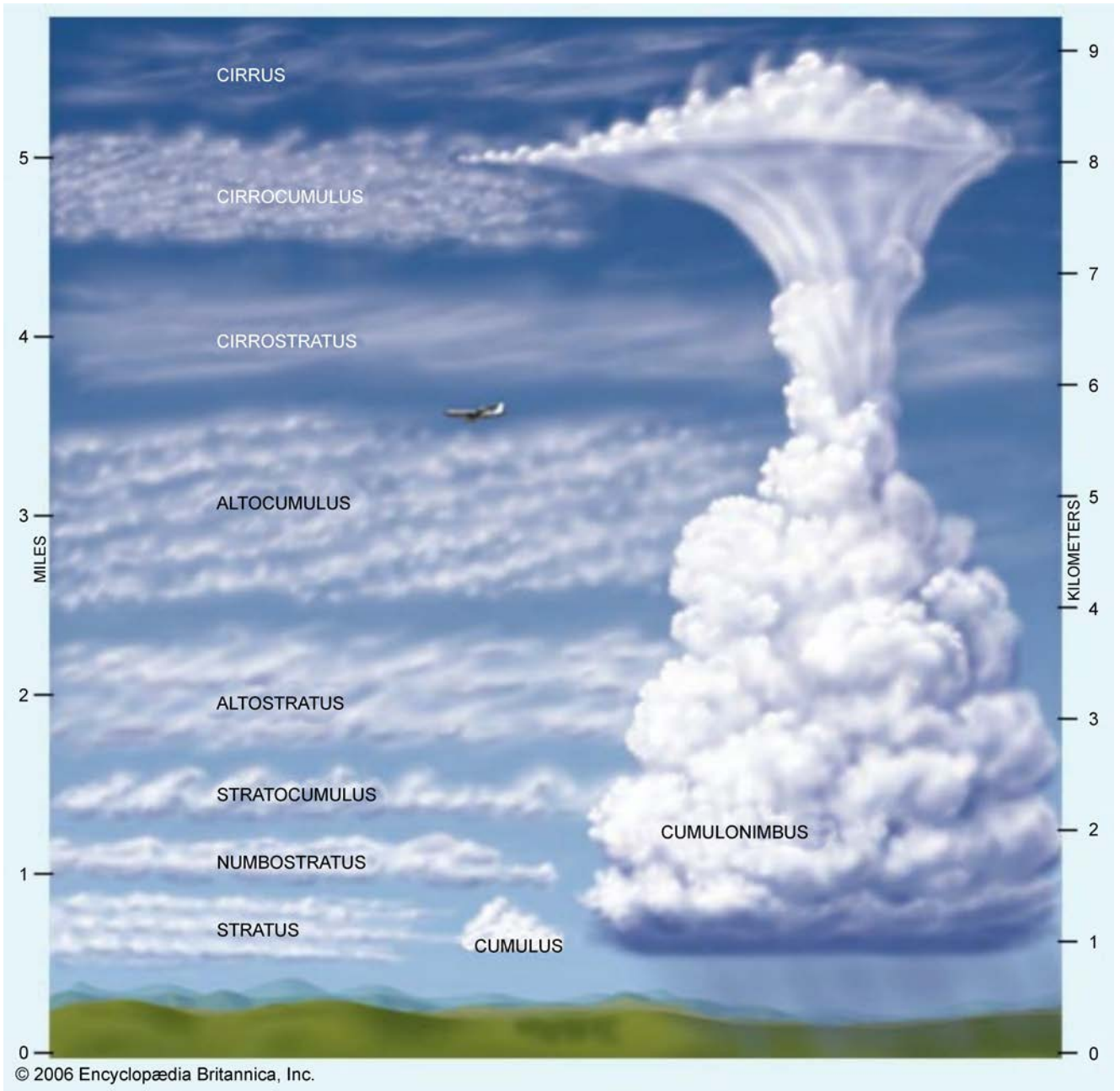

"Cumulus Cloud", by Encyclopaedia Britannica, Inc. 2006, Encyclopaedia Britannica Online, Copyright 2006 by Encyclopaedia Britannica, Inc. Retrieved November 21, 2007, from <http://cache.eb.com/eb/image?id=93302&rendTypeId=34>

Figure 14E-1 Common Types of Clouds

THIS PAGE INTENTIONALLY LEFT BLANK

### COMMON HABITAT

Rotting logs, stones, boards or any other materials lying on the ground provide good nesting sites and are excellent places to find a variety of insects including ants, termites, beetles and grubs. Grassy areas are good areas to search because insects are easily seen. The following insects can commonly be found in most locations.

**Grasshoppers.** Most commonly found in open fields. Watch for them jumping out of the way when walking. Eaten raw or cooked, remove the legs.



*Discover Entomology, by Carl D. Patrick, Grasshoppers and Their Control, Copyright 2008 by Texas A&M University Department of Entomology. Retrieved March 5, 2008, from <http://insects.tamu.edu/extension/bulletins/l-5201.html>*

Figure 14F-1 Grasshopper

**Beetles.** Often found under rotting logs, stones, boards or any other material lying on the ground. Insects with hard outer shells will have parasites so cook them before eating.



*Canadian Biodiversity Information Facility, Ground Beetles of Canada. Retrieved March 5, 2008, from [http://www.cbif.gc.ca/spp\\_pages/carabids/phps/image1\\_e.php#Bembidiini](http://www.cbif.gc.ca/spp_pages/carabids/phps/image1_e.php#Bembidiini)*

Figure 14F-2 Beetles

**Worms.** Worms are an excellent source of protein. Dig for them in damp soil or watch for them on the ground after rain. After collecting them, drop them into clean, potable water for a few minutes. The worms will naturally purge or wash themselves out, after which they can be eaten raw.



*Cheshire Wildlife Trust, Find Out About Earth Worms, Copyright 2004 by Cheshire Wildlife Trust. Retrieved March 5, 2008, from [http://www.wildlifetrust.org.uk/cheshire/watch\\_earthworms.htm](http://www.wildlifetrust.org.uk/cheshire/watch_earthworms.htm)*

Figure 14F-3 Earth Worm

**Grubs.** Known as insect larva, grubs are often found under rotting logs, stones, boards or any other materials lying on the ground.



*Green Smiths, Grub Worms. Retrieved March 5, 2008, from <http://www.greensmiths.com/grubs.htm>*

Figure 14F-4 Grubs

**Aquatic Insects.** Many species of edible insects exist around the edges of lakes, or ponds, or the ocean. Cook any hard shell insects.





*P. Tawrell, Camping and Wilderness Survival: The Ultimate Outdoors Book (2<sup>nd</sup> ed.), Paul Tawrell (p. 912)*

Figure 14F-5 Water Insects

### IDENTIFYING TRACKS AND HABITAT

All animals can be a source of nourishment. The more one knows about animals, the better the chances of locating an animal. To find an animal in the wild, one must be observant for signs. If a person can recognize the signs an animal leaves, and identify the animal, one can devise a method to hunt and trap it.

Most mammals are on the move at dawn and dusk (first light, last light), using regular routes between their watering spots, feeding places and homes. Animal tracks and trails can be identified by looking for specific signs.

The following are tips to locate and identify animals:

- Tracks are more obvious on wet ground snow and damp sand.
- The size of the impression is left from their tracks.
- The age of the track can be identified by its sharpness and moisture content.
- The clearer the track the more recent it is. If water or rain has seeped into it, it may be older.
- Heavy vegetation reveals regularly used routes or paths.
- Some animals never travel very far; any tracks likely mean they are in the area.
- Smaller animals make tunnels through dense underbrush.
- Broken twigs along a route, will identify direction of travel and the height of the animal.

### Rabbits and Hares

Rabbits and hares are easy to catch. They live either in burrows or above ground and most often use a specific run that they routinely retrace. Rabbits and hares have long hind legs with small front paws. When looking for rabbits or hares keep the following in mind:

- They leave little detail on soft ground.
- They have a narrow hind foot with four toes.
- They leave tracks with their hind feet in front of the forefoot instead of side by side.
- They eat tree bark and may nibble the base of a tree.

- They warn other rabbits and hares by using their paws to create sounds. The sound emitted sounds like a thump or someone hitting a cushion.



*N. Bowers, R. Bowers, and K. Kaufman, Kaufman Focus Guides: Mammals of North America, Houghton Mifflin Company (p. 35)*

Figure 14F-6 Rabbit and Tracks

### Squirrels

Squirrels are alert and very nimble. Most are active day and night – feeding on nuts, fruits, shoots and for some bird's eggs. Their nests are usually the size of a small day pack, made of sticks and leaves, high in trees. However, squirrels seek out tree hollows for winter dens. Squirrels are small and their tracks are barely noticeable. Signs of squirrel presence include:

- chewed cones,
- cone scales piled about, and
- loud and almost continuous high-pitched squeals and chirps.



*N. Bowers, R. Bowers, and K. Kaufman, Kaufman Focus Guides: Mammals of North America, Houghton Mifflin Company (p. 49)*

Figure 14F-7 Squirrel and Tracks

### Marmots (Groundhog)

The groundhog is most commonly found on pastures, roadsides, and overgrown fields. Groundhogs live alone in burrows up to 9 m long (30 feet), excavated under stumps, rocks or edges of buildings. Normally there are three entrances to the burrows. They are visible, measuring 20–30 cm (8–12 inches) across, with big mounds of dirt nearby.





*N. Bowers, R. Bowers, and K. Kaufman, Kaufman Focus Guides: Mammals of North America, Houghton Mifflin Company (p. 91)*

Figure 14F-8 Marmot (Groundhog) and Tracks

### Porcupines

The porcupine is the second largest rodent. It has sharp quills that are solid at the base and barbed at the tip. This animal feeds mainly on grasses, acorns and twigs and is fond of salt. Their tracks and signs include:

- footprints, where the front paws have four toes and hind paws have five toes,
- trees with bark stripped in irregular patches, and
- nipped twigs littering the ground.



*N. Bowers, R. Bowers, and K. Kaufman, Kaufman Focus Guides: Mammals of North America, Houghton Mifflin Company (p. 109)*

Figure 14F-9 Porcupine and Tracks

### Beavers

Beavers are known as dam builders. They are aquatic animals with scaly, padded-like tails. They can be found using regular runs along streams, lakes, or bogs/marshes and reside in a den known as a beaver house, where they can be trapped. Their tracks and signs include:

- fore footprints that have five toes with claw marks but, often only four show,
- rear footprints that are webbed, roundish and larger,
- water levels that are higher than normal lakes, bogs or marshes,
- the presence of a beaver dam, lodges, fallen and chewed saplings, and

- the presence of bark shavings near water.



*N. Bowers, R. Bowers, and K. Kaufman, Kaufman Focus Guides: Mammals of North America, Houghton Mifflin Company (p. 110)*

Figure 14F-10 Beaver and Tracks

### Raccoons

The “masked bandit” lives in a variety of habitats, from forests to prairies to city parks. They prefer to be in the vicinity of water and trees and are most abundant in wooded swamps. They reside in dens often in a hollow tree or log, rock crevice, cave or abandoned building. A raccoon’s diet from land sources includes nuts, fruit, insects, small rodents, and birds. Near water they will eat frogs, fish, molluscs and insects. Their tracks and signs include:

- a hind track that is about 7.62 cm (3 inches) long with 5 toes, and
- a front paw that is like a small hand with five fingers.



*N. Bowers, R. Bowers, and K. Kaufman, Kaufman Focus Guides: Mammals of North America, Houghton Mifflin Company (p. 99)*

Figure 14F-11 Raccoon and Tracks

## **DETECTING SIGNS OF FEEDING**

A skilled eye can often identify the species of animal by the pattern left by teeth or beak marks on a nut, or the way in which a pine cone has been stripped to get at its seeds. Some signs of feeding that may be found in the wilderness include:

- bark stripped from trees,
- the gnawed shells of nuts,
- partially eaten fruits,
- bitten off shoots,
- the remains of prey, and
- remains of carnivores or the destruction of nests.

Discarded fruits or nuts are often found when food is plentiful – an animal finds one piece not to its liking and drops it to try another. They not only disclose an animal's presence but suggest bait for traps.

## **FINDING DROPPINGS**

Droppings (sometimes called scat) are one of the best indications of whether an animal is a herbivore or a carnivore. The size of the animal can be judged from the mass and quantity of droppings. The dropping's dryness is an indication of how long it has been since they were passed. Old droppings will be hard and odourless. Fresh droppings will be wet, still smell and may be covered by flies.

The composition of droppings can be used to figure out what kind of animal deposited it. Bits of plant material (stems, seeds, husks, and stalks) indicate an herbivore (plant eater). There is almost no scent to the droppings of a plant eater, although those that have gorged on berries leave sweet smelling scat.

Droppings filled with animal material (scales, bones, and fur) left by a carnivore, usually has a rank smell. A mass of flies indicate a pile of fresh droppings.

## **IDENTIFYING ROOTINGS**

Some animals root up the ground in search of insects and tubers. If the earth is still crumbly and fresh an animal is likely to have been active on the spot. Small scratches may be where a squirrel or other rodents have been digging for shoots.

## **DETECTING SCENTS AND SMELLS**

Be alert and if you smell anything out of the ordinary. Try and register the smells. They may be indications of wildlife present. Where one kind of animal exists, there will also be others.

THIS PAGE INTENTIONALLY LEFT BLANK

### INSECT NUTRITIONAL VALUE CHART

<b>Insect (per 100 g)</b>	<b>Protein (g)</b>	<b>Fats (g)</b>	<b>Carbohydrates (g)</b>	<b>Calcium (mg)</b>	<b>Iron (mg)</b>
<b>Crickets</b>	<b>12.9</b>	<b>5.5</b>	<b>5.1</b>	<b>75.8</b>	<b>9.5</b>
<b>Small Grasshoppers</b>	<b>20.6</b>	<b>6.1</b>	<b>3.9</b>	<b>35.2</b>	<b>5.0</b>
<b>Giant Water Beetles</b>	<b>19.8</b>	<b>8.3</b>	<b>2.1</b>	<b>43.5</b>	<b>13.6</b>
<b>Red Ants</b>	<b>13.9</b>	<b>3.5</b>	<b>2.9</b>	<b>47.8</b>	<b>5.7</b>
<b>Silkworm Pupae</b>	<b>9.6</b>	<b>5.6</b>	<b>2.3</b>	<b>41.7</b>	<b>1.8</b>
<b>Termites</b>	<b>14.2</b>	<b>n/a</b>	<b>n/a</b>	<b>0.050</b>	<b>35.5</b>
<b>Weevils</b>	<b>6.7</b>	<b>n/a</b>	<b>n/a</b>	<b>0.186</b>	<b>13.1</b>

*G. Davenport, Wilderness Survival, Stackpole Books (p. 161)*

Figure 14G-1 Nutritional Value

THIS PAGE INTENTIONALLY LEFT BLANK

**COMMON POISONOUS PLANTS**



Government of Canada Poisonous Plants. Retrieved November 15, 2007, from [http://cbif.gc.ca/pls/pp/ppack.jump?p\\_null=illust&p\\_type=list&p\\_sci=comm&p\\_x=px](http://cbif.gc.ca/pls/pp/ppack.jump?p_null=illust&p_type=list&p_sci=comm&p_x=px)

Figure 14H-1 Poison Ivy



Government of Canada Poisonous Plants. Retrieved November 15, 2007, from [http://cbif.gc.ca/pls/pp/ppack.jump?p\\_null=illust&p\\_type=list&p\\_sci=comm&p\\_x=px](http://cbif.gc.ca/pls/pp/ppack.jump?p_null=illust&p_type=list&p_sci=comm&p_x=px)

Figure 14H-2 Poison Oak

THIS PAGE INTENTIONALLY LEFT BLANK



## COMMON POISONOUS PLANTS



*Government of Canada Poisonous Plants. Retrieved November 15, 2007, from [http://cbif.gc.ca/pls/pp/ppack.jump?p\\_null=illust&p\\_type=list&p\\_sci=comm&p\\_x=px](http://cbif.gc.ca/pls/pp/ppack.jump?p_null=illust&p_type=list&p_sci=comm&p_x=px)*

Figure 14I-1 Castor Bean



*Government of Canada Poisonous Plants. Retrieved November 15, 2007, from [http://cbif.gc.ca/pls/pp/ppack.jump?p\\_null=illust&p\\_type=list&p\\_sci=comm&p\\_x=px](http://cbif.gc.ca/pls/pp/ppack.jump?p_null=illust&p_type=list&p_sci=comm&p_x=px)*

Figure 14I-2 Death Camas



*Government of Canada Poisonous Plants. Retrieved November 15, 2007, from [http://cbif.gc.ca/pls/pp/ppack.jump?p\\_null=illust&p\\_type=list&p\\_sci=comm&p\\_x=px](http://cbif.gc.ca/pls/pp/ppack.jump?p_null=illust&p_type=list&p_sci=comm&p_x=px)*

Figure 14I-3 Oleander



*Government of Canada Poisonous Plants. Retrieved November 15, 2007, from [http://cbif.gc.ca/pls/pp/ppack.jump?p\\_null=illust&p\\_type=list&p\\_sci=comm&p\\_x=px](http://cbif.gc.ca/pls/pp/ppack.jump?p_null=illust&p_type=list&p_sci=comm&p_x=px)*

Figure 14I-4 Poison Hemlock

## METHODS OF FIELD COOKING HANDOUT

Cooking in the field is an important skill for people who find themselves in a survival situation. Since the human body needs nutrients and energy, cooking is essential to kill harmful bacteria. There are many different ways to cook in the field.

### BAKING IN A SHALLOW PIT LINED WITH ROCKS

The best way to bake in the field is in the ground. When food is buried, it will cook faster. To do this:

1. Dig a shallow pit in the ground.
2. Line the pit with rocks.
3. Burn a small fire to get a bed of coals.
4. Place a layer of wet grass on the embers when there are no more open flames and only hot, red embers remaining (if the grass is dry, use water).
5. Place the food (already prepared to be cooked) on top of the wet grass.
6. Use a stick to move around the hot coals to get them as close to the food as possible. Try to put some coals on top of the food.
7. Cover the food with the earth that was dug from the pit.

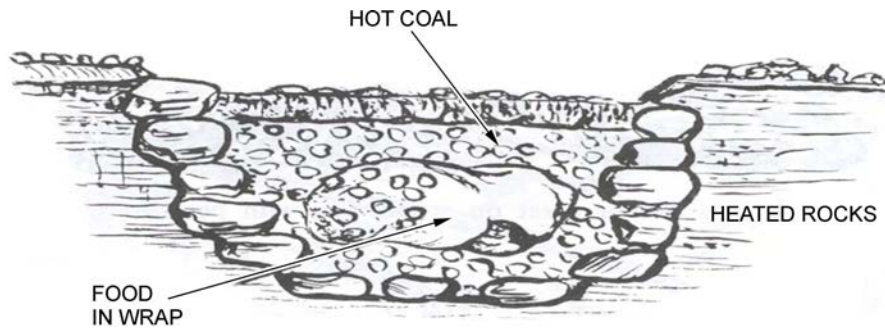

*Department of National Defence, Down But Not Out, Department of National Defence (p.130)*

Figure 14J-1 Baking in the Ground



When using this method, it is very difficult to check and see if the food is cooked. Cooking time will vary, depending on what is being cooked. Ensure food is completely cooked before consuming. Place it back in the ground and allow more time if unsure.

### ROASTING WITH A STICK

Roasting is an easy method that produces tasty results. Unfortunately, it also produces a lot of grease when cooking meat. To minimize waste, place a pot or container under the roasting food to catch grease. Place the object being cooked on the end of a stick, beside an open fire. The food should not be placed directly over the fire and direct contact with smoke and flame should be avoided as much as possible.

The food will need to be rotated or turned to ensure it is cooked throughout. If hanging the food above the fire, a rotor, made with plastic or heavy paper, can be attached (see Figure 14J-2). The rotor will catch and turn in the wind, turning the food.

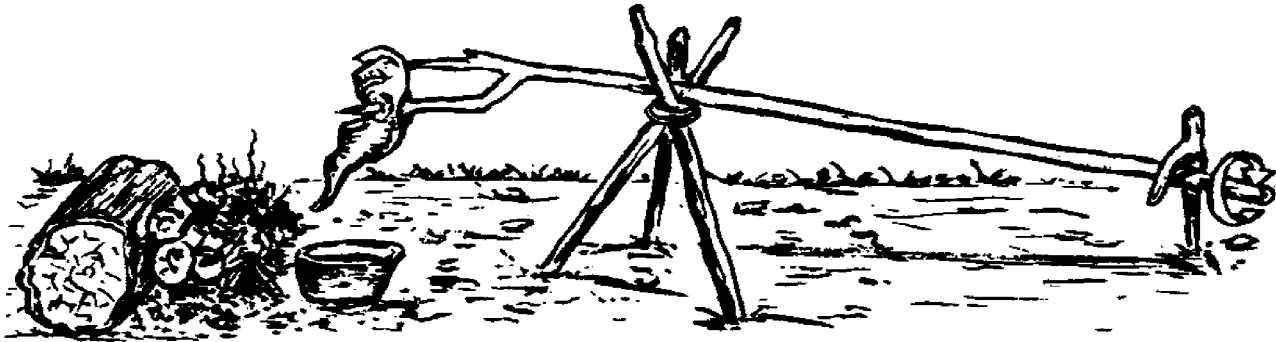

Department of National Defence, *Down But Not Out*, Department of National Defence (p.129)

Figure 14J-2 Roasting on a Stick

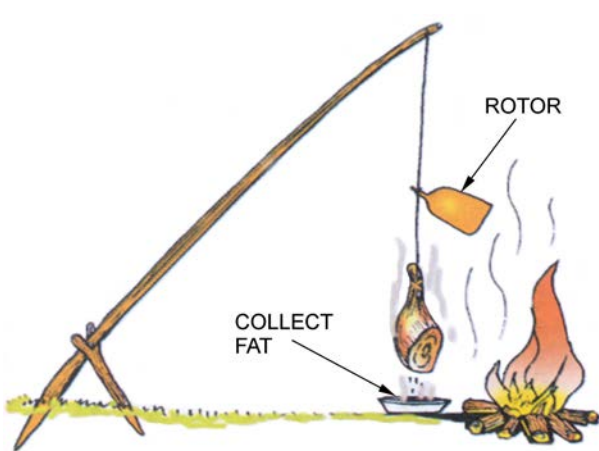

P. Tawrell, *Camping and Wilderness Survival*, Paul Tawrell (p. 442)

Figure 14J-3 Roasting With a Rotor

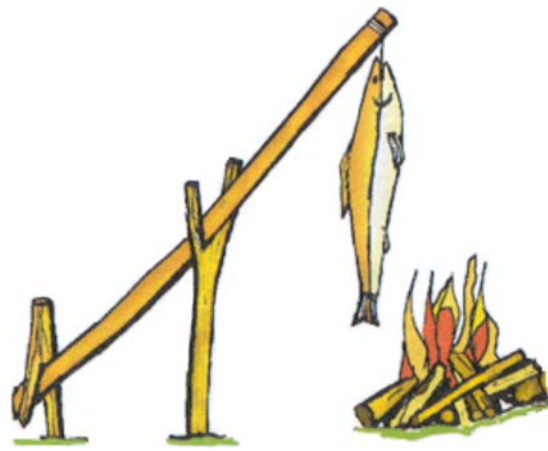

P. Tawrell, *Camping and Wilderness Survival*, Paul Tawrell (p. 448)

Figure 14J-4 Roasting Fish

## BOILING IN A POT

Boiling in a pot can be done over an open fire, the same as on a stove. When boiling in a pot, ensure the pot is sitting straight up on the fire. This can be done by using a grill, wedging it between two pieces of thick wood or placing rocks around to stabilize it. There are many ways to place a pot over a fire using wood (see Figures 14J-5 to 14J-8). It is important to ensure the pot is stable and does not have a risk of falling into the fire.

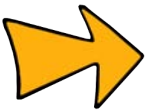

Seeing bubbles is an easy way to tell that water is boiling.



Boiling over an open fire will normally cause soot to form on the outside of the pot. A coating of soapy water on the outside of the pot will make cleaning much easier.



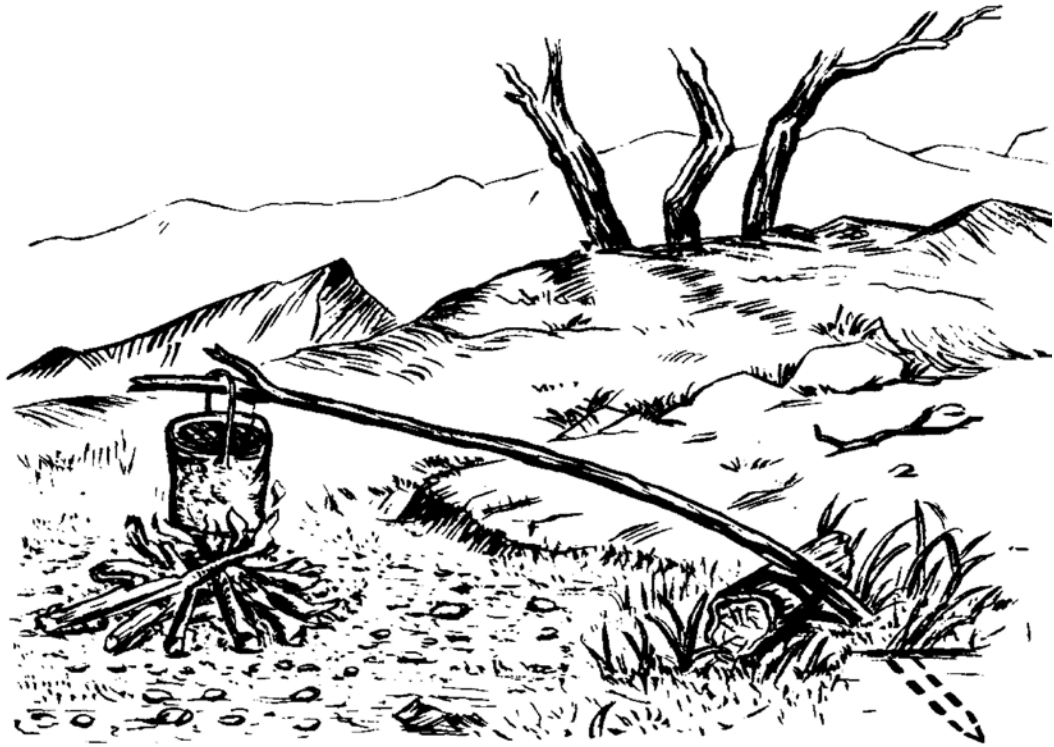

*Department of National Defence, Down But Not Out, Department of National Defence (p. 128)*

Figure 14J-5 Boiling

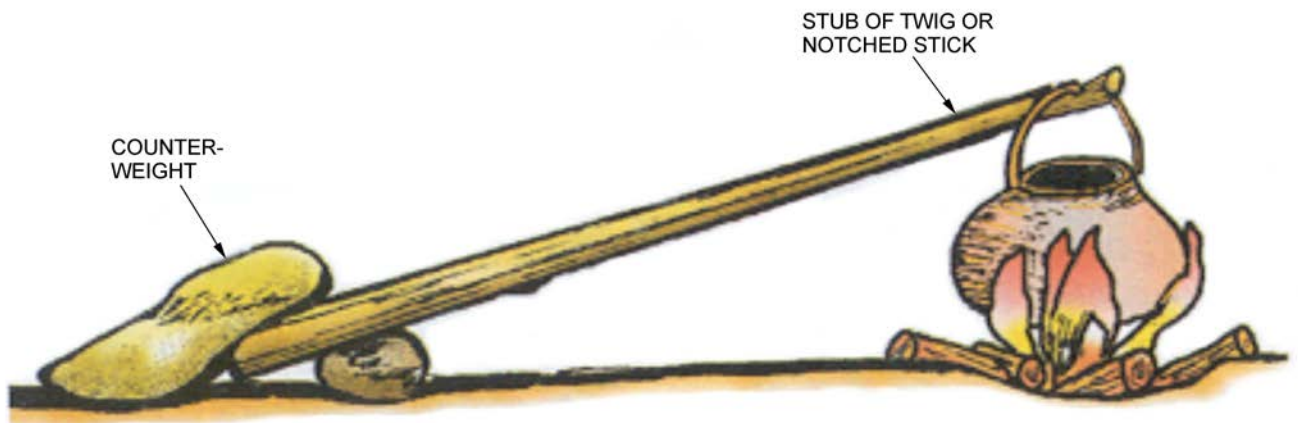

*P. Tawrell, Camping and Wilderness Survival, Paul Tawrell (p. 442)*

Figure 14J-6 Boiling Using a Counterweight

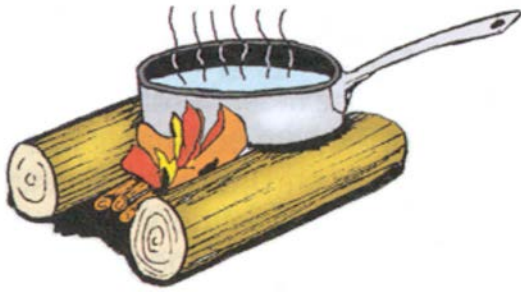

*P. Tawrell, Camping and Wilderness Survival, Paul Tawrell (p. 444)*



*P. Tawrell, Camping and Wilderness Survival, Paul Tawrell (p. 442)*

Figure 14J-7 Boiling on an Open Flame With Wood

Figure 14J-8 Boiling on an Open Flame With Rocks

### FRYING

Food can be easily fried on a rock or sheet of metal. A rock will hold a lot of heat for a very long time. When using this method to cook, food may easily stick if there is not a sufficient amount of grease.

STONE  
GRIDDLE

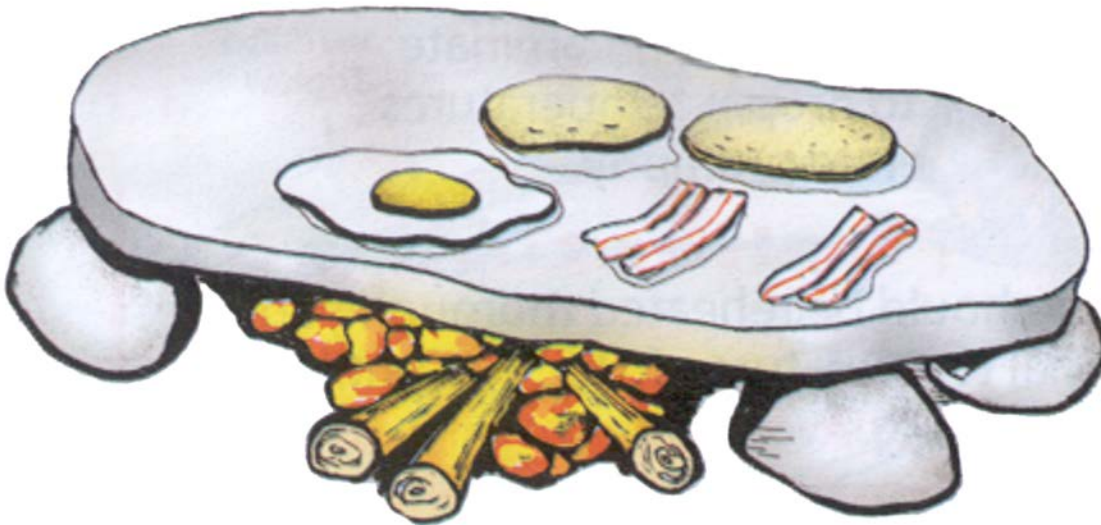

*P. Tawrell, Camping and Wilderness Survival, Paul Tawrell (p. 442)*

Figure 14J-9 Frying on a Flat Rock

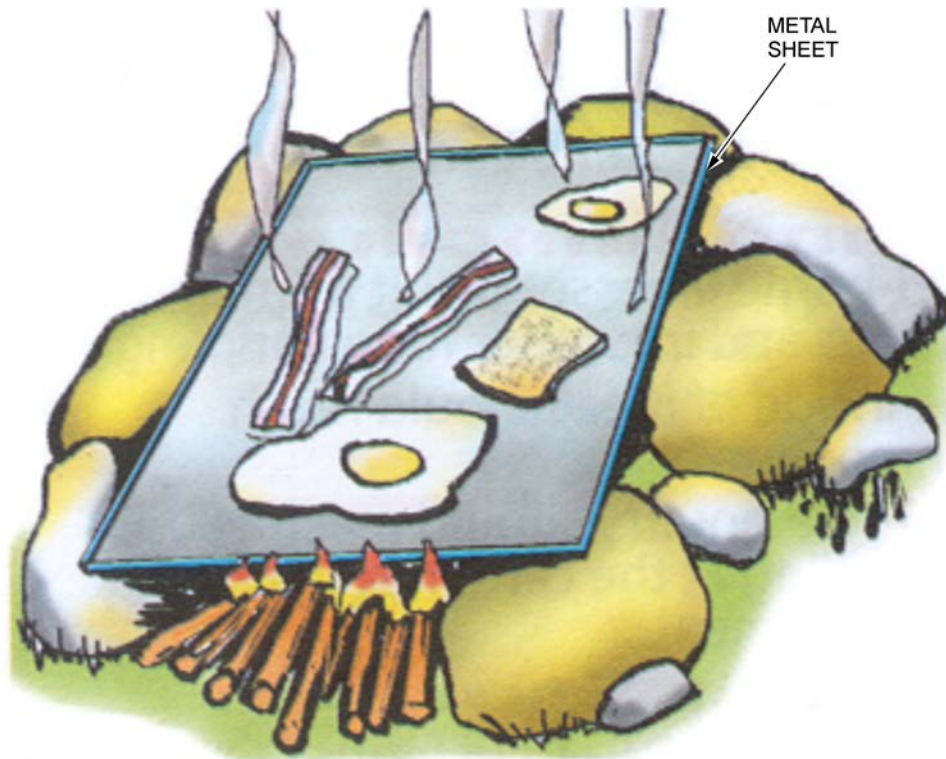

*P. Tawrell, Camping and Wilderness Survival, Paul Tawrell (p. 442)*

Figure 14J-10 Frying With a Metal Sheet

THIS PAGE INTENTIONALLY LEFT BLANK



**CHAPTER 15**

**PO 325 – IDENTIFY THE COMPETENCIES OF AN OUTDOOR LEADER**





**ROYAL CANADIAN ARMY CADETS**  
**SILVER STAR**  
**INSTRUCTIONAL GUIDE**



**SECTION 1**

**EO M325.01 – PARTICIPATE IN A DISCUSSION ON ARMY CADET EXPEDITION TRAINING**

---

Total Time:

30 min

---

**PREPARATION**

---

**PRE-LESSON INSTRUCTIONS**

Resources needed for the delivery of this lesson are listed in the lesson specification located in A-CR-CCP-703/PG-001, Chapter 4. Specific uses for said resources are identified throughout the instructional guide within the TP for which they are required.

Review the lesson content and become familiar with the material prior to delivering the lesson.

**PRE-LESSON ASSIGNMENT**

N/A.

**APPROACH**

An interactive lecture was chosen for TP 1 to introduce the topic of adventure learning and expeditions, and highlight opportunities available to cadets through expedition training within the Army Cadet Program.

A group discussion was chosen for TPs 2 and 3 as it allows the cadets to interact with their peers and share their knowledge, experiences, opinions and feelings about army cadet expedition training. This helps develop rapport by allowing the cadets to speak in a non-threatening way while helping them refine their ideas. A group discussion also helps cadets improve their listening skills and develop as members of a team.

---

**INTRODUCTION**

---

**REVIEW**

N/A.

**OBJECTIVES**

By the end of this lesson the cadet shall have participated in a discussion on cadet expedition training.

**IMPORTANCE**

It is important for cadets to understand the history of outdoor programs and the expedition program within army cadets as it is the backbone of the Army Cadet Program. Having the background knowledge of army cadet expedition training will allow cadets to participate in expedition training to the level they choose, as well as having the ability to set personal goals.

**Teaching Point 1****Discuss the History of Civilian Outdoor Programs**

Time: 5 min

Method: Interactive Lecture



The difference between going outside and an organized outdoor program is in the leadership and facilitation of the activity.

This TP illustrates the changes and growth of outdoor programs.

Adventure learning was initially regarded as lacking a solid base, its benefits unrecognized. However, those that participated in the activities were adamant that there was a personal benefit. It was not until the 1950s that this development began to be recognized. Hence, adventure training and outdoor education have been studied and critiqued since the 1950s.

**GROWTH OF ADVENTURE LEARNING PROGRAMS**

Adventure learning is a branch of outdoor education that focuses on personal relationships. Trained facilitators present a series of activities that challenge personal and group limits within a supportive environment.

Adventure learning stemmed from a need to better prepare outdoor instructors through formal leadership courses. The current training and education evolved over many decades, and now extends around the globe with the common goal of training outdoor leaders to a high degree of professionalism.

**HISTORY OF OUTWARD BOUND CANADA**

The Outward Bound organization was founded in 1941 by Kurt Hahn in Wales. Hahn claimed that challenge-based outdoor training would benefit the personal development of students. Outward Bound is a wilderness expedition placing experience and challenge at the forefront of all activities providing students the opportunity to meet challenges.

Outward Bound Canada was started in 1969, and has been challenging youth and adults in the wilderness classroom ever since. Based on the 20<sup>th</sup> century school originating in Wales, Outward Bound Canada facilitates adventure in the classic sense, dealing with the unknown.

Outward Bound courses are challenging journeys through Canada's wilderness, where every aspect of the outdoors is the classroom. Through this medium, students develop leadership skills, work effectively as a member of team, and progress through technical and decision-making skills.



The name Outward Bound originates from the idea of a ship leaving the harbour and headed to face the challenges and risks of the sea. For sailors, it implied commitment to long journeys and adventure.

**EXPERIENTIAL TRAINING IN CANADA**

Adventure and experiential training in Canada originally began in Ontario, British Columbia and Nova Scotia. All three provinces have been facilitating experiential training since the 1970s. Now all provinces and territories have a form of experiential training, through local government and/or civilian organizations.

## WILDERNESS AND EXPERIENTIAL THERAPY

Wilderness and Experiential Therapy has been used by organizations dealing with at risk youth, youth with disabilities, and young offenders for many years. The idea is to challenge youth in unfamiliar situations.



Wilderness and experiential therapy is a process through which a learner constructs knowledge, skill, and value from direct experience.

This challenge involves experiential education, cultural awareness, skill development and personal growth.

The goal of wilderness and experiential therapy is to provide students with communication, goal setting and strategies for continued success beyond the therapy.

---

### CONFIRMATION OF TEACHING POINT 1

---

#### QUESTIONS

- Q1. What is the purpose of Outward Bound?
- Q2. Where did adventure and experiential training start in Canada?
- Q3. What is the goal of Wilderness and Experiential Therapy?

#### ANTICIPATED ANSWERS

- A1. Outward Bound is a wilderness expedition placing experience and challenge at the forefront of all activities providing students the opportunity to meet challenges.
- A2. Adventure and experiential training in Canada started in Ontario, British Columbia and Nova Scotia.
- A3. The goal of wilderness and experiential therapy is to provide students with communication, goal setting and strategies for continued success.

---

#### Teaching Point 2

#### Discuss Army Cadet Expedition Training

Time: 10 min

Method: Guided Discussion

---

### BACKGROUND KNOWLEDGE

---



The point of the group discussion is to draw the following information from the group using the tips for answering/facilitating discussion and the suggested questions provided.



Cadets can experience many different training streams in the army cadet movement. This TP provides details on the structure of army cadet expedition training.

## HISTORICAL DEVELOPMENT AND RATIONALE OF THE PROGRAM



Expedition is defined as an organized voyage or journey across land or water, with a specific aim.

Army cadet expedition training combines many historical army-related field skills with adventure training to create one of the most challenging and rewarding aspects of army cadet training. Current army cadet expedition training evolved from a common vision developed by stakeholders in 1998 and refined over the period of a decade.

Expeditions provide an excellent platform for army cadets to achieve the aims and participant outcomes of the Cadet Program. Specifically, the objectives of expedition training are:

- to ensure all cadets participate in army cadet adventure training activities as part of mandatory training;
- promote retention and recruiting at the corps;
- develop leadership skills, while enhancing self-reliance, self-confidence, self-esteem, and self-discipline; and
- raise the profile and promote the Army Cadet Program.



For more information on the Cadet Program mandate refer to CATO 11-03, *Cadet Program Mandate*.

## THE ARMY CADET EXPEDITION MODEL

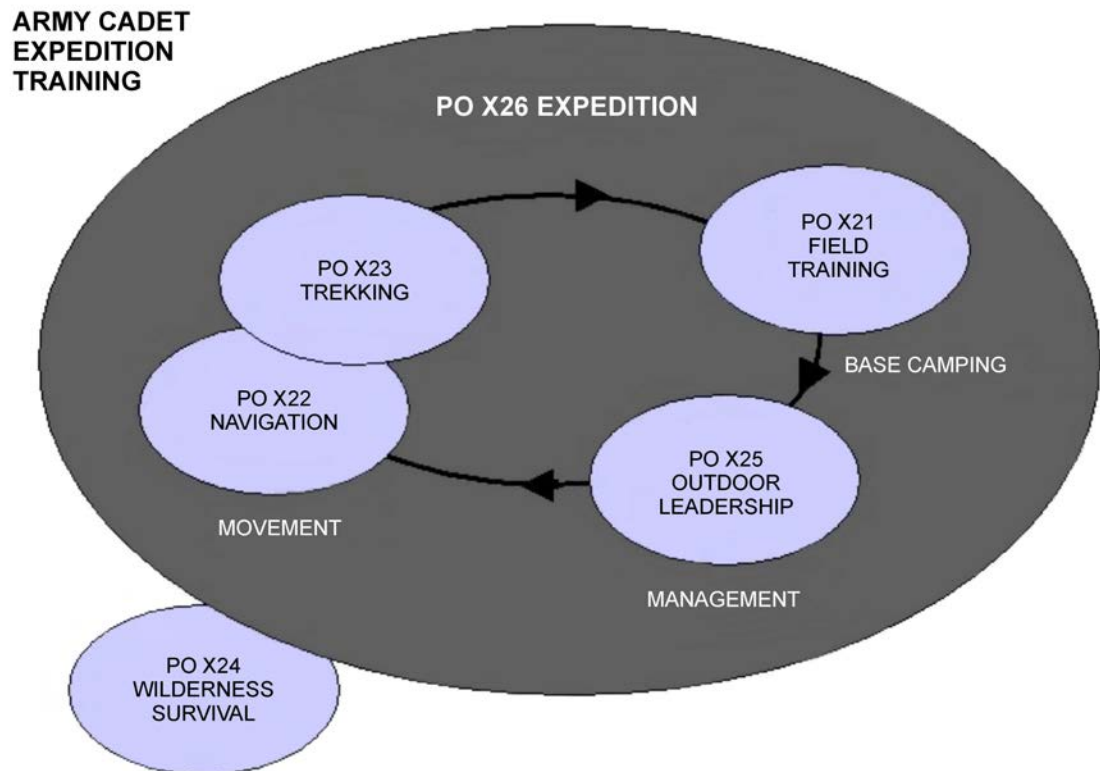

*Director Cadets 3, 2008, Ottawa, ON: Department of National Defence*

Figure 15-1-1 Army Cadet Expedition Model

As illustrated in Figure 15-1-1, expedition is built on training at the corps that incorporates base camping (PO X21 Field Training), movement (PO X22 Navigation and PO X23 Trekking) and management (PO X25 Outdoor Leadership). From this foundation a cadet is well equipped to move to more advanced expeditions at regional expedition centres, Cadet Summer Training Centres, and at a national and international level.

### BASE CAMPING

**PO X21 Field Training.** When a young person joins the Army Cadet Program they may have never spent a night outdoors. Field Training builds the basic skills requisite for a cadet to be able to comfortably live in the outdoors in a stationary supported base camp. In Silver Star, cadets transition from the relatively luxurious accommodations of a supported base camp to the more challenging environment of an expedition campsite in preparation for expeditions that may require a cadet to travel for a number of days carrying all of their support equipment.

### MOVEMENT

**PO X22 Navigation.** In order for a cadet to be capable of travelling by any means during an expedition they must first be capable of navigating. Navigation in the Cadet Program progressively trains a cadet by instructing map using in Green Star, map and compass use in Red Star, map and GPS in Silver Star and GPS navigation in Gold Star. By the time a cadet achieves their Master Cadet qualification, they should be proficient in navigation.

**PO X23 Trekking.** The cornerstone method of movement during an expedition is trekking, which is defined within the Army Cadet Program as, “arduous outdoor travel on foot.” Cadets begin expedition training with a day hike on Class 1 terrain in Green Star, and the cadet is challenged as they progress through the Army Cadet Program by increasing levels of terrain difficulty and by shifting to backpacking, which is an overnight hike with all required equipment being carried by group members. All expeditions will involve some level of trekking. As expeditions become more advanced, other modes of dynamic travel will be introduced, such as canoeing and mountain biking.

## MANAGEMENT

**PO X25 Outdoor Leadership.** Someone who leads others in the outdoors is an outdoor leader. By the time a cadet is qualified as a master cadet they are able to plan, implement, and lead their peers on an expedition. To provide the cadet with the requisite skills to reach this goal, the Army Cadet Program introduces the cadet to the technical competencies that differentiate an outdoor leader from any other leader. It also provides the cadet with the management skills required to plan an expedition, and prepares the cadet to lead an expedition.

## WILDERNESS SURVIVAL

**PO X24 Wilderness Survival.** Peripheral to any expedition are the skills to survive if one becomes lost in the wilderness. PO X24 Wilderness Survival provides cadets with the basic skills that may increase their chance of survival.

## THE ROLE OF THE EXPEDITION CENTRE

Regional expedition centres conduct training that is beyond the scope of the average cadet corps. Expedition centres use adult staff with considerable expedition and adventure training experience to provide cadets with an experience beyond the resources of an average corps. Cadets attending an expedition centre will be challenged physically and mentally while building hard and soft expedition skills.

## SKILL DEVELOPMENT

**Hard Skill Development.** Hard skills are solid, tangible, and measurable (also called technical skills). Hard skills are the technical competencies needed to conduct activities skillfully and safely. Examples of hard skills are the ability to climb a certain level of the Yosemite Decimal System (YDS), or paddle a specific class of river. Hard skills are easy to learn, and often involve taking a course.

**Soft Skill Development.** Soft skills are amorphous and intangible, best defined as the interpersonal and people skills required during an activity. These skills include, but are not limited to, communication, listening, understanding and motivating. Soft skills are harder to learn and effective leaders constantly strive to improve these skills.



The activities authorized for adventure training and expeditions are located in A-CR-CCP-951/PT-002, *Royal Canadian Army Cadets Adventure Training Safety Standards* online at [www.cadets.ca](http://www.cadets.ca).



---

## GROUP DISCUSSION

---



### TIPS FOR ANSWERING/FACILITATING DISCUSSION

- Establish ground rules for discussion, eg, everyone should listen respectfully; don't interrupt; only one person speaks at a time; no one's ideas should be made fun of; you can disagree with ideas but not with the person; try to understand others as much as you hope they understand you; etc.
- Sit the group in a circle, making sure all cadets can be seen by everyone else.
- Ask questions that will provoke thought; in other words avoid questions with yes or no answers.
- Manage time by ensuring the cadets stay on topic.
- Listen and respond in a way that indicates you have heard and understood the cadet. This can be done by paraphrasing their ideas.
- Give the cadets time to respond to your questions.
- Ensure every cadet has an opportunity to participate. One option is to go around the group and have each cadet answer the question with a short answer. Cadets must also have the option to pass if they wish.
- Additional questions should be prepared ahead of time.

### SUGGESTED QUESTIONS

- Q1. What subjects are used within expedition training?
- Q2. What role does outdoor leadership play in expedition training?
- Q3. What is the role of the expedition centre?
- Q4. Define hard skills.
- Q5. Define soft skills.



Other questions and answers will develop throughout the group discussion. The group discussion should not be limited to only those suggested.



Reinforce those answers given and comments made during the group discussion, ensuring the teaching point has been covered.

---

### CONFIRMATION OF TEACHING POINT 2

---

The cadet's participation in the group discussion will serve as confirmation of this TP.

**Teaching Point 3****Discuss Opportunities Within Army Cadet Expedition Training**

Time: 10 min

Method: Guided Discussion

**BACKGROUND KNOWLEDGE**

The point of the group discussion is to draw the following information from the group using the tips for answering/facilitating discussion and the suggested questions provided.

Adventure training begins at the corps in Green Star, and all Silver Star cadets have an opportunity to participate in corps expedition training.

**REGIONAL EXPEDITION CENTRE TRAINING**

Regional Expedition Centre training is conducted by the regions and is mandatory training for all Silver Star, Gold Star and Master Cadets. This training will be conducted over one weekend for silver and gold star cadets, with longer expeditions for master cadets, and combines cadets from corps in a common geographic area.



Refer to joining instructions published by the RCSU for further information.



Although it is possible for cadets to participate in many different activities, the listed activities authorized by D Cds & JCR are referred to in CATO 41-05, *Royal Canadian Army Cadet Expedition Program*.

**MASTER CADET EXPEDITION TRAINING**

Each Regional Cadet Support Unit (RCSU) develops and implements regional expeditions. This is supported solely by the RCSU, and cadets are selected from the region.

These expeditions are 4–10 days in duration, provide a personal sense of accomplishment, and are based on an experiential approach where cadets do a minimum of 75 percent adventure-based activities. The level of challenge is high and exceeds that which can be done at the zone level.

Examples of regional expedition sites include the Cathedral Mountains, Petawawa River, Dolomite Pass, and Bay of Fundy.

Selection processes for regional expeditions will be listed in the regional orders, and may include:

- a minimum star qualification,
- a minimum age requirement,
- participation at zone level activities,
- a fitness test, and/or
- medical fitness IAW CATO 16-02, *Selection of Cadets for Summer Training—Medical Considerations*.

## NATIONAL EXPEDITION TRAINING

National expeditions take two forms: domestic and international. These expeditions are conducted to develop and retain senior cadets and enhance their ability to assist in delivering expedition activities.

### Domestic Expedition

Since 2001, domestic expeditions have been conducted annually within Canada. Sixteen cadets are selected to participate in these expeditions which are 10–14 days in duration and occur in many of Canada's best parks and wilderness areas.

### International Expeditions

Every year in September, 16 cadets take part in an international expedition. These expeditions are approximately 14 days in duration and are held in locations worldwide. A few examples of these expeditions include hiking in Australia, trekking in Korea, climbing volcanoes in Costa Rica, and mountaineering in the French and Italian Alps.

Selection processes for domestic and international expeditions will be listed in the national directives, and may include:

- a minimum star qualification,
- a minimum age requirement,
- participation at expedition centre activities,
- a fitness test, and/or
- medical fitness IAW CATO 16-02, *Selection of Cadets for Summer Training–Medical Considerations*.



National and international expedition information can be found at the national cadet website ([www.cadets.ca](http://www.cadets.ca)) or at The Army Cadet League of Canada's website ([www.armycadetleague.ca](http://www.armycadetleague.ca)).

---

## GROUP DISCUSSION

---



### TIPS FOR ANSWERING/FACILITATING DISCUSSION

- Establish ground rules for discussion, eg, everyone should listen respectfully; don't interrupt; only one person speaks at a time; no one's ideas should be made fun of; you can disagree with ideas but not with the person; try to understand others as much as you hope they understand you; etc.
- Sit the group in a circle, making sure all cadets can be seen by everyone else.
- Ask questions that will provoke thought; in other words avoid questions with yes or no answers.
- Manage time by ensuring the cadets stay on topic.
- Listen and respond in a way that indicates you have heard and understood the cadet. This can be done by paraphrasing their ideas.
- Give the cadets time to respond to your questions.
- Ensure every cadet has an opportunity to participate. One option is to go around the group and have each cadet answer the question with a short answer. Cadets must also have the option to pass if they wish.
- Additional questions should be prepared ahead of time.

### SUGGESTED QUESTIONS

- Q1. When does expedition training begin?
- Q2. What is expedition centre training?
- Q3. Explain Master Cadet expedition training.
- Q4. What selection criteria may be included for domestic and international expeditions?
- Q5. Where can expedition information be found?



Other questions and answers will develop throughout the group discussion. The group discussion should not be limited to only those suggested.



Reinforce those answers given and comments made during the group discussion, ensuring the teaching point has been covered.

---

### CONFIRMATION OF TEACHING POINT 3

---

The cadet's participation in the group discussion will serve as confirmation of this TP.

---

**END OF LESSON CONFIRMATION**

---

**QUESTIONS**

- Q1. Give a brief description of the growth of adventure learning programs.
- Q2. What are the objectives of army cadet expedition training?
- Q3. What are some prerequisites for a national expedition?

**ANTICIPATED ANSWERS**

- A1. Adventure learning programs grew with an increased demand for more reliable and concrete training for instructors.
- A2. The objectives of Army Cadet Expedition Training are:
- to ensure all cadets participate in army cadet adventure training activities as part of mandatory training;
  - to promote retention and recruiting at the corps;
  - to develop leadership skills, while enhancing self-reliance, self-confidence, self-esteem, and self-discipline; and
  - to raise the profile and promote the Army Cadet Program.
- A3. The minimum prerequisites for participation in a national expedition are:
- hold a minimum star qualification,
  - meet a minimum age requirement,
  - have participated at zone level activities,
  - pass a fitness test, and/or
  - be medically fit IAW CATO 16-02, *Selection of Cadets for Summer Training–Medical Considerations*.

---

**CONCLUSION**

---

**HOMEWORK/READING/PRACTICE**

N/A.

**METHOD OF EVALUATION**

N/A.

**CLOSING STATEMENT**

Expedition training is exciting and challenging, includes team-building and all the benefits found within the Army Cadet Program. The skills and knowledge acquired during expedition training are transferable to many other aspects of army cadet training as well as civilian adventure activities.

**INSTRUCTOR NOTES/REMARKS**

N/A.

---

**REFERENCES**

---

- A2-001 A-CR-CCP-951/PT-002 Director Cadets 3. (2006). *Royal Canadian Army Cadets Adventure Training Safety Standards*. Ottawa, ON: Department of National Defence.
- A2-035 Director Cadets 4. (2006). CATO 41-05, *Army Cadet Expedition Program*. Ottawa, ON: Department of National Defence.
- C2-034 (ISBN 0-87322-637-2) Priest, S., & Gass, M. (2005). *Effective Leadership in Adventure Programming* (2<sup>nd</sup> ed.). Windsor, ON: Human Kinetics Publishing Inc.
- C2-169 Outward Bound Canada. (2008). *What is Outward Bound?* Retrieved March 3, 2008 from [www.outwardbound.ca](http://www.outwardbound.ca).



**ROYAL CANADIAN ARMY CADETS**  
**SILVER STAR**  
**INSTRUCTIONAL GUIDE**



**SECTION 2**

**EO M325.02 – LIST THE COMPETENCIES OF AN OUTDOOR LEADER (OL)**

---

Total Time: 60 min

---

**PREPARATION**

---

**PRE-LESSON INSTRUCTIONS**

Resources needed for the delivery of this lesson are listed in the lesson specification located in A-CR-CCP-703/PG-001, Chapter 4. Specific uses for said resources are identified throughout the instructional guide within the TP for which they are required.

Review the lesson content and become familiar with the material prior to delivering the lesson.

When setting the jigsaw activity, ensure there is enough room for each group to work independently and free from interruptions by other groups.

Photocopy:

- the scenario located at Annex A (one per cadet),
- the competencies of an OL information cards located at Annexes B to D (three copies),
- the expert activity sheets located at Annex E (one per cadet),
- the competencies of an OL handout located at Annex F (one per cadet), and
- the homework assignment located at Annex G (one per cadet).

**PRE-LESSON ASSIGNMENT**

N/A.

**APPROACH**

An interactive lecture was chosen for TP 1 as it is an interactive way for cadets to define an OL.

An in-class activity was chosen for TP 2 as an interactive way to provoke thought and stimulate interest in the competencies of an OL within a peer setting.

---

**INTRODUCTION**

---

**REVIEW**

N/A.

## OBJECTIVES

By the end of this lesson the cadet shall be expected to define the term OL and list the competencies of an OL.

## IMPORTANCE

It is important for cadets to be able to list the competencies of an OL to ensure that when the cadet is placed in a team leader role while participating in an adventure activity they know what is required of them. The competencies of an OL provide cadets with a foundation on which to develop their skills as an OL. Understanding and subscribing to these competencies will benefit the cadet during cadet adventure training activities, and during civilian outdoor experiences.

---

### Teaching Point 1

### Define an OL

Time: 15 min

Method: Interactive Lecture

---



Some of the information included in this TP will be a review for the cadets. It is important to explain the uniqueness of an OL and how it differs from that of a regular leader at the home corps.

## LEADERSHIP

The term leadership can be interpreted in many different ways. It is defined to meet the needs of goals of the organization, however, all meanings have a common basis or foundation. In most cases, the definition is tailored to fit the activity or organization under which it has been developed.

The Canadian Forces (CF) defines leadership as “directly or indirectly influencing others, by means of formal authority or personal attributes, to act in accordance with one’s intent to a shared purpose”. The CF definition is generic, value-neutral and broadly inclusive of all forms of leadership across a wide range of settings and times.

## DISTINCTION BETWEEN LEADERSHIP AND LEADERS

It is important to note that there should be a distinction between the concept of leadership and the ways in which an individual becomes a leader.

### Leadership

Leadership is a process of influence. In most informal group settings, people who become group leaders influence other group members to create, identify, work toward, achieve, and share mutually acceptable goals. In these types of situations, more than one group member often emerges to fulfill different leadership responsibilities.

Competent leadership requires formal training, especially in outdoor situations where bad leadership can have disastrous consequences.

### Leader

A leader is a person with certain qualities or traits exercising a definite and particular role in relation to others. The role they exercise is a set of expected behaviours associated with a person’s position in a group.





It is important for cadets to understand how the concept of leadership influences the cadets' ability to become a leader. While the terms may seem interchangeable, they are not. Leadership allows for the cadet to develop their skills as a leader even in situations where they are not the leader of the group.

### **EXPECTATIONS OF A LEADER**

Any person who has been a member of a team, participating in an activity, whether indoors or outdoors, has developed a list of expectations they believe the leader of their group should possess. As an individual participating in an activity, people expect leaders to:

- be good at planning and organizing;
- be confident;
- be technically competent, which for OLs includes competency in basic skills such as first aid, route finding and predicting the weather;
- care for other people;
- make good decisions;
- be trustworthy;
- communicate well;
- inspire others to be their best;
- build and maintain morale;
- be good teachers and coaches;
- be able to deal with difficult people and handle conflicts;
- be able to build and guide teams; and
- anticipate problems and deal with them proactively.

### **QUALITIES OF AN OL**

The responsibilities associated with being an OL can, at times, seem overwhelming. It is not just about possessing leadership skills. To be an effective OL, the leader should possess the following qualities:

- courage,
- tenacity,
- humility,
- warmth,
- enthusiasm,
- integrity,
- patience,
- competency,
- strength of character,
- desire to be a leader,

- humour, and
- organizational skills.

### **THE UNIQUE SKILL OF BEING AN OL**

Being an OL requires a different set of skills, qualifications, competencies and qualities than that of a leader in other settings. Incorporating these skills, qualifications and competencies into daily routine while participating in an outdoor adventure activity (OAA) is what makes an individual an OL. OLs:

- are unique as they are usually appointed into the position they hold in the group;
- are motivated and enjoy being outside and instilling this enjoyment in the individuals they lead;
- have previous outdoor experiences that provide them with a strong basis from which to lead;
- are required to use the process of group interaction and cooperation as a basis for the facilitation of personal and social growth of the members in their group;
- are responsible to ensure the safety of the individuals engaging in OAA under their leadership;
- aim to ensure the protection and preservation of the natural environments into which people venture for OAA; and
- aim to enhance the quality of OAA for individuals they are leading.

### **Who Will Lead the Group?**

A leader is either appointed or emerges from the membership to lead. Groups may naturally be drawn to the individual who exhibits the best leadership qualities. Some groups may naturally defer to the individual with the most experience while other groups may feel that no one person needs to be designated as the leader and leadership should be shared among the members of the group.

**Designated Leader.** When a person is appointed as the leader of a group, they become the designated leader. OLs will usually find themselves in this role. They are appointed due to their knowledge and experience in the activities being completed.

### **HARD AND SOFT SKILL COMPETENCY**

Being a leader in the outdoors requires a different set of hard and soft skills than that of a leader in other settings. OLs must be able to incorporate both types of these skills into their daily routine while participating in OAA.

#### **Hard Skills**

Hard skills are the technical, safety and environmental skills associated with being an OL. There is no requirement for individuals to master every skill; however, competency with a wide variety of skills is encouraged. As well, it is important for OLs to know their limitations. The safety of the individuals in the group relies on the ability of the OL to carry out the specific activity.

Examples of hard skills include:

- canoeing,
- mountain biking,
- hiking,
- mountaineering,
- kayaking,
- rock climbing,

- caving,
- ice climbing,
- navigating,
- camping, and
- winter hiking.

### **Soft Skills**

Soft skills complement hard skills. Being an excellent kayaker does not mean that an individual will be an effective OL. There has to be a balance between hard and soft skills. Soft skills are divided into the categories of instruction, organization and facilitation. Unfortunately, soft skill development is sometimes neglected.

### **DEFINITION OF AN OL**

An OL is an individual who leads groups and individuals into natural settings using a variety of modes of transportation such as hiking, mountain biking, canoeing, kayaking, mountaineering, etc. An OL must combine their hard skill competencies with soft skills in order to provide groups and individuals with a positive, safe and challenging outdoor experience. It is the responsibility of an OL to ensure the protection and preservation of the natural environments into which they bring people for an OAA.

---

## **CONFIRMATION OF TEACHING POINT 1**

---

### **QUESTIONS**

- Q1. What qualities should an OL possess in order to be effective?
- Q2. What type of leader is an OL?
- Q3. What are some examples of hard skills?

### **ANTICIPATED ANSWERS**

- A1. To be an effective OL, the leader should possess the following qualities:
- courage,
  - tenacity,
  - humility,
  - warmth,
  - enthusiasm,
  - integrity,
  - patience,
  - competency,
  - strength of character,
  - desire to be a leader,
  - humour, and
  - organizational skills.

A2. OLs are usually designated leaders because they are appointed due to their knowledge and experience in the activities being completed.

A3. Examples of hard skills are:

- canoeing,
- mountain biking,
- hiking,
- mountaineering,
- kayaking,
- rock climbing,
- caving,
- ice climbing,
- navigating,
- camping, and
- winter hiking.

---

**Teaching Point 2****Conduct an Activity Where the Cadet Will List and Discuss the Competencies of an OL**

Time: 40 min

Method: In-Class Activity

---

---

**BACKGROUND KNOWLEDGE**

---

**SELF-AWARENESS AND PROFESSIONAL CONDUCT****Being Self-Aware**

A competent OL needs to be self-aware. To be self-aware is to be conscious of one's character, feelings and motives. As an OL, who is responsible for the safety, well-being and organization of a group of people, being self-aware ensures a higher quality experience for all group members. Being aware of individual feelings and motives will allow the OL to better relate to their group members.

**Being Aware of One's Personal Abilities and Limitations**

Self-awareness starts with a clear understanding of one's personal abilities and limitations. Without a clear sense of their own abilities and limitations, OLs will have difficulty setting challenges appropriate to the abilities and limitations of group members. As well, there may be a tendency to set the bar too high, which may jeopardize the emotional and physical safety of the members of the group they are leading. This can result in the OL becoming a possible danger to the group and diminishing the quality of the experience for all.

**Being Mindful of All Actions**

Good OLs are always mindful – intentional – in their actions. They act with regard to the ultimate goals of the group experience, which is a balance between being attentive to the needs of the group members and being attentive to the tasks that must be accomplished.

## Managing Stress

Stress can be caused by a number of factors. While some may believe that stress caused by physical danger is the hardest to manage, this is not the case. Situations that place stress on the OL are often a lot less dramatic than a singular event such as a rope breaking during a climbing activity. The event happens so fast that adrenaline kicks in before stress can occur. Instead, it is the ordinariness of the situation which makes it so stressful. For example, a rainstorm catches a group 5 km (3 miles) away from the trailhead. Members force their own frustrations on the group leader, who not only has to deal with the group complaints, but also with the stream of rain running down the neck of their own parka.

## Demonstrating Professional Conduct

OLs are placed in a position of responsibility and as such must conduct themselves accordingly in all situations. A lack of professional conduct could result in situations such as an injury during a paddling activity, or a breakdown in group dynamics while on an OAA. It is the inherent risk associated with OAA that makes professional conduct so important for an OL. Professional conduct is characterized through demonstration of the following qualities:

- trustworthiness,
- flexibility,
- approachability,
- commitment,
- awareness of the position of authority, and
- modelling.

## CONFLICT MANAGEMENT

Conflicts in OAAs are inevitable. The challenge, for the OL, is to stop the conflict before it escalates, or deal with it quickly and effectively as possible. Most conflicts that occur in outdoor situations are a result of:

- weather conditions;
- varying levels of experience among group members;
- the challenging nature of the activity; and
- personalities of group members.

An OL who is able to communicate clearly with all group members will be better suited to manage conflict. There are always going to be situations where the OL is required to interact with difficult people. A group member who was a pleasure to have around at the beginning of a 10-day expedition, and who got along with everyone at the campsite, may, by Day 8, have blisters from ill-fitting boots and be arguing with everyone. It becomes the responsibility of the OL to deal with this situation. Conflict while on an expedition is like a wound: unless it is dealt with, it will just keep spreading and festering. Dealing with conflict is not a pleasant task, however, the first step is to always speak with the individual and discuss the issues in a calm and sensitive manner.

## DECISION MAKING AND JUDGMENT

**Decision Making.** Decision making is the process of choosing the best option from a collection of possible options. In order to make this choice, the OL will be required to use their judgment.

**Judgment.** Judgment is an informed opinion based on past experiences. Judgment also provides OLs with the ability to anticipate problems before they occur. Their experience in leading people during an OAA provides them the foresight to know when something is going well or when it needs adjustment.

OLs are placed in the position because of the experience they have. It is then assumed that when leading a group, they will be qualified to make decisions that affect the safety and welfare of the group. That is not to say that OLs have to make the “big” decisions on their own: being able to communicate with fellow group members and use their experience and ideas to help make a decision is also an integral part of making a decision. An OL, who has completed the same route up a mountain, may benefit from another individual’s point of view before deciding whether or not to continue an ascent, or halt due to a lack of motivation in group members.

Decision making is a process which should be carried out decisively. Once an OL has considered their options and reached a decision, they should stick with it, unless circumstances change. They should not allow themselves to be swayed by other group members. They have the experience, have assessed the factors and have reached a decision. In OAA, where safety is always a concern, the OL must have confidence in the decisions they make and the group must have confidence in the decisions the OL has made.

## **FACILITATION OF THE EXPEDITION EXPERIENCE**

Leading others in OAA does not guarantee that learning will occur. An outdoor experience can bring joy and wonder, and can help people develop new relationships and make discoveries. An outdoor experience encourages people to learn things about themselves, others and the outdoors.

It is possible to be outdoors and miss these opportunities or not enjoy the experience. Some participants do not want to learn in the outdoors:

- it feels unsafe in its newness;
- they have had previous negative experiences; or
- they are not interested in getting the most out of the experience.

An effective OL can facilitate the experience and shift the outdoor experience from a mere excursion in the outdoors to a dynamic learning experience.

Facilitation is the process of moving a group or individual toward a desired outcome. A facilitator provides the means for making experiences possible. For an OL, facilitation is a skill which fosters productive group dynamics, enabling all members to work toward completing the OAA, in a safe and enjoyable manner, while also developing interpersonal relationships.

OLs will often be required to:

- resolve conflicts;
- communicate effectively;
- foster personal trust and group cooperation; and
- debrief and guide reflection during and following an OAA.

## **TECHNICAL ABILITIES**

OLs may possess excellent facilitations skills and may be extremely effective at organizing an OAA, however, without technical ability to serve as the foundation for conducting the activity, these skills cannot be used. Technical abilities are organized into two main areas – generic competency skills and specific competencies.

### **Generic Competency Skills**

Generic competency skills are those skills in which, no matter the OAA, an OL must be competent. They include:

- weather prediction,
- wilderness first aid,

- trip planning,
- navigation,
- camp skills,
- general outdoor skills,
- physical fitness, and
- mental awareness.

### **Specific Competency Skills**

Specific competency skills are those skills unique to the OAA the OL will be leading. Examples include:

- trekking,
- mountain biking,
- abseiling,
- climbing,
- caving,
- canoeing, and
- kayaking.

There is no requirement for an OL to be an expert in all activities. In many cases they choose activities that interest them the most and capitalize on the experiences they offer. Proficiency in an OAA can only be gained through experience. The more experience OLs gain, the more competent they become.

OLs cannot allow their skills to decay; they should continuously participate in professional development training to refresh their knowledge and skills. It is the responsibility of the OL to stay up-to-date in the areas in which they lead others.

### **INSTRUCTIONAL TECHNIQUES**

Instructional skills are important because OLs often have the opportunity to teach and thus share important skills and knowledge with the people they lead. OLs with the responsibility of teaching others need to be well versed in skills such as using instructional aids, developing skill lesson plans and employing different teaching strategies. Experiential education is the primary method by which OLs deliver their educational content. Every lesson involves some degree of explanation and demonstration, and a greater degree of practice – which gives individuals the opportunity to learn skills in a hands-on manner.

### **ENVIRONMENTAL STEWARDSHIP**

Environmental stewardship is a three-faceted term that takes into account environmental ethics, ecological literacy and parks and protected areas management. With the environment experiencing the heavy impact of current culture, it is OLs who must alter the attitudes of others toward preserving and conserving the environment. When leading groups, OLs must practice and enforce the environmental ethical code, represented by the seven principles of Leave No Trace, which serve as the basis for ecologically responsible interactions with the natural environment.

Ecological literacy entails thinking and acting critically in an environmental context, especially when making decisions and exercising judgment regarding environmental problems.

Many of the areas OLs use to conduct OAAs are managed by provincial and national agencies. It is critical that OLs are aware of the policies and regulations of the park/conservation area they are using and abide by these rules. The park/conservation area has implemented these policies and regulations as a means to reduce the

environmental impact while still allowing people to enjoy the outdoor setting. OLs must understand that every action has the potential to impact the natural environment and that they must take the necessary precautions to protect the environment when travelling or camping outdoors. As well, they must teach low-impact camping, waste management and travelling techniques to their groups.

## **PROGRAM MANAGEMENT**

Program management consists of two main areas – employing safety and risk management, and planning, organizing and managing. OAAs are, for the most part, characterized by the inherent risk they possess. Risk is one of the critical components that make outdoor programming so popular and successful. OLs must be able to balance risk and safety – too much risk and the danger of the experience will become unreasonable; too much safety and the activity will fail to remain adventurous. As an OL, there is a responsibility to assess the OAA for risk, manage risk during the activity and develop a contingency plan to ensure the safety of all participants. Most aspects of risk management are carried out during the planning phase of an activity.

OLs are required to complete detailed planning for trips/activities they lead. Proper planning is essential for any OAA and when it is not carried out thoroughly, the possibility for tragedy increases. Trip/activity plans include:

- emergency management details,
- contingency plans,
- time control plans,
- energy control plans,
- ration plans,
- communication plans, and
- equipment/resource procurement, etc.

Once a plan has been developed, the ability to implement the plan is based on the OL's organizational skills. Implementation involves creating a system for getting tasks done and requires the ability to coordinate the various components of the plan so that it comes together to create a unified whole.

Management skills involve the ability of the OL to direct the group in an efficient manner to complete all required tasks throughout the OAA. For example, when arriving at the campsite, after a long day of paddling, an organized OL will have already divided the group into sub-groups to allow for multi-tasking to ensure the campsite is set up, water is collected, the fire is started and supper is prepared.



---

**ACTIVITY**

---



A cooperative learning strategy called a jigsaw structure will be used for this activity.

A jigsaw structure allows each cadet, as a member of a team, to become an “expert” in their part of the assignment. They do this by developing communication strategies that will allow them to interpret information they receive, both on their own and as a contributing member of a team, and by presenting the information as a response.

Each cadet in a team will receive the information to complete only their part. The cadets who are responsible for the same part join together and form a new, temporary expert team whose purpose is to master the ideas in their part and to develop strategies for communicating/presenting what they have learned to the other cadets in their original team.

Cadets must work together to accomplish a common goal which means that each cadet’s part, and each cadet, is essential. This structure encourages teamwork and it requires the cadets to be actively engaged in the process. It facilitates the development of a depth of knowledge not possible when learning material individually.

There are high expectations and responsibilities placed on each cadet in the jigsaw structure, therefore sufficient time should be taken to explain the process and requirements before beginning the activity as some cadets may find it to be complex.



For the purpose of this activity, there will be two sets of teams formed (as described in the activity instructions):

- jigsaw teams, and
- temporary expert teams.

Refer to Figure 15-2-1 for a visual representation of the format for these teams using six cadets per jigsaw team.

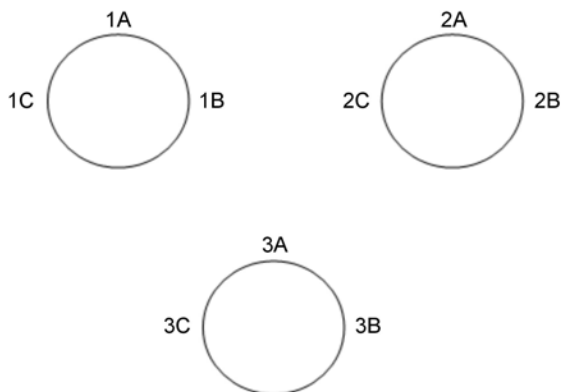
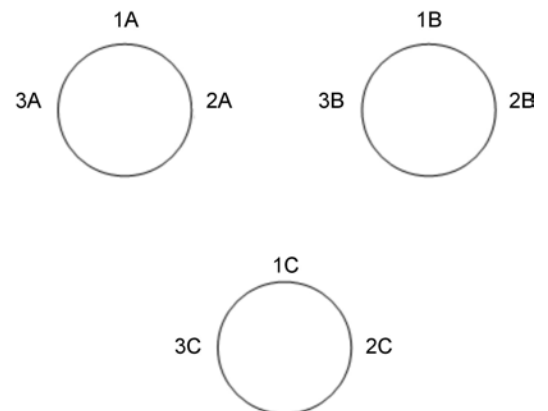
**JIGSAW TEAMS**

**TEMPORARY EXPERT TEAMS**

*Director Cadets 3, 2008, Ottawa, ON: Department of National Defence*

Figure 15-2-1 Format of Jigsaw Activity Groups

15-M325.02-11

---

## ACTIVITY

---

### OBJECTIVE

The objective of this activity is to have the cadets list and discuss the competencies of an OL.

### RESOURCES

- Scenario (located at Annex A),
- Competencies of an OL information cards (located at Annexes B to D),
- Expert activity sheets (located at Annex E),
- Competencies of an OL handout (located at Annex F),
- Pen/pencil, and
- Notebook.

### ACTIVITY LAYOUT

Arrange the classroom for group work.

### ACTIVITY INSTRUCTIONS



To facilitate this activity there should be three groups, with at least three cadets in each group. In situations where there are more than three cadets, assign two cadets the same information card. In situations where there are less than nine cadets in the class, divide the cadets into two groups and have each group discuss three of the six competencies. Then have each group present their material. Timings will remain the same.

1. Explain the following to the cadets:
  - (a) they will be participating in a jigsaw activity about the competencies of an OL, in which each member of their team will be responsible for 2–3 different competencies;
  - (b) they will be divided into jigsaw teams of three cadets, and each cadet will be given a competencies of an OL information card and scenario to review and a worksheet to guide them through the activity;
  - (c) after reviewing the scenario and their competencies of an OL information card, cadets will then form temporary expert teams by regrouping with the cadets from the other jigsaw teams who have the same competencies of an OL information card they do;
  - (d) temporary expert teams will work together to complete their expert activity sheets and develop a strategy to present the information to their jigsaw teams; and
  - (e) they will return to their jigsaw teams and take turns presenting information about their competencies and will note key points while other members are presenting.
2. Distribute the scenario to each cadet.
3. Divide the cadets into equal jigsaw teams of three, creating a maximum of three teams. Groups should be as heterogeneous as possible in terms of ability.
4. Appoint one cadet in each team to be the leader.
5. Distribute the competencies of an OL information cards to each group.

6. Each group member will select one of the three information cards (A to C); each card includes information on two or three competencies.
7. Provide cadets five minutes to read through the scenario and their information cards.
8. Have cadets form temporary expert teams by regrouping with the cadets from the other jigsaw teams who have the same information card they do.
9. Distribute expert activity sheets to each expert team.
10. Provide cadets 15 minutes to discuss and complete their activity sheets and develop a strategy to present the information back in their jigsaw team.



It is not uncommon in jigsaw activity for a confident cadet to dominate the conversation or try to control the group; ensure all cadets are contributing.

11. Circulate among the groups and assist the cadets as necessary, offering suggestions and advice for improvement.
12. Have cadets return to their jigsaw teams.
13. Provide cadets 20 minutes to present information gathered in their expert team to the members of their jigsaw team, under the direction of the group leader.
14. Debrief the cadets.
15. Distribute competencies of an OL handout.

### **SAFETY**

N/A.

---

### **CONFIRMATION OF TEACHING POINT 2**

---

The cadets' participation in the in-class activity will serve as the confirmation of this TP.

---

### **END OF LESSON CONFIRMATION**

---

The cadets' participation in the in-class activity will serve as the confirmation of this lesson.

---

### **CONCLUSION**

---

### **HOMEWORK/READING/PRACTICE**

Distribute homework assignment located at Annex G. Cadets will be required to complete and hand in the assignment for the next training session.

### **METHOD OF EVALUATION**

N/A.

## CLOSING STATEMENT

OLs are a critical aspect of the army cadet adventure training program. The presence of knowledgeable, conscientious OLs during cadet activities will influence the safety and success of the activity. The competencies of an OL are the skills and ideals which can be learned but must be practiced in order to master.

## INSTRUCTOR NOTES/REMARKS

N/A.

---

## REFERENCES

---

- C2-150 (ISBN 0-89886-502-6) Graham, J. (1997). *Outdoor Leadership: Technique, Common Sense and Self-Confidence*. Seattle, WA: The Mountaineers.
- C2-151 (ISBN 0-7360-4709-3) Gilbertson, K., Bates, T., McLaughlin, T., & Ewert, A. (2006). *Outdoor Education: Methods and Strategies*. Windsor, ON: Human Kinetics.
- C2-152 (ISBN 1-898555-09-5) Ogilvie, K. (1993). *Leading and Managing Groups in the Outdoors: New Revised Edition*. Cumbria, England: The Institute for Outdoor Learning.
- C2-153 (ISBN 0-7360-5731-5) Martin, B., Cashel, C., Wagstaff, M., & Breunig, M. (2006). *Outdoor Leadership: Theory and Practice*. Windsor, ON: Human Kinetics.
- C2-154 (ISBN 0-87322-637-2) Priest, S., & Gass, M. (1997). *Effective Leadership in Adventure Programming*. Windsor, ON: Human Kinetics.



**ROYAL CANADIAN ARMY CADETS**  
**SILVER STAR**  
**INSTRUCTIONAL GUIDE**



**SECTION 3**

**EO M325.03 – DISCUSS SELF-AWARENESS AND PROFESSIONAL  
 CONDUCT AS A COMPETENCY OF AN OUTDOOR LEADER (OL)**

---

Total Time: 30 min

---

**PREPARATION**

---

**PRE-LESSON INSTRUCTIONS**

Resources needed for the delivery of this lesson are listed in the lesson specification located in A-CR-CCP-703/PG-001, Chapter 4. Specific uses for said resources are identified throughout the instructional guide within the TP for which they are required.

Review the lesson content and become familiar with the material prior to delivering the lesson.

Photocopy the scenario located at Annex H for each cadet.

**PRE-LESSON ASSIGNMENT**

N/A.

**APPROACH**

A group discussion was chosen for TP 1 as it allows the cadet to interact with their peers and share their knowledge, opinions and feelings about self-awareness.

An interactive lecture was chosen for TP 2 to orient the cadet to professional conduct as a competency of an OL.

---

**INTRODUCTION**

---

**REVIEW**

The review for this lesson is from EO M325.02 (List the Competencies of an Outdoor Leader [OL], Section 2):

**QUESTIONS**

- Q1. What is an OL?
- Q2. What are the eight competencies of an OL?

**ANTICIPATED ANSWERS**

- A1. An OL is an individual who leads groups and individuals into natural settings using a variety of modes of transportation such as hiking, mountain biking, canoeing, kayaking, mountaineering, etc. OLs must combine their technical skill competencies with personal and interpersonal skills in order to provide groups and individuals with a positive, safe and challenging outdoor adventure activity (OAA). It is the

responsibility of an OL to ensure the protection and preservation of the natural environments into which they bring people for an OAA.

A2. The eight competencies of an OL are:

- self-awareness and professional conduct,
- conflict management,
- decision making and judgment,
- facilitation of the expedition experience,
- technical abilities,
- instructional techniques,
- environmental stewardship, and
- program management.

## OBJECTIVES

By the end of this lesson the cadet shall have discussed self-awareness and professional conduct as a competency of an OL.

## IMPORTANCE

It is important for cadets to further investigate the OL competency of self-awareness and professional conduct because as a new OL this competency shapes their daily experiences as an OL. Being cognizant of personal behaviour and how an individual presents themselves to others is an important aspect of being a leader. The inherent risk associated with outdoor activities adds to the importance of an OL acting appropriately while leading groups.

---

### Teaching Point 1

### Conduct a Group Discussion on Self-Awareness

Time: 15 min

Method: Group Discussion

---

---

## BACKGROUND KNOWLEDGE

---



The point of the group discussion is to draw the following information from the group using the tips for answering/facilitating discussion and the suggested questions provided.

## DEFINING WHAT IT MEANS TO BE SELF-AWARE

To be self-aware is to be conscious of one's character, feelings and motives. As an OL, who is responsible for the safety, well-being and organization of a group of people, being self-aware helps to ensure a high quality experience for all group members. Being aware of individual feelings and motives will help the OL relate to their group members.

### Being Mindful of All Actions

Good OLs are always mindful of their actions and deliberate in their intent. They act with regard to the ultimate goals of the group, which is a balance between being attentive to the needs of the group members and being attentive to the tasks that must be accomplished.

### **Being Aware of One's Personal Abilities and Limitations**

Self-awareness starts with a clear understanding of one's personal abilities and limitations. Without a clear sense of their own abilities and limitations, OLs will have difficulty setting challenges appropriate to the abilities and limitations of group members. As well, there may be a tendency to set the bar too high, which may jeopardize the emotional and physical safety of the members of the group they are leading. This can result in the OL becoming a possible danger to the group and diminishing the quality of the experience for all.

### **Knowing How One Influences Others**

An OL is considered the expert when they lead a group of people on an OAA. They have been chosen because of their experience and knowledge in the specific activity being conducted. This is an enormous responsibility. This position provides them the opportunity to influence the decisions and actions of the people they are leading. Being aware of this is a very important step in OLs developing their own self-awareness. Once they understand how their actions and comments can influence those around them, they will be able to judge what is appropriate and what is not.

### **Understanding the Importance of Demonstrating Commitment to the Activity**

An OL is committed when they participate fully in all aspects of the activity they are leading. The OL must commit their "mind, body and soul" to themselves, the people they are leading, the OAA they are completing and the environment they are using.

If an OL is not committed to the activity which they are leading, then the activity is doomed to fail. This commitment can be demonstrated verbally, through the actions of the OL and/or by their overall behaviour and presence. The OL who chooses to sit around the campfire after a long day of hiking to discuss the day's events, demonstrates a commitment to the activity by continuing the learning experience of the group. Likewise, the OL who displays excitement for the day of rock climbing shows a strong commitment to the activity. When the OL is committed to the activity, the group members will be committed to the activity.

### **Knowing How One Reacts to Different Situations**

An OL must always be prepared to react to the unexpected. To do this, it is important for OLs to know how they will react when faced with different situations. In most cases, this understanding will come from experience. However, developing strategies to implement when faced with an unlikely or challenging situation will assist the OL in facing the situation head-on with strength and confidence.

Examples of these different challenges the OL may face are:

- danger,
- hardship,
- stress,
- conflict, and
- fatigue.

### **Understanding the Importance and Benefits of Personal Reflection**

A good OL will take the time to learn from their successes and their mistakes. This process is called experiential learning, and can be described as the change in a person that results from reflection on a direct experience resulting in new understandings and applications. In practical terms, this process involves taking the time to sit down after an experience and think about how it went. The OL should ask themselves the following questions:

- What did I do well?
- What can I improve upon?

- How did people react to my leadership style?
- What can I learn from the way other OLs did things?

By thinking about past experiences, the OL can learn by experience and can start to think about ways they will do things in the future. When the next opportunity to confront a similar situation arises, the lessons learned – from taking the time to reflect on the past—will be drawn on to improve the way the OL deals with the new, but similar, experience. In many ways this is the same process as learning to ride a bicycle; from every success and every mistake the cadet learns something new, eventually allowing the training wheels to be removed.

---

### GROUP DISCUSSION

---



#### TIPS FOR ANSWERING/FACILITATING DISCUSSION:

- Establish ground rules for discussion, eg, everyone should listen respectfully; don't interrupt; only one person speaks at a time; no one's ideas should be made fun of; you can disagree with ideas but not with the person; try to understand others as much as you hope they understand you; etc.
- Sit the group in a circle, making sure all cadets can be seen by everyone else.
- Ask questions that will provoke thought; in other words avoid questions with yes or no answers.
- Manage time by ensuring the cadets stay on topic.
- Listen and respond in a way that indicates you have heard and understood the cadet. This can be done by paraphrasing their ideas.
- Give the cadets time to respond to your questions.
- Ensure every cadet has an opportunity to participate. One option is to go around the group and have each cadet answer the question with a short answer. Cadets must also have the option to pass if they wish.
- Additional questions should be prepared ahead of time.

#### SCENARIO

Consider the following scenario:



It's your third time out as a trip leader [OL] and you're taking a bunch of beginners up an easy trail to Mosquito Lake. Your group is moving a little slower than you'd like, but the weather is fair and the wildflowers are out; you figure it'll be OK to cook dinner in the dark if you have to.

Suddenly, black clouds begin to pour over a ridge to the west, and within minutes a summer storm is bearing down on you. The first drops of rain are so big they kick up dust on the trail. Lightning forks behind the peaks above and the crash of thunder is so loud and near, you know the storm center will be on top of you in minutes.

You've just started up a long exposed ridge. If you continue up, the danger of being hit by lightning could be significant, and even if it isn't, the chance that someone will panic in a storm this big is very real. But if you head down into the forest below, you'll never make it to the lake before dark; you'll have to camp lower, and you're not sure of the water supply there.

Up until now there has been no need for anyone to 'lead' on this easy, well-travelled trail. But now things have changed. This is Ben's first trip into the mountains. He is clearly getting more worried with each flash of lightning (Graham 1997, 15–16).

### SUGGESTED QUESTIONS

- Q1. What does it mean to be self-aware?
- Q2. What are the abilities and limitations of the OL in the scenario?
- Q3. What are some examples of how the OL in the scenario demonstrates commitment to the hike?
- Q4. How will knowing how one reacts to situations of danger and stress benefit the OL in the scenario?
- Q5. In the scenario Ben, an inexperienced hiker, is getting very nervous about the situation facing the hikers. What can the OL do to alleviate some these fears?
- Q6. Upon completion of the hike, why is it important that the OL, and group members, complete a personal reflection?
- Q7. What is the relationship between being self-aware and being an effective OL?



Other questions and answers will develop throughout the group discussion. The group discussion should not be limited to only those suggested.



Reinforce those answers given and comments made during the group discussion, ensuring the teaching point has been covered.

---

### CONFIRMATION OF TEACHING POINT 1

---

The cadets' participation in the group discussion will serve as the confirmation of this TP.

**Teaching Point 2****Discuss Professional Conduct**

Time: 10 min

Method: Interactive Lecture



This TP provides cadets an opportunity to further develop their understanding of professional conduct which is a component of the OL competency of self-awareness and professional conduct.

**PROFESSIONAL CONDUCT**

OLs are placed in a position of responsibility and as such must conduct themselves accordingly in all situations. A lack of professional conduct could result in an injury during a paddling activity or a breakdown in group dynamics while on an expedition, etc. The risks associated with an OAA demand professional conduct of an OL.

An OL who demonstrates professional conduct is typically viewed as being:

- flexible,
- responsible,
- trustworthy,
- courageous,
- hardworking,
- selfless,
- approachable,
- committed, and
- tolerant.

**USING THE POSITION RESPONSIBLY**

Cadets are placed in the position of an OL because of their experience. This position does not permit them to use their authority in unethical ways. In the environment of an OAA, OLs who abuse their position of authority have a negative impact on group morale and effectiveness, and can make dangerous situations even more dangerous.

The experience that OLs have is what makes them such a valuable asset to the group. However, it is important that OLs understand that in most cases the individuals they are leading do not have as much experience as they do. It is one thing to encourage an individual to try something new, such as a slightly more difficult rock climbing ascent, but an OL should never force an individual to do something they are not comfortable doing; it is extremely unprofessional and risky. Forcing an individual to abseil down a cliff by telling them they will not get their supper meal is a form of coercion. If that individual hurts themselves or another group member, the consequences in an outdoor setting could be dramatic. Coercion shall never be an option.



Coercion is the process of persuading an unwilling person by force.

**MODELLING ACTIONS WHICH THE TEAM SHOULD EMULATE**

An OL should always model the behaviour which they want their team/group to emulate.

## Committing Personally

If an OL is not personally committed to being an OL it will be obvious to the individuals they are leading. Being an OL is more than just about taking individuals into the outdoors; it is about providing them an experience and the opportunity to learn from that experience. An OL who is not personally committed to the activity and the people involved in the activity will be an ineffective leader. The hazardous nature of activities led by OLs requires their complete attention and commitment. To not give an activity their full attention and commitment OLs are putting themselves and the people they are leading at risk.

## Complying With Safety Regulations and Precautions

Safety regulations and precautions are established by subject matter experts to ensure the safety of individuals completing the specific OAA. While many OLs are very experienced, it is not their prerogative to change/alter predetermined safety regulations and precautions. Failing to abide by safety regulations and precautions could result in injuries which are compounded when in an isolated wilderness setting. Although it may seem redundant to hang food in a food hang every night, even if the group has not seen one bear, not doing so is a risk that should not be taken. Likewise, wearing a PFD while paddling on a flatwater lake may seem unnecessary, however, accidents can happen and wearing that PFD could save a life.

---

## CONFIRMATION OF TEACHING POINT 2

---

### QUESTIONS

- Q1. An OL who demonstrates professional conduct typically displays what qualities?
- Q2. What are two examples of ways in which an OL can abuse their position of authority?
- Q3. Why is it important for OLs to comply with safety regulations and precautions?

### ANTICIPATED ANSWERS

- A1. The following qualities are typically displayed by an OL who demonstrates professional conduct:
- flexible,
  - responsible,
  - trustworthy,
  - courageous,
  - hardworking,
  - selfless,
  - approachable,
  - committed, and
  - tolerant.
- A2. The following is a list of three possible examples of ways in which an OL has abused their position of authority are:
- have group members set up and tear down their tent;
  - have group members cook meals for the OL; or
  - have group member pump water for the OL each night.

- A3. Failing to abide by safety regulations and precautions could result in injuries which are compounded when in an isolated wilderness setting.

---

**END OF LESSON CONFIRMATION**

---

**QUESTIONS**

- Q1. What does it mean to be self-aware?
- Q2. Why is it important for an OL to be aware of their own abilities and limitations?
- Q3. What are the consequences of an OL not being personally committed to the activity being completed?

**ANTICIPATED ANSWERS**

- A1. To be self-aware is:
- being conscious of one's character, feelings and motives;
  - ensuring a high quality experience for all group members; and
  - being aware of individual feelings and motives in order to relate to group members.
- A2. Without a clear sense of their own abilities and limitations, OLs will have difficulty setting challenges appropriate to the abilities and limitations of the program participants. As well, there may be a tendency to set the bar too high, which may jeopardize the emotional and physical safety of the members of the group they are leading. This can result in the OL becoming a possible danger to the group and diminishing the quality of the experience for all.
- A3. An OL who is not personally committed to the activity and the people involved in the activity will be an ineffective leader and will put themselves and the people they are leading at risk.

---

**CONCLUSION**

---

**HOMEWORK/READING/PRACTICE**

N/A.

**METHOD OF EVALUATION**

N/A.

**CLOSING STATEMENT**

Self-awareness and professional conduct is a fundamental competency of an OL. This competency deals with the OL's ability to interact and develop relationships with the people they are leading. While technical, instructional and facilitation skills are all competencies of an OL, without a personal understanding of oneself and the ability to act in a professional manner, these skills are useless. An OL must develop the whole package of competencies, beginning with self-awareness and professional conduct.

**INSTRUCTOR NOTES/REMARKS**

N/A.

---

**REFERENCES**

---

- C2-150 (ISBN 0-89886-502-6) Graham, J. (1997). *Outdoor Leadership: Technique, Common Sense and Self-Confidence*. Seattle, WA: The Mountaineers.
- C2-152 (ISBN 1-898555-09-5) Ogilvie, K. (1993). *Leading and Managing Groups in the Outdoors: New Revised Edition*. Cumbria, England: The Institute for Outdoor Learning.
- C2-153 (ISBN 0-7360-5731-5) Martin, B., Cashel, C., Wagstaff, M., & Breunig, M. (2006). *Outdoor Leadership: Theory and Practice*. Windsor, ON: Human Kinetics.

THIS PAGE INTENTIONALLY LEFT BLANK



**ROYAL CANADIAN ARMY CADETS**  
**SILVER STAR**  
**INSTRUCTIONAL GUIDE**



**SECTION 4**

**EO C325.01 – COMMUNICATE DURING AN EXPEDITION**

---

Total Time:	120 min
-------------	---------

---

**PREPARATION**

---

**PRE-LESSON INSTRUCTIONS**

Resources needed for the delivery of this lesson are listed in the lesson specification located in A-CR-CCP-703/PG-001, Chapter 4. Specific uses for said resources are identified throughout the instructional guide within the TP for which they are required.

Review the lesson content and become familiar with the material prior to delivering the lesson.

Ensure that all hand-held radios are ready to use (serviceable, batteries fully charged).

Review the owners' manual associated with the hand-held radio being used.

Photocopy Annex I (one per cadet) and Annex J (one per group).

**PRE-LESSON ASSIGNMENT**

N/A.

**APPROACH**

An interactive lecture was chosen for TPs 1–3 and TP 7 to introduce communicating using basic voice procedures, familiarizing the cadet with the parts of the hand-held radio and alternative methods of emergency communication.

Demonstration and performance was chosen for TPs 4–6 as it allows the instructor to demonstrate and explain the communication skills the cadet is expected to acquire, while providing an opportunity for the cadet to practice basic voice procedures, transmitting messages over a radio net, and using alternative methods of communication under the supervision of an instructor.

A practical activity was chosen for TP 8 as it is an interactive way to for the cadet to practice communicating with a hand-held radio using basic voice procedures and transmitting a message using an alternative method of communication. This activity contributes to the cadets' development of communication skills in a fun and challenging setting.

---

**INTRODUCTION**

---

**REVIEW**

N/A.

## OBJECTIVES

By the end of this lesson the cadet shall be expected to communicate during an expedition by operating a hand-held radio and employing an alternative emergency communication method to transmit the Morse code message, Save Our Souls (SOS).

## IMPORTANCE

It is important for cadets to know how to operate hand-held radios in order to communicate between groups during expeditions. As an outdoor leader there will be a requirement for cadets to operate radios as part of daily responsibilities, as well as in emergency situations. Due to the nature of the expedition activities and the remote locations in which they occur, knowing how to communicate is critical for the safety of all group members.

---

### Teaching Point 1

### Explain the Elements of Radio Etiquette

Time: 5 min

Method: Interactive Lecture

---



The information presented in this TP is an introduction to elements of radio etiquette. The cadets may have some previous knowledge of the material. Ask lead-in questions to gain their insight.

## APPROPRIATE LANGUAGE

The way that one talks on the air is guided by national and international standards. These standards are termed voice procedure.

Voice procedure is intended to maximize clarity and reduce misunderstanding in spoken communication. One must follow basic radio rules, to include:

- Avoid sending transmissions without proper authority.
- Avoid transmissions using the operator's name.
- Never use profane, indecent or obscene language.
- Allow emergency calls to take priority over all other calls. If a person is talking, stop and wait until the emergency is finished.
- Keep communications official. Do not chat.

## ENUNCIATION

Enunciation is the act of speaking clearly. When making transmissions, each message will be as short as possible and should not exceed 10 seconds in length. To reduce the possibility of confusion while transmitting, subject matter should be kept to one topic.

When sending a transmission via radio it is important to pronounce words clearly and concisely. Before transmitting, wait for a period long enough so as not to interfere with transmissions already in progress. To ensure the message is received clearly, follow these tips:

- Speak slowly.
- Write down the message prior to transmitting (if it is lengthy).
- Hold the PTT button one second before and after speaking, to ensure the entire message was heard.



- Transmit only what is needed.
- Refrain from using slang terms.

## NO DUFFS

No Duff is the term spoken over the radio to identify that what is being said is not a drill. This term is only spoken during emergency situations when serious information has to be passed along. It shall never be used as part of an exercise or as a joke. Upon hearing No Duff, all radio communications will cease between parties. Normal communications may continue when the sender of No Duff has ended the transmission.

## CONFIRMATION OF TEACHING POINT 1

### QUESTIONS

- Q1. What are two basic radio rules?
- Q2. What should be the maximum length of a transmission?
- Q3. When sending transmissions, how should words be pronounced?

### ANTICIPATED ANSWERS

- A1. The basic radio rules are:
- Avoid sending transmissions without proper authority.
  - Avoid using the operator's name.
  - Never use of profane, indecent or obscene language.
  - Allow emergency calls to take priority over all other calls. If a person is talking, stop and wait until the emergency is finished.
  - Keep communications official. Do not chat.
- A2. Each message will be as short as possible, and should not exceed 10 seconds.
- A3. Pronounce words clearly and concisely.

### Teaching Point 2

### Describe the Phonetic Alphabet

Time: 10 min

Method: Interactive Lecture



Distribute the handout at Annex I to the cadets. As the information is presented have the cadets follow the handout. Have the cadets repeat the alphabet and numbers as they are presented.

## PHONETIC ALPHABET

### Purpose

Radios are usually used outdoors and are sometimes subject to background noise such as inclement weather, equipment, and other people. For this reason, the use of the International Phonetic Alphabet is required. The phonetic alphabet associates the letters of the alphabet with a word to assist in clarifying statements over a radio.

## Uses

The phonetic alphabet is used whenever isolated letters or groups of letters are pronounced separately, when spelling words, or when communication is difficult.

## Structure

The following table identifies the phonetic symbol and its corresponding pronunciation.

Letter	Phonetic	Pronunciation	Letter	Phonetic	Pronunciation
A	ALFA	<u>AL</u> FAH	N	NOVEMBER	NO <u>VÈM</u> BER
B	BRAVO	<u>BRAH</u> VOH	O	OSCAR	<u>OSS</u> CAR
C	CHARLIE	<u>CHAR</u> LEE	P	PAPA	PAH <u>PAH</u>
D	DELTA	<u>DELL</u> TAH	Q	QUEBEC	KÉH <u>BECK</u>
E	ECHO	<u>ECK</u> OH	R	ROMEO	<u>ROW</u> ME OH
F	FOXTROT	<u>FOKS</u> TROT	S	SIERRA	SEE <u>AIR</u> RAH
G	GOLF	GOLF	T	TANGO	<u>TANG</u> GO
H	HOTEL	HOH <u>TÈLL</u>	U	UNIFORM	<u>YOU</u> NEE FORM
I	INDIA	<u>IN</u> DEE AH	V	VICTOR	<u>VIK</u> TAR
J	JULIETT	<u>JEW</u> LEE ÈTT	W	WHISKEY	<u>WISS</u> KEY
K	KILO	<u>KEY</u> LOH	X	X-RAY	<u>ECKS</u> RAY
L	LIMA	<u>LEE</u> MAH	Y	YANKEE	<u>YANG</u> KEY
M	MIKE	<u>MÍ</u> KE	Z	ZULU	<u>ZOO</u> LOO



Spell the word CADETS using the phonetic alphabet: CHARLIE – ALFA – DELTA – ECHO – TANGO – SIERRA.

## Pronunciation of Numerals

When numbers are used in a radio transmission, they are always spoken as separate numbers digit by digit, (15 is spoken as ONE–FIFE) except multiples of a thousand, which may be spoken. The procedural word FIGURES can be used before transmitting such numbers.

The table identifies the number and its corresponding pronunciation.

Number	Pronunciation		Number	Pronunciation
0	ZE-RO		5	FIFE
1	WUN		6	SIX
2	TOO		7	SEV-EN
3	TREE		8	AIT
4	FOW-ER		9	NIN-ER



Have the cadets recite the entire alphabet using phonetic pronunciations.

---

### CONFIRMATION OF TEACHING POINT 2

---

#### QUESTIONS

- Q1. What is used to spell words over a radio?  
 Q2. How is the figure five spoken over the radio?  
 Q3. Using the phonetic alphabet, how would you spell radio?

#### ANTICIPATED ANSWERS

- A1. The phonetic alphabet is used to spell words over a radio.  
 A2. The figure five is spoken "FIFE" over the radio.  
 A3. Radio would be spelled as follows: ROMEO–ALFA–DELTA–INDIA–OSCAR.

---

#### Teaching Point 3

#### Identify and Briefly Describe the Parts of a Hand-Held Radio

Time: 5 min

Method: Interactive Lecture

---



Radios presented in this lesson are the Talkabout FRS/GMRS Recreational Two-Way Radio Models T5000, T5500, and T5550. Models may vary. Refer to the manufacturer's owners' manual as required.



Divide cadets into groups of no more than four and assign each group a radio. Cadets will point to the specific parts as they are explained.

## PARTS OF THE HAND-HELD RADIO AND THEIR FUNCTIONS

**On-Off/Volume Knob.** Controls volume and power to the unit.

**Light Emitting Diode (LED).** This light will be illuminated when the radio is on.

**Push-to-Talk Button (PTT).** A depressible button that allows transmissions.

**Speaker.** Converts electric current into audible sound.

**Antenna.** An electrical device designed to transmit or receive radio waves.

**Accessory Jack.** Used to insert accessory items such as a headset.

**Menu Scroll/Channel/Frequency Selector.** Push to scroll through the menu options and channels. Use the “+” and “-” symbol in order to scroll through the menu options.

**Microphone.** Converts sound into an electrical signal.

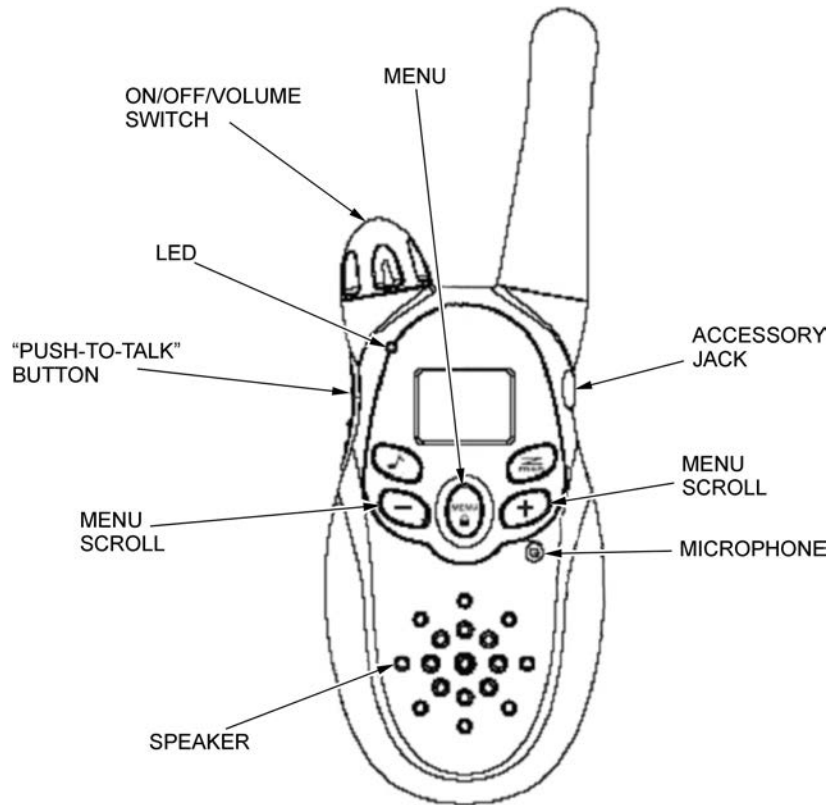

*Motorola, Inc. Talkabout FRS/GMRS Recreational Two-Way Radios Models T5000, T5500, T5550 User's Guide, Motorola, Inc. (p. 11)*

Figure 15-4-1 Hand-Held Radio

**Battery Cover.** Covers the storage compartment of the battery (located on the reverse side of the radio).

**Battery Cover Latches.** Secures the cover to the radio (located on the reverse side of the radio).

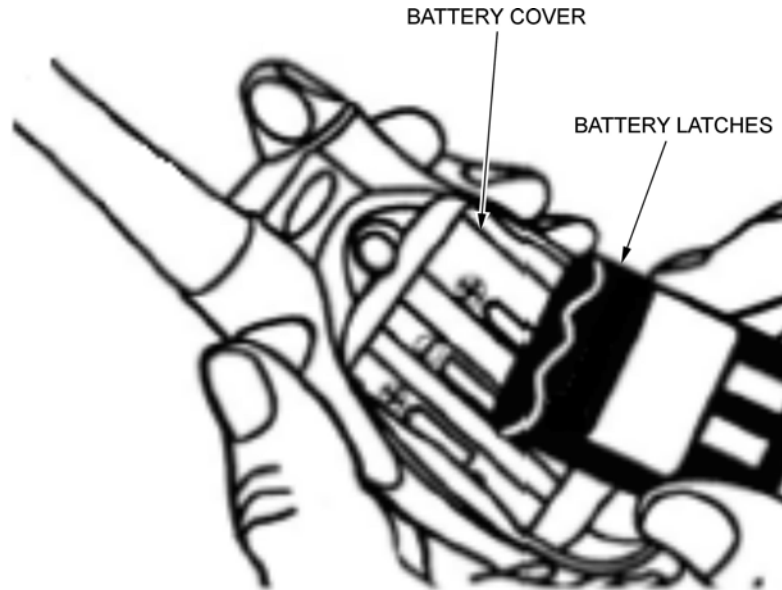

Motorola, Inc. Talkabout FRS/GMRS Recreational Two-Way Radios Models T5000, T5500, T5550 User's Guide, Motorola, Inc. (p. 13)

Figure 15-4-2 Battery Compartment

---

### CONFIRMATION OF TEACHING POINT 3

---

#### QUESTIONS

- Q1. Name the parts of the radio.  
 Q2. What function does the antenna perform?  
 Q3. What function does the microphone perform?

#### ANTICIPATED ANSWERS

- A1. The 10 parts of the Talkabout radio are: on-off / volume knob, LED, PTT, speaker, antenna, accessory jack, menu scroll, microphone, battery cover, and battery cover latches.  
 A2. The antenna transmits and receives radio waves.  
 A3. The microphone converts sound into an electrical signal.

---

#### Teaching Point 4

**Explain, Demonstrate and Have the Cadet Practice Using a Hand-Held Radio**

Time: 15 min

Method: Demonstration and Performance

---



For this TP, it is recommended that instruction take the following format:

1. Explain and demonstrate each skill while cadets observe.
2. Monitor the cadets' performance as they practice each skill.

**Note:** Assistant instructors may be employed to monitor the cadets' performance.

## TURNING THE RADIO ON/OFF

To turn the radio ON, turn the on-off/volume knob clockwise. The radio will beep and the radio display will briefly show all feature icons on the radio.

To turn the radio OFF, turn the on-off/volume knob counter-clockwise. A clicking sound will indicate that the radio is turned off.

## ADJUSTING FREQUENCIES

### Selecting a Channel (Frequency)

The radio operates on a group of frequencies that are accessed through radio channels. To set the channel of the radio, push the Menu button, which will cause the current channel to flash. Using the Menu scroll button, scroll through the channels and push the PTT button to select the desired channel.

## OPERATING THE PTT BUTTON

To send and receive messages, check the channel activity by pressing the monitor (MON) button. Static will be heard if the channel is clear to use. Do not transmit if someone is talking on the channel.

To send messages:

1. Press the PTT button.
2. Observe a standard pause.
3. Speak loudly, clearly and briefly into the microphone.
4. Release the PTT button (to maximize clarity, hold the radio 3–5 cm from the mouth).

The LED will glow continuously when sending messages.

In order to listen to messages, the PTT button must be fully released.

## CHANGING THE BATTERIES



Explain to the cadets the type of battery required to operate the hand-held radio. Consult the owner's manual to ensure the proper size and type of battery is being used. The Talkabout radios discussed in this lesson use three AA batteries.

Many hand-held radios will use three AA batteries for power. In order to install the batteries or to replace them, follow these steps:

1. Lift the battery latch to release the battery cover.
2. Remove the battery cover.
3. Insert three AA batteries as shown on the inside of the battery compartment.
4. Replace the battery cover and clip the battery latch to secure.
5. Discard spent batteries safely.

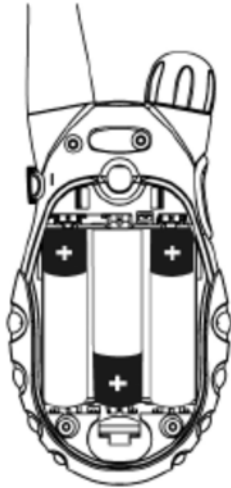

Motorola, Inc. *Talkabout FRS/GMRS Recreational Two-Way Radios Models T5000, T5500, T5550 User's Guide*, Motorola, Inc. (p. 13)

Figure 15-4-3 Batteries



Motorola, Inc. *Talkabout FRS/GMRS Recreational Two-Way Radios Models T5000, T5500, T5550 User's Guide*, Motorola, Inc. (p. 13)

Figure 15-4-4 Changing the Batteries



Batteries may corrode over time if left in radios and can cause permanent damage; therefore, they should be removed before storing radios for extended periods of time.

Batteries are made of various materials comprised of heavy metals including nickel cadmium, alkaline, mercury, nickel metal hydride, and lead acid. These elements can harm the environment if not properly discarded. As such, batteries are one of the most complex items to dispose of or recycle.

Batteries, if not properly disposed of, may cause:

- pollution of lakes and streams as the metals vaporize into the air when burned;
- leaching of heavy metals from solid waste landfills;
- exposure of the environment and water to lead and acid;
- corrosion from the strong acids; and
- burns or other injury to eyes and skin.

Batteries are not all the same and each have specific instructions for their proper disposal and/or recycling. The batteries most people use are household types; however, due to the variety of different rules and regulations, check with the local community recycling facility to determine the household battery recycling options or supporting unit/base POL/HAZMAT section.

---

#### CONFIRMATION OF TEACHING POINT 4

---

#### QUESTIONS

- Q1. How would one change channels on the radio?
- Q2. What position must the PTT button be in to receive a message?
- Q3. What is the most common type of battery used for hand-held radios?

## ANTICIPATED ANSWERS

- A1. To set the channel of the radio, push the Menu button, which will cause the current channel to flash. Using the Menu scroll button, scroll through the channels and push the PTT button to select the desired channel.
- A2. The PTT button must be released to receive a message.
- A3. The most common type of battery used for hand-held radios are AA.

---

### Teaching Point 5

### Explain, Demonstrate and Have the Cadet Practice Radio Communication

Time: 20 min

Method: Demonstration and Performance

---



The following section deals with call signs and transmission sequence. It is the basis for developing clear and understandable communications. Discuss the use of call signs and transmission sequence and demonstrate voice procedure using the examples provided below. Cadets will have an opportunity to practice sending radio transmissions during the practical activity.

## USING CALL SIGNS

Call signs are used to identify and organize persons or groups (also known as stations) within a radio network. A call sign may take the form of a pair of words or a combination of letters and figures to a maximum of four.

## UNDERSTANDING TRANSMISSION SEQUENCE

When a station originates a call it must first avoid interfering with other radio transmissions. An operator shall listen to make certain that a frequency is clear before making any transmissions.

Before conducting regular traffic over the radio it may be necessary to make contact with other stations involved to ascertain that communication is possible.

To initiate a call, the transmission sequence is as follows:

1. The initiating station will transmit the call sign of the intended receiver followed by the initiating station's call sign with the phrase "THIS IS" between them (see Example 1, step 1.).
2. The receiving station will acknowledge the initiating station's call by transmitting its call sign and finishing the transmission with the word "OVER" (see Example 1, step 2.).
3. After a reply is received the initiating station will end the transmission, if nothing further is to be said, by transmitting its call sign, acknowledging the receipt of the answer with the word "ROGER" and concluding the message by ending with the word "OUT" (see Example 1, step 3.).

### Example 1 of a Radio Call

1. One Alfa transmits: Two Bravo – this is One Alfa – Over.
2. Two Bravo responds to the initial call transmitting: Two Bravo – Over.
3. One Alfa concludes radio transmissions by transmitting: One Alfa – Roger – Out.

### Example 2 of a Radio Call

1. One Alfa transmits: Two Bravo – this is One Alfa – Message – Over.



2. Two Bravo responds to the initial call, transmitting: Two Bravo – Send message – Over.
3. One Alfa continues with the message, transmitting: One Alfa – will reach your location in two-fife minutes – Over.
4. Two Bravo responds to the message, transmitting: Two Bravo – Roger – Over.
5. One Alfa concludes the call by: One Alfa – Out.

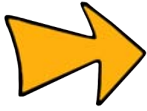

The station that starts the transmission must end it.

### CONDUCTING RADIO CHECKS

All stations are considered to have good signal strength unless otherwise notified. Strength of signals and readability checks will only be conducted when requested or when problems occur. The following prowords will be used to complete this procedure:



Prowords are pronounceable words or phrases which have been assigned meanings for the purpose of expediting message handling on circuits where radiotelephone procedure is employed.

RADIO CHECK: What is my strength and readability?

ROGER: I have received your transmission satisfactorily.

NOTHING HEARD: To be used when no reply is received from a call station.

When answering a radio check both signal strength and readability are reported, as follows:

REPORTS	REPLY	MEANING
REPORT OF SIGNAL STRENGTH	LOUD	Signal is very strong.
	GOOD	Signal is good.
	WEAK	Signal is weak.
	VERY WEAK	Signal is very weak.
	FADING	Signal is fading and continuous communications cannot be relied on.
REPORT OF READABILITY	CLEAR	Excellent quality.
	READABLE	Quality is satisfactory.
	UNREADABLE	I cannot read you.
	DISTORTED	Having trouble reading you due to your signal being distorted.
	INTERFERENCE	Having trouble reading you due to interference.
	INTERMITTENT	Having trouble reading you due to your signal being intermittent.

#### Example of a Radio Check to One Station

1. One Alfa transmits: Two Bravo – this is One Alfa – Radio Check – Over.
2. Two Bravo answers the radio check with the answer transmitting: Two Bravo – Loud and Clear – Over.
3. One Alfa concludes the radio transmission by transmitting: One Alfa – Roger – Out.

#### Example of a Radio Check to Multiple Stations

1. One Alfa transmits: Three Alfa, Two Bravo, One Charlie – this is One Alfa – Radio Check – Over.
2. In sequence the radio stations respond to the radio check by transmitting:  
Three Alfa – Loud and clear – Over.  
Two Bravo – Good with interference – Over.  
One Charlie – Loud and readable – Over.
3. One Alfa concludes radio transmissions by transmitting: One Alfa – Roger – Out.

---

#### CONFIRMATION OF TEACHING POINT 5

---

The cadets' participation in practicing voice procedure will serve as the confirmation of this TP.

**Teaching Point 6****Explain, Demonstrate and Have the Cadet Transmit an SOS Message by Morse Code With Sound and With Light**

Time: 10 min

Method: Demonstration and Performance



For this skill, it is recommended that instruction take the following format:

1. Explain and demonstrate transmitting an SOS message using Morse code with sound and with light.
2. Explain and demonstrate each step of transmitting an SOS message using Morse code with sound and with light. Monitor the cadets as they practice each step.
3. Monitor the cadets' performance as they practice transmitting the complete SOS message using Morse code with sound and with light.

**Note:** Assistant instructors may be used to monitor the cadets' performance.

**MORSE CODE**

Morse code is a method for transmitting telegraphic information, using standardized sequences of short and long elements to represent the letters, numerals, punctuation and special characters of a message. In the Navy, Morse code is referred to as the dot-dash system, with each letter and number being represented by a particular arrangement of dots and dashes. When transmitting, dots (di) are represented by short, and dashes (dah) by long, bursts of sound or light. It was invented by Samuel F. B. Morse (1791-1872), who is also known for producing the first working telegraph set in 1836.



The following is an example of the dots and dashes used to spell cadet: C -. -. A .- D-.. E. T-



The first Morse code message was "What hath God wrought" and was delivered from Washington, District of Columbia to Baltimore, Maryland.

Morse Code is usable in sound signalling (radio and whistle) and visual signalling (lights and flags).



An example of sound signalling is to use the PTT button on a hand-held radio. An example of light signalling is to use a flashlight.

**SOS**

The most well known Morse code transmission is Save Our Souls (SOS). SOS has been the obligatory signal since July 1, 1908.

The following format is used to transmit SOS:

- di-di-di-dah-dah-dah-di-di-di;
- ...-----

---

## CONFIRMATION OF TEACHING POINT 6

---

The cadets' transmission of an SOS message, with light and with sound, will serve as the confirmation of this TP.

---

### Teaching Point 7

### Discuss Alternative Methods of Communication

Time: 10 min

Method: Interactive Lecture

---

A cellular phone, satellite phone or personal locator beacon can be a big help in an emergency situation allowing individuals to contact help almost immediately. That is, provided, there is reception, the batteries are charged, or there is no damage to the unit.



In the outdoor community there is a great deal of discussion about the use of cellular phones and satellite phones. Some argue that they are essential backcountry safety devices and some feel they intrude on the experience of the outdoors. It is important to recognize that communication devices work differently in different areas and situations, and as such should not be relied on completely.

### SATELLITE PHONES

- Satellite phones require an unobstructed signal to the sky in order to establish a satellite connection.
- Although the technology is getting better all the time, connections often still cannot be made in deep forests, canyons, low-lying area and deep gorges.
- Satellite phones require a lot of battery power, so depending on the duration of the trip additional batteries or solar recharging panels may have to be brought.

### CELLULAR PHONES

- Cellular phones often do not work in remote areas.
- When going into wilderness settings, a cellular phone should not be relied upon as the sole emergency contact device.
- Cellular phones are limited by their service area.
- Cellular phones are vulnerable to cold, moisture, sand and heat – requiring users to protect them from hazards.



Some cellular phones have internal Global Position System (GPS) locators which can be useful when in wilderness areas. In emergency situations this allows for rescuers to pinpoint the location of those being rescued. However, the same limitations as discussed above exist. For example, if the individuals are in a low lying, forest covered area, the signal would not be received.

### PERSONAL LOCATOR BEACON

- Lightweight and reliable.
- Must be registered with a national search-and-rescue organization.
- In an emergency, press a button on the palm-sized unit to send a unique signal with GPS coordinates to a central call centre via satellite.

- When stranded but not in immediate danger or to check in as OK, send a help or OK message to your contacts via e-mail.

---

### CONFIRMATION OF TEACHING POINT 7

---

#### QUESTIONS

- Q1. When attempting to make a call using a satellite phone what are some considerations that should be made to ensure that they are able to establish a satellite connection?
- Q2. What is the main limitation of using a cellular telephone?
- Q3. What are the benefits of a GPS locator in a cell phone?

#### ANTICIPATED ANSWERS

- A1. To ensure the establishment of a good satellite connection the individual should ensure that they have an unobstructed signal to the sky, and that they are not in a deep forest, a canyon, low-lying area or a deep gorge.
- A2. Cellular phones are limited by their service area.
- A3. In emergency situations this allows for rescuers to pinpoint the location of those being rescued. However, the same limitations as discussed above exist. For example, if the individuals are in a low-lying, forest covered area, the signal would not be received.

---

#### Teaching Point 8

#### Conduct a Communication Activity

Time: 40 min

Method: Practical Activity

---

### ACTIVITY

---

#### OBJECTIVE

The objective of this activity is for the cadet to practice radio communications through employing the phonetic alphabet, beginning and ending radio transmissions, conducting radio checks, and transmitting an SOS Morse code message using sound/light.

#### RESOURCES

- Large space with a minimum of 5 m (16 ft) between members of each group,
- One hand-held radio per group,
- Three AA batteries per radio,
- Radio Communication Exercise located at Annex J, and
- One flashlight per group.

#### ACTIVITY LAYOUT

N/A.

## ACTIVITY INSTRUCTIONS

1. Divide cadets into three groups.
2. Assign a call sign to each member of each group (depending on numbers there may be a requirement to assign the same call sign to more than one person in a group, or assign two call signs to one person in a group).
3. Hand out a copy of the Radio Communication Exercise to each group.
4. Assign each group a specific area with at least 5 m (16 ft) between them.
5. Acting as 1, complete the radio communication exercise.
6. Once the radio communication exercise is complete, have each group transmit a SOS message using the PTT button on their radios and using a flashlight.

## SAFETY

N/A.

---

### CONFIRMATION OF TEACHING POINT 8

---

The cadets' participation in the activity will serve as the confirmation of this TP.

---

### END OF LESSON CONFIRMATION

---

The cadets' participation in the communication activity will serves as the confirmation of this lesson.

---

### CONCLUSION

---

## HOMEWORK/READING/PRACTICE

N/A.

## METHOD OF EVALUATION

N/A.

## CLOSING STATEMENT

As an outdoor leader understanding the principles of radio communication and being able to transit radio messages is very important. Daily expedition routine may require an outdoor leader to communicate between their group and other groups. As well, situations may arise when the outdoor leader must implement emergency communication strategies.

## INSTRUCTOR NOTES/REMARKS

Hand-held radio models may vary. The instructor will be responsible for consulting the owner's manual for detailed instructions on radio operation.

---

### REFERENCES

---

A2-034 ACP 125 CANSUPP Department of National Defence. (1984). *Radiotelephone Procedure for the Canadian Forces (Land Environment)*. Ottawa, ON: Department of National Defence.

- C0-069 Motorola Inc. (2004). *Talkabout FRS/GMRS Recreational Two-Way Radios Models T5000, T5500, T5550 User's Guide*.
- C1-003 (ISBN 11-770973-5) Royal Navy. (1972). *Admiralty Manual of Seamanship* (Vol. 1). London, England: Her Majesty's Stationary Office.
- C2-016 (ISBN 1-4000-5309-9) Curtis, R. (2005). *The Backpacker's Field Manual: A Comprehensive Guide to Mastering Backcountry Skills*. New York, NY: Three Rivers Press.

Two-way hand-held radio owner's manual.

THIS PAGE INTENTIONALLY LEFT BLANK





**ROYAL CANADIAN ARMY CADETS**  
**SILVER STAR**  
**INSTRUCTIONAL GUIDE**



**SECTION 5**

**EO C325.02 – PARTICIPATE IN A PRESENTATION ON THE DUKE OF EDINBURGH AWARD PROGRAM**

Total Time:

30 min

**PREPARATION**

**PRE-LESSON INSTRUCTIONS**

Resources needed for the delivery of this lesson are listed in the lesson specification located in A-CR-CCP-703/PG-001, Chapter 4. Specific uses for said resources are identified throughout the instructional guide within the TP for which they are required.

Review the lesson content and become familiar with the material prior to delivering the lesson.

Contact the local Duke of Edinburgh Award program division and gather presentation material about the Duke of Edinburgh Award program.

A member of the corps staff may present this lesson if a Duke of Edinburgh Award program representative is unavailable.

**PRE-LESSON ASSIGNMENT**

N/A

**APPROACH**

An interactive lecture was chosen for this lesson to introduce, clarify, emphasize and summarize the objectives of the Duke of Edinburgh Award program.

**INTRODUCTION**

**REVIEW**

N/A.

**OBJECTIVES**

By the end of this lesson the cadet shall have participated in a presentation on the Duke of Edinburgh Award program.

**IMPORTANCE**

It is important for cadets to know all opportunities for growth available to them. The Duke of Edinburgh Award program is one opportunity that is widely available to cadets. By knowing what the program entails and what the rewards are, cadets will have a better understanding of the program and be able to decide if they wish to become a participant.

---

## BACKGROUND KNOWLEDGE

---



The material for this lesson will be gathered from the provincial office of the Duke of Edinburgh Award program. Videos, brochures and activities used to present the information can be found at [www.dukeofed.org](http://www.dukeofed.org).

The program was founded in 1956 by His Royal Highness Prince Philip, The Duke of Edinburgh K.G. K.T. in London, England, as a means to encourage and motivate youth. The goal of the Duke of Edinburgh Award program is to encourage young people's participation in activities they already enjoy and to develop personal goals and encourage achievement based on individual effort and improvement.

The Duke of Edinburgh Award program is about personal challenge, and aims to encourage and stimulate:

1. self-reliance and self-discipline,
2. perseverance and determination,
3. initiative and creativity,
4. community involvement and social responsibility,
5. value orientation and value-oriented decision making,
6. the spirit of adventure,
7. fitness of body and mind,
8. vocational, cultural and family life skills, and
9. international understanding and awareness.

The award is a lapel pin or brooch, and an inscribed certificate of achievement. Upon completion of the Gold award, the individual will be presented the award by HRH Prince Philip.

More than 30 000 young Canadians are currently participating in the Duke of Edinburgh Award program; many within the Canadian Cadet Movement.

---

### Teaching Point 1

### Describe the Different Levels of the Program

Time: 5 min

Method: Interactive Lecture

---

There are three levels within the Duke of Edinburgh Award program. Each successive level requires more commitment and becomes more demanding. The levels are Bronze, Silver and Gold. A young person may choose to participate at any time and any level, keeping in mind the prescribed age requirements.

**Bronze.** For youth over the age of 14. There is a minimum 6-month period of participation.

**Silver.** For youth over the age of 15. There is a minimum 12-month period of participation.

**Gold.** For youth over the age of 16. There is a minimum 18-month period of participation.

If a participant has completed a prior level, the period of participation is decreased by six months. (eg, a cadet who has completed the Bronze level can complete the Silver level in six months).

---

## CONFIRMATION OF TEACHING POINT 1

---

### QUESTIONS

- Q1. What are the three levels of the program?
- Q2. What is the age requirement for the program?
- Q3. When can a person start the Gold level?

### ANTICIPATED ANSWERS

- A1. The three levels of the program are Bronze, Silver and Gold.
- A2. The age requirement is a minimum of 14, although each subsequent level has an age minimum if a participant is just beginning the program.
- A3. The Gold level can be started at age 16.

---

### Teaching Point 2

### Explain the Five Sections of the Program

Time: 10 min

Method: Interactive Lecture

---

The Award's activities are arranged into sections, and within each section there are many choices. There are five sections to the program. The four common sections are:

- service,
- adventurous journey,
- skills, and
- physical recreation.

At the Gold level, participants have to complete a residential project.

### SERVICE

Service is a commitment to the needs of others without pay.

The goal of the service section is to encourage participants to realize that as members of a community, they have a responsibility to others and that their help is needed. By helping others, it is hoped that participants will find satisfaction sparking a commitment to community service for life.

### ADVENTUROUS JOURNEY

The goal of the adventurous journey is to develop self-reliance by undertaking a journey of discovery. The adventurous journey encourages participants to develop an awareness of the natural environment, and the importance of protecting it.

The distance the cadet must travel and the duration of the journey varies for each level of the Award:

- Bronze – two days including one night away,
- Silver – three days including two nights away, and
- Gold – four days including three nights away.

The hours the cadet must spend on planned activities varies for each level:

- Bronze – an average of six hours per day,
- Silver – an average of seven hours per day, and
- Gold – an average of eight hours per day.

There are three types of journeys that can be undertaken:

- **Explorations.** A purpose with a trip. During this journey, participants must spend a minimum of 10 hours on journeying (moving without motorized assistance). The remainder of the time is spent on a special activity, (eg, historic site exploration, or studying flora and fauna). Explorations must involve pre-journey research, on-site study, and a report on the findings.
- **Expeditions.** A trip with a purpose. An Expedition is a journey where participants stay at a different campsite each night. The required hours will be spent on journeying, navigating and route finding. This may include tasks related to the purpose of the expedition.
- **Adventurous Projects.** An Adventurous Project is a journey that does not fit the above descriptions exactly, or may be a combination of the two. This type of journey would be used by those with medical restrictions or who require more challenges.

All Explorations, Expeditions and Adventurous Projects must have a clearly defined and a preconceived purpose.

## SKILLS

The goal of the skills section is to encourage the discovery of personal interests and development of social and practical skills. Participants are encouraged to take up interests within a range of practical, social and cultural activities. Skills can be either a progressive activity such as stamp collecting, playing a musical instrument, a study of a topic of personal interest such as money matters, or a definite task such as building something.

## PHYSICAL RECREATION

The goal of the physical recreation section is to encourage participation in physical activity and provide an opportunity to improve performance and learn to appreciate physical recreation as an important component of a healthy lifestyle.

Participation in one or more physical activities for the required number of weeks:

- Bronze – 30 hours over a minimum of 15 weeks,
- Silver – 40 hours over a minimum of 20 weeks, and
- Gold – 50 hours over a minimum of 25 weeks.

Improvement of overall performance is essential for qualification in this section.

## RESIDENTIAL PROJECT

The goal of the residential project is to develop social adaptability through involvement in a group setting. It involves participants in projects or training in the company of peers who are not their everyday companions.

The residential project is applied only at the Gold level, but can be completed at any time during award participation.

---

## CONFIRMATION OF TEACHING POINT 2

---

## QUESTIONS

Q1. What are the five sections of the Duke of Edinburgh Award program?

Q2. What is the goal of the skills section?

Q3. When is the residential project completed?

### ANTICIPATED ANSWERS

A1. The five sections of the program are:

- service,
- adventurous journey,
- skills,
- physical recreation, and
- residential project.

A2. The goal of the skills section is to encourage the discovery of personal interests and development of social and practical skills. Participants are encouraged to take up interests within a range of practical, social and cultural activities.

A3. The residential project can be completed at any time during award participation.

---

### Teaching Point 3

### Describe the Relationship Between the Corps, CSTC Programs and the Duke of Edinburgh Award Program

Time: 5 min

Method: Interactive Lecture

---



This TP is designed to inform the cadet about the opportunities within the Award that correspond with activities within the Canadian Cadet Organization (CCO).

The CCO offers many opportunities for participants to work toward completing their respective level.

Within the corps program and CSTC program, many opportunities exist for cadets to meet the requirements of the Award. Beyond the opportunities listed, many other opportunities may also exist, especially in very active cadet corps. Some examples of cadet activities that meet the Award requirements are:

- **SERVICE**
  - participating in community service activities as part of PO 302 (Perform Community Service, Chapter 2) within the corps program;
  - participating in opportunities as a senior cadet when instructing junior cadets during the corps program;
  - helping with the cadet corps newsletter;
  - volunteering to help the Royal Canadian Legion during poppy days; and
  - participating in a band demonstration where the corps does not receive funds in return.
- **ADVENTUROUS JOURNEY**
  - participating in the Silver and Gold Star program weekend bivouac exercise will qualify as practice or adventurous journeys for Bronze and Silver levels;

- o participating in most Year 2+ CSTC program exercises will qualify as practice or adventurous journeys for Bronze and Silver level; and
- o participating in regional/international and national expeditions may qualify as the Gold level provided the cadet directly participates in planning aspects of the activity.

- **SKILL**

- o participating in the cadet corps band;
- o participating in the marksmanship team; and
- o participating in the drill team.

- **PHYSICAL FITNESS**

- o participating in recreational sports as part of PO 305 (Participate in Recreational Sports, Chapter 5),
- o participating in cadet fitness testing as part of PO 304 (Update Personal Activity Plan, Chapter 4); and
- o participating in recreational sports as part of the CSTC Program.

- **RESIDENTIAL PROJECT**

- o participation in any qualification at a CSTC.



CATO 13-19, *The Duke of Edinburgh's Award*, outlines the participation requirements of a youth as a member of the Army Cadet program.

In addition to all the award requirements that are recognized as part of the Cadet Program, many activities cadets participate in outside the cadet corps also count toward the award, such as:

- volunteer activities,
- extracurricular sports teams,
- school clubs, and
- hobbies.



Duke of Edinburgh Award pins may be worn on the cadet uniform in accordance with CATO 46-01, *Army Cadet Dress Regulations*.



After cadets have been informed of the Duke of Edinburgh Award program, and displayed interest in participation, discuss participation with the CO.

Contact the divisional office of the Duke of Edinburgh Award program. Contact information for the offices can be found at [www.dukeofed.org](http://www.dukeofed.org).

After the Division office has been contacted:

1. Collect the registration fee from each cadet who wants to participate in the program.
2. If there are only a few cadets who wish to participate, register them as individuals.
3. If the corps will be participating as a whole, register as a group.

---

### CONFIRMATION OF TEACHING POINT 3

---

#### QUESTIONS

- Q1. What activities at the corps can be completed as part of the service section of the award?
- Q2. What optional activities within cadets can be used for the skill section?
- Q3. When is the residential project completed?

#### ANTICIPATED ANSWERS

- A1. As part of the service section, the following can be completed at the home corps:
- participating in community service activities as part of PO 302 (Perform Community Service, Chapter 2) within the corps program;
  - participating in opportunities as a senior cadet when instructing junior cadets during the corps program;
  - helping with the cadet corps newsletter;
  - volunteering to help the Royal Canadian Legion during Poppy Days; and
  - participating in a band demonstration where the corps does not receive funds in return.
- A2. Participating in the cadet corps band, the marksmanship team, and the drill team may be used to complete the skill section.
- A3. The residential project is completed with any qualification at a CSTC.

---

#### Teaching Point 4

#### Facilitate a Question and Answer Period

Time: 5 min

Method: Interactive Lecture

---



Allow cadets time to ask questions and discuss participation in the program.

---

**CONFIRMATION OF TEACHING POINT 5**

---

The cadets' participation in a question and answer period will serve as the confirmation of this TP.

---

**END OF LESSON CONFIRMATION**

---

The cadets' participation in the presentation on the Duke of Edinburgh Award program will serve as the confirmation of this lesson.

---

**CONCLUSION**

---

**HOMEWORK/READING/PRACTICE**

N/A.

**METHOD OF EVALUATION**

N/A.

**CLOSING STATEMENT**

The Duke of Edinburgh Award program is one of the largest award programs for youth across the world. Informing cadets about the program will encourage them to participate in the program. It will give them positive experiences to move toward in both the Cadet Program and in life.

**INSTRUCTOR NOTES/REMARKS**

Training aids should be determined by contacting the speaker prior to the presentation.

Cadets may participate in the Duke of Edinburgh Award program as an optional activity.

A member of the corps staff may present this lesson if a Duke of Edinburgh Award representative is unavailable.

---

**REFERENCES**

---

- C0-196 Duke of Edinburgh Award. (2008). *The Award*. Retrieved February 12, 2008, from <http://www.dukeofed.org/Award.htm>.
- C0-197 Duke of Edinburgh Award. (2007). *Participant's Record Book*. Markham, ON: Langstaff Reed Printing Ltd.



## SCENARIO

With the confidence he gained from his first outdoor leadership course five years ago, Peter decided to enrol in an adventure trip to Nepal. Their instructors were apparently experienced and skilled so the trip seemed safe. The participants were from all over the country. They had all enjoyed previous outdoor experiences. Everyone looked fit and ready for a fun adventure. The group met their instructors in Kathmandu. They were whisked away to the hotel and were given a quick briefing.

The next day, the group boarded a bus to travel toward the mountains. They were met by a group of Sherpas and porters who would cook, guide and carry their clothing and equipment. Peter was psyched – this was going to be great! They hiked through river beds and mountains, gaining and losing enormous amounts of elevation each day. Since it was fall, the weather was clear and cool. The group practiced the Nepali language each evening by playing volleyball with the porters and singing songs with them.

One day the instructors offered the group the chance to hike over a pass at 5 395 m (17 700 feet). There was some discussion about the route since the group had been advised to bring light hiking clothes. If anyone had extra warm sweaters or jackets they shared them with the porters. Peter thought it was a great idea to have such a challenge and get to a high elevation. He had total faith in the instructors and the program. It was snowing when they left camp at three in the morning. Up they climbed in two groups.

After 10 hours of hiking, the group was in trouble. One girl was suffering from hypothermia and a Sherpa carried her back down the mountain. Others were lying in the snow, vomiting, or just sitting, exhausted. The two hiking groups had lost sight of each other, and none of the participants really cared. They would keep going as long as they were told to do. Finally, the head Sherpa ran up to the lead group and said the group would return to camp. The group turned around and stumbled down the trail. Exhausted, cold, and sick, they finally made it to camp. The next day the experience was debriefed. The instructors informed the group that the porters had turned back well before the group had and refused to carry the groups' belongings to the next camp. It was also revealed that the next camp, a communal hut, had no firewood. The last group over the pass had used all of it the previous night. With the condition of the group they thought four or five people could have suffered severe hypothermia or death if they had not turned back.

The group was quiet. Peter thought he would have been one of the unlucky ones since he had wanted to lie down and go to sleep in the snow, a sure death sentence. He had strained a leg falling down the trail and was really scared. Mostly he had lost faith in the leaders and their ability to make safe decisions. He doubted his own abilities and swore that he would never participate in another organized trip unless he had all the details first. What had he been thinking, trying to go to over 5 000 m (17 000 feet) in sneakers and cotton pants? He had known better but trusted the leaders completely to make good decisions. The more he thought about it, the angrier he got, mostly at himself for doing something that was so unsafe. The experience also made Peter want to become an outdoor leader so that others could have safe and enjoyable experiences. He would get the training necessary to work with participants at their ability level. He also learned that life is fragile and it would be easy to die in the outdoors.

Peter's overconfidence after his first course was misplaced. He knew that outdoor experiences could change someone for the better, but now he had learned that poor decisions by leaders could lead to potential disaster. Peter understood and could reframe his scary experience so that he became determined to do better and to share what he had learned with others. He sought out further training and opportunities to learn technical skills. His teaching experience helped him to work with groups effectively and be sensitive to needs of participants at different age and experience levels.

Peter had been forced to look at himself critically. He learned not to take nature for granted. He became much more self-aware, which helped him to develop into an excellent outdoor leader. Peter has now led hundreds of students through the mountains. In retrospect, he is glad that he had experiences that made him pay attention to what people can tolerate in outdoor situations. He makes conservative decisions and routinely leads safe trips. Peter was lucky to be able to derive the positive from a negative experience. He became a more complete human and a successful, mature outdoor leader (Martin, B., Cashel, C., Wagstaff, M., and Breunig, M., *Outdoor Leadership: Theory and Practice*, Human Kinetics. [pp 120–121]).

## INFORMATION CARD A

### **SELF-AWARENESS AND PROFESSIONAL CONDUCT**

#### **Being Self-Aware**

A competent outdoor leader (OL) needs to be self-aware. To be self-aware is to be conscious of one's:

- character,
- feelings, and
- motives.

As an OL, who is responsible for the safety, well-being and organization of a group of people, being self-aware:

- ensures a higher quality experience for all group members, and
- allows the OL to better relate to their group members.

#### **Being Aware of One's Personal Abilities and Limitations**

Self-awareness starts with a clear understanding of one's personal abilities and limitations. Without a clear sense of their own abilities and limitations, OLs will have difficulty setting challenges appropriate to the abilities and limitations of group members. As well, there may be a tendency to set the bar too high, which may jeopardize the emotional and physical safety of the members of the group they are leading. This can result in the OL becoming a possible danger to the group and diminishing the quality of the experience for all.

#### **Being Mindful of All Actions**

Good OLs are always mindful – intentional – in their actions. They act with regard to the ultimate goals of the group experience, which is a balance between being attentive to the needs of the group members and being attentive to the tasks that must be accomplished.

#### **Managing Stress**

- Stress caused by physical danger is not the hardest type of stress for an OL to manage.
- Ordinary situations – a rainstorm that catches a group 5 km (3 miles) away from the trailhead with members who force their own frustrations on the group leader, who not only has to deal with the group complaints, but also with the stream of rain running down the neck of their own parka – are more stressful as they usually occur over an extended period of time, require more attention and require the OL to deal with uncontrollable factors.

#### **Demonstrating Professional Conduct**

OLs are placed in a position of responsibility and as such must conduct themselves accordingly in all situations. It is the inherent risk associated with outdoor adventure activities (OAA) that makes professional conduct so important for an OL – safety of the participants is a critical factor.

Professional conduct is characterized through demonstration of the following qualities:

- trustworthiness,
- flexibility,
- approachability,
- commitment,
- awareness of the position of authority, and
- modelling.

### **CONFLICT MANAGEMENT**

Conflicts in OAAs are inevitable. The challenge, for the OL, is to stop the conflict before it gets bigger, or deal with it as quickly and effectively as possible. Most conflicts that occur in outdoor situations are a result of:

- weather conditions;
- varying levels of experience among group members;
- the challenging nature of the activity; and
- personalities of group members.

An OL who is able to communicate clearly with all group members will be better suited to manage conflict. Dealing with conflict is not a pleasant task, however, the first step is to always speak with the individual and discuss the issues in a calm and sensitive manner.

### **DECISION MAKING AND JUDGMENT**

**Decision Making.** Decision making is the process of choosing the best option from a collection of possible options. In order to make this choice the OL will be required to use their judgment.

**Judgment.** Judgment is an informed opinion based on past experiences. Judgment also provides OLs with the ability to anticipate problems before they occur. Their experience in leading people during an OAA provides them the foresight to know when something is going well or when it needs adjustment.

- OLs do not have to make the "big" decisions on their own.
- Communicating with fellow group members and using their experience and ideas to help make a decision is also an integral part of making a decision.
- A decision must be made and carried out decisively.
- OLs must have confidence in the decision that they have made.
- Group members must have confidence in the decision that is made by the OL.

## INFORMATION CARD B

### FACILITATION OF THE EXPEDITION EXPERIENCE

#### FACILITATION

Facilitation is the process of moving a group or individual toward a desired outcome. Facilitation:

- fosters productive group dynamics;
- enables group members to work toward completing the outdoor adventure activity (OAA), in a safe and enjoyable manner; and
- works to develop interpersonal relationships among group members.

#### FACILITATOR

A facilitator provides the means for making experiences possible. As a facilitator, outdoor leaders (OLs) will:

- be required to resolve conflicts;
- communicate effectively;
- foster personal trust and group cooperation; and
- debrief and guide reflection on OAA.

An effective OL can facilitate the experience and shift the outdoor experience from a mere excursion in the outdoors to a dynamic learning experience.

#### TECHNICAL ABILITIES

OLs may possess excellent facilitations skills and may be extremely effective at organizing OAAs, however, without technical ability to serve as the foundation for conducting the activity, these skills cannot be used. Technical abilities are organized into two main areas – generic competency skills and specific competencies.

#### Generic Competency Skills

Generic competency skills are those skills in which, no matter the OAA, an OL must be competent. They include:

- weather prediction,
- wilderness first aid,
- trip planning,
- navigation,
- camp skills,
- general outdoor skills,
- physical fitness, and
- mental awareness.

### **Specific Competency Skills**

Specific competency skills are those skills unique to the OAA the OL will be leading. Examples include:

- trekking,
- mountain biking,
- abseiling,
- climbing,
- caving,
- canoeing, and
- kayaking.

There is no requirement for an OL to be an expert in all activities. In many cases they choose activities that interest them the most and capitalize on the experiences they offer. Proficiency in an OAA can only be gained through experience. The more experience OLs gain, the more competent they become.

OLs cannot allow their skills to decay; they should continuously participate in professional development training to refresh their knowledge and skills. It is the responsibility of the OL to stay up-to-date in the areas in which they lead others.

### **INSTRUCTIONAL TECHNIQUES**

Instructional skills are important because OLs often have the opportunity to teach and thus share important skills and knowledge with the people they lead.

OLs with the responsibility of teaching others need to be well versed in skills such as:

- using instructional aids;
- developing skill lesson plans; and
- employing different teaching strategies.

Experiential education is the primary method by which OLs deliver their educational content. Every lesson involves some degree of explanation and demonstration, and a greater degree of practice – which gives individuals the opportunity to learn skills in a hands-on manner.

## INFORMATION CARD C

### ENVIRONMENTAL STEWARDSHIP

#### ENVIRONMENTAL ETHICS

- Outdoor leaders (OLs) must alter the attitudes of others toward preserving and conserving the environment.
- OLs must practice and enforce the environmental ethical code represented by the seven principles of Leave No Trace.

#### ECOLOGICAL LITERACY

Ecological literacy entails thinking and acting critically in an environmental context, especially when it comes to making decisions and exercising judgment regarding environmental problems.

#### PARKS AND PROTECTED AREAS MANAGEMENT

- Areas OLs use to conduct outdoor adventure activities (OAA) are managed by provincial and national agencies.
- It is critical that OLs are aware of the policies and regulations of the park/conservation area they are using and abide by these rules.
- OLs must teach low-impact camping, waste management and traveling techniques to their groups.

### PROGRAM MANAGEMENT

#### EMPLOYING SAFETY AND RISK MANAGEMENT

OAA are, for the most part characterized by the inherent risk they possess. Risk is one of the critical components that make outdoor programming so popular and successful. OLs must be able to balance risk and safety.

As an OL, there is a responsibility to:

- assess the OAA for risk;
- manage risk during the activity; and
- develop a contingency plan to ensure the safety of all participants.

#### PLANNING, ORGANIZING AND MANAGING

##### Planning

OLs are required to complete detailed planning for trips/activities they lead. Proper planning is essential for any OAA and when it is not carried out thoroughly, the possibility of accidents increases.

Trip/activity plans include:

- emergency management details,
- contingency plans,
- time control plans,
- energy control plans,
- ration plans,
- communication plans, and
- equipment/resource procurement, etc.

### **Organizing**

Once a plan has been developed, the ability to implement the plan is based on the OL's organizational skills. Implementation involves creating a system for getting tasks done and requires the ability to coordinate the various components of the plan so that it comes together to create a unified whole.

### **Managing**

Management skills involve the ability of the OL to direct the group in an efficient manner to complete all required tasks throughout the OAA. For example, when arriving at the campsite, after a long day of paddling, an organized OL will have already divided the group into sub-groups to allow for multi-tasking to ensure the campsite is set up, water is collected, the fire is started and supper is prepared.



### EXPERT ACTIVITY SHEET

**Provide a brief overview of each assigned competency of an outdoor leader.**

Competency #1 \_\_\_\_\_

Competency #2 \_\_\_\_\_

Competency #3 \_\_\_\_\_

**Use the scenario to provide examples, positive and negative, of each assigned competency.**

Competency #1 \_\_\_\_\_

Competency #2 \_\_\_\_\_

Competency #3 \_\_\_\_\_

## COMPETENCIES OF AN OUTDOOR LEADER HANDOUT

### SELF-AWARENESS AND PROFESSIONAL CONDUCT

#### Being Self-Aware

A competent OL needs to be self-aware. To be self-aware is to be conscious of one's character, feelings and motives. As an OL, who is responsible for the safety, well-being and organization of a group of people, being self-aware ensures a higher quality experience for all group members. Being aware of individual feelings and motives will allow the OL to better relate to their group members.

#### Being Aware of One's Personal Abilities and Limitations

Self-awareness starts with a clear understanding of one's personal abilities and limitations. Without a clear sense of their own abilities and limitations, OLs will have difficulty setting challenges appropriate to the abilities and limitations of group members. As well, there may be a tendency to set the bar too high, which may jeopardize the emotional and physical safety of the members of the group they are leading. This can result in the OL becoming a possible danger to the group and diminishing the quality of the experience for all.

#### Being Mindful of All Actions

Good OLs are always mindful – intentional – in their actions. They act with regard to the ultimate goals of the group experience, which is a balance between being attentive to the needs of the group members and being attentive to the tasks that must be accomplished.

#### Managing Stress

Stress can be caused by a number of factors. While some may believe that stress caused by physical danger is the hardest to manage, this is not the case. Situations that place stress on the OL are often a lot less dramatic than a singular event such as a rope breaking during a climbing activity. The event happens so fast that adrenalin kicks in before stress can occur. Instead, it is the ordinariness of the situation which makes it so stressful. For example, a rainstorm catches a group 5 km (3 miles) away from the trailhead. Members force their own frustrations on the group leader, who not only has to deal with the group complaints, but also with the stream of rain running down the neck of their own parka.

#### Demonstrating Professional Conduct

OLs are placed in a position of responsibility and as such must conduct themselves accordingly in all situations. A lack of professional conduct could result in situations such as an injury during a paddling activity, or a breakdown in group dynamics while on an OAA. It is the inherent risk associated with OAA that makes professional conduct so important for an OL. Professional conduct is characterized through demonstration of the following qualities:

- trustworthiness,
- flexibility,
- approachability,
- commitment,
- awareness of the position of authority, and
- modelling.

### CONFLICT MANAGEMENT

Conflicts in OAAs are inevitable. The challenge, for the OL, is to stop the conflict before it escalates, or deal with it quickly and effectively as possible. Most conflicts that occur in outdoor situations are a result of:

- weather conditions;
- varying levels of experience among group members;
- the challenging nature of the activity; and
- personalities of group members.

An OL who is able to communicate clearly with all group members will be better suited to manage conflict. There are always going to be situations where the OL is required to interact with difficult people. A group member who was a pleasure to have around at the beginning of a 10-day expedition, and who got along with everyone at the campsite, may, by Day 8, have blisters from ill-fitting boots and be arguing with everyone. It becomes the responsibility of the OL to deal with this situation. Conflict while on an expedition is like a wound: unless it is dealt with, it will just keep spreading and festering. Dealing with conflict is not a pleasant task, however, the first step is to always speak with the individual and discuss the issues in a calm and sensitive manner.

## **DECISION MAKING AND JUDGMENT**

**Decision Making.** Decision making is the process of choosing the best option from a collection of possible options. In order to make this choice, the OL will be required to use their judgment.

**Judgment.** Judgment is an informed opinion based on past experiences. Judgment also provides OLs with the ability to anticipate problems before they occur. Their experience in leading people during an OAA provides them the foresight to know when something is going well or when it needs adjustment.

OLs are placed in the position because of the experience they have. It is then assumed that when leading a group, they will be qualified to make decisions that affect the safety and welfare of the group. That is not to say that OLs have to make the “big” decisions on their own: being able to communicate with fellow group members and use their experience and ideas to help make a decision is also an integral part of making a decision. An OL, who has completed the same route up a mountain, may benefit from another individual’s point of view before deciding whether or not to continue an ascent, or halt due to a lack of motivation in group members.

Decision making is a process which should be carried out decisively. Once an OL has considered their options and reached a decision, they should stick with it, unless circumstances change. They should not allow themselves to be swayed by other group members. They have the experience, have assessed the factors and have reached a decision. In OAA, where safety is always a concern, the OL must have confidence in the decisions they make and the group must have confidence in the decisions the OL has made.

## **FACILITATION OF THE EXPEDITION EXPERIENCE**

Leading others in OAA does not guarantee that learning will occur. An outdoor experience can bring joy and wonder, and can help people develop new relationships and make discoveries. An outdoor experience encourages people to learn things about themselves, others and the outdoors.

It is possible to be outdoors and miss these opportunities or not enjoy the experience. Some participants do not want to learn in the outdoors:

- it feels unsafe in its newness;
- they have had previous negative experiences; or
- they are not interested in getting the most out of the experience.

An effective OL can facilitate the experience and shift the outdoor experience from a mere excursion in the outdoors to a dynamic learning experience.

Facilitation is the process of moving a group or individual toward a desired outcome. A facilitator provides the means for making experiences possible. For an OL, facilitation is a skill which fosters productive group

dynamics, enabling all members to work toward completing the OAA, in a safe and enjoyable manner, while also developing interpersonal relationships.

OLs will often be required to:

- resolve conflicts;
- communicate effectively;
- foster personal trust and group cooperation; and
- debrief and guide reflection during and following an OAA.

## **TECHNICAL ABILITIES**

OLs may possess excellent facilitations skills and may be extremely effective at organizing an OAA, however, without technical ability to serve as the foundation for conducting the activity, these skills cannot be used. Technical abilities are organized into two main areas – generic competency skills and specific competencies.

### **Generic Competency Skills**

Generic competency skills are those skills in which, no matter the OAA, an OL must be competent. They include:

- weather prediction,
- wilderness first aid,
- trip planning,
- navigation,
- camp skills,
- general outdoor skills,
- physical fitness, and
- mental awareness.

### **Specific Competency Skills**

Specific competency skills are those skills unique to the OAA the OL will be leading. Examples include:

- trekking,
- mountain biking,
- abseiling,
- climbing,
- caving,
- canoeing, and
- kayaking.

There is no requirement for an OL to be an expert in all activities. In many cases they choose activities that interest them the most and capitalize on the experiences they offer. Proficiency in an OAA can only be gained through experience. The more experience OLs gain, the more competent they become.

OLs cannot allow their skills to decay; they should continuously participate in professional development training to refresh their knowledge and skills. It is the responsibility of the OL to stay up-to-date in the areas in which they lead others.

## **INSTRUCTIONAL TECHNIQUES**

Instructional skills are important because OLs often have the opportunity to teach and thus share important skills and knowledge with the people they lead. OLs with the responsibility of teaching others need to be well versed in skills such as using instructional aids, developing skill lesson plans and employing different teaching strategies. Experiential education is the primary method by which OLs deliver their educational content. Every lesson involves some degree of explanation and demonstration, and a greater degree of practice – which gives individuals the opportunity to learn skills in a hands-on manner.

## **ENVIRONMENTAL STEWARDSHIP**

Environmental stewardship is a three-faceted term that takes into account environmental ethics, ecological literacy and parks and protected areas management. With the environment experiencing the heavy impact of current culture, it is OLs who must alter the attitudes of others toward preserving and conserving the environment. When leading groups, OLs must practice and enforce the environmental ethical code, represented by the seven principles of Leave No Trace, which serve as the basis for ecologically responsible interactions with the natural environment.

Ecological literacy entails thinking and acting critically in an environmental context, especially when making decisions and exercising judgment regarding environmental problems.

Many of the areas OLs use to conduct OAAs are managed by provincial and national agencies. It is critical that OLs are aware of the policies and regulations of the park/conservation area they are using and abide by these rules. The park/conservation area has implemented these policies and regulations as a means to reduce the environmental impact while still allowing people to enjoy the outdoor setting. OLs must understand that every action has the potential to impact the natural environment and that they must take the necessary precautions to protect the environment when travelling or camping outdoors. As well, they must teach low-impact camping, waste management and travelling techniques to their groups.

## **PROGRAM MANAGEMENT**

Program management consists of two main areas – employing safety and risk management, and planning, organizing and managing. OAAs are, for the most part, characterized by the inherent risk they possess. Risk is one of the critical components that make outdoor programming so popular and successful. OLs must be able to balance risk and safety – too much risk and the danger of the experience will become unreasonable; too much safety and the activity will fail to remain adventurous. As an OL, there is a responsibility to assess the OAA for risk, manage risk during the activity and develop a contingency plan to ensure the safety of all participants. Most aspects of risk management are carried out during the planning phase of an activity.

OLs are required to complete detailed planning for trips/activities they lead. Proper planning is essential for any OAA and when it is not carried out thoroughly, the possibility for tragedy increases. Trip/activity plans include:

- emergency management details,
- contingency plans,
- time control plans,
- energy control plans,
- ration plans,
- communication plans, and
- equipment/resource procurement, etc.

Once a plan has been developed, the ability to implement the plan is based on the OL's organizational skills. Implementation involves creating a system for getting tasks done and requires the ability to coordinate the various components of the plan so that it comes together to create a unified whole.

Management skills involve the ability of the OL to direct the group in an efficient manner to complete all required tasks throughout the OAA. For example, when arriving at the campsite, after a long day of paddling, an organized OL will have already divided the group into sub-groups to allow for multi-tasking to ensure the campsite is set up, water is collected, the fire is started and supper is prepared.

THIS PAGE INTENTIONALLY LEFT BLANK



## HOMEWORK ASSIGNMENT

Use the scenarios below to answer the following questions:

1. What competency/competencies were displayed in the scenario?
2. How were the competency/competencies displayed? Were the OL's actions positive or negative?
3. If the actions were negative, what could the OL have done to correct their actions?

### SCENARIO #1

Sarah is a new member of your club and the first trip she signs up for is yours. At the trailhead, you notice that she's quite proud of a brand new pair of boots. Fine boots or not, you know that new footwear sometimes means trouble, so you check in with her several times during the first mile or two, asking how she's doing. She tells you she's fine – in a tone of voice that suggests you mind your own business.

Most leaders would leave it at that. But your assessment of Sarah is that she's a person of tight-lipped stubbornness, with a very proud and independent spirit. Moreover, the way she was showing off her boots earlier might make her hesitate to admit that she could ever have a problem with them. In short, you're afraid Sarah won't tell you she is having a problem.

And this is a four-day trip. Anyone with serious foot problems on the first day could be in for a truly nasty time – and could slow the group down considerably. Your fears are confirmed when you see Sarah favouring her right foot. You suspect she is developing a blister and that she won't say anything until it's too late to prevent a real problem.

At the next break, you make a show of taking off your own boots to check your feet, informally commenting that this might be a good idea for everybody. Several other people follow your lead, which leaves an opening for Sarah to do the same. You bring out the moleskin and help her treat the red spot on her heel (Martin, B., Cashel, C., Wagstaff, M., and Breunig, M., *Outdoor Leadership: Theory and Practice*, Human Kinetics [pp. 72–73]).

### ANSWERS – SCENARIO #1

## **SCENARIO #2**

You're leading a rafting trip down a section of the Roughwater River that you know can get very dangerous this time of year. Two others in your group are expert rafters, but everyone else is a beginner. It's been raining hard in the mountains for two days and the river is high. That's not a problem for the first leg of the trip, but now your group has made it to Devil's Fork, where the river splits in two. The right-hand channel is no more difficult than what you've already experienced. But the left channel has serious rapids, even without the recent rains. You don't have a firsthand report of conditions, but you assume the left fork is too dangerous for the group you're leading.

When you tell the group that you're thinking of heading down the right fork, everybody nods – except Dan and Nora, who are at least as experienced as you as white-water rafters and challenge your assessment as being too conservative. They describe the trip down the left fork as “the adventure of a lifetime,” and start recruiting two more people to make a full raft. Several beginners are being swayed by their challenge.

You're tempted by their arguments – it would be a great ride. But you also know it would be irresponsible to take that degree of risk with this group. You tell everyone the decision is made – it's the right fork. With the water this high, you say, the only way any raft should go down the left fork is with a crew of four expert paddlers.

Privately, you also know that even if two people with the experience of Dan and Nora could make it down on their own, that would leave you alone with two overloaded rafts of beginners – not a safe situation even on the “easy” fork. You tell Dan and Nora that the whole group has to stick together, and that it will take the easier fork (Martin, B., Cashel, C., Wagstaff, M., and Breunig, M., pp. 122–123).

## **ANSWERS – SCENARIO #2**

### **SCENARIO #3**

The sea kayaking instructor showed up at a small inland lake to teach a course called Introduction to Sea Kayaking. After he handed out the wetsuits and basic life jackets to the students, he donned his Gore-Tex drysuit, neoprene beanie hat, and the latest life jacket, with VHF radio in the pocket, flares, whistle, compass and hydration system, a clear contrast to what the students were using. Later on, he climbed into his new Kevlar kayak while the students climbed into their plastic boats. As the day progressed, the students were amazed at how well the instructor could do the manoeuvres in his high-performance boat, while they could hardly do any in their boat. They also were intimidated by going into the cold water, even though the instructor was floating in it all the time, because of his fancy equipment (Gilberston, K., Bates, T., McLaughlin, and Ewert, A., *Outdoor Education: Methods and Strategies*, Human Kinetics [pg. 25]).

### **ANSWERS – SCENARIO #3**

THIS PAGE INTENTIONALLY LEFT BLANK

## SCENARIO

It's your third time out as a trip leader and you're taking a bunch of beginners up an easy trail to Mosquito Lake. Your group is moving a little slower than you'd like, but the weather is fair and the wildflowers are out; you figure it'll be OK to cook dinner in the dark if you have to.

Suddenly, black clouds begin to pour over a ridge to the west, and within minutes a summer storm is bearing down on you. The first drops of rain are so big they kick up dust on the trail. Lightning forks behind the peaks above and the crash of thunder is so loud and near, you know the storm centre will be on top of you in minutes.

You've just started up a long exposed ridge. If you continue up, the danger of being hit by lightning could be significant, and even if it isn't, the chance that someone will panic in a storm this big is very real. But if you head down into the forest below, you'll never make it to the lake before dark; you'll have to camp lower, and you're not sure of the water supply there.

Up until now there has been no need for anyone to 'lead' on this easy, well-travelled trail. But now things have changed. This is Ben's first trip into the mountains. He is clearly getting more worried with each flash of lightning (Graham, J., *Outdoor Leadership: Technique, Common Sense & Self-Confidence*, The Mountaineers [pp. 15–16]).

THIS PAGE INTENTIONALLY LEFT BLANK

**PHONETIC ALPHABET AND PRONUNCIATION OF NUMBERS HANDOUT**

Letter	Phonetic	Pronunciation	Letter	Phonetic	Pronunciation
A	ALFA	<u>AL</u> FAH	N	NOVEMBER	NO <u>VÈM</u> BER
B	BRAVO	<u>BRAH</u> VOH	O	OSCAR	<u>OSS</u> CAR
C	CHARLIE	<u>CHAR</u> LEE	P	PAPA	PAH <u>PAH</u>
D	DELTA	<u>DELL</u> TAH	Q	QUEBEC	KÉH <u>BECK</u>
E	ECHO	<u>ECK</u> OH	R	ROMEO	<u>ROW</u> ME OH
F	FOXTROT	<u>FOKS</u> TROT	S	SIERRA	SEE <u>AIR</u> RAH
G	GOLF	GOLF	T	TANGO	<u>TANG</u> GO
H	HOTEL	HOH <u>TÈLL</u>	U	UNIFORM	<u>YOU</u> NEE FORM
I	INDIA	<u>IN</u> DEE AH	V	VICTOR	<u>VIK</u> TAR
J	JULIETT	<u>JEW</u> LEE ÈTT	W	WHISKEY	<u>WISS</u> KEY
K	KILO	<u>KEY</u> LOH	X	X-RAY	<u>ECKS</u> RAY
L	LIMA	<u>LEE</u> MAH	Y	YANKEE	<u>YANG</u> KEY
M	MIKE	<u>MÍ</u> KE	Z	ZULU	<u>ZOO</u> LOO

Number	Pronunciation	Number	Pronunciation
0	ZE-RO	5	FIFE
1	WUN	6	SIX
2	TOO	7	SEV-EN
3	TREE	8	AIT
4	FOW-ER	9	NIN-ER

THIS PAGE INTENTIONALLY LEFT BLANK



**RADIO COMMUNICATION EXERCISE**

<b>SERIAL</b>	<b>FROM</b>	<b>TO</b>	<b>MESSAGE</b>	<b>REMARKS</b>
1	1	All stations	All stations 1 – THIS IS – 1 – RADIO CHECK – OVER	Network check.
	All stations	1	11 – LOUD AND CLEAR – OVER 11A – LOUD AND CLEAR – OVER 11B – LOUD AND CLEAR – OVER 11C – LOUD AND CLEAR – OVER 12 – LOUD AND CLEAR – OVER 12A – LOUD AND CLEAR – OVER 12B – LOUD AND CLEAR – OVER 12C – LOUD AND CLEAR – OVER 13 – WEAK BUT READABLE – OVER 13A – WEAK AND DISTORTED – OVER 13B – WEAK BUT READABLE – OVER 13C – UNKNOWN STATION – SAY AGAIN – OVER	13C did not hear the call sign of the transmitting station.
	1	All stations	All stations – THIS IS – 1 – ROGER – 13C – THIS IS – 1 – I SAY AGAIN, RADIO CHECK – OVER	
	13C	1	13C – LOUD AND CLEAR – OVER	
	1	All stations	1 – ROGER – LOUD AND CLEAR – OUT	
2	1	11, 12, 13	11, 12, 13 – THIS IS – 1 – FETCH SUNRAY – OVER	Use of appointment titles.
	11	1	11 – SUNRAY speaking – OVER	
	12	1	12 – WAIT – OUT	
	13	1	13 – SUNRAY MINOR speaking, SUNRAY not in this location – OVER	Prowords
	12	1	1 – THIS IS – SUNRAY speaking – OVER	
	1	11, 12, 13	1 – ROMEO VICTOR at GRID 159597 – OVER	Phonetic alphabet and figures.

SERIAL	FROM	TO	MESSAGE	REMARKS
	11, 12, 13	1	11 – ROGER – OVER 12 – ROGER – OVER 13 – ROGER – OVER	
	1	11, 12, 13	1 – ROGER – OUT	
3	11	11A,11B, 11C	All stations 11 – THIS IS – 11 – LONG MESSAGE – OVER	
	11A,11B, 11C	11	11A – SEND – OVER 11B – WAIT – OVER 11C – SEND – OVER	Wait less than 5 seconds.
	11B	11	11 – THIS IS – 11B – SEND – OVER	
	11	11A,11B, 11C	11 - will move to the FOXTROT UNIFORM PAPA at FIGURES 0330 hours. 11C will lead, followed by 11, 11B and 11A. MORE TO FOLLOW – OVER	Long message.
	11A,11B, 11C	11	11A – ROGER – OVER 11B – ROGER – OVER 11C – ROGER – OVER	
	11	11A,11B, 11C	11 – CALL SIGN BLUEBELL will travel to FOXTROT UNIFORM PAPA with us. 11A will bring up the rear during the march – OVER	
	11A,11B, 11C	11	11A – ROGER – OVER 11B – ROGER – OVER 11C – SAY AGAIN ALL AFTER “with us” – OVER	Prowords SAY AGAIN and AFTER.
	11	11C	11 – I SAY AGAIN ALL AFTER “with us”, “11A will bring up the rear during the march” – OVER	
	11C	11	11C – ROGER – OVER	
	11	11A,11B, 11C	11 – ROGER – OUT	
4	12	12A,12B, 12C	All stations 12 – THIS IS – 12 – LONG MESSAGE – OVER	

SERIAL	FROM	TO	MESSAGE	REMARKS
	12A,12B, 12C	12	12A – SEND – OVER 12B – SEND – OVER 12C – SEND – OVER	
	12	12A,12B, 12C	12 – will move to FOXTROT UNIFORM PAPA at FIGURES 0300 ... CORRECTION ... FIGURES 0330 hours. 12C will lead, followed by 12, 12A and 12B...MORE TO FOLLOW – OVER	Long message, makes correction.
	12A,12B, 12C	12	12A – ROGER – OVER 12B – ROGER – OVER 12C – ROGER – OVER	
	12	12A,12B, 12C	12 – PLAYTIME will be in location to top up PAPA OSCAR LIMA when we arrive at FOXTROT UNIFORM PAPA. 12C will be left, 12B center, 12A right, 12 in depth - OVER	Appointment title.
	12A,12B, 12C	12	12A – SAY AGAIN ALL BETWEEN “PLAYTIME” and “arrive” – OVER 12B – ROGER – OVER 12C – ROGER – OVER	12A missed part of the message.
	12	12A	12 – I SAY AGAIN ALL BETWEEN “PLAYTIME” and “arrive”, “PLAYTIME will be in location to top up PAPA OSCAR LIMA when we arrive” – OVER	
	12A	12	12A – ROGER – OVER	
	12	12A,12B, 12C	12 – ROGER – OUT	
5	13	13A,13B, 13C	All stations 13 – THIS IS – 13 – OVER	
	13A,13B, 13C	13	13A – ROGER – OVER 13B – ROGER - OVER	Few seconds go by.
	13	13A,13B, 13C	13 – 13A, 13B – ROGER – 13C, THIS IS 13 – OVER	Few seconds go by.
	13	13C	13C – THIS IS – 13 – OVER	
	13C	13	13C – SEND – OVER	
	13	13C	13 – ENSURE YOU MONITOR NET CONTINUOUSLY – OVER	
	13C	13	13C – ROGER – OVER	

SERIAL	FROM	TO	MESSAGE	REMARKS
	13	13A,13B, 13C	All stations 13 – we will set-up bivouac site at GRID 178342 by FIGURES 0430 hours. Expect visitors from - I SPELL ALFA DELTA VICTOR ECHO NOVEMBER TANGO UNIFORM ROMEO ECHO CHARLIE OSCAR YANKEE – OVER	Phonetic alphabet, spelling difficult words.
	13A,13B, 13C	13	13A – ROGER – OVER 13B – SAY AGAIN ALL AFTER “visitors from” – OVER 13C – ROGER – OVER	
	13	13B	13 – 13B READ BACK....I SAY AGAIN ALL AFTER “visitors from”...”visitors from I SPELL  ALFA DELTA VICTOR ECHO NOVEMBER TANGO UNIFORM ROMEO ECHO CHARLIE OSCAR YANKEE – OVER	Ensure message is understood.
	13B	13	13B – I READ BACK... visitors from I SPELL ALFA DELTA VICTOR ECHO NOVEMBER TANGO UNIFORM ROMEO ECHO CHARLIE CHARLIE YANKEE – OVER	Mistake is made.
	13	13B	13 – NEGATIVE...” visitors from I SPELL ALFA DELTA VICTOR ECHO NOVEMBER TANGO UNIFORM ROMEO ECHO CHARLIE OSCAR YANKEE – OVER	
	13B	13	13B – I READ BACK...” visitors from I SPELL ALFA DELTA VICTOR ECHO NOVEMBER TANGO UNIFORM ROMEO ECHO CHARLIE OSCAR YANKEE – OVER	
	13	13C	13 – ROGER – OUT	
6	12	13	13 – THIS IS – 12 – OVER	Passing message.
	12	13	13 – THIS IS – 12 – OVER	
	12	13	13 – THIS IS – 12 – OVER	
	13C	12	12 – THIS IS – 13C – THROUGH ME – OVER	

SERIAL	FROM	TO	MESSAGE	REMARKS
	12	13C	12 – ROGER – RELAY TO 12 – SEND Location of ROMEO VICTOR – OVER	
	13C	12	13C – ROGER – OUT	
	13C	13	13 – THIS IS – 13C – OVER	
	13	13C	13 – SEND – OVER	
	13C	13	13C – RELAY FROM 12 – “SEND Location of ROMEO VICTOR” – OVER	
	13	13C	13C – ROGER – ROMEO VICTOR is at GRID 137954 – OVER	
	13C	13	13C – ROGER – OUT	
	13C	12	12 – THIS IS – 13C – OVER	
	12	13C	12 – SEND – OVER	
	13C	12	13C – RELAY FROM 13 – “ROMEO VICTOR is at GRID 137954” – OVER	
	12	13C	12 – ROGER – OUT	
7	1	All stations	All stations 1 – THIS IS – 1 – BULL DOG – OVER	Shutting down the net.
	All stations	1	11 – BULL DOG – OVER 11A – BULL DOG – OVER 11B – BULL DOG – OVER 11C – BULL DOG – OVER 12 – BULL DOG – OVER 12A – BULL DOG – OVER 12B – BULL DOG – OVER 12C – BULL DOG – OVER 13 – BULL DOG – OVER 13A – BULL DOG – OVER 13B – BULL DOG – OVER 13C – BULL DOG – OVER	
	1	All stations	1 – BULL DOG – NOW – OUT	

THIS PAGE INTENTIONALLY LEFT BLANK

**CHAPTER 16**  
**PO 326 – PERFORM EXPEDITION SKILLS**







**ROYAL CANADIAN ARMY CADETS**  
**SILVER STAR**  
**INSTRUCTIONAL GUIDE**



**SECTION 1**

**EO M326.01 – PREPARE FOR EXPEDITION TRAINING**

---

Total Time: 30 min

---

**PREPARATION**

---

**PRE-LESSON INSTRUCTIONS**

Resources needed for the delivery of this lesson are listed in the lesson specification located in A-CR-CCP-703/PG-001, Chapter 4. Specific uses for said resources are identified throughout the instructional guide within the TP for which they are required.

Review the lesson content and become familiar with the material prior to delivering the lesson.

Obtain necessary examples of outdoor clothing and equipment.

Obtain the necessary examples of high-energy snacks if available.

Obtain the updated version of the expedition centre joining instructions.

**PRE-LESSON ASSIGNMENT**

N/A.

**APPROACH**

An interactive lecture was chosen for this lesson to orient the cadets to expedition training and their responsibilities with regard to equipment.

---

**INTRODUCTION**

---

**REVIEW**

N/A.

**OBJECTIVES**

By the end of this lesson the cadet shall be expected to prepare for expedition training.

**IMPORTANCE**

It is important for cadets to understand the importance of preparing for expedition training to allow the cadet to be more comfortable. Reviewing the joining instructions prior to undergoing training will assist cadets in preparing for training.

**Teaching Point 1****Discuss the Selection of Clothing, Footwear, and Personal and Group Equipment**

Time: 10 min

Method: Interactive Lecture



This TP is designed to familiarize cadets with the proper clothing and equipment to pack for expedition training.

This TP is an introduction to selection criteria for personal clothing and equipment as well as group equipment. Cadets should have some knowledge of this subject from previous information presented in Green and Red Star.

Have examples of outdoor clothing available if possible.

Customize the lesson to the anticipated weather for the respective expedition centre and its activities. Cadets should be advised to check the weather forecast prior to the training.

**CLOTHING**

The most effective way to maintain warmth and comfort in varying conditions is by using multiple layers of clothing, rather than just one. Layers allow one to build a microclimate that surrounds the body which can then be adapted to moisture, wind, temperature and exertion levels.



Remember:

- It is easier to stay warm than to try to warm up after getting cold.
- It takes more insulation to stay warm when sitting still than when moving.
- Heat is lost faster to a cold solid object through conduction than to cold air through convection, which is the transfer of heat by upward movement.

**FOOTWEAR**

Footwear is an important aspect of dressing for expedition training. Properly fitting, comfortable shoes/boots will make the cadet more comfortable during training. Low-ankle hiking boots are the ideal footwear. Finding shoes/boots that provide adequate ankle protection is important.



Combat boots or other military issue high-ankle support boots should not be worn during expedition training.

**PERSONAL EQUIPMENT**

Consult the joining instructions for a specific list of requisite personal kit.

Personal expedition equipment are items which benefit the participant and should be maintained by that person. Personal equipment is the kit the cadets need to carry on them.

Items to bring from home:

- **Hygiene Kit.** Includes all personal items required to maintain good health and hygiene. A hygiene kit should include:
  - camp soap (biodegradable),
  - toothbrush,
  - toothpaste,
  - toilet paper, and
  - facecloth or small towel.
- **Insect Repellent.** The active ingredient in bug repellent is DEET. Many brands are available and can be purchased at most grocery stores.
- **Lip Balm.** Lip balm with sunscreen will help protect lips. Lips burn easily at any elevation and cold dry winds can make lips crack and bleed.
- **Sunscreen.** A Sun Protection Factor (SPF) of 4 means that it will take four times longer to burn as when unprotected. Most sunburns can be prevented with a SPF of 15 with UVA and UVB protection, however an SPF of 30 or higher is recommended for most activities.
- **Sunglasses.** Protective eyewear.
- **Notepad and Pencil.** Allows for note taking/leaving a message in any situation.
- **Water Carrier.** A leak proof water bottle or canteen.
- **Camera.** Cameras are great to record new experiences.

Items that the expedition centre may provide:

- **Flashlight/Headlamp.** A flashlight/headlamp should always be carried; smaller is better to control weight (be sure to have a spare set of batteries and bulb before each trip). Headlamps allow for hands-free operation.
- **Matches.** At least 20 matches that can strike anywhere and are waterproof are best. Store matches with a striker in a separate container inside the kit (35 mm film cases would suffice).
- **Pocket Knife/Multi-tool.** Useful tool for many applications in the field. Hunting-type knives with long fixed blades are not appropriate for cadet activities.
- **Survival Kit.** Fill with useful items that are specific for the environment you will be travelling in.
- **Whistle.** For use as a signalling device in emergencies.
- **High-Energy Snacks.** As detailed in TP 2.

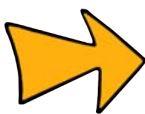

There may be a requirement for each participant to have a plate, a bowl and cutlery depending on food being consumed during expedition training.

## GROUP EQUIPMENT

Group equipment should be selected for its versatility, weight and ease of use and packing. The more compact an item is or can become, the easier it will be to pack and carry.

Group equipment will be given to cadets upon arrival at the expedition centre.

---

## CONFIRMATION OF TEACHING POINT 1

---

### QUESTIONS

- Q1. What is the most effective way to maintain warmth and comfort in varying conditions?
- Q2. What is the ideal footwear for expedition training?
- Q3. What are the personal items a cadet should bring to the expedition centre?

### ANTICIPATED ANSWERS

- A1. The most effective way to maintain warmth and comfort in varying conditions is by using multiple layers of clothing, rather than just one garment.
- A2. Low-ankle hiking boots are the ideal footwear for expedition training.
- A3. The personal items that should be brought to the expedition centre are:
- hygiene kit,
  - insect repellent,
  - lip balm,
  - sunscreen,
  - sunglasses,
  - notepad and pencil,
  - water carrier, and
  - camera.

---

### Teaching Point 2

### Discuss High-Energy Snacks

Time: 5 min

Method: Interactive Lecture

---



This TP is designed to introduce cadets to the importance of eating and snacking while performing high-energy activities.

Use actual food examples if available.

Food is one of the most important factors to consider when expending large amounts of energy during activities. Choosing the right snacks to supplement meals is important to maintain energy and nutrition.



People are more prone to injuries around 1100 hours and 1500 hours when blood sugar is low and people are tired from activities.

### GRANOLA BARS

Granola bars are an easy snack that can be brought on the trail with little waste. The wrapper of the granola bar can be folded and placed in a resealable plastic bag for disposal. When eating on the move, the wrapper can simply be placed in a pocket.

Granola bars come in a variety of flavours and often include chocolate. The nutrition in granola bars is largely grain based and provides a high calorie count. Granola bars often have 10–14 grams of sugar and 11–16 grams of fat.



Stay away from granola bars with more than 20 percent fat. These bars will only impede energy levels.

## DRIED FRUIT AND NUTS

Dried fruits last for months, and keeps most of their nutritional value. Dried fruit provides energy benefits without the added weight of 80 percent water content. Most grocery stores have varieties of mixed fruit, which can be dried at home.



### Homemade Dried Apples

1. Slice the apples thinly.
2. Place on baking tray in a single layer.
3. Place in oven on a low temperature setting (60 degrees Celsius [140 degrees Fahrenheit]).
4. Check dryness every 20 minutes.
5. Crack open the oven door to remove moist air and improve result.

This process can take up to four hours.

Seeds and nuts are great sources of carbohydrates, protein and fat. Proteins are an essential part of any diet; known as the “don’t leave home without it” snack. The high fat content will slow digestion so seeds and nuts are best used for refuelling during longer breaks. Nuts also provide magnesium, guarding the muscles against burn from lactic acid.

## CHEESE

A good source of dairy on the trail, cheese is a great form of calcium.



Cheese with a high moisture content does not keep well when not refrigerated for extended periods of time.

Cheeses with a low moisture content include:

- cheddar,
- colby, and
- swiss.

Cheeses with low moisture content can keep longer. The liquefied milk fat will run off at high temperatures. While this is not a pleasant sight, it is not a sign of spoilage.

## “GOOD OLD RAISINS AND PEANUTS” (GORP)

“Good old raisins and peanuts,” is just that – a mixture of raisins, peanuts and anything else a person might want to add. There is often a sugar source like chocolate chips added to a dried fruit.

There are many varieties of GORP recipes. GORP can be bought in most groceries stores – pre-made – or made at home. Everyone has their favourite recipe. A person’s GORP may change every expedition depending on what is available, or what they feel like eating.



Small items like sunflower seeds will settle to the bottom of the bag while larger items will float to the top. Mix up the contents of the bag before eating.



### Simple GORP Recipe:

118 mL (1/2 cup) peanuts,  
118 mL (1/2 cup) raisins,  
59 mL (1/4 cup) chocolate chips\*, and  
59 mL (1/4 cup) dried cranberries.

\*In warmer weather, chocolate chips can be substituted with candy-coated chocolate which will not melt.

Mix in a bowl and store in an air tight container or resealable bag.

This makes a little more than 354 mL (1 1/2 cups). Add or take away items as you like.

Examples of food items to put in GORP:

- dried apples,
- banana chips,
- dried papaya,
- dates,
- dried cranberries,
- coconut,
- almonds,
- cashews,
- peanuts,
- chocolate,
- carob chips,
- candy-coated chocolate,
- chocolate or yogourt covered raisins,
- sunflower seeds,
- dried green peas, and

- pretzels.

---

## CONFIRMATION OF TEACHING POINT 2

---

### QUESTIONS

- Q1. When are people more prone to injuries on the trail?
- Q2. What nutrients are in nuts?
- Q3. What is GORP?

### ANTICIPATED ANSWERS

- A1. People are more prone to injuries around 1100 hours and 1500 hours when blood sugar is low and people are tired from activities.
- A2. Nuts are great source of carbohydrates, protein and fat.
- A3. Good old raisins and peanuts. There is often a sugar source like chocolate chips added to dried fruit.

---

### Teaching Point 3

### Review, and Brief the Cadets on the Joining Instructions and Training Schedule for Silver Star Expedition Training

Time: 10 min

Method: Interactive Lecture



This TP is designed to introduce and brief cadets on what is required during training at the expedition centre.

Review joining instructions and after briefing cadets, answer any questions the cadets have.

### RISKS IN EXPEDITION TRAINING

Activities conducted at the expedition centres will likely include hiking, biking, canoeing and camping. With all adventure activities there are inherent risks. Risk is the chance or possibility of danger, loss or injury. Each activity has its own risks.

Hiking is the activity of walking outdoors on unpaved trails in a wilderness environment and may include many types of terrain and environments. It is not uncommon for cadets to be injured by tripping, falling and slipping over wet roots or rocks, or falling down a small slope.

Mountain biking is riding a bike on trails and secondary roads, using specialized equipment. Cadets are at risk of falling off the bike, or not using the bike properly which may cause injury. Injuries that may occur mountain biking are cuts and scrapes, bruising, flesh wounds, or broken bones.

Canoeing is travelling by canoe. Cadets should be seated, wearing PFDs and acting responsibly while canoeing. These actions will minimize the risks associated with canoeing.



Canoeing is of great cultural significance to Canadians and canoeing in expedition training allows cadets to see Canada's wilderness from a different perspective.



Refer to CATO 40-01, *Army Cadet Expedition Program* for general expedition information.

### **Medical Information**

The Medical Information Form is located in A-CR-CCP-951/PT-002, Chapter 1, Annex B. This form must be completed by all cadets prior to undertaking expedition training. This form asks general questions regarding health.

### **Consent to Adventure Training**

In addition to the medical form, the Consent to Adventure Training form, Chapter 1, Annex A to A-CR-CCP-951/PT-002, must be filled out by participating cadets. This form advises instructors and organizers that the cadet understands what they are undertaking and will comply with all rules and regulations.

### **Policies**

Prior to participating in expedition training, all cadets shall be reminded of the following policies:

- CATO 11-08, *Environmental Stewardship Policy*,
- CATO 13-23, *Drug and Alcohol Policy*,
- CATO 13-24, *Harassment Prevention and Resolution Policy*,
- CATO 13-26, *Return To Unit Policy*, and
- CATO 15-22, *Cadet Conduct and Discipline Policy*.

### **JOINING INSTRUCTIONS**

Joining instructions are issued to provide cadets with all the required information they may need to arrive at the expedition centre prepared and capable of performing the required training. They are issued for all activities outside of the local cadet corps.

Each region will have different joining instructions for each expedition centre.



Joining instructions for expedition training can be found at the regional website, through [www.cadets.ca](http://www.cadets.ca).

The joining instructions will have information such as:

- general information on the activity,
- directions to the expedition centre,
- dates of training,
- transportation requirements,
- what identification is required,
- administrative and claim information,



- rations and quarters information,
- uniform requirements,
- expected cadet conduct, and
- required kit list.

Joining instructions will often have a schedule/timetable included.

---

### CONFIRMATION OF TEACHING POINT 3

---

The cadets participation in the briefing on the expedition centres training weekend will serve as confirmation of this TP.

---

### END OF LESSON CONFIRMATION

---

The cadets participation in the briefing of the expedition centres training weekend will serve as confirmation of this lesson.

---

### CONCLUSION

---

#### HOMEWORK/READING/PRACTICE

N/A.

#### METHOD OF EVALUATION

N/A.

#### CLOSING STATEMENT

Participating in a briefing on the local expedition centre, wearing clothing, and bringing equipment and snacks will better prepare cadets for the upcoming challenges of expedition training.

#### INSTRUCTOR NOTES/REMARKS

The joining instructions and timetable referred to in TP 3 will vary depending on the region. Instructors should acquire these from the local expedition centre.

This EO should be conducted in the two weeks preceding the cadet's Silver Star expedition centre training weekend.

---

### REFERENCES

---

- |        |   |
|--------|---|
| A2-001 | A-CR-CCP-951/PT-002 Director Cadets 3 (2006). <i>Royal Canadian Army Cadets Adventure Training Safety Standards</i> . Ottawa, ON: Department of National Defence.       |
| C2-051 | (ISBN 978-0-7153-2254-3) Bagshaw, C. (2006). <i>The Ultimate Hiking Skills Manual</i> . Cincinnati, OH: David & Charles.  |
| C2-066 | (ISBN 1-4000-5309-9) Curtis, R. (2005). <i>The Backpacker's Field Manual: A Comprehensive Guide to Mastering Backcountry Skills</i> . New York, NY: Three Rivers Press. |

THIS PAGE INTENTIONALLY LEFT BLANK



**ROYAL CANADIAN ARMY CADETS**  
**SILVER STAR**  
**INSTRUCTIONAL GUIDE**



**SECTION 2**

**EO M326.02A – PADDLE A CANOE**

---

Total Time:

165 min

---

**PREPARATION**

---

**PRE-LESSON INSTRUCTIONS**

Resources needed for the delivery of this lesson are listed in the lesson specification located in A-CR-CCP-703/PG-001, Chapter 4. Specific uses for said resources are identified throughout the instructional guide within the TP for which they are required.

Review the lesson content and become familiar with the material prior to delivering the lesson.

**PRE-LESSON ASSIGNMENT**

N/A.

**APPROACH**

An interactive lecture was chosen for TPs 1–3, and TP 6 to orient the cadet, generate interest and present basic or background material on canoeing, canoeing equipment, and safety procedures.

Demonstration and performance was chosen for TPs 4, 5, and 9 as it allows the instructor to explain and demonstrate portaging a canoe, outfitting a canoe, and basic canoe strokes while providing an opportunity for the cadet to practice these skills under supervision.

Demonstration was chosen for TPs 7 and 8 as it allows the instructor to explain and demonstrate launching/landing and the canoe over canoe assisted rescue in a controlled environment.

A practical activity was chosen for TP 10 as it is an interactive way for the cadet to experience paddling a canoe in a safe, controlled environment during an expedition. The expedition contributes to the development of canoeing knowledge and skills in a fun and challenging setting on-water.

---

**INTRODUCTION**

---

**REVIEW**

N/A.

**OBJECTIVES**

By the end of this lesson the cadet shall have identified the parts of the canoe and the paddle; demonstrated how to: properly outfit a canoe with safety equipment, prepare for on-water activities and launch and land a canoe; performed a canoe over canoe assisted rescue; and performed basic canoe strokes.

## IMPORTANCE

It is important for cadets to know the parts of the canoe and paddle, so they can respond to direction given by instructor when participating in canoeing activities. To ensure safety of individual cadets and those around them when canoeing it is critical that all cadets: understand how to outfit a canoe with the required safety equipment; know how to communicate with paddle and whistle signals; know how to properly fit a Personal Floatation Device (PFD); understand portaging, launching and loading procedures; have an awareness of emergency rescue procedures; and are able to manoeuvre their canoe on water.

---

### Teaching Point 1

### Identify the Parts of a Canoe

Time: 5 min

Method: Interactive Lecture

---



It is important that cadets can see the canoe and its parts. A canoe should be on site and as the parts are identified, the instructor or an assistant should point to the respective part.

There are many different styles of canoes. The technological improvements in canoe building have made it quite difficult to choose an ineffective canoe. Despite the advances in design, the basic elements of the canoe remain the same. The parts of the canoe are:

**Bow.** The bow is the front section of the canoe. The bow can be easily spotted by looking at the seats. There is more leg room between the end of the canoe and the bow seat.

**Stern.** The stern is the back section of the canoe; most of the steering is done from the stern.

**Gunwales.** Gunwales are the upper edges of the sides of the canoe.

**Thwart.** The thwart on a canoe is a crosspiece which is attached on either side to the gunwales, two-thirds of the way back from the bow. The thwart provides structure and support to the gunwales and to the hull.

**Hull.** The hull is the body of the canoe which displaces water and provides the buoyancy for the canoe.

**Keel.** The keel is a narrow strip that runs along the centre of the bottom of the hull from bow to stern. The keel helps to provide better tracking (movement in a straight line) and stability; as well as providing a small barrier between the ground and the hull.

**Bow Seat.** The bow seat is located in the front (bow) of the canoe. It is further from the end of the canoe to provide leg room for the bow paddler.

**Stern Seat.** The stern seat is located in the back (stern) of the canoe. It is narrow and fastened to the gunwales closest to the rear of the canoe.

**Bow Handle.** The bow handle is a handhold at the bow, used for lifting and carrying. It is sometimes called the bow carrying thwart.

**Stern Handle.** The stern handle is a handhold at the stern, used for lifting and carrying. It is sometimes called the stern carrying thwart.

**Deck Plate.** The deck plate is a triangle piece of material that is fastened between the gunwales at both ends of the canoe. It is often called the bow deck and the stern deck. The deck plate provides a convenient handhold in the case of no bow or stern handle, as well as a place to attach a painter line.

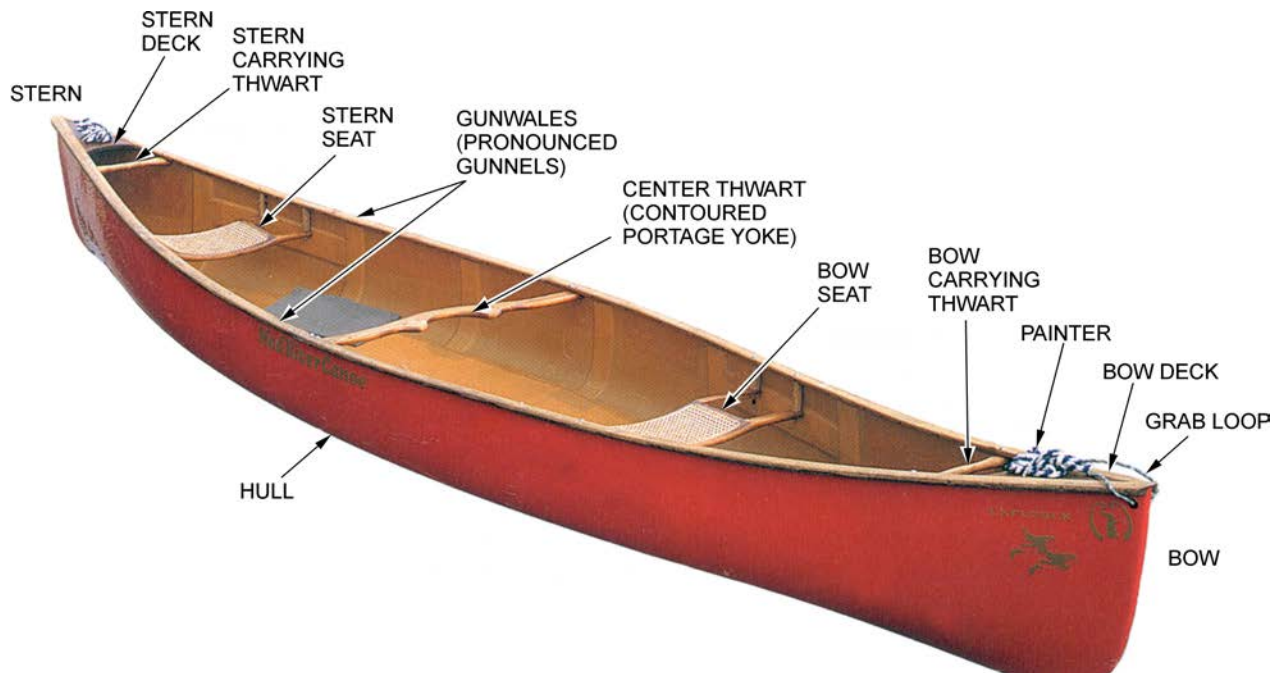

G. McGuffin & J. McGuffin, *Paddle Your Own Canoe*, The Boston Mills Press (p. 13)

Figure 16-2-1 Parts of the Canoe

---

### CONFIRMATION OF TEACHING POINT 1

---

#### QUESTIONS

- Q1. What are the front and back of the canoe called?  
 Q2. What is the hull?  
 Q3. Where is the keel?

#### ANTICIPATED ANSWERS

- A1. The front and back of the canoe are called the bow and the stern.  
 A2. The hull is the body of the canoe which displaces water and provides the buoyancy for the canoe.  
 A3. The keel is at the bottom of the canoe, running from bow to stern.

---

#### Teaching Point 2

#### Discuss Paddles

Time: 5 min

Method: Interactive Lecture



Have a paddle available to help illustrate the parts.

The paddle is the most important piece of equipment required to canoe, with the exception of the canoe itself. The paddle provides the momentum to move the canoe.

## PARTS OF A PADDLE

**Shaft.** The shaft is the narrow neck of the paddle between the grip and the blade.

**Grip.** The grip is found at the top of the paddle shaft and is where the paddler holds the paddle.

**Throat.** The throat is located at the bottom of the shaft, where the paddler's shaft hand holds the paddle.

**Blade.** The blade is the part of the paddle that is placed in the water. The blade has two sides:

- **Power Face.** The power face is the side of the paddle blade that presses against the water during a forward stroke.
- **Back Face.** The back face is the side of the paddle blade that has no pressure against it during a forward stroke. The back face is the opposite side of the power face.

**Tip.** The tip is the very bottom edge of the paddle blade.

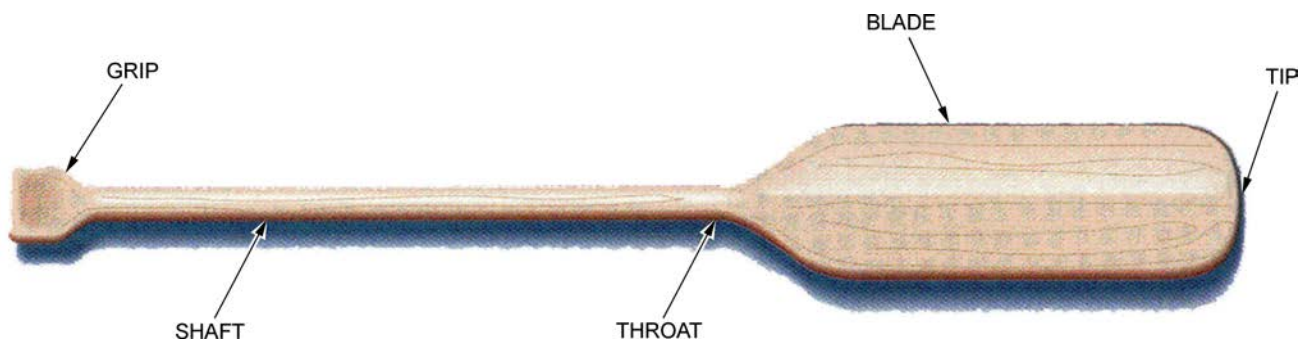

*L. Guillon, Outdoor Pursuits Series: Canoeing, Human Kinetics Publishers (p. 21)*

Figure 16-2-2 Parts of a Paddle

## SIZING A PADDLE

When selecting a paddle, it is important to size it correctly. Torso length, canoe seat height and paddling style will determine the proper paddle length.

Most tandem paddlers will require a paddle length between 137 cm (54 inches) and 147 cm (58 inches). Shorter paddles allow for higher tempo strokes. If the grip hand is above the head during strokes, the paddle is too long.



Paddle length will differ with individual preference, based on comfort and efficiency.

When choosing a paddle from a group of paddles, there are two ways to size a paddle.

1. Hold the paddle in both hands over your head with one hand on the grip and the other on the shaft, close to the throat. With the paddle rested on the head, the arms should be able to bend comfortably at the elbow in a 90 degree bend.
2. Hold the paddle in one hand and rest the blade on the top of the foot. The grip should come to the chin.

## HOLDING A PADDLE CORRECTLY

The paddle is held in both hands. One hand will hold the grip (control hand) and the second hand, called the shaft hand, will hold the paddle somewhere between the shaft and the throat of the paddle. If the paddler has shorter arms, the shaft hand will be higher up on the shaft.

---

## CONFIRMATION OF TEACHING POINT 2

---

**QUESTIONS**

- Q1. Where does the paddler hold the paddle?
- Q2. What is the shaft?
- Q3. What are the two sides of the paddle blade?

**ANTICIPATED ANSWERS**

- A1. The paddler holds the paddle at the grip and the throat of the shaft.
- A2. The shaft is the narrow neck of the paddle between the grip and the blade.
- A3. The two sides of the paddle blade are the power face and the back face.

**Teaching Point 3****Discuss PFDs**

Time: 10 min

Method: Interactive Lecture



Have a lifejacket and a PFD available to show the differences between each one to the cadets.

There are many people who use the water for both recreational activities and job-related duties. A lifejacket/PFD is used to assist in keeping a person afloat if they should fall into the water.



Government of Canada regulations state that anyone who is on and near the water, must have a Coast Guard/Transport Canada approved floatation device.

**THE DIFFERENCE BETWEEN A LIFEJACKET AND A PFD**

When in the water, a lifejacket is designed to keep the user's face up even if they are unconscious.

A PFD does not have the ability to turn the user face up but provides buoyancy (the ability to float without kicking or using arms).

**Construction of a PFD**

The Canadian Coast Guard regulates the construction of PFDs. When choosing a PFD, look for:

- Canadian Coast Guard/Transport Canada approved symbol;
- protection against hypothermia;
- allowance for maximum body movement;
- proper fit;
- ease of putting on and taking off; and

- rating for the user's weight.

### Care Instructions for a PFD

Caring for a PFD is important in order to prolong its life.

The following is a list of PFD don'ts:

- dry clean,
- alter, or repair a PFD,
- use cleaners,
- leave in the sun for long periods,
- leave near direct heat (fires, radiators, hair dryer),
- place under heavy objects,
- use as a cushion or kneeling pad, or
- attach to a boat.

Before using a PFD it should be checked for:

- rips and tears,
- damage to seams and buckles, straps or zippers, and
- signs of waterlogging, mildew or hardening of the buoyant material.

### FITTING A PFD

Fit is the most important thing when selecting a PFD. A PFD should:

- not be able to be pulled off easily,
- fit snugly, and
- be properly fastened.



A PFD must always be worn on and near water, and worn as the top layer.



Refer to A-CR-CCP-030/PT-001 *Water Safety Orders* for more information.

---

### CONFIRMATION OF TEACHING POINT 3

---

### QUESTIONS

- Q1. What is the difference between a lifejacket and a PFD?
- Q2. What is the approving body for PFDs and lifejackets in Canada?
- Q3. How should a PFD fit?



## ANTICIPATED ANSWERS

- A1. A lifejacket is designed to keep the user's face above water, while a PFD only provides buoyancy.
- A2. Canadian Coast Guard/Transport Canada is the approving body for PFDs and lifejackets in Canada.
- A3. A PFD should:
- not be able to be easily pulled off;
  - fit snugly; and
  - be properly fastened.

### Teaching Point 4

### Explain, Demonstrate and Have the Cadet Practice Portaging a Canoe

Time: 15 min

Method: Demonstration and Performance



For this TP, it is recommended that instruction take the following format:

1. Explain and demonstrate each method of portaging while the cadets observe.
2. Explain and demonstrate each step required to complete each method of portaging. Monitor the cadets as they practice each step.
3. Monitor the cadets' performance as they practice each method of portaging.

**Note:** Assistant instructors may be used to monitor the cadets' performance.

## CARRYING A CANOE TO THE WATER

Once a canoe is off the vehicle or trailer, it still needs to get to the water. There are several ways to carry a canoe; having one person at each end is a typical way. Hand and arm placement should allow for maximum comfort and provide balance and security against dropping.



It is critical that the canoe is not dragged along the ground. This damages the keel and the bottom of the canoe which may result in holes.

### Tandem Hand Carry

For a short distance over relatively flat ground, a canoe can be carried much like a briefcase. This is referred to as the tandem hand carry.

To execute the tandem hand carry:

1. The bow paddler will stand at the bow on the left or right of the canoe.
2. The stern paddler will stand at the stern on the side opposite to the bow paddler.
3. Each paddler will lift the canoe by the handle at their end.



L. Guillon, *Outdoor Pursuits Series: Canoeing*, Human Kinetics Publishers (p. 36)

Figure 16-2-3 Tandem Hand Carry

### **Tandem Portage Carry**

For longer distances, a canoe can be carried on the shoulders in the tandem portage carry. The canoe is lifted over the head and carried in such a manner that the stern seat rests across the shoulders of the person at the rear and the bow deck rests on one shoulder of the person in front.

To execute the tandem portage carry:

1. Stand up straight, with the legs slightly apart and knees bent. Grasp the gunwale closest to the body, near the bow and stern seats respectively. Place the fingers inside the gunwale and the thumbs outside the gunwale.
2. Keeping the back straight and knees bent, lift the canoe to the thighs in a rocking motion.
3. Reach across the canoe and grasp the far gunwale. The fingers are pointing out and the thumb is in. Reposition the hand from step one so that the fingers are out and the thumb is in.
4. Rocking the canoe again, use your legs to launch and lift the canoe over the head.
5. As the canoe is raised, turn to face the bow and then guide the bow and stern seats onto the shoulders.
6. Rest the weight of the canoe on the shoulders. The bow person will move further forward to improve visibility.
7. To move forward, the bow paddler hand-walks along the gunwale toward the front of the canoe. Balance the canoe's weight side to side and bow to stern.
8. Rest the deck plate on the bow paddler's shoulder.





A. Westwood, *Canoeing: The Essential Skills and Safety*, Heliconia Press (p. 136)

Figure 16-2-4 (Sheet 1 of 2) Tandem Portage Carry Steps 1-8

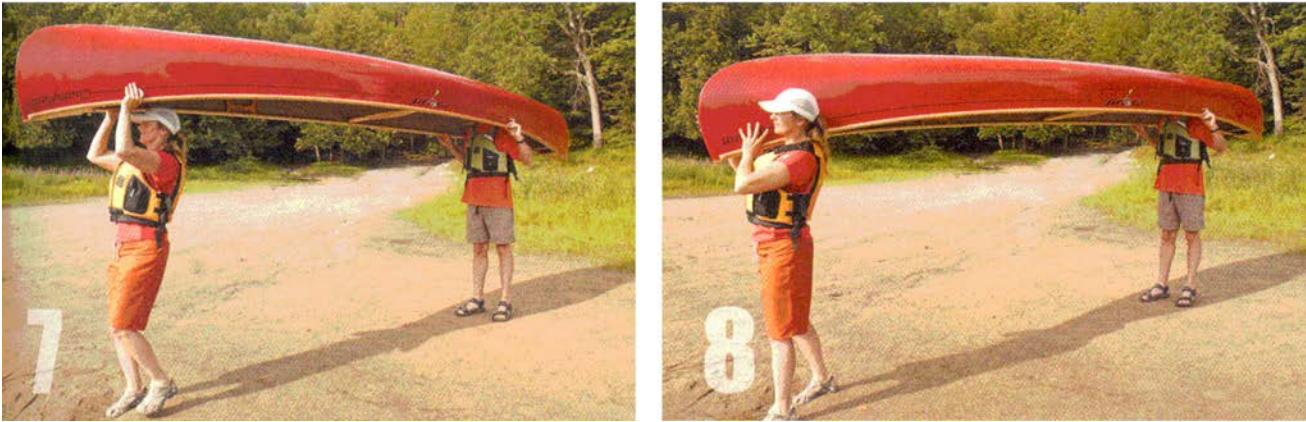

A. Westwood, *Canoeing: The Essential Skills and Safety*, Heliconia Press (p. 136)

Figure 16-2-4 (Sheet 2 of 2) Tandem Portage Carry Steps 1–8

---

### CONFIRMATION OF TEACHING POINT 4

---

#### QUESTIONS

- Q1. Why does dropping a canoe normally occur?
- Q2. What are the different ways a canoe can be carried to the water?
- Q3. When the portage is very long, what is the best way of carrying the canoe?

#### ANTICIPATED ANSWERS

- A1. Dropping a canoe is usually caused by incorrect placement of the hands.
- A2. A canoe can be carried to the water by the tandem hand carry or the tandem portage carry.
- A3. When a portage is very long, the best way to carry the canoe is by the tandem portage carry.

---

#### Teaching Point 5

#### Explain, Demonstrate and Have the Cadet Practice Outfitting a Canoe With Safety Equipment

Time: 15 min

Method: Demonstration and Performance

---



For this skill TP, it is recommended that the instruction take the following format:

1. Explain and demonstrate the complete process of outfitting a canoe while the cadets observe.
2. Explain and demonstrate each step to outfit a canoe. Monitor the cadets as they practice each step.
3. Monitor the cadets' performance as they practice the complete skill of outfitting a canoe.

**Note:** Assistant instructors may be used to monitor the cadets' performance.

Every boat that enters the water has to be outfitted with certain safety equipment that is required by law. The Canadian Coast Guard and Transport Canada deem every canoe must have the following safety equipment:



## BUOYANT HEAVING LINE OR THROW BAG

One buoyant heaving line not less than 15 m (49 ft) in length must be available for use in emergencies such as capsized paddlers. The heaving line shall be capable of floating and shall be attached using a figure-of-eight knot, or by clipping the throw bag to the thwart or bow handle.



A throw bag is a nylon rescue bag with a length of rope stuffed loosely inside, so it can pay out through the top when thrown to a person in the water.

## BAILER

A bailer is any container capable of removing water from a canoe. It must be made of plastic or metal, with an opening of 65 cm<sup>2</sup> (25 in<sup>2</sup>) and a minimum volume of 750 mL (25 oz). The bailer will be attached to the thwart of the canoe using a clove hitch.

## SPARE PADDLE

In addition to the paddles used by the paddlers, a third paddle is required in the case that one is lost, broken or forgotten on shore. The spare paddle should be secured, but immediately available in an emergency. Lashing the paddle into the canoe is not recommended.

## WHISTLE

A pealess whistle or noise-making device is required to communicate with other paddlers and signal in case of emergency. The whistle is often attached to the paddler's PFD, if not, it should be worn on a cord around the paddler's neck.

## WHITE NAVIGATION LIGHT

The white navigation light is a watertight flashlight complete with working batteries. This light can be used to signal other paddlers and during an emergency. It is attached to the bow plate using a carabiner or a piece of cordage.



The cadets are to be introduced to the requirement for a white navigation light as safety equipment, however, as cadets will not canoe at night, there is no requirement to use this device when outfitting a canoe.

## PAINTER LINES

Painter lines are two lines 6 m (19 feet) in length made of 10 mm (0.3 inches) buoyant polypropylene rope, with no knots. The lines are attached to the bow (bow line) and stern (stern line) of a canoe. They are used for pulling the canoe through shallow water and securing it to the shoreline or other stationary object. Painter lines will be attached to the bow and stern handles using a re-woven figure-of-eight knot.

## PFD

A vest style jacket filled with foam panels or tubes that provide buoyancy. A PFD must be worn when an individual is within 3 m (10 feet) or less of the shoreline, prior to or upon completion of an on-water activity and when they are on the water. It is important to ensure that the PFD is properly zipped and buckled prior to moving to the waters edge.



The A-CR-CCP-030/PT-001, states “the PFD shall always be worn over the outer layer of clothing. When worn, the PFD must have all fasteners and tighteners secured as they are intended to be used. A properly fitted PFD should be snug around the cadet’s upper body when in or out of the water. The PFD should not ride up to the cadet’s face when all fasteners and tighteners are fitted and secured. If it is riding up under these conditions, a smaller size is required.”



The A-CR-CCP-951/PT-002, states that one Canadian-approved PFD or lifejacket of appropriate size must be available for each person participating in on-water activities.

---

### CONFIRMATION OF TEACHING POINT 5

---

The cadets’ participation in outfitting a canoe with safety equipment will serve as the confirmation of this TP.

---

#### Teaching Point 6

#### Discuss Safety Concerns While Canoeing

Time: 10 min

Method: Interactive Lecture

---



When completing any cadet training, safety is always the main concern. This is also the case when cadets are in an unknown area or unfamiliar terrain, such as a body of water. It is important to consider hazards and to get to know the strengths and limitations of the members of the group.

Discuss responsibilities on water and passing procedures.

### UNDERSTAND PERSONAL RESPONSIBILITIES

#### Skill Level

It is the responsibility of the paddler to ensure that they have the proper skill set for paddling. Participants should always advise staff when they feel uncomfortable or unprepared for any aspect of canoe training.

#### Physical Fitness

Fitness and well-being are an important part of canoeing. Individuals must take responsibility for themselves. Every paddler must make sure they are physically and mentally prepared for paddling.

Physical preparedness includes having the endurance to be able to paddle the entire trip. The paddler should not be suffering from a cold or illness, and should not have any physical injuries, such as cramped or sore muscles.

### IDENTIFY PADDLE SIGNALS



When explaining paddle signals, it is important for cadets to see the signal in action. Demonstrate all paddle signals.

The water can be a noisy place. Using a whistle, paddle or gestures are the best ways of getting the attention of other paddlers.

Before heading out on any body of water, it is important to know and understand universal paddle signals. Paddle signals are important in times when there is distance between canoes and it is difficult to hear. Good communication on the water is essential to prevent accidents and ensure swift emergency response.



When receiving a signal, it is important to repeat the signal to the sender and pass the signal on to paddlers behind.

Paddle signals are used to alert the entire group to the direction of travel or to an unexpected situation, such as an overturned canoe.

**Stop.** To communicate the stop signal, form a horizontal bar with the paddle and move with an up and down motion until remaining paddlers see it. If you are already stationary, stay where you are. Wait for the all clear signal before proceeding.



*J. Rounds, Basic Kayaking: All the Skills and Gear You Need to Get Started, Stackpole Books (p. 83)*

Figure 16-2-5 Stop



Paddle signals should be given to indicate the direction of travel; not the location of the obstacles.

**Help Required/Emergency.** To communicate the help required/emergency signal, a paddle, helmet or a bright object (not a PFD) are waved in a continuous motion side to side above the head. This means “assist the signaller as quickly as possible”.



*J. Rounds, Basic Kayaking: All the Skills and Gear You Need to Get Started, Stackpole Books (p. 83)*

Figure 16-2-6 Emergency

**Raft Up.** To communicate the raft up signal, raise the paddle vertically above the head and move in a circular motion. This signal means “come to me”.

**All Clear.** To communicate the all clear signal, extend the paddle over the head vertically. Maintain the paddle in the air in order to ensure that all members of the group have seen the signal. This signal is used when it is safe to continue on and indicates that there are no obstructions or danger ahead.

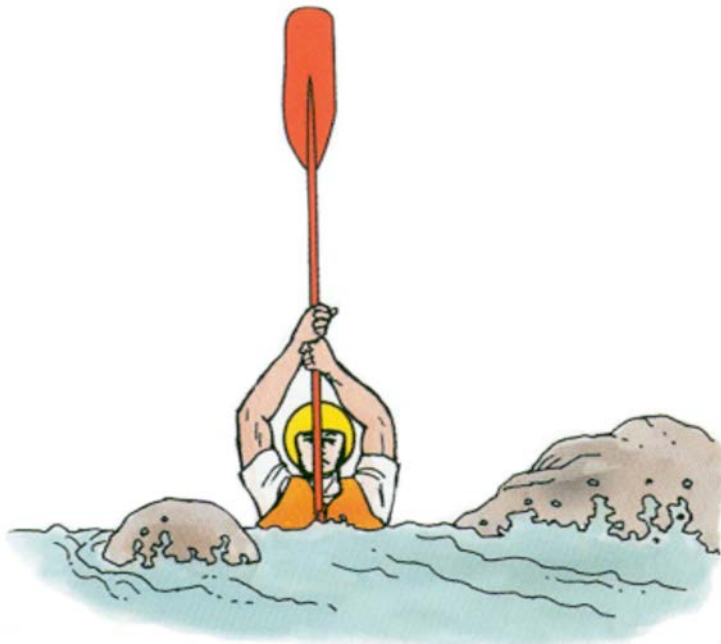

*J. Rounds, Basic Kayaking: All the Skills and Gear You Need to Get Started, Stackpole Books (p. 83)*

Figure 16-2-7 All Clear



## IDENTIFY WHISTLE SIGNALS



When explaining whistle signals, it is important for cadets to hear the signal in action. Demonstrate all whistle signals.

A whistle is an effective way to get the attention of other paddlers when visibility is limited and there is a lot of noise. Before heading out on any body of water, it is important to know and understand universal whistle signals. Good communication on the water is essential to prevent accidents and ensure swift emergency response.



Cadets shall be reminded that they will not play with or blow whistles unless they are in an emergency situation.

**Universal Distress Signal.** Three whistle blasts indicate that there is an emergency. All action should stop, and action should be taken for the emergency. This signal means: assist the signaller as quickly as possible.



*J. Rounds, Basic Kayaking: All the Skills and Gear You Need to Get Started, Stackpole Books (p. 83)*

Figure 16-2-8 Universal Distress Signal

**Move to Shore/Raft Up.** This signal indicates that there is a need for the group to get together. When two whistle blasts are heard, all personnel will look to the instructor or group leader for instructions and guidance on where to meet up, whether to move to the shore or to raft up at a given point. It should only be used when other forms of communication are not working.

**All Clear/Look at Me.** When one whistle blast is heard, focus attention on the instructor (look at me). It is used to get the attention of the group. This signal could also mean all clear.



As there are alternative meanings for one and two whistle blasts, it is imperative that the group understands what the signal means for their group. The team/group leader will specify before moving to the water.



Any series of three signals such as three whistle blasts or three horn blasts indicates an emergency. Immediately stop all activity and assist.

---

## CONFIRMATION OF TEACHING POINT 6

---

### QUESTIONS

- Q1. What are the personal responsibilities of the paddler when canoeing?
- Q2. What is the paddle signal for raft up?
- Q3. What action is to be taken when two whistle blasts are heard?

### ANTICIPATED ANSWERS

- A1. The personal responsibilities of the paddler include:
- making sure they are physically prepared; and
  - ensuring that they have the proper skill set.
- A2. To signal raft up, the paddler will raise their paddle vertically above the head and move it in a circular motion.
- A3. When two whistle blasts are heard, all personnel will look to the instructor or group leader for instructions or guidance on where to meet up.

---

### Teaching Point 7

### Explain and Demonstrate Launching and Landing a Canoe

Time: 10 min

Method: Demonstration

---



For this teaching point, it is recommended that instruction take the following format:

1. Explain and demonstrate launching and landing a canoe while the cadets observe.
2. Explain and demonstrate each step required to complete the skill.

**Note:** Cadets will be given the opportunity to practice this skill during the on-water training and the practical activity.

### IDENTIFYING A LOCATION

Putting a canoe on water and taking it out of water should be done carefully, smoothly and without damage to the canoe.

The ideal location to launch a canoe is a soft shore or beach where the water is calm. Avoid locations where there are large rocks, stumps and roots, strong wind or large waves.

If you are launching from a shallow beach, launch the canoe at a right angle to the beach and hold it with its stern touching the bottom at the water's edge.

## AVOIDING EQUIPMENT DAMAGE

A canoe should not be pushed, pulled or slid in or out of the water on a beach, bank, or dock. When launching, it is best to lay the canoe in the water from a lift position. It should be raised with the same care when being taken out of the water.

The canoe should be empty when launching. Once the canoe is placed on the water, it can be loaded with equipment while it is floating.

## ENTERING A CANOE

Getting into a canoe for the first time is difficult; with practice, it will become easier. The stern paddler should always hold the canoe steady while the bow paddler enters. Likewise, once the bow paddler has entered the canoe, they will steady the canoe, using their paddle and body, while the stern paddler enters.

The steps for getting into a canoe are:

1. Keep the body low at all times, to lower the centre of gravity; never stand in a canoe.
2. Place the paddle shaft across the gunwales for stability.
3. Grasp both gunwales and step into the canoe over the centreline.
4. Step along the centreline and slide the hands and paddle along the gunwales to move to the seat.

## LAUNCHING A CANOE

### Launching at a Shoreline



Launching and landing a canoe in waves is inadvisable. Wait for a lull and keep the canoe at a right angle to the water.

If the canoe swamps at any time, avoid getting between the canoe and the shore. A canoe full of water weighs approximately 1 ton (1 000 kg) and can seriously injure a paddler.

There are several ways to launch a canoe from shore. The most common is the bow first launch:

Procedure for the bow first launch:

1. Put on a PFD and have paddles in the canoe or on the shoreline. Set the canoe at a right angle to the shore.
2. Place the spare paddle and stern paddle in the centre of the canoe. Have the stern paddler hold the canoe while the bow paddler walks up the length of the canoe keeping low, along the centreline. Stability is maintained by keeping the paddle shaft across the gunwales.
3. Have the bow paddler sit or kneel and place the paddle in the ready position as detailed in Figure 16-2-9. The stern paddler will hold the paddle shaft across the gunwales for stability.
4. Have the stern paddler slide their paddle forward along the gunwales, continuing to hold both paddle shaft and gunwales. The blade is positioned on the side opposite to the bow paddlers' paddling side.
5. Once the stern paddler is kneeling and in the ready position move the canoe away from the shore.



G. McGuffin & J. McGuffin, *Paddle Your Own Canoe*, The Boston Mills Press (p. 36)

Figure 16-2-9 Bow First Launch



On windy days, the canoe should be faced directly into the wind when launching.

### Launching at a Dock

Procedure for a dock launch:

1. Put on a PFD and have paddles in the canoe or on the dock. Pick the canoe up in the middle and lower it hand-over-hand into the water perpendicular to the dock.
2. Place the spare paddle in the centre of the canoe. Have the stern paddler swing the canoe parallel to the dock (bow facing into the wind if any). The bow has more buoyancy, so have the bow paddler get in first while the stern paddler steadies the canoe.
3. From a crouched position on the dock, have the stern paddler steady the bow end by holding the paddle shaft across the gunwales, with the blade extended toward the paddling side. Have the bow paddler step in, keeping low and over the centreline.
4. Have the bow paddler kneel, holding their paddle in the ready position as detailed in Figure 16-2-9. The stern paddler will steady the canoe by positioning their paddle across the gunwales. With the blade on the paddling side and still holding the dock, step in keeping weight low and balance over the centreline.
5. When the stern paddler is in the ready position, move the canoe away from the dock.





G. McGuffin & J. McGuffin, *Paddle Your Own Canoe*, The Boston Mills Press (p. 35)

Figure 16-2-10 Dock Launch

## LANDING A CANOE

### Landing at a Shoreline

When a suitable location to exit the canoe is found, the following procedure shall be followed:

1. Bring the canoe into landing without running up on shore.
2. Have the bow paddler exit first to steady the canoe for the stern paddler.
3. Have the stern paddler move forward, keeping their weight low in the canoe.
4. Have the stern paddler exit at the bow.

### Landing at a Dock

1. Bring the canoe into landing without running into the dock.
2. Have the stern paddler hold the dock and steady the canoe while the bow paddler exits the canoe.
3. From a crouched position on the dock, have the bow paddler hold the canoe steady next to the dock for the stern paddler.
4. Have the stern paddler exit the canoe by keeping low and stepping to the dock.

## EXITING A CANOE

To exit the canoe, reverse the entry procedures:

1. Bring the canoe into the landing slowly and carefully.
2. Keep the body low at all times, lowering the centre of gravity.
3. Place the paddle shaft across the gunwales for stability.
4. Grasp both gunwales and the paddle shaft, and move to the bow of the canoe.
5. Step out of the canoe, keeping weight low.

---

### CONFIRMATION OF TEACHING POINT 7

---

## QUESTIONS

- Q1. When launching from shore, which paddler is first to enter the canoe?
- Q2. How is a canoe launched in the wind?
- Q3. How is a canoe brought to the dock for landing?

## ANTICIPATED ANSWERS

- A1. When launching from shore, the bow paddler is the first to enter the canoe.
- A2. On windy days, the canoe should be launched directly into the wind.
- A3. The canoe is brought to the dock for landing carefully without running into the dock to avoid damaging the canoe.

---

## Teaching Point 8

## Explain and Demonstrate Action on Capsizing

Time: 15 min

Method: Demonstration

---



For this skill TP, it is recommended that instruction take the following format:

1. Discuss the process a rescuer will follow in the event that a canoe has capsized, including the responsibilities of the cadet and what the rescuer will and will not do to assist them.
2. Explain and demonstrate the canoe over canoe assisted rescue while the cadets observe.
3. Explain and demonstrate the steps required to complete a canoe over canoe assisted rescue.

**Note:** Cadets will be given the opportunity to practice this skill during the on-water training and the practical activity.

Although strong rescue skills are important, preventing rescues by making careful, informed decisions will reduce the chances of capsizing. Anticipating changes in weather, actions of other paddlers and being properly trained will aid in the prevention of accidents.

## RESCUE PRIORITIES



The priority of rescue is listed below, but rescuers will only initiate rescue if it is safe to do so without harm to themselves.

When carrying out rescues, it is imperative that every individual involved be aware of the priorities of rescue. The rescue priorities are:

**Rescuer.** Rescuer safety is priority. The rescuer should not complete any part of the rescue that is beyond the scope of the rescuer's ability. Another casualty will only escalate the emergency.

**People.** The paddler(s) in the water. Each paddler will make sure they are okay, and that their partner is okay. If they cannot see their partner, they must establish voice contact to confirm that their partner is conscious, not seriously injured and is preparing to self-rescue.

**Canoes.** Canoes will be retrieved once all the paddlers in the water are safe.

**Equipment.** Equipment is the last thing to be retrieved as it is not essential. Clothing and food can be shared if need be.



If involved in a high risk rescue, the rescuer or rescue team should be prepared and trained to perform effectively and efficiently and follow the procedures.



Cold water and wind will accelerate the loss of body heat. People can become hypothermic very quickly, even in warm weather.

## TANDEM CANOE OVER CANOE ASSISTED RESCUE

The canoe over canoe assisted rescue is the universal rescue means.



The figures below depict two solo paddlers completing a canoe over canoe assisted rescue. The procedure is virtually the same as a tandem rescue with only minor adjustments, which are detailed in the numbered procedure. Use the figures as a guideline.





STEP 1



STEP 2

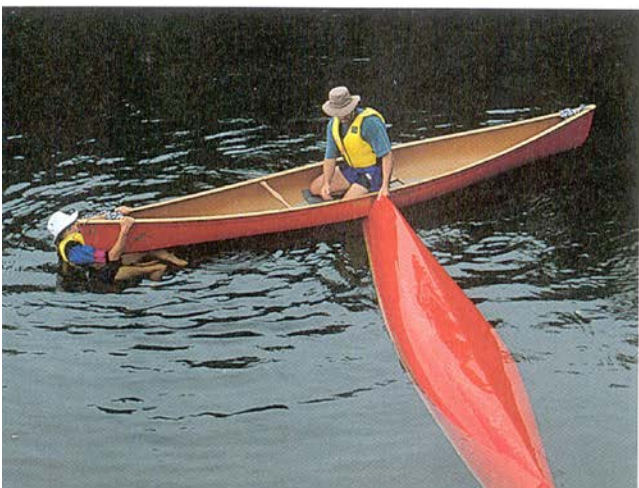

STEP 3



STEP 4

G. McGuffin & J. McGuffin, *Paddle Your Own Canoe*, The Boston Mills Press (p. 36)

Figure 16-2-11 (Sheet 1 of 2) Tandem Canoe Over Canoe Assisted Rescue





STEP 5



STEP 6



STEP 7



STEP 8

G. McGuffin & J. McGuffin, *Paddle Your Own Canoe*, The Boston Mills Press (p. 36)

Figure 16-2-11 (Sheet 2 of 2) Tandem Canoe Over Canoe Assisted Rescue

The procedure to follow in a tandem canoe over canoe assisted rescue is:

1. One paddler will swim to the stern of a rescue canoe, hang on and get as much of the body out of the water as possible.
2. The second paddler will swim to the far end of the canoe.
3. The rescuers will lift up on the capsized canoe as the second paddler pushes down on the opposite end of the canoe to break the suction.
4. The second paddler will then move to the bow of the rescue canoe, hang on and get as much of the body out of the water as possible.
5. Both paddlers will remain in that position until told to move by the rescuers. The rescuers will move the canoe across the gunwales of their canoe. Once it is centred they will flip it over and gently continue to slide it into the water.
6. Maintain communication and when instructed to do so the paddlers will, one at a time, get back into the canoe by one of two ways:

- (a) hook one leg over each canoe and pull up out of the water and climb into the canoe; or
- (b) propel themselves upward by scissor kicking, tucking the shoulder in and rolling into the canoe.

7. Return to the paddling position.

---

### CONFIRMATION OF TEACHING POINT 8

---

#### QUESTIONS

- Q1. What are the rescue priorities?
- Q2. When shall the rescuer stop a rescue?
- Q3. What are the two methods which can be used to re-enter a canoe after a capsizing?

#### ANTICIPATED ANSWERS

- A1. The rescue priorities are rescuers, people, canoes and equipment.
- A2. The rescuer shall stop a rescue when they are in danger themselves, or the rescue is beyond their scope of knowledge.
- A3. The two methods a paddler can use to re-enter a canoe after a capsizing are:
  - hook one leg over each canoe and pull up out of the water and climb into the canoe; or
  - propel themselves upward by scissor kicking, tucking the shoulder in and rolling into the canoe.

---

#### Teaching Point 9

#### Explain, Demonstrate and Have the Cadet Practice Strokes

Time: 35 min

Method: Demonstration and Performance

---



For this skill lesson, it is recommended that instruction take the following format:

1. Explain and demonstrate each stroke while the cadets observe.
2. Explain and demonstrate each step required to complete each stroke. Monitor the cadets as they practice each step.
3. Monitor the cadets' performance as they practice each stroke.

**Note:** Time devoted to practice during this TP will be limited due to time constraints, however, cadets will be provided additional time to practice individual strokes during the practical activity.

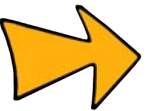

Kneeling is the position of choice for paddling because it provides increased canoe stability. When a person kneels, their centre of gravity is lowered. To give sore knees a break, a paddler can sit on the seat.



There are four phases of a stroke that help ensure the transition between each stroke is natural and smooth.

**Catch.** The beginning of the stroke where the blade is inserted into the water. **Power.** The movement of the paddle through the water by rotating the torso to transmit power to the blade. When paddling, it is important to use the muscles of the torso, which have more strength and endurance than the arm muscles.

**Exit.** When the paddle leaves the water.

**Recovery.** When the paddle is returned to the catch position. This is completed by feathering the blade (keeping it flat and just above the water surface) to minimize wind resistance.



The stern paddler will control the direction of the canoe using corrective strokes where applicable. The bow paddler will complete mostly power strokes when canoeing, unless the stern paddler requires assistance with corrective strokes.

## POWER STROKE

The power stroke is used to move the canoe forward. It is the foundation stroke on which most other strokes are built. The power stroke is made close to the side of the canoe and parallel to the keel, with the shaft of the paddle moving in a vertical or near-vertical plane. To complete the power stroke:

1. Rotate the torso forward toward the bow to engage the muscles for the stroke.
2. Place the blade deep into the water with as little splash as possible.
3. Unwind the torso while pulling on the shaft hand (lower hand) and pushing with the control hand (upper hand).
4. Power the stroke through the water until the blade of the paddle is in line with the knee.
5. Lift the paddle out of the water by slicing it out to the side.
6. Recover the stroke with the blade clear and flat across of the water (to reduce wind resistance) and complete another stroke.





A. Westwood, *Canoeing: The Essential Skills and Safety*, Heliconia Press (p. 71)

Figure 16-2-12 Power Stroke

## J-STROKE



Watch for ruddering as the cadets' practice the J-stroke. Ruddering is when the stern paddler places their paddle in the water behind the hip and manoeuvres it back and forth to turn the canoe. This will create drag and slow the forward momentum of the canoe.

The J-stroke is a version of the power stroke used as a corrective stroke by the stern paddler to help keep the canoe travelling in a straight line. When applied with force, it can be used to turn the canoe to the stern paddler's side (the side they are paddling on). To complete the J-stroke:

1. Complete the first four steps of the power stroke, ending with the control hand above the gunwale and the shaft hand at the hip.
2. Twist the control hand thumb forward and down while pulling the shaft hand inward, forming a "J".
3. Recover to complete another stroke.



A. Westwood, *Canoeing: The Essential Skills and Safety*, Heliconia Press (p. 74 and p. 75)

Figure 16-2-13 J-Stroke

## FORWARD SWEEP

The purpose of the forward sweep is to turn the canoe away from the canoeist's paddling side. It is a wide sweep of the paddle, using the power face of the blade. There are many occasions when this stroke would be used, such as:

- swinging the canoe for pivot turns or partial turns;
- manoeuvring the canoe around obstacles;
- following along the bends of streams or rivers;

- making sudden changes of direction in paddling;
- aiding in holding a straight course in crosswinds; and
- incorporating with other strokes as necessary to control the canoe.



Reverse sweeps use the back face of the blade and are the opposite of forward sweeps. Both sweeps have many of the same functions.

As the bow paddler, to complete the forward sweep:

1. Rotate the torso and bend forward slightly while immersing the blade of the paddle almost horizontally by the bow of the canoe.
2. Push the shaft hand out slightly from the waist while swinging in a 90 degree arc until the arm extends out from the hip (the paddle should be at a right angle to the side of the canoe).
3. Recover to complete another stroke.

As the stern paddler, to complete the forward sweep:

1. Lean back slightly as the upper body rotates while extending and immersing the paddle almost horizontally at a right angle to the side of the canoe at the hip, keeping the lower hand at waist height with the thumb pointing up.
2. Push out slightly with the shaft hand while swinging in a 90 degree arc (the paddle should be almost touching the stern).
3. Recover to complete another stroke.

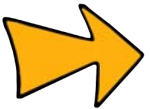

When the bow paddler is completing a forward sweep, the stroke should never move past the paddler's body. Any further movement will result in drag and loss of momentum.





STEP 1



STEP 2



STEP 3

*G. McGuffin & J. McGuffin, Paddle Your Own Canoe, The Boston Mills Press (p. 51)*

Figure 16-2-14 Forward Sweep

## DRAW

The purpose of the draw is to turn the canoe or to move it sideways. The draw stroke can be completed by both the bow and stern paddler. To complete the draw stroke:

1. Rotate the torso and extend the arms fully to position the paddle at the side of the canoe, adjacent to the knee.
2. Reach across the canoe with the control hand and place the paddle vertically into the water.
3. Plant the blade deeply in the water and pull the power face toward the body.
4. Twist the control hand thumb away from the body and rotate the blade 90 degrees (before the blade hits the canoe).
5. Bring the paddle back to the beginning position by slicing it through the water.

6. Twist the blade back into the original position to complete another stroke.



A. Westwood, *Canoeing: The Essential Skills and Safety*, Heliconia Press (p. 95)

Figure 16-2-15 Draw

## PRY

The pry is a powerful, deep-water stroke that can be applied by the bow or the stern paddler to move the canoe away from the paddler's side. To complete the pry stroke:

1. Place the paddle vertically against the gunwale adjacent to the knee with both hands above the gunwale.
2. Pull inward with the control hand to force the paddle away from the canoe.
3. Rotate the blade 90 degrees by twisting the thumb of the control hand away from the body and slicing the blade back to the beginning point.



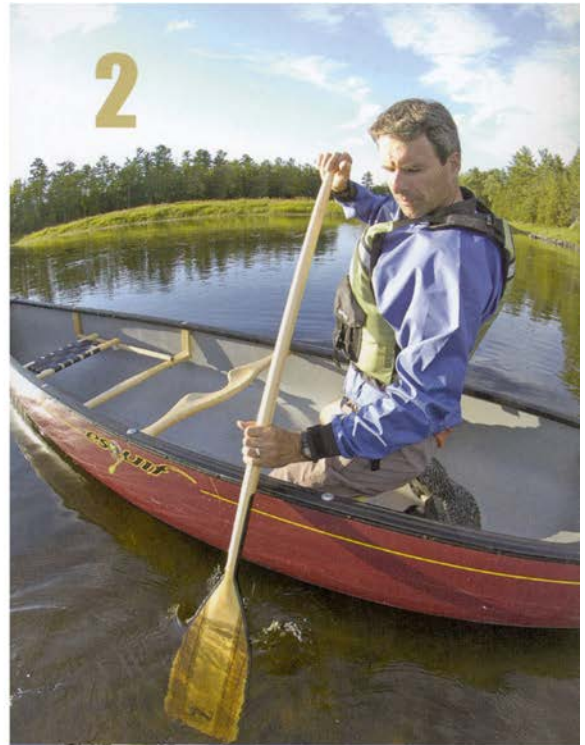

A. Westwood, *Canoeing: The Essential Skills and Safety*, Heliconia Press (p. 96)

Figure 16-2-16 Pry



If the bow paddler completes a pry and the stern paddler completes a draw, the canoe will move sideways. This combination of strokes could be useful if trying to move a canoe parallel to a dock or when rafting up.



## LOW BRACE

The low brace will assist in righting a canoe from capsizing or if it begins to tip. This stroke will also help a paddler rely on the paddle to steady the canoe as well as lean into turns. It can also be used by the stern paddler to steady the canoe when the bow paddler is initiating a turn. To complete a low brace:

1. Twist the upper body to face the water, with the paddle out at a 90 degree angle to the canoe.
2. Smack the water with the flat backside of the paddle to provide support to balance the body in the canoe.
3. Begin to get the knees level in the canoe by dropping the head towards the shaft of the paddle.
4. Assume a stable posture with the head centred inside the canoe once the canoe has levelled.

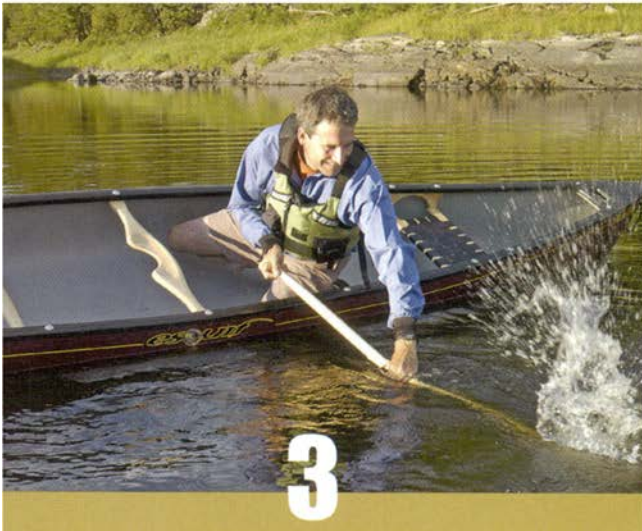

A. Westwood, *Canoeing: The Essential Skills and Safety*, Heliconia Press (p. 98 and p. 99)

Figure 16-2-17 Low Brace

## JAM

The jam stroke will stop a canoe's forward momentum quickly when applied. To execute the jam, the paddler will shove the paddle into the water at a right angle to the canoe in a vertical position.



## BACKPADDLING

To go backward, the bow paddler can complete a reverse power stroke. If necessary, the stern paddler can do a pry in the beginning to steady the canoe. To backpaddle:

1. Lean slightly back, rotate the shoulders back and place the blade of the paddle vertically in the water at the rear of the canoe up to the throat.
2. Unwind the body while pushing forward with the shaft hand and pulling with the control hand.
3. Continue with the stroke until the shoulders are square with the gunwales.
4. Lift the blade out of the water and recover to complete another stroke.



A. Westwood, *Canoeing: The Essential Skills and Safety*, Heliconia Press (p. 98 and p. 99)

Figure 16-2-18 Backpaddling



If both paddlers are backpaddling, the canoe will turn away from the bow paddler's side.

### CONFIRMATION OF TEACHING POINT 9

The cadets' participation in practicing strokes will serve as the confirmation of this TP.

#### Teaching Point 10

#### Have the Cadet Practice Canoe Skills During an Expedition

Time: 40 min

Method: Practical Activity



The cadets shall receive feedback during and after the activity. Have each cadet perform the strokes individually. When completing strokes, watch closely for the following:

#### Power Stroke

The cadet shall lean forward, place the paddle vertically into the water up to the throat, rotate the torso while pulling on the shaft hand and pushing with the control hand until the paddle is just past the knee and in line with the hip, then slice the blade out of the water and then recover.

#### J-Stroke

The cadet shall lean forward, place the paddle vertically into the water up to the throat, rotate the torso while pulling on the shaft hand and pushing with the control hand, ending with the control hand above the gunwale and the shaft hand at the hip, twist the control hand thumb forward and down while pulling the shaft hand inward to form a "J", then slice the blade out of the water and then recover.

#### Forward Sweep

The cadet shall lean back, extend and immerse the paddle from the hip so it is horizontally at a right angle to the side of the canoe, pushing out and pulling with the shaft hand, swing the paddle in a 90 degree arc to the stern of the canoe, then slice the blade out of the water and then recover.

#### Draw

The cadet shall rotate the torso and extend the arms fully to the side of the canoe, adjacent to the knee, reach across the canoe with the control hand, plant the paddle vertically into the water, pull the power face toward the canoe, twist the control hand thumb away from the body, rotate the blade 90 degrees just before it hits the canoe and then slice it through the water back to its original position.

#### Pry

The cadet shall place the paddle vertically against the gunwale adjacent to the knee with both hands above the gunwale, pull inward with the control hand to force the paddle away from the canoe, rotate the blade 90 degrees by twisting the thumb of the control hand away from the body and then slice the blade back to the beginning point.

---

**ACTIVITY**

---

**OBJECTIVE**

The objective of this activity is for the cadets to participate in a practical expedition activity to practice canoe strokes in a controlled environment for an extended period of time.

## RESOURCES

- Canoe equipment, to include:
  - Tandem canoe (one per two cadets),
  - Paddle (three per canoe),
  - PFD (one per cadet),
  - Whistle (one per cadet),
  - Bailer (one per canoe),
  - Painter lines (two per canoe), and
  - 15 m buoyant heaving line or throw bag (one per canoe);
- Water carrier (one per cadet),
- Topographical map of the area (two per team/group),
- Compass (one per team/group),
- Communication device (two per team/group),
- GPS Receiver (one per team/group),
- Batteries (spares for communication device and GPS), and
- First aid kit (one per team/group).

## ACTIVITY LAYOUT

- All canoes must be ready to launch.
- All canoes must be outfitted.
- Designated expedition canoe route.

## ACTIVITY INSTRUCTIONS

1. Place cadets in canoe partners.
2. Assign a bow and stern paddler (groups will be required to switch half-way through the activity).
3. Allow each group of cadets to launch their canoe, one at a time.
4. Have the cadets practice strokes to paddle in a straight line, turn 180 degrees and stop for the first half of the designated route.
5. Have each group complete a canoe over canoe assisted rescue.
6. Have the cadets land their canoes, switch positions and launch again.
7. Have the cadets practice strokes to paddle in a straight line, turn 180 degrees and stop for the remaining portion of the route.
8. Have the cadets land their canoes and store equipment.



When on the water, observe stroke technique and correct the cadets when necessary.

## SAFETY

- All cadets must wear their PFDs at all times.
- The cadets must respect the pre-determined boundaries for this activity.
- Teams/groups will travel in single file.
- Teams/groups will not pass another team/group unless directed to do so by their team instructor.
- All the cadets must have at least 500 mL (16 oz) of water.

---

## CONFIRMATION OF TEACHING POINT 10

---

The cadets' participation in the activity will serve as the confirmation of this TP.

---

## END OF LESSON CONFIRMATION

---

The cadets' participation in the practical expedition activity will serve as the confirmation of this lesson.

---

## CONCLUSION

---

## HOMEWORK/READING/PRACTICE

N/A.

## METHOD OF EVALUATION

This EO is assessed IAW A-CR-CCP-703/PG-001, Chapter 3, Annex B, Appendix 7 (326 PC).

## CLOSING STATEMENT

Canoeing is one of three dynamic modes of transport that can be used during expedition training. It is critical that the cadets understand the importance of following canoe safety procedures while on the water. Being able to manoeuvre a canoe on an expedition will provide a great sense of freedom and accomplishment. While there are many different strokes cadets should know prior to setting out on a canoe trip, these strokes will take a long time to master but the more they are used, the more comfortable they will feel.

## INSTRUCTOR NOTES/REMARKS

Expedition centres are required to select two dynamic modes of travel from EO M326.02a (Paddle a Canoe), EO M326.02b (Ride a Mountain Bike, Section 3), and EO M326.02c (Hike Along a Route, Section 4) to incorporate into their weekend training.

This EO has been allocated five and a half periods in the overall course period allocation. Each expedition centre may adjust this allocation to reflect the choice of activities, facilities and available resources at the expedition centre.

Upon arrival at the expedition centre, cadets will be divided into teams/groups. These teams/groups will remain the same for the duration of the weekend.

---

## REFERENCES

---

- A1-010 A-CR-CCP-030/PT-001 Director Cadets 3. (2005). *Water Safety Orders*. Ottawa, ON: Department of National Defence.
- A2-001 A-CR-CCP-951/PT-002 Director Cadets 4. (2006). *Royal Canadian Army Cadets Adventure Training Safety Standards*. Ottawa, ON: Department of National Defence.
- C0-025 (ISBN 1-895465-33-8) Gifford, D. (Ed.) (2000). *Canoeing Instructor's Resource Manual*. Merrickville, ON: Canadian Recreational Canoeing Association.
- C2-076 (ISBN 0-87322-443-4) Gullion, L. (1994). *Outdoor Pursuits Series: Canoeing*. Champaign, IL: Human Kinetics Publishers.
- C2-077 (ISBN 1-55013-654-2) Mason, B. (1995). *Path of the Paddle: An Illustrated Guide to the Art of Canoeing*. Toronto, ON: Key Porter Books Limited.
- C2-078 (ISBN 1-55013-079-X) Mason, B. (1988). *Song of the Paddle: An Illustrated Guide to Wilderness Camping*. Toronto, ON: Key Porter Books Limited.
- C2-106 (ISBN 0-900082-04-6) Rowe, R. (1997). *Canoeing Handbook*. Guildford, UK: Biddles Limited.
- C2-112 (ISBN 1-55046377-2) McGuffin, G. & McGuffin, J. (2005). *Paddle Your Own Canoe: An Illustrated Guide to the Art of Canoeing*. Erin, ON: Boston Mills Press.





**ROYAL CANADIAN ARMY CADETS**  
**SILVER STAR**  
**INSTRUCTIONAL GUIDE**



**SECTION 3**  
**EO M326.02B – RIDE A MOUNTAIN BIKE**

---

Total Time:	180 min
-------------	---------

---

**PREPARATION**

---

**PRE-LESSON INSTRUCTIONS**

Resources needed for the delivery of this lesson are listed in the lesson specification located in A-CR-CCP-703/PG-001, Chapter 4. Specific uses for said resources are identified throughout the instructional guide within the TP for which they are required.

Review the lesson content and become familiar with the material prior to delivering the lesson.

Every cadet must have a water carrier prior to the start of this lesson.

All mountain bikes and helmets being used should be organized by size prior to the start of this lesson.

For TP 3 select a mountain bike to use as a model when identifying the parts of the bike. These parts should be labelled on the bike using gear or masking tape.

Choose a location that is large enough to allow the cadets to ride and practice mountain bike techniques as they are presented, but not too large that control is compromised. The area should have some hills and varied terrain.

Have cleaning materials available to complete the pre-ride and post-ride check.

Timings for this EO will vary. While there is a requirement for initial training, the focus should be on having the cadets complete each technique through the practical activity in TP 7.

**PRE-LESSON ASSIGNMENT**

N/A.

**APPROACH**

An interactive lecture was chosen for TPs 1 and 2 to introduce the principles of safe riding and provide an overview of the parts of a mountain bike.

Demonstration and performance was chosen for TPs 3, 4, 6 and 8 as it allows the instructor to explain and demonstrate selecting and adjusting a mountain bike, the procedure for a pre-ride and post-ride bike check, and proper mountain bike techniques while providing an opportunity for the cadet to practice each skill under supervision.

Demonstration was chosen for TP 5 as it allows the instructor to explain and demonstrate safety precautions when mountain biking.

A practical activity was chosen for TP 7 as it is an interactive way to introduce the cadet to mountain bike techniques and procedures in a controlled environment during an expedition. The expedition contributes to the development of these skills and procedures in a fun and exciting manner.

---

## INTRODUCTION

---

### REVIEW

N/A.

### OBJECTIVES

By the end of this lesson the cadet shall have selected and fitted a mountain bike, followed trail etiquette, obeyed safety regulations and ridden a mountain bike.

### IMPORTANCE

It is important for cadets to be able to safely ride a mountain bike for the safety of them and those around them. Safe riding practices are built on knowing the parts of a mountain bike, an ability to properly fit a mountain bike, the development of mountain bike techniques and an awareness of trail etiquette. Having a properly fitted mountain bike will make the riding experience more positive for the cadets, allowing for a more comfortable ride, limiting the possibility and occurrence of injuries and increasing the overall performance of the mountain biker. Demonstrating mountain bike techniques without difficulty will assist the cadets in keeping up with members of their team and completing the practical expedition activity. Following trail etiquette will ensure that all trail users (mountain bikers, hikers, joggers and motorists) are able to use the trails and roads in a safe, enjoyable manner.

---

### Teaching Point 1

### Introduce Principles of Safe Riding

Time: 5 min

Method: Interactive Lecture

---



The following information will be explained to the cadets as a lead-in to the technical skills associated with mountain biking.

Mountain biking is a growing sport in North America. By the 1980s, the popularity of mountain bikes exceeded all other styles of bicycles combined, culminating with its entry into the 1996 Olympic games in Atlanta as a genuine racing event.

The popularity of the sport in the past two decades has led to the development of a trail classification system which informs mountain bikers of the type and technical difficulty of hundreds of trails throughout North America and the rest of the world.

### TRAIL RATING SYSTEM

Mountain bike trails are classified by mountain biking organizations. Interest in establishing consistent criteria for the rating of trails has been increasing.

The International Mountain Bicycling Association (IMBA) developed a basic method to categorize the technical difficulty of recreation trails. The system was adapted from the International Trail Marking System used at ski areas throughout the world.

The IMBA Trail Difficulty Rating System has been created to:

- help trail users make informed decisions;
- encourage visitors to use trails that match their skill level;
- manage risk and minimize injuries;
- improve the outdoor experience for a wide variety of visitors; and
- aid in the planning of trails and trail systems.

Mountain bike trails, in accordance with the IMBA Trail Difficulty Rating System have been divided into three categories based on trail width, trail surface, trail grade, obstacles and technical features.

**Novice Trails.** A novice trail should take two hours or less to complete. Characteristics of a novice trail include:

- hard-packed surfaces,
- some hills which require limited skill to ascend and descend, that are short in duration with few obstacles to navigate around – not too many included in the route,
- no high-speed downhill, and
- mostly flat ground with the inclusion of interesting terrain features such as small roots, logs and rocks to negotiate around.

**Intermediate Trails.** An intermediate trail can be completed in three to four hours. Characteristics of an intermediate trail include:

- a variety of moderate hills, that require technical skill to ascend and descend with ease,
- some high-speed downhill,
- some difficult obstacles such as roots, logs and rocks are included, but should not be a common feature of the trail, and
- some loose surface.

**Experienced Trails.** An experienced trail can vary from one to several days in length. Characteristics of an experienced trail include:

- a mix of flat and technical terrain (hills, obstacles and cornering),
- a variety of ascents and descents on steep and uneven terrain,
- a combination of loose and hard-packed surfaces, and
- obstacles such as rocks, roots and logs throughout the route.



It is critical that trail ratings are observed and that the mountain biker pays due diligence by riding on trails that meet their skill and experience level.

## SIX CODES OF CONDUCT

With the popularity of mountain biking on the rise, problems between mountain bikers and other trail users is increasing. Conflicts between trail users and mountain bikers have resulted in frequent trail closures in parks and wilderness areas, leaving enthusiasts of the sport seeking alternative locations to ride.

One of the best ways to prevent trail closures and to improve the image of the sport held by non-mountain bikers, is to improve relations with other trail users. To do this, mountain bikers are required to understand and practice trail etiquette whenever they are out on the trail. The IMBA has developed six codes of conduct to

minimize the impact of mountain bikers on the environment and on other users, which all mountain bikers are encouraged to adhere to when riding.

### **Riding on Open Trails Only**

Mountain bikers should always respect trail and road closures. Check the status of roads/trails before riding on them. Ensure that permits and authorization are obtained as required. Respect private and public property.

### **Practicing the Principles of Leave No Trace**

Be sensitive to the earth. Even on open trails, care should be taken to ensure that no evidence is left once the trail has been ridden. After a rain or thaw, the ground may be soft and should not be ridden to avoid causing damage. When the trail bed is soft, consider other riding options. Practice low-impact mountain biking by not sliding when riding, staying on the existing trails and not creating new trails. Do not ride through streams and pack out what was brought in.

### **Controlling Your Bicycle**

Inattention may cause an accident. Pay attention to the trail and be aware of approaching mountain bikers and hikers. Excessive speed can hurt the mountain biker and other people on the trail. Obey all speed regulations.

### **Giving Way to Other Users**

Approach other trail users with caution. Let them know well in advance of the approach of a biker. A friendly greeting (or bell) is considerate and works very well. Try not to startle others on the trail by speeding up to or behind them. Show respect when passing others by slowing down or even stopping, depending on the trail width. Anticipate that other trail users may be around corners or in blind spots.

### **Avoiding Animals**

Animals may be startled by an unannounced approach, a sudden movement or a loud noise. This can be dangerous for the mountain biker, other trail users and the animals. Give animals extra room and time to adjust. When passing horses, it is advised that the helmet and sunglasses are removed. Then use care and follow the directions of horseback riders. It is a serious offence to run cattle and disturb wild animals.

### **Planning Ahead**

Know the equipment being used and the ability of the mountain biker and the trail, and prepare accordingly. Be self-sufficient at all times. Wear a helmet, ensure the bike is maintained and carry the necessary supplies for changes in weather and other conditions. A well executed trip will result in a satisfactory experience for the mountain biker.

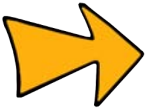

Respect for other trail enthusiasts and the natural environment is an attitude that all mountain bikers should adopt.

---

## **CONFIRMATION OF TEACHING POINT 1**

---

### **QUESTIONS**

- Q1. What level of trail are you riding on when it is a mix of flat and technical terrain, made up of both loose and hard-packed surfaces, consists of a variety of ascents and descents on steep and uneven terrain and has obstacles such as rocks, roots and logs throughout the trail to navigate?
- Q2. What measures should you take to practice low-impact mountain biking?
- Q3. What actions should be taken when approaching a horse on the trail?

**ANTICIPATED ANSWERS**

- A1. An experienced trail.
- A2. Practice low-impact mountain biking by not sliding when riding, staying on the existing trails, not creating new trails, not riding through stream and packing out what was brought in.
- A3. When approaching a horse on the trail it is advised that the helmet and sunglasses should be removed. Use care and follow the directions of horseback riders.

**Teaching Point 2****Identify the Parts of a Mountain Bike**

Time: 10 min

Method: Interactive Lecture



This TP is intended to give cadets an overview of the different parts of a mountain bike.

Use a mountain bike as a training aid to point out each as they are discussed. Allow the cadets to have a closer look.



Cadets will have some previous knowledge of the material presented in this TP. Use this knowledge through questions to identify the parts.



To make it easier for the cadets to remember the different parts, present them in a clockwise direction, as illustrated in Figure 16-3-1.



"Fullerton Bicycle Co. & Buena Park Bicycle Co.", *Dirt-Mountain Bikes*. Retrieved October 25, 2007, from <http://www.fullertonbicycle.com/images/Yukon.lg.jpg>

Figure 16-3-1 Parts of a Mountain Bike

**Handlebar.** The handlebar is a horizontal bar attached to the bike with handgrips at each end, where brake levers and gear shifters are attached.

**Gear Shifter.** There are two gear shifters, high and low, located on either side of the handlebars. The front shifter, which works the front derailleur, is normally located on the left side. The rear shifter, which works the rear derailleur, is normally located on the right side.

**Brake Lever.** There are brake levers on both sides of the handlebar to activate the brakes. The left brake lever is for the front brake, the right is for the rear brake.

**Top Tube.** The top tube is the horizontal tube running across the top of the bike providing strength and stability to the bike frame.

**Tire.** The tire is rubber tubing attached to the rim to form a wheel.

**Quick Release.** There are quick release levers located on both the front and rear wheels. These levers allow for the wheels to be dropped out without the need of a screwdriver or other tool.

**Derailleur (Front and Rear).** The derailleur is a lever-activated mechanism that pushes the chain off one chainring or sprocket and onto another, altering the gear ratio.



Sprocket is the general term that applies to both chainrings and to cassette cogs. A sprocket is defined as a disc with teeth which drives the chain when the bike is pedalled to propel it forward.

**Chainring.** A chainring is a toothed ring attached to the crank that drives the chain.

**Chainset.** The chainset is made up of two or three chainrings that pull the chain around when the pedals are turned.

**Chainstay.** The chainstay is the lower bar on the bike frame that attaches the rear wheel.

**Pedal.** The pedal is the platform for the foot to press on, attached to the crank.

**Chain.** A chain is the circular set of links to transfer power from the chainrings at the front of the bike, to the sprockets in the rear of the bike.

**Cogs.** A cog is a disc with teeth which drives the chain when the bike is pedalled to propel it forward. Cogs are blocked together to form cassettes which work in conjunction with the rear derailleur.

**Cassette.** A cassette is comprised of a number of cogs mounted together and attached to the rear hub. The smaller cogs provide a higher (harder) gear for maximum speed, while the larger cogs provide a lower (easier) gear for climbing hills.

**Brakes.** A bike has two sets of brakes: one set located in the front and the other in the rear. The brakes are activated by the brake levers attached to the handlebars.



There are two different types of braking systems which are used on mountain bikes. The traditional direct-pull (V-Brake) system and the more advanced disc brake system. Some bikes might have a combination of both types, with a disc brake on the front and a direct-pull on the rear.

**Seat Tube.** The seat tube is a hollow tube which runs from just below the saddle down to the bottom bracket of the bike in which the seat post is inserted into.



**Seat Post Release.** The seat post release is a quick release lever that holds the seat post in the desired position when it is inside the seat tube.

**Seat Post.** The seat post is an adjustable support for the saddle which fits into the seat tube.

**Saddle.** A saddle is the term used to describe the seat of a bike.

---

## CONFIRMATION OF TEACHING POINT 2

---

### QUESTIONS

- Q1. If the left brake lever is pulled, which brake—front or rear—would be activated?
- Q2. When climbing up a hill a biker would want to use the gear shifter on which side to move the chain to a smaller cog on the cassette?
- Q3. What are the two different types of brakes found on mountain bikes?

### ANTICIPATED ANSWERS

- A1. The front brake.
- A2. The right gear shifter.
- A3. The two types of brakes found on mountain bikes are disc brakes and direct-pull brakes (V-brakes).

---

### Teaching Point 3

### Explain, Demonstrate and Have the Cadet Select and Adjust a Mountain Bike

Time: 20 min

Method: Demonstration and Performance

---



For this skill TP it is recommended that the following format be followed:

1. Introduce cadets to the importance of selecting a proper fitting mountain bike and a proper fitting helmet.
2. Discuss selection of a helmet and then demonstrate how the helmet can be adjusted.
3. Discuss the different methods which can be used to select a mountain bike.
4. Using a bike that has already been properly selected and adjusted, explain the complete procedure for selecting and adjusting a mountain bike.
5. Explain and demonstrate each step required to complete the skill. Monitor cadets as they imitate each step.
6. Once each cadet has selected a mountain bike and helmet, they must be labelled with gear or masking tape.

**Note:** Assistant instructors may be used to monitor cadet performance.





Since the first introduction of the mountain bike in the mid to late 1970s, the design of bikes has evolved. The quest for improved products has led to continued improvements and advancements in materials being used to construct the bikes, as well as the overall design of the bikes themselves. With the introduction of new bikes each year by front runner manufacturers the use of stronger and lighter new materials and cutting edge designs compete to maximize speed, power and strength.

While it is important to have a well-designed mountain bike, if the bike chosen does not fit the mountain biker then the excellence in design will be lost. Having a properly fitted bike is important for riding efficiency and power as well as safety. When a bike does not fit the mountain biker properly, injuries are more likely.

### SELECTING A HELMET

A properly fitted helmet should:

- fit level and square on the head;
- cover the front of the forehead;
- sit snug on the head, without fastening the chin strap;
- not slip when the head moves; and
- have straps adjusted to meet just below the ear and fasten tightly.



INCORRECT



INCORRECT



CORRECT

*"Ministry of Transportation Ontario", Cycling Skills: Cycling Safety for Teen and Adult Cyclists, Copyright 2005 by Government of Ontario. Retrieved October 5, 2007, from <http://www.mto.gov.on.ca/English/pubs/cycling/cyclingskills.htm>*

Figure 16-3-2 Proper Fit of a Helmet



Helmet sizes vary from extra small to extra large and it is important to try on a variety of sizes to make sure the fit is correct.

### ADJUSTING THE HELMET

A helmet will not necessarily fit properly without making some minor adjustments. The following are some basic adjustments that can be made to ensure the helmet will protect the mountain biker in an accident:

- Adjust removable pads, if required, to make the fit firm and comfortable.
- Centre the chin clip so it is just under the chin and so the strap is even on both sides. This is done by pulling the strap from one side to another through the underside of the helmet.
- Adjust the side straps by pulling or pushing them through the sliders. The slider should sit just below the ears forming a 'V'.

- Use the rear adjuster (if there is one) by sliding the mechanism to make it bigger or smaller.
- Buckle the chin clip and ensure that no more than two fingers can fit under it.

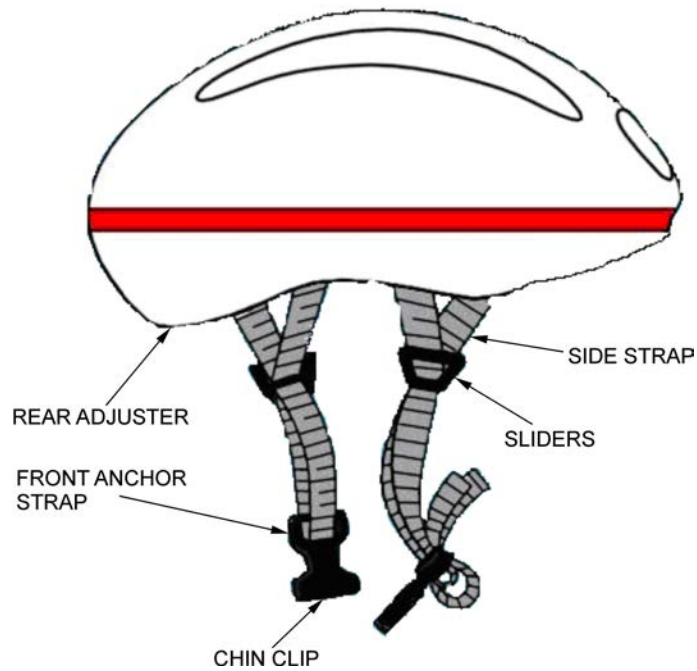

*"U.S. Consumer Product Safety Commission", CPSC Issues New Safety Standard for Bike Helmets. Retrieved October 30, 2007, from <http://www.cpsc.gov/cpscpub/prerel/prhtml98/98062.html>*

Figure 16-3-3 Parts of a Helmet

### **SIZING A MOUNTAIN BIKE**

While some manufacturers size their bikes by labelling them as small, medium, large and extra large, in most cases bike size is given in inches and is based on leg length. The size is determined by measuring the distance from where the crank attaches to the bike to the intersection of the seat tube and the top tube.



*"Dynamic Bicycles", Bike Sizing Guide, Copyright 2005 from Dynamic Bicycles, Inc. Retrieved October 31, 2007, from <http://www.dynamicbicycles.com/bikes/sizing.php>*

Figure 16-3-4 Sizing Measurements

The following steps should be followed when sizing a mountain bike:

1. **Size by Eye.** The initial step in sizing a bike is to select a bike with a frame size that coincides with the height of the mountain biker.
2. **Stand-Over Test.** The next step is to straddle the bike. There should be minimum five-centimetre (two-inch) clearance between the top tube and the crotch when the mountain biker is straddling the mountain bike.
3. **Saddle Adjustment.** Standing next to the bike, the mountain biker will adjust the saddle height to just above their hip by opening the seat post release, raising or lowering the saddle, then closing the release. The mountain biker will then sit on the saddle, place their left foot on the pedal with the ball of the foot over the centre of the pedal. The left leg should be almost perpendicular, without the knee locking.



It is important for cadets to label their bikes and helmets after they have been selected and adjusted. This can be done by using a different colour of gear or masking tape for each team/group. On the bike it is best to wrap the gear tape around the left side of the handlebar and then using a permanent marker place the cadets' initials on the tape. On the helmet, wrapping the tape around one of the side straps on the inside will work. Ensure that the cadets initials are on that as well.

**Note:** It is best to have assistant instructors help with the labelling.

---

### CONFIRMATION OF TEACHING POINT 3

---

Selecting and adjusting a helmet and a mountain bike will serve as the confirmation for this TP.

**Teaching Point 4****Explain, Demonstrate and Have the Cadet Practice the Procedure for Completing a Pre-Ride Bike Check Using the ABC Quick Check Method**

Time: 10 min

Method: Demonstration and Performance



For this skill, it is recommended that instruction take the following format:

1. Explain and demonstrate a pre-ride check while the cadets observe.
2. Explain and demonstrate each step of the pre-ride check. Monitor the cadets as they practice each step.
3. Monitor the cadets' performance as they practice a complete pre-ride check.

**Note:** Assistant instructors may be used to monitor the cadets' performance.



When demonstrating the pre-ride check, have the cadets seated away from the bikes to ensure they are paying attention.



The cadets should don their helmets prior to completing any steps of the pre-ride check. This will ensure that no cadet will ride their bike without a helmet.

Mountain biking is incredibly hard on the bikes and equipment. Before the start of a ride it is important to run through a pre-ride check to ensure the mountain bike is in the best possible condition for riding. It may seem redundant to do this before every ride, especially when a post-ride check was completed; however, it only takes one broken cable or one flat tire to ruin a ride.

The ABC Quick Check is an easy way to remember what parts of the bike should be checked during a pre-ride check. The check is a series of questions that the mountain biker must ask themselves, in relation to five areas of the mountain bike. The ABC Quick Check should be practiced so that it can be done quickly and efficiently. The mountain biker will correct any minor issues at the time of the pre-ride check; any major issues, or those that require a bike tool, will have to be brought to the attention of the ride leader for further attention.

**AIR**

The first step in the ABC Quick Check begins by focusing the mountain bikers' attention on the wheels and tires of the bike.

**Do the Tires Have Enough Air?**

This can be checked using a bicycle pump that has a built-in tire pressure gauge. The tire pressure for mountain biking should not be below 35 pounds per square inch (psi) (240 kpa) and not above 65 psi (448 kpa).



When pumping the tires, the cadets should aim to ensure that the tire pressure is between 45–50 psi (310 kpa – 345 kpa). This will allow for a variety of trail conditions.



Different trail conditions require different tire pressures. Harder surfaces are easier to ride with harder tires; 50–65 psi (345 kpa – 448 kpa), and conversely, softer surfaces are easier with softer tires; 35–40 psi (240 kpa – 275 kpa).

### **Is There Any Excessive Wear on the Tread or Any Cuts on the Sidewalls of the Tires?**

Any loose or engrained mud or debris that is lodged into the tread should be removed. This will help eliminate the possibility of sharp objects working their way through the tire casing into the inner tube, causing a flat.

### **BRAKES**

The mountain biker will now inspect the front and rear brakes of the bike. It is important to spend time on the brake levers, as well as the actual braking mechanism.

#### **Do the Brake Levers Work Effectively?**

There should be at least two finger's width of distance between each brake lever and the handlebar when pulled. It should require little effort to engage the brake lever. If it is hard to pull then the brake cables require adjustment.

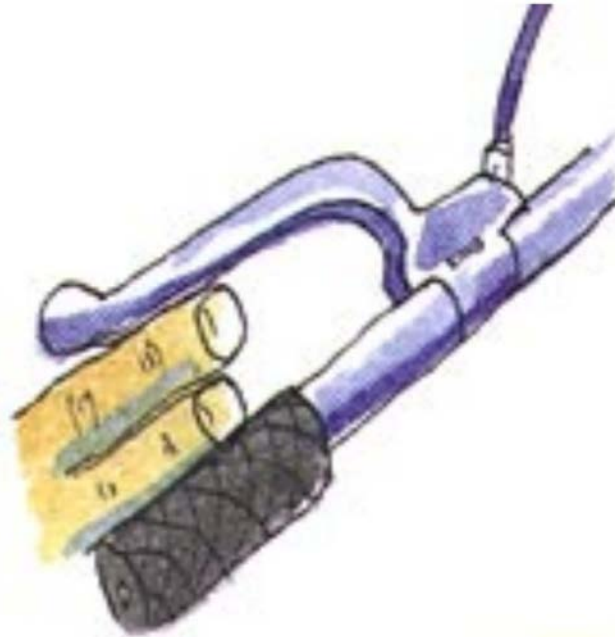

*"Ministry of Transportation Ontario", Young Cyclists Guide, Copyright 2005 by Government of Ontario. Retrieved November 5, 2007, from <http://www.mto.gov.on.ca/English/pubs/cycling/youngcyclists.htm>*

Figure 16-3-5 Brake Lever Positioning

#### **Do the Brakes Function as They Are Supposed to?**

The front and rear brakes should be checked independently. The mountain biker should stand beside the bike and push it forward by the handlebars. When the front brake lever is pulled, on its own, the rear wheel should lift up as the front wheel locks. When the rear brake lever is pulled, on its own, the rear wheel should lock and slide across the ground.

## CHAIN AND CRANK

The chain and crank are what make the bike move forward. If they are not in good working order then the bike will be difficult to manoeuvre and will most likely not get very far.

### Is the Chain On and Lubricated?

The chain should be able to move freely around the front and rear sprockets when the pedals are moved with no visible signs of bends or kinks. There should be no evidence of rust on the chain. If there is, an application of lubricant should work out the rust.



*"Ministry of Transportation Ontario", Young Cyclists Guide, Copyright 2005 by Government of Ontario. Retrieved November 5, 2007, from <http://www.mto.gov.on.ca/English/pubs/cycling/youngcyclists.htm>*

Figure 16-3-6 Lubricating the Chain

### Do the Pedals Spin Freely?

The mountain biker should lift up the rear wheel and move the pedals with one hand to check the functionality.

## QUICK RELEASE

Quick release levers are located on the front and rear wheels, as well as the seat post.

### Are the Wheel Quick Releases Working?

Open and close both the front and rear tire quick release levers. They should be easy to open and close. If not, lubricant can be applied. Ensure that they are fully tightened following the check and that the lever is flush with the fork of the bike.





*"Ministry of Transportation Ontario", Young Cyclists Guide, Copyright 2005 by Government of Ontario. Retrieved November 5, 2007, from <http://www.mto.gov.on.ca/English/pubs/cycling/youngcyclists.htm>*

Figure 16-3-7 Quick Release Incorrect Position – Example 1



*"Ministry of Transportation Ontario", Young Cyclists Guide, Copyright 2005 by Government of Ontario. Retrieved November 5, 2007, from <http://www.mto.gov.on.ca/English/pubs/cycling/youngcyclists.htm>*

Figure 16-3-8 Quick Release Incorrect Position – Example 2

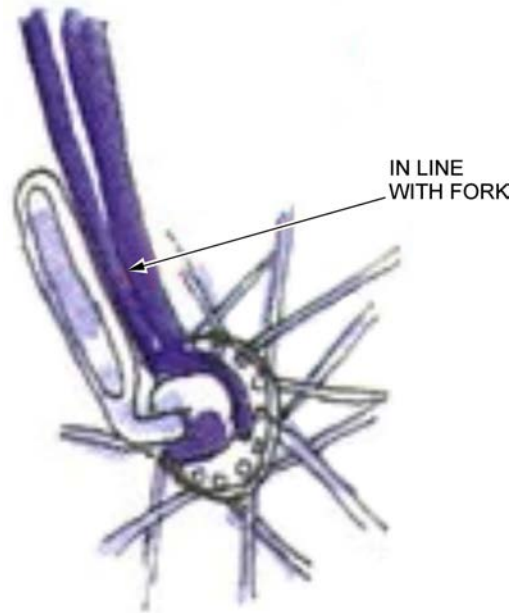

*"Ministry of Transportation Ontario", Young Cyclists Guide, Copyright 2005 by Government of Ontario.  
Retrieved November 5, 2007, from <http://www.mto.gov.on.ca/English/pubs/cycling/youngcyclists.htm>*

Figure 16-3-9 Quick Release Correct Position

### **Is the Saddle Quick Release Working?**

Open and close the lever to ensure that it is in good working order. It should be easy to open and close. If not, lubricant can be applied. When closed the lever should be flush with the seat post, pointing towards the back of the bike.

### **FINAL CHECK**

Finally, the mountain biker should complete a final check of their bike. The bike should be lifted five to seven centimetres (two to three inches) off the ground and then dropped in a controlled manner. When it drops the mountain biker should be listening for sounds associated with loose parts (clings/clangs/pings).

---

### **CONFIRMATION OF TEACHING POINT 4**

---

The cadets' participation in completing a pre-ride check of a mountain bike will serve as the confirmation of this TP.



**Teaching Point 5****Explain and Demonstrate Safety Precautions Which Must be Adhered to When Mountain Biking**

Time: 10 min

Method: Demonstration



For this TP, it is recommended that instruction take the following format:

1. Discuss the rules of the road.
2. Demonstrate all three (left, right, stop) hand signals while cadets observe.
3. Discuss ride discipline.
4. Demonstrate riding distances and stopping procedures.

Keeping safe on mountain bikes is part common sense and part informed risk-taking, together with a healthy dose of good judgment. Prevention of injury is far easier to deal with than seeking medical attention after the fact. Following basic trail and road safety rules will ensure that the ride is safe, not only for the mountain biker but for all trail users.



Investigate the specific rules and regulations associated with bike safety for your province or territory to pass along to cadets in conjunction with the material presented in this TP.

Each province and territory has specific rules and regulations in relation to bike safety. Bikes are the smallest vehicles on the road which makes it very important for mountain bikers to be as visible as possible to other road users at all times.

**RULES OF THE ROAD**

Each province has specific rules of the road which form laws within the province. In Ontario, these rules are stated in the *Highway Traffic Act* (HTA).

Some important rules that mountain bikers should know are:

- A bike is a vehicle and as a mountain biker, the same rights and responsibilities apply as to other road users.
- Stop at red lights and stop signs, and travel in the designated direction on one-way streets.
- A bike is a slow vehicle and must travel as far to the right as possible, except when preparing for a left turn or passing. Ride out from the curb far enough to maintain a straight-line path.
- Never compromise safety for the convenience of a motorist; use any part of a lane if safety of the mountain biker requires it.
- Stop for pedestrians at crosswalks, and walk the bike across crosswalks.
- Stop for school buses when the upper red lights are flashing and the stop arm is out.
- Stop 2 m (6.5 ft) behind streetcar doors and wait until the passengers have boarded or reached the curb.
- Do not attach a bike to a vehicle to hitch a ride.
- Do not ride on expressways, freeways or on roads where “No Bicycle” signs are posted.
- Mountain bikers must correctly identify themselves when stopped by the police for breaking traffic laws.

## SIGNALLING

When riding a bike on the road it is important to ensure that drivers of motor vehicles are aware of the mountain bikers' direction of travel at all times. Making a surprise turn in front of a car is dangerous to both the mountain biker and the driver. Demonstrating proper hand signals will help to eliminate some of the risk associated with riding a bike on roadways.

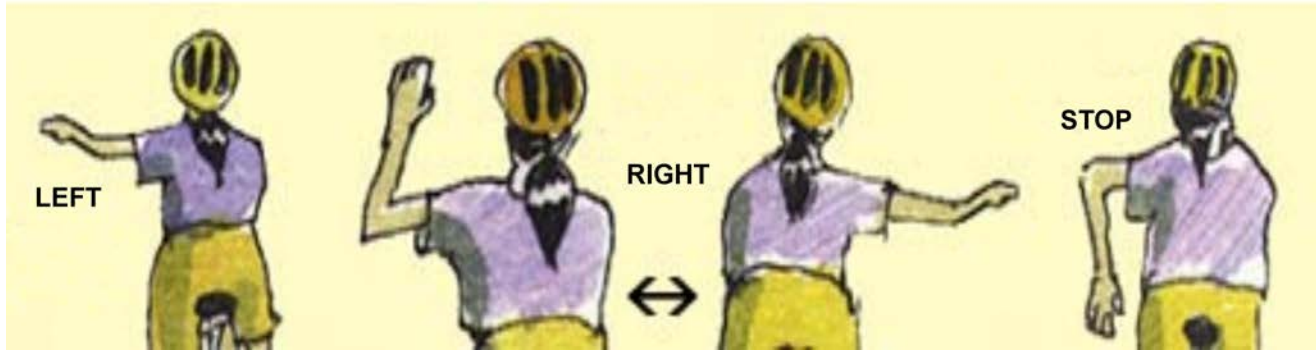

*"Ministry of Transportation Ontario", Young Cyclists Guide, Copyright 2005 by Government of Ontario.  
Retrieved October 5, 2007, from <http://www.mto.gov.on.ca/English/pubs/cycling/youngcyclists.htm>*

Figure 16-3-10 Hand Signals

## RIDE DISCIPLINE

Whether riding a bike on the side streets of town or on a double track in a conservation area, demonstrating awareness for the other mountain bikers will ensure that everyone has a safe ride. Ride discipline is a multi-faceted term that coincides with a variety of aspects of mountain biking, from personal and group organization, to stopping and starting procedures.

Riding in a group is one of the safest ways to ride. It is important to remember that each mountain biker is responsible for the person following them. Always have visual contact with the mountain biker behind. If when looking back the other mountain biker is not visible, stop and wait for a moment. If the mountain biker does not appear in a reasonable amount of time, call a halt to the mountain bikers ahead, and go back and look for the other mountain biker.

There are a few safety tips to keep in mind when travelling in groups:

- Ride in single file on roads and trails as much as possible.
- The lead mountain biker must communicate turns, obstacles and changes in momentum to the remainder of the group through hand signals and voice commands.
- Keep at least 1 m (3.2 ft) between mountain bikers in the group on flat ground.
- When descending hills, keep at least 3 m (9.8 ft) between mountain bikers.
- When ascending hills, stay in single file and keep to the right.
- When stopping, ensure that the entire group is completely off the trail or road.
- When stopped, all group members should get off their bikes, turn bikes so they are facing the road, close in ranks and stand to the left of their bikes.
- If travelling on roads in a large group, break into smaller groups of about 10 with at least 1 km (.62 miles) between each group to allow traffic to pass.
- Road crossings should be completed with the group lining up parallel to the other side of the road and then, in-line, walking their bikes across.

---

## CONFIRMATION OF TEACHING POINT 5

---

### QUESTIONS

- Q1. The rules of the road are found in what document?
- Q2. When making a left hand turn what hand signal should be used?
- Q3. When riding in a group how should you cross a road?

### ANTICIPATED ANSWERS

- A1. They are found in provincial regulations.
- A2. The left arm should be extended straight out from the body.
- A3. Road crossings should be completed with the group lining up parallel to the other side of the road and then, in-line, walk their bikes across.

---

### Teaching Point 6

### Explain, Demonstrate and Have the Cadet Practice Mountain Bike Techniques

Time: 55 min

Method: Demonstration and Performance

---



The cadets should be standing beside and to the left of their bikes with their helmets on, in a large semicircle when presented the demonstration portion of each skill.



When the cadets are practicing each individual technique, it is important to set clear and defined boundaries of where they are to ride. It is also important to give specific time limits for each practice phase and a signal for the cadets that tells them to return to the main teaching area and reform the semicircle for further instruction. This could be a whistle blast. Establish signals before the demonstration and ensure cadets know what action is required.



Mountain bike techniques should be presented using the following format:

1. Explain and demonstrate each technique while the cadets observe.
2. Explain and demonstrate the steps for each technique in the following order – mounting, braking, dismounting, gearing, ascending hills and descending hills – while the cadets observe. Ascending and descending hills can be demonstrated concurrently.
3. In a controlled manner, have the cadets practice the steps for all skills. Changes from step to step and technique to technique should be on the command of the instructor.
4. Monitor the cadets as they practice all techniques.

**Note:** Assistant instructors may be used to monitor the cadets' performance.

## MOUNTING

The straddle mount is the most common way to mount a bike. It is always advisable that the bike is in a low, easy gear prior to attempting to mount it.



It is recommended that the mountain biker start the mounting procedure with their non-dominant side. If they are right-handed then they should start with the left pedal. If left-handed then they should start with the right pedal.



Instructions for the cadets who favour the left leg are in brackets.

The steps for completing a straddle mount are as follows:

1. Stand to one side of the bike with hands firmly on the handlebars.
2. Lift the right (left) leg over the saddle and straddle the bike.
3. Move the right (left) pedal into the three o'clock position.
4. Place the left (right) foot securely on the left pedal and then hop onto the saddle and push forward.
5. Once moving forward, place the right (left) foot onto the right (left) pedal and keep pedalling.

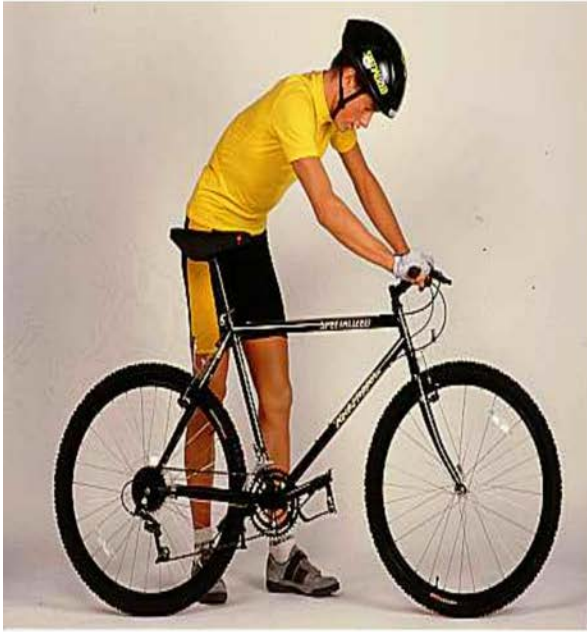

STEP 1

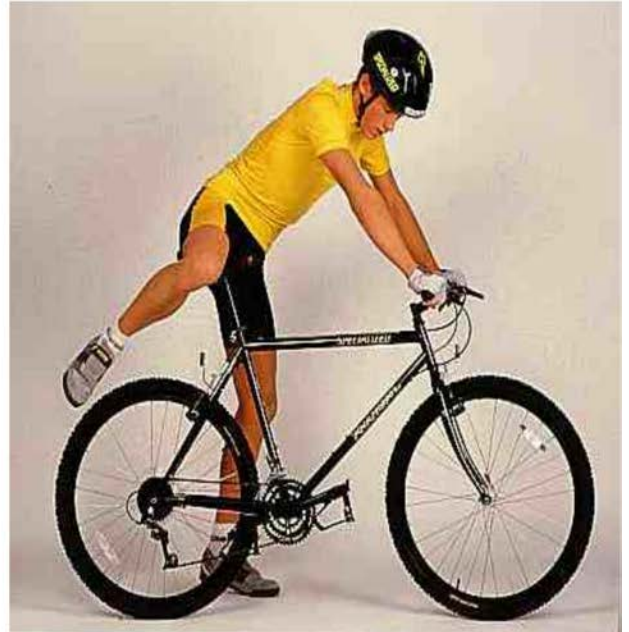

STEP 2



STEP 3-5

*"DK Images", Sports, Games, Recreation, Mountain Biking, Copyright 2007 by DK Limited. Retrieved November 5, 2007, from <http://www.dkimages.com/discover/Home/Sports-Games-Recreation/Outdoor-Adventure/Mountain-Biking/index.html>*

Figure 16-3-11 Straddle Mount a Bike

## BRAKING

Braking is used not only for stopping, but for slowing down and controlling the bike through technical portions of the trail. It is important for a mountain biker to be able to judge the amount of pressure to use and when to brake for various situations while on the roads and trails. This knowledge will ensure personal safety as well as the safety of other mountain bikers and trail users.

The left hand brake lever controls the front brake while the right hand lever controls the rear. Most braking is completed by the right hand, rear brakes, with the left adding assistance as required.

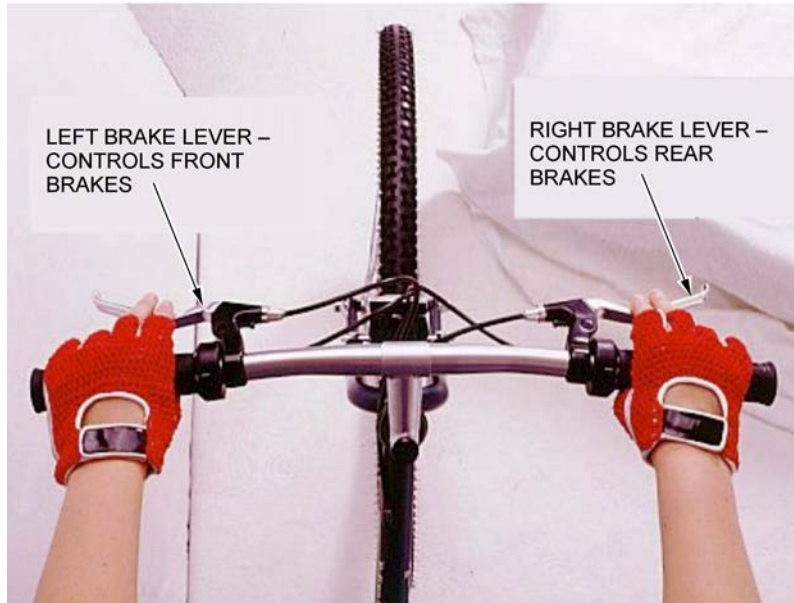

*"DK Images", Sports, Games, Recreation, Mountain Biking, Copyright 2007 by DK Limited. Retrieved November 5, 2007, from <http://www.dkimages.com/discover/Home/Sports-Games-Recreation/Outdoor-Adventure/Mountain-Biking/index.html>*

Figure 16-3-12 Braking Hand Position

## DISMOUNTING

The straddle dismount is the most common and safest dismount.

The steps to complete a straddle dismount are as follows:

1. Prepare to stop by applying the brakes to slow down the bike.
2. While coasting, remain seated in the saddle.
3. Place the left (right) pedal into the six o'clock position.
4. Remove the right (left) foot from the right (left) pedal and place it on the ground slightly to the outside of the pedal.
5. Once the bike has come to a complete stop, slide forward off the saddle and place the left (right) foot onto the ground.
6. Swing the right (left) leg over the back of the bike.



Mountain bikers should be cautioned against using the left brake lever by itself. While this will stop the bike, the forward momentum may cause the mountain biker to continue over the front of the handlebars and bike, resulting in a possible injury.

## GEARING

Terrain can change quickly when mountain biking. The ability to time a perfect gear shift is a crucial mountain bike technique to master. Smooth shifting makes the difference between a smooth, easy ride and a rough, hard ride. Gear components are equipped with pre-set gears and ramps built into the chainrings and cogs to



help the chain move smoothly from one to another. The mountain biker has to shift to the correct gear at the appropriate time.

Gearing adjusts the pedalling load so the mountain biker can adapt to changes in terrain. A gear is described by the number of teeth on the sprocket that is being used.

### Gear Ratio

The gear ratio is the relationship between the front chainring and the rear cassette being used. If the chainring and the cog have the same number of teeth, then the rear wheel would turn once for every pedal stroke and the ratio would be 1 : 1. If the chainring has more teeth than the cog, for example, 34 versus 17, then the ratio would be 2 : 1 and the rear wheel would revolve twice for every pedal stroke. There can also be negative gear ratios where the rear cog has more teeth than the smallest chainring, which makes the rear wheel turn slower than the pedal stroke.



FRONT CHAINSET



REAR CASSETTE

*"DK Images", Sports, Games, Recreation, Mountain Biking, Copyright 2007 by DK Limited. Retrieved November 5, 2007, from <http://www.dkimages.com/discover/Home/Sports-Games-Recreation/Outdoor-Adventure/Mountain-Biking/index.html>*

Figure 16-3-13 Front Chainset and Rear Cassette

Typically, mountain bikes have two or three chainrings in the front and seven to nine cogs in the back. Each of these sprockets is attached to a numerical value, which corresponds to the numbers on the gear shifting mechanism attached to the handlebars.

### Chainset

The chainset is numbered one through three. The biggest chainring in the chainset – three – is located on the outside of the set while the smallest chainring in the chainset, one, is located on the inside of the set.

The bigger chainring in the chainset is used for flat terrain, high speeds, downhills and road pedalling. The middle chainring in the chainset is for most off-road situations including single track, small hills and bumpy downhills. The smallest chainring in the chainset is used for steep uphill and very difficult technical terrain.

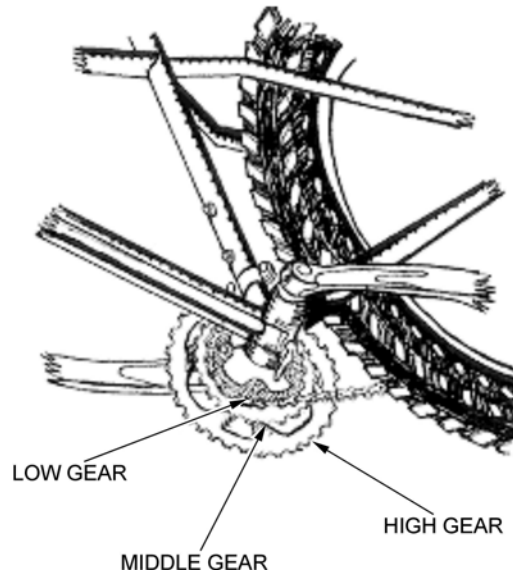

"Gorp", *Your First Mountain Bike Moves: Shifting Gears*, Copyright 2007 by Orbitz Away LLC.  
Retrieved November 7, 2007, from [http://www.gorp.away.com/gorp/publishers/menasha/how\\_ride5.htm](http://www.gorp.away.com/gorp/publishers/menasha/how_ride5.htm)

Figure 16-3-14 Front Chainset

### Cassette

The cassette is numbered one through nine from the inside, closest to the frame, to the outside. The inside cogs, the larger sprockets, equal the low and easiest gears which are primarily used to climb hills and when traversing uneven terrain. The outside, smaller sprockets, equal the highest and hardest gears which are used to gain speed on flat terrain.

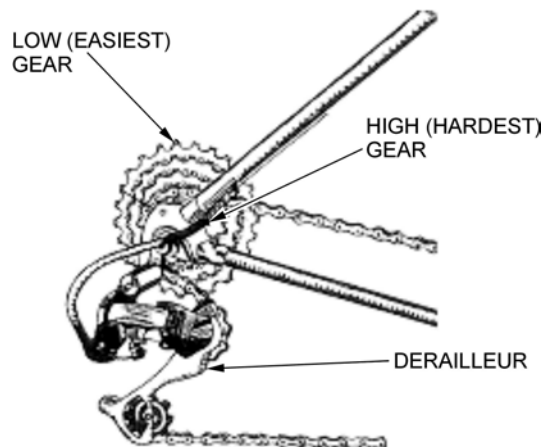

"Gorp", *Your First Mountain Bike Moves: Shifting Gears*, Copyright 2007 by Orbitz Away LLC.  
Retrieved November 7, 2007, from [http://www.gorp.away.com/gorp/publishers/menasha/how\\_ride5.htm](http://www.gorp.away.com/gorp/publishers/menasha/how_ride5.htm)

Figure 16-3-15 Rear Cassette



The bike chain should never be in the big rings on the front and rear at the same time. It places an enormous amount of tension on the chain as it moves the chain from a straight to a diagonal line.



## Shifting Gears

As with braking, the left gear shifter controls the chainrings on the front chainset, while the right gear shifter controls the cogs on the rear cassette. When the gear shifter is pushed, the derailleur, front or rear, will move the chain from one sprocket to another.



*"2 Wheel Bikes", Suspension Mountain Bikes. Retrieved November 7, 2007, from <http://www.2wheelbikes.com/suspension-mountainbikes/sm3000-mountain-bike.html>*

Figure 16-3-16 Right Gear Shifter

All mountain bike gears are indexed which means that they are pre-set and will click into place when the gear lever is activated. Most bikes have a visual indicator on both sides, which shows what gear the bike is in.

Pushing the gear shifter moves the chain onto a bigger chainring or cog, because the movement is against the spring tension in the derailleur. The mountain biker will have to push the lever further than the resting point so that the chain can make it up onto the bigger chainring or cog. This is done with the mountain biker's thumb, because it is stronger than the index finger.

Changing to the smaller chainrings or cogs is an easier motion because the lever is releasing the spring tension, letting the derailleur fall naturally into position. These gear changes are completed using the mountain biker's index finger to pull the lever forward.

It is possible to change more than one gear at a time. This is done through either a series of several clicks or one movement depending on the type of gear shifting mechanism the bike uses.

There are several important points to remember when gearing:

- Gears cannot be changed if the pedals are not moving.
- Cogs are used for small changes in speed, like when the mountain biker is climbing a long steady hill.
- Chainrings are for bigger changes in speed, such as descending the summit of a hill.
- The ideal gear to begin biking is somewhere in the middle of the cassette, four or five, and the middle chainring.

## ASCENDING HILLS

Climbing hills is a challenge when mountain biking and the mountain bike has been specifically designed to meet this challenge. Its broad, grippy tires, the position of the mountain biker over the back wheel and the increased number of gears give the mountain bike the technical ability to ascend hills.

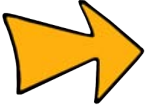

A mountain bike can handle inclines close to 45 degrees on badly broken ground.

Being able to ascend a hill is influenced by two factors – power and balance. Balance is gained through awareness and practice, while power is gained through repetition of the skill and muscular and cardiovascular strength.

There are factors that affect the mountain bikers' technique while attempting to ascend a hill.

### Position

The centre of gravity of a bike and the mountain biker is located at the mountain biker's abdomen. When climbing a hill, the centre of gravity must move forward on the bike to enable the mountain biker to keep their balance. The mountain biker should pull their body weight forward on the bike as the climb gets steeper, otherwise the front tire will not have enough weight on it and will lift up, resulting in a fall.



Centre of gravity is the point where all the weight of an object is concentrated.



*T. Brink, The Complete Mountain Bike Book, Ragged Mountain Press (p. 51)*

Figure 16-3-17 Proper Ascent Position



While it may seem easier to stand up from the saddle when climbing hills, it in fact requires more power and expends more of the mountain biker's energy. Keeping the body low and forward on the saddle is a much more effective climbing position.

### Gearing and Shifting

Depending on the steepness of the hill, it is acceptable to have the front chainset on the middle chainring, index two. The rear cassette is more dependent on the grade of the hill. It is advisable, when approaching

a hill to begin shifting down into a medium intensity gear, perhaps four or five. Once the mountain biker has begun the ascent they will have to continue to lower the cogs in relation to their ability to maintain pedal power. Remember that in order to change gears, the pedals have to be moving and the more steep the incline the harder it will be to pedal.

## DESCENDING HILLS

Descending is about letting gravity do the work, while the mountain biker concentrates on braking and distributing weight. It becomes a combination of balance and applying the brakes at the correct time. Mountain bikers must always think ahead and be aware of rough terrain, corners, obstacles and other mountain bikers that may be on the trail. It is critical to apply the brakes to move around or by disturbances, but not too much will completely lose the momentum from the hill.

### Position

When descending a hill it is critical that the centre of gravity of the mountain biker does not fall more than halfway down the top tube of the bike. If it does, the mountain biker may go over the handlebars. The mountain biker should move their body weight towards the back of the bike, be as low as possible and extend their arms so they are almost straight in front of them. Depending on the steepness of the hill, the mountain biker may want to slide their bottom off and behind the saddle for further stability.



*"2 Wheel Bikes", Suspension Mountain Bikes. Retrieved November 7, 2007, from <http://www.2wheelbikes.com/suspension-mountainbikes/sm3000-mountain-bike.html>*

Figure 16-3-18 Proper Descent Position

### Gearing and Shifting

Gearing and shifting are not as critical when descending hills as they are in ascending hills. The key thing to remember is that descending hills provides momentum, and speed must be maintained once the hill has ended. To do this, think ahead and shift into gears that will provide the most momentum. The front chainset should be in the biggest chainring and the rear cassette should be in the highest gear, eight. It may be necessary to shift to lower gears once the momentum from the hill begins to slow and pedalling gets harder.



Speed must be controlled when descending hills, with the mountain biker applying equal brake pressure, as required, on both the front and rear brakes. The mountain biker's hands must remain on the brake levers for the duration of the descent and should be ready to break at all times.

---

### CONFIRMATION OF TEACHING POINT 6

---

The cadets' participation in the practice of each mountain bike technique will serve as the confirmation of this TP.

---

#### Teaching Point 7

#### Have the Cadet Practice Mountain Bike Skills and Techniques During an Expedition

Time: 45 min

Method: Practical Activity

---

### ACTIVITY

---

#### OBJECTIVE

The objective of this activity is for the cadets to participate in a practical expedition activity to practice mountain bike skills and techniques in a controlled environment for an extended period of time.

#### RESOURCES

- Mountain bike equipment, to include:
  - Mountain bike (one per cadet),
  - Helmet (one per cadet),
  - Bell or horn (one per mountain bike),
  - Lights and reflectors,
  - Water carrier (one per cadet),
  - Day pack (one per cadet); and
- Topographical map of area (one per team/group),
- Compass (one per team/group),
- Whistle (one per cadet),
- Communication device (two per team/group),
- GPS Receiver (one per team/group),
- Batteries (spares for communication device and GPS),
- First aid kit (one per team/group), and
- Bike maintenance tool (one per team/group).

#### ACTIVITY LAYOUT

Designated novice mountain bike trail route.

## ACTIVITY INSTRUCTIONS

1. Have the cadets retrieve their bikes and helmets.
2. Have the cadets conduct a pre-ride check for no longer than 10 minutes.
3. Conduct a mountain bike phase of the practical expedition activity, following the designated route to practice:
  - (a) mountain bike techniques, to include:
    - (1) mounting;
    - (2) braking;
    - (3) dismounting;
    - (4) gearing;
    - (5) ascending hills; and
    - (6) descending hills; and
  - (b) riding formations, and
  - (c) communication skills.
4. Upon arrival at the end point, instruct TP 8 and then have the cadets store their bikes and helmets.

## SAFETY

- Each group will have a cadet wearing a reflective vest in both the front and back.
- Road- and trail-riding rules must be reviewed with the cadets prior to the commencement of the ride.
- The cadets must travel in single file at all times.
- The cadets must use road hand signals.
- All the cadets must have at least 500 mL (16 oz) of water.

---

## CONFIRMATION OF TEACHING POINT 7

---

The cadets' participation in the activity will serve as the confirmation of this TP.

---

### Teaching Point 8

### Explain and Demonstrate the Procedure for Completing a Post-Ride Bike Check

Time: 5 min

Method: Demonstration and Performance

---



This TP can be instructed following the biking phase of the practical expedition activity. The instructor should first demonstrate the procedure on their bike and then have the cadets complete a post-ride bike check on their own bike.

Proactive maintenance can reduce the chances of trail side breakdowns. It is the mountain biker's responsibility to ensure the bike is road/trail ready. The initial step in this process is through the implementation of the pre-ride bike check. While the pre-ride check is important, it is just as important to complete a post-ride check.

A post-ride check consists of:

- cleaning; and
- assessing for repairs.

## **CLEANING**

Mountain biking can be a dirty sport. While riding through mud, dirt and water on the trails is part of the experience, if left on the bike long term they can effect the technical components of the mountain bike. Regularly cleaned parts last longer. The following steps should be taken when cleaning the bike:

1. Hose the bike down to get as much mud and dirt off as possible.
2. Turn the bike upside down, wipe down the tires.
3. Using a stiff brush clean all excess dirt and grease off the rear cassette and the front chainset.

## **ASSESSING FOR REPAIRS**

A final quick assessment of the bike should be completed to ensure that nothing requires maintenance before the next time the bike is used. Some key issues to look for include:

- frayed or damaged cables,
- unevenness in the cable and lever system of the brakes; the brake lever should not be able to touch the handlebar,
- cuts in the sidewalls of the tires, and
- wear, cuts and missing knobs on the tires.

---

### **CONFIRMATION OF TEACHING POINT 8**

---

The cadets' participation in completing a post-ride check of a mountain bike will serve as the confirmation of this TP.

---

### **END OF LESSON CONFIRMATION**

---

The cadets' participation in the practical expedition activity will serve as the confirmation of this lesson.

---

### **CONCLUSION**

---

## **HOMEWORK/READING/PRACTICE**

N/A.

## **METHOD OF EVALUATION**

This EO is assessed IAW A-CR-CCP-703/PG-001, Chapter 3, Annex B, Appendix 7 (326 PC).

## **CLOSING STATEMENT**

Mountain biking is one of three dynamic modes of transport that can be used during expedition training. It is critical that the cadets understand the importance of maintaining a mountain bike and riding it safely. Being able to perform mountain bike techniques will allow the cadets to have an enjoyable and safe experience during the biking phase of the practical expedition activity.

**INSTRUCTOR NOTES/REMARKS**

Expedition centres are required to select two dynamic modes of travel from EO M326.02a (Paddle a Canoe, Section 2), EO M326.02b (Ride a Mountain Bike), and EO M326.02c (Hike Along a Route, Section 4) to incorporate into their weekend training.

This EO has been allocated five and a half periods in the overall course period allocation. Each expedition centre may adjust this allocation to reflect the choice of activities, facilities and available resources at the expedition centre.

Upon arrival at the expedition centre cadets will be broken into teams/groups. These teams/groups will remain the same for the duration of the weekend.

IAW A-CR-CCP-951/PT-002, the following equipment is required for the familiarization ride:

1. reflective vest (worn by the person in the rear of the group),
2. topographical map of the area (if unfamiliar),
3. compass,
4. first aid kit,
5. communication device (cellular phone or hand-held radio), and
6. basic bike repair kit.

---

**REFERENCES**

---

- A2-001 A-CR-CCP-951/PT-002 Director Cadets 3. (2006). *Royal Canadian Army Cadets Adventure Training Safety Standards*. Ottawa, ON: Department of National Defence.
- C2-082 (ISBN 1-57954-883-0) Downs, T. (2005). *Bicycle Maintenance & Repair for Road & Mountain Bikes*. USA: Rodale Inc.
- C2-083 (ISBN 0-07-149390-5) Brink, T. (2007). *The Complete Mountain Biking Manual*. Camden, ME: Ragged Mountain Press.
- C2-084 (ISBN 1-55297-734-X) Allwood, M. (2004). *Mountain Bike Maintenance: The Illustrated Manual*. Richmond Hill, ON: Firefly Books Ltd.
- C2-087 Badyk, M., Buck, K., Sahl, N., Schultz, R., & Vrooman, D. (1998). *Ontario Learn to Mountain Bike Clinic Workbook* (2<sup>nd</sup> ed.). North York, ON: Ontario Cycling Association and Ontario Recreational Mountain Bicycling Alliance.
- C2-088 (ISBN 1-55297-653-X) Crowther, N. (2002). *The Ultimate Mountain Bike Book: The Definitive Illustrated Guide to Bikes, Components, Techniques, Thrills and Trails*. Toronto, ON: Firefly Books Ltd.
- C2-089 Ministry of Transport Ontario. (2007). *Young Cyclists Guide*. Retrieved October 5, 2007, from <http://www.mto.gov.on.ca/english/safety/cycling/youngcyclist.htm>.
- C2-090 International Mountain Bicycling Association. (2007). *Trail Difficulty*. Retrieved October 10, 2007, from [http://www.imba.com/resources/trail\\_building/itn\\_17\\_4\\_trail\\_difficulty.html](http://www.imba.com/resources/trail_building/itn_17_4_trail_difficulty.html).
- C2-092 Ministry of Transport Ontario. (2007). *Cycling Skills: Cycling Safety for Teen and Adult Cyclists*. Retrieved October 5, 2007, from <http://www.mto.gov.on.ca/english/pubs/cycling/cyclingskills.htm>.

THIS PAGE INTENTIONALLY LEFT BLANK





**ROYAL CANADIAN ARMY CADETS**  
**SILVER STAR**  
**INSTRUCTIONAL GUIDE**



**SECTION 4**  
**EO M326.02C – HIKE ALONG A ROUTE**

---

Total Time: 165 min

---

**PREPARATION**

---

**PRE-LESSON INSTRUCTIONS**

Resources needed for the delivery of this lesson are listed in the lesson specification located in A-CR-CCP-703/PG-001, Chapter 4. Specific uses for said resources are identified throughout the instructional guide within the TP for which they are required.

Review the lesson content and become familiar with the material prior to delivering the lesson.

Ensure every cadet has a water carrier.

**PRE-LESSON ASSIGNMENT**

Instructors should be aware of and discuss interesting historical sites and geographic features along the route as well as trivia on flora and fauna. This will enhance the experience for the cadet and help create interest. The hike should be treated as a learning experience, not a forced march.

**APPROACH**

A practical activity was chosen for this lesson as it is an interactive way to allow the cadet to experience hiking on Class 3 terrain in a safe, controlled environment.

---

**INTRODUCTION**

---

**REVIEW**

N/A.

**OBJECTIVES**

By the end of this lesson the cadet shall be expected to hike 8–10 km along a route with some Class 3 terrain using the “rest step” principle and employing obstacle crossing techniques as required.

**IMPORTANCE**

It is important for cadets to be able to hike along a route that contains Class 3 terrain so they will be prepared for the technical challenges if/when given the opportunity to participate in more advanced level expeditions. Hiking is not just about walking along a trail or predetermined route; it requires the individual to be aware of their surroundings, their limitations and the limitations of the group they are travelling with. Knowing what to do when an obstacle is on the route is critical for everyone’s safety. As well, having a basic knowledge and understanding of techniques such as the “rest step” will make the hike more enjoyable for all members.

---

## BACKGROUND KNOWLEDGE

---



The TPs for this lesson will be presented during hiking familiarization training. Some material may be presented prior to departure, with the remainder being incorporated into teachable moments and breaks throughout the route. Cadets will have been introduced to many of the theoretical concepts, this activity will provide them the opportunity to put into practice what they have already learned.

### THE DIFFERENCE BETWEEN HIKING, TREKKING AND BACKPACKING

Hiking is an activity of vigorous walking in the outdoors/wilderness on an unpaved trail, either on a path or navigating along an unmarked route. Usually day hikes consist of travelling cross-country over different terrains, sometimes with inclines and declines. It provides individuals the opportunity to travel to destinations that could not, in many cases, be seen any other way.

The aim of hiking is to learn skills beneficial to physical health. It offers an alternative learning environment and allows participants to explore the outdoor surroundings. For individuals who have never participated in hiking activities, it can be quite challenging. However, it can also offer a challenge to experienced hikers by varying the location/terrain of the hikes.

Trekking is a journey over long distances over several challenging days. Usually trekking involves terrain that requires crossing obstacles.

Hiking becomes backpacking when equipment is carried for an overnight stay.

### PERSONAL CLOTHING AND EQUIPMENT FOR HIKING

#### Clothing

Clothing for the outdoors is slightly different than everyday clothing, yet everyone has clothing at home they can wear outside. When choosing clothing for outdoors, consider clothing that:

- is in good repair,
- breathes: perspiration must be able to escape the body and evaporate (depending on exertion, the body will warm up and become damp, even sweaty),
- is appropriate for the weather conditions and the activity,
- is made of materials that dry easily,
- offers wind and rain protection resistance,
- insulated and padded,
- flexible without drag,
- can be layered as necessary, and
- is comfortable.

#### Footwear

The most important factor to consider when selecting hiking footwear is fit. The footwear should be sufficiently sturdy to hold together throughout a trip. It should provide protection for the feet, and a firm foundation for walking and scrambling. Today, boots are derived from athletic shoe technology. They are light, comfortable and functional. Common characteristics to look for when selecting a hiking boot are:

**Sturdy.** The boot should support feet and ankles from twisting on uneven surfaces. Higher boots with stiff ankle support provide lateral rigidity. The boot should also support the foot from overextending when placing too much weight on the toe or heel.

**Lightweight.** The lighter the boots the easier walking will be. Every extra pound of footwear weight can be compared to five pounds of added backpack weight.

**Comfortable Fit.** When worn, boots shall fit snugly with the heel snug against the wall of the shoe and a small amount of space for the toes to move.

**Correct Size.** Proper fitting boots ensure comfort during hiking. A boot fits correctly when:

- it is wide enough so the boot matches the width of the foot with little extra room,
- the tongue rests comfortably along the top of the toe, and
- the toes have room to wiggle.

### **Socks**

The boot is only part of the footwear system; socks are the first line of defence for the feet. A two-sock system is common in many activities. Unless hiking regularly in hot, damp conditions, consider wearing one pair of heavy socks and one pair of light, inner socks. Always ensure socks are properly sized for the foot.

**Inner Socks.** This is a thin layer that helps wick, or pull moisture away, from the foot. They are usually made of a polypropylene material.

**Outer Socks.** This layer is most often made of wool or a wool blend, which can absorb moisture. This layer cushions the foot and provides insulation.

### **Pack**

There are many devices made to assist in carrying loads on a hike. For day trips, use a small pack which can comfortably hold all required items. In the winter, there may be a requirement for extra capacity.

**Fanny Pack.** The pack for short hikes or treks up to a few hours is a fanny pack. This pack is a small, unobtrusive pack that sits atop the buttocks, with a thin belt that clips around the waist. These are also known as waist, or lumbar, packs. The simplest of these packs consists of a pouch sewn to a piece of flat webbing. More elaborate fanny packs can hold upwards of 10 L, and have padded belts and suspensions. The fanny pack is lightweight, and holds the load close to the spine and a person's centre of balance. Items carried in a fanny pack should be limited to 4.5 kg (10 lbs).



*ABC-of-Hiking, 2007, Shop Backpacks, Copyright 2007 by Max Lifestyle.net "Go Hiking Like Max". Retrieved April 19, 2007, from <http://www.abc-of-hiking/shopitems/backpacks/prowler5-backpacks.asp>*

Figure 16-4-1 Fanny Pack

**Day Pack.** Day packs are produced in numerous model types; however, all have shoulder straps and a waist belt. Most day packs have pockets for organizing equipment and basic exterior features (eg, axe loops and daisy chains).

Important qualities of a good day pack include:

- back padding to protect shoulder blades,
- firmly padded shoulder straps,
- adjustment straps for placing weight between shoulders and hips,
- an internal frame (more durable and comfortable to wear),
- padded hip belt; four inches wide around hips and two inches at the buckle, and
- 35–40 L in volume (roughly 9–13 kg [20–30 lbs]).



*ABC-of-Hiking, 2007, Shop Backpacks, Copyright 2007 by Max Lifestyle.net "Go Hiking like Max". Retrieved April 17, 2007, from <http://www.abc-of-hiking/shopitems/backpacks/team-backpacks.asp>*

Figure 16-4-2 Day Pack

## Ten Essential Items

**Water Carrier.** One indispensable item in any wilderness traveller's kit is a water carrier. Carrying water during a hike requires a lightweight water bottle with a tight lid that is easily refillable. Versatile equipment benefits the user. When choosing a bottle it is advisable to choose one that can withstand the temperatures of frozen or hot liquids.

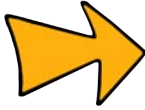

Wide mouth bottles are a practical choice as many water filters are built to twist directly onto the opening of the bottle. This simplifies the water filtering process.



Hydration bags are an excellent water carrying device which allows the user to easily carry between 1 L and 4 L of water at a time. They are built into a pack and consist of a lightweight plastic bladder and a drinking tube that passes over the shoulder of the user and allows for easy hydration while hiking.



*"Mountain Equipment Coop", Copyright 2007 by Mountain Equipment Coop. Retrieved March 28, 2007, from [Shttp://www.mec.ca/Products/product\\_detail.jsp?PRODUCT%3C%3Eprd\\_id=845524442500177&FOLDER%3C%3Efolder\\_id=2534374302696609&bmUID=1177425692300](http://www.mec.ca/Products/product_detail.jsp?PRODUCT%3C%3Eprd_id=845524442500177&FOLDER%3C%3Efolder_id=2534374302696609&bmUID=1177425692300)*

Figure 16-4-3 Wide Mouth Water Bottle



*"Bionic Sports", Copyright 2007 by Bionic Sports. Retrieved November 16, 2007, from <http://www.bionicsports.com/acatalog/Hydration.html>*

Figure 16-4-4 Hydration Bag

**Pocket Knife.** A knife or multi-purpose tool is essential for repairing equipment and cutting rope, cord or bandages. The key is to find a knife or tool that is small but has all the attachments – blade, scissors, screwdriver – that may be required while out on a hike.

**Extra Food.** It is always advisable to bring extra food on a hike. Snacks such as granola bars, GORP (good old raisins and peanuts), chocolate bars, and dried fruit will provide the hiker with an energy boost. In an emergency situation they may increase chances of survival.

**Extra Clothing.** Extra clothing includes an additional layer of warm clothing and a rain coat. A light down vest, sweater, or fleece jacket will provide insulation should the weather be cooler than expected, and during breaks when sweat evaporates and the body cools. Just because the sun is shining at the start of a hike does not mean it will be shining at the end. Rain coats may also be used in building a shelter in an emergency situation.

**Sunscreen.** Sunscreen blocks or prevents the skin's exposure to the sun or ultraviolet light. The skin will burn when the amount of exposure to the sun, or ultraviolet light source, exceeds the ability of the body's protective pigment to protect the skin. According to the *Canadian Dermatology Association* a minimum of SPF 15 with UV-A and UV-B protection should be worn.

**Sunglasses.** Hikers should always wear sunglasses to protect their eyes against damage from the sun's light (eg, ultraviolet, bright or intense light, and blue light). This is especially important in the winter, as snow blindness is a prevalent injury.

**Hat.** A wide brimmed hat will protect the back of the neck, ears, and face from burning. A toque in the winter will keep the hiker's ears warm and stop the escape of heat from the head.

**Insect Repellent.** Annoying mosquitoes and black flies can have a negative impact on a hike. Wear loose fitting clothing with closed cuffs and apply insect repellent to ward off unwanted insects. The repellent should be applied to the exposed areas of the body. Many insect repellents rely on chemicals such as DEET to repel insects and have long durations per application.

**Headlamp.** A headlamp is simply a flashlight that has been attached to an adjustable strap that fits around the user's head. It is beneficial on a hike as it frees up the user's hands to complete tasks when light is low or it is dark.



"Mountain Equipment Coop", Copyright 2007 by Mountain Equipment Coop. Retrieved November 16, 2007, from [http://www.mec.ca/Products/product\\_detail.jsp?PRODUCT%3C%3Eprd\\_id=845524442621000&FOLDER%3C%3Efolder\\_id=2534374302697057&bmUID=1195238790425](http://www.mec.ca/Products/product_detail.jsp?PRODUCT%3C%3Eprd_id=845524442621000&FOLDER%3C%3Efolder_id=2534374302697057&bmUID=1195238790425)

Figure 16-4-5 Headlamp

**Survival Kit.** Having a survival kit is a must during any wilderness hiking trip. It should include water purification tablets, a light source, waterproof matches, a signalling device and first aid materials.

**Notebook and Pencil.** Having a notebook and pencil will allow hikers to keep a log throughout the hike. Collecting information such as route details, trail condition, trail difficulty, and general observations will provide the individual with beneficial material when planning other hikes. It will also provide a record of the experience.

## TERRAIN

Terrain is the physical characteristics of the ground, whether it is a flat, straight trail or an ice-peaked mountain. There are different types of terrain that one can expect to encounter on a route.



IAW with A-CR-CCP-951/PT-002, the CCM uses the Yosemite Decimal System (YDS) to rate trail difficulty levels. YDS has a scale from 1–5 and it rates the hardest/most technical section on a terrain/route. It also provides ratings for travel over flat terrain.

**Class 1.** Hiking, usually on a trail.

**Class 2.** Simple scrambling, crossing obstacles with the occasional use of hands, requires route-finding skills, may be backcountry dense bush.

**Class 3.** Angle is steep enough that hands are required for balance; scrambling on rocks using hands and feet, a rope might be carried.

**Class 4.** Simple climbing, often with exposure requiring a rope belay. A fall could be serious or fatal. Natural protection can usually be easily found.

**Class 5.** Technical rock climbing begins. Climbing involves the use of ropes, belays, and the placement of natural or artificial protection for the leader in case of a fall. An open-ended decimal extension to Class 5 exists for rating climbs within this category.

### Types of Terrain

**Easy Terrain.** Terrain is flat and footing is secure. Forest roads, trails following streams and rolling hills are generally easy walking.

**Moderate Terrain.** Terrain with a trail that is mostly solid under foot with either one fairly steep hill or a series of small hills or forest floors with light underbrush.

**Difficult Terrain.** Any terrain in which a person ascends or descends over 150 m in 1 km. It can also consist of patches of dense forests, thick vegetation and rocky trails/root covered trails.

Rates of travel will differ, depending on the group, equipment, terrain, elevation above ground, etc. Generally:

- On easy terrain with a pack, a group can be expected to travel 3–5 km/h.
- On difficult terrain with a pack, a group can be expected to travel 1.5–3 km/h.
- In difficult terrain, the rate of travel can drop to a third or even a quarter of what it would be on easy terrain.
- When above 3000 m, the rate of travel will greatly decrease. On average, a person will travel 1 km/h less for every 1000 m gained in elevation.
- When descending on easy terrain, the rate can be up to twice the speed of the ascent.

### USING TREKKING POLES WHILE HIKING

#### Types of Poles and Sticks

There are three types of trekking poles – ski poles, wooden walking sticks and telescoping trekking poles. Depending on the activity, the choice of pole will be different.

Trekking poles provide better balance and reduce the amount of stress on the knees, shoulders and back. They absorb some of the impact the body would otherwise absorb. The poles, rather than the body, absorb shock, reduce arm and leg fatigue and improve endurance.

Ski poles and walking sticks may be used for long walks and easy treks on fairly level surfaces. The walking stick may be an acceptable choice for moderate treks. Telescoping trekking poles are the most versatile choice. They work well for hiking and trekking on rough terrain.



*Black Diamond, 2005, Gear, Copyright 2006 by Black Diamond Equipment Ltd.  
Retrieved April 12, 2007, from [http://www.bdel.com/gear/fixe\\_length\\_ski.php](http://www.bdel.com/gear/fixe_length_ski.php)*

Figure 16-4-6 Ski Pole



*Wintergoodies.com, 2007, Hiking, Trekking & Walking Pole Adjustable, Copyright 2007 by Wintergoodies.com.  
Retrieved April 12, 2007, from [http://www.winterbrookgoodies.com/pd\\_swissgear\\_hiking\\_trekking\\_walking\\_pole.cfm](http://www.winterbrookgoodies.com/pd_swissgear_hiking_trekking_walking_pole.cfm)*

Figure 16-4-7 Telescoping Trekking Pole





*The Walking Stick, 2005, Hiking Poles & Walking Sticks & Staffs, Copyright 2005 by The Walking Stick. Retrieved April 12, 2007, from <http://www.backpacking.net/walkstik.html>*

Figure 16-4-8 Wooden Walking Stick

### Criteria for Choosing Trekking Poles

To find the right trekking poles or walking stick, one needs to consider the type of activities for which they will be used, the type of terrain and the weight one will carry.



Aluminum telescoping poles are the best option. They are affordable and will last longer.

**Telescopic Adjustment.** Poles with telescopic adjustment may be adjusted to be longer or shorter depending on the type of terrain. Multiple people can use the same set of poles by adjusting the length. The poles are easy to store when not in use.

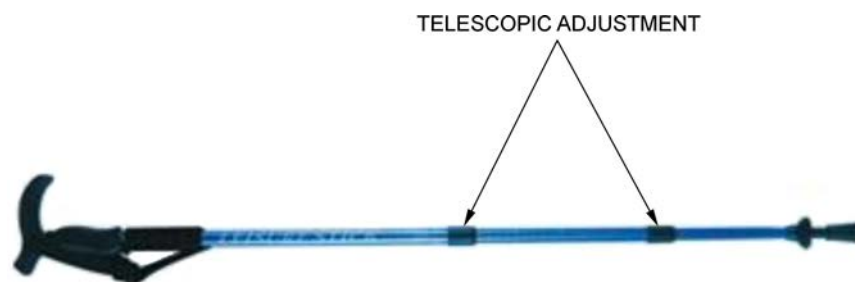

*Alibaba.com, 2007, Trekking Poles, Copyright 2007 by Alibaba.com Corporation and Licensors. Retrieved April 17, 2007, from [http://aoqida.en.alibaba.com/product/50252655/51316862/Trekking\\_Poles/Trekking\\_Pole.html](http://aoqida.en.alibaba.com/product/50252655/51316862/Trekking_Poles/Trekking_Pole.html)*

Figure 16-4-9 Telescoping Pole

**Grips.** Grips that have been shaped to fit the hand are more comfortable to grasp and easier to use over a long period of time. Grips that are hard can get wet with sweat and be uncomfortable to hold. One should try

multiple models to find the one that fits the hand the best. An adjustable strap should be attached to the grip to prevent dropping the pole.



*Moontrail, Backcountry Equipment Ltd, 2006, MSR Denali II, Telescoping Trekking Poles, Copyright 2006 by Backcountry Equipment, Ltd. Retrieved April 17, 2007, from <http://moontrail.com/msr-denali2.php>*

Figure 16-4-10 Grip With Strap

**Anti-Shock System (Shock Absorption).** The anti-shock system is built into the pole. Some systems are very complex and offer a range of settings depending on the user's preferences and the conditions of the trek. The anti-shock system helps absorb the impact of the pole striking the ground as one walks, easing the strain on the shoulders and arms. A lock system is a must as it allows the user to ensure the settings are locked and will not change during the hike.

**Baskets.** Baskets are the round rings at the bottom of trekking poles. The basket stops the poles from sinking into the surface (snow, mud or waterlogged ground). There are a variety of baskets. Baskets that are cut out like snowflakes are best used in the snow. Large, solid baskets are best used on soft muddy ground as they prevent sinking. If one is planning to buy trekking poles with baskets, ensure the baskets can easily be changed.



*Backcountry Edge, 2004, LEKI Snowflake Baskets, Copyright 2004 by Backcountry Edge, Inc. Retrieved April 17, 2007, from [http://www.backcountryedge.com/products/leki/snowflake\\_baskets.aspx](http://www.backcountryedge.com/products/leki/snowflake_baskets.aspx)*

Figure 16-4-11 Snowflake Baskets



*Backcountrygear.com, 2007, Black Diamond Trekking Pole Spare Baskets. Retrieved April 17, 2007, from <http://www.backcountrygear.com/catalog/accessdetail.cfm/BD320>*

Figure 16-4-12 Solid Baskets

**Tips.** There are three types of tips – single point, chiselled and rubber tipped. Each of these tips will work well in a certain environment. The best overall tip is the chiselled. It looks like notches have been cut out of the very tip of the pole, leaving several points sticking out. This type of tip offers traction in almost any condition and is durable.



*GoSki-Real Resort Info, 2005, Poles and Trekking Poles, Copyright 2005 by RSN. Retrieved April 17, 2007, from [http://www.goski.com/gear/product/LifeLink\\_Replaceable\\_Flex\\_Tip\\_Pair.html](http://www.goski.com/gear/product/LifeLink_Replaceable_Flex_Tip_Pair.html)*

Figure 16-4-13 Replaceable Tips

## METHODS OF USE

Using trekking poles may help prevent aches and pains. Poles are useful to help stabilize heavy loads and to negotiate trails. Besides providing better balance, trekking poles reduce the amount of stress on the back, legs and especially the knees. The poles absorb some of the impact the body would have to endure.



As the explanation is given, demonstrate the different techniques for holding trekking poles.

**Trekking Uphill.** When walking on even terrain, arms should be parallel to the ground when holding the grip. When trekking uphill, shorten the trekking poles for comfort and stability. This allows one to gain more power.



*TrekkingPoles.com, 2006, How to Use Trekking Poles, Copyright 2006 by NicheRetail, LLC Company.  
Retrieved April 26, 2007, from [http://www.trekkingpoles.com/custserv/custserv.jsp?pageName=How\\_To\\_Use](http://www.trekkingpoles.com/custserv/custserv.jsp?pageName=How_To_Use)*

Figure 16-4-14 Trekking Uphill

**Trekking Downhill.** Trekking poles will help reduce the shock of each footfall on the joints when going downhill. For comfort and stability it is recommended that the poles be lengthened.



*TrekkingPoles.com, 2006, How to Use Trekking Poles, Copyright 2006 by NicheRetail, LLC Company.  
Retrieved April 26, 2007, from [http://www.trekkingpoles.com/custserv/custserv.jsp?pageName=How\\_To\\_Use](http://www.trekkingpoles.com/custserv/custserv.jsp?pageName=How_To_Use)*

Figure 16-4-15 Trekking Downhill

The following may help while descending on rocky terrain:

- Walk slowly and test each rock before placing body weight on it.
- Lean forward to place body weight on the trekking poles.
- Grip the trekking pole securely.
- Keep the arms bent at 90 degrees.
- When possible, move one pole forward and step through with the opposite leg.

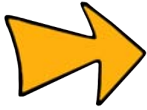

Trekking poles can also be used to:

- probe the depth of puddles or the strength of snow bridges;
- ward off aggressive animals; and
- provide support for a camera.

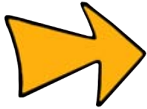

Some people like to have one hand free and only use one pole. For a greater level of support, two is better.

A solid wooden walking stick can be picked up in nature at any time during an expedition.

## PERSONAL HIKING RHYTHM

An average day of hiking will consist of periods of hiking and periods of rest. The combination of a good hiking rhythm, a good hiking speed, and fixed rest intervals separate beginners from experienced hikers. Enthusiasm often tends to cause one to start too fast, get tired quickly, take an early rest, and start off too fast again.

### Stride Rhythm and Speed

A steady hiking rhythm is generally more enjoyable as one over exerts themselves less and generally keep the physical strain at comfortable levels. Having a steady rhythm will enable a hiker to stick to a fixed schedule and lessen the strain put on the body. This allows a hiker to travel less fatigued.

**Developing a Hiking Rhythm.** A hiking rhythm is very personal and is developed over the course of many hikes. To develop a rhythm there are some guidelines to follow:

- Choose a specific stride rhythm and speed and keep to it. A good rhythm is one that allows a hiker to hike at the same intensity level for at least one hour without having to take a break.
- Adjust rhythm to terrain, weather and weight. The point where a person can no longer carry on a conversation indicates the hiker has gone beyond a comfortable tempo.
- Make the rhythm a full body movement where breathing and swinging of the arms happen in harmony.
- Uneven surfaces like uphill and downhill slopes of varying incline can make it difficult to maintain a steady hiking rhythm.

### Controlling Fatigue

The purpose of resting is to slow down the heart rate and breathing, thereby allowing the heart and lungs to rest. Resting gives the body time to get rid of the lactic acids built up in muscles, and to recover from hot spots or sores.

Resting guidelines:

- Rest in regular intervals; try 10 minutes for every hour hiked (make them part of the rhythm).
- Stick to 10-minute rest breaks. Use only lunch and dinner (supper) breaks as extended rest periods.
- 10 minutes is the most effective rest duration for body recovery.
- Ensure to take off backpacks, rest in the shade, and sit down during rests.
- During the extended rest breaks, allow feet to rest and dry by removing shoes, and airing out footwear.

## Adjusting Rhythm

Generally, hiking rhythm on a flat surface can be maintained easily; however, when weather and additional weight are included, hiking becomes more difficult. How fast one travels depends on the fitness level of the entire group, the terrain, the altitude and pack weight. One of the best ways to measure and regulate pace is to pay close attention to the tempo of breathing.

If breathing determines pace then, for example, on level ground one takes three steps per inhalation, and three steps per exhalation. Climbing a hill, while maintaining the same breathing rate, the steps per inhalation fall to two. A good rule of thumb to follow is to walk at a pace where one can still carry on a conversation.

When travelling in different conditions one's pace will change, according to:

- **Weather.** Poor weather will reduce pace and force the hiker to reduce step size for safety.
- **Weight.** Weight will affect pace size as the more weight one carries, the more energy must be expelled.
- **Terrain.** Travelling uphill will reduce pace size and distance travelled.

## Full Body Synchronization

Hiking rhythm is a full body affair. Just like marching, hiking requires coordinated movements where every action has a reaction. The swinging of arms provides momentum, breathing controls pace, etc. To properly control rhythm, one must first learn what body parts work in unison. To employ full body synchronization during movement, the arms should be in motion at a natural swing, opposite the forward foot.

## Resting Intervals

An average day of hiking consists of periods of hiking and resting. Resting intervals should occur once every hour, for a duration of 10 minutes, in an area that is conveniently shaded and possibly near a water source. During the first five to seven minutes of resting, the body flushes out about 30 percent of the lactic acid buildup in the muscles, but only five percent in the next 15 minutes (be cautious rest does not extend beyond 10 minutes).

In addition to lactic acid buildup in the muscles, the body works in unison and other areas may become fatigued. By resting:

- the heart rate slows and beats at a reduced rate,
- the lungs supply less oxygen to the body,
- the body and mind rest, and
- feet and footwear can be aired out, reducing the chance of blisters.

## The Rest Step

When trekking, sometimes a hill is so steep that it simply cannot be climbed without taking breaks. In these cases, the rest step can be used. The rest step is also good when hiking in snow and fog.

To employ the rest step:

1. Begin from an upright position. Step forward with the right leg, keeping the weight on the left (back) leg, with the knee locked. Pause before taking the next step, with the weight still on the back leg.
2. Transfer the weight to the right leg. Push up with the right leg and take a step forward with the left leg. Lock the right knee, so that the right leg is bearing all the body weight. Pause before taking the next step, with the weight still on the back leg.



3. Transfer the weight to the left leg. Push up with the left leg and take a step forward with the right leg. Pause before taking the next step, with the weight still on the back leg. Continue moving, walking at a slow and steady pace.



STEP 1



STEP 2



STEP 3

*K. Berger, Backpacking and Hiking, DK Publishing Inc. (p. 143)*

Figure 16-4-16 Rest Step

### CLASS 3 TERRAIN HIKING TECHNIQUES

#### Scrambling

Scrambling is a term used to describe making one's way over rough, uneven terrain and rocks by climbing or crawling. Scrambling usually requires the use of both hands and feet.

The following should be considered when using the scrambling technique:

- Test handholds and footholds before committing body weight.
- Keep the lower body close to the rocks.
- Use the hands to help maintain balance.
- Use large muscles in the legs to support body weight.
- Always maintain three points of contact with the rocks.



*Talisman Newsletter, 2006, Merry Christmas, Copyright 2007 by Talisman Mountaineering Activities Scotland.  
Retrieved April 17, 2007, from <http://www.talisman-activities.co.uk/downloads/newsletters/newsletter4/newsletter4.htm>*

Figure 16-4-17 Scrambling Technique

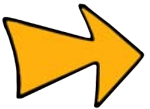

When scrambling and facing difficulty, take a moment to catch your breath. Study your route options and always identify a way back.

### **Boulder Hopping**

Boulder hopping is when one uses speed and momentum to lightly hop from boulder to boulder, using arms or trekking poles to for balance.

The following should be considered when boulder hopping:

- Plan your route. Larger boulders are more stable.
- Use hands for stability.
- Keep knees bent and relaxed.
- Control speed. Lightly hop.
- If one begins to lose balance, move forward, stepping lightly from foot to foot until balance is regained.





*Great Outdoor, 2006, Hiking the Forgotten End of the AT, Copyright 2006 by Greatoutdoor.com. Retrieved April 12, 2007, from <http://www.greatoutdoors.com/go/photos.jsp?title=hikingtheforgottenendoftheat&imag=1>*

Figure 16-4-18 Boulder Hopping With Trekking Poles

### Scree Crossing

A scree is a mass of fine, small rocks that are often found above the tree line on mountain slopes. When dealing with a scree, caution is the first rule.



*East Riding of Yorkshire Council, E Riding Media Library-England North, Copyright 2007 by School Improvement Service, East Riding of Yorkshire Council. Retrieved April 17, 2007, from [http://www.eriding.net/media/england\\_north.shtml](http://www.eriding.net/media/england_north.shtml)*

Figure 16-4-19 Scree

### Traversing a Scree

Traversing means walking obliquely or crossing in a sideways movement.

Walking on a scree may be very slippery. When traversing a scree, a planned zig-zag path is the best option. The route should be broken down in small sections. One should keep the pace controlled and remember that speed can only mean greater risk of injury.

**Walking Sideways.** Walking sideways will provide more contact between the long side of the foot and the slope to give better stability.

### **Climbing a Scree**

One should avoid climbing a scree, if possible as it can be very exhausting. If there is no other option, the following tips should be considered:

- Keep to the sides of the scree. The movement of the scree is slower and larger boulders can be found there.
- Aim to keep feet horizontal. If the scree is small enough, kick the toes into the slope (like in snow).
- Climbing with the feet spread-eagled will help put weight on the instep of each boot.
- Take small steps to reduce the strain on the legs. This also reduces the chances of slipping.
- Legs should be bent at the knee to support the body.

### **Descending a Scree**

When descending a scree, one should keep the weight on the heels and take short steps. One's back should be straight and the knees should be slightly bent to absorb stress and improve balance.

The following should be considered when descending a scree:

- Dig the heels into the slope.
- Use the hands to stay steady.
- Relax the knees and keep moving.

## **CROSSING WATER OBSTACLES**

### **Rivers**

Crossing rivers can be very challenging depending on the time of the year (eg, spring when snow melts into streams and rivers). A plan should be established before crossing a river.

**Choose a Place to Cross.** The safest place to cross is where the water is calm and no deeper than the height of one's hips. Such conditions can be found around rivers bends, where the stream widens and slows to make the turn. The darker (and greener) the water, the deeper it is.

The following should be avoided:

- turbulence that causes white water;
- dark water; and
- a powerful current.

If conditions appear dangerous, walk upstream in search of a safer option. Always cross with caution.

**Best Time to Cross.** Early in the morning is the best time to cross. Rivers run slower in the morning because the water is colder at night.

**Wading Across a River.** Wading across a river is the safest option. When crossing, always face upstream, diagonal to the current.

If crossing in a group, link arms, with the strongest people at the end. The group should move slowly in a line, diagonal to the current.

Trekking poles can be used to wade across a river. They will help with the balance.

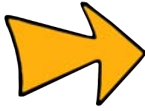

When crossing a river, to keep boots dry, take them off and wear sport sandals. If one does not have sport sandals, remove socks and boot liners, put boots back on and cross the river.

**Hopping.** Hopping is a technique used with rocks and will help one cross a river and stay dry. The following should be considered when hopping:

- Plan the route. Evaluate the steps to take.
- Decide which rocks are stable.
- Test steps before committing.
- If a step is unstable, move quickly to the next one.

Stepping in the water is an option. It is better to step into the water and get wet feet than to fall into it.

**Crossing Rivers Using a Wooden Bridge or Ropes.** Wooden bridges range from constructed bridges to logs placed across a stream. Always test a bridge first to see if it is fixed and stable. Crossing a log should be done one person at a time since weight can dislodge the log. If a bridge or a log is too narrow, unstable or high, shuffle across in a sitting position.



Unless trained in river rescue, hand-held rope should not be used. If a rope is fixed in place, it can be used to hold on to. Avoid getting tangled in the rope. Carabiners shall not be used to attach a person to the rope.

### Waterlogged Ground

Avoid crossing waterlogged ground if possible. If there is no other way around, one should plan a route through it. Footsteps of previous trekkers can tell how deep and hard the soil is.

**Natural Hard Spots.** When planning a route, aiming for hard spots in the ground can save time. Trees and shrubs might indicate a solid piece of ground. Large rocks and clumps of hard grass are also good indicators.

**Trails.** Sometimes, trails go across waterlogged ground. Frequently used trails will often have small wooden pathways (looking like short bridges) built to help facilitate the crossing. Bridges made of fallen logs may also be used.



When crossing waterlogged grounds, boots should be tightly laced. Suction of mud may pull at the boots.

### Crossing Snow and Ice

**Reading the Snow for a Safe Route.** When planning a route, it is best to avoid rocky places. Rocks absorb heat causing the snow near them to melt faster. The soft snow may not be firm enough to hold someone's weight. Before using a path, test the snow with trekking poles to prevent injuries. It is best to cross a large snowfield early in the morning when the snow is harder. As the sun rises and becomes more powerful, snow melts unevenly and creates soft spots.

**Ascending on Snow.** When walking on snow, the conditions will govern the route. A new route may be created to ascend safely. Zig-zags may also be an option. If it is easier to go straight up, one should kick the snow several times to make solid steps to stand on. Before standing on these steps, one should always test body weight.



Trekking uphill through snow can be very exhausting. It is recommended to plan twice as much time to complete this kind of trek. Take breaks as required.

**Crossing Ice.** Crossing ice requires caution. When crossing ice, one should use trekking poles to probe for holes or test the snow. On ice, do not rely on old footsteps. The route may not be safe if they are a few days old. Always test before advancing.



Ice is thinner in early winter and spring. During these seasons, one should try to go around.

---

### Teaching Point 1

### Participate in Hiking Familiarization

Time: 160 min

Method: Practical Activity

---

## ACTIVITY

---

### OBJECTIVE

The objective of this activity is for the cadet to hike along a route that contains some Class 3 terrain, using the “rest step” principle and employing obstacle-crossing techniques as required.

### RESOURCES

- Hiking equipment, to include:
  - Hiking boots (one pair per cadet),
  - Day pack (one per cadet),
  - Water carrier (one per cadet), and
  - trekking poles (one pole per cadet);
- Topographical/trail map of the area (two per team/group),
- Compass (one per team/group),
- Whistle (one per cadet),
- Communication device (two per team/group),
- GPS Receiver (one per team/group),
- Batteries (spares for hand-held radio and GPS), and
- First aid kit (one per team/group).

## ACTIVITY LAYOUT

Designated hiking route with some Class 3 terrain.

## ACTIVITY INSTRUCTIONS



Due to differences in geographic location, resources, and environment it may not be possible to cover all TPs in this lesson while travelling along the predetermined hiking route. It is suggested that a review of theoretical concepts takes place prior to departing. This should be completed as a discussion with the cadets, using leading questions to aid in the identification of the key concepts. During the hike, re-establish these points through practical examples, such as pointing out when the cadets are travelling on easy terrain versus moderate terrain. The TPs are organized into two main headings – pre-departure and during—but it should be understood that concepts discussed in the pre-departure section will be revisited during the hike.

1. Conduct pre-departure training, reviewing the following concepts through discussion:
  - (a) the difference between hiking, trekking and backpacking,
  - (b) personal clothing and equipment for hiking,
  - (c) terrain, including:
    - (1) the Yosemite Decimal System (YDS), and
    - (2) types of terrain, including:
      - (a) easy,
      - (b) moderate, and
      - (c) difficult; and
  - (d) trekking poles, including:
    - (1) types of poles and sticks, and
    - (2) criteria for choosing trekking poles.
2. Conduct a pre-hike briefing, to include:
  - (a) clothing/equipment requirements,
  - (b) trail etiquette,
  - (c) daily water requirements,
  - (d) rest intervals, and
  - (e) route overview.
3. Assign cadets the following positions and provide them with required equipment (positions will change throughout the route):
  - (a) navigator (topographical/trail map of area, compass),
  - (b) first-aider (first aid kit), and

- (c) radio operator (hand-held radio, spare batteries).
4. Have cadets retrieve their day packs and trekking poles and prepare to move.
5. Depart on the predetermined hiking familiarization route, incorporating the remaining TPs, where applicable, into teachable moments and breaks throughout the route, to include:
  - (a) methods of using trekking poles while hiking;
  - (b) personal hiking rhythm, including:
    - (1) stride rhythm and speed,
    - (2) controlling fatigue,
    - (3) adjusting rhythm,
    - (4) full body synchronization,
    - (5) resting intervals, and
    - (6) the rest step;
  - (c) Class 3 terrain hiking techniques, including:
    - (1) scrambling;
    - (2) boulder hopping; and
    - (3) scree crossing, to include:
      - (a) traversing a scree,
      - (b) climbing a scree, and
      - (c) descending a scree; and
  - (d) crossing water obstacles, including:
    - (1) rivers,
    - (2) waterlogged ground, and
    - (3) snow and ice.
6. Upon arrival at the end point, debrief the cadets and have them return equipment.

#### **SAFETY**

- The cadets will respect the predetermined boundaries for this activity.
- Teams/groups will travel in single file.
- Teams/groups will not pass another teams/groups unless directed to do so by their team instructor.
- All the cadets must have at least 500 mL (16 oz) of water.
- A water supply will be available along the route.

---

#### **CONFIRMATION OF TEACHING POINT 1**

---

The cadets' participation in the activity will serve as the confirmation of this TP.

---

## END OF LESSON CONFIRMATION

---

The cadets' participation in the practical expedition activity will serve as the confirmation of this lesson.

---

## CONCLUSION

---

### HOMework/READING/PRACTICE

N/A.

### METHOD OF EVALUATION

This EO is assessed IAW A-CR-CCP-703/PG-001, Chapter 3, Annex B, Appendix 7 (326 PC).

### CLOSING STATEMENT

Hiking is one of three dynamic modes of transport that can be used during expedition training. It is critical that the cadets are given the opportunity to hike on routes which include some Class 3 terrain to prepare them for more advanced expedition experiences. Being aware of pacing and implementing the "rest step" while hiking will ensure a more enjoyable hiking experience for the individual and the team/group. When travelling on advanced hiking terrain, the possibility of encountering obstacles is quite great, therefore it is important that all members understand how to safely cross them.

### INSTRUCTOR NOTES/REMARKS

Expedition centres are required to select two dynamic modes of travel from EO M326.02a (Paddle a Canoe, Section 2), EO M326.02b (Ride a Mountain Bike, Section 3), and EO M326.02c (Hike Along a Route) to incorporate into their weekend training.

This EO has been allocated six periods in the overall course period allocation. Each expedition centre may adjust this allocation to reflect the choice of activities, facilities and available resources at the expedition centre.

Timings for this EO will vary. While there is a requirement for some initial training, the focus should be on having the cadets practice hiking techniques through practical application.

Upon arrival at the expedition centre cadets will be broken into teams/groups. These teams/groups will remain the same for the duration of the weekend.

---

## REFERENCES

---

- |        |   |
|--------|---|
| A2-001 | A-CR-CCP-951/PT-002 Director Cadets 3. (2006). <i>Royal Canadian Army Cadets Adventure Training Safety Standards</i> . Ottawa, ON: Department of National Defence.      |
| C2-016 | (ISBN 1-4000-5309-9) Curtis, R. (2005). <i>The Backpacker's Field Manual: A Comprehensive Guide to Mastering Backcountry Skills</i> . New York, NY: Three Rivers Press. |
| C2-042 | (ISBN 0-7566-0946-1) Berger, K. (2005). <i>Backpacking &amp; Hiking</i> . New York, NY: DK Publishing, Inc.   |
| C2-051 | (ISBN 978-0-7153-2254-3) Bagshaw, C. (Ed.). (2006). <i>The Ultimate Hiking Skills Manual</i> . Cincinnati, OH: David & Charles.   |
| C2-103 | (ISBN 0-89886-427-5) Graydon, D., & Hanson, K. (Eds.). (2001). <i>Mountaineering: The Freedom of the Hills</i> (6 <sup>th</sup> ed.). Seattle, WA: The Mountaineers.    |

THIS PAGE INTENTIONALLY LEFT BLANK





**ROYAL CANADIAN ARMY CADETS**  
**SILVER STAR**  
**INSTRUCTIONAL GUIDE**



**SECTION 5**

**EO M326.03 – PRACTICE ENVIRONMENTAL STEWARDSHIP AS A TEAM LEADER**

---

Total Time: 30 min

---

**PREPARATION**

---

**PRE-LESSON INSTRUCTIONS**

Resources needed for the delivery of this lesson are listed in the lesson specification located in A-CR-CCP-703/PG-001, Chapter 4. Specific uses for said resources are identified throughout the instructional guide within the TP for which they are required.

Review the lesson content and become familiar with the material prior to delivering the lesson.

**PRE-LESSON ASSIGNMENT**

N/A.

**APPROACH**

A group discussion was chosen for TP 1 as it allows the cadets to interact with their peers and share their experiences, opinions, and feelings about Leave No Trace principles. A group discussion also helps the cadets improve their listening skills and develop as members of a team.

An interactive lecture was chosen for TPs 2 and 3 to give an introduction and overview of current land management issues in Canada and generate interest in adhering to Leave No Trace principles.

---

**INTRODUCTION**

---

**REVIEW**

N/A

**OBJECTIVES**

By the end of this lesson the cadet shall be expected to practice environmental stewardship as a team leader.

**IMPORTANCE**

It is important for cadets to understand environmental stewardship as it relates to ecological sustainability and Leave No Trace camping. Environmental management is constantly changing and knowing what is acceptable will assist the cadet in making good leadership decisions.

**Teaching Point 1****Review the Principles of Leave No Trace Camping**

Time: 5 min

Method: Group Discussion

**BACKGROUND KNOWLEDGE**

The point of the group discussion is to draw the principles of Leave No Trace camping from the group using the tips for answering/facilitating discussion and the suggested questions provided.

**PRINCIPLES OF LEAVE NO TRACE CAMPING****Plan Ahead and Prepare**

Plan ahead by considering your goals and expectations. Taking steps in advance of the trip will allow for minimum impact on the trail. Some points to help prepare include:

- **Knowing the Regulations and Special Concerns for the Areas Visited.** Taking the time to research specific locations will aid the group in packing and preparation.
- **Preparing for Extreme Weather, Hazards and Emergencies.** Information concerning weather, possible hazards, and emergencies should never be assumed or the importance underestimated. Check with weather forecasting services and research the location's seasonal weather history for any clues to weather that may be expected. Always plan for the worst weather expected, and be prepared for any emergency.
- **Carefully Planning Meals and Repackaging Food to Minimize Waste.** Reducing the amount of food you carry by carefully planning meals and repackaging food, reduces the amount of garbage produced. Eliminating trash removes the possibility of accidentally leaving waste behind.

**Camp and Travel on Durable Surfaces**

Trampled vegetation and eroded trails last for years, or even a lifetime. Walk and set tents on surfaces that endure (eg, rock, sand, gravel, dry grasses and snow). Adhere to the following guidelines:

- **Concentrate the Trek on Existing Trails and Campsites.** In popular areas, focus the trek where it is obvious that other visitors have already left an impact. Travelling on areas already worn will reduce the overall impact on the environment in the long term.
- **Walk in Single File in the Middle of the Trail, Even When Wet or Muddy.** Trails travelled frequently will show signs of wear. Maintaining travel in the centre of the path will reduce wear spreading to the edges of the trail.
- **Avoid Taking Shortcuts Away From Established Trails.** Taking shortcuts around routes or obstacles may be time saving however, the effect on the vegetation and environment is damaging. Avoid this whenever possible.
- **Travel on Rock, Gravel, Dry Grasses or Snow.** These surfaces are durable and can withstand the pressure of human travel. In pristine areas with no noticeable impact, groups should not walk in single file, but should disperse and travel separate routes.
- **Camp 100 m (300 Feet) From Lakes and Streams.** Ground water and water from lakes and streams have the potential to be spoiled by increased human contact. By camping a minimum distance of 100 m (300 feet) from these water sources, cadets can do their part to limit the impact on the area's ecosystem.

## Dispose of Waste Properly

**Pack it In, Pack it Out.** Inspect the campsite and rest areas for trash or spilled foods. Pack out all trash, leftover food and litter.

**Disposing of Human Waste.** Dispose of all human waste in catholes dug 16–20 cm (6–8 inches) deep and at least 60 m (200 feet) from water sources, camps, and trails. Cover and disguise the cathole when finished. Be sure to follow any additional direction provided by the owner or manager of the area you are training in, and adhere to any regional directives that may be in place.

**Pack Out Toilet Paper and Hygiene Projects.** Soiled toilet paper and feminine products will take a considerable amount of time to decompose, especially if the trek involves many participants. Be sure to employ a suitable disposal plan.

**Washing the Body or Dishes.** Carry water 60 m (200 feet) away from streams or lakes and use small amounts of biodegradable soap. Scatter strained dishwater.

## Leave What You Find

While trekking there will be many wonderful structures, intriguing objects, and items one will find interesting. Items of such nature shall be left alone for others to cherish.

Some guidelines to follow include:

- **Preserving the Past.** Leave all cultural or historical structures and artifacts untouched for all to enjoy.
- **Leave Flora and Fauna.** Plants, rocks, and animals shall be left alone and undisturbed.
- **Avoid the Construction of Structures.** While in the field, common practice is to invent or construct structures and furniture or dig trenches to make living easier, however, these actions leave a noticeable, unnatural indication of human presence in the environment. If structures are created out of necessity, once finished return the environment to its original appearance.

## Minimize Campfire Impacts

Traditional open fires destroy the landscape, and can be avoided by using lightweight stoves. If fires are acceptable, build minimum impact fires using an existing fire ring, pan or fire mound. Only dead and downed wood, no bigger than an adult's wrist, should be used. Maintain a small fire by burning all the wood down to ash then, saturating the ash with water and scattering the ash broadly. There should be little to no evidence of a fire.

## Respect Wildlife

Animals in their natural environment are not used to humans. Although some wild animals adapt to human presence, others flee, sometimes abandoning their young and their preferred habitat. As guests in the environment, and as expeditionists, we need to respect wildlife by observing these simple guidelines:

- Observe wildlife from a distance.
- Never feed the animals.
- Protect wildlife and food by storing rations and trash securely.
- Control pets.
- Avoid wildlife during sensitive times (eg, mating, nesting, when raising young, or during the winter).

## Be Considerate of Other Visitors

While trekking, one will likely encounter other travellers. Be sure to respect others and afford common courtesies, such as:

- respecting visitors to protect the quality of their experience;
- yielding to others on the trail;
- camping away from trails and other visitors; and
- allowing nature's sounds to prevail.

---

## GROUP DISCUSSION

---



### TIPS FOR ANSWERING/FACILITATING DISCUSSION

- Establish ground rules for discussion, eg, everyone should listen respectfully; don't interrupt; only one person speaks at a time; no one's ideas should be made fun of; you can disagree with ideas but not with the person; try to understand others as much as you hope they understand you; etc.
- Sit the group in a circle, making sure all cadets can be seen by everyone else.
- Ask questions that will provoke thought; in other words avoid questions with yes or no answers.
- Manage time by ensuring the cadets stay on topic.
- Listen and respond in a way that indicates you have heard and understood the cadet. This can be done by paraphrasing their ideas.
- Give the cadets time to respond to your questions.
- Ensure every cadet has an opportunity to participate. One option is to go around the group and have each cadet answer the question with a short answer. Cadets must also have the option to pass if they wish.
- Additional questions should be prepared ahead of time.

### SUGGESTED QUESTIONS

- Q1. What are the seven principles of Leave No Trace camping?
- Q2. When in the wilderness, squirrels are often present around the campsite. How much food should you spare to feed the animals?
- Q3. When preparing for a trek, what should one check to determine what clothing will be required for the trip?
- Q4. Where should campfires be made?
- Q5. What action should be taken with respect to other campers?



Other questions and answers will develop throughout the group discussion. The group discussion should not be limited to only those suggested.



Reinforce those answers given and comments made during the group discussion, ensuring the teaching point has been covered.

---

### CONFIRMATION OF TEACHING POINT 1

---

The cadet's participation in the group discussion will serve as the confirmation of this TP.

#### Teaching Point 2

#### Discuss Land Management Issues in Canada

Time: 5 min

Method: Interactive Lecture



This TP is designed to give cadets an introduction to land management issues in Canada that can affect expeditions. In addition, this information will allow cadets to be knowledgeable about current environmental issues.

### SUSTAINABLE FORESTRY

Sustainable forestry is meeting society's increasing demands for forest products while respecting the values of society and preserving forest health.

Forests in Canada are almost 15 000 years old, but, without sustainable forestry they may not be around for another 15 000 years. Over the last decade, forest concerns have been raised by public interest groups, Aboriginal peoples, and concerned citizens. Concerns include clear cutting, using pesticides and managing the forest for wildlife, cultural values, recreation and park management, and fresh water.

#### Why is it Important for Canada to Have Sustainable Forestry Standards?

Ensuring the sustainability of the resource and the long term protection of forest ecosystems and maintaining employment in the forestry sector are all critical to Canada's competition in international markets. The forestry industry is Canada's largest industrial employer, with over 339 900 Canadians directly employed in the industry.

Sustainable forests are a source of well-being socially, environmentally and economically. Canada is home to approximately 30 percent of the world's boreal forest. There are 180 indigenous species of trees in our forests that provide habitat for 70 species of mammals and 300 species of birds.

Within the 30 percent, 294.8 million hectares are available for commercial use. 143.7 million hectares of commercially available forest are actively managed. Most of Canada's forests are publicly owned (93 percent) of which 77 percent are under provincial jurisdiction.

It is important to note that before any forestry take place, a forest management plan must be prepared.

**Forest Management Plan.** A plan developed by industry leaders, professional foresters and local citizens that follows the Forest Management Planning Manual. The plan includes determining available harvest areas and assessing criteria and indicators of sustainability.

Forestry companies manage crown forests under licences that are known as sustainable forest licences (SFLs). SFLs are valid for 20 years but must be renewed every five years to show compliance to regulations as well as public audit. If a company does not meet the standard, the licence is not renewed.

Stumpage fees are charges to companies for the right to harvest timber. Stumpage fees are based on the number of trees harvested.

Canada is committed to and is a world leader in sustainable forest management. As of 2006, Canada had the largest number of independently certified forests.

**Independently Certified Forests.** Forests that have been certified by an independent third party to be managed using sustainable methods.

## **WASTE MANAGEMENT**

Waste management has changed drastically with recycling becoming a large part of waste reduction. Waste management is the responsibility of all levels of government. Provincial governments are responsible for licensing hazardous waste generators, carriers and treatment facilities.

Most waste management is contracted to private companies.

In field and wilderness settings, waste management is conducted by area residents, park staff or a private management company.

Carrying out what was carried in is crucial to waste management in wilderness areas. Bringing garbage back home, or back to the training centre where adequate disposal measures are in place assists in keeping wilderness areas clean.

## **WATER CONSERVATION**

Nearly three quarters of the earth is water. Ninety-nine point six percent of all fresh water is frozen in glaciers and ice fields, or located deep underground. Within our land mass, Canada holds about seven percent of the world's renewable fresh water.

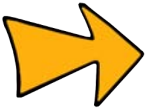

Canada holds 20 percent of the world's fresh water, but only seven percent is renewable.

Canadians rely on this seven percent of fresh water for drinking water, agriculture, recreation, industry and ecosystems. Managing this vast resource is the responsibility of all levels of government. Water conservation and management is an important issue within Canada that many people take for granted.

### **Why is Water Conservation so Important?**

Although Canada has the largest supply of fresh water, it is diminishing. Demand for water is higher, pollution has increased within water supplies, water tables have declined, and prolonged warm weather has caused drought conditions more frequently. These factors are shrinking the usable water supply.

Water is used for cooking food, bathing, doing laundry and drinking. When we are done with the water, it is usually returned to the same body of water it came from, usually in a worse condition.

### **What Do we Mean by Water Conservation?**

Water conservation means wasting less water, using water more efficiently, and not misusing water.

### **Using Water in the Wilderness**

When in the wilderness, collecting water from rivers, streams and lakes should be done with care.

Bathing in lakes will contaminate water. Using soap when washing is especially detrimental to the water as chemicals and bacteria not found naturally are being added. Even soaps that claim to be biodegradable are harmful to the water.

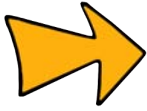

One drop of oil can render up to 25 L of water unfit for drinking.

The increase in Canada's population leads to an increased demand for water. More chemicals and bacteriological pollutants are found in the water supply. Waterborne diseases found in municipal water have prompted awareness and action by organizations across the country. This, combined with a depleting water table, means that maintaining a stable clean water supply has never been more important.

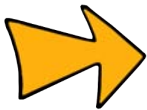

Only about one percent of the water in the Great Lakes is renewed each year through rainfall and snowmelt.

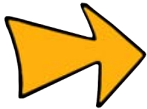

The entire population of Prince Edward Island and over 60 percent of the population of New Brunswick and the Yukon rely on groundwater to meet their domestic needs.

## ECOSYSTEM MANAGEMENT



**Ecosystem.** A self-regulating association of living plants, animals, and their non-living physical and chemical environment.

The sphere of life and organic activity extends from the ocean floor to approximately 8 km (5 miles) into the atmosphere. Within this sphere are thousands of different ecosystems. In an ecosystem, a change in one component causes changes in others as all systems adjust to the new conditions. An ecosystem includes biotic (living) and abiotic (nonliving) components. All of the components function as a whole, therefore, the slightest change in an ecosystem can drastically change its health.

**Limiting factor.** Physical or chemical factor that inhibits (through a lack of, or an excess of) biotic processes.

Changes that can threaten the biodiversity of areas are:

- habitat loss and degradation,
- invasive alien species,
- pollution, and
- climate change.

The national Species at Risk Act was adopted in 2002, to work with existing laws to protect wildlife species and protect ecosystems. Designed to ensure action plans are prepared for the recovery of declining species, the Act applies to all federal lands. Most provinces also have Species at Risk legislation.

---

## CONFIRMATION OF TEACHING POINT 2

---

### QUESTIONS

- Q1. What does water conservation mean?
- Q2. Why is ecosystem management so important?
- Q3. What can threaten the biodiversity of an area?

### ANTICIPATED ANSWERS

- A1. Water conservation means wasting less water, using water more efficiently, and not misusing water.
- A2. Ecosystem management is so important because a change in one component causes changes in others as all systems adjust to the new conditions.
- A3. Threats to the biodiversity of an area are:
- habitat loss and degradation,
  - invasive alien species,
  - pollution, and
  - climate change.

---

### Teaching Point 3

### Identify Ways a Team Leader Can Implement Leave No Trace Principles

Time: 10 min

Method: Interactive Lecture

---



This TP is designed to motivate cadets to follow Leave No Trace principles.

Allow cadets to develop their own ideas and implement them on corps trips and exercises.

### LEAVE NO TRACE PRINCIPLES

#### Following Leave No Trace Principles Personally by Leading by Example

Cadets follow and do as their leaders do. Cadets watch everything and notice when leaders are doing things differently. Seeing their leaders following Leave No Trace principles allows other cadets to see the principles in action. Seeing the leader of the group apply the principles will cause the junior cadets to follow.

#### Designate a Leave No Trace Leader Within the Group

Before heading out on the hike, trip or expedition, designate a cadet as a Leave No Trace leader. The Leave No Trace leader ensures the group follows Leave No Trace principles throughout the activity.

Make the job fun! A button or badge can be attached to the person's pack to identify them.

#### Becoming a Leave No Trace Advocate

Being an advocate of Leave No Trace principles means following Leave No Trace at home and school as well. Use less water, take public transportation, walk to school, recycle, and compost.



Even those who do not enter the wilderness affect the places others enjoy by actions such as depleting the water table, contributing to air pollution, and living in large homes that need more heat than smaller ones.

### **Implementing Awards Systems for Those who Follow Leave No Trace principles**

Trail snacks, or treats as well as certificates (or even larger prizes) can be awarded to the cadets that follow Leave No Trace principles, or encourage others to follow the principles.

### **Sharing Leave No Trace Information With Others**

**Tell Stories, Don't Preach.** Lectures will invariably make the group lose focus. Do not lecture the group about littering or nag them when hiking. Make the point in a story about an experience, or a fictional tale. A story about a mother bear and her cubs living off garbage versus hunting for dinner will have more impact than lecturing the cadets.

**Teachable Moments.** Pointing out trail erosion or polluted water sources is better than teaching theoretically. Teach when opportunities present themselves.

**Show a Better Way.** Rather than telling cadets they are doing something wrong, show them the better way.

**Authority of the Resource.** Switch the authority from the platoon commander to the earth. Encourage people to change their behaviour based on their desire to help the environment rather than on a need to obey an authority figure.

## **ACTIVITY**

Time: 5 min

### **OBJECTIVE**

The objective of this activity is get the cadets to brainstorm implementing Leave No Trace principles.

### **RESOURCES**

N/A.

### **ACTIVITY LAYOUT**

N/A.

### **ACTIVITY INSTRUCTIONS**

1. Divide the cadets into two or three small groups.
2. Have the cadets brainstorm implementation of the principles listed in TP 1.
3. Have the cadets share their ideas with the entire group.

### **SAFETY**

N/A.

## **CONFIRMATION OF TEACHING POINT 3**

The cadets participation in the brainstorming session about implementing Leave No Trace principles will serve as the confirmation of this TP.

---

## END OF LESSON CONFIRMATION

---

### QUESTIONS

- Q1. Describe the second principle of Leave No Trace, camp and travel on durable surfaces.
- Q2. What is sustainable forestry?
- Q3. What does being a Leave No Trace advocate mean?

### ANTICIPATED ANSWERS

- A1. Trampled vegetation and eroded trails last for years, or even a lifetime. Walk and set tents on surfaces that endure (eg, rock, sand, gravel, dry grasses and snow).
- A2. Sustainable forestry is meeting society's increasing demands for forest products while respecting the values of society and preserving forest health.
- A3. Being a Leave No Trace advocate means following Leave No Trace principles at home and school as well. Use less water, take public transportation, walk to school, recycle, and compost.

---

## CONCLUSION

---

### HOMEWORK/READING/PRACTICE

N/A.

### METHOD OF EVALUATION

N/A.

### CLOSING STATEMENT

Understanding environmental stewardship and its practices will guide team leaders when in the wilderness to make proper stewardship decisions.

### INSTRUCTOR NOTES/REMARKS

This EO could be delivered by a local official or Ministry of Natural Resources representative.

If being delivered by a guest speaker, this EO may be tailored to the local area; however the human impact theme must remain. The guest speaker should present issues specific to area land management.

---

## REFERENCES

---

- C2-011 (ISBN 0-89886-910-2) McGivney, A. (2003). *Leave No Trace: A Guide to the New Wilderness Etiquette*. Seattle, WA: Mountaineers Books.
- C2-186 Ministry of Natural Resources of the Government of Ontario. (2002). *Today's Forests – Promoting Sustainability*. Retrieved March 25, 2008, from <http://onatrioforests.mnr.gov.on.ca/spectrasites/viewers/showArticle.cfm?objectid=551DC374-4876-4590-A4F564FD9E79093B&method=DISPLAYFULLBARNOTITLEWITHRELATED&id=551DC374-4876-4590-A4F564FD9E79093B>.

- C2-187 Environment Canada. (2002.) *Source to Tap: Protecting Canada's Water*. Retrieved March 20, 2008, from [http://www.ec.gc.ca/EnviroZine/english/issues/22/feature1\\_e.cfm](http://www.ec.gc.ca/EnviroZine/english/issues/22/feature1_e.cfm).
- C2-188 Environment Canada. (2006). *Water: No Time to Waste (Water Myths and Facts)*. Retrieved March 25, 2008, from [http://www.ec.gc.ca/water/en/info/pubs/nttw/e\\_nttw8a.htm](http://www.ec.gc.ca/water/en/info/pubs/nttw/e_nttw8a.htm).
- C2-189 Natural Resources Canada. (2008). *Sustainable Forest Management—Canada's Forests*. Retrieved March 26, 2008, from [http://canadaforests.nrcan.gc.ca/articletopic/top\\_suj/](http://canadaforests.nrcan.gc.ca/articletopic/top_suj/).

THIS PAGE INTENTIONALLY LEFT BLANK



**ROYAL CANADIAN ARMY CADETS**  
**SILVER STAR**  
**INSTRUCTIONAL GUIDE**



**SECTION 6**

**EO M326.04 – NAVIGATE ALONG A ROUTE USING A MAP AND COMPASS**

---

Total Time: 60 min

---

**PREPARATION**

---

**PRE-LESSON INSTRUCTIONS**

Resources needed for the delivery of this lesson are listed in the lesson specification located in A-CR-CCP-703/PG-001, Chapter 4. Specific uses for said resources are identified throughout the instructional guide within the TP for which they are required.

Review the lesson content and become familiar with the material prior to delivering the lesson.

**PRE-LESSON ASSIGNMENT**

N/A.

**APPROACH**

An interactive lecture was chosen for TP 1 to review navigation background material.

A practical activity was chosen for TP 2 as it is an interactive way to allow the cadet to experience navigation in a safe, controlled environment. This activity contributes to the development of navigation knowledge and skills in a fun and challenging setting.

---

**INTRODUCTION**

---

**REVIEW**

N/A.

**OBJECTIVES**

By the end of this lesson the cadet shall have navigated along a route using a map and compass.

**IMPORTANCE**

It is important for cadets to understand how to navigate along a route as it provides a foundation for building subsequent navigation skills. Navigation is an important aspect of expedition training. All cadets should take every opportunity to practice and refine these skills.

**Teaching Point 1****IAW PO 222 (Navigate Along a Route Using a Map and Compass, A-CR-CCP-702/PF-001, Chapter 12), Review Navigation**

Time: 10 min

Method: Interactive Lecture

**DETERMINING DISTANCE ON A MAP**

Cadets can use their maps to measure the distance between two points (A and B) on the ground. All maps are drawn to scale; therefore, a specified distance on a map equals a specified distance on the ground. The scale of a map is printed at the top and bottom of each map (eg, scale 1 : 50 000). This means that 1 cm on the map equals 50 000 cm (500 m) on the ground. There are two ways to determine distance on a topographical map – point-to-point and along a route.

**Measuring Point-to-Point**

To measure a distance point-to-point:

1. Lay the straight edge of a piece of paper against the two points.
2. With a sharp pencil, mark the paper at the A (start) and B (finish) points.
3. Lay the paper just under the scale bar (metres) and move the B mark backwards to each thousands mark until the A mark falls within the subdivided thousands (hundreds) to the left of the zero.
4. To calculate the total distance, add the number of thousands where the B mark is, plus the number of subdivided thousands where the A mark is to the left of the zero.

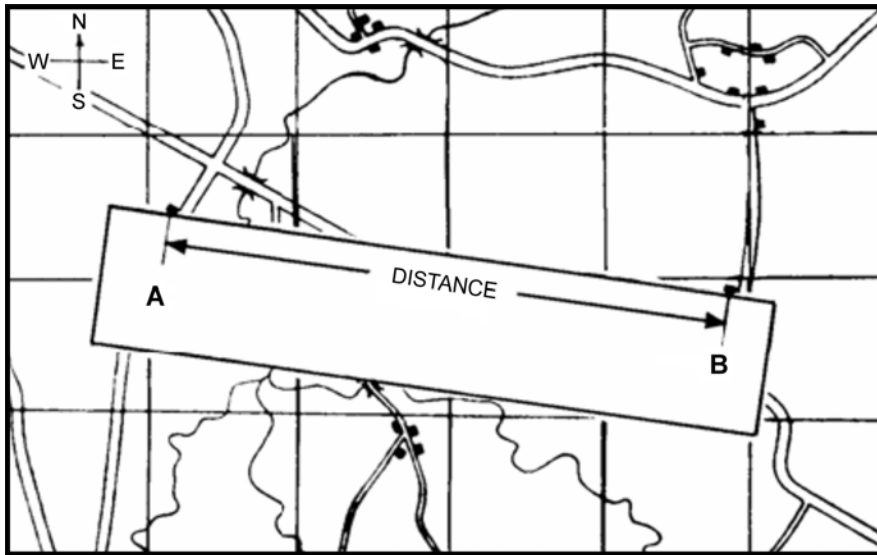

A-CR-CCP-121/PT-001 (p. 5-24)

Figure 16-6-1 Measuring Distance Point-to-Point

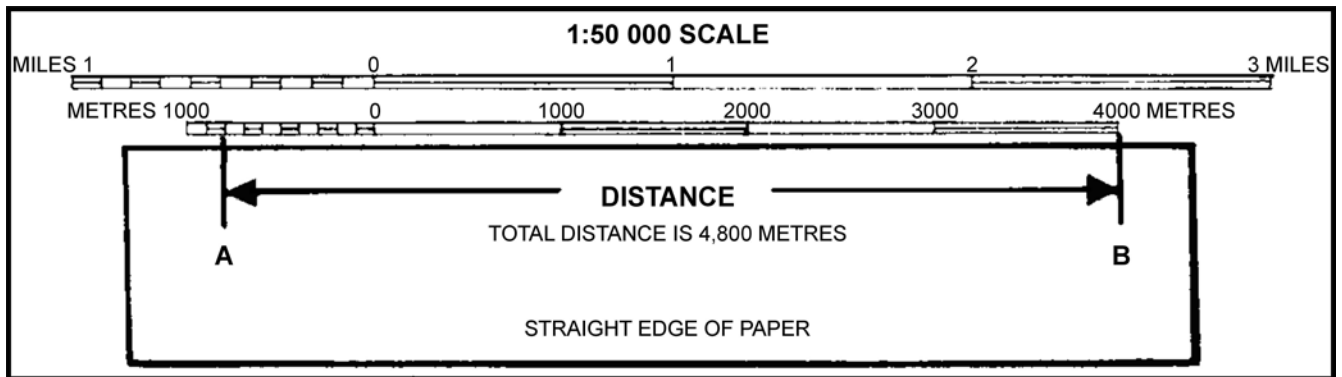

*A-CR-CCP-121/PT-001 (p. 5-25)*

Figure 16-6-2 Calculating Distance

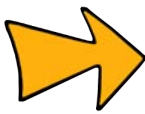

For a distance that is longer than 5 000 m, measure the first 5 000 m and mark the paper with a new line and label it '5 000 m'. Place the new mark at the zero or thousands mark until the A mark fits within the subdivided thousands bar. Add the total of that distance to the 5 000 m and that will be the total distance.

### Measuring Along a Route

Sometimes the cadets need to find the distance between A and B around curves in a road or along a planned route. To measure a distance along a route between two points:

1. Lay the straight edge of a piece of paper against point A.
2. With a sharp pencil, mark point A on the paper and the map.
3. Line up the paper with the edge of the road until you come to a curve and make another mark on the paper and on the map.
4. Pivot the paper so that it continues to follow the road edge. Repeat until you reach point B.
5. Mark your paper and the map at point B.
6. Lay the paper just under the scale bar (metres) and move the B mark backwards to each thousands mark until the A mark falls within the subdivided thousands to the left of the zero.
7. Add the number of thousands where the B mark is, plus the number of subdivided thousands where the A mark is to the left of the zero, to determine the total distance.

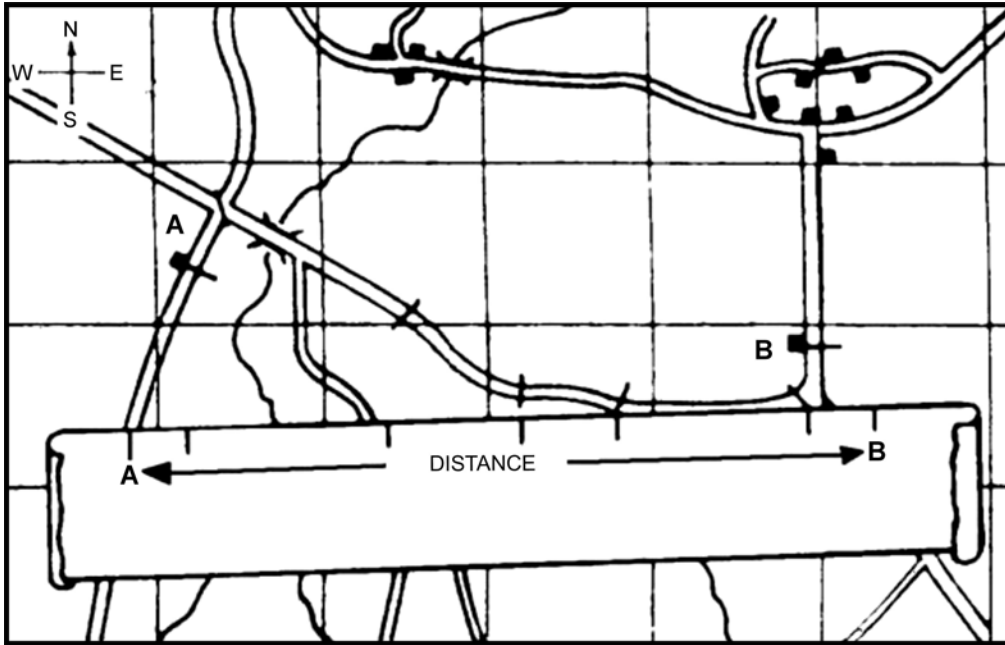

*A-CR-CCP-121/PT-001 (p. 5-25)*

Figure 16-6-3 Measuring Distance Along a Route

## DETERMINING INDIVIDUAL PACE

### Pace Counting Method

The pace counting method (pacing) is used for measuring a given distance by counting every other step. Two steps equal one pace. Pacing is a very important skill in navigation, as each person has a different pace and needs to determine their pace before it can become a useful measurement tool. Pacing varies between individuals as it uses a natural stride – an average adult will pace about 60–70 paces in 100 m.

To determine an individual pace, practice taking uniform, comfortable steps over a measured distance (100 m) counting every second step of the dominant foot. Do this three to five times. The average will be the individual's pace number and should be remembered.



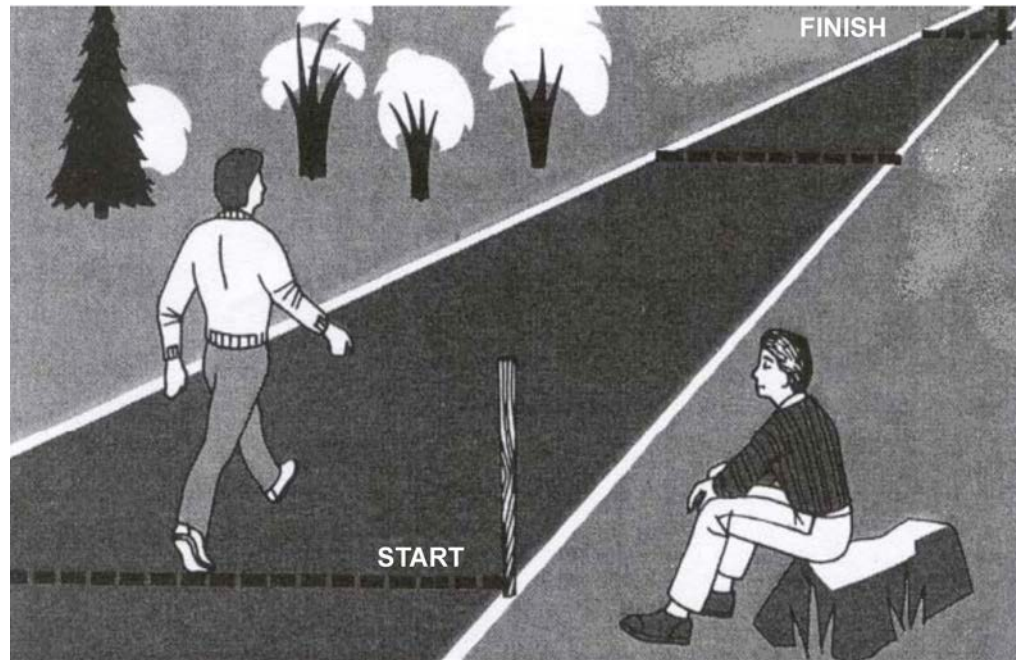

*B. Kjellstrom, Be Expert with Map & Compass, Hungry Minds, Inc. (p. 53)*

Figure 16-6-4 Determining Distance Using Pacing

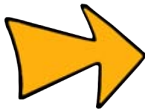

Remember, pacing is an approximation. A margin of error of 1–2 percent is considered reasonable (eg, 10–20 m for every 1 km walked).

### Factors That Affect Pacing

Pacing can be affected by different factors and numbers may vary. Some of the factors and their affect on individual pacing are:

- **Topography.** This is the most common factor. Walking through mud, thick bush and tall vegetation can shorten the paces.
- **Slopes.** Walking uphill will shorten the paces, while walking downhill will lengthen the paces.
- **Fatigue.** Pacing may change from natural in the morning, when cadets are rested, and shorter in the afternoon as they start to get tired.
- **Equipment.** Equipment could affect pacing, such as the wrong type of footwear. Too much or too little clothing and the amount of equipment being carried can shorten the paces.
- **Weather.** Heavy rain, wind velocity, temperature and snow can shorten the paces.



Pacing beads can be used to keep track of the distance walked. One bead is moved for every 100 m walked. If pacing beads are not available, stones can be used by moving them from one pocket to another to count every 100 m.

### ORIENTING A MAP USING A COMPASS

To orient a map using a compass:

1. Check and set the current declination on the compass.
2. Set the compass dial to read 00 (zero) mils or 0 degrees (north).
3. Lay the compass flat on the map with the cover open.
4. Orient the compass to point the mirror to north (top of the map).
5. Align one side of the base plate with an easting line.
6. Turn the map and compass together until the red end of the magnetic needle is over the orienting arrow.



The mnemonic used to remember to put the magnetic needle over the orienting arrow is "Red in the Bed".



Director Cadets 3, 2007, Ottawa,  
ON: Department of National Defence

Figure 16-6-5 Set Declination



Director Cadets 3, 2007, Ottawa,  
ON: Department of National Defence

Figure 16-6-6 Set Compass to 00



Director Cadets 3, 2007, Ottawa,  
ON: Department of National Defence

Figure 16-6-7 Turn  
Until Red is in the Bed

## TAKING A MAGNETIC BEARING

A compass can be used to identify the cardinal points such as north and south, the direction of travel and the bearing from one's current location to a prominent object. However, the ability to take a magnetic bearing of a prominent object and to use that information to help identify one's general location can save hours when trekking. A magnetic bearing is a quick method for determining the direction of travel.

There are two ways to determine a magnetic bearing.

### Using a Prominent Object in Sight

To determine the magnetic bearing of a prominent object:

1. Check and set the predetermined declination on the compass.
2. Hold the compass at eye level, at arms length, and face the prominent object.
3. Aim at the object using the compass sight, ensuring the sighting line is in line with the index pointer.
4. Adjust the compass cover so the compass dial is seen in the sighting mirror.
5. Look in the mirror and turn the compass dial until the magnetic needle is over the orienting arrow (red in the bed).
6. Read the number on the compass dial at the luminous index pointer. The magnetic bearing of the prominent object is read at the luminous index pointer.



*A-CR-CCP-121/PT-001 (p. 5-42)*

Figure 16-6-8 Taking a Magnetic Bearing

### Using a Map

To determine a magnetic bearing using a map:

1. Set the predetermined declination on the compass.
2. Identify and mark the start (Point A) and finish (Point B) points on a map.
3. Draw a plotting ray from Point A to Point B.
4. Lay the fully opened compass with the edge of the compass base plate along the plotting ray, in the direction of travel (Point A to Point B).
5. Hold the compass in place, rotate the compass dial so that the compass meridian lines align with the easting lines on the map, ensuring north on the dial indicates north on the map.
6. Read the number on the compass dial at the luminous index pointer.





Prior to determining a magnetic bearing on a map, it is good practice to first estimate the bearing by drawing a quick compass rose and looking at where the bearing would be on the compass rose. This serves as a good check to ensure the cadet has not accidentally measured the back bearing.



If the bearing is taken from Point B to Point A, the compass will be pointing 180 degrees or 3200 mils in the exact opposite direction of travel wanted. This is called a back bearing.

---

### CONFIRMATION OF TEACHING POINT 1

---

The cadets' participation in the activity in TP 2 will serve as the confirmation of this TP.

#### Teaching Point 2

#### Conduct a Navigation Activity

Time: 40 min

Method: Practical Activity

---

### BACKGROUND KNOWLEDGE

---

#### DESCRIBING BEARINGS

**Bearing.** A bearing is an angle that is measured clockwise, from a fixed zero line; north is always this zero line. Simply, a bearing is just another name for an angle.

#### Types of Bearings

There are three different types of bearings:

**Grid Bearing.** A grid bearing is a bearing that is measured between two points on a map. The ability to measure a bearing from a map allows a map user to plan routes or activities before going into the field, and allows an easy method of communicating information about movement or location.

**Magnetic Bearing.** A magnetic bearing is a bearing that is measured between two points using a compass. A magnetic bearing is a quick and efficient method of describing a route to take. The bearing alone is usually not enough information to navigate with and must also have distance or a target object.

**Back Bearing.** A back bearing is a bearing that is in the exact opposite direction of the bearing that has been measured. A back bearing can be useful for different reasons; to return to the start location after a hike, or to calculate the bearing from an object to one's current location. Depending on the compass being used, the steps to calculate a back bearing are:

- When the bearing is less than 3200 mils or 180 degrees, add 3200 mils or 180 degrees.
- When the bearing is greater than 3200 mils or 180 degrees, subtract 3200 mils or 180 degrees.

#### SETTING DECLINATION ON A COMPASS

The compass's declination scale must be set to compensate for the difference between true north and magnetic north. To do this the amount of declination in degrees east or west is needed. Then, turn the compass over and look at the back of the dial.

From the zero point, using the screwdriver on the end of the safety cord, turn the declination screw to the right for west and to the left for east declination. Each small black line is two degrees.



When setting declination on a compass, it is easier to hold the screwdriver and turn the compass, especially in cold weather. The declination shall *never* be turned past 90 degrees on the declination scale.

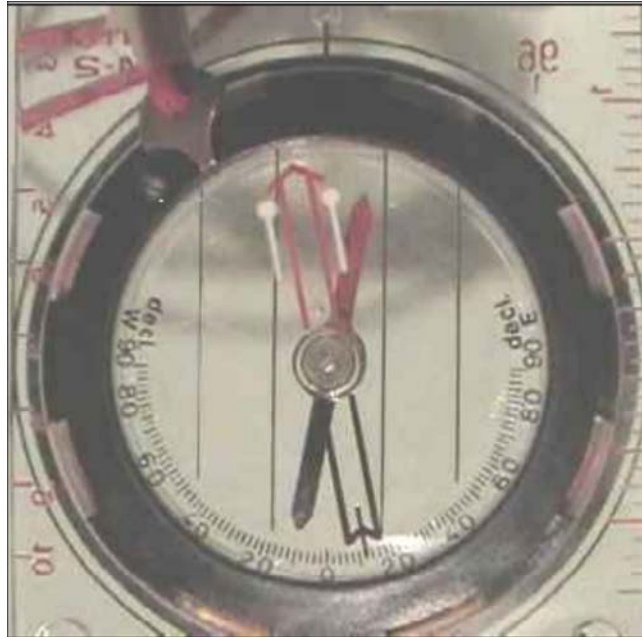

*Director Cadets 3, 2007, Ottawa, ON: Department of National Defence*

Figure 16-6-9 Declination Screw

---

## ACTIVITY

---

### OBJECTIVE

The objective of this activity is for the cadet to navigate along a route.

### RESOURCES

- Topographical map of the area (one per team),
- Compass (one per team),
- Start and end point GR,
- Paper, and
- Pencils.

### ACTIVITY LAYOUT

N/A.

## ACTIVITY INSTRUCTIONS

In expedition teams, cadets will navigate a route as part of the practical expedition activity. The mode of travel will vary with each expedition centre. During the activity, cadets will:

1. describe bearings;
2. set declination on a compass;
3. determine distance between two points on a map;
4. determine individual pace;
5. orient a map using a compass;
6. take a magnetic bearing; and
7. travel on a series of bearings along a route.

## SAFETY

N/A.

---

### CONFIRMATION OF TEACHING POINT 2

---

The cadets' participation in the navigation activity will serve as the confirmation of this TP.

---

### END OF LESSON CONFIRMATION

---

The cadets' participation in navigating along a route will serve as the confirmation of this lesson.

---

### CONCLUSION

---

## HOMEWORK/READING/PRACTICE

N/A.

## METHOD OF EVALUATION

This EO is assessed IAW A-CR-CCP-703/PG-001, Chapter 3, Annex B, Appendix 7 (326 PC).

## CLOSING STATEMENT

Map and compass skills take a great deal of practice for a person to become efficient using them in the field. Throughout expeditions, cadets will always be required to navigate routes. Take every opportunity to practice map and compass, whether it is navigating a route or riding a bike. The skills learned in Green and Red Star navigation are building blocks. There are still more navigation skills to acquire.

## INSTRUCTOR NOTES/REMARKS

Assistant instructors may be required for this lesson.

Expedition centres are required to select two dynamic modes of travel from EO M326.02a (Paddle a Canoe, Section 2), EO M326.02b (Ride a Mountain Bike, Section 3), and EO M326.02c (Hike Along a Route, Section 4) to incorporate into their weekend training.

This EO has been allocated one period in the overall course period allocation. Each expedition centre may adjust this allocation to reflect the choice of activities, facilities and available resources at the expedition centre.

Timings for this EO will vary. While there is a requirement for some initial training, the focus should be on having the cadets practice navigation techniques during the practical expedition activity.

---

### REFERENCES

---

- A2-041 B-GL-382-005/PT-001 Canadian Forces. (2006). *Maps, Field Sketching, Compasses and the Global Positioning System*. Ottawa, ON: Department of National Defence.
- C0-011 Canadian Orienteering Federation. (1985). *Orienteering Level Two Coaching Certification*. Ottawa, ON: Canadian Orienteering Federation.
- C2-041 (ISBN 0-07-136110-3) Seidman, D., & Cleveland, P. (1995). *The Essential Wilderness Navigator*. Camden, ME: Ragged Mountain Press.

THIS PAGE INTENTIONALLY LEFT BLANK





**ROYAL CANADIAN ARMY CADETS**  
**SILVER STAR**  
**INSTRUCTIONAL GUIDE**



**SECTION 7**

**EO M326.05 – USE EXPEDITION EQUIPMENT**

---

Total Time: 60 min

---

**PREPARATION**

---

**PRE-LESSON INSTRUCTIONS**

Resources needed for the delivery of this lesson are listed in the lesson specification located in A-CR-CCP-703/PG-001, Chapter 4. Specific uses for said resources are identified throughout the instructional guide within the TP for which they are required.

Review the lesson content and become familiar with the material prior to delivering the lesson.

Refer to the owner's manual for the operating instructions for the following items:

- single-burner mountain stove,
- water filter,
- fuel bottle,
- fuel,
- rope,
- pocket knife/multipurpose tool,
- carabiner, and
- headlamp.

**PRE-LESSON ASSIGNMENT**

N/A.

**APPROACH**

Demonstration and performance was chosen for this lesson as it allows the instructor to explain and demonstrate the uses of expedition equipment while providing an opportunity for the cadets to practice operating this equipment under supervision.

---

**INTRODUCTION**

---

**REVIEW**

N/A.

## OBJECTIVES

By the end of this lesson the cadet shall be expected to safely employ equipment required during an expedition.

## IMPORTANCE

It is important for cadets to understand how to operate equipment being used on expedition training so that they can safely use the equipment. Proper working equipment will make expedition training safer and efficient. Correctly using equipment will ensure the equipment lasts longer and requires less maintenance.



For this skill lesson, it is recommended that instruction take the following format:

1. Explain and demonstrate the complete skill while cadets observe.
2. Explain and demonstrate each step required to complete the skill. Monitor cadets as they imitate each step.
3. Monitor the cadets' performance as they practice the complete skill.

**Note:** Assistant instructors may be employed to monitor cadet performance.

---

### Teaching Point 1

### Explain, Demonstrate and Have the Cadet Operate a Single-Burner Mountain Stove

Time: 25 min

Method: Demonstration and Performance

---



Refer to the owner's manual for the operating instructions for the single-burner mountain stove.



This TP focuses on expedition equipment that the cadets may not have been introduced to before. When available, have examples of each piece of equipment and pass them around so the cadets can see the equipment and handle it.

During an expedition it is important that cadets are aware of the equipment that is being brought. Cadets should know the various uses for each piece of equipment, how it works and how to make basic repairs as required.

The stoves used at expedition centres are single-burner mountain stoves. These stoves are used because of size, weight and functionality. Single-burner mountain stoves are portable stoves that allow cooking anywhere without having to make a fire. These stoves are stored easily and can be carried during an expedition. Single-burner mountain stoves are commonly fuelled by using white gas such as naphtha and can perform well in extreme cold and high altitudes.



The stove featured in this lesson is the Coleman Peak One, if another is used, substitute information from the owner's manual.

## IDENTIFYING PARTS AND ACCESSORIES

The Coleman Peak One single-burner mountain stove has the following characteristics:

- powerful 7500 BTUs with precise flame control,
- fold out legs that collapse for storage and keeps the stove stable,
- liquid fuel appliance offers superior operational fuel and cost efficiency,
- integrated 350-mL fuel tank,
- one fill-up per weekend of camping,
- 2-hour burn time on high, 7.5 hours on low, and
- boils 0.94 L (one quart) of water in four minutes.



The diagram provided is for part identification, not disassembly purposes.

The parts and accessories of a single-burner mountain stove are:

**Burner Plate.** Fitted with a grate to ensure cookware remains stable.

**Stove Grate.** The stove grate supports pot sets and ensures pots remain stable.

**Fuel Line.** The line from the fuel tank that provides the burner plate with fuel.

**Pump Assembly.** The pump assembly is fitted into the tank and is held in place by a locking mechanism.

**Lighting Lever.** The lighting lever is the on/off switch for the stove.

**Fuel Cap.** The fuel cap keeps the fuel from spilling.

**Fuel Tank.** The fuel tank is on the bottom of the stove. This tank is only intended to be filled to three quarters full, allowing air in for pressurization.

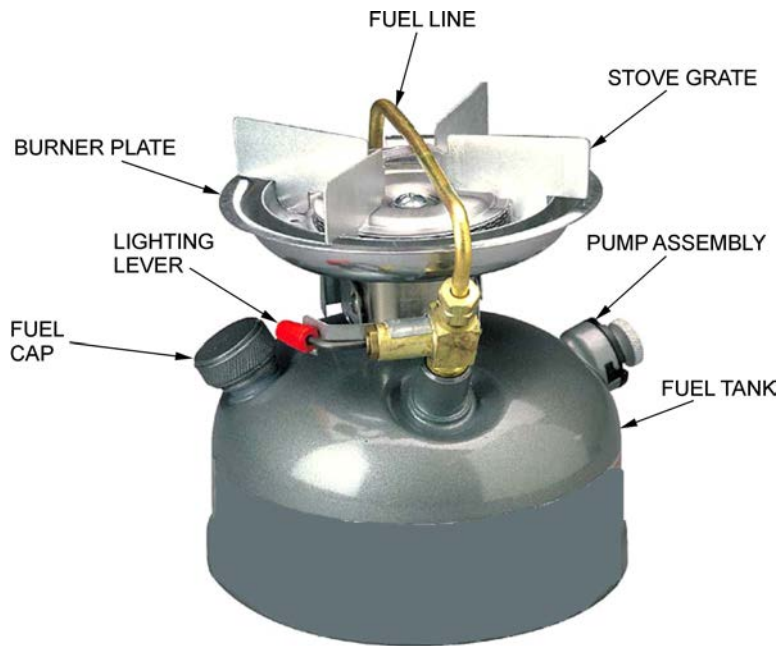

*"Backpackgear Online", Copyright 2007 by Maguire and Johnson Web Services. Retrieved March 28, 2007, from [http://www.coleman.com/coleman/colemancom/detail.asp?product\\_id=533B705&categoryid=2020](http://www.coleman.com/coleman/colemancom/detail.asp?product_id=533B705&categoryid=2020)*

Figure 16-7-1 Single-Burner Mountain Stove

## **IDENTIFYING FUEL TYPE AND OPERATIONAL TEMPERATURES**

The stove uses naphtha fuel.

It is operational in all types of temperatures.

## **ASSEMBLY**

The single-burner mountain stove comes assembled. The fold out legs only need extending.

## **LIGHTING AND EXTINGUISHING**

### **Precautions**

Hazards are few if precautions are taken. Follow these few simple rules:

- Never leave the stove unattended.
- Do not use a stove as a heating device or in enclosed spaces such as buildings, tents or caves.
- Never loosen the filler cap on the fuel tank while the stove is in operation.
- Always fill and light the stove outside in a well ventilated area, away from open flame, heat and combustibles.
- Use only naphtha fuel.
- Store away from open flame or excessive heat.
- Before transporting or storing, ensure the stove is cool. Loosen the filler cap to release air pressure and retighten. Turn the control knob off.
- If the stove catches fire, turn off the fuel supply.
- When using the stove ensure a fire extinguisher is available.



Stoves must not be used in enclosed spaces such as buildings and tents. The burning of naphtha and other fuels results in the release of carbon monoxide. Carbon monoxide binds with hemoglobin 200–250 times better than oxygen, and disrupts almost all physiologic and neurologic systems, even in fairly low concentrations. The gas is heavier than air, and pools in the low ground of tents and caves where outdoor enthusiasts sleep, and will not go away for days unless it is forced out by a strong, persistent direct draft of cold air at the height of the pooled gas. Preventing the problem in the first place requires a similarly active draft at the bottom of the stove, not at the top of the tent or cave as was once thought.

According to one recent research study, asphyxiation in tenting situations kills three times as many people yearly than mountaineering does. Other research has linked even moderate exposure to carbon monoxide to significant long-term effects, including depressed mood, apathy, disorientation, irritability and amnesia. Several of these symptoms occur in 100 percent of individuals exposed and can be measured years after the initial exposure. Risks also increase in higher altitudes.

### Priming the Single-Burner Mountain Stove

To prime the single-burner mountain stove follow these steps:

1. Make sure the control knob is in the OFF position.
2. Turn the pump rod two full turns counter-clockwise to open.
3. Place the thumb over the air vent of the pump rod handle.
4. Pump 30–40 strokes to pressurize the fuel tank.
5. Turn the pump rod clockwise until it is closed tight.

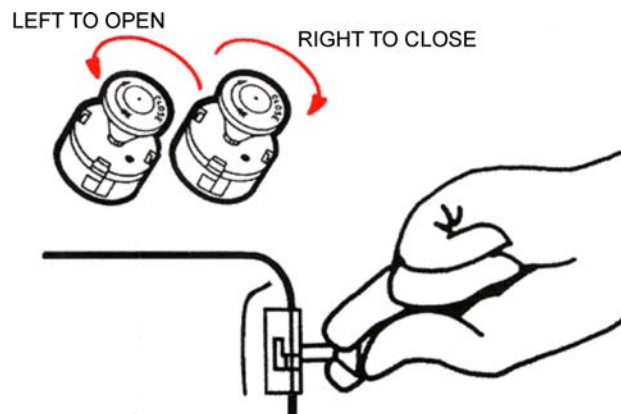

*The Canadian Coleman Co., Coleman Camp Stove Model M425F710C Instructions for Use, The Canadian Coleman Co.*

Figure 16-7-2 Priming the Fuel Tank

### Lighting the Burner

To light the burner follow these steps:

1. Do not lean over the stove while lighting.
2. Hold a lit match near the burner.
3. Turn the control lever to the LIGHT position.

4. Monitor the flame.
5. When the flame turns blue in colour (approximately one minute), turn the instant light lever down and turn the control knob to the desired heat setting (HI–LO).



Should the stove fail to light or the match goes out before ignition, turn the control lever to the OFF position and wait two minutes before attempting to light the stove again.

### Extinguishing the Burner

To extinguish the burner follow these steps:

1. Remove cookware from the stove and turn the instant light lever to the OFF position.
2. Turn the control lever clockwise to the OFF position and close firmly.

### Storing After Use

To store the single-burner mountain stove follow these steps:

1. Allow the stove to cool before packing.
2. Ensure the stove is clean and any dirt, matches, etc are removed.
3. Empty all fuel from the stove.
4. Store the stove in a cool, dry location.

---

## CONFIRMATION OF TEACHING POINT 1

---

The cadets' participation in lighting a stove will serve as the confirmation of this TP.

---

### Teaching Point 2

### Explain, Demonstrate and Have the Cadet Operate a Water Filter

Time: 5 min

Method: Interactive Lecture

A water filter can be used to strain out most parasites and micro-organisms by pumping the water through a filter. A filter is made of a thick porous material such as carbon or ceramic which trap particles as the water flows through it.



Contamination by wildlife, farm animals, pollutants or other hikers may introduce micro-organisms into water sources that can cause intestinal problems. It is imperative that all collected water is treated before being consumed. Filtering is the best way.

### IDENTIFYING CHARACTERISTICS



Refer to the owner's manual for the operating instructions for the water filter.

The following are characteristics of the ceramic water filter:

- filters at a 1 L per minute flow rate;
- effective against all protozoa, most bacteria, and chemicals including iodine and chlorine; and
- includes foam pre-filter.

The MSR WaterWorks water filter (as illustrated in Figure 16-7-3) is a rugged and lightweight water filter. Its polyurethane construction and carbon-cored ceramic filter element removes larger bacteria and some chemicals (iodine and chlorine) along with odours and tastes.

A gauge is supplied to determine when the ceramic filter needs replacing.

### IDENTIFYING PARTS AND ACCESSORIES

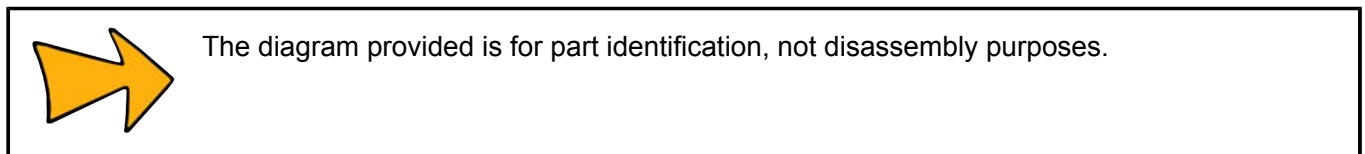

The diagram provided is for part identification, not disassembly purposes.



*"Mountain Equipment Coop", Copyright 2007 by Mountain Equipment Coop. Retrieved November 16, 2007, from [http://www.mec.ca/Products/product\\_detail.jsp?PRODUCT%3C%3Eprd\\_id=845524442372421&FOLDER%3C%3Efolder\\_id=2534374302696689&bmUID=1195238644467](http://www.mec.ca/Products/product_detail.jsp?PRODUCT%3C%3Eprd_id=845524442372421&FOLDER%3C%3Efolder_id=2534374302696689&bmUID=1195238644467)*

Figure 16-7-3 Water Filter

**Pumping Handle.** The lever that allows the user to pump the water.

**Filter Cap.** A protective covering that covers the ceramic filter.

**Ceramic Filter.** Located within a plastic enclosure, the water filter has a 0.2 micron membrane that removes bacteria and acts as a second line of defence around the ceramic filter. The wide-mouth base reduces spillage and the risk of cross-contamination with unfiltered water.

**Filter Gauge.** Gauge used to determine when filter requires replacement.

### ASSEMBLY

The water filter should be assembled and ready to use. To use:

1. Remove the filter cap.
2. Begin pumping the handle in a steady manner to pump water.

## MAXIMUM FILTERING CAPACITY

Normal conditions will allow a user to filter between 10–20 L of water between cleanings.

## PUMPING WATER

To pump water:

1. Place the hose with the float end in the water source. (If a bucket or pot is available, collect water in the bucket or pot and filter from there). This will assist in keeping dirt out of the filter.
2. Attach the filter to a wide-mouth bottle.
3. Pump the pumping handle a few times to prime the pump.
4. Pump the handle to draw water until the bottle is full.

## DISMANTLING AND CLEANING

Any excess water should be released from the filter and the filter should be allowed to air dry. This will prevent the growth of mold, mildew and bacteria.

When storing for long term, the ceramic filter should be removed and air dried for 3–5 days. Wash and dry other filter parts thoroughly.

---

### CONFIRMATION OF TEACHING POINT 2

---

The cadets participation in using a water filter will serve as the confirmation of this TP.

---

### Teaching Point 3

### Explain, Demonstrate and Have the Cadet Safely Use Expedition Equipment

Time: 15 min

Method: Demonstration and Performance

---



Refer to the owner's manual for the operating instructions for the fuel bottle, rope, pocket knife, carabiner and headlamp.



When using equipment, everyone should:

- Store equipment in a secure place. Never leave equipment lying around or touching the ground.
- Always use the right tool for the job.
- Follow the safety procedures for using the equipment.
- Keep the edges of blades sharp and handles tight.
- Clean and lightly oil steel parts before storage.



## FUEL BOTTLE

Fuel is carried in a separate container to ensure there is no spillage of fuel in the pack. Fuel containers are either aluminum or plastic. Aluminum containers are usually a cylindrical aluminum bottle. Plastic bottles are usually red in colour and have a fluoropolymer inner coating that resists both gasoline and alcohol. Plastic fuel bottles should never be used as a tank for a stove or be pressurized with a pump. Once a container is used for a particular type of fuel it should not be used for another fuel, as the substances will combine and deteriorate the container or combust.



*"Mountain Equipment Coop", Copyright 2007 by Mountain Equipment Coop. Retrieved March 28, 2007, from [http://www.mec.ca/Products/product\\_detail.jsp?PRODUC%3C%3Eprd\\_id=845524441772275&FOLDER%3C%3Efolder\\_id=2534374302696497&bmUID=1175178016804](http://www.mec.ca/Products/product_detail.jsp?PRODUC%3C%3Eprd_id=845524441772275&FOLDER%3C%3Efolder_id=2534374302696497&bmUID=1175178016804)*

Figure 16-7-4 Aluminum Fuel Bottle

### Storing Techniques

During expedition training, fuel bottles will be stored with cooking equipment or in the designated location specified by the instructors.

Fuel bottles should be stored empty whenever possible.

If the bottle is being stored with fuel, it should be stored in a locked area, away from any flammables and other explosive materials.

### Transferring Fuel to and From the Fuel Bottle

When transferring fuel to and from the fuel bottle, a funnel or spigot should be used to prevent splashes, leaks and spills.

### ROPE

While rope can be heavy to carry, it is an extremely advantageous piece of expedition equipment. A length of rope, approximately 15 m, can be used to hang food in the food hang, make a clothesline to dry clothing or tie a tarp to make a shelter when there is inclement weather. It can also be used to complete minor field repairs.

### Cleaning

Ropes should be washed frequently with a soap. Hang the rope to dry, out of direct sunlight.

## Storing

Storing a rope should only be done when it is completely dry, free of knots and coiled loosely. Ropes should be stored in a cool, dry place away from sunlight, heat, and chemicals.

## Coiling

Depending on the length of the rope, rope should be coiled using a mountaineer's coil or a butterfly coil.

## POCKET KNIFE/MULTIPURPOSE TOOL

A pocket knife or multi-purpose tool is essential for repairing equipment and cutting rope, cord or bandages. The key is to find a knife or tool that is small but has a blade, scissors, and screwdriver that are required while out on an expedition.

## Sharpening

Blades should be sharpened regularly with a proper sharpening stone or tool. It is important to follow the manufacturer's directions regarding care.

## Holding

A firm grip should be taken on the handle of any knife. If the pocket knife has a locking mechanism, it should be used.

## Storing

All pocket knives should be cleaned before storage. Pocket knives should be stored in their sheaths and oiled prior to long-term storage.



*"Mountain Equipment Coop", Copyright 2007 by Mountain Equipment Coop. Retrieved November 16, 2007, from [http://www.mec.ca/Products/product\\_detail.jsp?PRODUCT%3C%3Eprd\\_id=845524441773603&FOLDER%3C%3Efolder\\_id=2534374302696789&bmUID=1195240440348](http://www.mec.ca/Products/product_detail.jsp?PRODUCT%3C%3Eprd_id=845524441773603&FOLDER%3C%3Efolder_id=2534374302696789&bmUID=1195240440348)*

Figure 16-7-5 Multi-Purpose Knife



*"Mountain Equipment Coop", Copyright 2007 by Mountain Equipment Coop. Retrieved November 16, 2007, from [http://www.mec.ca/Products/product\\_detail.jsp?PRODUCT%3C%3Eprd\\_id=845524442622475&FOLDER%3C%3Efolder\\_id=2534374302696889&bmUID=1195240570229](http://www.mec.ca/Products/product_detail.jsp?PRODUCT%3C%3Eprd_id=845524442622475&FOLDER%3C%3Efolder_id=2534374302696889&bmUID=1195240570229)*

Figure 16-7-6 Multi-Purpose Tool

## CARABINER

A carabiner is a common piece of equipment used primarily in mountaineering activities such as climbing and abseiling. On an expedition, a carabiner is an essential piece of equipment as it can be used in a variety of circumstances, such as:

- attaching the tether line in the canoe or to a pack;
- clipping a water bottle to the outside of a pack;
- stringing up a food hang or clothesline; and
- attaching a throw bag to the thwart of the canoe.

## HEADLAMP

A headlamp is simply a flashlight that has been attached to an adjustable strap that fits around the user's head. It is very beneficial while out on an expedition as it frees up the user's hands to complete tasks after dark, such as reading a map, lighting a stove, setting up a tent or finding the bathroom.



*"Mountain Equipment Coop", Copyright 2007 by Mountain Equipment Coop. Retrieved November 16, 2007, from [http://www.mec.ca/Products/product\\_detail.jsp?PRODUCT%3C%3Eprd\\_id=845524442621000&FOLDER%3C%3Efolder\\_id=2534374302697057&bmUID=1195238790425](http://www.mec.ca/Products/product_detail.jsp?PRODUCT%3C%3Eprd_id=845524442621000&FOLDER%3C%3Efolder_id=2534374302697057&bmUID=1195238790425)*

Figure 16-7-7 Headlamp



Headlamps can use a combination of light-emitting diodes (LED) and halogen bulbs. Choosing a headlamp will vary depending on use. Halogen bulbs offer the brightest output, but use battery power fast. LED bulbs give off sufficient light and are very efficient.



Extra batteries must always be brought to supplement those currently in the headlamp.

---

### CONFIRMATION OF TEACHING POINT 3

---

#### QUESTIONS

- Q1. Why is it preferable to have a headlamp with both LED and halogen bulbs?
- Q2. What are some of the materials that water filters are made from?
- Q3. What can a carabiner be used for?

#### ANTICIPATED ANSWERS

- A1. Halogen bulbs offer the brightest output, but use battery power very fast. LED bulbs do not give off as much light, but are very efficient.
- A2. Filters can be made from a thin sheet with precisely-sized pores which prevent all objects larger than the pores from moving through it or from thick porous materials such as carbon or ceramic which trap particles as the water flows through it.
- A3. Carabiners can be used for:
- attaching the tether line in the canoe or to the expedition field pack;
  - clipping a water bottle to the outside of the expedition field pack;
  - stringing up a food hang or clothesline; and
  - attaching a throw bag to the thwart of the canoe.

---

### END OF LESSON CONFIRMATION

---

The cadets' participation in using expedition equipment will serve as the confirmation of this lesson.

---

### CONCLUSION

---

#### HOMEWORK/READING/PRACTICE

N/A.

#### METHOD OF EVALUATION

This EO is assessed IAW A-CR-CCP-703/PG-001, Chapter 3, Annex B, Appendix 7 (326 PC).

#### CLOSING STATEMENT

Knowing how to properly use, and store expedition equipment will allow the cadets to successfully complete training without added assistance from instructors or staff.

#### INSTRUCTOR NOTES/REMARKS

Additional staff may be required to supervise cadets using expedition equipment.

Instructors should refer to the owner's manual for the operating instructions for the single-burner mountain stove.

Instructors should refer to the owner's manual for the operating instructions for the water filter.

Instructors should refer to the owner's manual for the operating instructions for the fuel bottle, rope, pocket knife, carabiner and headlamp.

It is recommended that this EO be taught where opportunities exist rather than in a structured 60-minute period.

Expedition centres are required to select two dynamic modes of travel from EO M326.02a (Paddle a Canoe, Section 2), EO M326.02b (Ride a Mountain Bike, Section 3), and EO M326.02c (Hike Along a Route, Section 4) to incorporate into their weekend training.

This EO has been allocated one period in the overall course period allocation. Each expedition centre may adjust this allocation to reflect the choice of activities, facilities and available resources at the expedition centre.

Timings for this EO will vary. While there is a requirement for some initial training, the focus should be on having the cadets practice hiking techniques through practical application.

Upon arrival at the expedition centre cadets will be broken into teams/groups. These teams/groups will remain the same for the duration of the weekend.

---

### REFERENCES

---

N/A.

THIS PAGE INTENTIONALLY LEFT BLANK



**ROYAL CANADIAN ARMY CADETS**  
**SILVER STAR**  
**INSTRUCTIONAL GUIDE**



**SECTION 8**  
**EO M326.06 – FOLLOW DAILY ROUTINE**

---

Total Time: 30 min

---

**PREPARATION**

---

**PRE-LESSON INSTRUCTIONS**

Resources needed for the delivery of this lesson are listed in the lesson specification located in A-CR-CCP-703/PG-001, Chapter 4. Specific uses for said resources are identified throughout the instructional guide within the TP for which they are required.

Review the lesson content and become familiar with the material prior to delivering the lesson.

**PRE-LESSON ASSIGNMENT**

N/A.

**APPROACH**

A demonstration was chosen for TP 1 as it allows the instructor to explain and demonstrate campsite selection.

An interactive lecture was chosen for TPs 2–4 to orient the cadet to following campsite routines during expedition training.

---

**INTRODUCTION**

---

**REVIEW**

N/A.

**OBJECTIVES**

By the end of this lesson the cadet shall be expected to follow daily routine during expedition training.

**IMPORTANCE**

It is important for cadets to understand the procedures involved in selecting a campsite and the routine that is to be followed during the occupation of that campsite. The departure routine is equally important in order to maintain organization and safety. The information in this lesson will assist the cadets during all corps exercises and expedition training.

**Teaching Point 1****Demonstrate Campsite Selection**

Time: 10 min

Method: Demonstration



The information in this TP has been previously taught. Instructors should demonstrate campsite selection in an area that will allow cadets to recognize the tasks involved.



When selecting a campsite, ensure permission is obtained from the park authority. Failure to do so could result in fines being issued by provincial or federal parks officers.

Determining the suitability of a campsite is key to the enjoyment of the time spent there. After a long day it is important that the cadets take the extra few minutes to choose an appropriate campsite.

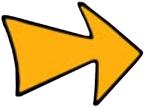

Great campsites are found, not made. At the end of a day of travel take the pack off, put on a warm layer and drink something, eat if low on energy, then look for a good campsite. It is important that there is not a lot of time spent on this task.

**DETERMINING THE SUITABILITY OF A CAMPSITE****Absence of Potential Hazards**

**Fallen Trees/Branches.** Look up and around the campsite. Is there a potential for limbs of trees to fall on the tent or campsite?

Care must be taken as the cadets can easily trip over fallen trees/branches. A sharp branch can also cause damage to equipment such as tents and groundsheets. Tent sites should not be set up where fallen trees are present. However, fallen trees can mark boundaries, hold signs and help weatherproof a site.

Areas with dead trees should be avoided. Dead trees lack strength and therefore should not be in the area when considering a campsite. These trees can easily fall during high winds and storms. Also, look closely for any branches that may fall.





*"Colby-Sawyer College", Kelsy Forest Walk, Copyright 2007. Retrieved November 22, 2007, from [www.colby-sawyer.edu/images/image\\_9614.jpg](http://www.colby-sawyer.edu/images/image_9614.jpg)*

Figure 16-8-1 Fallen Trees

**Poisonous Plants.** Always look for poisonous plants prior to setting up a campsite. Common poisonous plants such as poison ivy, poison sumac and poison oak were identified in EO M121.05 (Recognize Environmental Hazards, A-CR-CCP-701/PF-001, Chapter 10, Section 5). Contact with poisonous plants will cause severe itching of the skin, red inflammation and blistering. Keep campsites away from areas containing poisonous plants.

**Insects, Beehives and Hornet's Nests.** Most insects are a nuisance rather than a danger. When bothered by insects like mosquitoes, blackflies and deer flies/chiggers, hikers have several options available to thwart such nuisances and reduce exposure by controlling their surroundings. Try to avoid camping areas with tall grass, weeds and standing water where insects are abundant.

In the field, beehives and hornet's nests can be found in trees, shrubs and even in the ground. When nests are disturbed, bees and hornets will get defensive and sting. Always look for beehives and hornet's nests before setting up a campsite. A good sign that a hive or nest is nearby is when a large number of bees or hornets are flying around.



*P. Tawrell, Camping and Wilderness Survival, Paul Tawrell (p. 898)*

Figure 16-8-2 Hornet's Nest

**Ant Hills.** Once disturbed, ant hills can become a big nuisance. Check the ground for ant hills prior to setting up a campsite.

**Animal Dens.** Prior to setting up a campsite, look for any areas that may be near animal dens. A group of cadets could easily disturb resting animals. A den may be found on a trail or at the end of a trail in the field.

### **Accessible Water**

There should be an accessible water point within 60 m (200 feet) of the campsite. When in the wilderness, water sources can become contaminated very easily by such things as soap and feces.

Distancing the campsite from the accessible water point is an important step to ensure that contaminants from cooking and human waste do not pollute the water.

### **Space for Tents**

There should be enough space for all tents and they should not have guy lines overlapping each other. Ideally, tents should be roughly 5 m (15 feet) away from each other to avoid this.

## DETERMINING THE CAMPSITE LAYOUT

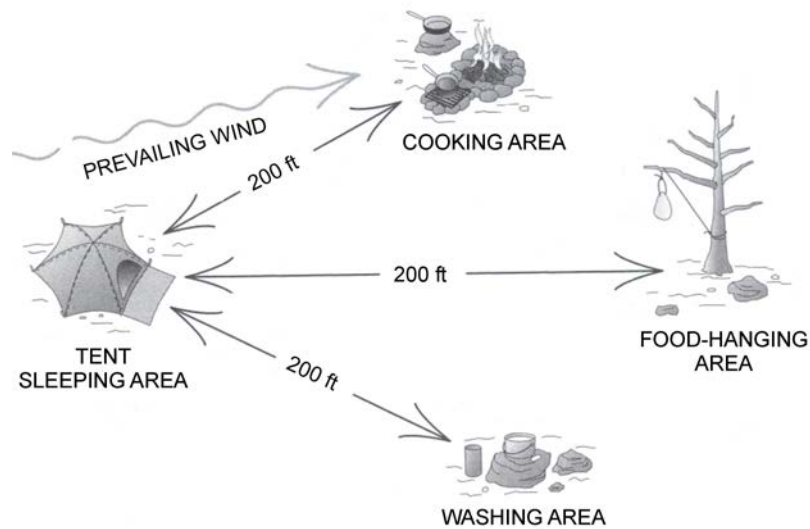

*R. Curtis, The Backpackers Field Manual, Three Rivers Press (p 113)*

Figure 16-8-3 Common Campsite Layout

### Sleeping Area

Above all, the sleeping area should be upwind of the cooking area. Flat ground works best. If there is a slight angle in the ground, it is best to lie with the head uphill.

There may be many cadets in the field at any given time. It is important that tents are spread out. In both the male and female lines, tents should be spaced at least 5 m apart. Where guy lines exist, there must be adequate space between tents so the cadets can easily walk without stepping over lines.

By spacing tents a small distance apart, the cadets are provided with privacy, while still being able to easily communicate.



When night falls, shelters may be hard to see. When shelters are close together there is a greater chance of having an accident, such as tripping over guy lines.

It is a good idea to mark the guy lines with flagging tape or Glow Sticks.

### Washroom/Latrine

Whenever possible, existing outhouses should be used. The smell in existing outhouses may be concentrated, but using them instead of catholes all over the area, will minimize the impact on the environment.

Washrooms/latrines are often the most uncomfortable thing to set up when camping. If group members will be using individual catholes, each cathole should be at least 60 m (200 feet) from water sources. In addition to the distance, the group should establish a route out of the campsite which the group will use.

In a group setting, it is best to set up a toilet and then pack out the waste. A group latrine should be downwind at least 60 m (200 feet) from the sleeping area as well as any trails or water sources.

## Cooking Area

This is the area where most campers will spend the majority of their time. Naturally, the cooking area is popular due to the time spent cooking, washing dishes or eating a quick snack.

The best cooking area location is a durable surface such as a large flat rock or sandy area. If a durable surface cannot be found, meadow grass or gravel are the next best choices.

In some situations it may be beneficial to set up a separate area for eating. This is recommended for larger groups to prevent people from milling around hot stoves and boiling water, which are a primary source of accidents. The eating area can be just metres away.

## Fire Area

Be aware of the fire regulations in the area being used. Certain times, especially late summer when forest fires are likely, there are often fire restrictions.



Discuss how the Fire Weather Index and the Canadian Forest Fire Danger Rating System (CFFDRS) measures the possibility of forest fires.

Pay attention to any individuals who may exhibit bad habits when dealing with fire and work to correct their bad habits.

Safety is paramount when lighting a fire. Be sure fire safety equipment is available when lighting fires.

Parks commonly follow the Fire Weather Index, which provides an assessment of relative fire potential that is based solely on weather observations. Check with park administration for rules and regulations when planning to light fires within the park boundaries.

## Canadian Forest Fire Danger Rating System (CFFDRS)

The CFFDRS is Canada's national system for rating forest fire danger. The system evaluates and integrates data to help managers predict woodland fire potential.

The CFFDRS provides an index (see Figure 16-8-1) on how easy it is to ignite vegetation, how difficult a fire may be to control, and how much damage a fire may do.

BLUE	GREEN	YELLOW	ORANGE	RED
LOW	MODERATE	HIGH	VERY HIGH	EXTREME

*Director Cadets 3, 2007, Ottawa, ON: Department of National Defence*

Figure 16-8-4 CFFDRS Fire Index

**Low.** Low chance of fires occurring. Fires that do occur are likely to be self-extinguishing and new ignitions are unlikely.

**Moderate.** Moderate chance of fires starting. These fires are creeping or gentle surface fires. They are easily contained by ground crews with water pumps.

**High.** High chance of fire starting. These fires are challenging for ground crews to handle and heavy equipment (tanker trucks and aircraft) are often required to contain the fire.

**Very High.** Very high chance of a fire starting. These fires are fast spreading and are of high intensity. They are hard to control and require aircraft support.

**Extreme.** The environment is very dry and chances of fire are extreme. These fires are fast spreading, of high intensity and very difficult to control.

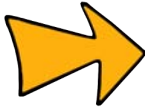

Advise cadets they can review this information for themselves by looking up the CFFDRS on the Internet for their area at <https://nofc1.cfsnet.nfis.org/mapserver/cwfis/index.phtml>.

Check for existing fire rings. Building a fire in a new spot all the time is damaging to the environment. Incorrectly built fires sterilize the soil below the fire, and it will take years before something can grow there again.

### Food Storage Area

The food storage area should be a minimum of 60 m (200 feet) from the sleeping area. When possible, a food hang should be used.

### Equipment Drying Area

A drying line should be put up within the sleeping area but not where members of the group could run into it or get caught up on it.

---

## CONFIRMATION OF TEACHING POINT 1

---

### QUESTIONS

- Q1. What should be taken into consideration when choosing a campsite?
- Q2. Describe the common campsite layout.
- Q3. Where is the best place to put the cooking area?

### ANTICIPATED ANSWERS

- A1. Absence of potential hazards, accessible water and space for tents should all be considered when choosing a campsite.
- A2. The common campsite layout includes the sleeping area, latrine/washroom, cooking area, fire area, food storage area and equipment drying area.
- A3. The best place to put a cooking area is on a durable surface such as a large flat rock or sandy area.

---

### Teaching Point 2

### Discuss Campsite Set-Up Routine

Time: 5 min

Method: Interactive Lecture

---



This TP details the process of elements of the campsite set-up when on expedition training. Upon arrival at a suitable area, this process should be established to set up the campsite. All the cadets will have the opportunity to follow the process by delegating their peers to assist. Group work should be utilized whenever possible to keep the cadets active.

## CAMPSITE SET-UP ROUTINE



The following is a sample routine that can be used when the cadets are tasked to lead a campsite set-up. These cadets will have selected the campsite and will delegate a section to complete the following tasks.

- All the cadets will set up their tents.
- Two cadets will locate and build a food hang.
- One cadet will identify and set up the cooking area and begin preparations for a meal.
- Two cadets will identify and set up the equipment drying area.
- Two cadets will purify water for cooking and drinking.
- Two cadets will gather firewood and set up the fire.
- One cadet will mark washrooms/latrines.

When these tasks have been completed, the entire section will gather for further instruction.

### Organizing and Erecting Tents

The first step of the campsite set-up routine is to identify the sleeping area where the tents will be set up. Distinguish an area for males and females that is a minimum of 15 m apart. All the cadets should set up the tents upon arrival.



Erecting a tent was taught in EO M121.07 (Erect a Group Tent, A-CR-CCP-701/PF-001, Chapter 10, Section 7).

### Setting up a Food Hang

Immediately upon arrival at the campsite, the food hang should be set up a minimum of 60 m (200 feet) from the sleeping area. A few members of the group should be tasked to set up the food hang so that everyone can hang their food bags when other tasks are completed.

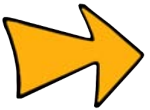

The preferred method of constructing a food hang is:

1. Find a tree with a live branch a minimum of 10 cm (4 inches) in diameter.
2. Throw a weighted rope over the branch.
3. Pull about two-thirds of the rope over the branch.
4. Attach the food bag to one end of the rope and haul it up as high as possible.
5. Tie the loose end of the rope to the trunk of the tree.

To retrieve the bag, untie the end tied to the tree and lower the bag to the ground.





An alternate method of constructing a food hang is taught in C121.01 (Construct Field Amenities, A-CR-CCP-701/PF-001, Chapter 10, Section 10).



In established campsites, bear boxes or bear poles may be available to store food. When available, these are the preferred methods of protecting food.

### Establishing a Cooking Area

The cooking area will remain the same during the entire time the group occupies the site. One or two cadets will be required to set up this area.

### Setting up a Clothesline

A clothesline should be set up close to the sleeping area. Two cadets will be required to set up the clothesline.



If there is no drying area available, a drying rack can be constructed using the method taught in EO C121.01 (Construct Field Amenities, A-CR-CCP-701/PF-001, Chapter 10, Section 10).

### Collecting Water

The best source of water will come from a fast moving stream. Avoid collecting water near livestock, human activity or from still water sources such as a small lake or pond. Muddy rivers are also poor sources of water.

Treat most water with suspicion. Boil the water for a minimum of 5 minutes adding 1 minute for every additional 300 m (1000 feet) in elevation. Whenever possible, use a water filter with micro-filtration systems to get rid of water-borne particles and viruses.



If the group plans to boil all collected water needed for the duration of the expedition, a greater amount of fuel will be required.

### Gathering Firewood

It is best practice not to have a fire. Around highly-used campsites, most deadfall and downed trees have already been burned. It is getting increasingly difficult to find fallen wood to use in campfires. If this is the case, it likely means group members will have to forage further away from the site.

### Starting a Fire

If using a fire, it should be started shortly before all other tasks are completed. Do not start a fire immediately on arriving at the site, as the fire will burn for no reason wasting valuable firewood.

### Marking the Washrooms/Latrines

The washrooms/latrines should be marked using flagging tape and Glow Sticks before night falls. A good practice is to hang Glow Sticks when setting up the facilities and when dusk falls, a member of the group can activate the Glow Stick.

## Cooking and Eating

A few group members should be assigned to oversee the cooking and other members of the group should clean up afterwards. Individuals will keep their food scraps with their garbage to keep the group waste smaller.



Hot water left on the stoves from meal time can be used for washing dishes or oneself later in the day. Water that has been used to cook Individual Meal Packages (IMPs) can be used for washing after the evening meal. It is important to ensure the water is used for washing only and not ingested.

---

### CONFIRMATION OF TEACHING POINT 2

---

#### QUESTIONS

- Q1. What tasks are done immediately upon arriving at a site?
- Q2. Where is the best source of water?
- Q3. When is a fire started?

#### ANTICIPATED ANSWERS

- A1. Setting up tents and setting up a food hang are done immediately upon arriving at a site.
- A2. The best source of water is from a fast moving stream.
- A3. A fire is started prior to most of the routine tasks being completed.

---

#### Teaching Point 3

#### Discuss Campsite Routine

Time: 5 min

Method: Interactive Lecture

---



This TP is intended to give an overview of the elements of campsite routine when occupying a campsite.

Tasks should be divided among the cadets to follow the established routine that will be followed throughout the time the group occupies that campsite.

#### CAMPSITE ROUTINE

It is important that every member of the group understands campsite routine and its importance. It is important to have a campsite routine in order to maintain control, keep equipment organized and maintain the safety of every member of the group.

#### Ensuring Personal and Group Equipment is Always Organized

It is essential that all personal and group equipment be secured at all times. It is the responsibility of the individual to ensure that the equipment they have brought is in good repair and that they are aware of where it is. It is good practice to prepare for an exercise in advance. As an example, at dusk, retrieve the headlamp and any other equipment required to negate the task of going through packs in the dark.



## Conforming to the Principles of Leave No Trace Camping

It is critical to ensure that the principles of Leave No Trace camping are followed. The Leave No Trace principles were covered in detail in EO M121.08 (Apply 'Leave No Trace' Camping, A-CR-CCP-701/PF-001, Chapter 10, Section 8). It is important to follow the Leave No Trace principles whenever training in the wilderness.

The principles of Leave No Trace camping are:

- Plan ahead and prepare.
- Travel and camp on durable surfaces.
- Dispose of waste properly.
- Leave what you find.
- Minimize campfire impacts.
- Respect wildlife.
- Be considerate of other visitors.

## Cooking and Eating

All aspects of cooking and eating will be completed within the cooking area.

Before cooking or handling any food, be sure that the person washes their hands thoroughly.

If extra pots are available, put water on the stove immediately after the meal has finished cooking. This water can be used for making hot drinks later in the day.

## Storing Garbage

Everything that goes into the field with the group, from socks to sunscreen, leaves the field with the group.

Keep track of individual garbage by storing it all in one bag. Keep the bag accessible within the pack in order to add to the waste whenever needed. This will negate putting apple cores and garbage into pack pockets. A bread bag or resealable plastic bag works well as a waste bag.



Ensure that all garbage is placed in the food hang at night.

## Dealing With Food Scraps

Pay close attention to and retrieve any pieces of food that are dropped on the ground. This includes crumbs.

Food scraps, including leftovers, should never be buried. Animals will dig as soon as they smell it. This could happen before leaving the campsite.



Remember: Any and all food waste should be packed out.

---

**CONFIRMATION OF TEACHING POINT 3**

---

**QUESTIONS**

- Q1. What does a campsite routine entail?
- Q2. What is the correct procedure for dealing with garbage?
- Q3. Why are food scraps not buried?

**ANTICIPATED ANSWERS**

- A1. Campsite routine entails:
- organizing individual and group equipment;
  - conforming to the principles of Leave No Trace camping;
  - cooking and eating;
  - storing garbage; and
  - dealing with food scraps.
- A2. The correct way to deal with garbage is to store it all in one re-sealable bag.
- A3. Food scraps should not be buried because animals will smell the scraps and dig them up.

---

**Teaching Point 4****Discuss Campsite Departure Routine**

Time: 5 min

Method: Interactive Lecture

---



This TP details a step-by-step process of the campsite departure when on expedition training or corps exercise.

The importance of having a routine is crucial here as there may be little time to complete the departure routine.

**CAMPSITE DEPARTURE ROUTINE**

The following is a sample routine that can be used when the cadets are tasked to lead a campsite departure. These cadets will delegate a section to complete the following tasks:

- All cadets will strike their tents.
- Two cadets will dismantle campsite amenities.
- All cadets will organize their personal equipment.
- Two cadets will purify water for drinking during travel.
- One cadet will dismantle the cooking area and remove any food waste.
- Two cadets will ensure fire is extinguished.
- One cadet will remove any markings from washrooms/latrines.
- One cadet will erase all signs of occupancy.

- One cadet and a staff member will conduct a final sweep.

When these tasks have been completed the entire section will gather for further instruction.

When leaving any campsite, the site should look like there was never anyone there. This includes biodegradable material like fruit and vegetable leftovers. These will still take a very long time to decompose.

### **Striking Tents**

It is advisable to leave the tents up a little longer in the morning to allow any condensation/water to dry before packing up.

To remove a tent from the campsite, one must first strip the tent site of all components belonging to the tent. Importance should be placed on removing pieces of string or rope that are used to tie down the structure. The sleeping surface should be returned to its original appearance (replacing sticks and stones removed for sleeping). Remove any left over garbage.

### **Dismantling Campsite Amenities**

If a clothesline or other amenities were built, they should be dismantled. Do not cut ropes and be sure to remove any rope from the tree entirely.

### **Organizing Personal Equipment**

Personal equipment should be packed shortly after waking, to ensure the task is completed and equipment is organized.



Pack all individual sleeping equipment prior to leaving the tent.

### **Dismantling Food Hang**

The food hang should be dismantled when packing up personal equipment to ensure that individuals have their food.

The immediate area of the food hang should be checked to ensure that no waste has been left behind.

### **Purifying Water**

Two cadets in the section shall be tasked to purify water for all members of the group to ensure everyone has a full canteen. This will also serve as a time management activity while packing.

### **Cooking and Eating**

All members of the group shall ensure they have eaten a meal relatively close to departure time and have packaged and put away all food waste.

### **Ensuring Fire is Fully Extinguished**

Extinguish a small fire by burning all the wood down to ash, then saturating the ash with water and scattering the ash broadly away from the campsite. Use a stick to stir up the ash and water. Stop burning the wood long before the requirement to put it out.



“Night logs” are not necessary as they will most likely only be half-burned in the morning.

## **Organizing Group Equipment**

Establish what equipment members of the group will be carrying. Sharing the load is advantageous for a few reasons: the weight is spread out, packs are less bulky and the group must communicate with each other in order to set up and tear down camp.

## **Erasing Signs of Occupancy**

Easy steps to erase the signs of occupancy:

1. Dismantle secondary fire rings at established campsites.
2. Disperse rocks and other natural objects to their original position.
3. Fluff the grass where tents were and fill in tent peg holes.
4. Use a fallen pine branch to sweep the sand and dirt of any footprints.

## **Conducting a Final Sweep of the Area**

Inspect the ground after all equipment has been packed to ensure nothing is hidden in the grass or buried. A final sweep of the area will include:

- checking tent areas;
- checking garbage has been picked up;
- ensuring latrine/washroom area is clean; and
- scattering ash once the fire is completely out by using a trowel.

If using a civilian campsite, try to make the site more appealing to users. This will keep them from going to find a 'wilder' site.

Pack out any garbage and waste that was left by previous campers.

---

## **CONFIRMATION OF TEACHING POINT 4**

---

### **QUESTIONS**

- Q1. When are the tents struck?
- Q2. Why should everyone understand the routine at a campsite?
- Q3. What is checked during the final sweep?

### **ANTICIPATED ANSWERS**

- A1. Tents are struck in the morning after waking. If tents are damp, they can be left a bit longer to dry out.
- A2. Campsite routine should be understood by everyone to ensure that the campsite can be set up quickly and efficiently.
- A3. During the final sweep, the following items are checked:
- tent areas;
  - garbage has been picked up;
  - latrine/washroom area is clean; and
  - ash is scattered once the fire is completely out by using a trowel.

---

**END OF LESSON CONFIRMATION**

---

**QUESTIONS**

- Q1. What are some hazards to be considered when choosing a campsite?
- Q2. What activities are completed when setting up a campsite?
- Q3. What are the elements of a campsite departure routine?

**ANTICIPATED ANSWERS**

A1. Hazards to consider are:

- fallen trees/branches,
- poisonous plants,
- insects, beehives and hornet's nests,
- ant hills, and
- animal dens.

A2. The activities to be completed are:

- organizing and erecting tents;
- setting up a food hang;
- establishing a cooking area;
- setting up a clothesline;
- collecting water;
- gathering firewood;
- starting a fire;
- marking the washrooms/latrines; and
- cooking and eating.

A3. The campsite departure routine is:

- striking tents;
- dismantling campsite amenities;
- organizing personal equipment;
- dismantling food hang;
- purifying water;
- cooking and eating;
- ensure fire is fully extinguished;
- organizing group equipment;
- erasing signs of occupancy; and
- conducting a final sweep of the area.

---

## CONCLUSION

---

### HOMEWORK/READING/PRACTICE

N/A.

### METHOD OF EVALUATION

This EO is assessed IAW A-CR-CCP-703/PG-001, Chapter 3, Annex B, Appendix 7 (326 PC).

### CLOSING STATEMENT

The ability to move from campsite to campsite in an efficient way is important as the cadets could arrive at a campsite late in the day with minimum light and have to leave early the next morning. The key to an efficient routine is work and time management. These skills will assist the cadets in corps exercises and expedition training.

### INSTRUCTOR NOTES/REMARKS

Personal and group expedition equipment is outlined in PO 326 (Perform Expedition Skills).

The knowledge presented in this EO will enhance the cadets' participation in daily routine as part of the expedition training experience.

This EO has been allocated one period in the overall course period allocation. Each expedition centre may adjust this allocation to reflect the choice of activities, facilities and available resources at the expedition centre.

Timings for this EO will vary. While there is a requirement for some initial training, the focus should be on having the cadets practice hiking techniques through practical application.

---

## REFERENCES

---

- C2-009 (ISBN 0-684-85909-2) Harvey, M. (1999). *The National Outdoor Leadership School's Wilderness Guide*. New York, NY: Fireside Books.
- C2-011 (ISBN 0-89886-910-2) McGivney, A. (2003). *Leave No Trace: A Guide to the New Wilderness Etiquette* (2<sup>nd</sup> ed.). Seattle, WA: The Mountaineers Books.
- C2-016 (ISBN 1-4000-5309-9) Curtis, R. (2005). *The Backpackers Field Manual*. New York, NY: Three Rivers Press.
- C2-051 (ISBN 978-0-7153-2254-3) Bagshaw, C. (2006). *The Ultimate Hiking Skills Manual*. Cincinnati, OH: David & Charles.



**ROYAL CANADIAN ARMY CADETS**  
**SILVER STAR**  
**INSTRUCTIONAL GUIDE**



**SECTION 9**  
**EO M326.07 – RECORD ENTRIES IN A JOURNAL**

---

Total Time: 30 min

---

**PREPARATION**

---

**PRE-LESSON INSTRUCTIONS**

Resources needed for the delivery of this lesson are listed in the lesson specification located in A-CR-CCP-703/PG-001, Chapter 4. Specific uses for said resources are identified throughout the instructional guide within the TP for which they are required.

Review the lesson content and become familiar with the material prior to delivering the lesson.

Photocopy Annex A and distribute to each cadet.

**PRE-LESSON ASSIGNMENT**

N/A.

**APPROACH**

An interactive lecture was chosen for TPs 1 and 2 to introduce the journal and present background information.

A practical activity was chosen for TP 3 as it is an interactive way to provoke thought and stimulate interest in the journal.

---

**INTRODUCTION**

---

**REVIEW**

N/A.

**OBJECTIVES**

By the end of this lesson the cadet shall have recorded entries in a journal during expedition training.

**IMPORTANCE**

It is important for cadets to understand the importance of recording entries in a journal, especially during expedition training. Completing entries in a journal records the cadet's involvement, not just their participation in the training. These entries provide a link between the knowledge learned throughout training and the direct experiences the cadet had.

**Teaching Point 1****Discuss Journals**

Time: 5 min

Method: Interactive Lecture



This TP will take place in the evening while at the Expedition Centre. Team Instructors (TI) should ask the cadets to reflect on their previous experiences using journals.

Discuss how the cadets feel about previous experiences using a journal.

The cadets will be required to record entries in the journal during the evenings at the expedition centre.

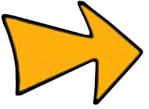

When completing Leadership and Challenge, senior expeditions and international expeditions, cadets are required to keep a journal.

**DIFFERENCE BETWEEN A JOURNAL, LOG AND RECORD BOOK**

Journals, logs and record books are methods of recording information. Each records information about the expedition experience, from a different perspective.

**Journals.** Record personal thoughts, reactions to experiences, personal learning, and the participant's awareness of what happened in an experience. They are forms of expression that provide an avenue for reflection that is much different than speaking. Journals help people reflect on self-discovery, group dynamics, sense of place and professional development. They do not have a set format and can be a creative expression of the writer tying together experience and learning.

Some people who are reluctant to speak in front of a group find journals provide a place to express what is on their mind. Journals help open the thought process for some individuals, allowing them to speak freely about their entries at a later date.

**Log.** Logs are a written record of facts and events on a trip or activity. Logs contain information on what activities were accomplished and any incidents that took place. Logs also record factual information such as distance travelled, weather conditions, flora, fauna, wildlife encounters and campsite locations.

Logs are more formal forms of record keeping than journals and can often serve as legal documents in emergencies and critical incidents.

**Record Book.** A structured, fill-in-the-blanks document used to record the completion of specific training, skills and depth of experience.

**THE PURPOSE OF JOURNALS**

The purpose of journals is to allow the participant to record thoughts, feelings and experiences that allow the individual to grow and develop as a person.

**TYPES OF JOURNALS**

In addition to an individual's reflective journal, there are other journals which can be used in training. Examples of these are:

**Group Journals.** This type of journal is shared among participants. Each person takes a turn logging their impressions, thoughts and experiences. A person may also comment on someone else's entry. This type of



journal assists in fostering group cohesion and creativity. Issues may be brought to the attention of the whole group or used as topics during group reflection.

**Project Journals.** This type of journal has entries that are related to a future project to be accomplished by an individual or by the entire group. It is often used for long-term experiences and provides participants the opportunity to reflect on the process of working on a project.



Have the cadets brainstorm instances when each type of journal could be used.

## JOURNAL ENVIRONMENT

The environment in which entries are recorded in a journal is of the utmost importance. In general, the journal environment should:

- provide each cadet with a minimum of 20 uninterrupted minutes;
- account for cadets who will require more than 20 minutes to complete an entry (eg, no training should be completed directly after);
- provide each cadet enough space to be free from other cadets; and
- allow each cadet to express their thoughts wherever they wish within a given set boundaries.



Journals should be thought of as public documents. References that are made to or about other people must be made in a respectful and positive manner.

---

## CONFIRMATION OF TEACHING POINT 1

---

### QUESTIONS

- Q1. What is a journal?
- Q2. What is a log?
- Q3. What is a project journal?

### ANTICIPATED ANSWERS

- A1. A journal records personal thoughts and reactions to experiences and personal learning, and creates awareness of what happened in an experience. It is a form of expression that provides an avenue for reflection that is much different than speaking. Journals help people reflect on self-discovery, group dynamics, sense of place and professional development.
- A2. A log is a written record of facts and events on a trip or activity. Logs contain information on what activities were accomplished, and any incidents that took place. Logs also record factual information such as weather conditions, flora, fauna, wildlife encounters and campsite locations.
- A3. This type of journal has entries that are related to a future project to be accomplished by an individual or by the entire group.

**Teaching Point 2****Describe a Journal**

Time: 10 min

Method: Interactive Lecture



The Silver Star expedition journal uses both journal and log information in order to train cadets on the functions of recording information.

The purpose of the Silver Star expedition journal is threefold:

1. The journal will provide cadets with a training experience where they will take time to record personal experiences.
2. The journal will serve as a record of the cadets involvement in local expedition training. It will provide the link between the Army Cadet Program and their expedition experiences.
3. The journal will familiarize cadets with a new tool for their lives.

**IMPORTANCE**

Historically, logs and journals recorded a journey. Since then, they have been widely adopted among educators as a means of documenting personal development. The importance of a journal is to record activities and provide a chronological record of one's outdoor experiences which can serve as a tool for reflection on experience. The silver star expedition journal introduces elements of logs and journals.

**INFORMATION REQUIRED IN THE SILVER STAR EXPEDITION JOURNAL**

Information required in the journal includes:

**Day and Date.** The day of the trip. (eg. Day 2 of a 2 day trip) and the calendar date.

**Mode of Travel.** Record the mode of travel. How is the group travelling? Is the group hiking, biking or canoeing?

**Time.** Record the time the group woke up and went to bed. This will give a record of how long the days were. Record the start and finish time of the activity. This will be useful when debriefing and completing any reports required. It will also give an accurate estimate of the time required to make the trip at a given time of year (eg, canoeing in the spring will be faster than in the fall due to the melting snow).

**Start and End Location.** Record the start and end locations for the day. This should be a precise grid reference but can also be a description of the area.

**Distance and Campsite Grid Reference (GR).** The total distance travelled throughout the day and the grid reference of the campsite for the night.

**Route Travelled.** A chart with columns for the name of the trail or route, time it took to complete the section, how many kilometres the route was and a physical description of the route. The description could include any sections on the route that were difficult, if there were obstacles on sections, and the state of the trail.

**Campsite Description.** A description of the campsite and the area surrounding it. Does it require maintenance? Are there any special characteristics about it? Sufficient number of tent sites?

**Weather.** A written description of the weather including the temperature, cloud cover, wind speed, direction and a prediction for the short term.

**Personal Goals.** This is the place to set personal goals for the day and for the next day or few days.

**Where Can I Use This Training?** Is the training useful? Will the training be used in the future? Record where the training could be used and how it will benefit you.

**Best Thing of the Day/Worst Thing of the Day/My Best Moments.** A short description of the best and worst parts of the day and feelings felt.

**Personal Reflections and Observations.** Include anything with regard to the trip itself. Notes on weather, animals, and significant events can also be added. This is also a great place to record recurring themes and assess personal involvement. Incorporate any personal reflections or other observations not covered in other sections.

## CONFIRMATION OF TEACHING POINT 2

### QUESTIONS

- Q1. Why are journals so important?
- Q2. What is recorded in the times section?
- Q3. What goes into the personal reflections section?

### ANTICIPATED ANSWERS

- A1. The importance of a journal is to record activities and provide a chronological record of one's outdoor experiences which can serve as a tool for showing a person's depth of experience.
- A2. The times section records time the group woke up and went to bed. This will give a record of how long the days were and the start and finish time of the activity. This will be useful when debriefing and completing any reports required. It will also give an accurate estimate of the time required to make the trip at a given time of year (eg, canoeing in the spring will be faster than in the fall due to the melting snow).
- A3. The personal reflection section is for any observation or thoughts not recorded in any other section.

### Teaching Point 3

### Have the Cadets Record Entries in a Journal During an Expedition

Time: 10 min

Method: Practical Activity

## ACTIVITY

### OBJECTIVE

The objective of this activity is to familiarize the cadet with the Silver Star Expedition Journal. During expedition training cadets will make two entries in their journals.

### RESOURCES



A variety of resources may be used during this activity. The writing and marking materials are not limited to this list.



There are many pages to the journal, although only the structured information page is covered within this lesson. The remainder of the journal is for free flowing thought.

- Silver Star Expedition Journal located at Annex A, and
- Pencils/pens.

### ACTIVITY LAYOUT

N/A.

### ACTIVITY INSTRUCTIONS

TIs will facilitate the journal activity as a group while cadets record comments into their own journals.

1. Distribute a journal located at Annex A to each cadet.
2. Have each cadet read and become familiar with the journal. Introduce the journal, which includes:
  - (a) a front page;
  - (b) a page of possible ideas that will provoke thoughts for writing during training;
  - (c) daily pages (one of which is to be completed each day following completion of training);
  - (d) one extra page to be used after the expedition for any final thoughts or ideas that occurred throughout or after training; and
  - (e) a page for sketches, to be completed after expedition training.
3. Have the cadet record entries.

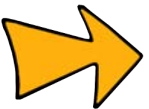

Within the journal, the page of possible ideas should be used as a guide, especially if a cadet is experiencing difficulty deciding what to write. Each entry should have a common theme.

### SAFETY

N/A.

---

### CONFIRMATION OF TEACHING POINT 3

---

The cadets' participation in the activity will serve as the confirmation of this TP.

---

### END OF LESSON CONFIRMATION

---

The cadets' participation in recording entries in a journal will serve as the confirmation of this lesson.

---

**CONCLUSION**

---

**HOMEWORK/READING/PRACTICE**

N/A.

**METHOD OF EVALUATION**

This EO is assessed IAW A-CR-CCP-703/PG-001, Chapter 3, Annex B, Appendix 7 (326 PC).

**CLOSING STATEMENT**

Recording entries in a journal is a way for the cadets to express themselves and reflect freely, without speaking. There will always be individual differences within every group and a journal allows the cadets to express themselves using a variety of means. After expedition training, all the cadets will be given time to reflect on their expedition experiences.

**INSTRUCTOR NOTES/REMARKS**

The cadet will make two entries in the journal while at the expedition centre.

This EO has been allocated one period in the overall course period allocation. Each expedition centre may adjust this allocation to reflect the choice of activities, facilities and available resources at the expedition centre.

---

**REFERENCES**

---

C2-109 (ISBN 0-7872-6561-6) Sugerman, D., Dohery, K., Garvey, D., & Gass, M. (2000). *Reflective Learning: Theory and Practice*. Dubuque, IO: Kendall/Hunt Publishing Company.

THIS PAGE INTENTIONALLY LEFT BLANK

SILVER STAR EXPEDITION JOURNAL



# AUTOGRAPHS

Expedition Name: \_\_\_\_\_

Course: \_\_\_\_\_

Dates: \_\_\_\_\_

Participant List:

\_\_\_\_\_  
\_\_\_\_\_  
\_\_\_\_\_  
\_\_\_\_\_  
\_\_\_\_\_  
\_\_\_\_\_  
\_\_\_\_\_  
\_\_\_\_\_  
\_\_\_\_\_  
\_\_\_\_\_  
\_\_\_\_\_  
\_\_\_\_\_  
\_\_\_\_\_  
\_\_\_\_\_  
\_\_\_\_\_





**Individual Trip Journal**

1. Day: \_\_\_\_\_ Date: \_\_\_\_\_  
Mode of Travel (canoe, bike, hike): \_\_\_\_\_
2. Time: Wake up: \_\_\_\_\_ Bedtime: \_\_\_\_\_  
Time: On Route: \_\_\_\_\_ Off Route: \_\_\_\_\_
3. Start Location: \_\_\_\_\_  
End Location: \_\_\_\_\_
4. Distance: \_\_\_\_\_ Campsite GR: \_\_\_\_\_
5. Route Travelled: \_\_\_\_\_

Name of Route (trail, lake, river, portage)	Time	Km	Description

6. Campsite Description:

7. Weather:

8. Personal Goals:

9. Where can I use this training?:



10. Best Thing of the Day/Worst Thing of the Day, My Best Moments:

11. Personal Reflections and Observations (natural environment, leadership, personal involvement, recurring themes):

(Copy enough pages for each day of the expedition activity)

**Possible ideas:**

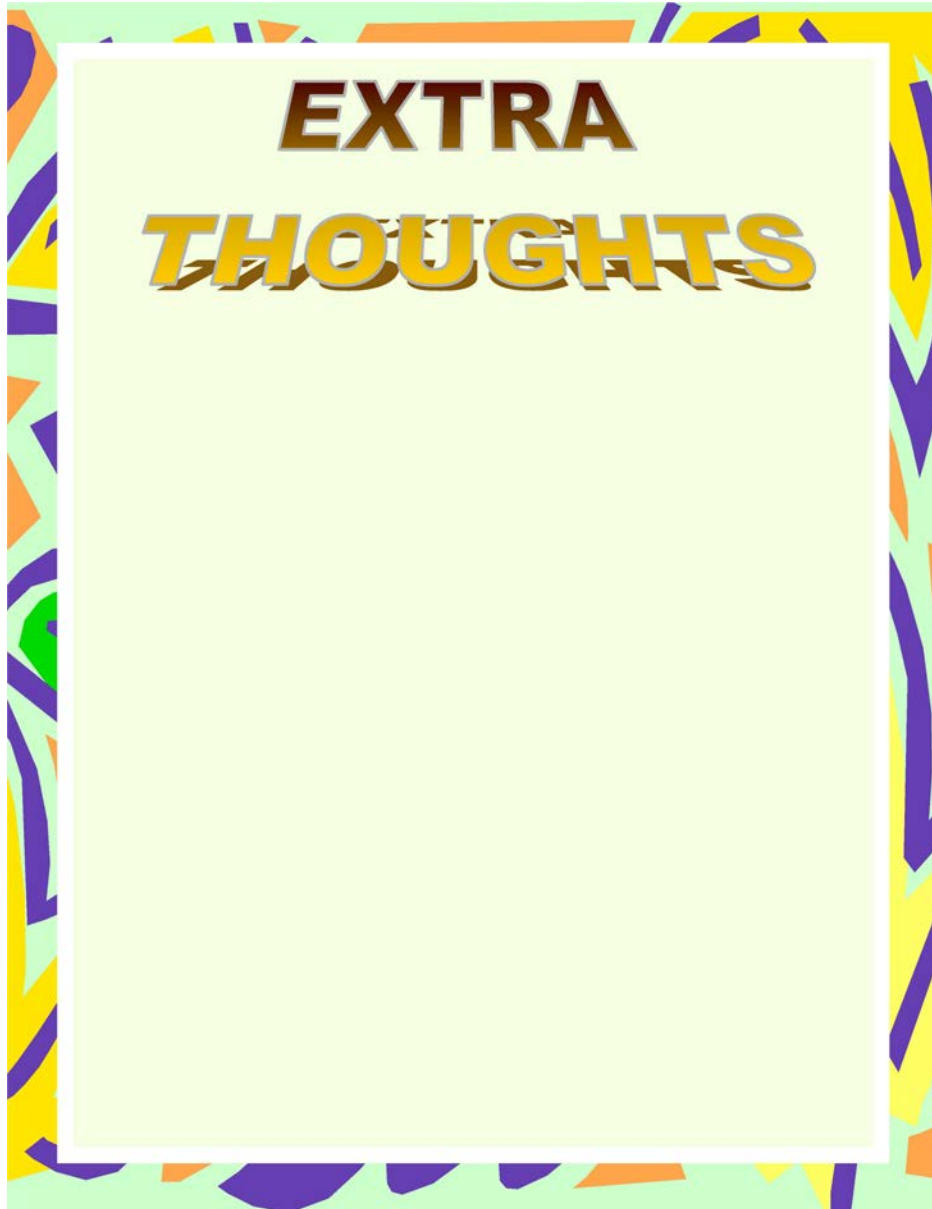
- Feelings that occur on an expedition,
- Thoughts on leadership during an expedition,
- Feelings about acting as a leader,
- Seeing peers act as a leader,
- Leadership of the staff,
- Accomplishments at the end of the day,
- Challenges,
- Barriers or conflicts the group is facing,
- Teamwork when canoeing,
- Navigation and hiking,
- Mountain biking,
- Concern about the activities for tomorrow,
- Responsibility to peers,
- Responsibility to the environment,
- Learning from mistakes,
- I could be doing something different with my summer,
- The importance of teamwork on an expedition,
- Future opportunities at the corps, and



THIS PAGE INTENTIONALLY LEFT BLANK