

MCM TRAUMA LINE

Interlocking Nailing Systems

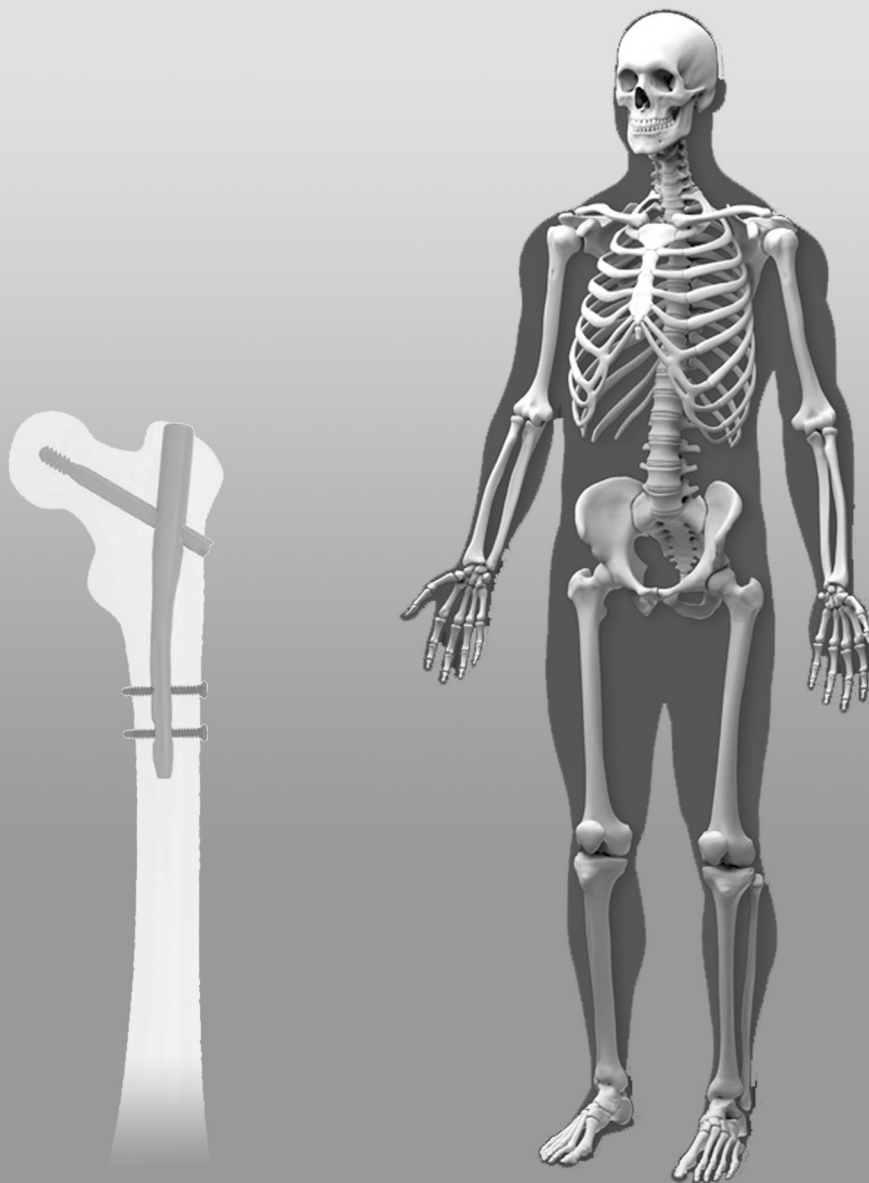

Introducing Ourselves

Manufacturer of surgical implants and medical devices. Solutions for patient orthopaedic and osteosyntheses fracture treatments, osteosyntheses customized orthopaedic innovations and solutions.

Corporate company philosophy

- Plate and screw systems (mini, small and large fragment systems)
- Locking plate and screw systems (small and large fragment systems)
- Interlocking nailing systems
- Cranio maxillo facial plate and screw systems
- Cannulated screw system
- Flexible reamer systems
- Hand and Foot implants (screws and staple systems)
- External fixator systems
- Oscillating saw blades
- Power tool systems, battery and air drive systems
- General surgical instruments
- Hemi arthroplasty instruments for hip surgeries and cement extraction

\\ 01 "UNO" Tibial Interlocking Nail



\\ 02 "Esperto" Tibial Interlocking Nail



\\ 03 "Comodo Shape" Tibial Interlocking Nail



\\ 04 "UNO" Femoral Interlocking Nail



\\ 05 "UNO Multi-13mm" Femoral Interlocking Nail



\\ 06 "UNO Multi-15mm" Femoral Interlocking Nail



\\ 07 "Esperto-Reco" Femoral Interlocking Nail



\\ 08 "Comodo" Femoral Interlocking Nail



\\ 09 "UNO Tro-16mm" Trochanteric Interlocking Nail



mc medizintechnik



"Esperto Gama" Gamma
Interlocking Nail

10 //



"Comodo Gama" Gamma
Interlocking Nail

11 //



"UNO Condo" Femoral
Interlocking Nail

12 //



"UNO Omero" Humeral
Interlocking Nail

13 //



"Comodo Omero" Humeral
Interlocking Nail

14 //



"UNO Raggio" Ulna-Radius
Interlocking Nail

15 //



"UNO" Elastic Nail

16 //



Flexible Reamer System

17 //



Interlocking Nail Systems
Instruments and Devices

18 //



mc medizintechnik

\\ 01

"UNO" Tibial Interlocking Nail



MCM Pro."UNO" Tibia Int. Nail ST.STEEL

Length Länge	Dia	Stainless steel Rostfreier Stahl
270mm	8mm	19-200-0827
285mm	8mm	19-200-0828
300mm	8mm	19-200-0830
315mm	8mm	19-200-0831
330mm	8mm	19-200-0833
345mm	8mm	19-200-0834
360mm	8mm	19-200-0836
380mm	8mm	19-200-0838
400mm	8mm	19-200-0840
420mm	8mm	19-200-0842
270mm	9mm	19-200-0927
285mm	9mm	19-200-0928
300mm	9mm	19-200-0930
315mm	9mm	19-200-0931
330mm	9mm	19-200-0933
345mm	9mm	19-200-0934
360mm	9mm	19-200-0936
380mm	9mm	19-200-0938
400mm	9mm	19-200-0940
420mm	9mm	19-200-0942
440mm	9mm	19-200-0944
270mm	10mm	19-200-1027
285mm	10mm	19-200-1028
300mm	10mm	19-200-1030
315mm	10mm	19-200-1031
330mm	10mm	19-200-1033
345mm	10mm	19-200-1034
360mm	10mm	19-200-1036
380mm	10mm	19-200-1038
400mm	10mm	19-200-1040
420mm	10mm	19-200-1042
440mm	10mm	19-200-1044

for \varnothing 4.5 mm Locking Screws prox.for \varnothing 4.5 mm Locking Screws distal

Length Länge	Dia	Stainless steel Rostfreier Stahl
285mm	11mm	19-200-1128
300mm	11mm	19-200-1130
315mm	11mm	19-200-1131
330mm	11mm	19-200-1133
345mm	11mm	19-200-1134
360mm	11mm	19-200-1136
380mm	11mm	19-200-1138
400mm	11mm	19-200-1140
420mm	11mm	19-200-1142
285mm	12mm	19-200-1228
300mm	12mm	19-200-1230
315mm	12mm	19-200-1231
330mm	12mm	19-200-1233
345mm	12mm	19-200-1234
360mm	12mm	19-200-1236
380mm	12mm	19-200-1238
400mm	12mm	19-200-1240
420mm	12mm	19-200-1242
285mm	13mm	19-200-1328
300mm	13mm	19-200-1330
315mm	13mm	19-200-1331
330mm	13mm	19-200-1333
345mm	13mm	19-200-1334
360mm	13mm	19-200-1336
380mm	13mm	19-200-1338
300mm	14mm	19-200-1430
315mm	14mm	19-200-1431
330mm	14mm	19-200-1433
345mm	14mm	19-200-1434
360mm	14mm	19-200-1436
380mm	14mm	19-200-1438

for \varnothing 5.0mm Locking Screws prox.for \varnothing 5.0mm Locking Screws distal

**Locking Screw Dia. 4.5mm,
for MCM Pro."UNO" Tibia Int. Nail ST.STEEL**



Length Länge	Code
20mm	19-201-4520
25mm	19-201-4525
30mm	19-201-4530
35mm	19-201-4535
40mm	19-201-4540
45mm	19-201-4545
50mm	19-201-4550
55mm	19-201-4555
60mm	19-201-4560
65mm	19-201-4565

**Locking Screw Dia. 5.0mm,
for MCM Pro."UNO" Tibia Int. Nail ST.STEEL**



Length Länge	Code
25mm	19-202-5025
30mm	19-202-5030
35mm	19-202-5035
40mm	19-202-5040
45mm	19-202-5045
50mm	19-202-5050
55mm	19-202-5055
60mm	19-202-5060
65mm	19-202-5065
70mm	19-202-5070
75mm	19-202-5075
80mm	19-202-5080
85mm	19-202-5085
90mm	19-202-5090

**Locking Screw Dia. 4.5mm,
for MCM Pro."UNO" Tibia Int. Nail ST.STEEL**



Length Länge	Code
25mm	19-203-5025
30mm	19-203-5030
35mm	19-203-5035
40mm	19-203-5040
45mm	19-203-5045
50mm	19-203-5050
55mm	19-203-5055
60mm	19-203-5060
65mm	19-203-5065

**Nail Cap for MCM Pro."UNO" Tibia Int. Nail
ST.STEEL**



Code
19-204-1112

Basic Instrumentation Set for MCM Pro."UNO" Tibia Int. Nail

Set Code

19-999-010

**Graphic Case(QTY 3) for Set MCM Pro."UNO"
Tibia Int. Nail**

Code

19-998-020

**Container Alum. 285x280x150mm silver Lid
perforated / Bottom non-perforated**

Code

19-998-030

Container for Set 19-999-100

Code

19-998-010

**Screw Box f. Locking Screws and Screwed
Plugs (empty)**

Code

19-998-040

Universal Socket Wrench

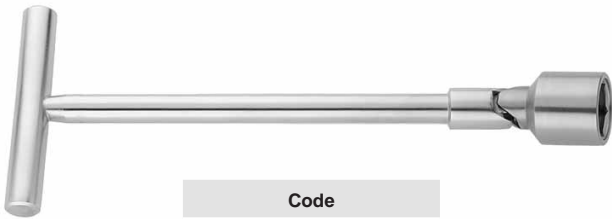

Code
19-888-001

Screw Length Gauge



Code
19-888-007

Hex Driver



Item	Code
Hex Driver SW 3.5 for 4,5mm 5,0mm Interl. screws	19-888-002
Hexagon Driver for screws 6,4mm	19-888-003
Hex Driver cannul. f. dia 4,5 + 5mm	19-888-004

Radiolucent drill Bits cannul.



Dia Ø	Code
3.5mm	19-888-008
4.0mm	19-888-009
4.8mm	19-888-010

Medullary Exchange Tube



Code
19-888-005

Radiolucent drill Bits



Dia Ø	Code
2.7mm	19-888-011
3.5mm	19-888-012
4.0mm	19-888-013
4.8mm	19-888-014

Internal Fracture Alignment Device



Code
19-888-006

Twist Drill



Dia Ø	Code
3.5mm	19-888-015
4.0mm	19-888-016
4.8mm	19-888-017

Trocar dia 4,0mm x 240mm

Code

19-888-018

Tip Threaded Guide Pin 3,2mm x 305mm

Code

19-888-019

Guide Rod dia 1,8 x350mm

Code

19-888-020

Guide Rod for Reamer 2,4 x 900mm

Code

19-888-021

Guide Rod for Reamer 3,0mm x 900mm

Code

19-888-022

Guide Rod for Reamer 2,0 x 900 mm



Code
19-888-023

Guide Rod for Reamer 3,0 x 900mm



Code
19-888-024

Guide Rod for Reamer 3,0 x 900mm



Code
19-888-025

Guide Rod w. curvedTip 2,4 x 900mm



Code
19-888-026

Open End Wrench 17/14"



Code

19-888-027

Supine Driver

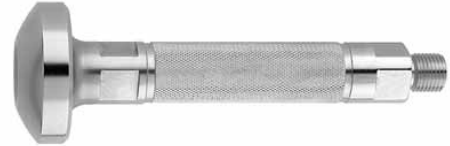

Code

19-888-030

Reamer Template

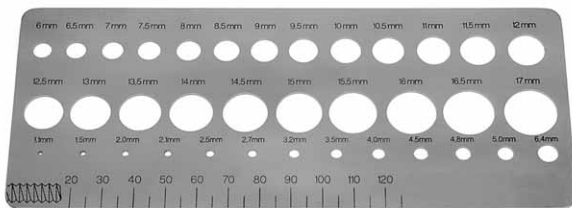

Code

19-888-028

T-Handle



Code

19-888-031

Nail Length Gauge



Code

19-888-029

Tibial Proximal Device



Code
19-888-032

Trocar Nail



Dia Ø	Code
3.2mm	19-888-035
4.0mm	19-888-036
4.8mm	19-888-037
8.0mm	19-888-038

Skin Protector



Code
19-888-033

Curved Awl



Code
19-888-034

**Reamer cannulated
dia 15,5 mm**

Code
19-888-039

**Tapered Reamer dia
13,5mm cannulated**

Code
19-888-040



Cannulated Reamer 9,0mm



Code

19-888-041



Drill Sleeve, green, 8,0 mm (long)

19-888-042



Drill Sleeve Silver 2,1 mm

19-888-043



Drill Sleeve blue 4,8 mm

19-888-044



Drill Sleeve Gold 4,0 mm

19-888-045



Drill Sleeve (black) 3,5 mm

19-888-046

Slide Hammer



Code

19-888-047

Tibal Extractor Bolt



Code
19-888-048

Bolt f. prox. DrillGuide ..



Code
19-888-051

Length Gauge



Code
19-888-049

Guide Rod dia 1,8 x350mm



Code
19-888-050

02

"Esperto" Tibial Interlocking Nail



MCM Pro. "Esperto" Tibial Interlocking Nail

Length Länge	Dia	Stainless steel Rostfreier Stahl	Titanium Titan	Length Länge	Dia	Stainless steel Rostfreier Stahl	Titanium Titan
250mm	8mm	19-105-0825	19-105-0825T	345mm	10mm	19-105-1034	19-105-1034T
270mm	8mm	19-105-0827	19-105-0827T	360mm	10mm	19-105-1036	19-105-1036T
285mm	8mm	19-105-0828	19-105-0828T	375mm	10mm	19-105-1037	19-105-1037T
300mm	8mm	19-105-0830	19-105-0830T	390mm	10mm	19-105-1039	19-105-1039T
315mm	8mm	19-105-0831	19-105-0831T	405mm	10mm	19-105-1040	19-105-1040T
330mm	8mm	19-105-0833	19-105-0833T	420mm	10mm	19-105-1042	19-105-1042T
345mm	8mm	19-105-0834	19-105-0834T	250mm	11mm	19-105-1125	19-105-1125T
360mm	8mm	19-105-0836	19-105-0836T	270mm	11mm	19-105-1127	19-105-1127T
375mm	8mm	19-105-0837	19-105-0837T	285mm	11mm	19-105-1128	19-105-1128T
390mm	8mm	19-105-0839	19-105-0839T	300mm	11mm	19-105-1130	19-105-1130T
405mm	8mm	19-105-0840	19-105-0840T	315mm	11mm	19-105-1131	19-105-1131T
420mm	8mm	19-105-0842	19-105-0842T	330mm	11mm	19-105-1133	19-105-1133T
250mm	9mm	19-105-0925	19-105-0925T	345mm	11mm	19-105-1134	19-105-1134T
270mm	9mm	19-105-0927	19-105-0927T	360mm	11mm	19-105-1136	19-105-1136T
285mm	9mm	19-105-0928	19-105-0928T	375mm	11mm	19-105-1137	19-105-1137T
300mm	9mm	19-105-0930	19-105-0930T	390mm	11mm	19-105-1139	19-105-1139T
315mm	9mm	19-105-0931	19-105-0931T	405mm	11mm	19-105-1140	19-105-1140T
330mm	9mm	19-105-0933	19-105-0933T	420mm	11mm	19-105-1142	19-105-1142T
345mm	9mm	19-105-0934	19-105-0934T	250mm	12mm	19-105-1225	19-105-1225T
360mm	9mm	19-105-0936	19-105-0936T	270mm	12mm	19-105-1227	19-105-1227T
375mm	9mm	19-105-0937	19-105-0937T	285mm	12mm	19-105-1228	19-105-1228T
390mm	9mm	19-105-0939	19-105-0939T	300mm	12mm	19-105-1230	19-105-1230T
405mm	9mm	19-105-0940	19-105-0940T	315mm	12mm	19-105-1231	19-105-1231T
420mm	9mm	19-105-0942	19-105-0942T	330mm	12mm	19-105-1233	19-105-1233T
250mm	10mm	19-105-1025	19-105-1025T	345mm	12mm	19-105-1234	19-105-1234T
270mm	10mm	19-105-1027	19-105-1027T	360mm	12mm	19-105-1236	19-105-1236T
285mm	10mm	19-105-1028	19-105-1028T	375mm	12mm	19-105-1237	19-105-1237T
300mm	10mm	19-105-1030	19-105-1030T	390mm	12mm	19-105-1239	19-105-1239T
315mm	10mm	19-105-1031	19-105-1031T	405mm	12mm	19-105-1240	19-105-1240T
330mm	10mm	19-105-1033	19-105-1033T	420mm	12mm	19-105-1242	19-105-1242T



**Locking Screw Dia. 4.4mm for MCM
Pro."Esperto" Tibia Int. Nail**



Nail Cap for MCM Pro."Esperto" Tibia Int. Nail



Length	Stainless steel Rostfreier Stahl	Titanium Titan
0.0mm	19-106-00	19-106-00T
5.0mm	19-106-05	19-106-05T
10.0mm	19-106-10	19-106-10T
15.0mm	19-106-15	19-106-15T

**Locking Screw Dia. 4.8mm for MCM
Pro."Esperto" Tibia Int. Nail**



Length Länge	Stainless steel Rostfreier Stahl	Titanium Titan
55mm	19-107-55	19-107-55T
60mm	19-107-60	19-107-60T
65mm	19-107-65	19-107-65T
70mm	19-107-70	19-107-70
75mm	19-107-75	19-107-75T
80mm	19-107-80	19-107-80T
85mm	19-107-85	19-107-85T
90mm	19-107-90	19-107-90T

Length Länge	Stainless steel Rostfreier Stahl	Titanium Titan
24mm	19-108-24	19-108-24T
26mm	19-108-26	19-108-26T
28mm	19-108-28	19-108-28T
30mm	19-108-30	19-108-30T
32mm	19-108-32	19-108-32T
34mm	19-108-34	19-108-34T
36mm	19-108-36	19-108-36T
38mm	19-108-38	19-108-38T
40mm	19-108-40	19-108-40T
42mm	19-108-42	19-108-42T
44mm	19-108-44	19-108-44T
46mm	19-108-46	19-108-46T
48mm	19-108-48	19-108-48T
50mm	19-108-50	19-108-50T
52mm	19-108-52	19-108-52T
54mm	19-108-54	19-108-54T
56mm	19-108-56	19-108-56T
58mm	19-108-58	19-108-58T
60mm	19-108-60	19-108-60T
62mm	19-108-62	19-108-62T
64mm	19-108-64	19-108-64T
66mm	19-108-66	19-108-66T
68mm	19-108-68	19-108-68T
70mm	19-108-70	19-108-70T
72mm	19-108-72	19-108-72T
74mm	19-108-74	19-108-74T
76mm	19-108-76	19-108-76T
78mm	19-108-78	19-108-78T
80mm	19-108-80	19-108-80T
82mm	19-108-82	19-108-82T
84mm	19-108-84	19-108-84T
86mm	19-108-86	19-108-86T
88mm	19-108-88	19-108-88T

Basic Instrumentation Set for MCM Pro."UNO" Tibia Int. Nail

Set Code

19-999-020

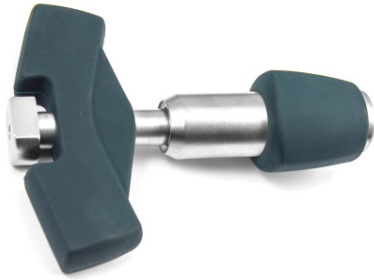
Guide Wire Holder

Code

19-888-062

Protection Sleeve

Code

19-888-063

Radiographic Ruler

Code

19-888-060

Straight Awl

Code

19-888-064

Guide Wire, 3.2mm

Code

19-888-061

Skin Protector



Code
19-888-065

Reducer



Code
19-888-069

Cannulated Awl



Code
19-888-066

Ball Tip Guide Wire

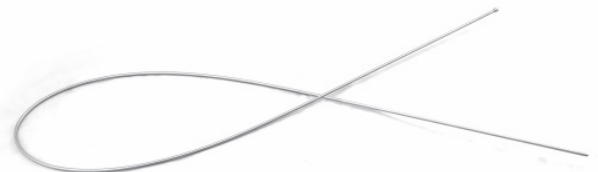

Code
19-888-070

Entry Reamer



Code
19-888-067

Flexible Reamer Shaft



Code
19-888-071

T-handle with Quick Coupling

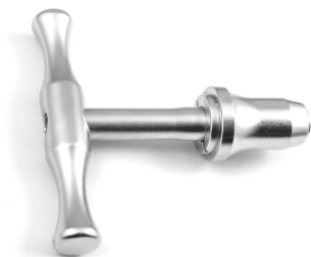

Code
19-888-068



Reamer Head, 7.5mm

19-888-072



Reamer Head, 8.0mm

19-888-073



Reamer Head, 8.5mm

19-888-074



Reamer Head, 9.0mm

19-888-075



Reamer Head, 9.5mm

19-888-076



Reamer Head, 10.0mm

19-888-077



Reamer Head, 10.5mm

19-888-078



Reamer Head, 11.0mm

19-888-079



Reamer Head, 11.5mm

19-888-080



Reamer Head, 12.0mm

19-888-081

Insertion Handle

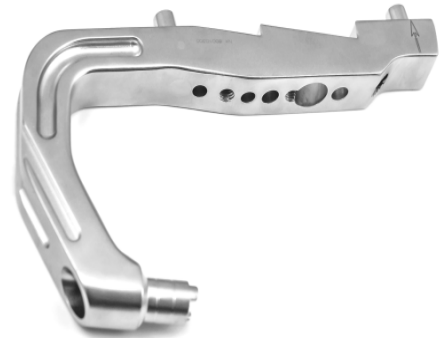

Code

19-888-082

Nail Holding Bolt



Code

19-888-083

Guide Bolt Wrench with T-Handle, SW6.5



Code

19-888-084

Connecting Shaft Block



Code
19-888-085

Hammer Guiding Shaft



Code
19-888-089

Connecting Shaft



Code
19-888-086

Hammer Guiding Shaft Nut



Code
19-888-090

Spanner



Code
19-888-087

Sliding Hammer



Code
19-888-091

Small Wrench



Code
19-888-088

Distal Aiming Bar

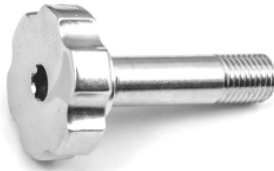

Code
19-888-092

Distal Bolt

Code

19-888-093

Positioning Rod Drill, 5.2mm

Code

19-888-097

Bolt Wrench, SW5

Code

19-888-094

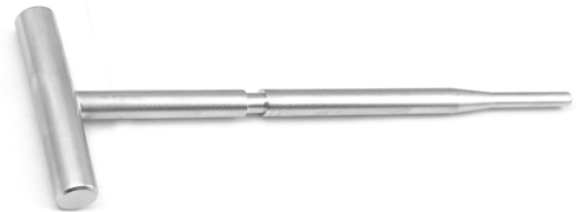
Position Rod

Code

19-888-098

Drill Sleeve, 5.2mm

Code

19-888-095

Position Rod

Code

19-888-099

Drill Bit, 5.2mm

Code

19-888-096

Position Rod



Code
19-888-099

Trocar for Sleeves



Code
19-888-103

Drill Sleeve, 4.0mm



Code
19-888-104

Distal Amiming Device



Code
19-888-100

Drill Bit, 4.0mm



Code
19-888-105

Distal Amiming Device Bolt



Code
19-888-101

Stopper, 4.0mm



Code
19-888-106

Outer Drill Sleeve



Code
19-888-102

Stopper Wrench, SW3.0



Code

19-888-107

Proximal Aiming Device, for Cortical Screw



Code

19-888-111

Screw Length Gauge



Code

19-888-108

Proximal Bolt

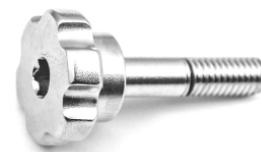

Code

19-888-112

Screw Driver for Locking Screw, SW3.5



Code

19-888-109

Proximal Aiming Device, for Cancellous Screw



Code

19-888-113

Locking Screwdriver Shaft, SW3.5



Code

19-888-110

Outer Drill Sleeve for Cancellous Screw



Code
19-888-114

Compression Bolt



Code
19-888-119

Drill Sleeve, 3.2



Code
19-888-115

Guide Bolt Wrench, Ball Tip



Code
19-888-120

Trocar



Code
19-888-116

End Cap Holder



Code
19-888-121

Drill Bit, 3.2mm



Code
19-888-117

Extractor



Code
19-888-122

Stopper, 3.2mm



Code
19-888-118

Tray



Code

19-888-123

Container



Code

19-888-124



03

"Comodo" Tibial Interlocking Nail



MCM Pro. "Comodo" Tibial Interlocking Nail

Length Länge	Dia	Stainless steel Rostfreier Stahl	Titanium Titan	Length Länge	Dia	Stainless steel Rostfreier Stahl	Titanium Titan
240mm	8mm	19-101-0824	19-101-0824T	340mm	10mm	19-101-1034	19-101-1034T
260mm	8mm	19-101-0826	19-101-0826T	360mm	10mm	19-101-1036	19-101-1036T
280mm	8mm	19-101-0828	19-101-0828T	380mm	10mm	19-101-1038	19-101-1038T
300mm	8mm	19-101-0830	19-101-0830T	400mm	10mm	19-101-1040	19-101-1040T
320mm	8mm	19-101-0832	19-101-0832T	240mm	11mm	19-101-1124	19-101-1124T
340mm	8mm	19-101-0834	19-101-0834T	260mm	11mm	19-101-1126	19-101-1126T
360mm	8mm	19-101-0836	19-101-0836T	280mm	11mm	19-101-1128	19-101-1128T
380mm	8mm	19-101-0838	19-101-0838T	300mm	11mm	19-101-1130	19-101-1130T
400mm	8mm	19-101-0840	19-101-0840T	320mm	11mm	19-101-1132	19-101-1132T
240mm	9mm	19-101-0924	19-101-0924T	340mm	11mm	19-101-1134	19-101-1134T
260mm	9mm	19-101-0926	19-101-0926T	360mm	11mm	19-101-1136	19-101-1136T
280mm	9mm	19-101-0928	19-101-0928T	380mm	11mm	19-101-1138	19-101-1138T
300mm	9mm	19-101-0930	19-101-0930T	400mm	11mm	19-101-1140	19-101-1140T
320mm	9mm	19-101-0932	19-101-0932T	240mm	12mm	19-101-1224	19-101-1224T
340mm	9mm	19-101-0934	19-101-0934T	260mm	12mm	19-101-1226	19-101-1226T
360mm	9mm	19-101-0936	19-101-0936T	280mm	12mm	19-101-1228	19-101-1228T
380mm	9mm	19-101-0938	19-101-0938T	300mm	12mm	19-101-1230	19-101-1230T
400mm	9mm	19-101-0940	19-101-0940T	320mm	12mm	19-101-1232	19-101-1232T
240mm	10mm	19-101-1024	19-101-1024T	340mm	12mm	19-101-1234	19-101-1234T
260mm	10mm	19-101-1026	19-101-1026T	360mm	12mm	19-101-1236	19-101-1236T
280mm	10mm	19-101-1028	19-101-1028T	380mm	12mm	19-101-1238	19-101-1238T
300mm	10mm	19-101-1030	19-101-1030T	400mm	12mm	19-101-1240	19-101-1240T
320mm	10mm	19-101-1032	19-101-1032T				



**Locking Screw Dia. 4.5mm for MCM
Pro."Comodo" Tibia Int. Nail**



Length Länge	Stainless steel Rostfreier Stahl	Titanium Titan
20mm	19-102-20	19-102-20T
25mm	19-102-25	19-102-25T
30mm	19-102-30	19-102-30T
35mm	19-102-35	19-102-35T
40mm	19-102-40	19-102-40T
45mm	19-102-45	19-102-45T
50mm	19-102-50	19-102-50T
55mm	19-102-55	19-102-55T
60mm	19-102-60	19-102-60T
65mm	19-102-65	19-102-65T
70mm	19-102-70	19-102-70T
75mm	19-102-75	19-102-75T
80mm	19-102-80	19-102-80T

Nail Cap for MCM Pro."Comodo" Tibia Int. Nail



Stainless steel Rostfreier Stahl	Titanium Titan
19-104-10	19-104-10T

**Locking Screw Dia. 3.5mm for MCM
Pro."Comodo" Tibia Int. Nai**



Length Länge	Stainless steel Rostfreier Stahl	Titanium Titan
20mm	19-103-20	19-103-20T
25mm	19-103-25	19-103-25T
30mm	19-103-30	19-103-30T
35mm	19-103-35	19-103-35T
40mm	19-103-40	19-103-40T
45mm	19-103-45	19-103-45T
50mm	19-103-50	19-103-50T
55mm	19-103-55	19-103-55T
60mm	19-103-60	19-103-60T
65mm	19-103-65	19-103-65T
70mm	19-103-70	19-103-70T
75mm	19-103-75	19-103-75T
80mm	19-103-80	19-103-80T

Basic Instrumentation Set for MCM Pro."Comodo" Tibia Int. Nail

Set Code

19-999-030

Drill Sleeve,(For 5.2mm Drill Bits)

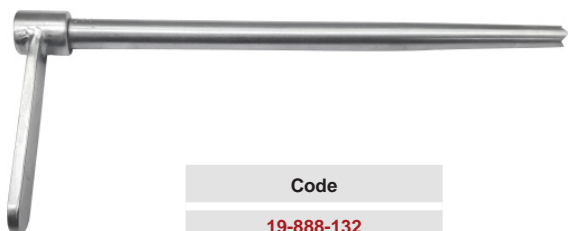

Code

19-888-132

Trocar



Code

19-888-133

Drill Sleeve (for 04.0mm Drill Bit)



Code

19-888-130

Protection Sleeve



Code

19-888-131



Reamer Head,11.0mm

19-888-134



Reamer Head,10.5mm

19-888-135



Reamer Head,10.0mm

19-888-136



Reamer Head,9.5mm

19-888-137



Reamer Head,9.0mm

19-888-138



Reamer Head,8.5mm

19-888-139



Reamer Head,8.0mm

19-888-140

Reduction Rod (For Guide Rod)



Code
19-888-141

Positioning Flat Drill

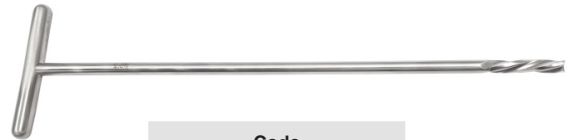

Code
19-888-145

Drill Bit with Stopper, 4.0mm (for Locking Bolt)



Code
19-888-142

Screws Exactor

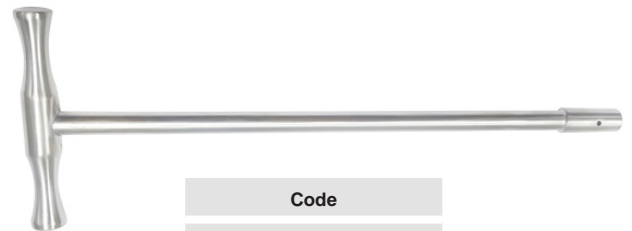

Code
19-888-146

Fleximal Shaft (for Reamer Head, 9 to 12mm)



Code
19-888-143

Bone Awl, Cannulated for Tibial Nails



Code
19-888-147

Flexible Reaming shaft Fixed Remear, 9mm



Code
19-888-144

Right Angle Locking Rod

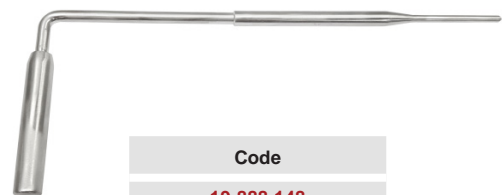

Code
19-888-148

Drill Bit , 4.0mm

Code

19-888-149

Spanner

Code

19-888-154

Screw Measuring Device for Locking Bolt

Code

19-888-150

Allen Wrench, 3.0mm

Code

19-888-155

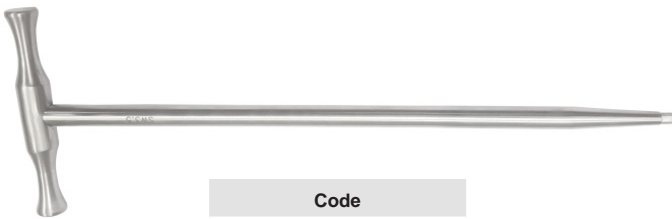
T Handle Hex Screw Driver

Code

19-888-151

Proximal Holes Attachment

Code

19-888-156

Entry Drill Bit, 5.2mm

Code

19-888-152

Distal Positioning Frame

Code

19-888-157

Guide Rod with olive, 2.5mm

Code

19-888-153

Proximal Target Device



Code
19-888-158

Allen Wrench, 5.0mm



Code
19-888-162

Sliding Hammer



Code
19-888-163

Positioning block



Code
19-888-159

Universal Adapter



Code
19-888-164

Connecting Nut (For Targetting Device)



Code
19-888-160

Tissue protector

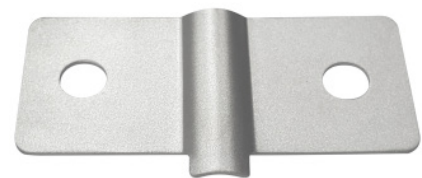

Code
19-888-165

Positioning Rod



Code
19-888-161

Distal Targeting Attachment



Code

19-888-166

T-Handle, Quick Coupling

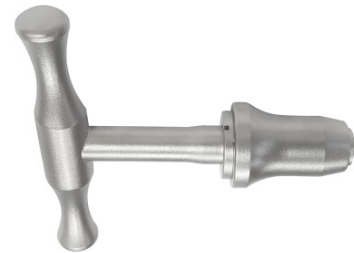

Code

19-888-169

Nail holding Bolt



Code

19-888-167

Guide Wire Introducer



Code

19-888-170

Tap For Locking Bolt



Code

19-888-168

Tray



Code
19-888-123

Container



Code
19-888-124

04

"UNO" Femoral Interlocking Nail



MCM Pro. "UNO" Femoral Interlocking Nail

Length Länge	Dia	Stainless steel Rostfreier Stahl	Length Länge	Dia	Stainless steel Rostfreier Stahl
240mm	8mm	19-210-0824	240mm	10mm	19-210-1024
260mm	8mm	19-210-0826	260mm	10mm	19-210-1026
280mm	8mm	19-210-0828	280mm	10mm	19-210-1028
300mm	8mm	19-210-0830	300mm	10mm	19-210-1030
320mm	8mm	19-210-0832	320mm	10mm	19-210-1032
340mm	8mm	19-210-0834	340mm	10mm	19-210-1034
360mm	8mm	19-210-0836	360mm	10mm	19-210-1036
380mm	8mm	19-210-0838	380mm	10mm	19-210-1038
240mm	9mm	19-210-0924	400mm	10mm	19-210-1040
260mm	9mm	19-210-0926	420mm	10mm	19-210-1042
280mm	9mm	19-210-0928	440mm	10mm	19-210-1044
300mm	9mm	19-210-0930	460mm	10mm	19-210-1046
320mm	9mm	19-210-0932	480mm	10mm	19-210-1048
340mm	9mm	19-210-0934	320mm	11mm	19-210-1132
360mm	9mm	19-210-0936	340mm	11mm	19-210-1134
380mm	9mm	19-210-0938	360mm	11mm	19-210-1136
400mm	9mm	19-210-0940	380mm	11mm	19-210-1138
420mm	9mm	19-210-0942	400mm	11mm	19-210-1140
440mm	9mm	19-210-0944	420mm	11mm	19-210-1142
460mm	9mm	19-210-0946	440mm	11mm	19-210-1144
			460mm	11mm	19-210-1146
			480mm	11mm	19-210-1148

Nail Cap Dia.13.0mm for MCM Pro."UNO"
Femoral Int. Nail

Code

19-213-1113

for ø 5.0 mm Locking Screws prox.

for ø 5.0 mm Locking Screws distal

Locking Screw Dia. 5.0mm
for MCM Pro."UNO"
Femoral Int. Nail

Length Länge	Stainless steel Rostfreier Stahl
25mm	19-211-5025
30mm	19-211-5030
35mm	19-211-5035
40mm	19-211-5040
45mm	19-211-5045
50mm	19-211-5050
55mm	19-211-5055
60mm	19-211-5060
65mm	19-211-5065
70mm	19-211-5070
75mm	19-211-5075
80mm	19-211-5080
85mm	19-211-5085
90mm	19-211-5090

MCM Pro. "UNO" Femoral Interlocking Nail

Length Länge	Dia	Stainless steel Rostfreier Stahl
320mm	12mm	19-210-1232
340mm	12mm	19-210-1234
360mm	12mm	19-210-1236
380mm	12mm	19-210-1238
400mm	12mm	19-210-1240
420mm	12mm	19-210-1242
440mm	12mm	19-210-1244
460mm	12mm	19-210-1246
480mm	12mm	19-210-1248
500mm	12mm	19-210-1250
360mm	13mm	19-210-1336
380mm	13mm	19-210-1338
400mm	13mm	19-210-1340
420mm	13mm	19-210-1342
440mm	13mm	19-210-1344
460mm	13mm	19-210-1346
480mm	13mm	19-210-1348
500mm	13mm	19-210-1350
320mm	14mm	19-210-1432
340mm	14mm	19-210-1434
360mm	14mm	19-210-1436
380mm	14mm	19-210-1438
400mm	14mm	19-210-1440
420mm	14mm	19-210-1442
440mm	14mm	19-210-1444
460mm	14mm	19-210-1446
480mm	14mm	19-210-1448

for \varnothing 6.4 mm Locking Bolts prox

for \varnothing 6.4 mm Locking Bolts distal



Locking Screw Dia. 6.4mm for MCM Pro. "UNO" Femoral Int. Nail



Length Länge	Stainless steel Rostfreier Stahl
30mm	19-212-6430
35mm	19-212-6435
40mm	19-212-6440
45mm	19-212-6445
50mm	19-212-6450
55mm	19-212-6455
60mm	19-212-6460
65mm	19-212-6465
70mm	19-212-6470
75mm	19-212-6475
80mm	19-212-6480
85mm	19-212-6485
90mm	19-212-6490

\\ 05

"UNO Multi-13mm" Femoral Interlocking Nail



MCM Pro."UNO Multi-13mm" Multifunctional Femoral Int. Nail

Length Länge	Dia	Stainless steel Rostfreier Stahl	Length Länge	Dia	Stainless steel Rostfreier Stahl
240mm	8mm	19-215-0824	320mm	10mm	19-215-1032
260mm	8mm	19-215-0826	340mm	10mm	19-215-1034
280mm	8mm	19-215-0828	360mm	10mm	19-215-1036
300mm	8mm	19-215-0830	380mm	10mm	19-215-1038
320mm	8mm	19-215-0832	400mm	10mm	19-215-1040
340mm	8mm	19-215-0834	420mm	10mm	19-215-1042
360mm	8mm	19-215-0836	440mm	10mm	19-215-1044
380mm	8mm	19-215-0838	460mm	10mm	19-215-1046
240mm	9mm	19-215-0924	480mm	10mm	19-215-1048
260mm	9mm	19-215-0926	320mm	11mm	19-215-1132
280mm	9mm	19-215-0928	340mm	11mm	19-215-1134
300mm	9mm	19-215-0930	360mm	11mm	19-215-1136
320mm	9mm	19-215-0932	380mm	11mm	19-215-1138
340mm	9mm	19-215-0934	400mm	11mm	19-215-1140
360mm	9mm	19-215-0936	420mm	11mm	19-215-1142
380mm	9mm	19-215-0938	440mm	11mm	19-215-1144
400mm	9mm	19-215-0940	460mm	11mm	19-215-1146
420mm	9mm	19-215-0942	480mm	11mm	19-215-1148
440mm	9mm	19-215-0944			



Lag Screw 5.0mm for MCM Pro."UNO Multi-13mm" Multi Femoral Int. Nail



Length Länge	Stainless steel Rostfreier Stahl
65mm	19-216-5065
70mm	19-216-5070
75mm	19-216-5075
80mm	19-216-5080
85mm	19-216-5085
90mm	19-216-5090
95mm	19-216-5095
100mm	19-216-5100
105mm	19-216-5105
110mm	19-216-5110
115mm	19-216-5115
120mm	19-216-5120
125mm	19-216-5125

Locking Screw 5.0mm for MCM Pro."UNO Multi-13mm" Multi Femoral Int. Nail



Length Länge	Stainless steel Rostfreier Stahl
25mm	19-217-5025
30mm	19-217-5030
35mm	19-217-5035
40mm	19-217-5040
45mm	19-217-5045
50mm	19-217-5050
55mm	19-217-5055
60mm	19-217-5060
65mm	19-217-5065
70mm	19-217-5070
75mm	19-217-5075
80mm	19-217-5080
85mm	19-217-5085
90mm	19-217-5090

Nail Cap Dia.13.0mm for MCM Pro."UNO Multi-13mm" Multi Femoral Int. Nail



Code
19-218-1113

\\ 06

"UNO Multi-15mm" Femoral Interlocking Nail

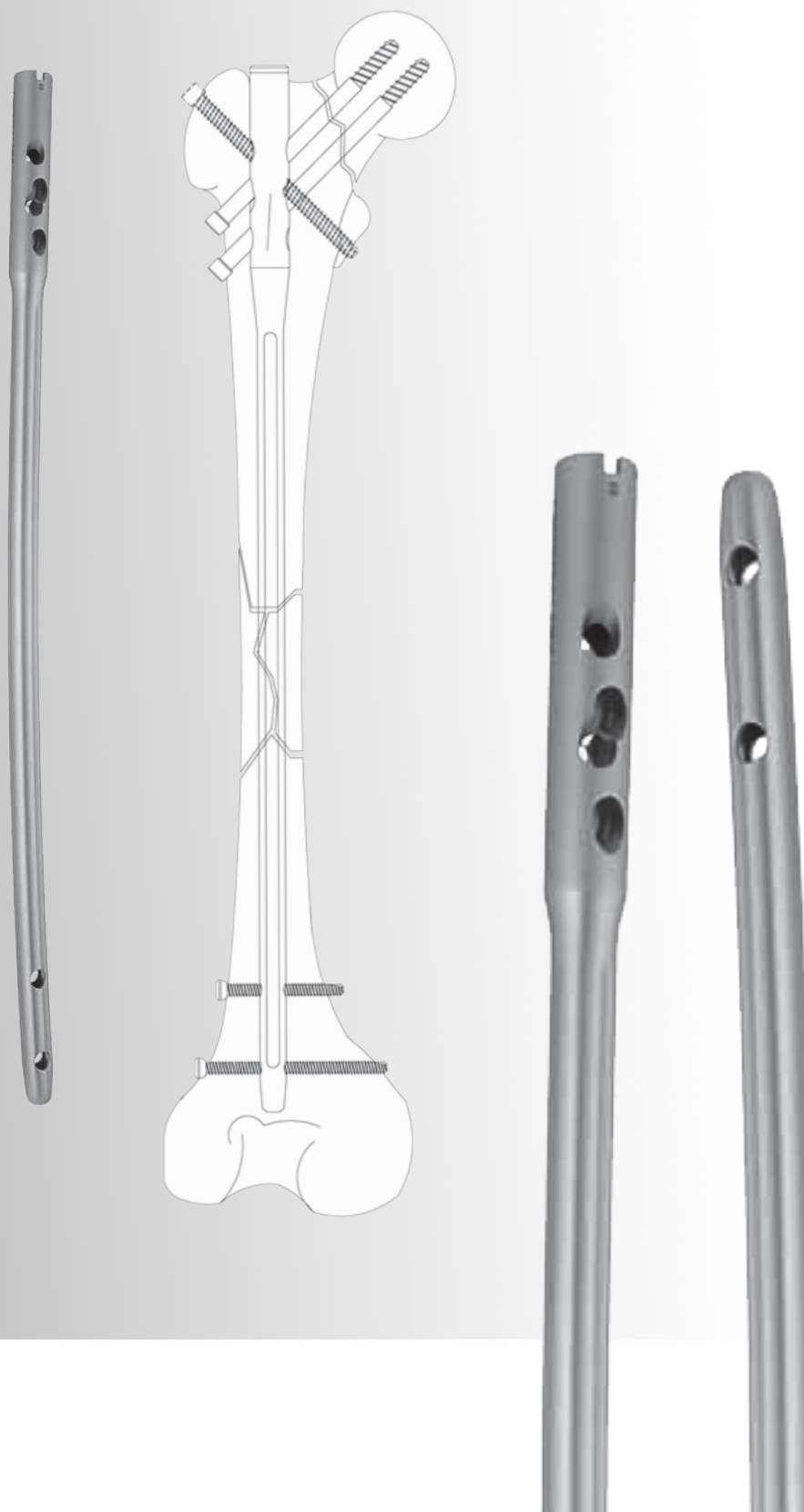

MCM Pro."UNO Multi-15mm" Multifunctional Femoral Int. Nail

Length Länge	Dia	Stainless steel Rostfreier Stahl
240mm	10mm	19-220-1024
320mm	10mm	19-220-1032
340mm	10mm	19-220-1034
360mm	10mm	19-220-1036
380mm	10mm	19-220-1038
400mm	10mm	19-220-1040
420mm	10mm	19-220-1042
440mm	10mm	19-220-1044
460mm	10mm	19-220-1046
480mm	10mm	19-220-1048
240mm	12mm	19-220-1224
320mm	12mm	19-220-1232
340mm	12mm	19-220-1234
360mm	12mm	19-220-1236
380mm	12mm	19-220-1238
400mm	12mm	19-220-1240
420mm	12mm	19-220-1242
440mm	12mm	19-220-1244
460mm	12mm	19-220-1246
480mm	12mm	19-220-1248

for \varnothing 6.4 mm Lag Bolts prox.

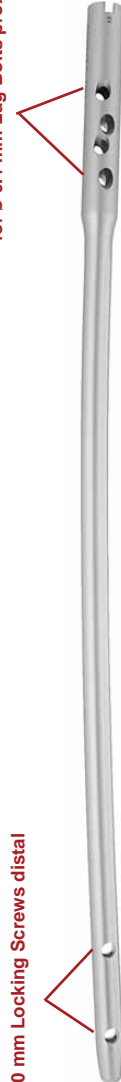

for \varnothing 5.0 mm Locking Screws distal

Lag Screw 6.4mm for MCM Pro."UNO Multi-15mm" Multi Femoral Int. Nail



Length Länge	Stainless steel Rostfreier Stahl
65mm	19-221-6465
70mm	19-221-6470
75mm	19-221-6475
80mm	19-221-6480
85mm	19-221-6485
90mm	19-221-6490
95mm	19-221-6495
100mm	19-221-6100
105mm	19-221-6105
110mm	19-221-6110
115mm	19-221-6115
120mm	19-221-6120
125mm	19-221-6125

Locking Screw 6.4mm for MCM Pro."UNO Multi-15mm" Multi Femoral Int. Nail



Length Länge	Stainless steel Rostfreier Stahl
30mm	19-222-6430
35mm	19-222-6435
40mm	19-222-6440
45mm	19-222-6445
50mm	19-222-6450
55mm	19-222-6455
60mm	19-222-6460
65mm	19-222-6465
70mm	19-222-6470
75mm	19-222-6475
80mm	19-222-6480
85mm	19-222-6485
90mm	19-222-6490

Nail Cap Dia.15.0mm for MCM Pro."UNO Multi-15mm" Multi Femoral Int. Nail



Code

19-223-1115

Basic Instrumentation Set for MCM Pro."UNO" Femoral Int. Nail

Set Code

19-999-011

**Graphic Case(QTY 3) for Set MCM Pro."UNO"
Tibia Int. Nail**



Code

19-998-021

**Container Alum. 285x280x150mm silver Lid
perforated / Bottom non-perforated**



Code

19-998-031

Container for Set 19-999-100



Code

19-998-010

**Screw Box f. Locking Screws and Screwed Plugs
(empty)**



Code

19-998-041

Universal Socket Wrench

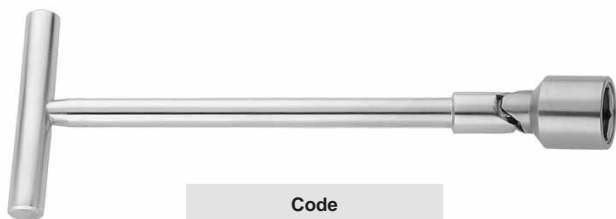

Code

19-888-001

Screw Length Gauge



Code

19-888-007

Hex Driver



Item	Code
Hex Driver SW 3.5 for 4,5mm 5,0mm Interl. screws	19-888-002
Hexagon Driver for screws 6,4mm	19-888-003
Hex Driver cannul. f. dia 4,5 + 5mm	19-888-004

Radiolucent drill Bits cannul.



Dia ø	Code
3.5mm	19-888-008
4.0mm	19-888-009
4.8mm	19-888-010

Radiolucent drill Bits



Dia ø	Code
2.7mm	19-888-011
3.5mm	19-888-012
4.0mm	19-888-013
4.8mm	19-888-014

Medullary Exchange Tube



Code

19-888-005

Internal Fracture Alignment Device



Code

19-888-006

Twist Drill



Dia ø	Code
3.5mm	19-888-015
4.0mm	19-888-016
4.8mm	19-888-017

Trocar dia 4,0mm x 240mm



Code

19-888-018

Tip Threaded Guide Pin 3,2mm x 305mm



Code

19-888-019

Guide Rod dia 1,8 x350mm



Code

19-888-020

Guide Rod for Reamer 2,4 x 900mm



Code

19-888-021

Guide Rod for Reamer 3,0mm x 900mm

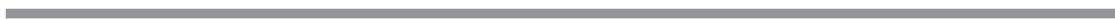

Code

19-888-022

Guide Rod for Reamer 2,0 x 900 mm



Code

19-888-023

Guide Rod for Reamer 3,0 x 900mm



Code

19-888-024

Guide Rod for Reamer 3,0 x 900mm



Code

19-888-025

Guide Rod w. curvedTip 2,4 x 900mm



Code

19-888-026

Open End Wrench 17/14"



Code

19-888-027

Supine Driver

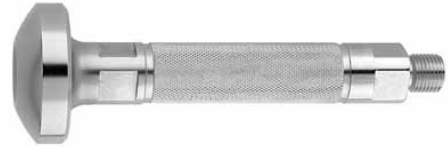

Code

19-888-030

Reamer Template

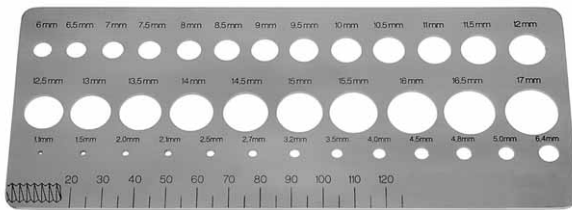

Code

19-888-028

T-Handle



Code

19-888-031

Nail Length Gauge



Code

19-888-029

Femoral Proximal Device



Code

19-888-053

Trocar Nail



Dia ø	Code
3.2mm	19-888-035
4.0mm	19-888-036
4.8mm	19-888-037
8.0mm	19-888-038

Skin Protector



Code

19-888-033

Curved Awl



Code

19-888-034

Reamer cannulated
dia 15,5 mm

Code

19-888-039

Tapered Reamer dia
13,5mm cannulated

Code

19-888-040



Twist Drill cannul.dia 4,0 x 325/305mm



4,0 x 325/305mm

19-888-054

4,8 x 325/305mm

19-888-055

UNO Multi-cutter f. screws dia 6,4mm



Code

19-888-056

Cannulated Reamer 9,0mm



Code
19-888-041



Drill Sleeve, green, 8,0 mm (long)
19-888-042



Drill Sleeve Silver 2,1 mm
19-888-043



Drill Sleeve blue 4,8mm
19-888-044



Drill Sleeve Gold 4,0 mm
19-888-045



Drill Sleeve (black) 3,5 mm
19-888-046

Slide Hammer



Code
19-888-047

Tibal Extractor Bolt



Code
19-888-048

Bolt f. prox. DrillGuide ..



Code
19-888-051

\\ 07

"Esperto-Reco" Femoral Interlocking Nail



Left - Links				Right - Rechts			
Length Länge	Dia	Stainless steel Rostfreier Stahl	Titanium Titan	Length Länge	Dia	Stainless steel Rostfreier Stahl	Titanium Titan
300mm	9mm	19-112-0930L	19-112-0930LT	300mm	9mm	19-112-0930R	19-112-0930RT
320mm	9mm	19-112-0932L	19-112-0932LT	320mm	9mm	19-112-0932R	19-112-0932RT
340mm	9mm	19-112-0934L	19-112-0934LT	340mm	9mm	19-112-0934R	19-112-0934RT
360mm	9mm	19-112-0936L	19-112-0936LT	360mm	9mm	19-112-0936R	19-112-0936RT
380mm	9mm	19-112-0938L	19-112-0938LT	380mm	9mm	19-112-0938R	19-112-0938RT
400mm	9mm	19-112-0940L	19-112-0940LT	400mm	9mm	19-112-0940R	19-112-0940RT
420mm	9mm	19-112-0942L	19-112-0942LT	420mm	9mm	19-112-0942R	19-112-0942RT
440mm	9mm	19-112-0944L	19-112-0944LT	440mm	9mm	19-112-0944R	19-112-0944RT
460mm	9mm	19-112-0946L	19-112-0946LT	460mm	9mm	19-112-0946R	19-112-0946RT
480mm	9mm	19-112-0948L	19-112-0948LT	480mm	9mm	19-112-0948R	19-112-0948RT
300mm	10mm	19-112-1030L	19-112-1030LT	300mm	10mm	19-112-1030R	19-112-1030RT
320mm	10mm	19-112-1032L	19-112-1032LT	320mm	10mm	19-112-1032R	19-112-1032RT
340mm	10mm	19-112-1034L	19-112-1034LT	340mm	10mm	19-112-1034R	19-112-1034RT
360mm	10mm	19-112-1036L	19-112-1036LT	360mm	10mm	19-112-1036R	19-112-1036RT
380mm	10mm	19-112-1038L	19-112-1038LT	380mm	10mm	19-112-1038R	19-112-1038RT
400mm	10mm	19-112-1040L	19-112-1040LT	400mm	10mm	19-112-1040R	19-112-1040RT
420mm	10mm	19-112-1042L	19-112-1042LT	420mm	10mm	19-112-1042R	19-112-1042RT
440mm	10mm	19-112-1044L	19-112-1044LT	440mm	10mm	19-112-1044R	19-112-1044RT
460mm	10mm	19-112-1046L	19-112-1046LT	460mm	10mm	19-112-1046R	19-112-1046RT
480mm	10mm	19-112-1048L	19-112-1048LT	480mm	10mm	19-112-1048R	19-112-1048RT
300mm	11mm	19-112-1130L	19-112-1130LT	300mm	11mm	19-112-1130R	19-112-1130RT
320mm	11mm	19-112-1132L	19-112-1132LT	320mm	11mm	19-112-1132R	19-112-1132RT
340mm	11mm	19-112-1134L	19-112-1134LT	340mm	11mm	19-112-1134R	19-112-1134RT
360mm	11mm	19-112-1136L	19-112-1136LT	360mm	11mm	19-112-1136R	19-112-1136RT
380mm	11mm	19-112-1138L	19-112-1138LT	380mm	11mm	19-112-1138R	19-112-1138RT
400mm	11mm	19-112-1140L	19-112-1140LT	400mm	11mm	19-112-1140R	19-112-1140RT
420mm	11mm	19-112-1142L	19-112-1142LT	420mm	11mm	19-112-1142R	19-112-1142RT
440mm	11mm	19-112-1144L	19-112-1144LT	440mm	11mm	19-112-1144R	19-112-1144RT
460mm	11mm	19-112-1146L	19-112-1146LT	460mm	11mm	19-112-1146R	19-112-1146RT
480mm	11mm	19-112-1148L	19-112-1148LT	480mm	11mm	19-112-1148R	19-112-1148RT
300mm	12mm	19-112-1230L	19-112-1230LT	300mm	12mm	19-112-1230R	19-112-1230RT
320mm	12mm	19-112-1232L	19-112-1232LT	320mm	12mm	19-112-1232R	19-112-1232RT
340mm	12mm	19-112-1234L	19-112-1234LT	340mm	12mm	19-112-1234R	19-112-1234RT
360mm	12mm	19-112-1236L	19-112-1236LT	360mm	12mm	19-112-1236R	19-112-1236RT
380mm	12mm	19-112-1238L	19-112-1238LT	380mm	12mm	19-112-1238R	19-112-1238RT
400mm	12mm	19-112-1240L	19-112-1240LT	400mm	12mm	19-112-1240R	19-112-1240RT
420mm	12mm	19-112-1242L	19-112-1242LT	420mm	12mm	19-112-1242R	19-112-1242RT
440mm	12mm	19-112-1244L	19-112-1244LT	440mm	12mm	19-112-1244R	19-112-1244RT
460mm	12mm	19-112-1246L	19-112-1246LT	460mm	12mm	19-112-1246R	19-112-1246RT
480mm	12mm	19-112-1248L	19-112-1248LT	480mm	12mm	19-112-1248R	19-112-1248RT
300mm	13mm	19-112-1330L	19-112-1330LT	300mm	13mm	19-112-1330R	19-112-1330RT
320mm	13mm	19-112-1332L	19-112-1332LT	320mm	13mm	19-112-1332R	19-112-1332RT
340mm	13mm	19-112-1334L	19-112-1334LT	340mm	13mm	19-112-1334R	19-112-1334RT
360mm	13mm	19-112-1336L	19-112-1336LT	360mm	13mm	19-112-1336R	19-112-1336RT
380mm	13mm	19-112-1338L	19-112-1338LT	380mm	13mm	19-112-1338R	19-112-1338RT
400mm	13mm	19-112-1340L	19-112-1340LT	400mm	13mm	19-112-1340R	19-112-1340RT
420mm	13mm	19-112-1342L	19-112-1342LT	420mm	13mm	19-112-1342R	19-112-1342RT
440mm	13mm	19-112-1344L	19-112-1344LT	440mm	13mm	19-112-1344R	19-112-1344RT
460mm	13mm	19-112-1346L	19-112-1346LT	460mm	13mm	19-112-1346R	19-112-1346RT
480mm	13mm	19-112-1348L	19-112-1348LT	480mm	13mm	19-112-1348R	19-112-1348RT



Nail Cap for MCM Pro."Esperto Reco" Femoral Int.



Length Länge	Stainless steel Rostfreier Stahl	Titanium Titan
0.0mm	19-113-00	19-113-00T
5.0mm	19-113-05	19-113-05T
10.0m	19-113-10	19-113-10T
15.0mm	19-113-15	19-113-15T
20.0mm	19-113-20	19-113-20T

Locking Screw 4.8mm for MCM Pro."Esperto Reco" Femoral Int.



Length Länge	Stainless steel Rostfreier Stahl	Titanium Titan
26mm	19-115-26	19-115-26T
28mm	19-115-28	19-115-28T
30mm	19-115-30	19-115-30T
32mm	19-115-32	19-115-32T
34mm	19-115-34	19-115-34T
36mm	19-115-36	19-115-36T
38mm	19-115-38	19-115-38T
40mm	19-115-40	19-115-40T
42mm	19-115-42	19-115-42T
44mm	19-115-44	19-115-44T
46mm	19-115-46	19-115-46T
48mm	19-115-48	19-115-48T
50mm	19-115-50	19-115-50T
52mm	19-115-52	19-115-52T
54mm	19-115-54	19-115-54T
56mm	19-115-56	19-115-56T
58mm	19-115-58	19-115-58T
60mm	19-115-60	19-115-60T
62mm	19-115-62	19-115-62T
64mm	19-115-64	19-115-64T

Canulated Locking Screw 6.5mm for MCM Pro."Esperto Reco" Femoral Int



Length Länge	Stainless steel Rostfreier Stahl	Titanium Titan
60mm	19-114-60	19-114-60T
65mm	19-114-65	19-114-65T
70mm	19-114-70	19-114-70T
75mm	19-114-75	19-114-75T
80mm	19-114-80	19-114-80T
85mm	19-114-85	19-114-85T
90mm	19-114-90	19-114-90T
95mm	19-114-95	19-114-95T
100mm	19-114-100	19-114-100T
105mm	19-114-105	19-114-105T
110mm	19-114-110	19-114-110
115mm	19-114-115	19-114-115T
120mm	19-114-120	19-114-120T
125mm	19-114-125	19-114-125T
130mm	19-114-130	19-114-130T

**Basic Instrumentation Set for MCM Pro."Esperto Reco"
Femoral Int. Nail**

Set Code

19-999-040

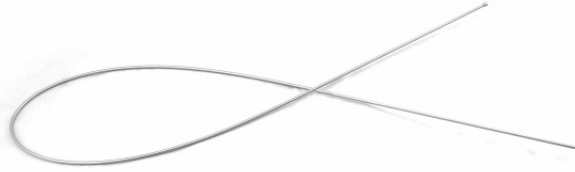
Ball Tip Guide Wire

Code

19-888-183

T-Handle with Quick Coupling



Code

19-888-182

Cannulated Awl

Code

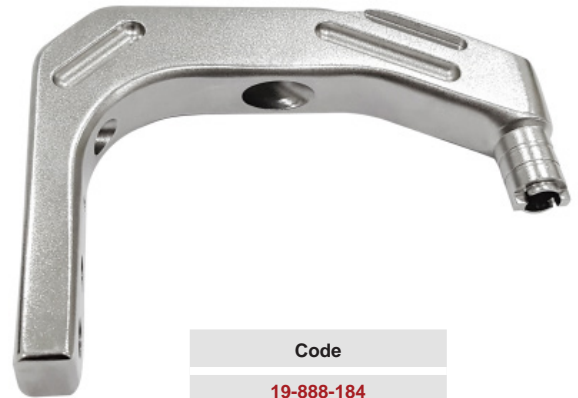
19-888-180

Inserion Handle

Code

19-888-184

Entry Reamer

Code

19-888-181

Flexible Reamer Shafi

Code

19-888-185

Reduction Rod



Code
19-888-186

Nail Holding Bolt



Code
19-888-199

	Reamer Head, 8.5mm 19-888-187
	Reamer Head, 9.0mm 19-888-188
	Reamer Head, 9.5mm 19-888-189
	Reamer Head, 10.0mm 19-888-190
	Reamer Head, 10.5mm 19-888-191
	Reamer Head, 11.0mm 19-888-192
	Reamer Head, 11.5mm 19-888-193
	Reamer Head, 12.0mm 19-888-194
	Reamer Head, 12.5mm 19-888-195
	Reamer Head, 13.0mm 19-888-196
	Reamer Head, 13.5mm 19-888-197
	Reamer Head, 14.0mm 19-888-198

Long Screw Driver for Locking Screw, SW 3.5



Code
19-888-200

Sliding Hammer



Code
19-888-201

Proximal Aiming Bar

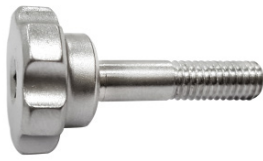

Code
19-888-202

Proximal Bolt

Code

19-888-203

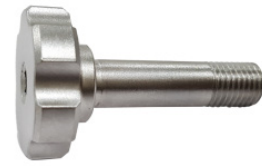
Distal Aiming Device Bolt

Code

19-888-207

Bolt Wrench, SW 5.0

Code

19-888-204

Distal Targeter

Code

19-888-208

Proximal Aiming Device.

Code

19-888-205

Outer Drill Sleeve

Code

19-888-209

Distal Aiming Bar

Code

19-888-206

Trocar for Sleeves

Code

19-888-210

Drill Sleeve, 4.0mm

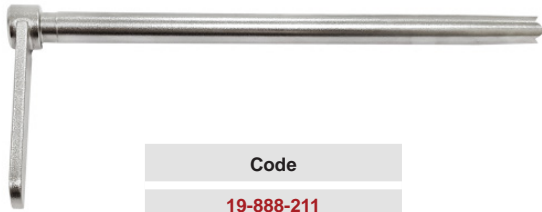

Code
19-888-211

E-Block



Code
19-888-215

Drill Bit, 5.2mm



Code
19-888-212

Outer Drill Sleeve



Code
19-888-216

Positioning Rod Drill, 5.2mm



Code
19-888-213

Drill Sleeve



Code
19-888-217

Positioning Rod



Code
19-888-214

Trocar



Code
19-888-218

Sleeve



Code
19-888-219

Trocar

Code

19-888-220

Guide Bolt Wrench, Ball Tip

Code

19-888-224

Drill Bit, 4.3mm

Code

19-888-221

Distal Bolt

Code

19-888-225

Screw Length Gauge

Code

19-888-222

Threaded Guide Wire, 2.5mm x 320mm

Code

19-888-226

Screw Driver for Locking Screw, SW 3.5

Code

19-888-223

Guide Wire, 2.5mm x 320mm

Code

19-888-227

Direct Measuring Device



Code

19-888-228

Impactor - Extractor Rod



Code

19-888-233

Tissue Protector



Code

19-888-229

Guide Wire Holder



Code

19-888-234

Drill Bit with Stopper



Code

19-888-230

Distal Screw Device (Static/ Dynamic Locking)



Code

19-888-235

Sleeve for Guide Wire



Code

19-888-231

Protection Sleeve



Code

19-888-232

Spanner



Code

19-888-236

Impactor

Code

19-888-237

Compression Bolt

Code

19-888-238

Drill Bit with Stopper, 4.3mm

Code

19-888-240

Trocar

Code

19-888-241

Radiographic Ruler

Code

19-888-242

Depth Gauge

Code

19-888-243

Guide Pin ,3.2mm

Code

19-888-239

Tray



Code

19-888-244

Container



Code

19-888-245

08

"Comodo" Femoral Interlocking Nail

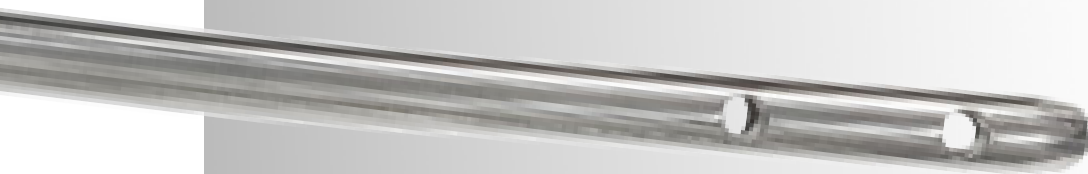
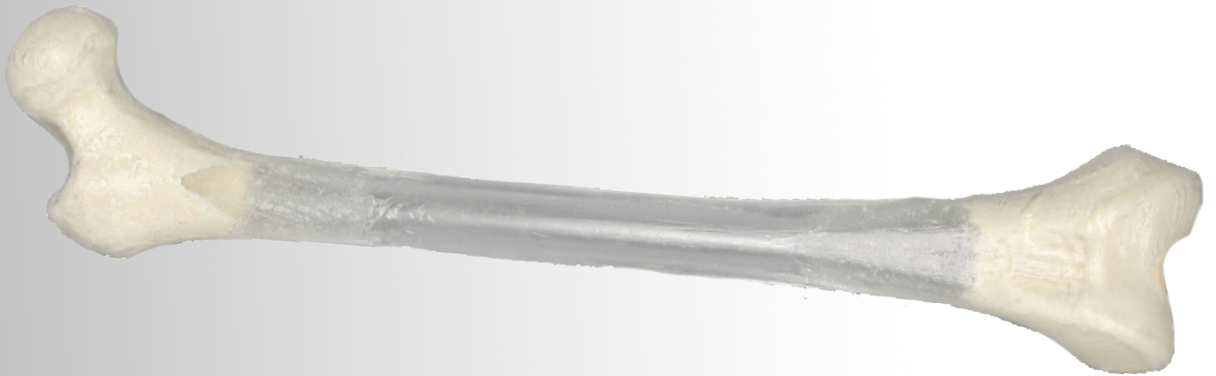
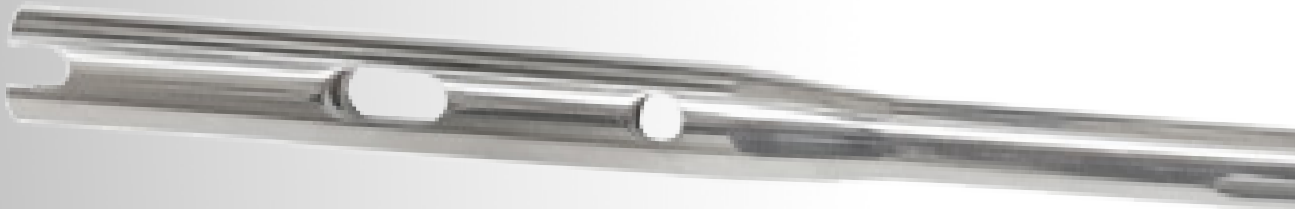

MCM Pro."Comodo" Femoral Int. Nail

Length Länge	Dia	Stainless steel Rostfreier Stahl	Titanium Titan
320mm	9mm	19-109-0932	19-109-0932T
340mm	9mm	19-109-0934	19-109-0934T
360mm	9mm	19-109-0936	19-109-0936T
380mm	9mm	19-109-0938	19-109-0938T
400mm	9mm	19-109-0940	19-109-0940T
420mm	9mm	19-109-0942	19-109-0942T
440mm	9mm	19-109-0944	19-109-0944T
460mm	9mm	19-109-0946	19-109-0946T
320mm	10mm	19-109-1032	19-109-1032T
340mm	10mm	19-109-1034	19-109-1034T
360mm	10mm	19-109-1036	19-109-1036T
380mm	10mm	19-109-1038	19-109-1038T
400mm	10mm	19-109-1040	19-109-1040T
420mm	10mm	19-109-1042	19-109-1042T
440mm	10mm	19-109-1044	19-109-1044T
460mm	10mm	19-109-1046	19-109-1046T
320mm	11mm	19-109-1132	19-109-1132T
340mm	11mm	19-109-1134	19-109-1134T
360mm	11mm	19-109-1136	19-109-1136T
380mm	11mm	19-109-1138	19-109-1138T
400mm	11mm	19-109-1140	19-109-1140T
420mm	11mm	19-109-1142	19-109-1142T
440mm	11mm	19-109-1144	19-109-1144T
460mm	11mm	19-109-1146	19-109-1146T
320mm	12mm	19-109-1232	19-109-1232T
340mm	12mm	19-109-1234	19-109-1234T
360mm	12mm	19-109-1236	19-109-1236T
380mm	12mm	19-109-1238	19-109-1238T
400mm	12mm	19-109-1240	19-109-1240T
420mm	12mm	19-109-1242	19-109-1242T
440mm	12mm	19-109-1244	19-109-1244T
460mm	12mm	19-109-1246	19-109-1246T



Locking Screw Dia. 4.5mm for MCM Pro."Comodo" Femoral Int. Nail



Length Länge	Stainless steel Rostfreier Stahl	Titanium Titan
20mm	19-110-20	19-110-20T
25mm	19-110-25	19-110-25T
30mm	19-110-30	19-110-30T
35mm	19-110-35	19-110-35T
40mm	19-110-40	19-110-40T
45mm	19-110-45	19-110-45T
50mm	19-110-50	19-110-50T
55mm	19-110-55	19-110-55T
60mm	19-110-60	19-110-60T
65mm	19-110-65	19-110-65T
70mm	19-110-70	19-110-70T
75mm	19-110-75	19-110-75T
80mm	19-110-80	19-110-80T

Nail Cap Length for MCM Pro."Comodo" Femoral Int. Nail



Stainless steel Rostfreier Stahl	Titanium Titan
19-111-10	19-111-10T

Basic Instrumentation Set for MCM Pro."Comodo" Femoral Int. Nail

Set Code

19-999-050

Tray



Code
19-888-244

Drill Sleeve,(For 5.2mm Drill Bits)



Code
19-888-262

Container



Code
19-888-245

Tissue protector



Code
19-888-263

Drill Sleeve (for 4.0mm Drill Bit)

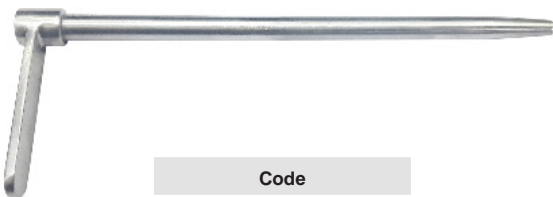

Code
19-888-260

Right Angle Locking Rod

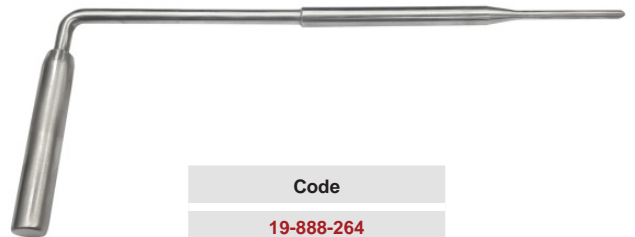

Code
19-888-264

T Handle Hex Screw Driver



Code
19-888-265

Outer Sleeve



Code
19-888-261

Positioning Flat Drill

Code

19-888-266

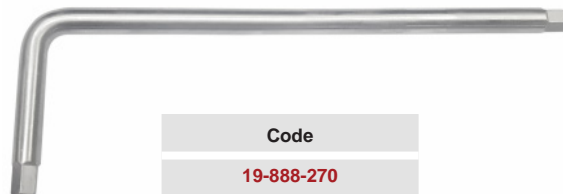
Allen Wrench, 5.0mm

Code

19-888-270

Tap

Code

19-888-267

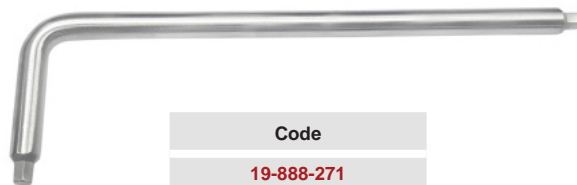
Allen Wrench, 3.0mm

Code

19-888-271

Screws Extractor

Code

19-888-268

Spanner

Code

19-888-272

Positioning Rod

Code

19-888-269

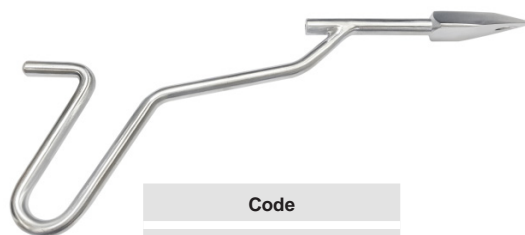
Bone Awl, Cannulated for Femur Nails

Code

19-888-273

Drill Bit with Stopper, 4.0mm (for Locking Bolt)



Code
19-888-283

Reamer Head, 13.0mm

19-888-274



Reamer Head, 12.5mm

19-888-275



Drill Bit with Stopper, 4.0mm (for Locking Bolt)



Code
19-888-284

Reamer Head, 12.0mm

19-888-276



Reamer Head, 11.5mm

19-888-277



Entry Reamer



Code
19-888-285

Reamer Head, 11.0mm

19-888-278



Reamer Head, 10.5mm

19-888-279



Reduction Rod (For Guide Rod)



Code
19-888-286

Reamer Head, 10.0mm

19-888-280



Reamer Head, 9.5mm

19-888-281



Fleximal Shaft (for Reamer Head, 9 to 12mm)



Code
19-888-287

Reamer Head, 9.0mm

19-888-282



Proximal Target Device with Nail connector

Code

19-888-288

Distal Positioning Frame

Code

19-888-289

T-type quick coupling handle

Code

19-888-290

Positioning block

Code

19-888-291

Trocar

Code

19-888-292

Distal Targeting Attachment

Code

19-888-293

Screw Measuring Device for Locking Bolt

Code

19-888-294

Sliding Hammer

Code

19-888-295

Universal Adapter

Code

19-888-296

Impacting Handle



Code
19-888-297

Connecting Nut (For Targetting Device)



Code
19-888-301

Trocar (For Drill Sleeve, 4.0mm)



Code
19-888-298

Sleeve for Entry Reamer



Code
19-888-302

Guide Rod with olive, 2.5mm



Code
19-888-299

Proximal Hole Attachment



Code
19-888-303

Nail holding Bolt



Code
19-888-300

Guide Wire Introducer



Code
19-888-304

09

"UNO Tro-16mm" Trochanteric Interlocking Nail



MCM Pro."UNO Tro-16mm" Trochanteric Nail, Dia.16mm x 180mm



Angle	Titanium Titan
120°	19-230-120
125°	19-230-125
130°	19-230-130

Plug for MCM Pro."UNO Tro-16mm" Trochanteric Nail, TITANIUM



Code
19-232-100

Lag Screw 11mm for MCM Pro."UNO Tro-16mm" Trochanteric Nail



Length	Titanium Titan
70mm	19-231-070
75mm	19-231-075
80mm	19-231-080
85mm	19-231-085
90mm	19-231-090
95mm	19-231-095
100mm	19-231-100
105mm	19-231-105
110mm	19-231-110
115mm	19-231-115
120mm	19-231-120

Blocking Screw for MCM Pro."UNO Tro-16mm" Trochanteric Nail,TITANIUM



Code
19-233-100

Locking Screw 5.0mm for for MCM Pro."UNO Tro- 16mm" Trochanteric Nail,TITANIUM



Length	Titanium Titan
25.0mm	19-234-5025
27.5mm	19-234-5027
30.0mm	19-234-5030
32.5mm	19-234-5032
35.0mm	19-234-5035
37.5mm	19-234-5037
40.0mm	19-234-5040
42.5mm	19-234-5042
45.0mm	19-234-5045
50.0mm	19-234-5050

Locking Screw 5.0mm for for MCM Pro."UNO Tro-16mm" Trochanteric Nail

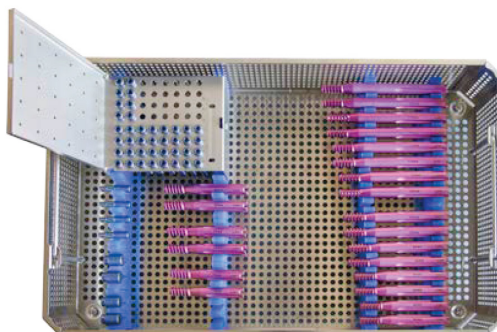

Code
19-999-060

Item	Code	QTY
Empty Tray for individual MCM Pro."UNO Tro-16mm" Trochanteric Nail,TITANIUM	19-998-060	1
MCM Pro."UNO Tro-16mm" Trochanteric Nail, Dia.16mm x 180mm x 120° TITANIUM	19-230-120	2
MCM Pro."UNO Tro-16mm" Trochanteric Nail, Dia.16mm x 180mm x 125° TITANIUM	19-230-125	2
MCM Pro."UNO Tro-16mm" Trochanteric Nail, Dia.16mm x 180mm x 130° TITANIUM	19-230-130	2
Lag Screw 11mm x 70mm for MCM Pro."UNO Tro-16mm" Trochanteric Nail,TITANIUM	19-231-070	2
Lag Screw 11mm x 75mm for MCM Pro."UNO Tro-16mm" Trochanteric Nail,TITANIUM	19-231-075	2
Lag Screw 11mm x 80mm for MCM Pro."UNO Tro-16mm" Trochanteric Nail,TITANIUM	19-231-080	2
Lag Screw 11mm x 85mm for MCM Pro."UNO Tro-16mm" Trochanteric Nail,TITANIUM	19-231-085	2
Lag Screw 11mm x 90mm for MCM Pro."UNO Tro-16mm" Trochanteric Nail,TITANIUM	19-231-090	2
Lag Screw 11mm x 95mm for MCM Pro."UNO Tro-16mm" Trochanteric Nail,TITANIUM	19-231-095	2
Lag Screw 11mm x 100mm for MCM Pro."UNO Tro-16mm" Trochanteric Nail,TITANIUM	19-231-100	2
Lag Screw 11mm x 105mm for MCM Pro."UNO Tro-16mm" Trochanteric Nail,TITANIUM	19-231-105	2
Lag Screw 11mm x 110mm for MCM Pro."UNO Tro-16mm" Trochanteric Nail,TITANIUM	19-231-110	2
Lag Screw 11mm x 115mm for MCM Pro."UNO Tro-16mm" Trochanteric Nail,TITANIUM	19-231-115	2
Lag Screw 11mm x 120mm for MCM Pro."UNO Tro-16mm" Trochanteric Nail,TITANIUM	19-231-120	2
Plug for MCM Pro."UNO Tro-16mm" Trochanteric Nail,TITANIUM	19-232-100	4
Blocking Screw for MCM Pro."UNO Tro-16mm" Trochanteric Nail,TITANIUM	19-233-100	4
Locking Screw 5.0mm x 25mm for for MCM Pro."UNO Tro-16mm" Trochanteric Nail,TITANIUM	19-234-5025	4
Locking Screw 5.0mm x 27.5mm for for MCM Pro."UNO Tro-16mm" Trochanteric Nail,TITANIUM	19-234-5027	4
Locking Screw 5.0mm x 30mm for for MCM Pro."UNO Tro-16mm" Trochanteric Nail,TITANIUM	19-234-5030	4
Locking Screw 5.0mm x 32.5mm for for MCM Pro."UNO Tro-16mm" Trochanteric Nail,TITANIUM	19-234-5032	4
Locking Screw 5.0mm x 35mm for for MCM Pro."UNO Tro-16mm" Trochanteric Nail,TITANIUM	19-234-5035	4
Locking Screw 5.0mm x 37.5mm for for MCM Pro."UNO Tro-16mm" Trochanteric Nail,TITANIUM	19-234-5037	4
Locking Screw 5.0mm x 40mm for for MCM Pro."UNO Tro-16mm" Trochanteric Nail,TITANIUM	19-234-5040	4
Locking Screw 5.0mm x 42.5mm for for MCM Pro."UNO Tro-16mm" Trochanteric Nail,TITANIUM	19-234-5042	4
Locking Screw 5.0mm x 45mm for for MCM Pro."UNO Tro-16mm" Trochanteric Nail,TITANIUM	19-234-5045	4
Locking Screw 5.0mm x 50mm for for MCM Pro."UNO Tro-16mm" Trochanteric Nail,TITANIUM	19-234-5050	4

Basic Instrumentation Set for "UNO Tro-16mm" Trochanteric Nail

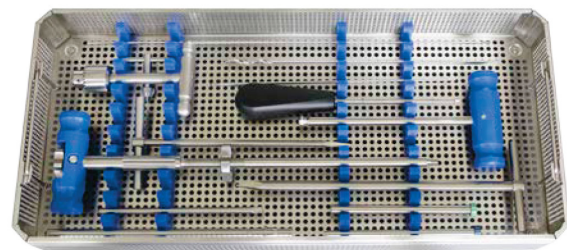
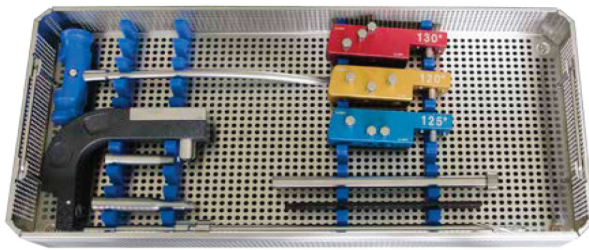

Code

19-999-070

Item	Code	QTY
Tray for for "UNO Tro-16mm" Trochanteric Nail, Instrumentation Set	19-888-310	2
Proximal Targeting device for "UNO Tro-16mm" Trochanteric Nail, (carbon)	19-888-311	1
Changeble part for "UNO Tro-16mm" Trochanteric Nail, Sytem 120° (aluminum)	19-888-312	1
Changeble part for "UNO Tro-16mm" Trochanteric Nail, Sytem 125° (aluminum)	19-888-313	1
Changeble part for "UNO Tro-16mm" Trochanteric Nail, Sytem 130° (aluminum)	19-888-314	1
Reamer for "UNO Tro-16mm" Trochanteric Nail, Lag screw	19-888-315	1
Screw driver for "UNO Tro-16mm" Trochanteric Nail,	19-888-316	1
Screw driver for "UNO Tro-16mm" Trochanteric Nail, Lag screw	19-888-317	1
Sleeve for reamer for "UNO Tro-16mm" Trochanteric Nail, Lag screw	19-888-318	1
Sleeve for guide wire for "UNO Tro-16mm" Trochanteric Nail,	19-888-319	1
Distal guide sleeve for "UNO Tro-16mm" Trochanteric Nail,	19-888-320	1
Guide wire Ø3,2 mm for "UNO Tro-16mm" Trochanteric Nail, lag screw	19-888-321	1
Anti rotation wire Ø3,2 mm for "UNO Tro-16mm" Trochanteric Nail,	19-888-322	1
Cannulated awl for "UNO Tro-16mm" Trochanteric Nail,	19-888-323	1
Reamer Ø4,8 mm / Length 305 mm for "UNO Tro-16mm" Trochanteric Nail,	19-888-324	1
Trocar Ø11,0 mm for "UNO Tro-16mm" Trochanteric Nail,	19-888-325	1
Trocar Ø8,0 mm for "UNO Tro-16mm" Trochanteric Nail,	19-888-326	1
Measuring device for "UNO Tro-16mm" Trochanteric Nail,	19-888-327	1
Universal Chuck with key cannulated 4,1 mm complete with T-Handle	19-888-328	1
Hexagonal screw driver for "UNO Tro-16mm" Trochanteric Nail,	19-888-329	1
Drill sleeve green 8,0 mm for "UNO Tro-16mm" Trochanteric Nail,	19-888-330	1
Drill sleeve blue 4,8 mm for "UNO Tro-16mm" Trochanteric Nail,	19-888-331	1
Tray 540 x 255 x 50 mm (perforated) for "UNO Tro-16mm" Trochanteric Nail,	19-888-332	1
Tray 540 x 255 x 70 mm (perforated) for "UNO Tro-16mm" Trochanteric Nail,	19-888-333	1
Standard Silicone device for "UNO Tro-16mm" Trochanteric Nail,	19-888-334	1
Lid for tray 540 x 255 mm for "UNO Tro-16mm" Trochanteric Nail,	19-888-335	1

Proximal Targeting device for "UNO Tro-16mm" Trochanteric Nail, (carbon)



Code
19-888-311

Screw driver for "UNO Tro-16mm" Trochanteric Nail,



Code
19-888-316

Changeable part for "UNO Tro-16mm" Trochanteric Nail, Sytem 120° (aluminum)



Angle	Code
120°	19-888-312
125°	19-888-313
130°	19-888-314

Screw driver for "UNO Tro-16mm" Trochanteric Nail, Lag screw



Code
19-888-317

Reamer for "UNO Tro-16mm" Trochanteric Nail, Lag screw



Code
19-888-315

Sleeve for reamer for "UNO Tro-16mm" Trochanteric Nail, Lag screw

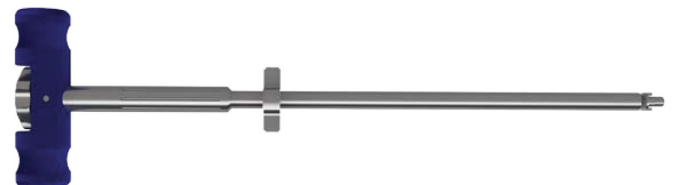

Code
19-888-318

Sleeve for guide wire for "UNO Tro-16mm"
Trochanteric Nail,



Code

19-888-319

Cannulated awl for "UNO Tro-16mm"
Trochanteric Nail,

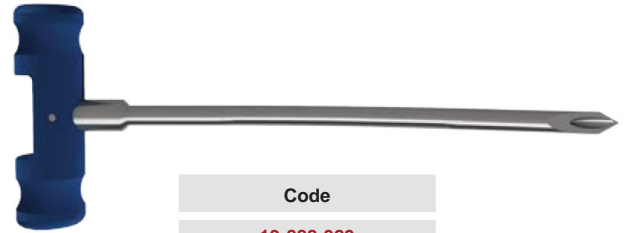

Code

19-888-323

Distal guide sleeve for "UNO Tro-16mm"
Trochanteric Nail,



Code

19-888-320

Reamer Ø4,8 mm / Length 305 mm for "UNO
Tro-16mm" Trochanteric Nail,



Code

19-888-324

Guide wire Ø3,2 mm for "UNO Tro-16mm"
Trochanteric Nail, lag screw



Code

19-888-321

Trocar Ø11,0 mm for "UNO Tro-16mm"
Trochanteric Nail,



Code

19-888-325

Anti rotation wire Ø3,2 mm for "UNO Tro-16mm"
Trochanteric Nail,



Code

19-888-322

Trocar Ø8,0 mm for "UNO Tro-16mm"
Trochanteric Nail,

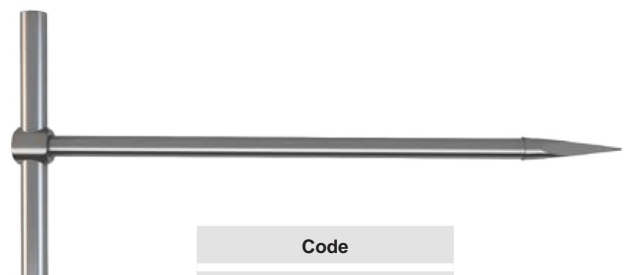

Code

19-888-326

**Measuring device for "UNO Tro-16mm"
Trochanteric Nail,**



Code

19-888-327

**Universal Chuck with key cannulated 4,1 mm
complete with T-Handle**



Code

19-888-328

**Hexagonal screw driver for "UNO Tro-16mm"
Trochanteric Nail,**



Code

19-888-329

**Drill sleeve green 8,0 mm for "UNO Tro-16mm"
Trochanteric Nail,**



Code

19-888-330

\\ 10

"Esperto Gama" Gamma
Interlocking Nail



MCM Pro. "Esperto Gama" Anti -Rotation Short Gamma Nail, Dia. 11mm

Length Länge	Dia	Stainless steel Rostfreier Stahl	Titanium Titan
180mm	9mm	19-116-0918	19-116-0918T
200mm	9mm	19-116-0920	19-116-0920T
220mm	9mm	19-116-0922	19-116-0922T
240mm	9mm	19-116-0924	19-116-0924T
180mm	10mm	19-116-1018	19-116-1018T
200mm	10mm	19-116-1020	19-116-1020T
220mm	10mm	19-116-1022	19-116-1022T
240mm	10mm	19-116-1024	19-116-1024T
180mm	11mm	19-116-1118	19-116-1118T
200mm	11mm	19-116-1120	19-116-1120T
220mm	11mm	19-116-1122	19-116-1122T
240mm	11mm	19-116-1124	19-116-1124T
180mm	12mm	19-116-1218	19-116-1218T
200mm	12mm	19-116-1220	19-116-1220T
220mm	12mm	19-116-1222	19-116-1222T
240mm	12mm	19-116-1224	19-116-1224T
180mm	13mm	19-116-1318	19-116-1318T
200mm	13mm	19-116-1320	19-116-1320T
220mm	13mm	19-116-1322	19-116-1322T
240mm	13mm	19-116-1324	19-116-1324T

Nail Cap Length for MCM Pro. "Esperto Gama"
Gamma Nail

Length Länge	Stainless steel Rostfreier Stahl	Titanium Titan
26mm	19-116-0918	19-116-0918T
28mm	19-116-0920	19-116-0920T
30mm	19-116-0922	19-116-0922T
32mm	19-116-0924	19-116-0924T

MCM Pro. "Esperto Gama" Anti -Rotation Long Gamma Nail

Left - Links				Right - Rechts			
Length Länge	Dia	Stainless steel Rostfreier Stahl	Titanium Titan	Length Länge	Dia	Stainless steel Rostfreier Stahl	Titanium Titan
320mm	9mm	19-118-0932L	19-118-0932LT	320mm	9mm	19-118-0932R	19-118-0932RT
340mm	9mm	19-118-0934L	19-118-0934LT	340mm	9mm	19-118-0934R	19-118-0934RT
360mm	9mm	19-118-0936L	19-118-0936LT	360mm	9mm	19-118-0936R	19-118-0936RT
380mm	9mm	19-118-0938L	19-118-0938LT	380mm	9mm	19-118-0938R	19-118-0938RT
400mm	9mm	19-118-0940L	19-118-0940LT	400mm	9mm	19-118-0940R	19-118-0940RT
420mm	9mm	19-118-0942L	19-118-0942LT	420mm	9mm	19-118-0942R	19-118-0942RT
440mm	9mm	19-118-0944L	19-118-0944LT	440mm	9mm	19-118-0944R	19-118-0944RT
320mm	10mm	19-118-1032L	19-118-1032LT	320mm	10mm	19-118-1032R	19-118-1032RT
340mm	10mm	19-118-1034L	19-118-1034LT	340mm	10mm	19-118-1034R	19-118-1034RT
360mm	10mm	19-118-1036L	19-118-1036LT	360mm	10mm	19-118-1036R	19-118-1036RT
380mm	10mm	19-118-1038L	19-118-1038LT	380mm	10mm	19-118-1038R	19-118-1038RT
400mm	10mm	19-118-1040L	19-118-1040LT	400mm	10mm	19-118-1040R	19-118-1040RT
420mm	10mm	19-118-1042L	19-118-1042LT	420mm	10mm	19-118-1042R	19-118-1042RT
440mm	10mm	19-118-1044L	19-118-1044LT	440mm	10mm	19-118-1044R	19-118-1044RT
320mm	11mm	19-118-1132L	19-118-1132LT	320mm	11mm	19-118-1132R	19-118-1132RT
340mm	11mm	19-118-1134L	19-118-1134LT	340mm	11mm	19-118-1134R	19-118-1134RT
360mm	11mm	19-118-1136L	19-118-1136LT	360mm	11mm	19-118-1136R	19-118-1136RT
380mm	11mm	19-118-1138L	19-118-1138LT	380mm	11mm	19-118-1138R	19-118-1138RT
400mm	11mm	19-118-1140L	19-118-1140LT	400mm	11mm	19-118-1140R	19-118-1140RT
420mm	11mm	19-118-1142L	19-118-1142LT	420mm	11mm	19-118-1142R	19-118-1142RT
440mm	11mm	19-118-1144L	19-118-1144LT	440mm	11mm	19-118-1144R	19-118-1144RT
320mm	12mm	19-118-1232L	19-118-1232LT	320mm	12mm	19-118-1232R	19-118-1232RT
340mm	12mm	19-118-1234L	19-118-1234LT	340mm	12mm	19-118-1234R	19-118-1234RT
360mm	12mm	19-118-1236L	19-118-1236LT	360mm	12mm	19-118-1236R	19-118-1236RT
380mm	12mm	19-118-1238L	19-118-1238LT	380mm	12mm	19-118-1238R	19-118-1238RT
400mm	12mm	19-118-1240L	19-118-1240LT	400mm	12mm	19-118-1240R	19-118-1240RT
420mm	12mm	19-118-1242L	19-118-1242LT	420mm	12mm	19-118-1242R	19-118-1242RT
440mm	12mm	19-118-1244L	19-118-1244LT	440mm	12mm	19-118-1244R	19-118-1244RT
320mm	13mm	19-118-1332L	19-118-1332LT	320mm	13mm	19-118-1332R	19-118-1332RT
340mm	13mm	19-118-1334L	19-118-1334LT	340mm	13mm	19-118-1334R	19-118-1334RT
360mm	13mm	19-118-1336L	19-118-1336LT	360mm	13mm	19-118-1336R	19-118-1336RT
380mm	13mm	19-118-1338L	19-118-1338LT	380mm	13mm	19-118-1338R	19-118-1338RT
400mm	13mm	19-118-1340L	19-118-1340LT	400mm	13mm	19-118-1340R	19-118-1340RT
420mm	13mm	19-118-1342L	19-118-1342LT	420mm	13mm	19-118-1342R	19-118-1342RT
440mm	13mm	19-118-1344L	19-118-1344LT	440mm	13mm	19-118-1344R	19-118-1344RT



Lock Screw 4.8mm for MCM Pro. "Esperto Gama-Comodo Gama" Gamma Nail



Length Länge	Stainless steel Rostfreier Stahl	Titanium Titan
26mm	19-122-26	19-122-26T
28mm	19-122-28	19-122-28T
30mm	19-122-30	19-122-30T
32mm	19-122-32	19-122-32T
34mm	19-122-34	19-122-34T
36mm	19-122-36	19-122-36T
38mm	19-122-38	19-122-38T
40mm	19-122-40	19-122-40T
42mm	19-122-42	19-122-42T
44mm	19-122-44	19-122-44T
46mm	19-122-46	19-122-46T
48mm	19-122-48	19-122-48T
50mm	19-122-50	19-122-50T
52mm	19-122-52	19-122-52T
54mm	19-122-54	19-122-54T
56mm	19-122-56	19-122-56T
58mm	19-122-58	19-122-58T
60mm	19-122-60	19-122-60T
65mm	19-122-65	19-122-65T
70mm	19-122-70	19-122-70T
75mm	19-122-75	19-122-75T
80mm	19-122-80	19-122-80T
85mm	19-122-85	19-122-85T
90mm	19-122-90	19-122-90T

Lag Screw 10.5mm for MCM Pro. "Esperto Gama-Comodo Gama" Gamma Nail



Length Länge	Stainless steel Rostfreier Stahl	Titanium Titan
70mm	19-116-0918	19-116-0918T
75mm	19-116-0920	19-116-0920T
80mm	19-116-0922	19-116-0922T
85mm	19-116-0924	19-116-0924T
90mm	19-116-1018	19-116-1018T
95mm	19-116-1020	19-116-1020T
100mm	19-116-1022	19-116-1022T
105mm	19-116-1024	19-116-1024T
110mm	19-116-1018	19-116-1018T
115mm	19-116-1020	19-116-1020T
120mm	19-116-1022	19-116-1022T

Cann. Anti Rotation Screw 6.4mm for MCM Pro. "Esperto Gama" Gamma Nail



Length Länge	Stainless steel Rostfreier Stahl	Titanium Titan
60mm	19-121-060	19-121-060T
65mm	19-121-065	19-121-065T
70mm	19-121-070	19-121-070T
75mm	19-121-075	19-121-075T
80mm	19-121-080	19-121-080T
85mm	19-121-085	19-121-085T
90mm	19-121-090	19-121-090T
95mm	19-121-095	19-121-095T
100mm	19-121-100	19-121-100T
105mm	19-121-105	19-121-105T
110mm	19-121-110	19-121-110T
115mm	19-121-115	19-121-115T
120mm	19-121-120	19-121-120T



11

"Comodo Gama" Gamma Interlocking Nail



MCM Pro. "Comodo Gama" Short Gamma Nail, Dia.

Length Länge	Stainless steel Rostfreier Stahl	Titanium Titan
180mm	19-117-0918	19-117-0918T
200mm	19-117-0920	19-117-0920T
220mm	19-117-0922	19-117-0922T
240mm	19-117-0924	19-117-0924T
180mm	19-117-1018	19-117-1018T
200mm	19-117-1020	19-117-1020T
220mm	19-117-1022	19-117-1022T
240mm	19-117-1024	19-117-1024T
180mm	19-117-1118	19-117-1118T
200mm	19-117-1120	19-117-1120T
220mm	19-117-1122	19-117-1122T
240mm	19-117-1124	19-117-1124T
180mm	19-117-1218	19-117-1218T
200mm	19-117-1220	19-117-1220T
220mm	19-117-1222	19-117-1222T
240mm	19-117-1224	19-117-1224T
180mm	19-117-1318	19-117-1318T
200mm	19-117-1320	19-117-1320T
220mm	19-117-1322	19-117-1322T
240mm	19-117-1324	19-117-1324T

Inner Screw, for MCM Pro. "Esperto Gama"
Gamma Nail

Stainless steel Rostfreier Stahl	Titanium Titan
19-124-10	19-124-10T

MCM Pro. "Comodo Gama" Long Gamma Nail, Dia.

Left - Links				Right - Rechts			
Length Länge	Dia	Stainless steel Rostfreier Stahl	Titanium Titan	Length Länge	Dia	Stainless steel Rostfreier Stahl	Titanium Titan
320mm	9mm	19-119-0932L	19-119-0932LT	320mm	9mm	19-119-0932R	19-119-0932RT
340mm	9mm	19-119-0934L	19-119-0934LT	340mm	9mm	19-119-0934R	19-119-0934RT
360mm	9mm	19-119-0936L	19-119-0936LT	360mm	9mm	19-119-0936R	19-119-0936RT
380mm	9mm	19-119-0938L	19-119-0938LT	380mm	9mm	19-119-0938R	19-119-0938RT
400mm	9mm	19-119-0940L	19-119-0940LT	400mm	9mm	19-119-0940R	19-119-0940RT
420mm	9mm	19-119-0942L	19-119-0942LT	420mm	9mm	19-119-0942R	19-119-0942RT
440mm	9mm	19-119-0944L	19-119-0944LT	440mm	9mm	19-119-0944R	19-119-0944RT
320mm	10mm	19-119-0932L	19-119-0932LT	320mm	10mm	19-119-0932R	19-119-0932RT
340mm	10mm	19-119-1034L	19-119-1034LT	340mm	10mm	19-119-1034R	19-119-1034RT
360mm	10mm	19-119-1036L	19-119-1036LT	360mm	10mm	19-119-1036R	19-119-1036RT
380mm	10mm	19-119-1038L	19-119-1038LT	380mm	10mm	19-119-1038R	19-119-1038RT
400mm	10mm	19-119-1040L	19-119-1040LT	400mm	10mm	19-119-1040R	19-119-1040RT
420mm	10mm	19-119-1042L	19-119-1042LT	420mm	10mm	19-119-1042R	19-119-1042RT
440mm	10mm	19-119-1044L	19-119-1044LT	440mm	10mm	19-119-1044R	19-119-1044RT
320mm	11mm	19-119-1132L	19-119-1132LT	320mm	11mm	19-119-1132R	19-119-1132RT
340mm	11mm	19-119-1134L	19-119-1134LT	340mm	11mm	19-119-1134R	19-119-1134RT
360mm	11mm	19-119-1136L	19-119-1136LT	360mm	11mm	19-119-1136R	19-119-1136RT
380mm	11mm	19-119-1138L	19-119-1138LT	380mm	11mm	19-119-1138R	19-119-1138RT
400mm	11mm	19-119-1140L	19-119-1140LT	400mm	11mm	19-119-1140R	19-119-1140RT
420mm	11mm	19-119-1142L	19-119-1142LT	420mm	11mm	19-119-1142R	19-119-1142RT
440mm	11mm	19-119-1144L	19-119-1144LT	440mm	11mm	19-119-1144R	19-119-1144RT
320mm	12mm	19-119-1232L	19-119-1232LT	320mm	12mm	19-119-1232R	19-119-1232RT
340mm	12mm	19-119-1234L	19-119-1234LT	340mm	12mm	19-119-1234R	19-119-1234RT
360mm	12mm	19-119-1236L	19-119-1236LT	360mm	12mm	19-119-1236R	19-119-1236RT
380mm	12mm	19-119-1238L	19-119-1238LT	380mm	12mm	19-119-1238R	19-119-1238RT
400mm	12mm	19-119-1240L	19-119-1240LT	400mm	12mm	19-119-1240R	19-119-1240RT
420mm	12mm	19-119-1242L	19-119-1242LT	420mm	12mm	19-119-1242R	19-119-1242RT
440mm	12mm	19-119-1244L	19-119-1244LT	440mm	12mm	19-119-1244R	19-119-1244RT
320mm	13mm	19-119-1332L	19-119-1332LT	320mm	13mm	19-119-1332R	19-119-1332RT
340mm	13mm	19-119-1334L	19-119-1334LT	340mm	13mm	19-119-1334R	19-119-1334RT
360mm	13mm	19-119-1336L	19-119-1336LT	360mm	13mm	19-119-1336R	19-119-1336RT
380mm	13mm	19-119-1338L	19-119-1338LT	380mm	13mm	19-119-1338R	19-119-1338RT
400mm	13mm	19-119-1340L	19-119-1340LT	400mm	13mm	19-119-1340R	19-119-1340RT
420mm	13mm	19-119-1342L	19-119-1342LT	420mm	13mm	19-119-1342R	19-119-1342RT
440mm	13mm	19-119-1344L	19-119-1344LT	440mm	13mm	19-119-1344R	19-119-1344RT



Lag Screw 10.5mm for MCM Pro. "Esperto Gama-Comodo Gama" Gamma Nail



Length Länge	Stainless steel Rostfreier Stahl	Titanium Titan
70mm	19-120-070	19-120-070T
75mm	19-120-075	19-120-075T
80mm	19-120-080	19-120-080T
85mm	19-120-085	19-120-085T
90mm	19-120-090	19-120-090T
95mm	19-120-095	19-120-095T
100mm	19-120-100	19-120-100T
105mm	19-120-105	19-120-105T
110mm	19-120-110	19-120-110T
115mm	19-120-115	19-120-115T
120mm	19-120-120	19-120-120T

Lock Screw 4.8mm for MCM Pro. "Esperto Gama-Comodo Gama" Gamma Nail



Length Länge	Stainless steel Rostfreier Stahl	Titanium Titan
26mm	19-122-26	19-122-26T
28mm	19-122-28	19-122-28T
30mm	19-122-30	19-122-30T
32mm	19-122-32	19-122-32T
34mm	19-122-34	19-122-34T
36mm	19-122-36	19-122-36T
38mm	19-122-38	19-122-38T
40mm	19-122-40	19-122-40T
42mm	19-122-42	19-122-42T
44mm	19-122-44	19-122-44T
46mm	19-122-46	19-122-46T
48mm	19-122-48	19-122-48T
50mm	19-122-50	19-122-50T
52mm	19-122-52	19-122-52T
54mm	19-122-54	19-122-54T
56mm	19-122-56	19-122-56T
58mm	19-122-58	19-122-58T
60mm	19-122-60	19-122-60T
65mm	19-122-65	19-122-65T
70mm	19-122-70	19-122-70T
75mm	19-122-75	19-122-75T
80mm	19-122-80	19-122-80T
85mm	19-122-85	19-122-85T
90mm	19-122-90	19-122-90T

Nail Cap for MCM Pro. "Comodo Gama" Gamma Nail



Length Länge	Stainless steel Rostfreier Stahl	Titanium Titan
26mm	19-125-00	19-125-00T
28mm	19-125-05	19-125-05T
30mm	19-125-10	19-125-10T
32mm	19-125-15	19-125-15T

Set Screw, for MCM Pro. "Comodo Gama" Gamma Nail



Stainless steel Rostfreier Stahl	Titanium Titan
19-126-10	19-126-10T

Basic Instrumentation Set for MCM Pro. "Esperto Gama-Comodo Gama" Gamma Nail

Set Code 19-999-080

Radio Graphic Ruler



Code
19-888-340

Guide Sleeve



Code
19-888-342

Ball Tip Guide Wire



Code
19-888-343

Protection Sleeve



Code
19-888-341

Flexible Reamer



Dia	Code
10mm	19-888-344
11mm	19-888-345
12mm	19-888-346
13mm	19-888-347

T Handle with Quick Coupling

Code

19-888-348

Insertion Handle

Code

19-888-352

Entry Reamer, Cannulated

Code

19-888-349

Nail Holding Bolt

Code

19-888-353

Cannulated Awl

Code

19-888-350

Guide Wire Holder

Code

19-888-354

Tissue Protector

Code

19-888-351

Insertion Connecting Rod

Code

19-888-355

Combination Wrench



Code
19-888-356

Trocar for Distal Locking



Code
19-888-360

Insertion Hammer



Code
19-888-357

Drill Sleeve, 0 4.3mm (for Distal Locking Screw)



Code
19-888-361

Proximal Targeting Device



Code
19-888-358

Distal Targeting Device



Code
19-888-362

Protection Sleeve (for Distal Locking Screw)



Code
19-888-359

Sliding Hammer



Code
19-888-363

Screw Driver, SW 3.5 (for End Cap)

Code

19-888-364

Trocar Sleeve, (for Cephalic Screw)

Code

19-888-368

Allen Wrench

Code

19-888-365

Trocar (for Cephalic Screw)

Code

19-888-369

Hex Screw Driver , SW7.0

Code

19-888-366

Measuring Device (for Cephalic Screw)

Code

19-888-370

Protection Sleeve (for Cephalic Screw)

Code

19-888-367

Insertor (for Cephalic Screw)

Code

19-888-371

Screw Driver SW3.5 (for Distal Locking Screw)

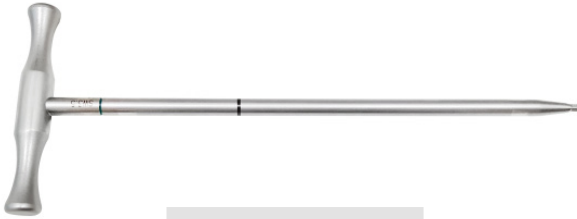

Code
19-888-372

Measuring Device (for Anti-Rotation Screw)



Code
19-888-376

Driver for Nail Holding Bolt



Code
19-888-373

Protection Sleeve (for Anti-Rotation Screw)



Code
19-888-377

Proximal Cortex Cannulated Drill, 010mm



Code
19-888-374

Trocar Sleeve (for Anti-Rotation Screw)



Code
19-888-378

Cannulated Drill, 010mm (for Cephalic Screw)



Code
19-888-375

Trocar (for Anti-Rotation Screw)



Code
19-888-379

Screw Driver (for Anti-Rotation Screw)

Code

19-888-380

Guide Wire, 03.0 (with Threaded Tip)

Code

19-888-384

Drill (for Anti-Rotation Screw)

Code

19-888-381

Hammering Rod (for Extraction)

Code

19-888-385

Holding Driver, SW3.5

Code

19-888-382

Depth Gauge (for Measuring upto 100mm)

Code

19-888-386

Guide Wire, 0 2.5mm

Code

19-888-383

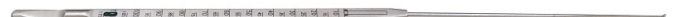
Screw Length Gauge

Code

19-888-387

Clean Brush



Code

19-888-388

Cephalic Screw Holder



Code

19-888-389

Tray



Code

19-888-244

Drill Bit, 04.3mm



Code

19-888-390

Container



Code

19-888-245

Stopper (for Drill Bit, 04.3mm)



Code

19-888-391

12

"UNO Condo" Femoral Interlocking Nail

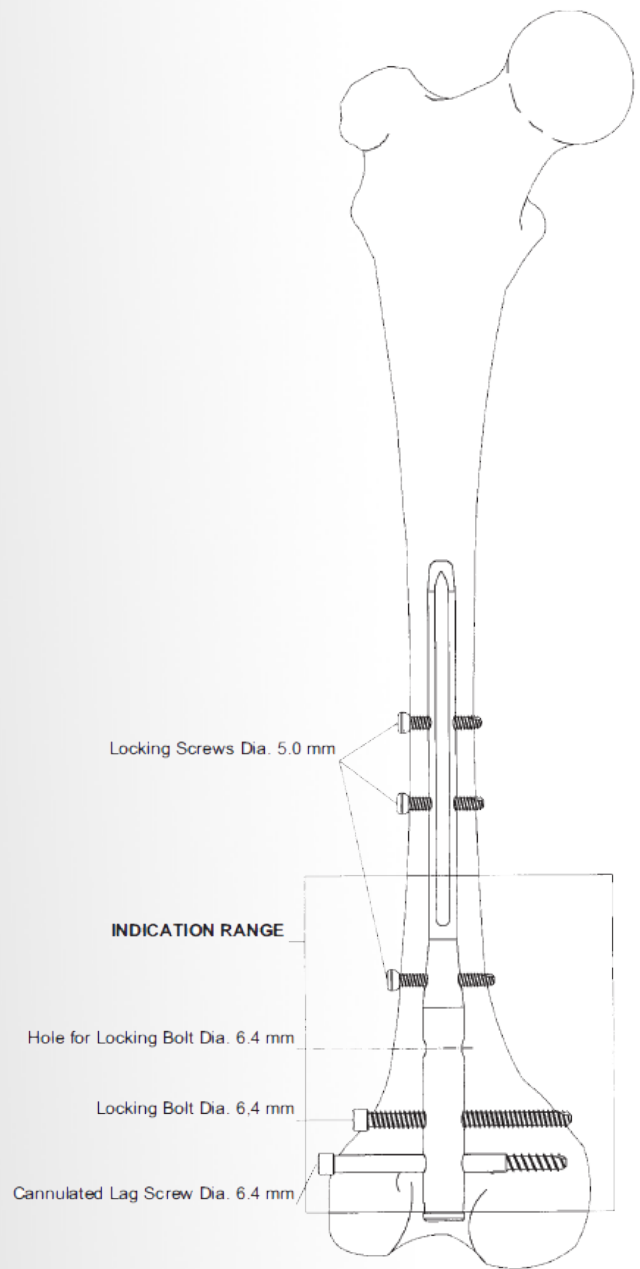

MCM Pro."UNO Condo" Femoral Condylar Nail, 240mm

Dia	Stainless steel Rostfreier Stahl
10mm	19-240-1024
11mm	19-240-1124
12mm	19-240-1224

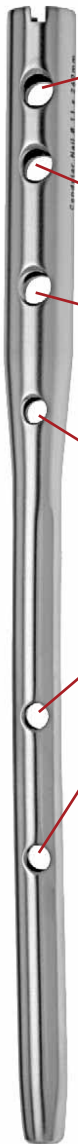
Cannulated Lag Screw
6.4mm for MCM Pro."UNO
Condo" Femoral Cond. Nail

Length Länge	Stainless steel Rostfreier Stahl
65mm	19-241-6065
70mm	19-241-6070
75mm	19-241-6075
80mm	19-241-6080
85mm	19-241-6085
90mm	19-241-6090
95mm	19-241-6095
100mm	19-241-6100
105mm	19-241-6105
110mm	19-241-6110
115mm	19-241-6115
120mm	19-241-6120
125mm	19-241-6125

Cannulated Lag Screw
6.4mm for MCM Pro."UNO
Condo" Femoral Cond. Nail

Length Länge	Stainless steel Rostfreier Stahl
25mm	19-243-5025
30mm	19-243-5030
35mm	19-243-5035
40mm	19-243-5040
45mm	19-243-5045
50mm	19-243-5050
55mm	19-243-5055
60mm	19-243-5060
65mm	19-243-5065
70mm	19-243-5070
75mm	19-243-5075
80mm	19-243-5080
85mm	19-243-5085
90mm	19-243-5090

Cannulated Lag Screw
6.4mm for MCM Pro."UNO
Condo" Femoral Cond. Nail

Length Länge	Stainless steel Rostfreier Stahl
30mm	19-242-6430
35mm	19-242-6435
40mm	19-242-6440
45mm	19-242-6445
50mm	19-242-6450
55mm	19-242-6455
60mm	19-242-6460
65mm	19-242-6465
70mm	19-242-6470
75mm	19-242-6475
80mm	19-242-6480
85mm	19-242-6485
90mm	19-242-6490



Prox./Dist. Targeting Device for MCM Pro."UNO Condo" Femoral Condylar Nail



Code

19-888-395

Bolt f. prox. Drill Guide for MCM Pro."UNO Condo" Femoral Condylar Nail



Code

19-888-396

13

"UNO Omero" Humeral Interlocking Nail



MCM Pro. "UNO Omero" Humeral Int. Nail

Length Länge	Dia	Stainless steel Rostfreier Stahl
180mm	7mm	19-250-0718
200mm	7mm	19-250-0720
220mm	7mm	19-250-0722
240mm	7mm	19-250-0724
260mm	7mm	19-250-0726
280mm	7mm	19-250-0728
300mm	7mm	19-250-0730
180mm	8mm	19-250-0818
200mm	8mm	19-250-0820
220mm	8mm	19-250-0822
240mm	8mm	19-250-0824
260mm	8mm	19-250-0826
280mm	8mm	19-250-0828
300mm	8mm	19-250-0830
180mm	9mm	19-250-0918
200mm	9mm	19-250-0920
220mm	9mm	19-250-0922
240mm	9mm	19-250-0924
260mm	9mm	19-250-0926
280mm	9mm	19-250-0928
300mm	9mm	19-250-0930



Locking Screw 4.0mm for MCM Pro. "UNO Omero" Humeral Int. Nail



Length Länge	Stainless steel Rostfreier Stahl
10mm	19-252-4010
12mm	19-252-4012
14mm	19-252-4014
16mm	19-252-4016
18mm	19-252-4018
20mm	19-252-4020
22mm	19-252-4022
24mm	19-252-4024
26mm	19-252-4026
28mm	19-252-4028
30mm	19-252-4030
32mm	19-252-4032
35mm	19-252-4035
40mm	19-252-4040
45mm	19-252-4045
50mm	19-252-4050
55mm	19-252-4055
60mm	19-252-4060

Nail Cap Dia. 9mm for MCM Pro. "UNO Omero" Humeral Int. Nail



Code

19-251-09

Humeral Proximal Drill Guide



Code

19-888-400

Drill Sleeve, 6,0 mm



Code

19-888-401

Screwdriver for V-screw 4,0mm



Code

19-888-405

Drill Sleeve 2,7 mm



Code

19-888-402

Cannulated Reamer 9,0mm



Code

19-888-406

Adaptor f. Nail Driver and Extractor



Code

19-888-403

Tip Threaded Guide Pin 3,2mm x 305mm



Code

19-888-407

Radiolucent drill Bit 2,7 x 150mm



Code

19-888-404

Nail Guide Wire 2, 500mm



Code

19-888-408

\\ 14

"Comodo Omero" Humeral Interlocking Nail



MCM Pro. "Comodo Omero" Humeral Int. Nail

Length Länge	Dia	Stainless steel Rostfreier Stahl	Titanium Titan
180mm	8mm	19-128-0818	19-128-0818T
200mm	8mm	19-128-0820	19-128-0820T
220mm	8mm	19-128-0822	19-128-0822T
240mm	8mm	19-128-0824	19-128-0824T
260mm	8mm	19-128-0826	19-128-0826T
280mm	8mm	19-128-0828	19-128-0828T
300mm	8mm	19-128-0830	19-128-0830T
320mm	8mm	19-128-0832	19-128-0832T
180mm	9mm	19-128-0918	19-128-0918T
200mm	9mm	19-128-0920	19-128-0920T
220mm	9mm	19-128-0922	19-128-0922T
240mm	9mm	19-128-0924	19-128-0924T
260mm	9mm	19-128-0926	19-128-0926T
280mm	9mm	19-128-0928	19-128-0928T
300mm	9mm	19-128-0930	19-128-0930T
320mm	9mm	19-128-0932	19-128-0932T
180mm	10mm	19-128-1018	19-128-1018T
200mm	10mm	19-128-1020	19-128-1020T
220mm	10mm	19-128-1022	19-128-1022T
240mm	10mm	19-128-1024	19-128-1024T
260mm	10mm	19-128-1026	19-128-1026T
280mm	10mm	19-128-1028	19-128-1028T
300mm	10mm	19-128-1030	19-128-1030T
320mm	10mm	19-128-1032	19-128-1032T
180mm	11mm	19-128-1118	19-128-1118T
200mm	11mm	19-128-1120	19-128-1120T
220mm	11mm	19-128-1122	19-128-1122T
240mm	11mm	19-128-1124	19-128-1124T
260mm	11mm	19-128-1126	19-128-1126T
280mm	11mm	19-128-1128	19-128-1128T
300mm	11mm	19-128-1130	19-128-1130T
320mm	11mm	19-128-1132	19-128-1132T
180mm	12mm	19-128-1218	19-128-1218T
200mm	12mm	19-128-1220	19-128-1220T
220mm	12mm	19-128-1222	19-128-1222T
240mm	12mm	19-128-1224	19-128-1224T
260mm	12mm	19-128-1226	19-128-1226T
280mm	12mm	19-128-1228	19-128-1228T
300mm	12mm	19-128-1230	19-128-1230T
320mm	12mm	19-128-1232	19-128-1232T



MCM Pro. "Comodo Omero" Humeral Int. Nail



Length Länge	Stainless steel Rostfreier Stahl	Titanium Titan
20mm	19-129-20	19-129-20T
25mm	19-129-25	19-129-25T
30mm	19-129-30	19-129-30T
35mm	19-129-35	19-129-35T
40mm	19-129-40	19-129-40T
45mm	19-129-45	19-129-45T
50mm	19-129-50	19-129-50T
55mm	19-129-55	19-129-55T
60mm	19-129-60	19-129-60T
65mm	19-129-65	19-129-65T
70mm	19-129-70	19-129-70T
75mm	19-129-75	19-129-75T
80mm	19-129-80	19-129-80T

MCM Pro. "Comodo Omero" Humeral Int. Nail



Stainless steel Rostfreier Stahl	Titanium Titan
19-130-10	19-130-10T

**Basic Instrumentation Set for MCM Pro. "Comodo Omero"
Humeral Int. Nail**

Set Code

19-999-100v

Proximal Holes Attachment



Code

19-888-420

Positioning Rod

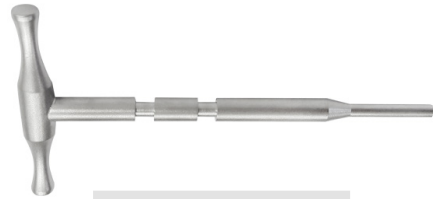

Code

19-888-423

Positioning block



Code

19-888-424

Distal Positioning Frame



Code

19-888-421

Trocar (For Drill Sleeve,4mm)



Code

19-888-425

Connecting Nut (For Targetting Device)



Code

19-888-422

Drill Sleeve,(For 5.2mm Drill Bits)

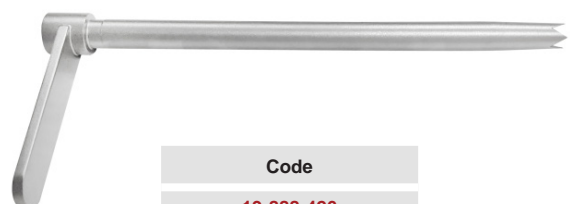

Code

19-888-426

Outer Sleeve (For Drill Sleeve 5.5mm)

Code

19-888-427

Outer Sleeve

Code

19-888-431

Drill Sleeve for 02.9mm Drill Bit

Code

19-888-428

Drill Bit, 0 2.9mm-0 3.5mm

Code

19-888-432

Proximal Target Device with Nail connector

Code

19-888-429

Distal Targeting Attachment

Code

19-888-433

Nail holding Bolt

Code

19-888-430

Bone Awl, Cannulated for Femur Nails

Code

19-888-434

Spanner



Code
19-888-435

T Handle Hex Screw Driver



Code
19-888-438

Positioning Flat Drill



Code
19-888-439

Handle, for Reamer



Code
19-888-436

Tap

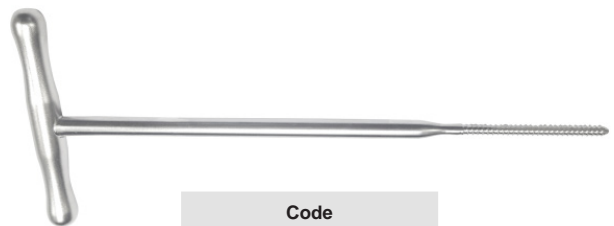

Code
19-888-440

Allen Wrench, 5mm

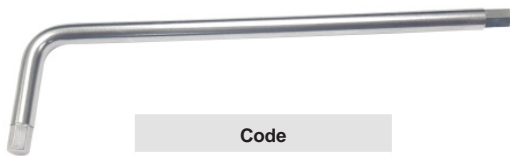

Code
19-888-437

T Handle Screw Driver



Code
19-888-441

Reamer



Dia	Code
8mm	19-888-442
9mm	19-888-443
10mm	19-888-444

Sliding Hammer



Code
19-888-445

Universal Adapter



Code
19-888-446

Tray



Code

19-888-244

Container



Code

19-888-447

15

"UNO Raggio" Ulna-Radius
Interlocking Nail

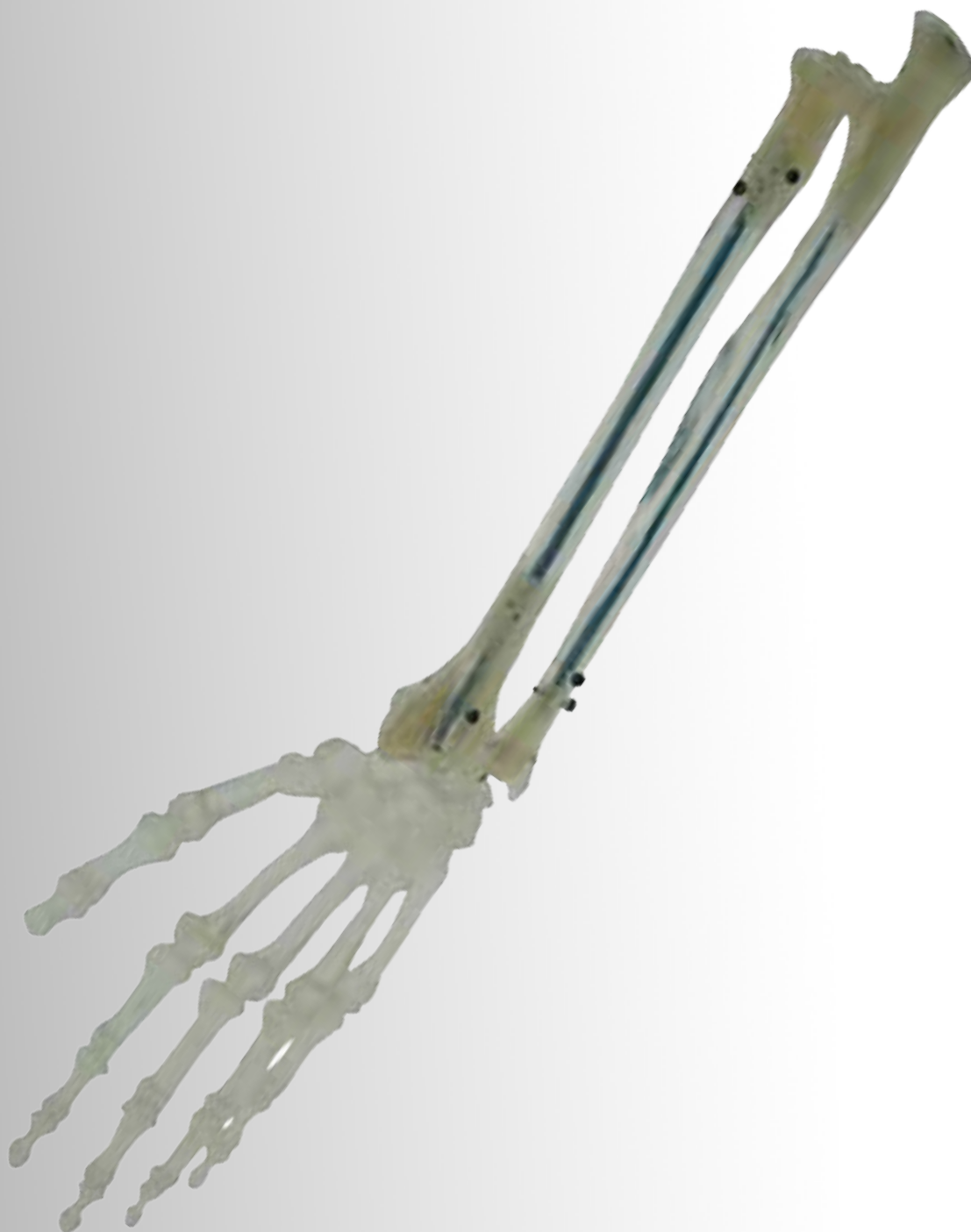

MCM Pro. "UNO Raggio" Ulna-Radius Int. Nail,

Length Länge	Dia	Titanium Titan
180mm	4mm	19-260-0418
190mm	4mm	19-260-0419
200mm	4mm	19-260-0420
210mm	4mm	19-260-0421
220mm	4mm	19-260-0422
230mm	4mm	19-260-0423
240mm	4mm	19-260-0424
250mm	4mm	19-260-0425
260mm	4mm	19-260-0426
180mm	5mm	19-260-0518
190mm	5mm	19-260-0519
200mm	5mm	19-260-0520
210mm	5mm	19-260-0521
220mm	5mm	19-260-0522
230mm	5mm	19-260-0523
240mm	5mm	19-260-0524
250mm	5mm	19-260-0525
260mm	5mm	19-260-0526



Locking Screw 2.7mm for MCM Pro. "UNO Raggio" Ulna-Radius Int. Nail



Length Länge	Stainless steel Rostfreier Stahl
14mm	19-261-2714
16mm	19-261-2716
18mm	19-261-2718v
20mm	19-261-2720
22mm	19-261-2722
24mm	19-261-2724
26mm	19-261-2726
28mm	19-261-2728
30mm	19-261-2730
32mm	19-261-2732
34mm	19-261-2734

Locking Screw 2.7/1.9mm for MCM Pro. "UNO Raggio" Ulna-Radius Int. Nail



Length Länge	Stainless steel Rostfreier Stahl
10mm	19-262-1910
12mm	19-262-1912
14mm	19-262-1914
16mm	19-262-1916
18mm	19-262-1918



Compression Screw for MCM Pro. "UNO Raggio" Ulna-Radius Int. Nail

19-263-10

Prox. Plug for MCM Pro. "UNO Raggio" Ulna-Radius Int. Nail

19-264-10

**Basic Implant Set for MCM Pro. "UNO Raggio"
Ulna-Radius Int. Nail,**

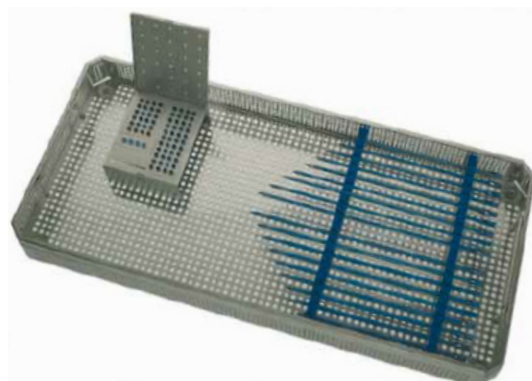

Code
19-999-110

Container



Code
19-888-447

Ulna / Radius Proximal Device



Code

19-888-460

Basic Instrumentation Set for MCM Pro. "UNO Raggio" Ulna-Radius Int. Nail,



Code

19-999-120

Slide Hammer for Ulna / Radius Nails



Code

19-888-461

Drill Sleeve, green, 8,0 mm



Code

19-888-462

Radiolucent Drill Sleeve Ø 1,9mm for Ulna / Radius Nails



Code

19-888-464

Drill Sleeve, pink, 1,9 mm



Code

19-888-463

Distal Drill Sleeve Ø 8,0mm f. Ulna / Radius Nails



Code

19-888-465

Drill Wire Ø 1,9,, Length 140mm for Ulna Radius Nail System



Code
19-888-466

Reamer with T-handle



Dia	Code
3.0mm	19-888-470
3.5mm	19-888-471
4.0mm	19-888-472
4.5mm	19-888-473
5.0mm	19-888-474
6.0mm	19-888-475

Bending Nail Template for Ulna / Radius



Code
19-888-467

Screw Driver Hexagonal 2,5mm with Selfholding Sleeve for Ulna/Radius Nail



Code
19-888-476

Screw Length Gauge f. Ulna/Radius Nails



Code
19-888-468

Nail and Rod Bending Instrument for Ulna / Radius Nails



Code
19-888-477

Cannulated Reamer Ø6,0mm, Length 150mm for Ulna Radius Nails



Code
19-888-469

Screwdriver hexagonal 2,5mm



Code
19-888-478

Open End Wrench 17/14"



Code

19-888-479

Nail Guide Wire 2, 500mm



Code

19-888-483

Screw Holding Forceps



Code

19-888-480

T - wrench - 14



Code

19-888-484

Supine Driver for Ulna / Radius Nails



Code

19-888-481

Trocar



Trocar 5.0 mm

19-888-485

Trocar 3.5 mm

19-888-486

Drill Bit AO shaft 2,0mm Dia x100/75



Code

19-888-482



\ 16

"UNO" Elastic Nail

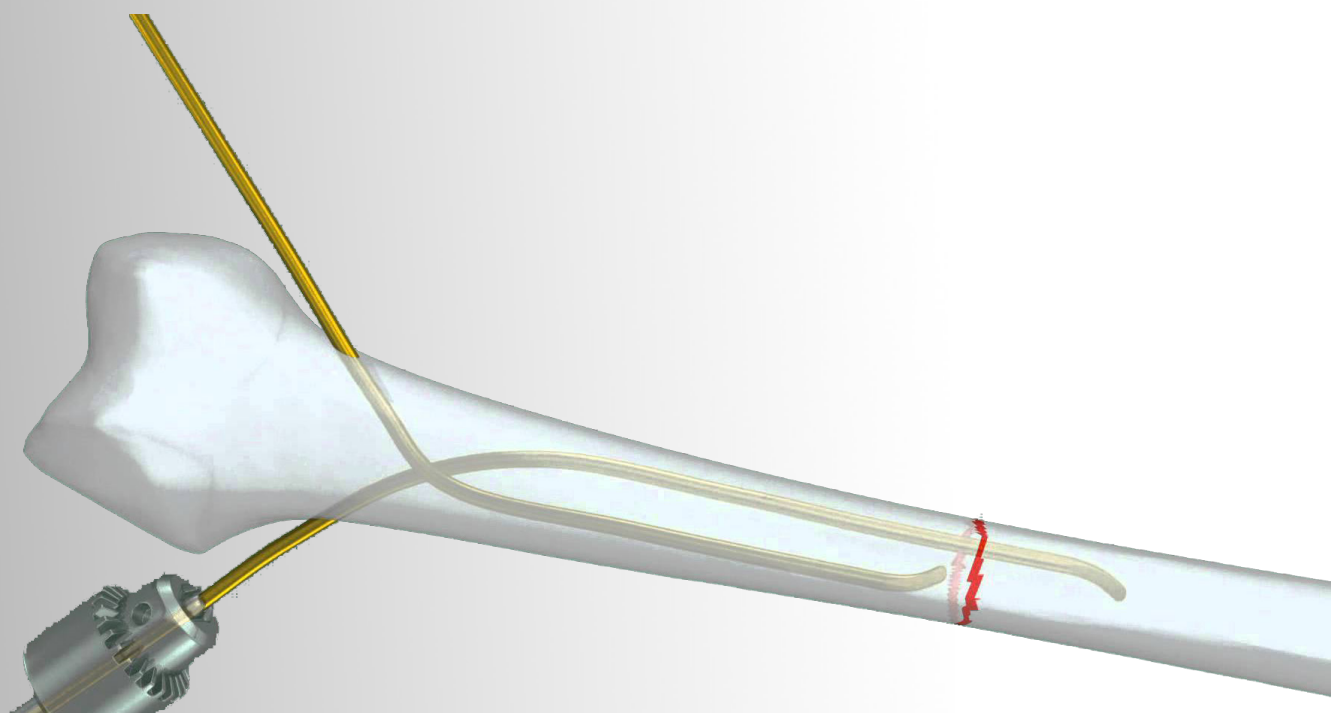

Basic Instruments Set for MCM Pro. "UNO" Elastic Nail

Set Code

19-999-170

Basic Implant Set for MCM Pro. "UNO" Elastic Nail

Set Code

19-999-180

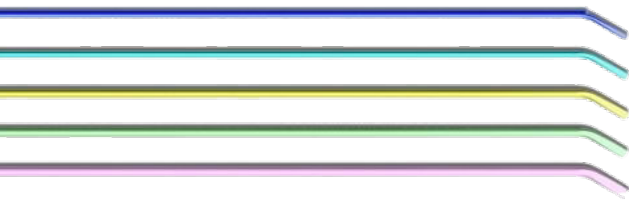
MCM Pro. "UNO" Elastic Nail , 450mm

Dia	Titanium Titan
1.5mm	19-100-15T
2.0mm	19-100-20T
2.5mm	19-100-25T
3.0mm	19-100-30T
3.5mm	19-100-35T
4.0mm	19-100-40T
4.5mm	19-100-45T
5.0mm	19-100-50T

Tray for Intramedullary Elastic Nail (empty)

Code

19-999-610

MCM Pro. "UNO" Cap for Elastic Nail

Dia	Titanium Titan
1.5mm	19-100-15C
2.0mm	19-100-20C
2.5mm	19-100-25C
3.0mm	19-100-30C
3.5mm	19-100-35C
4.0mm	19-100-40C
4.5mm	19-100-45C
5.0mm	19-100-50C

Container Alum. 580x280x100mm Lid perforated / Bottom non-perforated

Code

19-888-611

Trocar



Ø 3,5 - 5,0 mm	Ø 1,5 - 3,0 mm
19-888-612	19-888-613

Awl 16cm for MCM Pro. "UNO" Elastic Nail



Code
19-888-620

Driver for MCM Pro. "UNO" Elastic Nail

Code
19-888-617

Centering Sleeves



Dia	Code
Ø 1,5 - 2,0 mm	19-888-614
Ø 2,5 - 3,0 mm	19-888-615
Ø 3,5 - 5,0 mm	19-888-616

Extraction Forceps for MCM Pro. "UNO" Elastic Nail



Code
19-888-621

Perthes Awl



22cm	16cm
19-888-618	19-888-619

Extraction pliers for MCM Pro. "UNO" Elastic Nail



130mm	180mm
19-888-622	19-888-623

Tap handle with universal three-jaw chuck



Code

19-888-624

Nail Impactor



Dia	Code
1,5mm - 2,5mm	19-888-625
2,5mm - 3,5mm	19-888-626
3,5mm - 5,0mm	19-888-627

Bone Hammer 350g



Code

19-888-628



**Wire Cutter 220mm
3mm/2.5mm TC**



Code
19-888-629

Wire Cutter 6,0mm 575mm



Code
19-888-630

Wire Cutter 3,5mm 260mm



Code
19-888-631



\\ 17

Flexible Reamer System



Complete Flexible Reamer System Set (Hudson Connection)



Code

19-999-130

Flex. medullary reamer, Hudson

Container Alum. 580x280x135mm, Lid perforated / Bottom non-perforated



Code

19-888-490

Trays (2) empty f. flexible reamers



Code

19-888-491

	Code
6.0mm	19-888-492
6.5mm	19-888-493
7.0mm	19-888-494
7.5mm	19-888-495
8.0mm	19-888-496
8.5mm	19-888-497
9.0mm	19-888-498
9.5mm	19-888-499
10.0mm	19-888-500
10.5mm	19-888-501
11.0mm	19-888-502
11.5mm	19-888-503
12.0mm	19-888-504
12.5mm	19-888-505
13.0mm	19-888-506
13.5mm	19-888-507
14.0mm	19-888-508
14.5mm	19-888-509
15.0mm	19-888-510
15.5mm	19-888-511
16.0mm	19-888-512
16.5mm	19-888-513
17.0mm	19-888-514
17.5mm	19-888-515
18.0mm	19-888-516

Complete Flexible Reamer System Set (Aesculap Connection)



Code

19-999-150

Container Alum. 580x280x135mm, Lid perforated / Bottom non-perforated



Code

19-888-550

Medullary reamer

	Code
6.0mm	19-888-552
7.0mm	19-888-553
8.0mm	19-888-554
9.0mm	19-888-555
10.0mm	19-888-556
11.0mm	19-888-557
12.0mm	19-888-558
13.0mm	19-888-559
14.0mm	19-888-560
15.0mm	19-888-561
16.0mm	19-888-562
17.0mm	19-888-563
18.0mm	19-888-564
19.0mm	19-888-565
20.0mm	19-888-566

Trays (2) empty f. flexible reamers



Code

19-888-551

18

Interlocking Nail Systems Instruments and Devices

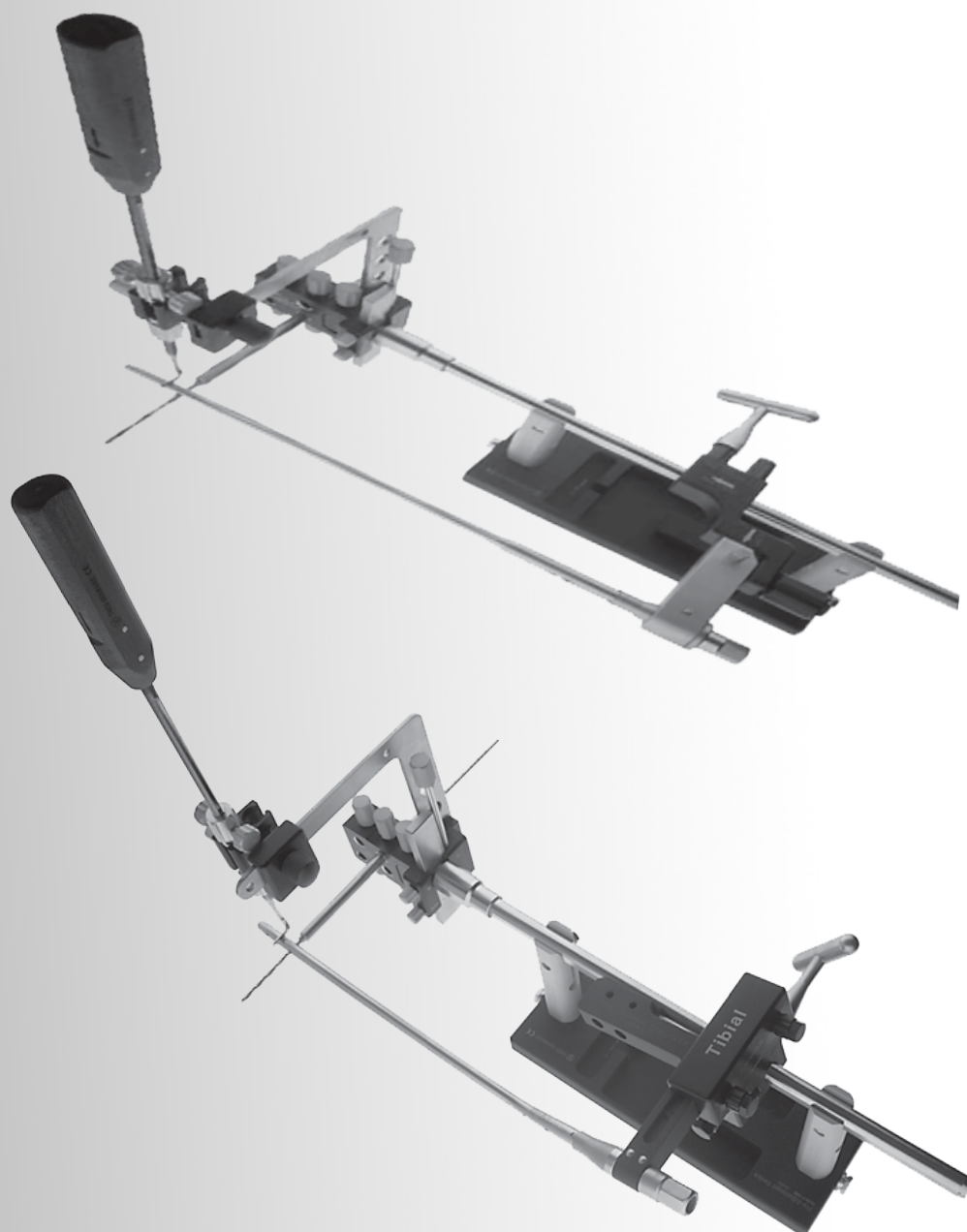

Guide Rod for Reamer 2,0 x 900 mm



Code

19-888-570

Guide Rod for Reamer 3,0 x 900mm



Code

19-888-571

Guide Rod for Reamer 3,0 x 900mm



Dia

Code

3.0mm

19-888-572

3.5mm

19-888-573

4.0mm

19-888-574

5.0mm

19-888-575

Diamond Point Awl



Femur 10 mm

19-888-576

Tibia 8 mm

19-888-577

Reamer for Femur



Code

19-888-578

Slotted Hammer width of the Slot 7mm



Code

19-888-579

Slotted Nail Driver



Code

19-888-580

Extraction Hook 5mm



Length Länge	code
29mm	19-888-584
37mm	19-888-585
43mm	19-888-586
51mm	19-888-587

Nail Driver



Dia	Code
6mm - 8mm	19-888-581
9mm - 12mm	19-888-582
13mm - 20mm	19-888-583



Extractor hook for 19-888-588

19-888-589

Nail Extractor with 2 Hooks



Code

19-888-588



Extractor hook broad for 19-888-588

19-888-560

Instrument Set for Distal Device Equipment

Set Code

19-999-160

Targeting Device



Code

19-888-591

Femur Adapter Block



Code

19-888-594

Pre-Adjustment Device



Code

19-888-592

Extension arm f. Femur + Tibia Hook



Code

19-888-595

Tibia Adapter Block



Code

19-888-593

T - wrench - 14



Code

19-888-596

Fixation Hook



Femur	Tibia
19-888-597	19-888-598

Container Alum. 580x280x135mm, Lid perforated / Bottom non-perforated



Drill guide 8,0mm with hook



Code
19-888-599

Code
19-888-490

Trays (2) empty f. flexible reamers



Item	code
Femural opening Awl for 19-888-598	19-888-601
Tibial opening Awl for 19-888-597	19-888-600



Code
19-888-551

The source of perfection

Die Quelle der Perfektion



Go to www.mcm-export.de
or simply scan the QR code
with your smartphone



M.C. Medizintechnik-Export GmbH & Co.KG
Obere Hauptstraße 40/1 78573 Wurmlingen -D
Info@mcm-export.de +4974611717971