

# *PANIGALE V4*





# Index

The science of speed	4
The Desmosedici Stradale engine	8
True chassis perfection	13
MotoGP-derived brakes	16
Aerodynamics package	19
Tailor-made racing electronics	20
Panigale V4 SP Time Attack	26
TFT dashboard	30
Riding Modes	33
Servicing and maintenance	34
Technical data and equipment	37
Accessories	48
Apparel	56
Ducati SuMisura	60

# The science of speed

Year after year, the Panigale V4 is updated and made faster and more exciting on track for both the amateur and professional rider.

For 2021, the Panigale V4 becomes Euro 5 compliant (only for countries where Euro 5 standard applies), while retaining the same maximum power and torque levels.

The electronics package is also revised and now includes the increasingly predictive, latest generation Ducati Traction Control. The Riding Mode strategy is also new, the Race Riding Mode now split into two mappings that can be easily compared in terms of individual parameters.

The Panigale V4 is equipped with the chain guard fin and new self-bleeding brake and clutch pumps derived from those used for the first time on the Superleggera V4. The new pumps also stand out for the smoke colour of the brake and clutch reservoirs.

And for those who use the bike all year round, there is now provision for heated grips, while the ignition key has a new, more modern and elegant grip.





**PANIGALE V4S**

A “user-friendly” bike, the Panigale V4 is intuitive and easy to ride. This was undoubtedly one of the toughest goals to achieve, as offering non-professional riders the chance to control the performance of a real racing bike requires full exploitation of current technology.

At the same time, it is a bike with a stiff, easy to tune chassis, equipped with an engine that, already in its standard configuration, appears kitted out for Superbike racing, agile and lightening quick to turn in and reach the apex, as only a racing bike knows how. This means it can satisfy the needs of professional riders who will find little to improve on the technical front, and many adjustments that ensure the new Panigale V4 is ‘made to measure’. Achieving outstanding results has never been within such close reach of a production bike.

# Engine

## Euro 5 Desmosedici Stradale

The Panigale V4 is powered by the Euro 5-compliant\* 1103 cc Desmosedici Stradale, a MotoGP-derived 90° V4 (banked 42° back from the horizontal), with Desmodromic timing. This one-of-a-kind engine features a counter-rotating crankshaft and Twin Pulse firing order.

To comply with the new European emissions standard, various refinements have been made to the Desmosedici Stradale exhaust line and to the engine calibration.

The silencer uses larger catalysts (+10 mm in length), while the lengths and dimensions of the exhaust primaries of the rear bank have been optimised to minimise catalytic converter 'light off' time, without altering engine performance. Compared to Euro 4 models, the rear bank manifolds have been shortened by 100 mm and reduced in diameter, going from 42 mm to 38 mm. The new component allows for the use of a more compact rear heat shield that is integrated into the body of the bike.

Emissions are also contained thanks to the introduction of four lambda probes, one for each cylinder, which allow for more refined control of the amount of injected fuel. In addition, a new Variable Intake System (VIS) strategy controls the lift of the intake trumpets.

In its Euro 5 configuration, the Desmosedici Stradale delivers 214 hp (157.5 kW) at 13,000 rpm and torque of 12.6 kgm (124.0 Nm) at 9500 rpm.

The Panigale V4 features specially developed Ride by Wire system mapping with several torque delivery control settings. Track-dedicated RbW mapping more closely aligns rider demand with delivered torque, resulting in a smoother, more predictable throttle response.

The new torque delivery control strategy lets the rider stabilise more easily on the desired throttle aperture through and out of the corners. In addition, torque curve linearisation in 1st, 2nd and 3rd gear varies according to the selected Power Mode, minimising any loss of stability during acceleration.

\*Only for countries where Euro 5 standard applies.



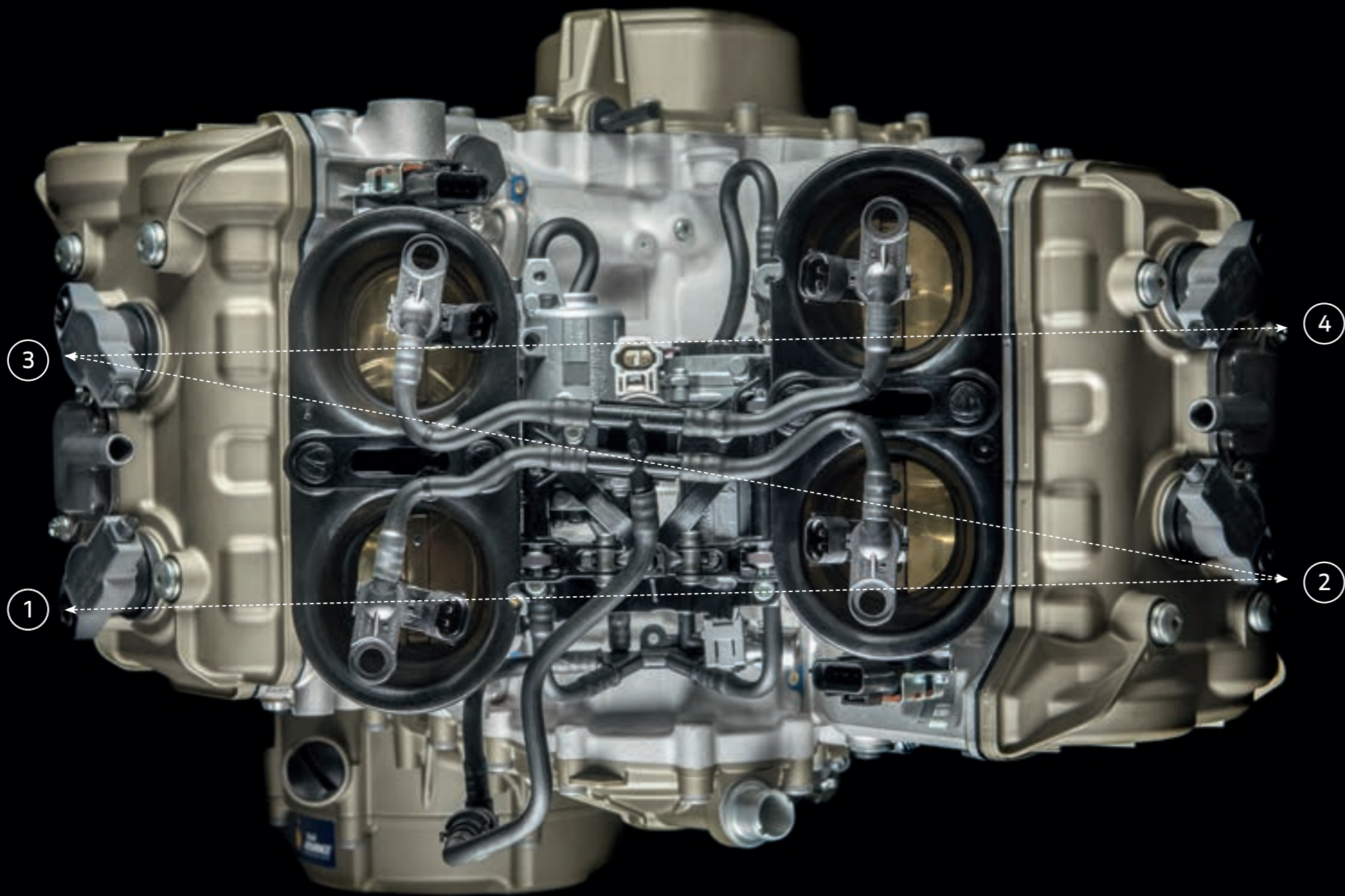

The engine is designed around the Desmodromic system, a feature that contributes to ensuring that the Ducati is the fastest prototype in the MotoGP world championship. With this high-rotation engine, the "Desmo" truly comes into its own, reaching levels of sophistication, compactness and lightness never before seen on a Ducati.

On street bikes, the crankshaft rotates in the same direction as the wheels. In contrast, in MotoGP, a counter-rotating crankshaft that rotates in the opposite direction is commonly used. The Desmosedici Stradale has borrowed this technical solution to compensate for part of the gyroscopic effect produced by the wheels, making the bike more agile when changing direction.

This geometry, combined with the 90° V engine layout, allows for a particular kind of firing order, the so-called "Twin Pulse". The peculiarity lies in the rapid firing of the two cylinders on the left side and then on the right side of the motorcycle. In the timing chart, the ignition points are at 0°, 90°, 290° and 380°. This particular firing order gives the V4 a sound that is very similar to that of the Desmosedici MotoGP.

The active (firing) phases of cylinders on either side of the engine (left and right) are extremely close together, with ignition points at 0°-90°-290°-380°. This is a tried

and tested solution that boosts traction when accelerating out of a turn. The crankshaft is a typical race component, counter-rotating with respect to the wheels and compensating in this way for any wheel lift during acceleration. Created in forged, case-hardened aluminium, it turns with the intervention of bearings (being monolithic) on three journals, while the valves are aerodynamically shaped to "cut" the lubricant with as little energy expenditure as possible, despite the semi-dry casing. Thanks to the introduction of the so-called idle wheel on the primary driveline, it is counter-rotating, thus turning in an anticlockwise direction and generating gyroscopic effects during acceleration that are the opposite of those produced by components that rotate clockwise, thus limiting the tendency to wheelie.

The wet clutch, lightweight and compact, reduces disc disengagement load and therefore the force required on the lever thanks to a progressive slipper mechanism. Gear shifting is carried out with the support of the electronic Ducati Quick Shift system, mapped with shifting times and logics for quicker, more efficient gear changes, whether the rider is up-shifting or aggressively down-shifting.



## True chassis perfection

The Panigale V4 "Front Frame" has the same specifications as the V4 R version and stands out for its lighter, machined side panels that allow Ducati Corse to meet the stiffness target required for the SBK Championship and further reduce its weight.

When used on the track, the increased flexibility of the frame reduces stress on the tyre and allows for better front end feel at maximum lean.

The aluminium alloy front end is the same as that of the Panigale V4 R but less stiff, a structural change that comes directly from Ducati Corse. The new machine finished front aluminium plates make for a more flexible fork support section, a choice that results in greater front end 'feel' for the rider.

The swingarm angle with respect to the ground is increased, as is the effect of chain pull in acceleration, meaning less rear suspension compression (so-called "squat"), which stabilises the Panigale through the longest, fastest turns.

The Panigale V4 is equipped with a 43 mm Showa Big Piston Fork (BPF) that provides fully adjustable spring pre-load and compression and rebound damping. The fork bodies house chrome stanchions to which Brembo radial callipers are affixed. The front package is completed with a Sachs steering damper. The rear boasts a fully adjustable Sachs shock absorber, attached to one side of the Desmosedici Stradale engine with a forged aluminium bracket.

The Panigale V4 S comes complete with an Öhlins NIX-30 fork, rear Öhlins TTX36 shock and an Öhlins steering damper with event-based control system. With these versions, the suspension and steering damper are controlled by the second-generation Öhlins Smart EC 2.0 system.

On both versions, the spring preload and calibration of the fork and single-sided swingarm are designed to even out pits and ripples on the asphalt. This also results in a greater load transfer to the front wheel during braking, for easier, more intuitive turn-ins, especially for the less expert rider.

The Panigale V4 mounts die-cast aluminium wheels with a 5-spoke design, while the Panigale V4 S is equipped with 3-spoke forged aluminium alloy wheels.

The wheels mount Pirelli DIABLO™ Supercorsa SP tyres, 120/70 ZR17 at the front and a revolutionary 200/60 ZR 17 at the rear. The latest version of the DIABLO™ Supercorsa SP, in its 200/60 ZR 17 size, is already widely used for the slick product in the FIM Superbike World Championship and represents a real generational leap in the field of replica racing tyres.

Innovative rear tyre profiling maximises the contact patch at maximum lean and takes full advantage of the dual compound technology used, which adopts the same SC2 compound used for racing slicks in the shoulder zone to provide race-grade grip, while still guaranteeing the stability and versatility required for road riding.





## MotoGP-derived brakes



Mechanically-speaking, braking involves 330 mm steel discs and Brembo Stylema monobloc callipers, mounted with radial attachment to the light alloy feet of the chrome fork stanchions. Cornering ABS Bosch EVO is confirmed, allowing the rider to make adjustments depending on the situation and riding style, and is uniquely equipped with the "Only Front" function that frees the rear wheel from any electronic filter while retaining Cornering ABS at the front.



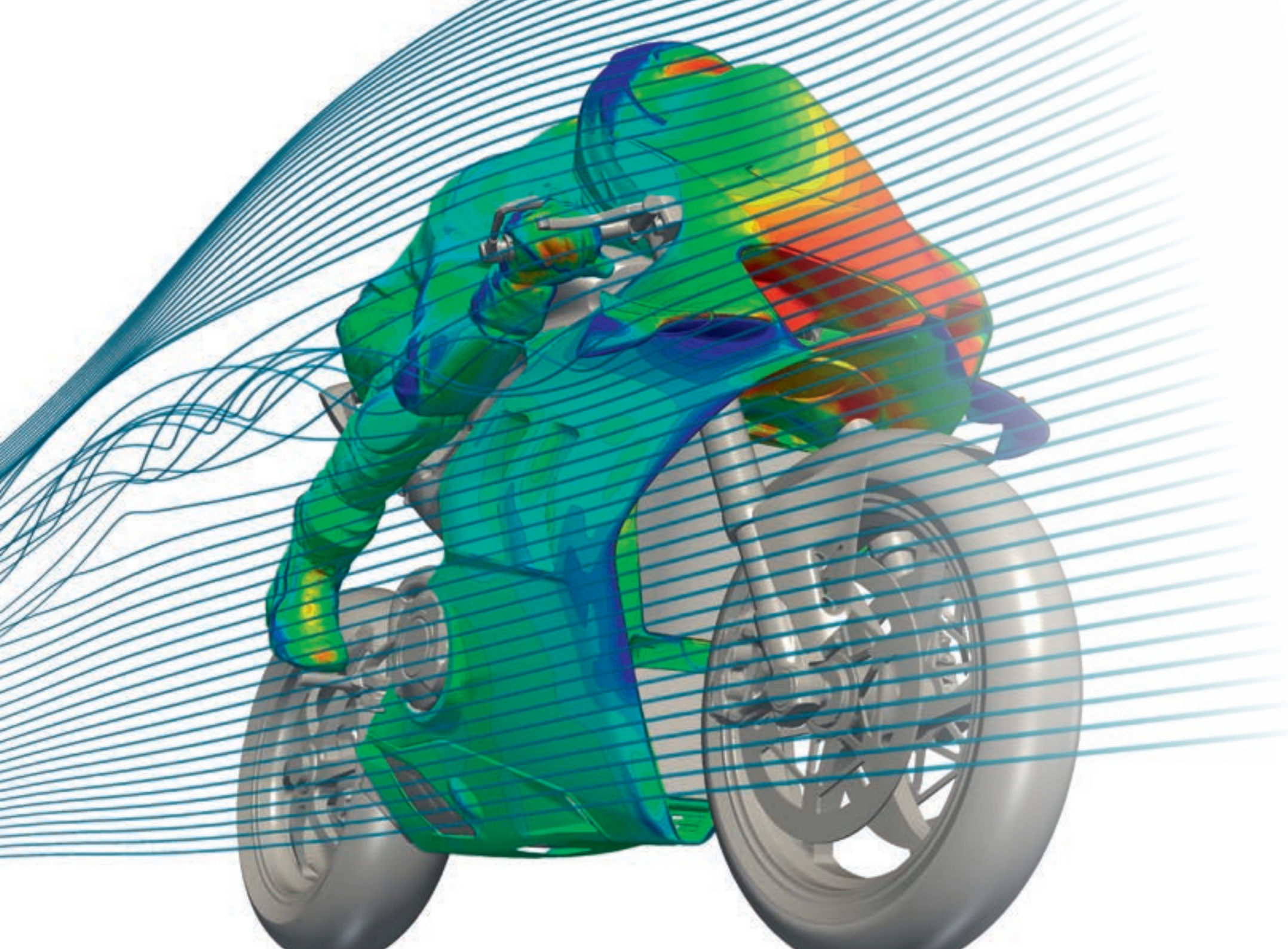

## Aerodynamics package

The brand-new Aero aerodynamics package inherited from the V4R comprises "wings" that derive from those used on Ducati MotoGP bikes until 2016, the year in which the championship regulation imposed strict limitations on these components. The aerodynamic appendages of the new Panigale V4 rely on "winglets" and "strake", profiles used for aeroplane wings that improve overall aerodynamic efficiency and generate considerable downforce. The higher, more angled top fairing, wider lateral fairings, and new air vents on the sides of the fairing all make for increased downforce, +30 kg at a speed of 270 km/h.

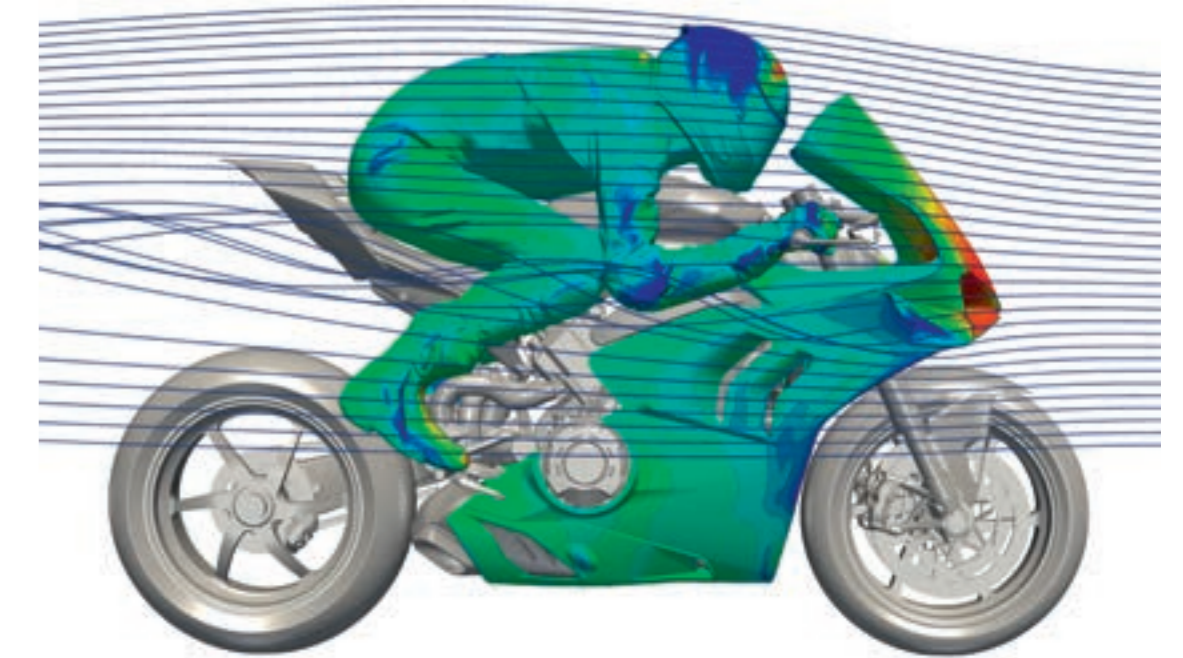

+30 kg (42%) of downforce at the front wheel at 270 km/h

- Greater aerodynamic protection
- Greater stability at high speeds
- Greater stability in and out of the corners
- Greater sensitivity at the front wheel
- Less tendency to wheelie
- Less tendency for front wheel lock during braking
- No impact on top speed

## Tailor-made racing electronics

The 2021 Panigale V4 features a new Riding Mode strategy that allows the rider to make quick comparisons between two different configurations on the track to define the best set-up. The Race Riding Mode has been split into two specific mappings for track use (Race A and Race B), now easily comparable in terms of the individual parameters, which complement the already existing Sport and Street.

Three Cornering ABS EVO settings adapt system performance to the track. By selecting level 2 or 1, the latter incorporating the Front Only function, ABS is active at the front wheel even at full lean while the rear is left free from any control. Level 3 is intended for road use or in conditions of low grip.





The MY21 Panigale V4 range is equipped with Ducati Traction Control EVO 3, its sophisticated strategy intervening as the throttle is opened mid-turn to gently manage Desmosedici Stradale recovery, modulating the torque delivered and preventing that peak that can occur following the recovery phase. This translates into easier and more predictable acceleration out of the corner.

The new software predictively adjusts the delivered torque, calibrating the angular speed of the crankshaft to make the recovery phase more fluid. This translates into a more linear acceleration out of the corner and thus a better feeling for the rider.



The DQS EVO 2 with up/down function, uses lean angle data to maximise bike stability when shifting gears through the corners. The electronic EBC EVO (Engine Brake Control) can be adjusted to work effectively with the anti-patter clutch (both the standard wet system, or the dry system, available as a Ducati Performance accessory).

This inertial platform has also allowed for the addition of slide control, something we see with MotoGP riders when the rear tyre produces that blue smoke.

Essentially, DSC (Ducati Slide Control) acts on the throttle body valves and ignition timing to ensure slide angles remain within safe limits, even when a rider requires power while leaning out of a corner. The impossible brought to a possible level.

The electronics package is rounded out with DWC EVO (Ducati Wheelie Control) and Ducati Power Launch (DPL) for blistering starts.



# Panigale V4 SP Time Attack

Ducati expands the Panigale V4 family by introducing the new numbered Panigale V4 SP version, which marks the long-awaited return of the "SP" (Sport Production) initials to the fairing of a Ducati super sports bike.

Introduced for the first time on the legendary Ducati 851, this abbreviation identified those versions that served as the base for development of the race bikes used in the Sport Production Championship, a precursor to the current Superstock.

Ducati still uses the "SP" acronym to identify a production bike with specific technical equipment that makes it faster on the track.

Thanks to its technical equipment, the Panigale V4 SP is the ideal bike for the amateur who wants to hit the track and be immediately fast. The bike is easy to ride and requires little physical effort, regardless of one's riding skills. The quality of the bike under braking is extraordinary, as is its lightness when leaning and its tendency to close the line. An amateur rider on the "SP" will be faster than if he were riding the more demanding "R" version, but the professional rider will also be able to match that performance in certain conditions or on certain types of track.





#### Lightweight chassis

In terms of its chassis, the Panigale V4 SP is equipped with state-of-the-art technical content derived from the Ducati Superleggera V4. These components include carbon wheels, exclusive Brembo Stylema R® front brake callipers, and the Brembo MCS radial master cylinder with “remote adjusting” device. This, in addition to the machined steering head that bears the progressive number of the bike and the adjustable aluminium rider footpegs with carbon heel guards.

#### "Winter test" livery

The Panigale V4 SP stands out for its pared-back “Winter Test” livery, inspired by that of the Ducati Corse bikes used during MotoGP and SBK pre-season tests. The total black look created by the matte black of the fairings and the matte black carbon rims and wings contrasts with the shine of the exposed brushed aluminium tank, while bright red accents on the tail, tank and front fairing are a nod to the traditional red of Borgo Panigale sports bikes. The seat is specific in its materials and customised with the “V4 SP” logo.



## TFT dashboard

The Panigale V4 mounts a bright, high definition (186.59 PPI - 800xRGBx480) full TFT 5" colour display with modern, eye-catching graphics.

The dashboard is dominated by the circular virtual rev counter on the right-hand side. Desmosedici Stradale revs are displayed according to a 1000-15,000 rpm scale using a needle gauge. Movement of the latter is accompanied by a white trail that acts as a 'shift light', changing colour from white to orange and then red as the rev limit approaches. Two different layouts are available to the rider. 'Track' highlights lap times and makes the rpm range used on tracks much more visible, while 'Road' replaces lap times with data relating to the Ducati Multimedia System (DMS) and its rpm scale is better suited to the rev range used on public roads. For improved readability, the (digital) indication of top speed, selected Riding Mode and selected gear retains the same position on both layouts.

As well as offering the classic menu with total mileage covered, Trip 1, Trip 2, consumption, average consumption, Trip Fuel, Trip Time, average speed, air temperature, Lap On/Off (only in "Track" mode), Player On/Off (only in "Road" mode), the Panigale V4 dash also has another menu at the bottom right which can perform two functions. Specifically, it can display/indicate parameters linked to the set Riding Mode or allow for the rapid modification of DTC, DWC, EBC and DSC parameters. Lastly, the Panigale V4 indicators are of the 'auto off' type, which means they switch off automatically after completing the turn or, if tripped accidentally, switch off after the bike has travelled in a straight line for a certain distance (from 200 to 2000 metres depending on how fast the bike is going when the indicator is switched on).







## New Riding Mode strategy

The Riding Modes allow you to choose between four different pre-set riding styles to offer the Panigale V4 behaviour that is perfectly adaptable to the rider, the type of track and the environmental conditions. Each Riding Mode (Race A, Race B, Sport and Street) is programmed to instantly change the character of the engine, the parameters of the electronic controls and, with the "S" version, also the suspension setting. Obviously, the rider is given the opportunity to customise their particular riding style and subsequently restore the parameters set by Ducati.

### **Race A Riding Mode**

Race A riding mode in its default configuration was developed for experienced riders who want to exploit the full potential of the bike on the track. By selecting Race A, the rider can count on the full power of the engine with direct Ride-by-Wire response when the throttle is opened. The electronics setting of Race A mode is designed for maximum performance on tracks with smooth asphalt and high grip, without decreasing the level of safety, with the ABS intervening only on the front wheel to offer maximum braking performance, but with the Cornering feature always active. On the "S" version, DES system adjustments offer significant dynamic control in the acceleration and braking phases to ensure stability and precision even in the most forced manoeuvres.

### **Race B Riding Mode**

By selecting the Race B Riding Mode a rider can count on full engine power but with reduced torque delivery in 1st, 2nd and 3rd gear compared to Race A. This makes the bike more manageable during long track sessions, on circuits that favour cornering rather than strong acceleration or that have an uneven or low-grip surface. The electronic controls are set up to afford even less experienced riders an effective and spectacular ride. DES system adjustments guarantee riding safety and high levels of grip even on bumpy or slippery surfaces.

### **Sport Riding Mode**

Selecting Sport Riding Mode gives the rider 214 hp, with a direct sport-style Ride-by-Wire throttle response and, on the S version, a sport style suspension set-up. Electronic control settings afford even less experienced riders an effective and spectacular ride. In Sport mode, for example, the Slide by Brake function is engaged, allowing riders to drift into corners safely. Rear wheel lift detection during braking is on and the Cornering ABS function is set to maximise cornering performance.

### **Street Riding Mode**

Street Riding Mode is recommended when riding the Panigale V4 on the road. As with Sport Riding Mode, this RM gives the rider 214 hp and a progressive Ride-by-Wire throttle response. With the Panigale V4 S version, it features a suspension set-up that is well suited to bumpy or pitted roads. Electronic control settings ensure grip and stability to maximise safety.

# Servicing and maintenance

## Safety as standard

Ducati's continuing commitment to design, research and development has the precise objective of guaranteeing state-of-the-art motorcycles characterised by the highest degree of active safety. It is with racing performance in mind and a view to increasing the level of control during the most difficult riding that we continue to develop systems that are always at the cutting edge.

On the Panigale V4, the ABS Cornering EVO system manages every braking phase, even with the bike leaned over, a situation in which the engine brake is controlled by Engine Brake Control EVO, which carefully regulates the braking torque. The acceleration phase is controlled by Ducati Traction Control EVO, Ducati Wheelie Control and Ducati Slide Control. Systems that allow for maximum performance, in total safety, aboard the most powerful production sports bike Ducati has ever built.

## More value to your passion

With Ever Red, the quality and reliability of the Ducati brand remain your inseparable travelling companions over time. Ever Red is the exclusive Ducati warranty extension programme. With its activation you can continue to feel protected for 12 or 24 months beyond the expiration of the Ducati Warranty (24 months). Ever Red includes roadside assistance for the entire coverage period and no mileage limits. In this way you can ride for all the kilometres you want, even abroad, enjoying your Ducati without any worries.

To find out if the Ever Red extension is available in your country and for further information contact your Ducati dealer or visit [ducati.com](http://ducati.com).

## Endless excitement

In designing each bike, Ducati constantly strives to ensure maximum reliability while reducing service costs. A commitment that has seen the intervals for the main Desmo Service, in which valve clearance is checked and adjusted if necessary, extended to 24,000 km (15,000 mi) for the Panigale V4. Even the simplest of checks, such as the Oil Service, are extended to 12,000 km (7,500 mi) or 12 months.

A considerable interval for such high-performance engines, which only confirms the high quality standards adopted in terms of material selection and R&D processes. Ducati continuously invests in the technical training of its dealers. The specific skills offered by the official Ducati Service network ensure that all those operations needed to keep every Ducati in perfect condition are thoroughly executed, while advanced equipment such as the Ducati Diagnosis System allows the software on each Ducati to be updated with the latest releases, ensuring that the electronics continue to perform at the maximum level.

## Always by your side

One of Ducati's main goals is to offer every Ducatista the chance to enjoy unlimited and safe travel all over the world. To achieve this aim, Ducati offers a "fast delivery" original spares service, with delivery in 24/48 hours across 85% of the areas in which it operates. With a distribution network that covers more than 91 countries, thanks to 738 official Dealers and Service Points\*, choosing a Ducati means you can travel worry free and in total freedom, wherever the road may take you, and count on support from our extensive Dealer network that ensures Ducati quality and professionalism is always close at hand.

738 Authorised dealers and service points

91 World countries

\*Information updated as of February 2021



**Ever Red**  
Extended Warranty



\*Equal to 18,000 miles.





## Technical data and equipment

# PANIGALE V4

## Dimensions

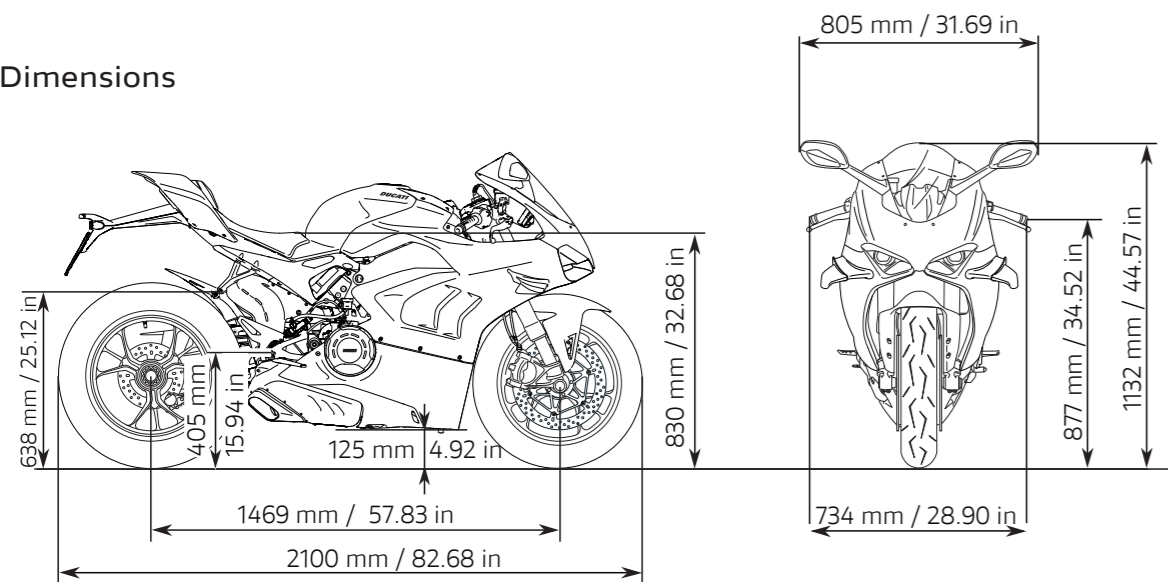

## Power and torque

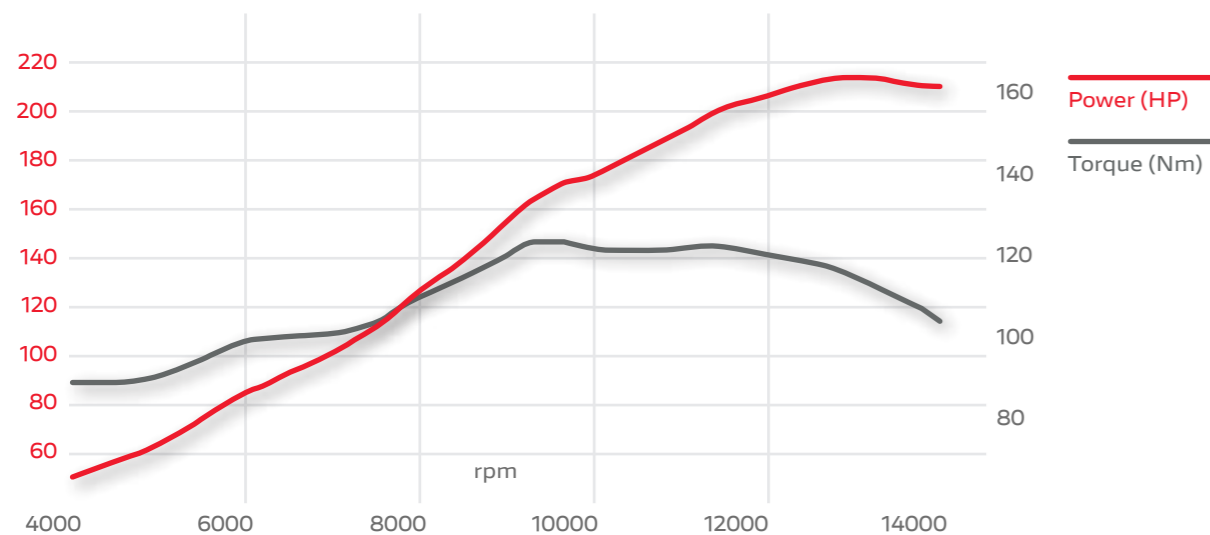

## Engine

**Engine** Desmosedici Stradale 90° V4, counter-rotating crankshaft, 4 Desmodromic timing, 4 valves per cylinder, liquid-cooled

**Displacement** 1,103 cc

**Bore X stroke** 81 x 53.5 mm

**Compression ratio** 14.0:1

**Power** 157.5 kW (214 HP) @ 13,000 rpm

**Torque** 124 Nm (91.5 lb-ft) @ 9,500 rpm\*  
124 Nm (91.5 lb-ft) @ 10,000 rpm

**Fuel injection** Electronic fuel injection system. Twin injectors per cylinder. Full ride-by-wire elliptical throttle bodies. Variable length intake system

**Exhaust** 4-2-1-2 system, with 2 catalytic converters and 4 lambda probes

## Transmission

**Gearbox** 6-speed with Ducati Quick Shift (DQS) up/down EVO 2

**Primary drive** Straight cut gears; ratio 1.80:1

**Ratios** 1=38/14 2=36/17 3=33/19 4=32/21  
5=30/22 6=30/24

**Final drive** Chain; Front sprocket 16; Rear sprocket 41

**Clutch** Hydraulically controlled slipper and self-servo wet multiplate clutch. Self bleeding master cylinder

## Chassis

**Frame** Aluminum alloy "Front Frame" with optimized stiffness

**Front suspension** Fully adjustable Showa BPF fork. 43 mm chromed inner tubes

**Front wheel** 5-spoke light alloy, 3.50" x 17"

**Front tyre** Pirelli Diablo Supercorsa SP 120/70 ZR17

**Rear suspension** Fully adjustable Sachs unit. Aluminum single-sided swingarm

**Rear wheel** 5-spoke light alloy, 6.00" x 17"

**Rear tyre** Pirelli Diablo Supercorsa SP 200/60 ZR17

**Wheel travel (front/ rear)** 120 mm (4.7 in) - 130 mm (5.1 in)

**Front brake** 2 x 330 mm semi-floating discs, radially mounted Brembo Monobloc Stylema® (M4.30) 4-piston callipers with Bosch Cornering ABS EVO. Self bleeding master cylinder

**Rear brake** 245 mm disc, 2-piston calliper with Cornering ABS EVO

**Instrumentation** Last generation digital unit with 5" TFT colour display

## Dimensions and weights

**Dry weight** 175 kg (386 lb)

**Weight in running order** 198 kg (436 lb)

**Seat height** 835 mm (32.9 in)

**Wheelbase** 1,469 mm (57,8 in)

**Rake** 24.5°

**Front wheel trail** 100 mm (3,94 in)

**Fuel tank capacity** 16 l - 4.23 gallon (US)

**Number of seats** Dual seats

## Safety equipment

Riding Modes, Power Modes, Cornering ABS EVO, Ducati Traction Control (DTC) EVO 3, Ducati Wheelie Control (DWC) EVO, Ducati Slide Control (DSC), Engine Brake Control (EBC) EVO, Auto tyre calibration

## Standard equipment

Ducati Power Launch (DPL), Ducati Quick Shift (DQS) up/down EVO 2, Full LED lighting with Daytime Running Light (DRL), Sachs steering damper, Quick adjustment buttons, Auto-off indicators, Chain guard

## Additional equipment

Passenger seat and footpegs kit

## Ready for

Ducati Data Analyser+ (DDA+) with GPS module, Ducati Multimedia System (DMS), Anti-theft, Heated grips

## Warranty

**Warranty** 24 months unlimited mileage

## Maintenance

**Maintenance service intervals** 12,000 km (7,500 mi) / 12 months

**Valve clearance check** 24,000 km (15,000 mi)

## Emissions and Consumption \*

**Standard** Euro 5



\* equal to 18,000 miles.

Kilometres refer to the first Desmo Service, i.e. when the valve clearance is checked and adjusted if necessary.

The power/torque values indicated were measured on a static testing bench according to type-approval standards and match the data read during the type-approval tests as listed on the vehicle's log book. Max power @ 12,500 rpm for US market only

\*Only for countries where Euro 5 standard applies.

# PANIGALE V4 S



Panigale V4



Panigale V4 S

Öhlins Smart EC 2.0 system	-	✓
Front suspension	43 mm Showa BPF fork	43 mm Öhlins NIX30 fork
Rear suspension	Sachs shock absorber	Öhlins TTX36 shock absorber
Steering damper	Sachs	Öhlins
Racing style hand grips	-	✓
Lithium ion battery	-	✓
Wheels	In lightweight alloy	Marchesini forged aluminium
Front mudguard colour	Ducati Red	Black
Dry weight	175 kg	174 kg
Kerb weight	198 kg	195 kg



1 Marchesini forged wheels

2 Race-style hand grips

3 Öhlins suspension with Öhlins Smart EC 2.0 control system

4 43 mm Öhlins NIX30 fork

# PANIGALE V4

Ducati Red



The bike represented is for countries where Euro 5 standard applies.

# PANIGALE V4S

Ducati Red



The bike represented is for countries where Euro 5 standard applies.

# PANIGALE V4 SP

Winter Test livery



The picture shows the Panigale V4 SP equipped with Ducati Performance parts that are prohibited for operating on public roads. The bike represented is for countries where Euro 5 standard applies.

# PANIGALE V4 SP

## Dimensions

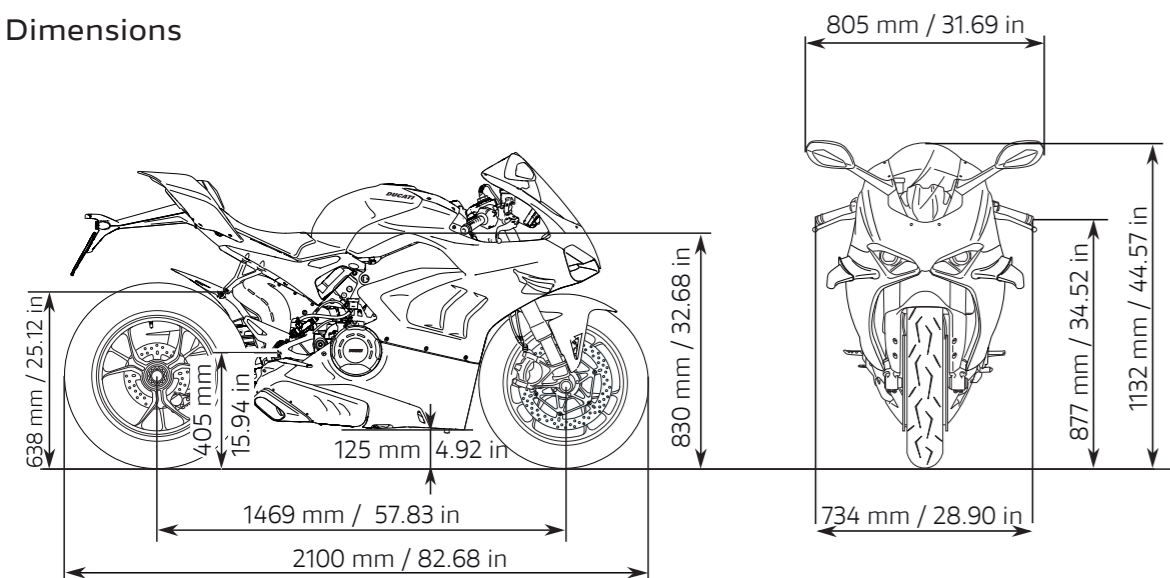

## Power and torque

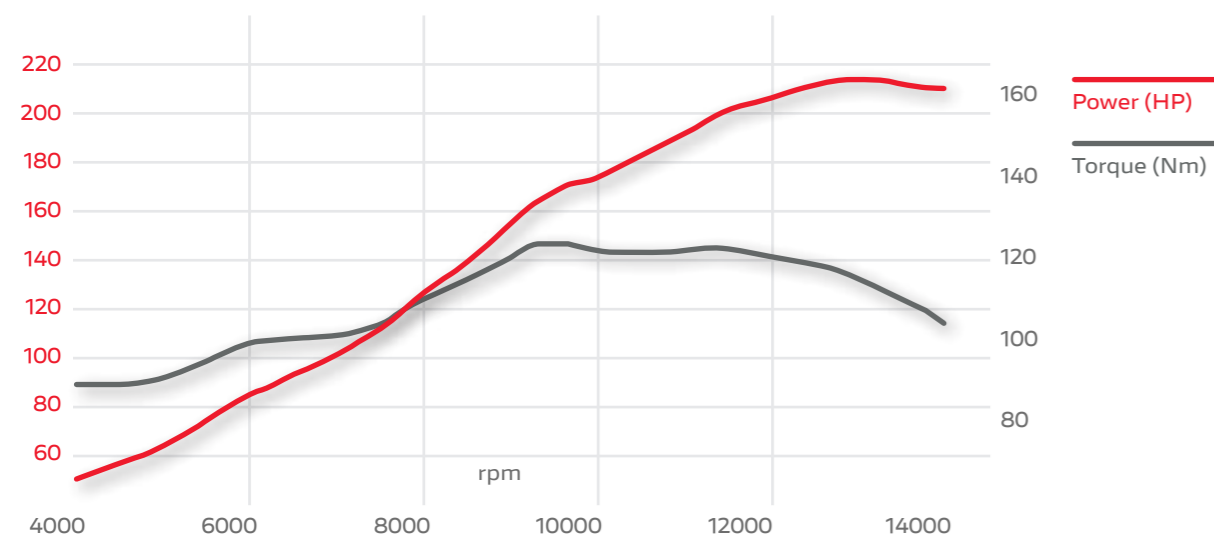

Engine	
Engine	Desmosedici Stradale 90° V4, counter-rotating crankshaft, 4 Desmodromic timing, 4 valves per cylinder, liquid-cooled"
Displacement	1,103 cc
Bore X stroke	81 x 53.5 mm
Compression ratio	14.0:1
Power	157.5 kW (214 HP) @ 13,000 rpm
Torque	124 Nm (91.5 lb-ft) @ 9,500 rpm* 124 Nm (91.5 lb-ft) @ 10,000 rpm
Fuel injection	Electronic fuel injection system. Twin injectors per cylinder. Full ride-by-wire elliptical throttle bodies. Variable length intake system
Exhaust	4-2-1-2 system, with 2 catalytic converters and 4 lambda probes.
Transmission	
Gearbox	6-speed with Ducati Quick Shift (DQS) up/down EVO 2
Primary drive	Straight cut gears; ratio 1.80:1
Ratios	1=38/14 2=36/17 3=33/19 4=32/21 5=30/22 6=30/24
Final drive	Chain 520; Front sprocket 16; Rear sprocket 41
Clutch	Hydraulically controlled slipper dry clutch. Self bleeding master cylinder.
Chassis	
Frame	Aluminum alloy "Front Frame" with optimized stiffnesses

Front suspension	Öhlins NIX30 43 mm fully adjustable fork with TiN treatment. Electronic compression and rebound damping adjustment with Öhlins Smart EC 2.0 event-based mode
Front wheel	5-split spoke carbon fiber 3.50" x 17"
Front tyre	Pirelli Diablo Supercorsa SP 120/70 ZR17
Rear suspension	Fully adjustable Öhlins TTX36 unit. Electronic compression and rebound damping adjustment with Öhlins Smart EC 2.0 event-based mode. Aluminium single-sided swingarm
Rear wheel	5-split spoke carbon fiber 6.00" x 17"
Rear tyre	Pirelli Diablo Supercorsa SP 200/60 ZR17
Wheel travel (front/ rear)	120 mm (4.7 in) - 130 mm (5.1 in)
Front brake	2 x 330 mm semi-floating discs, radially mounted Brembo Monobloc Stylema® R 4-piston callipers with Bosch Cornering ABS EVO. Self bleeding Brembo MCS 19.21 master cylinder.
Rear brake	245 mm disc, 2-piston calliper with Cornering ABS EVO
Instrumentation	Last generation digital unit with 5" TFT colour display
Dimensions and weights	
Dry weight	173 kg (381 lb)
Weight in running order	194 kg (427 lb)

Seat height	835 mm (32.9 in)
Wheelbase	1,469 mm (57,8 in)
Rake	24.5°
Front wheel trail	100 mm (3,94 in)
Fuel tank capacity	16 l - 4.23 gallon (US)
Number of seats	Single seat
Safety equipment	
Riding Modes, Power Modes, Cornering ABS EVO, Ducati Traction Control (DTC) EVO 3, Ducati Wheelie Control (DWC) EVO, Ducati Slide Control (DSC), Engine Brake Control (EBC) EVO, Auto tyre calibration.	
Standard equipment	
Ducati Power Launch (DPL), Ducati Quick Shift (DQS) up/down EVO 2, Full LED lighting with Daytime Running Light (DRL), Ducati Electronic Suspension (DES) EVO with Öhlins suspension and steering damper, Quick adjustment buttons, Lithium-ion battery, Auto-off indicators, Racing style handle grips, Chain guard, Carbon fiber wheels, Carbon fiber front mudguard, Wings in carbon fiber, Adjustable rider footpegs in aluminium with heel guard in carbon fiber, Billet aluminium steering stem with bike number.	
Additional equipment	
Machined mirror block-off plates**, License plate mount removal plug**, Carbon fiber clutch cover**, Ducati Data Analyzer+ (DDA+) with GPS module	
Ready for	
Ducati Multimedia System (DMS), Anti-theft, Heated grips	

Warranty	
Warranty	24 months unlimited mileage
Maintenance	
Maintenance service intervals	12,000 km (7,500 mi) / 12 months
Valve clearance check	24,000 km (15,000 mi)
Emissions and Consumption *	
Standard	Euro 5
CO <sub>2</sub> Emissions	175 g/km
Consumption	7,6 l/100km

\*\*This product is designed for vehicles used exclusively on a closed racetrack. Its use on public roads is prohibited by law.



Kilometres refer to the first Desmo Service, i.e. when the valve clearance is checked and adjusted if necessary.

The power/torque values indicated were measured on a static testing bench according to type-approval standards and match the data read during the type-approval tests as listed on the vehicle's log book. Max power @ 12,500 rpm for US market only

\*Only for countries where Euro 5 standard applies.





## Accessories



For more information about the Ducati Performance range, technical specifications and instructions, refer to a Ducati Dealer or visit the Accessories section of the [ducati.com](http://ducati.com) website .

Complete titanium exhaust assembly.





1 Magnesium rims

2 Carbon heel guard. Adjustable rider footpegs in aluminium

3 Dry clutch kit. Carbon dry clutch cover

4 Carbon tank cover. Billet aluminium tank cap

5 Carbon chain guard.

6 Carbon protection for generator cover



1 Racing seat in technical fabric.



2 Carbon front mudguard.



3 Brake lever protection.

4 Carbon swingarm guard.



1 Panigale V4 Tyre Warmer Set

For more information about the accessories range, technical specifications and instructions, visit a Ducati Dealer or the Accessories section of the [ducati.com](https://www.ducati.com) site.

 This product is designed exclusively for race bikes ridden on a closed racetrack. Its use on public roads is forbidden by law.

# Apparel

**Ducati Corse C5**  
Racing suit.

**Ducati Corse V5**  
Full-face helmet.

**Ducati Corse V5 Air**  
Racing Boots.

**Ducati Corse Speed 2**  
Full-face helmet.

**Ducati Corse |D |air® K1**  
Racing suit with airbag system.



Ducati Apparel Collection designed by *Drudi Performance*





#### Race

Chair

#### Ducati Corse Speed 2

Full-face helmet

#### Ducati Corse |D |air® C2

Racing suit with airbag system.

#### Ducati Corse Speed 2

Full-face helmet.

#### Ducati Corse C5

Racing suit.

#### Ducati Corse V5

Full-face helmet.



#### Race

Chair

#### Ducati Corse Speed 2

Full-face helmet

#### Ducati Corse C4

Racing suit

# Ducati SuMisura

Ducati SuMisura is a project created especially for Ducati enthusiasts so that they can customise the layout or fit of their suit and make it a perfect match for their body shape. You can create a suit that is unique and exclusive to be manufactured on a highly specialised production line. Use the configurator on the [ducatiumisura.com](http://ducatiumisura.com) website to design your SuMisura suit.

**Ducati Corse |D |air® C2**  
Racing suit with airbag system.

**Ducati Corse Speed 2**  
Full-face helmet.

**Ducati Corse V5 Air**  
Racing Boots

**Ducati Corse C5**  
Racing suit.

**Ducati Corse V5**  
Full-face helmet.

**Ducati Corse K1**  
Racing suit.

**Speed Evo**  
Full-face helmet.





**DC Track**  
Short-sleeved polo shirt.

**Dovizioso**  
Sunglasses

**DC Track**  
T-shirt.

**Racing Spirit**  
Cap

**Acapulco**  
Sunglasses

**DC Tonal**  
T-shirt.

**Racing Spirit**  
T-shirt.

**DC Track**  
Cap

**V4 Eyes**  
T-shirt.

**DC Track**  
Sweatshirt

**Ducati Corse Sketch**  
T-shirt.

**DC Track**  
Short-sleeved polo shirt.

**Dovizioso**  
Sunglasses















**DC Track**  
T-shirt.

For more information on the apparel collection go to a Ducati Dealership or visit the site [ducati.com](http://ducati.com).





## Key to symbols

- |  |   |  |  |
|--|---|--|--|
|  This product is designed exclusively for race bikes ridden on a closed racetrack. Its use on public roads is forbidden by law. |  For racing use only. The product marked with this symbol can only be used on competition vehicles. Use outside a competition track of motorcycles equipped with this product is prohibited by law. Verify any further restrictions with the relevant race course. Motorcycles equipped with this accessory are prohibited from operating on public roads. |  Anodized |  Red    |
|  This accessory is not approved for road circulation.   |   |  Matt     |  Black  |
|  This accessory is approved for road circulation in Europe.   |   |  Tinted   |  Silver |
|  This accessory cannot be used/sold in United Kingdom   |  This accessory cannot be used/sold in Japan.  |  Clear    |  |
|  |  Silencer type-approved according to European Standard 2005/30/EC.   |  |  |



ducati.com

Riding a motorcycle is the most exciting way to enjoy the road, and offering the utmost safety to the motorcyclist is Ducati's commitment. Ducati bikes are increasingly easy to handle, reliable and better equipped to guarantee maximum safety and enhance riding pleasure. Technical clothing is made with more and more advanced materials for adequate protection and increased visibility. The safety of motorcyclists is Ducati's commitment. For more information visit the safety section of the Ducati site ([www.ducati.com](http://www.ducati.com)).

**WARNING:** The photos and technical information in this catalogue may refer to prototypes subject to modifications during production and are purely for illustration and reference purposes, and are therefore not binding on Ducati Motor Holding S.p.A. Sole Shareholder Company - Company subject to the direction and coordination of AUDI AG ("Ducati"). Ducati cannot be held responsible for any print and/or translation errors. This catalogue is transnational and therefore some products may not be available and/or their features may vary in accordance with local laws. Not all colours and versions are available in each country. Ducati reserves the right to make changes and improvements to any product without obligation of prior notice or to make such changes to products already sold. Further characteristics of the products are contained in the pertinent owner's manuals. The products represented are not definitive versions and are therefore subject to significant changes at Ducati's discretion without prior notice. The photographs published in this catalogue show only professional riders under controlled street conditions. Do not attempt to imitate such riding behaviour as it could be dangerous for you or other people on the road. This catalogue, including but not limited to the trademarks, logos, texts, images, graphics and table of contents herein, constitute Ducati intellectual property, or in any event Ducati has the right to reproduce it; any reproduction, modification or other whole or partial use of the catalogue or its contents, including publication on the Internet without the prior written consent of Ducati, is prohibited.

Actual fuel consumption may vary based on many factors, including but not limited to riding style, maintenance performed, weather conditions, surface characteristics, tyre pressure, load, weight of the rider and the passenger, accessories.

Ducati indicates the dry weight of the motorcycle excluding battery, lubricants and coolants for liquid-cooled models. The weights in running order are considered with all operating fluids, standard equipment and the fuel tank filled to 90% of its useful capacity (UE regulation no. 168/2013). For more information visit [www.ducati.com](http://www.ducati.com). January 2021.



Developed with 

Technical partner 

Developed with 

Technical partner 