

PACE 350

PACE 350 OWNER'S MANUAL

AVENTON

AVENTON PACE 350 OWNER'S MANUAL

Thank you for purchasing an Aventon Pace 350 E-Bike! Before riding, please take a moment to review these instructions.

Need service or support? Visit our website for quick answers, manuals and live chat support, and/or give us a call and we'll find you a solution.

18457 Railroad St
Industry, CA 91748
Phone: (866) 300-3311
Email: info@aventon.com

CONTENTS

Display / Control Specifications	1
Getting Started	2
What's on the Display?	3
Using the Controls	4
Customizing the Display	4
• Function 02P Unit of Measure	4
• Function 03P Battery Voltage	5
• Function 04P Wheel Size	5
• Function 05P Speed Limit	5
• Function 06P Odometer Reset	6
Battery and Charging	7
Maintenance and Service	8
Safety	9
Error Codes and Troubleshooting	10



DISPLAY / CONTROL SPECIFICATIONS

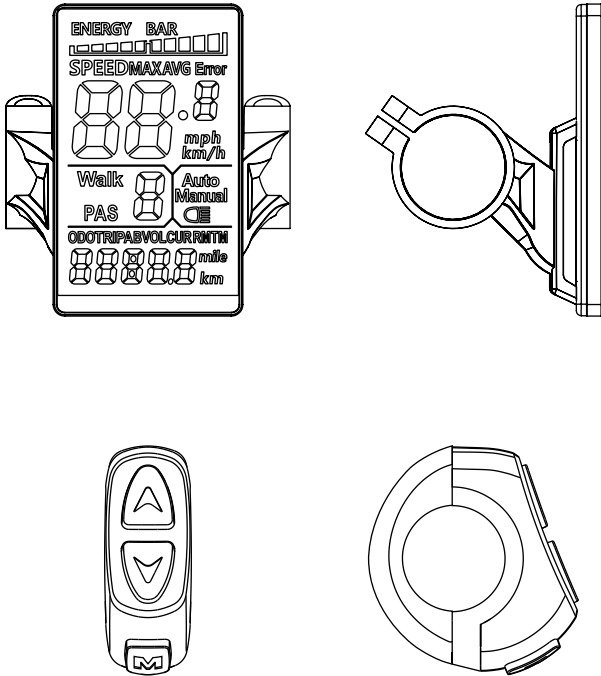

- 36 Volt Power Supply
- Current Rated: 10mA
- Maximum Operating Current: 30mA
- Power Off Leakage Current < 1uA
- Operating Current to Controller: 50mA
- Operating Temperature: -18° to 65°C
- Storage Temperature: -30° to 80°C



GETTING STARTED

The Pace 350 is operated using the control pad on the handlebars. The control pad is located near the left-hand brake lever.

First, turn on the power switch on the battery itself. Then press and hold the  button on the control pad for 3 seconds to power up the system. While the bike and display are powered on, press and hold  for 3 seconds to turn off.

The Pace 350 E-Bike offers pedal assist. When using pedal assist, an electric motor supplements the rider's own effort. To use the pedal assist, simply start pedaling, then tap the  or  arrows to increase or decrease the amount of pedal assist. Pedal assist will engage at speeds up to 20 MPH.

The Pace 350 E-Bike is equipped with a throttle, which is mounted near the rider's left thumb, to propel the bike without pedaling. To use the throttle, start pedaling then apply the throttle. Once the bike is moving on throttle power, you can stop pedaling entirely and use your thumb to control the speed of the bike. The throttle can propel you at speeds up to 20 MPH.

The motor stops when you: stop pedaling, squeeze the brake levers, or release the throttle. Simply start pedaling again to re-engage the motor.

WHAT'S ON THE DISPLAY

While you are riding, you can use the display to monitor your speed, the amount of pedal assist, battery life remaining, and other data.

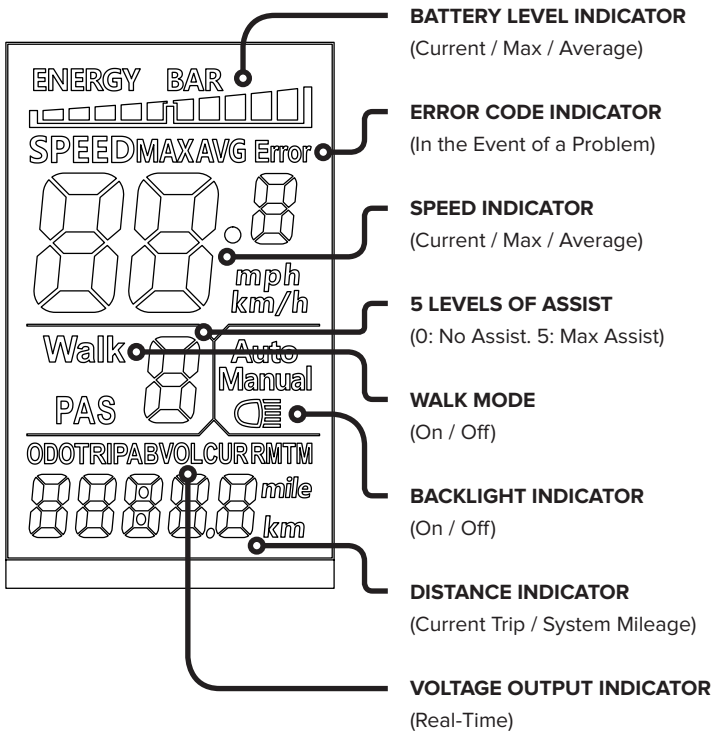

As shown below, your Pace 350 uses a LCD display screen that looks like this:





USING THE CONTROLS



To turn on your bike, tap the power switch on the battery, then press and hold the **M** button for 3 seconds. To turn off, press and hold the **M** button for 3 seconds, then press and hold the power button on the battery for 2 seconds. The display has an energy-saving feature, if there is no activity for 10 minutes, it will turn off automatically to preserve battery life.

Tap the  or  arrows to change the level of pedal assist.



Hold  and  for 3 seconds to switch between showing real-time speed, average speed, and max speed.





Tap **M** to toggle between the display of the Odometer, Trip Distance, Voltage, and Elapsed Time.

Press and hold  for 3 seconds to enable the backlight on the display. Press and hold  again for 4 seconds to turn it off.

To enable walk mode, first come to a complete stop and stand next to the bike. Press and hold  for 3 seconds. The bike will slowly move forward at 3.5 MPH / 6 KPH as long as you hold the  button. This feature is useful for pushing the bike up stairs or walking through a crowd, where you cannot safely ride.

CUSTOMIZING THE DISPLAY

You can use the settings features of the display to customize the Pace 350 for your use. To enter the “Settings” mode, hold the  and  buttons at the same time for 2 seconds.

You can customize 5 out of the 6 different functions on the display. Tap the  button to move from function to function, and use the  and  arrows to adjust each to your preferences. When you are finished, press and hold the  button to save your changes. *Note: The system will save your changes automatically after 8 seconds.*

FUNCTION 01P - BACKLIGHT BRIGHTNESS

You can control how bright you'd like the display backlight to be. 1 being the dimmest and 3 is the brightest.

FUNCTION 02P - UNIT OF MEASURE

You can toggle between miles or kilometers, based on your location and preference.

FUNCTION 03P - BATTERY VOLTAGE

This function sets the battery voltage of the system. On the Pace 350, this function is locked at 36V to match the battery and motor, and cannot be changed.

FUNCTION 04P - WHEEL SIZE

This function can be used to change the wheel size to 16, 18, 20, 22, 24, 26, 27.5, or 28" wheels. The Pace 350 comes stock with 27.5" wheels, which is the default and recommended setting. *Note: Selecting the incorrect wheel size will affect the accuracy of the bike's speed, the odometer, and the functionality of its pedal assist.*

FUNCTION 05P - SPEED LIMIT

The Pace 350 is a California Class II E-Bike. This designation carries a pedal assist limit of 20 MPH (32 KPH). You can pedal faster without assist, but the motor will stop providing assist when the speed limit is reached. You can use the Speed Limit function to change the speed limit based on your preferences and the law in your area. The Speed Limit function can be set from 20-51 KPH (for reference, that is 12.4 - 31.7 MPH) and is always set in KPH. You should only set the Speed Limit to a value that is safe and legal in your community.

FUNCTION 06P - ODOMETER RESET

The odometer tracks the distance you've ridden over the lifetime of your bicycle. Press and hold  for 5 seconds to reset the trip distance from a single trip.

BATTERY AND CHARGING

The Pace 350 uses a Lithium-Ion battery which can be charged on or off the bike. We recommend charging the battery off the bike indoors, in moderate temperature conditions. To charge the battery, plug the charger into the charging port and then connect the charger to a wall outlet. The LED indicator light will be red when charging and will turn green when charging is complete.

Take care of the battery to ensure a long service life:

- Charge and store the battery indoors if possible. The battery can be removed from the bicycle for this purpose.
- Avoid extreme hot and cold temperatures.
- DO NOT submerge your bike or any of the components in water. This action will void the warranty.

To optimize the performance of the battery over time, try and use it (discharging and charging) at least monthly. But if you won't be riding your Pace 350 for a long period of time, it's best to store the battery fully charged.

After many charging and discharge cycles, runtime and range will be reduced. Replacement batteries are available from Aventon to extend the life of your E-Bike. The lifespan of the battery is about 500 charge / discharge cycles.

When you install the battery on the Pace 350, it locks into place automatically. To unlock it for removal, use the supplied key. Do not ride the bicycle if the battery rattles or moves - it should be

firmly attached.

The Pace 350 battery contains a USB port for transmitting diagnostic data only, not for charging. It will not charge or power devices via USB.

MAINTENANCE AND SERVICE

Properly maintaining your Pace 350 ensures its longevity and smooth operation. Before assembling your bike, please watch the “How To Assemble” video we’ve prepared for you. If you have questions during the assembly process, please contact Aventon at (866) 300-3311 or email info@aventon.com.

Once you’re up and running, please make sure to:

- When cleaning your bike, use a damp cloth and gentle dish soap. *Note: DO NOT use a pressure washer or sprayer.*
- Periodically apply a light lubricant to moving parts, including the links of the chain, derailleur pivots, and shifter cable inner wire where it enters the cable housing.
- If you ride in wet / humid environments clean and dry electric connections and apply an anti-corrosive.

All bicycles will need a periodic tune-up or adjustments by a professional. An annual “check-up” is beneficial. Your bike’s service schedule will depend on the frequency of its use. In between expert services at a bike shop, we suggest:

- Keep tires inflated to their recommended pressure (30-50 PSI / 2.0-3.5 BAR / 200-350 KPA) and check weekly.
- Clean the drivetrain and lubricate the chain (monthly)

For more information about further recommended maintenance, we suggest the excellent video series offered by Park Tool.

SAFETY

You should wear an approved bicycle helmet every time you ride a bicycle, regardless of the legal requirement to do so. Additionally, some jurisdictions require helmet use when riding Class II E-Bikes like the Pace 350. You should comply with local law when riding your Aventon bicycle.

Your Pace 350 comes with reflectors and we encourage you to install and use them. Reflectors are not a substitute for lights, which are not included with your bicycle. You should purchase, install, and use front and rear lights when riding in dim or dark conditions.

Some jurisdictions restrict where E-Bikes can and cannot be ridden. These limits may include specific speeds and motor wattages. Your Pace 350 is a California Class II E-Bike, 350 watts with pedal assist up to 20 MPH and throttle up to 20 MPH. You should only ride it where legal and safe.

ERROR CODES AND TROUBLESHOOTING

In the event of a problem with the electrical components of your bike, the display will show an error code. Compare the code with this list below and **HOW TO RESOLVE**:

CODE	ERROR	HOW TO RESOLVE
30	Communication Error	Poor connection between the controller and the display, check all cable connections.
21	Current Error	Check the cable that connects the rear hub motor to the rest of the system. Make sure it is free from grit or contaminants and is firmly connected.
22	Throttle Error	When you press and release the throttle, it should return to the original position. Remove any obstructions. Check the throttle and throttle cable for damage, such as a cut or frayed cable.
23	Motor Phase Error	Check the cable that connects the rear hub motor to the rest of the system and make sure it is free from grit or contaminants and is firmly connected. This error might appear if you don't reconnect the cable after removing the rear wheel (for example, after changing a flat tire, or transporting your bike in the trunk of a car). At least one of the motor phase wires has been damaged or is temporarily disconnected.

24	Motor Hall Sensor Error	The hall sensor (or cadence sensor) might be disconnected or damaged, reconnect the motor cable and cadence sensor connecting cable.
25	Brake Error	The Pace 350 uses special brake levers that stop the motor when you apply the brakes - built in "magnetic reed switches" disengage the motor's power when the lever is squeezed. If the lever is damaged (for example, following a crash), it might need to be replaced.
38	Battery Voltage Error	The battery is not supplying the required voltage to power the display and motor. Use the display to view the real-time voltage being output from the battery. It can also be checked using a volt meter. If the battery is old and has been charged / discharged many times, it may need to be replaced. This error could also appear if you install the wrong battery on your Pace 350.

AVENTON

WWW.AVENTON.COM