

Ebike Operation Instruction

Qualisports® USA Beluga

This is a precision instruction, please make sure you read this carefully before you try your first ride. If you doubt about any information inside this instruction, please contact us or your local distributor.

Meet Your Ebike

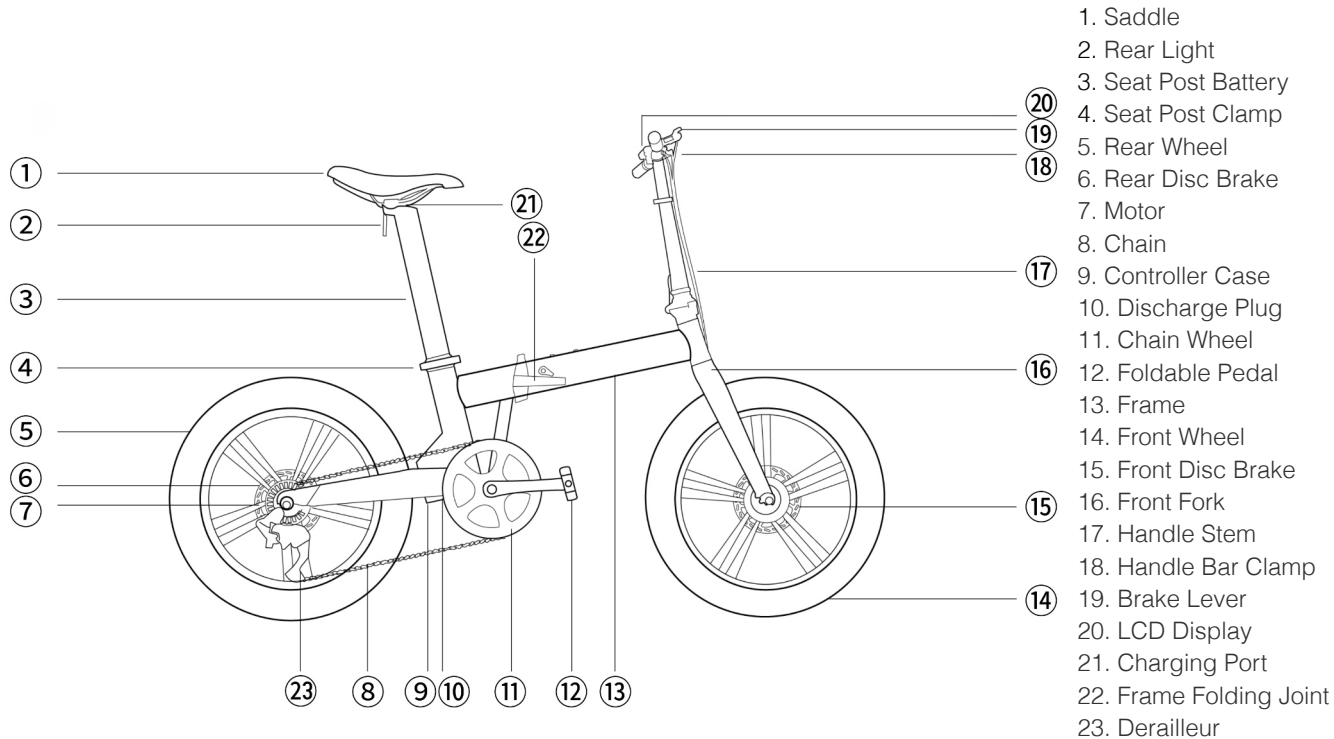

Parameter

Product Name: Beluga

Model Name: QSEB04

Size: 1660*640*1180 mm

Fold Package: 900*550*750 mm

Wheel Base: 1100 mm

Net Weight: 66 lbs

Range: 25+ miles (PAS)

Max Load: 300 lbs

Max Speed: 20 mph

Charging Time: 7 Hrs

Battery Type: Samsung Lithium-ion

Battery Capacity: 48V 10.5Ah

Noise: ≤ 62 dB(A)

Motor: MXUS 500W Brushless Geared DC motor

Rated Output Power: 500W

Motor efficiency: $\geq 78\%$

Rated RPM: 310 ± 10 r/min

Rated Voltage: 48 V

Max Torque: 60 N.m

Overcurrent Protection: 15 ± 1 A

Low-voltage Protection: 30 ± 1 V

Kwh: ≤ 1.2 Kw.h

Ride System: 5 Levels + Throttle + Walk Assist + Cruise

Tire Diameter: 20 inch

Frame: 20 inch 6061 Al-alloy Foldable

Front Fork: 20 inch 6061 Al-alloy

Brake: 160 mm Disc Brakes

Rim: 20 inch Al-alloy 13G36H

Tire: CST Big Boat 20*4.0

Chain Wheel: Prowheel 52T

Free Wheel: Shimano 7-speed

Front Hub: Sigma Al-alloy

Chain: KMC

Handle Bar: Promax

Display: Kunteng LCD

Controller: Kunteng Sine Wave FOC

Brake Lever: Al-alloy Ebike Lever

Saddle: KNUS

Pedal: Foldable Pedal

Fold Your Ebike

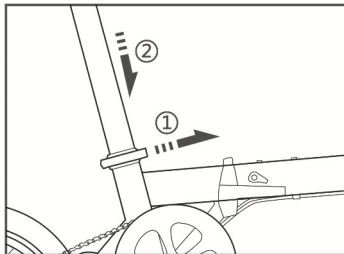

1. Grab the seat so it doesn't mistakenly drop to the ground and loosen the seat post clamp.
2. Slowly push the seat post downward until it touches the ground, and then tighten the seat post clamp.

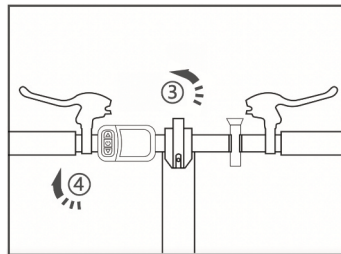

3. Loosen the handle bar clamp.
4. Twist the handlebar clockwise until the brake levers are vertical and then tighten the clamp. If raised, lower the handlebars.

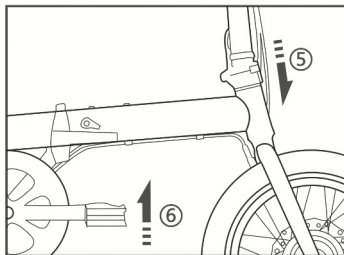

5. Release the head tube lock clamp and fold the head tube gently down.
6. Collapse the pedals by pushing them in and then position them horizontal.

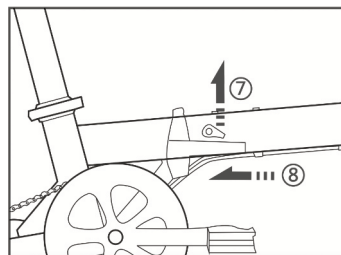

7. Release the main tube safety cap.
8. Pull the lock bar and fold the main tube in half.

Operate Your Ebike

I. Press and hold the power button for 3 seconds. LCD monitor will display screen I (below) and show:

Single riding time - PAS Class and Speed - Single riding distance;

II. Press and hold power button once. LCD monitor will display screen II (below) and show: Total Riding Time - PAS Class and Average Speed - Total Distance;

III. Press button twice. LCD monitor will display screen III (below) and show: Total Riding Time - Maximum Speed - Battery Voltage.

IIII. Touch and hold power button to turn off the monitor.

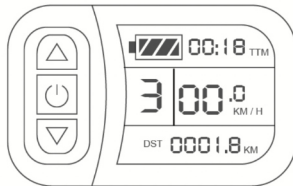

I

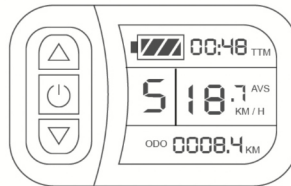

II

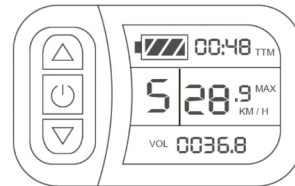

III

The layout of the display and buttons.

1. **Walk-assist mode.** Press and hold the DOWN button till the icon  flashes. Your ebike will slide at a fixed speed of 3.75 MPH. Release to quit.
2. **Cruise mode.** Ride throttleat your desired speed, which mustbe over 4.35 MPH, then press and hold the DOWN button for 3 seconds to enter Cruise Mode, press any button or take brakes to quit Cruise Mode.
3. **LCD front light.** Press and hold the UP button to turn on the monitor display front light. Press and hold the UP button again to turn the front light off.
4. **PAS mode.** Press the UP or DOWN button to choose the PAS classes from 0~5.

(If you have more questions, please contact the manufacturer for the details.)

Charge Your Ebike

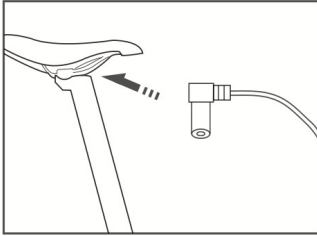

The charging port is right beneath the saddle. It is covered by a rubber dust-free plug. Remove the plug and insert the charger into the port. Remove the charger and insert the rubber plug into the port when battery is fully charged.

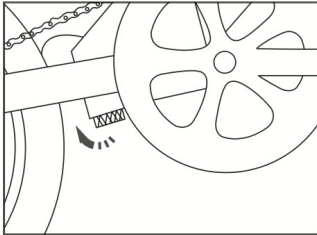

If you want to charge your battery separately, unscrew the power port on the bottom of the seat post, release the seat post clamp, pull out the seat post battery, and then repeat the steps above.

Accessory list

1. Front Mud Fender
2. Rear Mud Fender
3. Reflectors
4. Ring
5. Lamp

(Please mount accessories according to your needs.)

Attention

Battery & Charge

1. Red indicator on the charger means it is charging. When it turns green the battery is full charged and you should stop charging your battery.
2. Do not expose to temperatures below -4°F or greater than 95°F. Fully charge the battery and store separately if you plan to not use your bike for over 30 days. Fully charge your battery every 30 days or the battery may self-discharge and be damaged. This damage is not covered by the Limited Warranty.
3. Never expose your battery to a damp environment or soak it in water. Never short circuit the battery terminals, this damage is not covered by the Limited Warranty;
4. Only charge your battery with the original charger.
5. Do not disassemble or punch a hole in battery pack. Do not place it in fire or drop it from a high point. Avoid touching the electrical contacts.
6. Turn off your ebike power before you charge it. Plug the charge port in the seat post first and then plug in the AC.
7. Do not cover the charger during charging.
8. Pull out the charge port plug on the seat post before you unplug the AC.
9. Please keep battery out of reach from children.
10. The capacity of Li-battery will decrease when the temperature is below 14°F.
11. Please recycle or dispose of your battery in accordance with local regulations.

Ride & Maintenance

1. Please ride with your helmet on and follow your local laws and regulations.
2. Read this instruction manual carefully before riding your ebike.
3. Start your ride in the 3rd PAS class or lower.
4. Keep the lamp on at night.
5. Fully check your break system, tire pressure, and battery voltage before riding.
6. Please use the rear brake first.
7. Do not do any intense riding.
8. Do not ride into water deeper than 6 inches.
9. Be sure to replace the quick-wear parts (like break pads) when needed.
10. Juveniles, pregnant women, and those intoxicated are not allowed to ride an ebike.
11. Keep your ebike away from becoming damp, high temperatures or a corrosive environment.
12. Keep your ebike away from being sun-scorched or rain-drenched.
13. Check the screws, chain and other parts regularly.