

BAIAN



2002 OWNER'S MANUAL

Lance · Lance Lite · Lance Slideouts



TABLE OF CONTENTS

WARRANTY

| | |
|---|-----------|
| INTRODUCTION | 1 |
| Warnings | 2 |
| Information about this Manual | 2 |
| Owners Information Package | 2 |
| Dealer Responsibility | 2 |
| Planning and Preparation | 3 |
| Inspect and Maintain | 3 |
| Altering or Modifying Your Camper | 3 |
| Reporting Safety Defects | 3 |
| IDENTIFICATION INFORMATION | 4 |
| L.P. GAS SAFETY REGULATION | 5 |
| CAMPER AND TRUCK | 6 |
| Matching Truck and Camper | 6 |
| Tiedowns and Turnbuckles | 6 |
| Electrical Connection to Truck | 6 |
| Battery Separator | 7 |
| Exclusive Lance Cabover/Truck Struts | 7 |
| Hitching and Towing Systems | 7 |
| LOADING AND UNLOADING | 8 |
| Camper Jacks | 8 |
| Manual Acme Jacks | 8 |
| Manual Ball Screw Jacks | 8 |
| Remote Control Electric Jacks | 8 |
| Manual Override Operation | 10 |
| Swing-Out Brackets | 10 |
| Load Camper On To Truck | 10 |
| Remove Camper From Truck | 10 |
| Leveling/Stabilizing Camper | 11 |
| ON THE ROAD | 11 |
| Loading | 11 |
| Carrying Capacity | 11 |
| Safe Driving Rules | 11 |
| Riding in Camper | 12 |
| Carbon Monoxide Gas | 12 |
| Preparing For Travel | 13 |
| Pre-trip Checks | 13 |
| Post-trip Clean-up | 13 |
| EFFECTS OF PROLONGED OCCUPANCY | 14 |
| Ventilation and Moisture Control | 14 |
| Dripping Ceiling Vents | 15 |
| Interior Odor | 15 |

| | |
|---|-----------|
| FIRE AND SAFETY | 16 |
| Fire Extinguisher | 16 |
| Smoke Detector | 16 |
| LPG Leak Detector | 16 |
| Carbon Monoxide Detector | 17 |
| EXTERIOR FEATURES | 18 |
| Compartment Doors | 18 |
| Vents | 18 |
| Lighting | 18 |
| Safe-T-View® Window | 18 |
| Roof Rack and Ladder | 18 |
| Camper Bumper/Step | 19 |
| INTERIOR FEATURES | 20 |
| Dinette Bed Conversions | 20 |
| Luggage/Child Restraint System | 21 |
| Cargo Net | 22 |
| Bathroom | 22 |
| Cabover Area | 22 |
| Galley | 22 |
| Interior Storage | 22 |
| ELECTRICAL SYSTEMS | 23 |
| 12-Volt DC System | 23 |
| Battery and Compartment | 23 |
| Battery Disconnect Switch | 23 |
| Battery Storage Precautions | 24 |
| Battery Charging | 24 |
| Systems Monitor Panels | 24 |
| Water Pump Control Switch | 25 |
| Monitor Panel - Level Indicator Switch | 25 |
| Fuse Box | 25 |
| (12-volt Exterior Lights, Main C.B.) | |
| Camper Fuse Panel | 25 |
| (12-volt Interior Circuits) | |
| Stereo/Speaker Pre-Wire | 26 |
| 12-volt Outlet, Park Cable TV Outlet and Roof TV Antenna | 26 |
| TV Antenna Pre-Wire | 27 |
| Solar Panel Pre-Wire | 27 |
| Factory Solar Panel Installation | 27 |
| 120-Volt AC System | 27 |
| 120-Volt Power Cord | 27 |
| Power Center-Power Converter/Battery Charger | 27 |
| Ground Fault Circuit Interrupter | 28 |
| Generator Ready | 28 |
| Power Generator | 28 |
| Generator Operating Safety | 29 |

| | | | |
|--|-----------|--|-----------|
| ELECTRICAL (Cont'd) | | | |
| Generator Maintenance and Service | 30 | Electrical System Maintenance | 46 |
| Generator/Electrical Component | 30 | Mechanical Maintenance | 46 |
| Incompatibility | | System Troubleshooting | 46 |
| Typical Bulbs and Fuses | 31 | Electrical Troubleshooting | 46 |
| Typical Electrical System Wiring Diagram | 31 | Slide-Out System Electrical Diagram | 46 |
| LPG SYSTEM | 32 | GENERAL MAINTENANCE | 47 |
| Safety Precautions | 32 | Exterior Maintenance | 47 |
| Fill LPG Tank | 32 | Damage Checks | 47 |
| Using LPG Systems | 33 | Door and Windows | 47 |
| Dual LPG Tank | 33 | Sealant Renewal of Roof, Door, | 47 |
| Single LPG Tank | 34 | Windows & Jack Bracket Anchor Points | |
| LPG at Low Temperatures | 34 | INTERIOR MAINTENANCE | 48 |
| LPG Leak Detector | 35 | Interior Odor | 48 |
| APPLIANCES | 36 | Upholstery and Drapes | 48 |
| Lighting LPG Appliances | 36 | Wall and Ceiling Panels | 48 |
| Refrigerator | 36 | Floors and Carpeting | 48 |
| Operating Tips | 36 | Wood Product Care | 48 |
| Range Oven | 36 | Laminate Top Care | 48 |
| Microwave Oven | 37 | Refrigerator | 48 |
| Water Heater | 37 | Power Range Hood | 48 |
| Automatic Ignition Water Heater | 37 | Drains | 48 |
| Forced Air Furnace (Automatic Ignition) | 38 | Shower Care | 48 |
| Roof Mounted Air Conditioner | 38 | Maintenance Chart 1 | 49 |
| Combination Furnace/Air Conditioner | | Maintenance Chart 2 | 50 |
| Thermostat | 38 | WINTERIZATION | 51 |
| FRESH WATER SYSTEM | 39 | Operating in Freezing Conditions | 51 |
| Water Pump | 39 | Storage | 51 |
| Water Tank Fill | 39 | Short Term Storage (less than 45 days) | 51 |
| City Water Connection | 40 | Above Freezing | |
| Water System Drain | 40 | Long Term Storage Above Freezing | 51 |
| Sanitizing Fresh Water System | 40 | Storage Below Freezing | 52 |
| Water Filter | 40 | Winterizing Method When Not | 52 |
| Shower | 41 | Equipped With a Winterize Valve | |
| Exterior Wash Station | 41 | Winterizing Method When Equipped | 52 |
| WASTE SYSTEM | 42 | With a Winterize Valve | |
| Insulated and Heated Holding Tank Cover | 42 | Water Heater Bypass | 53 |
| Toilet | 42 | Reactivating Camper After Storage | 53 |
| Black Water Holding Tank | 42 | Outside Area | 53 |
| Dumping the Holding Tanks | 42 | 12-volt System | 53 |
| Holding Tank Care and Maintenance | 42 | Fresh Water System | 53 |
| SLIDE-OUT ROOM SYSTEM | 45 | LP-Gas System | 53 |
| System Description | 45 | General | 54 |
| System Operation | 45 | 120-Volt system | 54 |
| Normal Operation | 45 | Maintenance | 54 |
| Manual Override Operation | 45 | Camper Loading and Checkout | 54 |
| System Maintenance | 46 | SERVICE PHONE LISTING | 55 |

LIMITED WARRANTY

FOR TRUCK CAMPERS MANUFACTURED BY LANCE CAMPER MANUFACTURING CORPORATION (LANCE CAMPERS) SOLD IN THE UNITED STATES AND CANADA

Lance Campers warrants, to the original purchaser, this recreational vehicle to be free of defects in materials and workmanship under normal use, with reasonable care and maintenance for two (2) years and for structural integrity for two (2) years, from the date of purchase.

COVERAGE PROVIDED

Within the period of the warranty, Lance Campers is obligated to repair or replace any part covered by this warranty proven defective in material and/or workmanship. In the event of such an occurrence, the purchaser should contact the selling dealer for a service appointment. If it is not possible to return to your selling dealer, call the Lance factory service department and they will provide you with the location of the nearest authorized dealer. The cost of transporting the vehicle to the service center shall be incurred by and paid for by the purchaser.

This is the only warranty given with the purchase of this recreation vehicle other than implied warranties of greater length by component manufacturers. Any warranties implied by law are limited to the duration of the warranty outlined above. Any other warranty expressed or implied, not provided for in this **LIMITED WARRANTY** is waived by the purchaser. Lance Campers neither assumes nor authorizes any other person to assume for it any other liability in connection with this recreational vehicle.

OWNER'S OBLIGATION

The purchaser must notify Lance Campers or a Lance Campers authorized dealer of any defect promptly upon discovery. **Warranty repairs by a non-Lance dealer must be approved by Lance Campers factory service department personnel prior to any work being started.**

DEALER'S OBLIGATION

Within sixty (60) business days after receiving notice from the purchaser, Lance Campers or a Lance Campers authorized dealer will repair or replace, at its option, the defective part(s).

EXCLUSIONS

The scope of this warranty is expressly limited to only items actually constructed by Lance Campers. Lance Campers therefore makes no warranty with respect to component parts constructed or assembled by other manufacturers, including, but not limited to the LPG and electrical appliances, heaters, refrigerators, plumbing fixtures, light fixtures, lights, entrance door and windows. Such component parts may be warranted by their respective manufacturers and copies of such warranties are included with the vehicle.

This warranty shall not apply to damage caused by abuse, misuse, neglect, alteration, accident or normal wear and tear. Nor does this warranty apply to parts made out of cloth, leather, wood, paint, or chrome which has been affected by airborne fallout, such as chemicals and tree sap, or by road salt, hail, windstorm or other environmental factors.

No payment or other compensation will be made for incidental expenses, including, but not limited to, towing, telephone, transportation, lodging, travel, gasoline, loss of pay or indirect or consequential damage including, but not limited to, loss of use of the vehicle, inconvenience, damage or injury to person or property, or loss of revenue, which might be paid, incurred or sustained by reason of a manufacturer's defect covered by this warranty. Lance Campers is not responsible to any purchaser of this recreational vehicle for any undertaking, representation or warranty made by dealers during the course of selling this recreational vehicle, beyond those herein expressed.

As the manufacturer of the camper which you have purchased, Lance Camper cannot know the purpose you have in mind for your truck and camper, nor can Lance know the GVWR of your truck. Therefore, Lance Camper makes no warranties or representations, express or implied, as to the performance of your truck if the matchup of your truck and camper exceeds the GVWR as specified by your truck's manufacturer. Specifically, there is no express or implied warranty of merchantability or of fitness for the particular match of your truck to any particular camper.

This warranty is intended to comply with the requirements of both State and Federal laws. Any part of the warranty in conflict with any such law shall be ineffective to the extent of any such conflict. This warranty gives you specific legal rights and you may also have other rights, which may vary from state to state.

INTRODUCTION

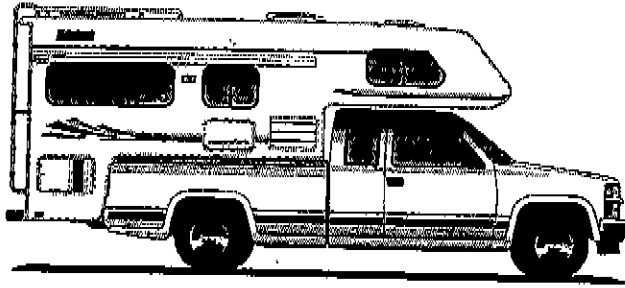

Welcome to the recreational vehicle life-style and the ever-growing family of Lance truck camper owners. We sincerely *thank you* for choosing Lance.

Your camper has been designed and constructed to provide many years of trouble free traveling and vacationing. This manual describes many features of your camper and provides an operating guide so that you may obtain the best performance from those features. Your camper has been designed to conform with, or exceed, the American National Standards Institute (ANSI) A119.2, National Fire Protection Association (NFPA) 501C, Canadian Standards Association (CSA) Z-240 (for Canadian built units), National Electric Code (NEC), and applicable motor vehicle standards. These standards establish the minimum electrical, fuel systems and equipment, fire and life safety provision, plumbing and other requirements for quality and safety.

If you have any questions regarding operation, maintenance, or service, please contact your dealer immediately so he can assist you. Your dealer's Service and Sales Department will handle any normal problem that might occur. *Customer service* is of the utmost importance to your dealer and equally as important to Lance.

Your camper is covered by our *limited warranty* as defined at the front of this manual. Please read that warranty carefully. You will be informed in case you

have a warranty-related problem, and your dealer will be able to get you back on the road again. If you have any questions about the warranty or what it does or does not cover, please contact your dealer.

At the time of sale, your dealer will fill out and mail your warranty registration to the factory. Within 2 or 3 weeks you should receive, by mail, your owner registration card. If you do not receive your card, check with your dealer that they registered your camper. The card will have your name, serial number, model, date of purchase and dealers name. If your camper ever needs warranty service, present this card to your dealer.

It is best to return your camper to the selling dealer for warranty service. If this is not possible, you may contact any other authorized Lance dealer. The Lance Camper manufacturing service department can help you find a dealer in your area. If, for some reason, a problem is not handled to your satisfaction:

1. Discuss any warranty-related problems directly with the manager or owner of the dealership, giving him the opportunity to help his service department resolve the matter for you.
2. If a problem arises that cannot be resolved to your satisfaction by your local dealer, contact the Lance Camper Manufacturing service manager.
3. We sincerely believe that your dealer and the factory representative will be able to solve any problem that might arise. If their combined efforts are not satisfactory, please send a letter describing the circumstances to:

Lance Camper Mfg. Corp.
43120 Venture Street
Lancaster, CA 93535

Please include the model and serial number of your camper. The serial number is located on the identification tag next to the entry door. If you wish to call for factory assistance, phone: (661) 949-3322.

WARNINGS



This icon indicates a warning. Warnings provide information that may reduce the risk of personal injury and prevent possible damage to others, your vehicle, camper and its equipment.

INFORMATION ABOUT THIS MANUAL

This Owner's Manual is of a general nature only and does not cover every aspect of all models manufactured by the Lance Camper Mfg. Corp. Each owner should read this manual thoroughly and heed the warnings given herein, as well as those warnings given in the component instruction manuals contained in the *Owner's Information Package*.

NOTE: Some equipment and features described or shown in this manual may be optional or not available on some models. This instructional manual is of a general nature only. Because of the continuous product improvement program at Lance Campers, it is possible that recent product changes may not be included in this manual.

Specifications may change without notice. The instructions included in this manual are intended to be a guide, and in no respect extend the responsibility of the manufacturer beyond the limited warranty as presented in this manual. Photographs or illustrations in this manual are representative of function may not be specific in their depiction of actual equipment, fabrics, interior or exterior decor or design options as installed on or in your camper.

OWNERS INFORMATION PACKAGE

The package supplied with your camper contains very valuable documents explaining details of operation for major appliances, systems and equipment built into your camper for your enjoyment, convenience and safety. Included in this package is warranty information on various appliances and components in your camper. Warranty registration cards for these items should be filled out and mailed as soon as possible after you take delivery of your camper. Since this Owner's Manual does not cover every possible detail of equipment and options installed on or in your camper, these booklets and instructional material in the package will help you operate, maintain and trouble-shoot those items. Be sure you read all this information. Keep it handy for reference. If you ever decide to sell or trade your camper, be sure the new owner gets all the material in this package.

DEALER RESPONSIBILITY

Your camper has been thoroughly inspected at the factory before shipment. Your dealer is responsible for performing a complete pre-delivery inspection of all your camper's components. This should assure you that all components are in proper working order and free of defects prior to you taking delivery.

During the delivery process, the dealer should have taken you through the inside, as well as around the exterior of the camper, to instruct and explain the proper usage of all of the following items:

Appliances
Dinette Bed Conversions
Electrical System
Fresh Water System
LP Gas System
Loading and Unloading
Optional Equipment
RV Park Hookup
Waste System
Slide-Out System

While the dealer has provided basic instructions on how to use your camper, it is ultimately your responsibility to make sure you fully understand how to use the camper prior to doing so. To fulfill this responsibility, in addition to the instructions received from the dealer, you must read all instructional material furnished with the camper. If you do not understand how to operate any appliance or equipment, you should return to your dealer for further instructions.

Your Lance Camper comes with the following loose items. Please make sure that you have each of these items:

- 12 volt Molded Camper Connector (installed on your truck by the dealer)
- Two sets of keys
- Owner's Packet
- Fire Extinguisher (mounted)
- Waste Drain Hose with Dumping Hardware
- Jack Handle
- Slide-out Crank Handles and Extension Tube (Slide-out units only)
- Entry Step with pins (if camper supplied with bumper)
- Solar Pigtail Plug (Solar ready option)
- Remote for Electric Power Jacks (Power Jack option)
- Remote for Stereo (Stereo option)

PLANNING AND PREPARATION

Proper planning of your trip will ensure a pleasurable experience. A thorough knowledge of your RV is important if you are going to get the most of the convenience and safety built into your camper. You should become as familiar with your camper as you are with your own personal car or truck. If you have trouble or questions, you should consult your dealer.

INSPECT AND MAINTAIN

Follow a consistent schedule of inspection and maintenance for your camper. Your continuing safety and comfort depend on it. The **Maintenance Chart** located at the rear of this manual defines the *minimum* maintenance intervals. Adherence to this schedule will minimize the possibility of failure of any important system of your camper. The time spent inspecting and maintaining your camper will provide you with many years of trouble free recreational pleasure.

ALTERING OR MODIFYING YOUR CAMPER



If you plan on making any alterations or modifications to your camper, check with your dealer or call the factory before getting started.

Even doing something as simple as hanging a picture; a drill, screw or nail could penetrate an unseen gas line or electrical circuit which would be hazardous. If you are not sure, *call for help!* Also, alterations or modifications to your camper may void your warranty.



Areas between the camper and truck bed are used for ventilation. Filling or blocking these areas could trap and prevent gases from escaping.

REPORTING SAFETY DEFECTS

If you believe that your vehicle has a defect which could cause a crash or could cause injury or death, you should immediately inform the National Highway Traffic Safety Administration (NHTSA) in addition to notifying Lance Camper Manufacturing Corporation.

If NHTSA receives similar complaints, it may open an investigation, and if it finds that a safety defect exists in a group of vehicles, it may order a recall and remedy campaign. However NHTSA cannot become

involved in individual problems between you, your dealer or Lance Camper Manufacturing Corporation.

To contact NHTSA, call the Auto Safety Hot-line, at 1-202-366-0123 in Washington DC.) Or write to: NHTSA, U.S. Department of Transportation, Washington, D.C., 20509. Other information about motor vehicle safety can be obtained from the Hotline.

Not all models include all features. Product information and Photography included is as accurate as possible at the time of publication. For the most current product information and changes please visit our website at www.lancecamper.com or contact your local Lance dealer. Subsequent modifications may be evident in the actual product. Specifications are subject to change without notice. All weights, fuel, liquid capacities, and dimensions are approximate.

IDENTIFICATION INFORMATION

For identification purposes it is recommended that you write the camper serial number inside. Pick a spot - behind a drawer or inside a cabinet. Protect yourself from possible theft and be able to identify your property. You should keep a copy of this information at home. If the unit is ever stolen, the police can use the appliance serial number to identify the unit. It is also handy to have when service is needed.

PLEASE TAKE A FEW MINUTES TO COMPLETE THE INFORMATION. IT WILL BE A HANDY REFERENCE FOR YOU.

Your Name _____ Camper Model _____

Serial Number _____ Purchase Date _____

Dealer Name _____ Key Number _____

Address _____

Insurance Policy Number _____ Agent's Name _____

Agent's Phone Number _____

5

Air Conditioner
Manufacturer _____

Model _____

Serial Number _____

Range/Oven
Manufacturer _____

Model _____

Serial Number _____

Furnace
Manufacturer _____

Model _____

Serial Number _____

Refrigerator
Manufacturer _____

Model _____

Serial Number _____

Generator
Manufacturer _____

Model _____

Serial Number _____

Stereo
Manufacturer _____

Model _____

Serial Number _____

Microwave Oven
Manufacturer _____

Model _____

Serial Number _____

Water Heater
Manufacturer _____

Model _____

Serial Number _____

LP GAS SAFETY REGULATIONS

The manufacturer of this recreational vehicle is required to furnish the following consumer information as provided by the National Fire Protection Association and the American National Standards Institute. The information and warnings found here may also be found in other chapters of this Owner's Manual. Please see chapters titled "LP GAS SYSTEM" and "APPLIANCES" for other safety and operating information.

 **LP gas containers shall not be placed or stored inside the vehicle. LP gas containers are equipped with safety devices, which relieve excessive pressure by discharging gas to the atmosphere.**

The following label has been located in the cooking area to remind you to provide an adequate supply of fresh air for combustion.

WARNING

IT IS NOT SAFE TO USE COOKING APPLIANCES FOR COMFORT HEATING!

Cooking Appliances need fresh air for safe operation.

BEFORE OPERATION:

1. Open overhead vent or turn on exhaust fan, and
2. Open window.

DD-26W

Unlike homes, the amount of oxygen supply is limited due to the size of the recreational vehicle, and proper ventilation when using cooking appliance(s) will avoid dangers of asphyxiation. It is especially important that cooking appliances not be used for comfort heating as the danger of asphyxiation is greater when the appliance is used for long periods of time.

 **Portable fuel-burning equipment, including wood and charcoal grills and stoves shall not be used inside the recreational vehicle. The use of this equipment inside the recreational vehicle may cause fires or asphyxiation.**



Do not bring or store LP gas containers, gasoline, or other flammable liquids inside the vehicle. Fire or explosion may be the result.

A warning label has been located near the LP gas container. This label reads:

DO NOT FILL CONTAINER(S) TO MORE THAN 80 PERCENT OF CAPACITY.

Overfilling the LP gas container can result in uncontrolled gas flow, which can cause fire or explosion. A properly filled container will contain approximately 80 percent of its volume as liquid LP gas.

The following label has been placed in the vehicle near the range area:

IF YOU SMELL GAS:

1. Extinguish any open flame, pilot lights, and all smoking materials.
2. Do not touch electrical switches.
3. Shut off the gas supply at the tank valve(s) or gas supply connection.
4. Open door and other ventilating openings.
5. Leave the area until the odor clears.
6. Have the gas system checked and leakage source corrected before using again.

LP gas regulators must always be installed with the diaphragm vent facing downward. Make sure the regulator vent faces downward to minimize vent blockage, which could result in excessive gas pressure causing fire or explosion.

The following label has been placed near the front on both exterior right and left walls of your camper:

WARNING: ALL PILOT LIGHTS, APPLIANCES, AND THEIR IGNITORS (SEE OPERATING INSTRUCTIONS) SHALL BE TURNED OFF DURING REFUELING OF MOTOR FUEL AND/OR LP GAS CONTAINERS.

CAMPER AND TRUCK

MATCHING CAMPER AND TRUCK

Selecting the right combination requires understanding a few guidelines. Your Lance dealer can be a valuable source of information when matching a camper to your truck.

Campers are considered "truck payload." Some new trucks have their payload capacity posted in the glove box. Trucks that have many options and/or a 4-wheel drive option have less payload. To calculate payload the factory assumes all seat positions are filled with persons weighing 150 pounds each.

One way to determine the amount of payload available is to weigh the truck and subtract that weight from the GVWR.



Failure to properly match camper and truck can result in undesirable handling characteristics and create a safety hazard.

Do not load your vehicle beyond its gross vehicle weight rating (GVWR) and/or gross axle weight ratings (GAWR). Both of these ratings are given on an identification label normally located at the driver's door post area.

The truck must be rated by its manufacturer to carry the gross weight of the fully loaded camper and passengers. The truck must also have a compatible center of gravity zone with the camper. Please refer to your truck Owner's Manual and the consumer information data sheet supplied with this manual.

In addition to knowing the overall weight that can be safely loaded in or attached to the truck, you must know how to distribute the weight in the camper so that correct amounts of weights are placed on the truck axles. Proper weight distribution is required for driving stability and will assure that the camper is not rear, front or side heavy. Heavy weights placed at the rear end of the camper may cause undesirable handling characteristics.

Your RV should be weighed with a full normal load (including occupants). When weighing your truck/camper combination, always use a platform scale such as those used by trucking companies and at highway weigh scales. The weigh station attendant

can guide you through the correct positioning of the truck on the scales. If your unit exceeds its weight rating or axle rating, adjust the load as required. Use this information to assist you in loading for future trips.

TIEDOWNS AND TURNBUCKLES

The camper must be secured to the truck with a set of high quality tiedowns and turnbuckles. *The turnbuckles must be spring or shock loaded at the front.* We recommend Happijac or equal quality. The turnbuckles connect the camper eyebolts to the tie down hardware installed on your truck. Check eyebolts, turnbuckles, and bracket bolts before each trip and at frequent intervals. Refer to the use and maintenance instructions supplied with the tiedowns and turnbuckles for detailed information.

ELECTRICAL CONNECTION TO TRUCK

Your Lance Camper comes equipped with a 12-volt electrical cord with a molded camper connector. The truck electrical connector will be installed by the Lance Dealer to your truck wiring system. With the wiring and connectors hooked-up, your truck will supply 12-volt DC power to charge your camper battery and provide power for the 12-volt power needs while the truck is operating.

See the listing below for 12-volt connector wire colors, wire gauge and function:

NOTE: *Do not use less than 8 gauge wire size for charge lines. Also, do not attach them to smaller gauge wires.*

| COLOR | GAGE | FUNCTION |
|--------|------|-------------------|
| Black | 8 | 12-volt power (+) |
| White | 8 | Ground (-) |
| Green | 14 | Running Lights |
| Red | 16 | Left Turn Signal |
| Brown | 16 | Right Turn Signal |
| Yellow | 16 | Back-up Lights |

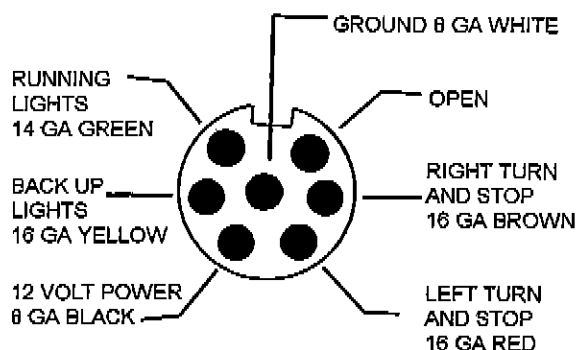

To protect your truck's 12-volt system from overload, a 40-amp circuit breaker should be installed at the power source under the hood. An isolator switch or optional Battery Separator should be installed to protect the truck's starting battery from discharge. To handle the camper's electrical requirements and to charge the camper battery, 8 gauge hot and ground wires must be run from the power source under the truck hood to the 12-volt truck electrical connector location in the truck bed.

BATTERY SEPARATOR (If equipped)

Some campers come with a Battery Separator. This component eliminates the need to add an isolator to the truck electrical system to protect the truck battery from discharge.

The Battery Separator is installed inside the camper where the truck electrical connector enters the camper.

The Battery Separator allows both the truck and camper batteries to be charged from the truck alternator. The Battery Separator isolates the batteries, so that the truck battery will not discharge. The Battery Separator will begin charging the camper battery after the truck battery has reached at least 13.2 volts.

EXCLUSIVE LANCE CABOVER/TRUCK STRUTS

To dampen the vertical movements of the camper cabover that sometimes occur when traveling, it may be advisable to install a set of optional Lance Cabover Struts.

The right and left side strut base is installed on the side of the truck's windshield/cowl area. The top end of the strut connects to an adjustable sliding bracket located in an aluminum track that is secured on the underside of the camper cabover. The sliding bracket allows adjustment to fit various truck/camper combinations.

The length of the vertical movement built into the strut will allow them to remain connected to the truck and camper under all but the most rough travel conditions.

Brackets are sold separately and are available for various types of trucks from your Lance Dealer.

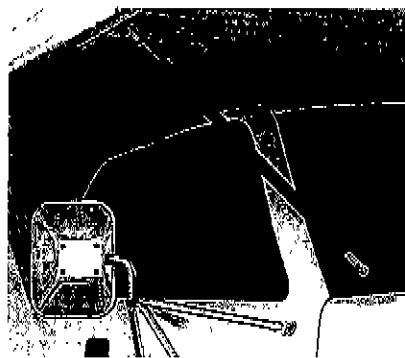

Lance Cabover Strut

HITCHING AND TOWING SYSTEMS

A hitch system has been developed and is available for use when towing with your truck and Lance camper. The Reese Titan Class V Receiver, along with a custom designed bar extension for campers over 8' are available from authorized Lance dealers or the Lance Service Department. It can be used with a standard weight carrying ball mount, or for added capacity, a weight distributing hitch bar and ball mount.



Hitch systems should be installed by qualified personnel only.



Towing will change the handling and braking characteristics of your truck/camper package.



Do not tow from or attach a hitch bar or ball to the camper bumper.

LOADING AND UNLOADING

CAMPER JACKS

The camper is loaded, unloaded, leveled and stabilized with the aid of jacks positioned at each corner of the camper. Lance campers can be equipped with one of three different systems: Manual Acme Jack, Manual Ball Screw Jack or Remote Control Electric Jack. Refer to operating instructions supplied in your *Owners Information Package*. The following information is only supplemental. Before operating jacks, read "Loading and Removing Camper From Truck" section in this chapter.

Manual Acme Jacks

To extend or retract jack, push handle onto drive shaft and rotate slightly until drive pin is engaged in handle slot. Rotate handle clockwise to raise camper or counterclockwise to lower camper. To remove handle, reverse above procedure.

Manual Ball Screw Jacks

To extend or retract jack, push handle onto alignment tube and depress the release bar with plastic push collar. Hold plastic push collar in place with one hand and rotate the handle slightly with the other hand until the black pin engages at either end of the handle "T" slot. Rotate the handle clockwise to raise camper or counter clockwise to lower camper.

 Do not over-extend or over-retract jacks. Each jack has built in stops. If excessive force is applied against the stops, damage to the jacks can result.

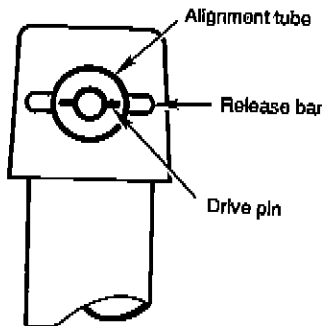

BALL SCREW ROTARY CAMPER JACK

 Always maintain positive pressure on handle until the release bar is completely back into place, engaging the pin.

To remove the handle, hold the plastic push collar in place with one hand and back the handle off with the other hand until the black pin is engaged in the middle of the handle "T" slot. The release bar should audibly and visually spring back into position. To do so the handle must be in the vertical position. If a jack is supporting the camper, it may be necessary to rotate handle clockwise slightly to relieve load on release bar before release bar can be disengaged.

Quick-to-ground feature:

To extend jack from transport position on truck to ground, the base can be dropped quickly to the ground. While release bar is disengaged, step down on base to drop it to the ground.

NOTE: *Quick-to-ground feature may not work freely until jack has been used several times due to close tolerances built into jack.*



Do not use quick-to-ground feature with handle in place.

Remote Control Electric Jacks

Electric jacks need 12-volt automotive battery power to operate. The camper battery must be charged and in good condition. If the battery is too low to operate the jacks, charge the battery before using jacks. If the camper is on the truck, starting the truck's engine will supply power to the jacks as long as the 12-volt electrical power cord is connected. If the camper is off the truck and battery power is low, a 12-volt electrical connector extension (available from your Lance dealer) can be used to connect the camper to the truck to power the jacks. If no power is available, use the manual override operation noted below.

 Do not use the electric jacks to raise or lower the camper using only 120-volt power. The converter's charger will be damaged if the jacks are operated with 120-volt power through the 12-volt converter without an automotive battery or with a low battery. *A well charged battery in good condition is required.*

 Before operating the remote control electric camper jacks, be sure to read and understand the operating instructions that were provided with your camper pertaining to their safe operation.

The jacks are operated with a hand held remote control. To activate the remote, locate and press the control switch located inside the camper, at floor level, near the entry door. A light on the face of the control switch will illuminate when activated. The switch is on a time delay that will automatically shut-off 10 minutes after activation. After use, store the remote unit in a secure place away from access by children.

The hand held remote control operates on radio frequency, which is similar to remote units for garage doors openers. The remote is powered by a 9v battery located under the removable cover on the back of the remote unit. The remote has a range of up to 20 feet from the camper. Occasional frequency interference from other nearby remote control devices may occur. This will only result in momentary pauses during the extend or retract operation.

The frequency of your remote control unit has been pre-set by the manufacturer. If interference problems persist, refer to the manufacturer's operating instructions in your owner's packet to change the frequency.

The power relay (receiver) for your remote jacks is located on the driver's side forward most cabinet, usually in the galley cabinet.

To lift camper: (Extend jacks to ground)

Press and hold the "ALL JACKS" extend button. All four jacks simultaneously extend until they touch the ground. Release button.

Extend front jacks first. Extend front jacks so camper is 4" higher in front than in the rear.

Once the camper front is higher than the rear, press and hold the "ALL JACKS" button. Release the button when the camper is at the desired height. **Make sure the front of the camper stays higher than the rear.**

Use the individual jack buttons to adjust an individual jack. Press and hold the extend or retract buttons for the individual jacks as needed to keep the front of the camper 4" higher than the rear, to prevent tipping over the camper. Keep all corners within 4" of level with each other.

To lower camper:

Retract rear jacks first so the camper is 4" lower in the rear than in the front.

Once the camper has the rear lower than the front, press and hold the "ALL JACKS" button and retract. Release the button when the camper is at the desired height.

Use the individual-jack buttons to adjust an individual jack. Keep all corners within 4" of level with each other.

If the jacks keep running, push the control switch and the light will go out. This should shut off the jacks. If they continue to run, unplug the jack(s) from their exterior plug and contact your Lance service center.

Note: When operating the jacks with a low 12v automobile battery, the "ALL JACKS" extend and retract feature may not work. Use the individual jack buttons to operate the jacks.



When operating the jacks by remote control, visually inspect all four jacks to insure that they are responding properly and that you are following proper lifting or lowering camper procedures.



Do not over-extend or over-retract jacks. The electric jack has an internal slip clutch to help prevent damage; when clicking sound is heard, release switch. Continuing to hold the switch will wear out the slip clutch or cause damage to the motor.

If jacks fail to operate, check these items:

1. Be certain that the 9v battery in the remote control unit is fresh. Keep spare batteries available.
2. The control switch light located next to the entry must be on.
3. You are within range for the remote to operate.
4. Adequate 12v Battery power is available.
5. The jack electrical cord is securely plugged into the exterior socket.
6. Hold the remote vertically (keypad facing you) and have it between the camper and you.
7. If other radio frequency devices are making the jacks pause, lift your finger from the button and press the button again.

If the jacks still fail to operate, consult your Lance service center for more information and help.

Manual Override Operation:

To manually extend or retract jack, unplug the jack from the camper. Place the manual override handle into the alignment tube and engage the drive pin. Rotate handle counter-clockwise to raise or clockwise to lower camper.

Swing-out Brackets: (If equipped)

To load or unload campers on dual rear wheel trucks, swing-out brackets are installed on the front jacks to clear the fender. To operate, follow the steps below:

1. Lift jack from the travel notch locked position and swing outward from the camper body.
2. Position jack so when camper jack is lowered, the notch and raised tab engage to prevent rotation.
3. Repeat the process for the other front mounted jack.
4. Follow the standard camper loading and removal procedures below.

LOADING/REMOVING CAMPER



Keep children and animals away from the area when raising or lowering the camper. Avoid putting any part of your body under the camper during the procedure.



Do not tilt the camper sideways while raising it on the jacks. The jacks could buckle.



Always raise or lower the camper with the front either level or higher than the back to avoid weight transfer and damage to jacks or cargo.



Load and unload camper on firm level ground.

Use caution when loading and unloading the camper on a windy day. The amount of wind that is dangerous depends on your exposure and the weight of the camper, etc.

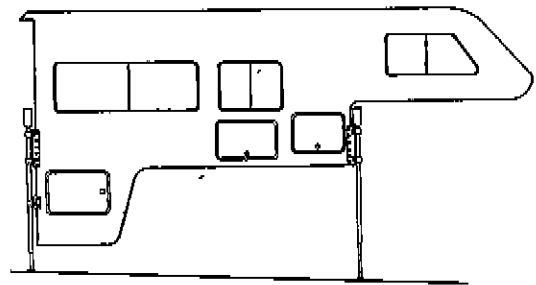

ALWAYS KEEP FRONT HIGHER THAN REAR.

LOADING CAMPER ON TO TRUCK

1. Extend each jack no more than 4" at a time, starting with the front jacks, keeping the camper as level as possible at all times. Repeat this process until the camper will clear the truck body bed by approximately 4".
2. Slowly back truck under camper making sure to clear wheel wells and any structure or plumbing located below the living area. This may take more than one try.
3. Continue backing until the truck is within a foot of loaded position. Stop and connect the 12-volt power cord to the 12-volt receptacle in the truck bed.
4. Continue backing under the camper until the bumpers mounted on the front corners lightly touch the front of the truck bed.
5. Slowly lower both rear jacks, then front jacks until the camper is resting fully on the truck bed.
6. Raise the jack base pads and secure in place according to the manufacturer's instructions.
7. Lift and swing front jacks inward (if equipped with swing out brackets).
8. Secure the camper to the truck with a set of high quality tiedowns. **The front tiedowns must be spring or shock loaded**, while the rear should use solid turnbuckles. Install both the front and rear tiedowns per manufacturer's instructions.
9. Connect camper stabilizers (optional).
10. Install crawl through boot (optional)

REMOVING CAMPER FROM TRUCK

1. Position the truck/camper combination on firm level ground.
2. Disconnect and/or remove the following items:
 - Crawl through boot
 - Camper stabilizers
 - Front and rear tiedowns
 - 12-volt camper power cord

3. Starting with the front jacks, extend the jacks no more than 4" at a time, keeping the camper as level as possible at all times. Repeat the process until the camper has cleared the truck body bed by approximately 4".
4. Slowly drive the truck out from under the camper. Be sure to clear the front overhang.
5. Lower the camper with the rear jacks first, then the front jacks no more than 4" at a time. Always keep the front of the camper slightly higher than the rear.

On campers without rear bumpers, lower camper until jacks are fully retracted. On campers equipped with bumper, holding tanks generator exhaust pipes, allow two inches of clearance between these items and the ground when lowering the camper.

 Always lower camper back down close to ground level. Do not use tall sawhorses, cinderblocks etc. to support the camper in the raised position. Do not enter or occupy the camper in a raised position.

 When lowering camper, do not allow camper bumper, holding tanks or generator exhaust pipes to touch the ground. Damage may occur.

LEVELING/STABILIZING CAMPER

When using the jacks to level the camper, when attached to the truck, **DO NOT** attempt to correct more than 4 inches of difference. Move to a more level location if necessary. If it is not possible to move to a more level location, use wood blocks under the truck tires to assist in leveling. Also loosening the camper tiedowns will allow the camper to level without lifting on the truck. Do not forget to install the tiedown after you lower the camper back down.

If you are raising the front of the camper more than a couple of inches, it may be necessary to remove the cabover stabilizers.

ON THE ROAD

LOADING

When loading your camper, store heavy gear first and place down low. Distribute weight as evenly as possible from side to side. **REMEMBER** overloading or uneven loading can create a serious safety hazard and may shorten the service life of chassis components. Do not load upper cabinets with heavy items. Secure and brace stored items so they won't move during travel, thereby shifting the load in the camper. Do not load heavy items near the end of the camper or on the rear bumper. Carry only as much water as needed for travel use or to balance the load. Whenever possible, empty the waste water holding tanks before traveling.

CARRYING CAPACITY

During the design and development of your camper, the number and size of storage compartments and liquid tank capacities are maximized for value and convenience. If the camper operator fills all liquid tanks to capacity, and fills all storage compartments and cupboards to maximum volume, the truck might well exceed its GVWR. The operator is responsible for analyzing the conditions under which the truck and camper will be used for each trip. After you have determined how much weight you can safely carry and selected those items to make up that weight, make a list and keep it for future reference.

SAFE DRIVING RULES

Your truck will have very different handling and stopping characteristics when it is carrying the camper. The following rules will help you develop needed skills for safe truck camper driving.

Travel very slowly if you are new to driving with a camper or have a new truck/camper combination, until you have learned the handling and stopping characteristics of the combination. Practice turning, stopping, and backing in a secluded place away from traffic.

Do not permit a driver who is inexperienced at driving a camper to operate your truck/camper combination without your direct supervision. **REMEMBER** - it's slow speed for beginners.

Drive at moderate speeds allowing for adverse highway and wind conditions. Even under the best of conditions, do not exceed 55 miles per hour. As speed increases, driving stability, stopping ability, and ability to make emergency maneuvers are greatly reduced.

Reduce speed before starting down hills - even short ones - and avoid heavy braking on downgrades. Truck stability is reduced when traveling downhill.

Slow down before entering turns and avoid heavy braking in turns. Truck stability is reduced in turns, and the weight of the camper on the truck will affect the way the truck handles.

Avoid quick steering movements that can reduce truck stability.

Maintain at least twice the normal stopping distance while carrying your camper. The increased weight of the camper on the truck requires greater stopping distance.

Use lower gears on long grades. Downshift on upgrades to avoid overheating or undue engine loads. Downshift on downgrades to allow engine braking to assist in controlling vehicle speed. Avoid continuous or frequent brake application. The added weight of the camper can cause brakes to overheat and fade.

Allow ample time for passing. Your acceleration will be much slower when you are carrying the camper.

Once you become accustomed to the feel of your truck/camper combination, you will find carrying your camper as easy as driving your truck without it. Become familiar with the position of the truck in traffic, and be cautious when maneuvering to allow for its length and width. Always allow extra room to corner and to change lanes. Learn to use the side mirrors to view the road behind and to the sides. Check them often.

Allow for extra height of your camper and avoid areas having low overhead clearance. Check for low hanging tree branches or other obstructions whenever you drive, park, or when pulling in for fuel or service. Always check overhead clearance of overpasses and bridges, especially if you drive with the roof vents *slightly open* or if the camper is equipped with a roof air conditioner, roof rack, TV/radio antenna, or a satellite dish.

NOTE: *Be sure to lower TV antenna before driving.*

RIDING IN CAMPER WHILE TRAVELING

For the safety of passengers, it is not advisable to ride in the camper while traveling. If it is necessary, care must be taken to remain seated while moving.

CARBON MONOXIDE GAS-

Safety Precautions

Carbon monoxide gas is colorless, tasteless, and odor-less. It is a combustion by-product of fuel-burning engines. The engines in your truck and generator system (if installed) produce it constantly while they are running. **Carbon monoxide gas is deadly.** Please read and understand the following warnings and precautions to protect yourself and others from the effects of carbon monoxide gas.

 **Exhaust gases are deadly. Do not block the tailpipes or situate the vehicle in a place where the exhaust gases have any possibility of accumulating either outside, underneath, or inside your vehicle or any nearby vehicles.**

 **Outside air movement can carry exhaust gases inside the vehicle through windows or other openings remote from the exhaust outlets.**

 **Operate the engine(s) only when safe dispersion of exhaust gases can be assured, and monitor outside conditions to be sure that exhaust continues to be dispersed safely.**

 **Do not under any circumstances operate any engine while sleeping.**

Beware of exhaust gas (carbon monoxide) poisoning symptoms:

- Dizziness
- Headache
- Weakness and sleepiness
- Nausea
- Vomiting
- Muscular twitching
- Throbbing in temples
- Inability to think coherently

If symptoms indicate the possibility of carbon monoxide gas poisoning:

Turn off engine(s) immediately
Get out into fresh air at once
Summon medical assistance

You would not be able to monitor outside conditions to assure that engine exhaust does not enter the interior, and would not be alert to exhaust odors or the symptoms of carbon monoxide gas poisoning.

Check the exhaust systems during routine maintenance and repair any leaks, damage, or obstruction before further operations. Do not modify any exhaust system in any way.

PREPARING FOR TRAVEL

Properly preparing for a trip before you leave can make things more enjoyable. Make a list of items you will need or wish to take. Keep in mind the following categories:

Bathroom supplies
Bedding
Cleaning items
Clothing
Fire Extinguisher
First aid items
Food
Holding tank chemical
Kitchenware
Personal items
Road flares
Tools

PRE-TRIP CHECKS

(Exterior)

1. Connect battery and check condition.
2. Check for fluid leaks.
3. Check tires and wheels for damage and proper inflation.
4. Check tires for cuts or other damage.
5. Check tires for unusual tread wear that may indicate a balance or suspension problem.
6. Always keep tires in good condition and when replacing, be certain that the new tires have the load carrying capacity of your truck's G.V.W.R.
7. Check that access doors are securely closed.
8. Check engine and power plant oil levels.
9. Check engine coolant level, windshield washer reservoir, and batteries.

10. Check all running lights, tail lights and electrical system.
11. Be sure tie-downs and cabover stabilizers are securely tightened.
12. Be sure to use a stable and adequately rated heavy-duty jack that will lift both the truck and camper combined weight.

(Interior)

1. Secure all loose items.
2. Close all drawers and cabinets.
3. Secure range and refrigerator doors.
4. Check that entry door is locked.

(Systems)

1. Fill fresh water tank.
2. Drain holding tanks and secure drain cap.
3. Check operation of interior lights and appliances.
4. Check LP gas level.

POST-TRIP CLEAN-UP

1. Clean unit and check for damage.
2. Drain waste-holding tanks.
3. Clean waste drain hose and secure drain cap.
4. Drain fresh water tank and rinse.
5. Close outlet valve on LPG tank.
6. Disconnect the battery cables or turn off battery switch on Legends.

EFFECTS OF PROLONGED OCCUPANCY

Your camper was designed primarily for recreational use and short-term occupancy. If you expect to occupy the camper for an extended period, be prepared to deal with condensation and the humid conditions that may be encountered.

The relatively small volume of space and air tight construction of a modern recreational vehicle means that the normal living activities of even a few occupants will lead to rapid moisture saturation of the air contained in the camper and the appearance of visible moisture, especially in cold weather.

Just as moisture collects on the outside of a glass of cold water during humid weather, moisture can condense on the inside surfaces of your camper during use in cold weather when the relative humidity of interior air is high. This condition is increased because the insulated walls of the camper are much thinner than house walls.

Estimates indicate that a family of four can vaporize up to three gallons of water daily through breathing, cooking, bathing, and washing. Unless this water vapor is carried outside by ventilation, or condensed by a dehumidifier, it will condense on the inside of the windows and walls as moisture, or in cold weather as frost or ice. It may also condense out of sight within the walls or the ceiling where it will manifest itself as warped or stained panels.

Appearance of these conditions may indicate a serious condensation problem. When you recognize the signs of excessive moisture and condensation in your camper, you should take action to minimize their effects.

NOTE: Your camper is not designed to be used as permanent housing. Use of this product for long term or permanent occupancy may lead to premature deterioration of the structure, interior finishes, fabrics, carpeting and drapes. Damage or deterioration due to long-term occupancy may not be considered normal, and may under the terms of the warranty constitute misuse, abuse or neglect, and may therefore reduce your warranty protection.

VENTILATION AND MOISTURE CONTROL

You can reduce interior moisture condensation by taking the following steps:

Ventilate with outside air. Partially open one or more roof vents and one or more windows to provide circulation of outside air into the interior. While this ventilation may increase furnace heating load during cold weather, it will greatly reduce water condensation. Even when it is raining or snowing, ventilation air from outside will be far drier than interior air and will effectively reduce condensation inside the camper.

Minimize moisture release inside the camper. Run the range vent fan when cooking and the bath vent fan (or open the bath vent) when bathing to carry water vapor out of the camper. Avoid making steam from excessive boiling or use of hot water. Remove water or snow from shoes before entering to avoid soaking the carpet. Avoid drying overcoats or other clothes inside the camper.



DO NOT HEAT THE CAMPER INTERIOR WITH THE RANGE OR OVEN!!

In addition to the hazards of toxic fumes and oxygen depletion, open flames add moisture to the interior air, increasing condensation. *Do not use an air humidifier* inside the camper. Water put into the air by the humidifier will greatly increase condensation.

Ventilate closets and cabinets. During prolonged use in very cold weather, leave cabinets and closet doors partially open to warm and ventilate the interior of storage compartments built against exterior walls. The airflow will warm the exterior wall surface, reducing or eliminating condensation and minimizing possible ice formation.

Install a dehumidifier. During prolonged, continuous use, a dehumidifying appliance may be more comfortable and effective in removing excess moisture from the interior air. While use of a dehumidifier is not a "cure-all", ventilation, storm windows, and moisture reduction continue to be important, operation of the dehumidifier will reduce the amount of outside air needed for ventilation.

Heating load on the furnace will be reduced, and the interior will be less drafty.

Install tight fitting storm windows. This will reduce or eliminate condensation on window glass. The interior surface of the storm window will be warmer, reducing moisture condensation.

DRIPPING CEILING VENTS

During cold weather and even in short term occupancy, condensation frequently forms on ceiling vents and may even accumulate to the point of dripping onto the surfaces below. This is frequently misinterpreted as a "leaking" roof vent but is most often condensation drippage.

Follow the preceding steps to control moisture condensation. Insulated hatch and vent covers are available. Consult your Lance Dealer.

INTERIOR ODOR

New units may have a strong odor and even cause eye and lung irritation when closed up in hot weather. This is due to glues used in production of forest products (plywood, paneling, etc.). This condition passes with time, but in an extreme condition, open the door, windows, and vents to allow the interior to "air out" for several hours.

FIRE AND SAFETY

The hazard and possibility of fire exists in all areas of life, and the recreational lifestyle is no exception. Your camper is a complex device made up of many materials - some of them flammable. But like most hazards, the possibility of fire can be virtually eliminated by recognizing the danger and practicing common sense safety and maintenance habits.

Recreational vehicle fires are generally caused by unattended food cooking on the stove or in the oven, faulty or damaged wiring and electrical devices, fuel leaks (both gasoline and LPG), or carelessness. The most common careless acts include smoking in bed, leaving children unattended and cleaning with flammable liquids.

Consider These Fire Safety Suggestions:

Before refueling your truck or any generator fuel tank in the vicinity of your camper, be sure to turn off all pilots and appliances in your camper. (See LP gas safety regulations on page 5)



If you experience a fire while traveling, maintain control of the vehicle until you can safely stop.

Consider the cause and severity of the fire and the risk involved before trying to put it out. If the fire is major or is fed by gasoline, LP gas or any type of oil product, stand clear of the vehicle and wait for the fire department or other emergency assistance.



If your camper is damaged by fire, do not use it until it has been thoroughly examined and the cause of the fire is found and fixed.

FIRE EXTINGUISHER

The fire extinguisher furnished with your camper is rated for Class B (gasoline, grease, flammable liquids) and Class C (electrical) fires since these are the most common types of fires in recreational vehicles. Read the instructions on the fire extinguisher. Know how and when to use it. You and your family should be familiar with its operation.

The fire extinguisher in your camper is located near the main entry door. Your fire extinguisher should be replaced immediately after use or discharge.

SMOKE DETECTOR

Most fire casualties are caused by inhalation of toxic fumes (smoke) from a fire and not by flame. The smoke detector responds to smoke that enters the sensing chamber. It does not sense gas, heat or flame. A ceiling mounted, battery powered smoke detector is located in the living /cooking area of your camper. Please read the smoke detector Owner's Manual for details on testing and caring for this important safety device.

Test the smoke detector after the camper has been in storage, before each trip, and at least once a week during use.



The smoke detector should never be disabled due to nuisance or false alarm from cooking smoke, a dusty furnace, etc. Ventilate your camper with fresh air and the alarm will turn off. Do not disconnect the battery.

Replace the battery once a year or immediately when the low battery "beep" signal sounds once a minute. The detector uses a standard 9-volt battery, usually found at any retail store that sells batteries.

Test smoke detector operation after replacing the battery. If the smoke detector fails to operate with a new battery, replace the detector with a new unit.

LPG LEAK DETECTOR

A permanently installed LP gas detector is located near the floor in the galley area. The unit contains an alarm that will sound, alerting you to the presence of low levels of potentially dangerous LP gas that may have been released due to a gas leak.

NOTE: This device detects the presence of LP gas, it does not disconnect the gas supply.



Be aware of the difference between a gas leak versus gas escaping from an unlit, open burner. Pure propane gas from a leaking pipe or gas fitting is heavier than air and will build up its heaviest concentration at the floor level first. Gas from open burners is intentionally mixed with air to induce burning and will dissipate into the air. The primary purpose of the detector is to detect gas leaks. The propane from open burners is mixed with air (oxygen) so that it will burn. When mixed with air, the gas becomes only marginally heavier than air and may not sink to the floor. If a burner is left on, the area

around the burner, range and adjoining counter space will be combustible and will cause injury and damage if ignited. This condition may exist for an extended time period before the gas can reach the detector's location and be detected. The detector only indicates the presence of LP gas at the sensor. LP gas may be present in other areas.

Other combustibles which may be detected by the detector include alcohol, liquor, deodorants, colognes, perfumes, wine, adhesives, lacquer, kerosene, gasoline, glues, most cleaning agents and the propellants of aerosol cans.

 When the alarm sounds, turn the gas off at the tank(s), turn off all gas appliances, extinguish all flames and smoking material and open all doors and major windows to air out the camper. Do not re-enter the camper until the alarm stops sounding. If the alarm sounds a second time after the gas is turned back on, leave the gas off and have a Lance service center make the necessary repairs to the source of the gas leak.

 This detector will not work without power.

The detector unit is powered by the 12-volt DC system and is always powered as long as the camper is connected to the truck, a charged battery, or 120-volt AC power. A green light on the front panel indicates that the detector has power. The fuse for the detector is located behind the detector.

Test the leak detector each time the camper is relocated and set up for use.

- Press the test switch. The LED should flash RED and the alarm should sound. Release the switch.

 Do not use a cigarette lighter to test the alarm.

A mute button will allow you to temporarily quiet the alarm after it has been set off or after testing. If the alarm does not sound during a test or if the green indicator light is not visible, check the fuse located behind the detector. If there is power to the detector and it does not operate, see your dealer. **There are no internal batteries or user serviceable parts inside this unit.**

NOTE: Since the detector is continuously powered, disconnect the battery if you are not using your camper. Low camper battery power will cause a series of short beep tones between long intervals and is distinctively different from the alert sound.

CARBON MONOXIDE DETECTOR

The carbon monoxide detector is located in the main sleeping area. It is designed to alert you to the presence of dangerous levels of carbon monoxide in the air.

Once the detector is powered, it will run through a ten minute warm-up and self check before beginning to monitor for CO gas. There is no switch to allow the unit to be accidentally turned off, so the detector has been designed to protect you by alerting you to the buildup of potentially dangerous levels of CO gas. The fuse is located behind the detector.

It is important to test the CO detector once a week or each time it has remained unpowered for more than a day. Use a butane lighter to test without striking the flint wheel.

Be sure that the detector has been powered for a minimum of 10 minutes.

- Press and hold test button for 15 seconds.
- Without releasing the test button, aim the butane lighter nozzle towards the gas Sensor Area.
- Press the gas release quickly (not more than 1 second). **DO NOT ROTATE FLINT WHEEL.**
- Release the test button.
- The alarm should sound. If it does not, repeat this procedure then see the troubleshooting section in the CO detector Owner's Instructions.
- Wait one minute.
- Press and release the test button to silence the alarm. If the alarm continues to sound, wait 30 seconds and press and release the test button again.

NOTE: The alarm will reset within five minutes without pressing the test button.

 Carbon monoxide cannot be seen or smelled and can kill you.

If the alarm sounds, turn off appliances, vehicle or other sources of combustion at once (furnace, water heater, stove/oven, truck, etc.) or call the fire department. Get fresh air into premises or vehicle. **Evacuate the premises immediately. Do a head count to check that all persons are accounted for. Do not re-enter the unit until it has been aired out and the problem corrected.** Have the problem corrected before restarting appliances.

Read and understand the CO detector information supplied in your *Owner's Information Package*.

EXTERIOR FEATURES

After taking delivery of your Lance camper, spend some time familiarizing yourself with the exterior features. Those described here do not appear on all models.

COMPARTMENT DOORS

Various exterior compartment doors provide access to certain appliances, controls, and general storage. Exterior compartment doors may not be water tight in all weather and road conditions. Any article which could be damaged by water or dirt should be carried inside the camper or truck.

The **Water Heater Door** provides access to the operating control of the water heater.

The **LPG Tank Compartment Door** provides access to the storage LP gas tank(s) and regulator valve(s). This compartment door *must remain unlocked* as required by safety building codes.

The **Refrigerator Vent/Door** provides access to the rear of the refrigerator for service and supplies inlet ventilation for proper operation.

The **Bumper Hinged Door** provides storage and convenient access to the waste drain hose and storage tray.



Outside storage compartments are not sealed or vented enclosures and may be accessible from inside the camper. Do not store hazardous chemicals/materials or flammable, volatile liquids in these areas.

VENTS

All exterior vents and louvers provide needed air circulation. Be sure not to block these vents because damage to equipment, as well as hazards to individuals could result.

The roof vents are operated from inside and have built-in screens. These vents may be left *slightly open* while traveling, but be careful when traveling where vertical clearance is limited. Vent lid cracks may result if left open too far.

LIGHTING

Your camper is equipped with exterior lights not normally found on autos to comply with state and federal regulations. It's important not to alter the lights or the reflecting markers. Check the exterior lighting frequently and replace any burned out bulbs or damaged parts as soon as possible.

SAF-T-VUE® WINDOW (If equipped)

The Saf-T-Vue® window, with its special wide angle lens, is located in the lower part of the camper entry door to assist in backing, towing and driving safety by allowing visibility to the rear in areas not covered by the truck side view mirrors.



Objects viewed through the Safe-T-Vue® window are actually closer than they appear.

It is advisable, upon delivery of your new camper, to familiarize yourself with the real distance as compared to the vision through the window. This will help you judge more accurately, the true distance of vehicles or objects to the rear.

A vinyl cover is provided, on the inside of the window that will allow you to cover the opening when privacy is desired. When cleaning the lens side of the window (inside), wash with soapy water and dry with a clean soft cloth. Care should be taken to avoid harsh cleansers as they may damage the lens.

ROOF RACK AND LADDER

All camper models are equipped with a ladder. The roof rack (if equipped) or roof tracks (if equipped) can be used to secure light bulky items, such as lawn chairs. Models with the roof tracks are supplied with adjustable tie-down loops and are designed to accommodate additional add-on accessories from Yakama. These accessories are available from your Lance dealer or a local Yakama dealer.

Some camper models have the ladder located in front of a storage or generator access door. In order to gain access to the door, the ladder's lower section is hinged allowing it to swing up and be secured in place.



Before using the ladder, it must be lowered and locked into the brackets.

All Lance models have a fully decked roof and may be walked on from front to rear. Use caution when loading sharp articles on the roof. If you add accessories or new equipment on the roof, use a qualified installer, or consult your dealer. Care must be taken to avoid leakage and void your warranty.



The roof is slippery when wet.

CAMPER BUMPER/STEP (If equipped)

The aluminum bumper has an illuminated license plate location and storage for the sewer hose. Use the fold down step when entering or exiting the camper. The step can be mounted to the right for use when towing a boat or trailer.

INTERIOR FEATURES

Your interior has been designed with utility and comfort in mind to provide spaciousness and versatility. Familiarize yourself with the bedding and dining arrangements as well as the various storage areas inside.

The dinette cushions are reversible with a vinyl backing for use when sitting at the dinette with damp swimsuits.

Loose cushions supplied for the bed makeup can be used to increase seating width on dinette seats with slides. Extend the seat platform along with the bottom cushion and place the loose cushion between the seat cushion and wall cushion.

DINETTE CONVERSION (Lance)

Depending on your model, the dinette converts to a sleeping area in one of three ways (see diagram that matches your dinette area).

To convert the dinette area into a sleeping area:

1. Remove table top and pedestal.
2. Remove filler panel located in the area between the front and rear facing seats.
3. Place the dinette table on the supports between the seat platforms and into the cutout area.
4. Pull out each seat platform slide extension far enough to provide support for the cushions used for sleeping.
5. Arrange seat and back cushions as shown in the picture.

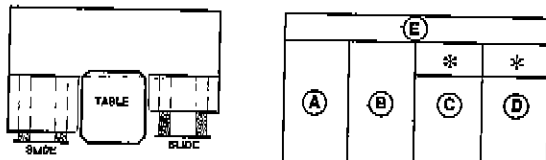
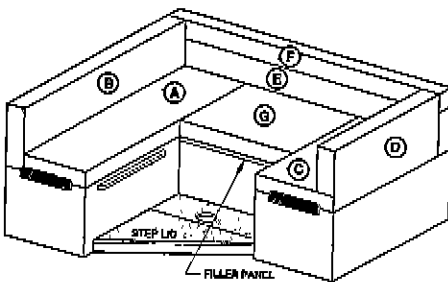

**Models with Two-Piece Back Cushion
Dinette Base and Cushion Arrangement**
* 7"x18" Loose Cushions

NOTE: Cushion F stays attached to the wall.
Cushion G not used to make the bed.

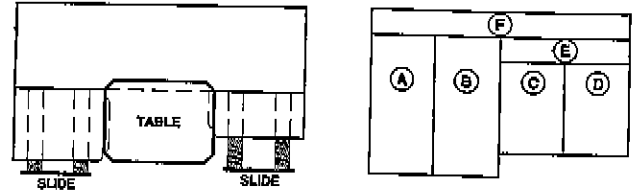
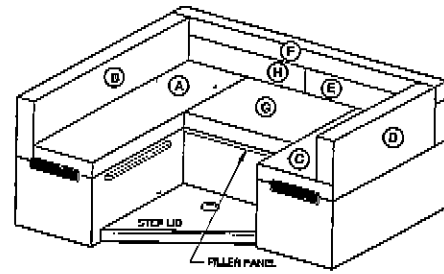

**Models with Three-Piece Back Cushion
Dinette Base and Cushion Arrangement**

NOTE: Cushions H and G not used to make bed.

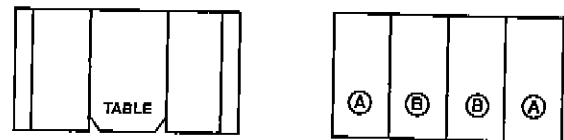
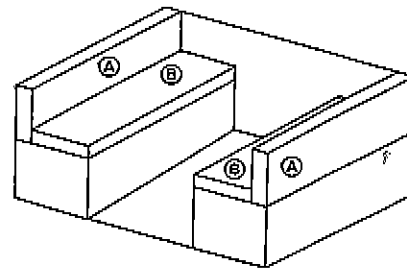

Dinette Base and Cushion Arrangement

DINETTE CONVERSION

To convert the dinette area into a sleeping area:

1. Lower table to dinette supports.
2. Arrange seat and back cushions as shown in the picture.

SOFA CONVERSION (Lance)

On models with a sofa only or a sofa with loose cushions used for dinette seating, remove any loose cushions and pull sofa back over the seat to form a bed.

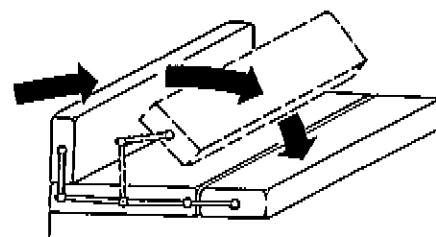

Pull Over Sofa

DINETTE COVERSION (Lance Lite)

To convert the dinette area to a sleeping area:

1. Remove the table top and pedestal.
2. Remove filler panel from side rail (if equipped) to insert the table.
3. Place table top on supports between the seat platforms and under side rail metal angle. The table will extend into the aisle a few inches past the cushions.
4. Pull out rear seat platform slide extension far enough to provide support for the cushions used for sleeping.
5. Arrange seat and back cushions as shown in the picture.

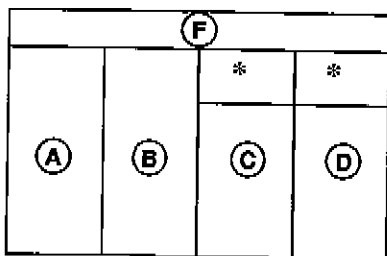
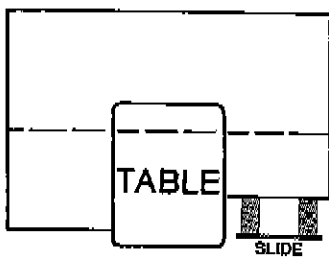
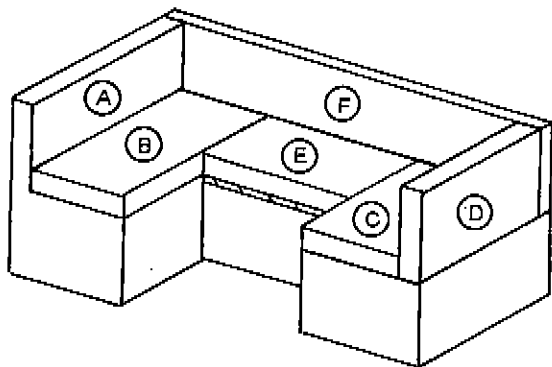

* 7"x18" Loose Cushions

Dinette Base and Cushion Arrangement

NOTE: Cushion F stays attached to wall.
Cushion E not used to make bed.

LUGGAGE/CHILD RESTRAINT SYSTEM (If equipped)

The luggage/child restraint system may be used when extra storage is required or for security when children are sleeping in the overhead bunk. A zippered panel allows easy access. The restraint net rolls up and snaps into place to store the system when not in use. When traveling, limit storage to 150 lbs. maximum. (This area is good for storing bulky items such as sleeping bags, lawn chairs etc.)

The child restraint system is intended for children's safety when sleeping and should not be used as a playpen. Please supervise your children for their safety.

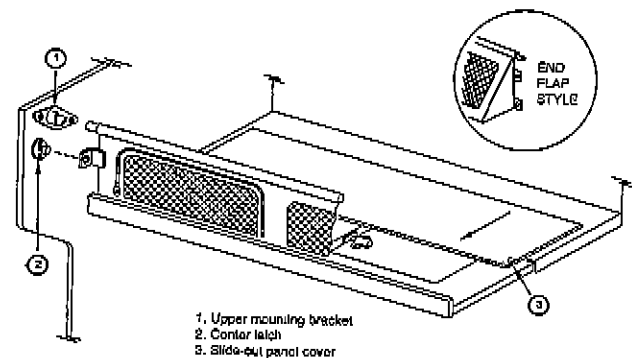

1. Upper mounting bracket
2. Center latch
3. Slide-out panel cover

Luggage/Child Restraint System



You must fasten the center latch on both sides of the net to keep the pole from popping out of the brackets.



To prevent injury from a fall, do not use the fold down storage/bunk for sleeping without using the lance luggage/child restraint system.

To use the luggage/child restraint system:

1. Unlatch the bunk and fold down.
2. Unsnap the storage strap and roll out the net.
3. Insert the pole into the upper mounting brackets.
4. Fasten the center latch on both sides of the net.
5. Slide-out the panel to cover the door openings and position the bunk pads.

CARGO NET (If equipped)

The cargo net should be used to secure items in the overhead fold down bunk area, especially bulky items such as sleeping bags and lawn chairs.



The cargo net is not designed for, or intended to be used for, securing children or other people, in the bunk at any time.

When traveling, limit the storage in the bunk area to 150 lbs. maximum.

To use the cargo net:

1. Unlatch the bunk face and fold down to gain access to the cargo net which is attached to the back of the bunk face.
2. Slide out the panel to cover door openings.
3. The cargo net top edge is fabricated of elastic cord with loops that correspond with hooks attached to adjoining walls.
4. Slip the loops over these hooks and the top cord over the hooks located in the ceiling to hold the cargo net in place. *Some stretching is required and necessary to provide the cargo net a taut and snug fit.*

BATHROOM

The bathroom walls are sealed and waterproof, so do not worry if water splashes on it. All camper models are equipped with ceiling vents.

The toilet is designed to flush with a minimal amount of water and still provide for proper disposal and odor control. Toilet chemicals are available at most RV retail outlets. Review the manufacturer's Owner's Manual supplied with the toilet for proper use, maintenance and chemical usage. The toilet paper dispenser is mounted inside the lavatory door under the sink. Information on the toilet plumbing can be found in the "Waste System" sections.

CABOVER AREA



Do not allow anyone, children especially, to ride in the cabover area while traveling. Any sudden stops could result in injury.

In case of emergency or fire, an emergency escape hatch is located in the ceiling, which allows you to exit the camper by using the rear wall mounted ladder. Caution should be used when walking on the roof.

GALLEY

The galley is designed for utility, convenience and comfort. Most models have cabinets that are equipped with positive locking latches which prevent them from opening while traveling. Refer to the "Appliance" section for information regarding the appliances.

INTERIOR STORAGE

Interior storage areas may be found in a number of places in your camper: overhead compartments, wall closets, under the dinette, under the bed, lavatory and galley cabinets.

Drawers rest in detent notches when they are closed. To open drawers, lift up slightly, then pull open. These "travel locks" reduce the opening of drawers during travel, but may not hold on rough road surfaces.

Some closet and pantry cabinets are equipped with a 12-volt light that turns ON when the door is opened. If you experience some battery discharging, it could be that the light may not be OFF. Readjust the light to insure proper operation when the door is closed.

ELECTRICAL SYSTEMS

The electrical system consists of a primary 12-volt DC system and a 120-volt AC system. The 12-volt system uses battery power similar to that used in automobiles. The 120-volt system requires a source of 120-volt power provided through the power supply cord or optional generator.

These systems are connected through a power converter. When connected to 120-volt power, the converter transforms 120-volt AC input into 12-volt DC power output and charges the storage battery when installed.

12-VOLT DC SYSTEM

The 12-volt system provides power for the following components:

- Interior lighting
- Exterior lighting
- Water Pump
- Power Range Hood
- Forced Air Furnace Blower
- Evaporative Cooler (dealer installed)
- Refrigerator and Water Heater
- Stereo/CD Player
- Fantastic Fan
- Starting the Generator

The interior lighting operates on 12-volt DC power only. When connected to a 120-volt source or using the generator, the power converter transforms 120-volts to 12-volts. However, when not connected to 120-volts, the entire load of lights, water pump, exhaust fans, etc., is on your 12-volt battery. Use conservatively to minimize battery discharging.

NOTE: Without an isolator switch (dealer installed option) or the optional Battery Separator, your truck battery will also be drained when using 12-volt components.

BATTERY AND COMPARTMENT

Maintenance of your 12-volt battery is essential to carefree travel. Be sure to use a heavy-duty, minimum 95 amp/hr., RV/Marine **deep-cycle battery**. The battery compartment is designed to accept a group 27, 29, or 31. Check the battery frequently with the condition meter located on the monitor panel. The use of a hydrometer is required to test for the specific gravity of the battery acid.

Hydrometers are available through an auto parts store. On models equipped with a slide-out battery tray, the tray extends to allow access to service the battery without having to remove it from the compartment.

NOTE: The 12-volt battery is not supplied with the camper by the manufacturer.

 Before connecting the battery cables, turn off all electrical components to avoid sparks. Connect the black cable to the positive (+) post on the battery. Connect the white cable to the negative (-) post.

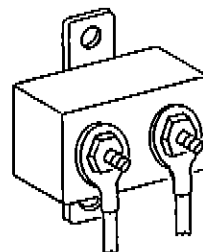

40-amp Circuit Breaker

The 40 amp main circuit breaker (located inside the camper on the backside of the battery compartment) will not allow power into the camper or the battery to be charged when an overload or short circuit occurs. To reset the breaker, disconnect and reconnect the white negative (-) cable from the battery. If your camper is equipped with a battery disconnect switch, pushing the switch in, then out will accomplish the same. If the breaker continues to trip, a short circuit or overload condition is indicated. Have the system checked by qualified personnel.

BATTERY DISCONNECT SWITCH (If equipped)

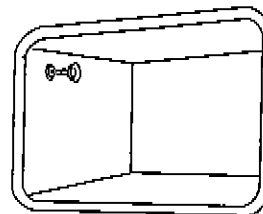



Battery Compartment

The disconnect switch is installed and accessible from inside the battery compartment (see picture above). The switch should be "OUT" for normal use and when pushed "IN" the 12-volt power is shut off to the interior of the camper. The converter or truck cannot charge the battery, when the switch is in the "in" position.

Battery Information

- The battery must be securely strapped in the compartment at all times.
- The battery is charged by the truck's charging system or when connected to 120-volt power. If equipped, the on-board generator charges the battery while running.
- Check that the battery liquid level is correct (weekly in warm climate, monthly in cold climate). Add distilled water as required.
- Clean battery terminals and cables periodically with a wire brush and baking soda. Be sure the caps are securely in place when cleaning.
- Use caution not to touch battery terminals to metal doorframe when removing or installing the battery.

 Remove rings, metal watchbands, and other metal jewelry before working around a battery. Use caution when using metal tools. If the tool contacts the battery terminals or metal connected to them, a short circuit could occur which could cause personal injury or fire.

 Do not allow battery electrolyte to contact skin, eyes, fabrics or painted surfaces. The electrolyte is a sulfuric acid solution that could cause serious personal injury or property damage. Wear eye protection when working with batteries.

BATTERY STORAGE PRECAUTIONS

When you store your camper for a week or more be sure to disconnect the battery. Electronic tuning radios, the LPG detector, and the CO detector all draw a small amount of current when the battery is connected. Even a disconnected battery will naturally "self-discharge" about 1% of capacity per day. If you intend to store your camper for any length of time, remove the battery. Store it in a cool, dry place and recharge every month.

BATTERY CHARGING

Normally the battery will be kept charged by either the truck charging system while on the road, or, by the AC/DC power converter when plugged into AC service. On those occasions when the battery needs to be charged from a different charging source, please following these safety guidelines:

- Do not smoke near batteries being charged or which have been recently charged. Please note that batteries are being charged while you drive, and while you are connected to 120-volt AC power through the power converter/charging circuit.
- Do not break live circuits at the battery terminals. Use care when connecting or disconnecting booster leads or cables while charging. Poor connections are a common cause of electrical arcs that can cause explosions.
- Check and adjust the electrolyte level before charging. Fill each cell to the indicator level with distilled water.
- Always remove the vent caps (if equipped) before charging the battery.

 Never expose the battery to open flame or electric spark. Chemical action in the battery generates hydrogen gas that is flammable and explosive.

SYSTEMS MONITOR PANEL

The systems monitor panel incorporates controls and instrumentation concerning the electrical and fluid systems. Some models also have switches for optional automatic water heaters and generators.

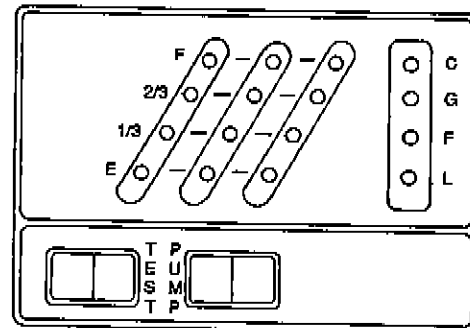

Systems Monitor Panel (Lance Lite)

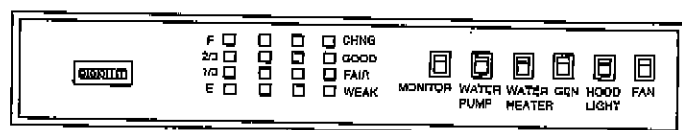

Systems Monitor Panel (Lance)

WATER PUMP CONTROL SWITCH

This rocker switch controls the demand water pump. The water pump is pressure sensitive and starts (with the switch ON) when a faucet is open, causing pressure in the line to drop. When the faucet is closed, pressure builds in the line and the pump stops.

MONITOR PANEL - LEVEL INDICATOR SWITCH

When depressing the monitor switch, indicator lights for the black (waste), grey (sink), fresh water tank and battery charging will illuminate, indicating the existing condition of each component.

Erroneous indications when checking water levels can be caused by:

Water with low mineral content. Level is measured by a very low electrical signal traveling through the liquid. Some water which is low in mineral content may not conduct the signal properly. This condition may be infrequent, but can exist. Check the panel reading when the fresh water tank is filled. Material trapped on the sides of the holding tanks may give a full reading when the tank is actually empty. Use of a spray to wash out the tank following dumping should help prevent this condition.

NOTE: If the sensor probes mounted in the tanks get coated with grease, the monitor panel may indicate falsely or not at all. Avoid pouring grease, oils, or similar substances down drains or the toilet. If this is unavoidable, the holding tank(s) should be washed out with a soapy water solution.

When testing approximate battery condition, first turn all lights, fans and other 12-volt equipment OFF. If the battery is being charged the charge light will illuminate when the monitor switch is depressed. If only a weak light is illuminated, discontinue use of all 12-volt equipment until battery can be recharged.

FUSE BOX 12-volt Exterior Lights (Lance Only) and Main Circuit Breaker

A fuse box is installed to protect the exterior light circuits, refrigerator, jacks, and 12-volt power supplied from the truck. The fuse box is located inside the galley cabinet near where the 12-volt

connector cable enters the camper. Circuit titles and fuse sizes are labeled on the box cover.

The fuse box contains fuses and a 40-amp circuit breaker that feeds power from the truck to the camper fuse panel, refrigerator, jacks, exterior lights and battery. When an overload or short circuit occurs, this breaker will not allow power from the truck into the camper. (Be aware of the other 40 amp circuit breaker on the backside of the battery compartment may have been tripped and may also have to be reset.)

To reset the breaker, disconnect and then reconnect the power connector to the truck. If the breaker continues to trip, a short circuit or overload condition is indicated. Have the system checked by qualified personnel.

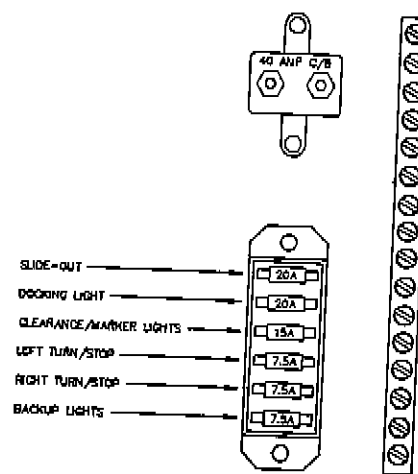

Exterior Light Fuse Box
(Lance Only)

CAMPER FUSE PANEL (12-volt Interior Circuits)

A 12-volt fuse panel is installed in the Power Converter to protect the interior circuits. Circuit titles and fuse sizes are marked inside the converter door. If a fuse blows, locate and correct the cause. Turn off all lights and motors, then install a fuse with the same rating. If fuses continue to blow, a short circuit is indicated. Have the system checked by qualified personnel. (See Power Converter Section for more information.)

Fuses for the LP Leak Detector, CO Detector and Stereo are located behind each component.



Do not install fuses with amperage ratings greater than that specified on the power converter door.

STEREO/SPEAKER PRE-WIRE (If equipped)
Instructional material can be found in the *Owner's Information Package* for the stereo system.

All Lance and Lance Lite campers are pre-wired for a future stereo system. The speakers are located in the ceiling, two in the cabover area and two over the dinette. Their locations are denoted with a label attached to the ceiling. There is blocking located for their mounting with a 5" diameter hole. The stereo location is also denoted with a label attached to the cabinet where it is to be installed.

On all models with a TV cabinet, the stereo is located under or adjacent to the TV cabinet. On models without a TV cabinet, the stereo location may vary and is denoted with a label. 12 volt power and speaker wires are located in this area. Radio antennas are typically mounted on the camper roof directly above the stereo location.

ROOF MOUNTED ANTENNA, TV OUTLET

Lance models are equipped with a park cable inlet located under the driver's side camper overhang. A TV jack outlet is located inside the TV overhead cabinet when equipped with a roof mounted antenna. An "ON/OFF" switch is located adjacent to the TV jacks which controls power going to the 12-volt outlet. Some TVs have a small current drain even when not being viewed. The switch should be turned "OFF" when not using the TV.

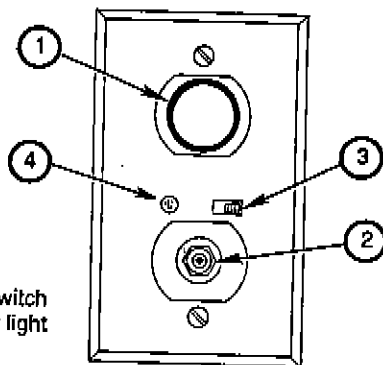

- 1. 12 volt outlet
- 2. TV hook-up
- 3. Antenna/cable switch
- 4. Antenna booster light

12-volt, Cable TV, Antenna Outlet

To use the TV antenna, turn "ON" the switch located on the TV jack (Item 3). A red light will show on the jack indicating the antenna is powered. There will be a small continual 12-volt current drain as long as the switch is on. Turning the switch "OFF" changes the TV jack from antenna operation to park cable and

ceases the current draw. Units equipped with a satellite dish have an additional outlet located next to the TV jack. The satellite receiver will connect to this outlet.

Lance Lite models equipped with a TV antenna have a TV jack located at the TV shelf. The jack has a 12-Volt outlet to power a TV. When not using the TV, unplug it from the outlet to prevent current drain. To use the TV antenna, turn "ON" the switch located on the TV jack (Item 3). A red light will show on the jack indicating the antenna is powered. When not using the antenna, turn the switch "OFF" to prevent current drain. Units equipped with a satellite dish have an additional outlet located next to the TV jack. The satellite receiver will connect to this outlet.

For operation of the TV or satellite antennas, see their operation manuals located in your *Owner's Information Package*.

NOTE: *The 12-Volt outlet is intended for a TV only and rated for 7.5 amps. DO NOT USE FOR HIGHER RATED APPLIANCES.*

TV ANTENNA PRE-WIRE

A cabover roof mounted antenna connector plate is located on the driver's side of the camper. This connector has a wood reinforcement under the roof covering for the mounting of a TV antenna or a satellite dish.

The pre-wired Lance models have (2) RG6 cables installed that run from the connector plate to a box located inside of the TV overhead cabinet. Only one cable will be needed if you have a TV antenna or a satellite dish only. If a combination TV antenna and satellite dish is used, then the second cable will be required.

The pre-wired Lance Lite models terminate the cables under the forward end of the galley overhead.

SOLAR PANEL PRE-WIRE

The pre-wired solar panel connector is mounted into the side of the refrigerator roof vent. The mating connector is supplied in your loose parts box.

Two wires, 12ga red (+) and 12ga white (-) run from the refrigerator vent mounted connector to a location behind the battery compartment for future connection to a battery.

SOLAR PANEL (If equipped)

The factory installed solar panel is mounted on the roof beside the refrigerator roof vent. The panel plugs into a connector mounted on the side of the refrigerator roof vent. The wires from the refrigerator roof vent connector run to a regulator mounted near the battery compartment. The 12ga red wire is connected to the 40-amp circuit breaker at the battery compartment with a fuse holder. The 12ga White wire is terminated at the battery.

NOTE: *Weather conditions will effect the charging rate of the solar panel. Refer to the solar panel manual supplied in your Owner's Information Package.*

120-VOLT AC SYSTEM

The 120-volt electrical system supplies power to the following components:

- Power Converter
- 120-volt Outlets (interior and exterior)
- Refrigerator
- Roof Mounted Air Conditioner (optional)
- Microwave Oven (if equipped)



Never operate the 120-volt electrical system without a proper ground.

120-VOLT POWER CORD

Your camper is equipped with a heavy-duty power cord for connection to an external 120-volt, 30 amp rated service, or onboard generator if equipped. The cord and plug are molded together to form a weatherproof assembly.

- Do not cut or alter the cord in any way.
- Do not remove the ground pin from the attachment plug, or defeat the ground circuit in the camper.
- If you have to use an adapter to plug into an electrical service, make sure the ground is maintained.
- Never use a two-conductor extension cord, or any cord that does not assure appropriate and adequate ground continuity. Use a 30 amp RV extension cord with a maximum length of 25'.
- Never plug the 120-volt cord into an ungrounded receptacle.

POWER CENTER (Power Converter/Battery Charger)

The power center consists of three sections; the 120-volt AC panelboard, the 12-volt DC panelboard and the 120-volt AC to 12-volt DC power converter/battery charger section.

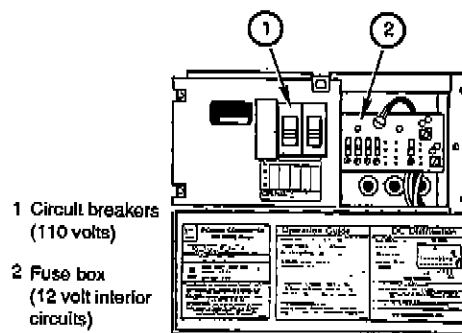

Typical Power Converter

When the 120-volt AC panelboard is supplied power from either the power cord or the AC generator, the connected circuits are protected by circuit breakers.

Switching from 120-volt AC power to 12-volt DC power is automatic when the power cord is plugged in or the AC generator is on. This powers the 12-volt panelboard and connected circuits are protected by the installed fuses. Battery charging is automatic when plugged into 120-volt AC power. Complete operating instructions are located on the inside converter door.

NOTE: Clicking and humming sounds from the converter's switching solenoid and cooling fan are normal. Should the converter shutdown during normal operation, heat may be the cause. The converter has a built-in automatic-reset thermal breaker that will reset after a cooling off period. If this occurs frequently, your dealer or qualified personnel should correct the problem. Be sure not to store items in front of the vent openings.

GROUND FAULT CIRCUIT INTERRUPTER

The bathroom, galley, and patio 120-volt receptacles are protected by a Ground Fault Circuit Interrupter (GFCI). This device is intended to protect you against the hazards of line to ground electric faults and electrical leakage shocks possible when using appliances in damp areas.

NOTE: The GFCI device does not prevent electrical shock. It does not protect a person who comes in contact with both the "hot" and "neutral" sides of the circuit. It does not protect you against electrical overload.

TEST the GFCI at least once a month while operating on 120-volt AC power. To test the GFCI:

Push the **TEST** button. The **RESET** button should pop out, indicating that the protected circuit has been disconnected.

 If the reset button does not pop out when the test button is pushed, a loss of ground fault protection is indicated. Do not use the outlet or other outlets on the same circuit. Have the camper electrical system checked out at an authorized Lance service center or by a qualified electrician. Do not use the system until the problem has been corrected.

To restore power, push the **RESET** button.

NOTE: If the bathroom, galley or patio receptacles don't work, check the GFCI. Reset the button if necessary. If the GFCI continues to trip, have the camper electrical system checked at an authorized Lance Dealer Service Center or by a qualified electrician.

GENERATOR READY (If equipped)

 The generator compartment is for a particular brand and size of LP gas powered generator provided by Lance Camper Manufacturing Corp. Qualified personnel should complete installation only.

 Do not use this compartment for the operation of a portable generator.

 The generator inverter converts **HIGH VOLTAGE DC** current to 120-volt AC. It is not nor can be used as a typical 12-volt to 120-volt voltage inverter and should be serviced only by a qualified technician.

Some camper models come set up for a generator to be installed at a later date. Generator ready condition includes: the vented compartment door (see caution note), 12-volt pre-wired remote start/stop switch, 120-volt and 12-volt wiring and LP gas supply piping with a capped bulkhead fitting.

CAUTION: The generator ready access door has an insert panel installed behind the air inlet grill. This is to help keep most dirt, dust and moisture out of the compartment should it be used for storage. It is mandatory that this be removed when a generator is installed. Failure to do so will result in generator overheating and possible fire danger.

POWER GENERATOR (If equipped)

 Before operating any generator, read and understand the "generator" section of this manual and the manufacturer's operating instructions for your generator.

Your camper may be equipped with a LP gas powered generator, which will provide complete electrical self-containment when public utility 120-volt AC power is unavailable. The generator supplies high voltage DC current, which is converted to 120-volt AC power through an inverter. The inverter is located in the dinette step area. Do not block the air vents in the step as this could cause damage to the inverter and/or generator.

The voltage output of the generator is connected through an inverter to an automatic transfer switching device which when the generator power plant is operating, power is available at all of the 120-volt power outlets in the camper, just as if the power cord were connected to an external source.

The generator circuit breaker provides circuit protection while in the "ON" operating mode. See the Generator Manual for location.

The LPG tank(s) supplies fuel to the generator and other gas appliances in the camper. Check LP gas level frequently to avoid running out of fuel.

NOTE: Refer to your Generator Power Plant Owner's Manual provided in your Owner's Information Package for starting, operating, service and trouble-shooting instructions.

To start the generator: Press the START/STOP switch to the start position and hold until the unit starts. Make sure that all electrical equipment is turned off prior to starting.

Always wait at least three minutes after starting generator before turning on or plugging in heavy electrical loads, such as the roof air conditioner and the microwave oven.

CAUTION: If the unit is slow to start, DO NOT hold the start switch in the START position for more than 10 seconds. Release the switch, wait two minutes minimum and then try again. This will help avoid overheating and damaging the generator starting system. If this fails to start the generator, consult the troubleshooting guide in the Generator Owner's Manual.

To stop the generator:

1. Turn off all electrical loads.
2. Let the generator run at no-load for a few minutes,

- to stabilize internal engine generator temperatures.
3. Place START/STOP switch in the STOP position.

GENERATOR OPERATING SAFETY PRECAUTIONS AND WARNINGS

 Do not block the generator ventilating air inlets or outlets. The engine requires a constant supply of cooling air. Restricted ventilating air inlets or outlets can cause engine failure or fire from engine overheating.

 Do not use generator-ventilating air for heating any interior living space. Ventilating air can contain high concentrations of lethal gases.

 Check engine fuel lines often. Fuel leakage in or around the compartment is an extreme fire hazard. Do not use the generator until fuel leaks are repaired.

EXHAUST GAS IS DEADLY!

 Exhaust gases contain carbon monoxide, an odorless and colorless gas. Carbon monoxide is poisonous and can cause unconsciousness and death. See the "carbon monoxide safety precautions" section in "on the road" chapter.

 Protection against carbon monoxide inhalation also includes proper exhaust system installation and visual and audible inspection of the complete exhaust system at the start of each generator set operation.

 Do not block the tailpipe or situate the camper in a place where the exhaust gases have any possibility of accumulating either outside, underneath, or inside your vehicle or nearby vehicles.

 Outside air movement can carry exhaust gases inside the vehicle through windows or other openings remote from the exhaust opening. Operate the engine (s) only when safe dispersion of exhaust gases can be assured, and monitor outside conditions to be sure that exhaust continues to be dispersed safely.

 Do not under any circumstances operate the generator while sleeping. You would not be able to monitor outside conditions to assure that generator exhaust does not enter the interior, and you would not be alert to exhaust odors or symptoms of carbon monoxide poisoning.

 Do not operate the generator when parked in or near high grass or brush areas. Exhaust heat may cause a fire.

 Do not use the generator as an emergency power source to a residential or industrial utility line. Such operation could cause death or serious injury to workers for utility companies. Such use is unlawful in some states.

 Check the generator exhaust system after every eight (8) hours of operation and whenever the system or camper structure may have been damaged, and repair any leaks or obstructions before further operation.

 Do not modify the generator installation or exhaust system in any way.

 Disconnect generator starting battery before performing any maintenance on the generator.

 Do not overload the generator. Some installations may require that electrical loads be alternated to avoid overloading. Applying excessively high electrical loads may damage the generator and may shorten its life. Add up the rated watts of all electrical lighting, appliance, tool and motor loads the generator will power at one time. This total should not be greater than the wattage capacity of the generator. If an electrical device nameplate gives only volts and amps, multiply volts times amps to obtain watts (volts x amps = watts). Some electric motors require more watts of power (or amps of current) for starting than for continuous operation.

GENERATOR MAINTENANCE AND SERVICE

Specific maintenance requirements are outlined in the Generator Owner's Manual supplied with the camper. Follow these guidelines and /or refer to your dealer for assistance.

GENERATOR/ELECTRICAL COMPONENT INCOMPATIBILITY

Your generator has been carefully matched to the electrical components and appliances installed in your camper. Adding or changing the type of any electrical component to another type or size can cause an incompatibility with the generator circuitry. This can cause the generator or added component not to function properly.

LP GAS SYSTEM

Please observe the warnings and cautions contained in this section as well as the manufacturers supplied information with each gas appliance.

Liquefied Petroleum Gas (LP gas) is stored in a high pressure tank in liquid form and is delivered to the appliances in a gaseous form. The LP gas container(s) must not be placed or stored inside a vehicle. The container(s) are equipped with safety devices that relieve excess pressure by discharging gas to the atmosphere.

NOTE: One gallon of LP gas produces approximately 107,000 BTU's. Using the BTU rating of each gas appliance in your RV, you can determine about how long your supply will last according to your usage.

SAFETY PRECAUTIONS

LP gas is of course highly flammable and also heavier than air. It's treated to have a garlic-like odor to aid in detecting a leak. If a leak should occur, the LP gas can collect in pockets along the floor and thereby dissipate the air. If unnoticed, this could result in suffocation or an explosion.

IF YOU SMELL GAS

1. Extinguish any open flames, pilot lights and all smoking materials.
 - Do not touch electrical switches.
 - Shut off the gas supply at the tank valve(s) or gas supply connection.
 - Open door and other ventilating openings.
 - Leave the area until odor clears.
 - Have the gas system checked and leakage source corrected before using again.
2. Inspect the entire LP-gas system for leaks or damaged parts before each trip.
3. Never check for leaks with an open flame. Use an approved leak detection solution or a non-ammoniated, non-chlorinated soap solution only. If the leak cannot be located, have the system checked by qualified personnel.
4. Always be careful when drilling holes or fastening objects to the camper. A nail or screw could puncture the gas supply lines.

5. Do not restrict access to LP tanks. In an emergency, the tank service valve must be easily accessible. Do not store items or block ventilation openings in the LP compartment.
6. Do not use any LP gas tank(s) other than those furnished with your camper.

 **Turn off main gas valve and individually turn off all gas appliances or electrically disconnect automatic ignition appliances before entering an LP gas bulk plant or motor fuel service station. When not individually turned off, automatic ignition appliances may continue to spark.**

 **Do not fill LP gas containers to more than 80% capacity. Overfilling can result in uncontrolled gas flow that can cause fire and explosion. A properly filled container holds about 80% of its volume as liquid.**

7. LP gas regulators must always be installed with the diaphragm vent facing downward within 45° of vertical to minimize vent blockage that could result in excessive gas pressure causing fire or explosion.
8. Do not use a wrench or pliers to close the service valve. This valve is designed to be closed leak-tight by hand. If a tool is required to stop a leak, the valve probably needs repair or replacement.
9. When attaching the hose connector to the valve, don't force, jam or crossthread the fitting. Always check fitting for leaks after tightening.
10. Be sure the tanks are securely fastened whenever they are mounted on the camper.
11. If you do not have the special tools and training that is necessary, do not attempt to repair LP gas system components.
12. Always think safety.

FILL LPG TANK

Filling should be done only at authorized LP gas fueling stations. Please observe the following instructions when filling the storage tanks.

 **D.O.T. regulation #173-34 prohibits LP tanks from being refilled inside the RV. The tank(s) must be removed from the compartment to be properly inspected before refilling.**

Use LP-gas tanks in their proper position.

1. All new gas tanks must be purged of air and moisture before filling. A small amount of anhydrous methanol (3/4 oz per 5 gal) can be added before filling an empty tank to prevent freeze-ups. Check with you LP-gas dealer or the LP tank manufacturer's information in the Owner's Information Package provided with your camper.
2. The law requires at least a 20% vapor space for safety. A special liquid level valve is installed in the tank to indicate when the tank has reached 80% of its volume as liquid LP. Stop filling when liquid appears at this valve.
3. Use vapor only. All LP-gas appliances for cooking, heating, lighting, water heating, and refrigeration are designed to operate on LP-gas vapor only. Therefore, all LP-gas tanks designed for vapor service must be transported, installed and used in the proper position. LP-gas containers are permanently marked with "TOP" stamped on tank, welded to the tank or "ARROWS must point up" stamped in the guard or bracket to identify the proper position.
4. Do not transport, install or use a vertical cylinder in a horizontal or upside down position. Never use a horizontal cylinder or tank on its improper side. Liquid LP-gas could enter systems designed for vapor only, creating a hazardous condition.
5. Do not carry or store filled or empty LP-gas containers inside your camper. LP-gas containers are equipped with a safety device that relieves excessive pressure by discharging gas to the atmosphere. Leaks can occur at valves and fittings. Always store LP tanks with the valves closed.
6. Always use the dust cap when transporting or storing disconnected tanks (full or empty).
7. All LP gas tanks must be securely attached in the proper position for intended use. Use all brackets provided to ensure proper support and positioning.
8. Route all gas lines carefully and avoid kinking the lines.

USING LPG SYSTEM

It is normal to have a slight gas odor when initially opening the outlet valve. Fully open and seat valve by *hand only* to prevent leakage past the valve stem. If an odor seems to linger perform a leak test.

Keep outlet valves closed when not using the LP-gas system.

Do not attempt to adjust the regulator. The manufacturer has preset it. If any adjustment is required, a qualified LPG service technician using special equipment must make it.

NOTE: The Owner's Information Package contains a helpful hints pamphlet about LP gas containers.

DUAL LP GAS TANKS

Dual LP gas tanks are equipped with a two-stage automatic changeover regulator, which transfers gas demand automatically to the second tank when the first tank becomes empty.

For proper operation, both outlet valves must be opened. Turn or slide the tank selector knob so it points to the tank you wish to provide service. A small glass window is located on the regulator. A clear or green band will appear in the window indicating that pressure is in the line from the tank. After all gas is used from that tank, the regulator will automatically switch service to the other tank, and a red band will show in the window, with the arrow or slide pointing to the empty tank.

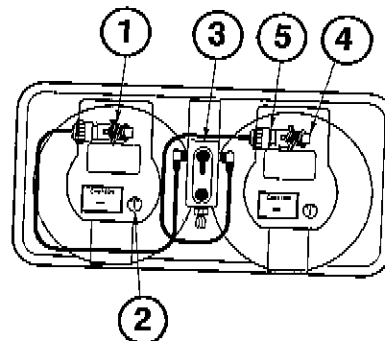

Dual Laydown LPG Tank Installation

1. Outlet Valve
2. Level Gauge
3. Two Stage Automatic Changeover Regulator
4. Liquid Level Valve (20% Valve)
5. Valve Connector

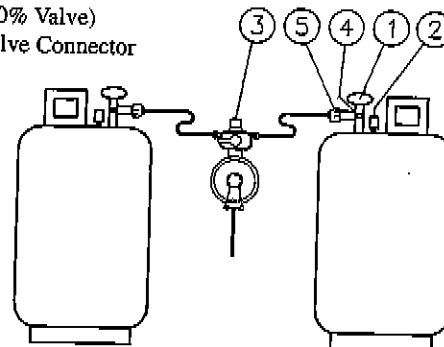

Dual Standup LPG Tank Installation

The empty tank can be removed for filling without disturbing the gas flow to the camper by rotating or sliding the tank selector to the full tank. The red band will disappear from the window indicating pressure supply from the full tank. Turn off the outlet valve on the empty tank before disconnecting.

SINGLE LP GAS TANK

Single LP gas tanks are equipped with a two-stage regulator. Be sure the regulator is securely fastened to the tank with the diaphragm vent facing downward. When using the tank, simply open the valve.

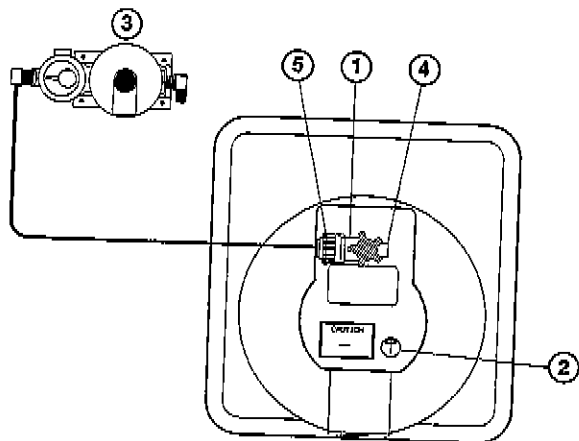

Single Laydown LPG Tank Installation

1. Outlet Valve
2. Level Gauge
3. Two Stage Regulator (Vent Facing Down)
4. Liquid Level Valve (20% Valve)
5. Valve Connector

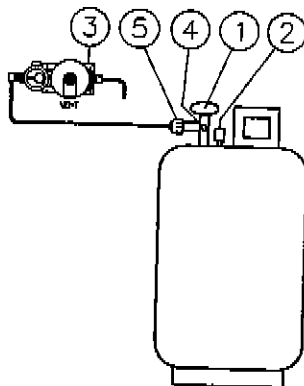

Single Standup LPG Tank Installation

LP GAS AT LOW TEMPERATURES

LP gas systems can and do freeze up in very cold weather. It is a common misconception that the regulator or the gas itself freezes. Actually, it is moisture or water vapor that gets trapped in the system or absorbed by the gas that freezes and causes the problem.

Where does the water come from? From a variety of sources. The gas can be saturated with water when it comes out of the gas plant or refinery unless care is taken to see that it is thoroughly dehydrated. The gas can absorb water while it is transported if the tank cars contain water; or the gas storage tanks may have water in them because moist air has been trapped in the tank because a valve was left open.

When this water freezes, the ice can build-up and partially or totally block the gas supply. There are a number of things you can do to prevent this freeze up.

1. Be sure the gas tank is totally moisture-free before it is filled.
2. Be sure the tank is not overfilled. This is also a safety consideration.
3. Keep the valves on empty tanks closed.
4. Have the gas tanks purged by the LP-gas service station if freeze-up occurs.
5. Have the LP service station inject an approved antifreeze or de-icer into the tank(s).
6. Be sure you have the proper gas blend for your traveling area. If you have the proper gas blend, it is very unlikely that the gas is at fault.

If, despite precautions, you do experience freeze-up, try melting the ice by warming the regulator with a cloth soaked in warm water if available or regular tap water. **DO NOT USE AN OPEN FLAME.** If the problem persists, ask your LP gas supplier to service the tank or regulator as required.

LPG LEAK DETECTOR

A permanently installed LP gas detector is located near the floor in the galley area. The unit contains an alarm that will sound, alerting you to the presence of low levels of potentially dangerous LP gas that may have been released due to a gas leak.

NOTE: This device detects the presence of LP gas, it does not disconnect the gas supply.

 Be aware of the difference between a gas leak versus gas escaping from an unlit, open burner. Pure propane gas from a leaking pipe or gas fitting is heavier than air and will build up its heaviest concentration at the floor level first. Gas from open burners is intentionally mixed with air to induce burning and will dissipate into the air. The primary purpose of the detector is to detect gas leaks. The propane from open burners is mixed with air (oxygen) so that it will burn. When mixed with air, the gas becomes only marginally heavier than air and may not sink to the floor. If a burner is left on, the area around the burner, range and adjoining counter space will be combustible and will cause injury and damage if ignited. This condition may exist for an extended time period before the gas can reach the detector's location and be detected. The detector only indicates the presence of LP gas at the sensor. LP gas may be present in other areas.

Other combustibles which may be detected by the detector include alcohol, liquor, deodorants, colognes, perfumes, wine, adhesives, lacquer, kerosene, gasoline, glues, most cleaning agents and the propellants of aerosol cans.

 When the alarm sounds, turn the gas off at the tank(s), turn off all gas appliances, extinguish all flames and smoking material and open all doors and major windows to air out the camper. Do not re-enter the camper until the alarm stops sounding. If the alarm sounds a second time after the gas is turned back on, leave the gas off and have a Lance service center make the necessary repairs to the source of the gas leak.

 This detector will not work without power.

The detector unit is powered by the 12-volt DC system and is always powered as long as the camper is connected to the truck, a charged battery, or 120-volt AC power. A green light on the front panel indicates that the detector has power. The fuse for the detector is located behind the detector.

Test the leak detector each time the camper is relocated and set up for use.

Press the test switch. The LED should flash RED and the alarm should sound. Release the switch.

 Do not use a cigarette lighter to test the alarm.

A mute button will allow you to temporarily quiet the alarm after it has been set off or after testing. If the alarm does not sound during a test or if the green indicator light is not visible, check the fuse located behind the detector. If there is power to the detector and it does not operate, see your dealer. **There are no internal batteries or user serviceable parts inside this unit.**

NOTE: Since the detector is continuously powered, disconnect the battery if you are not using your camper. Low camper battery power will cause a series of short beep tones between long intervals and is distinctively different from the alert sound.

APPLIANCES

Follow the operating and maintenance instructions supplied by the appliance manufacturer for safe and dependable use. The following information is supplied as only a supplement to that provided with each appliance. If you have a problem, see your local Lance service center or call the appliance manufacturer listed in the back of this manual.

LIGHTING LP-GAS APPLIANCES

NOTE: New LP tanks or empty tanks that have been sitting with the valve open for a period of time, must be purged of air and moisture prior to filling.

Air trapped in the gas lines may delay the initial lighting of any appliance. It could take several seconds or minutes for the gas to reach the appliance. To purge some of the air from the gas system, first light a burner on the range. The other appliances will then light more quickly.

The first time the furnace or oven is operated, paints and oils used in manufacturing may generate some smoke and fumes. If this occurs, open doors and windows to air out the camper. These materials should burn off after the first 15 to 20 minutes of operation.



Always follow the appliance manufacturer's lighting and operating instructions.

REFRIGERATOR

The refrigerator operates on 12-volt DC power, 120-volt AC power and LP gas. The operating instructions supplied in the Owner's Information Package will help you with detailed information from the manufacturer.

The recreational vehicle LP type refrigerator operates on the "absorption" principle and therefore must be reasonably level. When your camper is stationary, it should be leveled for comfortable living. If you can occupy the camper comfortably, the refrigerator unit should perform well. If the refrigerator unit is not "close to level", it may not function properly and your food will not be adequately cooled.

When the RV is in motion, the continuous movement will not affect operation. The operating instructions are printed inside near the controls and may be found in the manufacturer's instructions manual.

OPERATING TIPS

- Operate the refrigerator on 120-volts for 8 to 12 hours (overnight) before you leave on a trip. This will allow the refrigerator and freezer to get cold and even have some ice ready.
- Pre-cool food and drinks before putting them into the camper refrigerator.
- For off-truck use, some refrigerator models must have 12-volt battery hookup to power the electronic controls. Refer to the supplied appliance manuals for proper operating instructions.

RANGE-OVEN

The gas burners and oven use LP gas for fuel. Operation is similar to the range in your home. However, cook temperatures will vary from home ranges depending on the altitude.

Most camper models are equipped with a spark igniter for lighting the top burners while some models require matches or hand held igniter for lighting the burners.

The three (3) burner range used in the most camper models is equipped with one (front) high output burner when additional heat is needed.

All ovens are equipped with a pilot light that must be lit before using the oven. Be sure to turn OFF the pilot when the oven is not needed or before traveling or refueling. For additional information, please refer to the operating manual supplied in your *Owner's Information Package*.



Before turning on the main gas supply, be sure all burner and oven control knobs are in the "OFF" position.



It is not safe to use cooking appliances for comfort heating. Do not use open flames to warm the living area.

Cooking appliances need fresh air for safe operation.

Before operation:

1. Open overhead vent or turn on exhaust fan.
2. Open window.

The warning label above has been located in the cooking area to remind you to provide an adequate supply of fresh air for combustion. Unlike homes, the amount of oxygen supply is limited due to the size of the recreational vehicle, and proper ventilation when using the cooking appliance(s) will avoid danger of asphyxiation. It is especially important that cooking appliances not be used for comfort heating as the danger of asphyxiation is greater when the appliance is used for long periods of time.

Never use portable fuel-burning equipment, including wood and charcoal grills and stoves inside the vehicle because a fire or explosion may result.

MICROWAVE OVEN (If equipped)

Please read all instructions that come with the microwave before use. The oven should never be operated empty.

When operating on your generator (if equipped) power is limited. If the roof air conditioner is operating there may not be enough power to operate the microwave. Turn the air conditioner control to "fan only" setting to use microwave.

WATER HEATER

Access to the heater controls and valves is through the exterior compartment door. Some models are equipped with an electric igniter switch for pilot lighting. Lighting instructions are printed inside the compartment door.

Before lighting, open the water heater relief valve and run until water flows without presence of air. *Do not operate the water heater until it is filled with water.*

Turn on the hot water at the galley sink, and when water flows continuously the heater is full.

Occasionally you may experience "weeping" of the pressure/temperature relief valve. *This is not a defect.*

It is caused by the normal expansion of the water while being heated. The tank is designed with an internal air gap at the top to reduce this weeping phenomenon. In time, though, the heating and expansion of the water will absorb this air. To replace the air and reduce relief valve weeping:



Wait until the water in the heater tank is cool before performing the following steps.

1. Turn off the water heater.
2. Turn off incoming water supply.
3. Open a faucet in the camper.
4. Pull the handle of the relief valve straight out and let water flow until it stops.
5. Release the relief valve handle and let the valve snap shut.
6. Turn on the water supply.
7. Close the faucet when water flows continuously without sputtering.
8. Turn on the water heater.

This procedure will re-establish the air pocket at the top of the tank. If the relief valve weeps again, repeat the above procedure.

CAUTION: *Do not plug the pressure-temperature relief valve under any circumstances.*

If the water heater will be "out of service" for some time, it should be drained. See "Storage" chapter for more information.

When using hot water faucets in the camper for the first time after heating water, open the valve *slowly* to reduce water splattering from pressure build-up.

AUTOMATIC IGNITION

WATER HEATER (If equipped)

If your camper is equipped with a fully electronic water heater, which has no pilot light, simply turn ON the water heater switch located on the monitor panel. The water heater will cycle on and off as needed. If the water heater fails to ignite, a red light on the panel will appear. Check to make sure you have adequate gas and battery supply. Move switch off and back on again.

NOTE: Suburban water heaters are equipped with an anode rod that is attached to the drain plug and extends into the water heater tank. This rod requires yearly inspection and periodic replacement. Consult your Suburban Owner's Manual for full details or contact your Lance Dealer Service Center.

FORCED AIR FURNACE

(Automatic Ignition)

The furnace is a forced air unit fueled by LP gas and electronically powered by 12-volts. A wall-mounted thermostat similar to those used in homes controls it. To *start* the furnace, set thermostat switch to the ON position and set desired temperature. The furnace will cycle on and off as needed. To *stop* the furnace, set the thermostat to lowest setting and the Off position. If your furnace does not operate properly, check the battery condition and LP-gas supply.

CAUTION: The furnace will not operate properly if your stored personal items block the free flow of air at the registers or return air to the furnace.

The operating manual included in your *Owner's Information Package* contains detailed operating and maintenance instructions.

During the initial lighting of a furnace, smoke and fumes may be created as a result of the burning off of manufacturing compounds. This is **normal**, however, the initial lighting should be done with windows and doors open and should be of adequate duration to completely burn off residue.



Portable fuel-burning appliances are not safe for heating inside the camper. Asphyxiation or carbon monoxide poisoning can occur.

ROOF MOUNTED AIR CONDITIONER

(If equipped)

The roof mounted air conditioner operates on 120-volt power which is supplied through the 30 amp power cord, either from an outside 120-volt power service or by the onboard generator, if equipped.

The air conditioner will provide cooled air for your comfort. However, it is the largest single load of electrical usage. It is important to manage your electrical usage when you have either an air conditioner or microwave oven installed or both.

1. Be sure air conditioner is OFF before connecting electricity.
2. When the air conditioner has been shut down, wait at least five minutes before restarting.
3. Do not operate without a filter installed.

Helpful Notes for Using the Air Conditioner

- Keep window curtains closed.
- Use kitchen vent fan when cooking.
- Air conditioning removes moisture from the air and it is normal to have water discharge off the roof.

COMBINATION FURNACE/AIR CONDITIONER THERMOSTAT

(If equipped)

The wall-mounted combination thermostat will operate either the furnace or air conditioner from one location. An additional feature is the Electric Heat Strip. The heat strip is located in the air conditioner unit and is activated by switching the system switch to Heat Strip on the thermostat.

The operating instructions included in your *Owner's Information Package* contains detailed operating and maintenance instructions.

On some models, operating the air conditioner on the optional generator will use most of the electrical power available. Energy management is important when the air conditioner is operating. Care must be taken when turning on too many other 120-volt appliances. Experience will provide knowledge of how to operate the campers' electrical system the best.

FRESH WATER SYSTEM

Your Camper is outfitted with a system designed to provide fresh (potable) water service from an onboard water tank or a city water connection with a fresh water tank fill located on the roadside of the camper.

When connecting to the city water hookup, use only a non-toxic water hose, available at most RV supply stores. Since water pressures at campgrounds and household hookups vary, you should install an inline pressure regulator at the water supply faucet. This will protect both the camper water system and supply hose from excessively high water pressure.

WATER PUMP

The pump is located under the forward end of the galley cabinet. The model number is indicated on the pump data label.

CAUTION: *The pump is not equipped with a dry tank shut-off switch. Turn the pump switch OFF if water in tank becomes depleted or when system is not in use.*

The pump operates when water pressure within outlet plumbing drops below a predetermined pressure. A drop in pressure occurs when a faucet or a toilet valve is opened. When the faucet is closed the pump shuts off as soon as the system is repressurized.

Turn the pump ON to pressurize the water system. When the faucet is opened, the water may sputter for a few seconds. This is **normal** and no cause for alarm. The water flow will become steady when all air is bled from the water lines. If a faucet is open slightly, allowing water to flow slowly, the pump may pressurize the plumbing faster than the water is released, causing the pump to cycle on and off.

A built-in check valve prevents back flow and protects the pump and fresh water tank from excessive city water system pressures. At free flow the pump draws approximately 4 amps. A fuse in the power center protects the water pump circuit.

When traveling, always turn OFF the water pump. This will reduce the possibility of water flowing

during travel. If the pump cycles on and off when no water is being used, you may have a partly open faucet, a leak in the water system or an empty water tank.

Never attempt to service the pump without first turning off the power and opening all faucets to relieve pressure in the water system. Consult the installation and operation manual for full details in the *Owner's Information Package*.

WATER TANK FILL

The fresh water system should be sanitized at the initial filling, after a period of storage or if contaminated. See "Sanitize Fresh Water System" in this section.



Fill tank slowly. do not overfill. Do not leave unattended while filling. Structure damage may occur.

Filling the fresh water tank:

1. Close water tank drain petcock located at the rear or rear side of the camper.
2. Remove cap on fresh water fill inlet.
3. Using a 3/8" hose adapter, fill the water tank through the exterior fill spout slowly at a low volume until water overflows out the vent. **Do not** force water into spout since air in the tank must be released during filling. Do not put the potable water hose into the mouth of the fill.

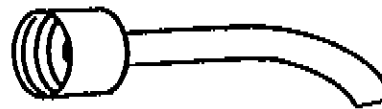

3/8" Plastic Hose Adapter For Filling Water Tank

4. Set pump control switch to ON.
5. Open each faucet one by one until water flows evenly, and no air bubbles are evident.
6. Top off water tank through the exterior fill spout to replace water used in filling the water heater and purging the water lines of air.
7. Replace cap and lock the access door (if equipped).

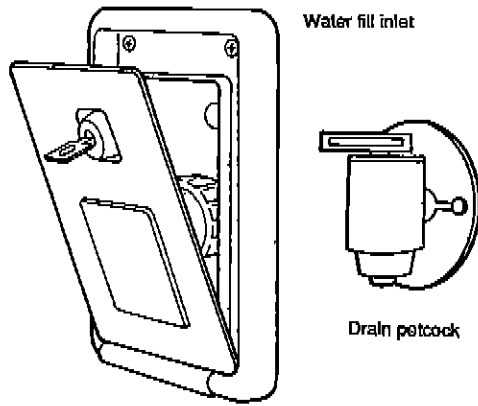

Typical Fresh Water Inlet and Drain

CITY WATER CONNECTION

The city water inlet connection is located under the roadside overhang.



You may wish to purchase a pressure regulator to protect your camper from possible damage due to excessive water pressure.

To supply city water to your camper's water system and bypass the water pump:

1. Attach a potable water hose to the exterior city water inlet connection.
2. Pump switch should remain in OFF position.
3. Open each faucet until water flows evenly.

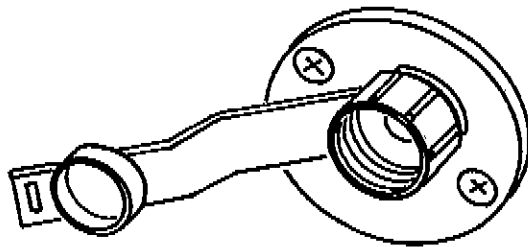

Typical City Water Connection

WATER SYSTEM DRAIN

The water system should be drained if it will be out of service for more than one week. This will prevent algae and bacteria contamination of your fresh water system. To drain your camper:

1. The camper should be level and pump control switch in OFF position.
2. Open all faucets and showerhead.

3. Open water tank drain valve.
4. Open water line low point drains usually located under shower area.
5. Open water heater drain and relief valves. (See Winterization and Storage section for more information.)

SANITIZING FRESH WATER SYSTEM

Sanitize the fresh water system and piping at initial use, at least once a year and whenever the camper sits for a prolonged period. This will help keep the tank and lines fresh and will discourage the growth of bacteria and other organisms that can contaminate the water supply. Rinse the tank with a chlorine/fresh water solution as follow:

1. Drain water system. (See Drain Water System above).
2. Prepare a chlorine solution with one gallon of water and 1/4 cup household bleach.
3. Pour one gallon of solution for each 15 gallons of tank capacity into fill spout.
4. Fill tank with fresh water.
5. Open each faucet and water heater relief valve until water flows evenly.
6. Set pump switch to OFF.
7. Allow solution to stand for 3 hours.
8. Drain and flush with fresh water.
9. To remove any chlorine taste or odor, fill tank with one quart vinegar to 5 gallons water. Allow solution to remain in tank several days if possible.
10. Drain and flush with fresh water.

WATER FILTER

Dirt, mineral scale, or organic matter is filtered out of the fresh water system by an in-line water filter attached to the inlet side of the water pump. If you suspect a clogged filter, it is easily removed and cleaned.

- Loosen the clamp at the inlet end of the filter.
- Pull the water hose off the filter.
- Unscrew the filter from the water pump.
- Turn each end of the filter and pull apart.
- Flush out and clean screen.
- Reverse procedure to install and check for leaks.
- Inspect the filter after the first 90 days of use, clean it if necessary, and inspect annually thereafter.

SHOWER

The showerhead is removable for hand-held use and equipped with a water flow control device to allow you to conserve water while showering. After showering, there may be some water discharge at the sink faucet. This water is draining from the shower hose through an anti-siphon valve in the faucet and is normal.

EXTERIOR WASH STATION (If equipped)

The exterior wash station is located in a roadside compartment for exterior use. It uses water from the fresh water tank or when connected to the city water hookup. The showerhead is equipped with a flow control to allow you to conserve water. This flow control is not a permanent shut off. After use of the shower, the water must be shut off at control valves or possible damage could occur to the showerhead and/or hose.

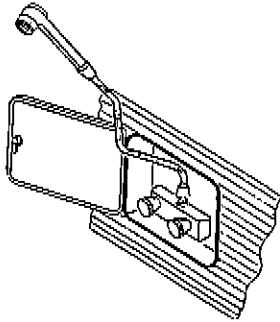

Exterior Wash Station

NOTE: For your protection, this faucet is equipped with a vacuum breaker (backflow preventer) to prevent contamination of your potable water supply. The water in the hand-held shower hose will drain through this vacuum breaker when the faucet is turned OFF. This is not a leak. This drainage is inherent in the design of the vacuum breaker, and is evidence that it is functioning.

Due to design precautions, hand held shower heads, when in the "hold" position must have a built-in leak rate of not less than 1 gallon per 30 minutes of time. This leakage is not a defect but is an attempt to reduce the possibility of scalding accidents due to temperature changes from fluctuating water pressure.

WASTE SYSTEM

The waste holding system in your camper is made up of sinks, shower, toilet plumbing drain and vent lines, "gray water" holding tank, and "black water" holding tank. The holding tanks make the system completely self-contained and allow you to dispose of wastewater at your convenience. A flexible sewer hose is supplied to connect the holding tank outlet to the inlet of an approved wastewater dump station or sewer system.

The holding tanks are made of seamless plastic that will not corrode. On most units with dual tanks, one retains toilet waste and the other retains liquid waste from the sinks and shower. Drain all wastes at an approved site.

On some 8-foot models, the shower drains into the toilet waste tank. To prevent wastes from backing up into the shower (especially while driving) keep the locking basket strainer in the shower drain except when showering.

INSULATED AND HEATED WASTE HOLDING TANK COVER

(If equipped)

To help keep the waste tanks and dump valves from freezing when using in below freezing temperatures, an insulated cover is installed to enclose the waste tanks and valves. When the furnace is in operation, warm air is discharged into the compartment.

NOTE: In extremely cold weather, non-toxic anti-freeze should be added to both tank contents to provide the maximum protection.

FRESH WATER FLUSH TOILET

Your camper is equipped with a marine-type recreational vehicle toilet. This toilet is especially designed to operate with a minimum of water usage. The flushing mechanism, a hand-operated lever, allows a valve in the bottom of the bowl to open, permitting the contents to be flushed into the holding tank below. A stream of water under pressure from the camper's water system, swirls around the bowl, cleaning and flushing the contents. Most models have two levers, each working independently of the other so the bowl can be filled with water prior to use.

For additional information, please refer to the operating manual supplied with the toilet.

NOTE: The toilet requires a water supply for proper use. This can be from either a city water hookup, if available, or from the on board fresh water tank supply. The 12-volt water pump switch must be in the "ON" position when using water from the tank.

BLACK WATER HOLDING TANK

This holding tank must be primed with 2 gallons of water and one odor control chemical package at each initial use. Add more odor control chemical if needed until dumping is required. Refer to the chemical package available at most RV outlets for specific instructions.

DUMPING THE HOLDING TANKS

The holding tanks terminate in a valve arrangement that permits each tank to be dumped separately or together (see picture below). The valves are called "knife valves". A blade closes the opening in the sewer drainpipes. The blade is connected to a T-handle that is pulled to release the contents of the tank(s).

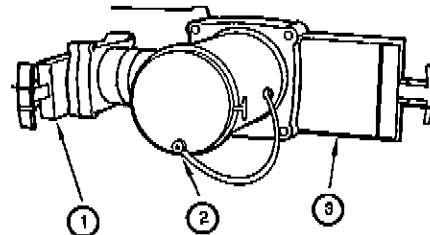

1. Gray water drain valve
2. Drain outlet
3. Toilet waste drain valve (large valve)

Typical Drain Assembly

During self-containment use, the sewer outlet line should be securely capped and valves closed to prevent leakage of waste material on the ground or pavement.

▲ Holding tanks are enclosed sewer systems and as such must be drained into an approved dump station. Both black and gray water holding tanks must be drained and thoroughly rinsed to prevent accumulation of harmful or toxic materials.

Dump the holding tanks only when they are about 2/3 full. If necessary, fill the tanks with water to 2/3 full. This provides sufficient water to ensure complete flushing of waste material into the sewer line. Whenever possible, dump the holding tanks before traveling.

The holding tanks outlet is set up to be used with a removable fitting that locks onto the outlet with a clockwise twist. The sewer drain hose is clamped on this fitting when you need to drain the holding tanks. When you are operating self-contained, or you store the camper, install the protective cap in place of the removable hose.

The sewer (dump) hose is compressed and stored in the camper's hose carrier (rear bumper if equipped). When you want to drain the holding tanks:

1. Attach the sewer hose to the dump outlet.
2. Extend the hose and insert the hose end into the sewer or dump station inlet, pushing it firmly into the opening to be secure. In some cases, adapters may be necessary between the hose and inlet.
3. Arrange the sewer hose so it slopes evenly and is supported to maintain the slope.
4. Dump the black water holding tank first. Grasp the handle of the black water knife valve (the large one) firmly and slide the valve open with a steady pull.
5. Allow enough time for the tank to drain completely. Rinse and flush the tank and drain hose through the toilet with a bucket of water or a hose.
6. When the tank flow stops, push the handle in to close the valve.
7. Pull the small handle for the grey water holding tank. Repeat steps 4 through 6. This tank is dumped last to aid in flushing the outlet and drain hose.
8. Remove the sewer hose and replace the outlet cap.
9. Rinse out the sewer hose with fresh water and remove the sewer hose from the dump station.
10. Replace sewer or dump station cover(s).
11. Store the sewer hose.

NOTE: To facilitate draining on 8-foot models, the camper should be level or slightly higher in the front. On 9', 10' and 11' models, raise the passenger side of the camper to drain towards the driver's side.

If you are parked at a site with a sewer hookup, keep the black water knife valve closed to allow the waste level to build up. The outlet will probably clog if you leave the knife valve open continually. Run enough water into the tank to cover the bottom. This will aid the break up-of solid wastes. The gray water knife valve may be left open.

PLEASE PRACTICE GOOD HOUSEKEEPING WHEN DRAINING WASTES AT A CAMPSITE OR DISPOSAL STATION. LEAVE THE SITE IN GOOD ORDER. ABOVE ALL, PLEASE DO NOT POLLUTE.

HOLDING TANK CARE/ MAINTENANCE

Since holding tanks don't rely on any sophisticated mechanical devices for their operation, they are virtually trouble-free. The most common problem is also an unpleasant one-*clogging*. You can minimize chances of clogging by keeping the following considerations in mind:

- Keep the black water tank knife valve closed. Be sure to cover the tank bottom with water after dumping.
- Movement while driving will help liquefy the solids.
- Use only toilet tissue formulated for use in septic tank or RV sanitation systems.
- Keep both knife valves closed and locked, and the drain cap tightly in place when using the system on the road.
- Use only cleaners that are approved for use in septic tank or RV sanitation systems.
- Use a special holding tank deodorant chemical approved for septic tank systems in the black and gray water holding tanks. These chemicals aid the breakdown of waste and make the system much more pleasant to use.
- Do not put facial tissue, paper, grease, ethylene glycol-based or other automotive antifreeze, sanitary napkins or household toilet cleaners in the holding tanks.
- Do not put anything solid in either tank that could scratch or puncture the tank.

If the drain system does get clogged:

- Use a hand-operated probe to loosen stubborn accumulations.
- Seriously clogged P-traps may require disassembly. Be careful not to overtighten when reassembling.

- Do not use harsh household drain cleaners.
- Do not use motorized drain augers.
- Sometimes the holding tank valve will get clogged. In this case, a hand-operated auger may be necessary. Be ready to close the valve quickly once the clog is cleared. If the seal gets damaged, it must be replaced.

SLIDE-OUT ROOM SYSTEM

SYSTEM DESCRIPTION

The slide-out room uses a rack and pinion mechanism to move the room. The pinion gears are driven by a 12-volt DC electric motor by the camper battery. A rocker switch mounted on the wall controls the room movement.

SYSTEM OPERATION

During extension or retraction of the slide-out you may hear some noises that are associated with the electrical motor or mechanical system. These sounds are normal. If other loud noises occur, contact your Lance Dealer or the Lance Service Center.

Remember that when the slide-out room is outside of the camper. Outside elements such as rain, snow, dirt or other debris may cling to the outside surfaces of the room and could affect the function of the slide-out room. When the room is retracted, material clinging to the exterior surfaces may be brought into the camper. Always check the exterior surfaces of the slide-out room before retracting it. Remove excess water, snow, dirt, or other debris. Ensure that the outside surfaces are as clean and dry as possible.

The seals around the outside of the slide-out are not designed to act as a squeegee. Do not depend on them to remove water.

NORMAL OPERATION

 **Read and understand this section of the Owner's Manual to avoid injury and/or property damage. Keep people and objects clear of the slide-out room during operation.**

 **The camper must be level before operating the slide-out room.**

 **Remove/disengage travel locks and any obstructions that may restrict the slide-out room movement.**

 **Before extending or retracting the slide-out room, open a vent, window or door. The operation of the slide-out room can create enough vacuum or pressure to damage windows or doors.**

 **DO NOT MOVE THE CAMPER WITH THE ROOM EXTENDED.**

To operate the slide-out room, press the control switch to **IN** or **OUT** depending on the position of the room. When the room is fully extended or retracted, release the switch. The motor has a built-in clutch which will ratchet if the switch is held after the room makes contact with the interior or exterior seals. There is also a thermo limiting circuit breaker built into the controller which will sense an increased load applied to the motor and will automatically shut off the motor.

After a few seconds, the breaker will reset itself.

When the room is in the retracted position, the travel locks should always be in place. The weather seal can separate between the slide-out room and the sidewall while traveling, causing water leaks. The travel locks will help to insure a good seal. The travel locks should always be in place during travel and during storage when the slide-out is retracted.

MANUAL OVERRIDE OPERATION

The slide-out room system can be overridden to extend or retract the room in case there is an electrical power interruption or failure, or other system malfunction.

 **During manual operation of the slide-out, the confined working quarters can cause pinch and crush hazards. Ensure that the slide-out path is clear of obstructions in the interior of the camper.**

If the slide-out room will not move when the switch is pressed, check the following:

The battery is connected and fully charged.

The power fuse located in the exterior light fuse box under the galley is not blown.

The travel locks are removed/disengaged and there are no other obstructions in the room's path.

The camper is level and not in a rack or twisted position.

Confirm that the slide-out switch is centered in the **OFF** position.

Depending on your camper model, there are two different slideout mechanisms. They operate identical except for the manual over-ride. One unit has a second switch located inside the cabinet behind the slideout control switch. Turning this switch to off will let the electric slide motor turn easier. This will allow you to crank the room in or out. After the room has been extended or retracted, turn the switch back to on to lock the room in position. The second unit has the

above features plus there is a disengage lever located on the motor. It is a white lever located at the end of the motor where it fastens to the slide-out mechanism. The lever is located about 27" to the left of the center of the slide-out room when facing the room from the interior of the camper. Flip the lever to the right to disengage the motor. When the room is in the extended position, the motor and disengage lever is accessible through a removable access panel located under the left dinette seat box.

The room is now free to move.

Be sure there are no obstructions in the slide-out room's path. The room can be manually pushed or cranked using the crank handle and crank extension supplied. Turn the shaft in the necessary direction to extend or retract the room. When the room is fully extended or retracted, the motor disengage lever must be returned to its locked position.



Failure to engage motor could cause slide-out room to move during use or in transit.

When fully retracted, engage travel locks and contact you Lance Service Center for service, if required.



When the motor is disengaged, the slide-out room WILL NOT lock in place. It will not be sealed from either the interior or exterior. When the room has been fully retracted, be sure to re-engage the motor to seal and lock the room.

SYSTEM MAINTENANCE

ELECTRICAL SYSTEM MAINTENANCE



Disconnect all power sources before performing any service work on the system. This includes the 120-volt AC power to the converter, the battery and the connection between the camper and the truck.

The slide-out room system requires a minimum battery voltage of 12-volts. Be sure the battery is fully charged for best performance.

Maintain the battery as outlined in the Battery Section under Electrical Systems.

Check the terminals and other connections at the battery, fuse panel and the control switch. Be sure the connections are tight, clean, undamaged and corrosion-free.

MECHANICAL MAINTENANCE

The slide-out room mechanism is designed to be virtually maintenance free.

During long-term storage, apply a seal dressing such as 303® Protectant slide-out room seals, retract the room fully and install the travel locks. The travel locks will insure a positive seal. 303® Protectant is available at most RV or auto parts supply stores. This dressing will also lubricate the seals and make it easier to extend and retract the slide room.

SYSTEM TROUBLESHOOTING

The camper body, the slide-out room and the slide-out room mechanism make up a slide-out room system. Each needs to function properly with the others. Every unit has its own characteristics. Symptoms of malfunction may appear to be the same, but troubleshooting and fixing a problem must include a thorough check of all the interrelated components.

When something restricts room travel, the drive mechanism is designed to stop. If the room is restricted, the system may put undue pressure on the camper body, slide-out room or mechanism. The room may not seal properly and the obstruction may cause fatigue and premature system failure.

Before troubleshooting the system or contacting an authorized Lance Camper Service Center, make sure the battery is fully charged and there are no obstructions to room movement.

ELECTRICAL TROUBLESHOOTING

There are no field serviceable parts in the motor or control system, therefore electrical troubleshooting and service by the owner is limited to thorough checking of wiring and connections, checking the fuse at the fuse box and proper battery maintenance.

Contact an authorized Lance Service Center for any other service requirements.

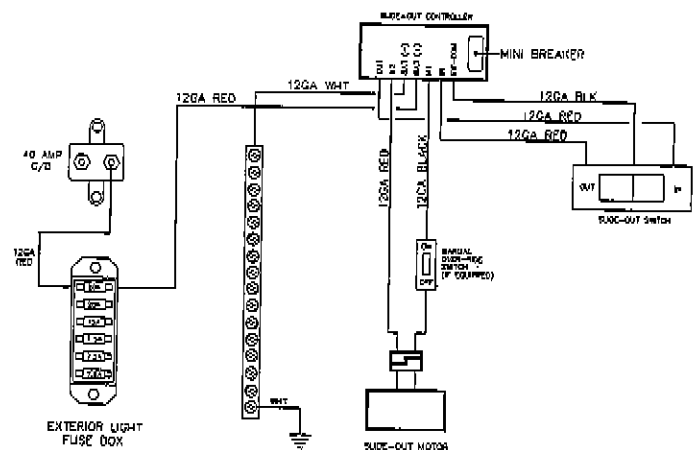

Slide-Out System Electrical Diagram

GENERAL MAINTENANCE

EXTERIOR MAINTENANCE

Some exterior parts of your camper are made of fiberglass, metal, rubber and plastic materials. The finish on these parts is durable, but not indestructible. Any material and finish will deteriorate over time. Exposure to sunlight, moisture, and airborne pollutants can chemically alter the composition of the base and finish materials and cause dulling and fading of the finish. Generally, changes in the finish due to weathering are cosmetic - they are on the surface of the part and do not affect its strength.

The best insurance against these affects is routine maintenance. If the finish is not washed thoroughly and waxed, the surface can deteriorate very rapidly. The following guidelines can help you reduce these weathering effects:

Wash the exterior at least once a month using a liquid detergent. Never use strong abrasives to clean the exterior surfaces.

Wax the exterior of aluminum at least once a year, preferably twice, with a quality non-abrasive wax. When waxing, always read and follow instructions and precautions on the container. Some cleaners and waxes are recommended for use on only certain types of surfaces. Exterior streaking is reduced with more frequent waxing.

If you wish to wax the exterior of fiberglass sided units, use automotive waxes or cleaners/polishes developed for use on fiberglass boats, showers and tubs. Be sure to follow the directions on the wax container.

Rubbing alcohol can be used on caulking that show signs of yellowing.

 **Do not use abrasive cleaners or rubbing compounds. Do not dry wipe the fiberglass surface, clean only with water and liquid detergent.**

DAMAGE CHECKS

It is important to periodically check the exterior for damage. Pay particular attention to the following areas:

- Waste tanks and plumbing lines.
- LP-gas tanks and assembly.
- Sealant around doors, roof, vents and windows.
- Exterior lighting.

DOORS AND WINDOWS

Lubricate door hinges, locks and window mechanisms periodically. Clean window frames and tracks to

ensure easy operation. If the camper is exposed to salt air, more frequent lubrication will be required.

SEALANT RENEWAL OF ROOF, DOOR, WINDOWS AND JACK BRACKET ANCHOR POINTS

The adhesives and sealants used in the construction of your camper were developed to remain waterproof under sustained effects of weather and vibration. However, even the finest materials will eventually dry out and lose their effectiveness under constant heat of the sun and attack by other elements. This section outlines the procedures that you must follow to maintain the weather-resistant integrity of your camper. Leak damage caused by neglecting to follow these procedures may affect your warranty.

The jack brackets can loosen and the seals separate during regular use. It is important to periodically check the four corner brackets to insure the fasteners are tight and the seals are not cracked as rocking can occur during normal loading/unloading and while your camper is in storage.

Your dealer can perform the resealing inspection and work for you, and has current information on sealants used in your camper and can recommend the appropriate sealants if you prefer to do this work yourself. Always use the recommended sealants.

To protect your camper from possible water intrusion damage, your unit should be inspected thoroughly and resealed bi-annually.



ROOF IS SLIPPERY WHEN WET.

Inspect the sealant around the roof, windows and doors at least every six months. If any of the following are evident during inspection, the affected areas must be resealed:

- Weathering or drying of sealant.
- Sealant cracked or peeling.
- Voids in sealant.
- Shrunken or separated sealant.

If you find any of the above:

- Remove excess sealant with a plastic scraper.
- Clean all areas to be resealed with mineral spirits.
- Make sure that all areas to be resealed are absolutely dry before new sealant is applied.



Mineral spirits is a flammable liquid. Use extreme care when handling. Do not expose to open flame, sparks, or smoking materials. Do not use in unventilated areas.

INTERIOR MAINTENANCE

INTERIOR ODOR

New campers may have a strong odor and even cause eye irritation when closed up in hot weather. This is due to glues used in the cabinetry and paneling. This condition passes with time but in an extreme condition open door and all windows and allow the inside to air out for several hours.

UPHOLSTERY AND DRAPES

Professionally clean only. Some dry cleaning methods will damage vinyl or plastic found on cushions and drapes. Be sure to consult you local cleaners. Frequent vacuuming or light brushes between cleanings will help prevent accumulation of dirt and grime. Use of water based or detergent based cleaners may cause shrinking. Water stains may become permanent.



Do not use lacquer thinner, nail polish remover, carbon tetrachloride, gasoline, or naphtha for any cleaning purpose. These products may cause damage to the material being cleaned, and are highly flammable or poisonous.

WALL AND CEILING PANELS

The paneling and ceiling of your camper may be any of several finishes and textures. Never use harsh detergents or abrasive cleaners on walls or ceilings. Most surfaces will clean with a soft cloth moistened with mild liquid detergent in warm water. Do not use large amounts of water which could saturate the material.

FLOORS AND CARPETING

Vinyl flooring requires only washing and periodic waxing. Vacuum carpeting regularly, and clean it with a quality carpet cleaner.

WOOD PRODUCT CARE

Remove dust with a clean, slightly damp cloth. Apply a quality furniture polish and buff with a soft, dry cloth. Never use harsh detergents and solvents.

LAMINATE TOP CARE

For cleaning laminated surfaces, use a mild dishwashing liquid with warm water. Use a soft cloth for both washing and drying. Abrasive

cleaners, steel wool or gritty cleaners will damage the surface.

POWER RANGE HOOD

Clean the filter in detergent and hot water periodically and wipe down the surface of the unit with mild soap and water. Use a soft cloth for both washing and drying.

REFRIGERATOR

Clean interior with mild soap and water after each trip. Defrost freezer and empty ice trays. When defrosting, be sure that the drip tray is in place under the finned evaporator - defrost water will be carried through a tube from the drip tray to the bottom of the camper overhang below the refrigerator. Periodically check the drain tube to assure it does not become plugged. Leave the door open after cleaning.

DRAINS

If a stoppage develops in the sink or shower drain, **DO NOT** use lye or any strong chemicals. Strong chemicals can harm the plastic in your waste system. A standard wire drain cleaner is recommended.

SHOWER CARE

For routine cleaning use a non-abrasive cleaner. Household fiberglass cleaners are recommended. Never use harsh detergents or abrasive cleaners. Never use a razor blade or steel wool to clean the surfaces.

MAINTENANCE CHART 1

| Service to be Performed For details, see respective section. | Start of Each trip | Before use At Setup or Weekly | Monthly |
|---|-----------------------|-------------------------------------|------------|
| Inspect wiring, connector plug & receptacles | ■ | | |
| Check exterior lighting | ■ | | |
| Inspect camper jacks | ■ | | |
| Check that camper anchors are secure | ■ | | |
| Check that cabover stabilizers are secure | ■ | | |
| Inspect LPG system compartment | | ■ | |
| Inspect LPG leak detector | | ■ | |
| Inspect generator exhaust (if equipped) | | ■ | |
| Check smoke detector operation | | ■ | |
| Check carbon monoxide detector operation | | ■ | |
| Check fire extinguisher | | | ■ |
| Inspect/clean battery, cables, terminals | | | ■ |
| Check battery charge (in storage) | | | ■ |
| Check battery electrolyte (in use) | | | ■ |
| Test GFCI | | | ■ |
| Wash Exterior | | | ■ |
| Inspect water pump filter | First time | | Thereafter |

MAINTENANCE CHART 2

| Service to be Performed For details, see respective section. | Every 3 Months | Every 6 Months | Annually or After Long Storage |
|---|-------------------|-------------------|--------------------------------------|
| Inspect roof sealants | | ■ | |
| Inspect doors & window sealants | | ■ | |
| Inspect all hot, cold, drain plumbing | | | ■ |
| Sanitize fresh water tank | | | ■ |
| Complete LPG pressure check & system check | | | □ |
| Clean interior as necessary | | | |
| Wax exterior | | | ■ |
| Clean & Lube overhead vents | | | ■ |
| Lube locks, hinges, and hardware | | | ■ |
| Replace smoke detector battery | | | ■ |

Items marked with □ require special equipment and/or qualified personnel.

WINTERIZATION

OPERATING IN FREEZING CONDITIONS



If water freezes inside the system, it can damage piping and equipment.

Keeping the interior warm will aid in preventing water in the storage tank, pump and piping from freezing. Open inside cabinets and allow warm air to circulate over the water system components.

Add non-toxic anti-freeze to the holding tank(s). Refer to instructions with the anti-freeze. Install a winter cover for the air conditioner.

LP gas (propane), fuel for the appliances will work down to 44 degrees below zero (-44°).

The sliding windows have weep holes which drain water from the window tracks. In heavy rain and wind, water could be blown into the camper through these holes. Put a piece of sponge in the track over the hole to prevent this from occurring.

See "Ventilation and Moisture Control" section for more information.

STORAGE

The following checklists will help you perform the steps necessary to prepare your camper for storage. Use the checklist that applies to the storage conditions you anticipate. These checklists do not include every detail required, and you may want to expand them to suit your needs.

SHORT-TERM STORAGE

(Less than 45 days — Above Freezing)

1. Wash the exterior.
2. Park the camper as level as possible front to rear and side to side.
3. Before disconnecting the battery cables, check the charge in the battery. Recharge as necessary. Clean terminals, top and sides of battery and battery box. Leave the battery disconnected or switched to off position.
4. Drain holding tanks, toilet, and fresh water tank. Turn off water pump and water heater. On Suburban water heater (if equipped), remove the anode plug and replace if more than 75%

deteriorated. This is to prevent further deterioration. Consult your Suburban water heater manual for more details.

5. Turn off LP-gas at tank valve.
6. Turn off refrigerator, furnace, all range and oven burner valves and-pilot.
7. Remove all perishables from refrigerator and galley cabinets. Leave refrigerator door open to reduce odor buildup. An open box or tray of baking soda in the refrigerator will help absorb odors.
8. Slightly open (1/4") a roof vent.
9. Close and lock all windows. Be sure vent fan and range hood fan switches are off.
10. Cap and close holding tank drain, city water inlet and fresh water fill spout.
11. Turn off all radios, TV's, interior and exterior lights.
12. Close curtains and /or mini blinds and pull shades.
13. Disconnect the 120-volt power cord and store in compartment.
14. If removing the camper from the truck, see procedure and warnings in the "Loading and Unloading Camper" section.
15. Check the camper weekly.

LONG-TERM STORAGE — Above Freezing

1. Perform all the preceding short-term storage steps.
2. Operate air conditioner periodically to lubricate compressor seals.
3. Remove and place the battery in a cool, dry area. Check battery charge every 30 days. Recharge as necessary.
4. Check sealants around all roof seams, body seams and windows. Reseal if necessary. See "Sealant Renewal" section.
5. Prepare generator (if equipped). (See generator Operating Manual included in the Owner's Information Package.
6. Remove the smoke detector's battery. Leave the cover open as a reminder to replace the battery.
7. Cover exterior vents; water heater, furnace, air conditioner shroud, range hood, refer, to prevent insects and small animals from getting in the camper. *Be sure to remove all covering materials before using appliances and vents.*

STORAGE BELOW FREEZING

To avoid damage to the plumbing fixtures and other components, we recommend that your camper plumbing systems be properly drained and have anti-freeze protection. The following is a procedure checklist you can follow if you prefer to winterize your camper yourself. Many owners prefer to have a Lance Dealer Service Center perform this service.

1. Perform all steps in the short and long term storage procedures.
2. Drain the fresh water tank by opening the water tank drain and leave open.
3. Turn the water pump ON and open all hot and cold water faucets. When the flow of water stops, turn the pump OFF. Open the low point drains on hot and cold water pipes, usually located under the shower.
4. Drain the water heater by opening the drain plug at the bottom of the heater and open the pressure relief valve.
5. Depress the toilet flush pedal or hand operated lever. Shut OFF all faucets, close the water line drain caps, fresh water tank drain valve, water heater drain and pressure relief valve.
6. Drain the showerhead and hose by disconnecting the hose at the faucet from the inside and outside shower. (if equipped)
7. Drain the waste water system by following the normal procedure for draining the holding tanks. See "Waste System" section.
8. Apply silicone lubricant to the knife valve actuator rod.
9. Be sure ALL water from ALL plumbing has been drained.

 Draining the water system alone will not provide adequate cold weather protection. If the camper is to be unheated during freezing temperatures, consult your dealer for the best winterizing procedure for your climate. Your dealer can supply you with one of the special non-toxic antifreezes that are safe and approved for use in RV water systems. Follow the instructions furnished with the antifreeze.

 Do not use automotive or windshield washer antifreeze in the camper water system. These could be harmful if swallowed.

WINTERIZING METHOD

(When not equipped with a winterize valve)

1. Before the water systems are completely filled with antifreeze, remove the water purifier cartridge (if equipped).
2. If your camper is equipped with a water heater bypass valve, turn valve to **bypass** position and drain tank by removing drain plug and opening safety relief valve.
3. Disconnect the pump inlet (suction side) hose from the water pump. Attach a 1/2" ID X 4' hose to the water pump that is used to draw non-toxic RV approved anti-freeze directly from the container. This method reduces the quantity required.
4. Turn water pump on.
5. Open hot water faucet farthest away from water tank. When antifreeze appears, let at least one cup run down the drain to winterize the P-trap. Repeat this at all other hot and cold water faucets including the shower.
6. Depress the flush pedal or hand operated lever on the toilet until the antifreeze solution flows continuously.
7. Install all protective caps:
 - Water tank fill
 - City water inlet
 - Waste tank drain outlet
8. Do not let antifreeze stand on plastic sinks or outside shower components to prevent stains.
9. Remove snow accumulation as often as possible.

WINTERIZING METHOD

(When Equipped With a Winterize Valve)

1. Make sure the water pump switch is off.
2. Insert the hose from the winterizing valve located under the galley sink into a container of RV approved non-toxic anti-freeze.
3. If your camper is equipped with a water heater bypass valve, turn water heater bypass valve to *Bypass* position and drain the water heater by removing drain plug and opening safety relief valve. Open faucets to relieve pressure. (Hot and Cold) Open the hot and cold low point drains.
4. Drain water tank by opening tank drain cock and leave open to drain completely.
5. After system is completely drained. Close all faucets and replace low point drain caps.
6. Turn winterize valve to "Winterize" position. The valve is located under the galley in all models.
7. Turn ON pump switch.

8. Open hot water faucet farthest from the water tank. When antifreeze appears, let at least one cup run down the drain to winterize the P-trap. Do the same to all other water outlets, hot and cold, including shower, toilet and outside shower if equipped.
9. Turn OFF pump switch.
10. Open a water faucet to relieve pressure, then close.
11. The procedure is complete.

WATER HEATER BYPASS (If equipped)

The water heater bypass valve is located behind the water heater and is used when winterizing the water system for storage. By rotating the lever to the bypass position, antifreeze will not enter the water heater requiring less antifreeze to protect the water system plumbing. Follow the instructions shown on the valve.

NOTE: Be sure to drain the water heater by opening the drain plug at the bottom of the heater and open the pressure relief valve.

To De-Winterize With Winterizing Valve:

1. First fill water tank.
2. Turn winterizing valve to normal flow position.
3. Turn water heater bypass valve to "bypass", this will (keep antifreeze from entering the water heater).
4. Turn ON water pump switch.
5. Open water faucet farthest from water tank, (catching antifreeze in a container for future use), until clear water appears. Shut off faucet. Do this to all other faucets and showerhead, including outside shower, if equipped.
6. Turn water heater bypass valve to normal flow position.
7. Open a hot water faucet until water appears.
8. Your system is now ready for use.

REACTIVATING CAMPER AFTER STORAGE

The following procedure checklist assumes that you stored the camper with care. If you didn't and extensive freeze damage or other serious deterioration may have occurred, please consult you Lance Dealer Service Center for advise.

OUTSIDE AREA

1. Thoroughly inspect the outside of the camper and open all doors and compartments. Check for animals or insect intrusion, water damage or other deterioration.
2. Remove all appliance vent, ceiling vent and air conditioner coverings. Be sure all furnace, water heater, and refrigerator openings are clear and free of debris or insect nests, webs, etc..
3. Open vents and windows.

12-VOLT SYSTEM

1. Prior to the battery installation, check charge level. Refill and recharge as necessary. Inspect cable ends and assure that terminals are clean and free of corrosion. Place battery into compartment, install tiedowns, and connect cables. Turn battery switch to "ON" if equipped). Check battery condition on monitor panel.
2. Be sure all 12-volt DC and 120-volt AC circuit breakers are ON.
3. Inspect and operate all 12-volt lights and accessories.

FRESH WATER SYSTEM

1. If fresh water system has been winterized, drain antifreeze from fresh water system.
2. Turn water pump on and open all faucets until flow of antifreeze stops.
3. Do not let antifreeze stand on plastic sinks or outside shower components or stains may occur.
4. Open water heater bypass valves if equipped.
5. Flush, and sanitize the fresh water system as outlined in the "Fresh Water System" section.
6. Install the water purifier cartridge (if equipped).
7. Operate all faucets and fixtures in the fresh water system. Check for leaks at all joints and fittings. Repair if necessary.

LP-GAS SYSTEM

1. Turn on LP valves and inspect all pipes and fittings in the LP system. Check for leaks as outlined in the "LP-Gas System" section.
2. Operate each LP-gas appliance. Observe all burners and pilot flames for proper color and size. If there are any problems, refer to an authorized Lance Dealer Service Center.

GENERAL

1. Install new 9-volt battery in smoke detector and remote control for electric jacks.
2. Check monitor panel operation.
3. Open and operate vents and vent fans.

120-VOLT SYSTEM

1. Inspect the 120-volt electrical system - power cord, converter, and outlets. If defects are found, refer service to a Lance Dealer Service Center.
2. Prepare the AC generator (if equipped) for operation following instructions in the generator operating manual in your Owner's Information Package.
3. Operate 120-volt AC appliances and air conditioner.

MAINTENANCE

1. Check the sealant around all roof, body seams, and windows. Reseal if necessary. See "Sealant Renewal" subsection of the "MAINTENANCE" section.
2. Lubricate all exterior locks, hinges and latches.
3. Wash and wax the exterior. Inspect the body for scratches or other damage. Touch-up or repair as necessary.

CAMPER LOADING AND CHECKOUT

1. Load the camper onto the truck (when ready) following the procedure in the "LOADING AND UNLOADING" section.
2. Check the operation of taillights, turn signals, backup lights, clearance lights, license plate lights, and emergency flashers.

Your camper should now be ready for a new traveling season. If you choose, your dealer can double check your preparation and correct any defects or make any necessary adjustments.

Happy Camping

SUPPLIERS SERVICE PHONE LISTING

| PRODUCT | SUPPLIER | PHONE | WEB SITE |
|--------------------------|--------------------------------|-------------------|-------------------------------|
| Lance Service | Lance Camper Manufacturing Co. | 661 949-3322 | www.lancecamper.com |
| Air Conditioner | Dometic Corporation | 800 544-4881 | www.dometic.com |
| Aluminum Roofing | Amerimax Building Products | 800 350-5209 | www.amerimax-inc.com |
| Awning | Carefree of Colorado | 800 621-2617 | www.carefreeofcolorado.com |
| Battery Separator | Sure Power Industries, Inc. | 503 692-9091 | www.surepower.com |
| Camper Cover | ADCO | 800 541-2326 | www.adcoprod.com |
| Carbon Monoxide Detector | M.T.I. | 800 383-0269 | www.safe-t-alert.com |
| Fire Extinguisher | BRK Electronics | 800 323-9005 | www.firstalert.com |
| Furnace | Atwood /Hydroflame | 800 825-4328 | www.atwoodmobile.com |
| Generator, Onan | Onan Corporation | 800 222-4871 | www.onancorp.com |
| Generator, Generac | Generac | 800 333-1322 | www.generac.com |
| | | East 219 293-6503 | |
| | | West 909 778-9312 | |
| | | NW 262 473-5514 | |
| Jacks | Atwood Mobile Products | 800 825-4328 | www.atwoodmobile.com |
| LP Detector | M.T.I. | 800 383-0269 | www.safe-t-alert.com |
| LP Tank | Manchester Tank Co. | 800 640-6327 | www.manchestertank.com |
| Mattress | Serta | 800 327-3782 | www.serta.com |
| Microwave | Samsung | 800 726-7864 | www.samsung.com |
| Monitor Panel | Kib Enterprises | 219 262-0518 | www.kibenterprises.com |
| Power Center (Converter) | Magnetek | 800 443-4859 | www.magnetek.com |
| Radio | JVC | 800 252-5722 | www.jvc.com |
| Range (w/oven) | Atwood Mobile Products | 800 825-4328 | www.atwoodmobile.com |
| Range Vent | Jensen | 800 647-7686 | www.philipsproducts.com |
| Refrigerator, Dometic | Dometic Corporation | 800 544-4881 | www.dometic.com |
| Refrigerator, Norcold | Norcold, Inc. | 800 543-1219 | www.norcold.com |
| Regulator - LP | Marshall Gas Controls | 800 877-2495 | www.mgc-mbc.com/Mgcpg1.htm |
| Roof Rack | Yakama | 888 925-4621 | www.yakama.com |
| Roof Vent/Escape | Elixir Corporation | 800 223-1555 | www.philipsproducts.com |
| Roof Vent | Fantastic Vent Co. | 800 521-0298 | www.fantasticvent.com |
| Slide-Out Mechanism | Happijac Company | 800 231-7440 | www.happijac.com |
| Smoke Alarm | M.T.I. | | www.safe-t-alert.com |
| Structurewood | Weyerhaeuser Co. | 800 321-0728 | www.weyerhaeuser.com/products |
| Thermostat, Atwood | Atwood Mobile Products | 800 825-4328 | www.atwoodmobile.com |
| Thermostat, Dometic | Dometic Corporation | 800 544-4881 | www.dometic.com |
| Toilet | Thetford Corporation | 800 521-3032 | www.thetford.com |
| TV Antenna/Sat Dish | Winegard | 319 754-0600 | www.winegard.com |
| Water Heater, Atwood | Atwood Mobile Products | 800 825-4328 | www.atwoodmobile.com |
| Water Heater, Suburban | Suburban | 423 775-2131 | www.suburbanmanufacturing.com |
| Water Pump | Shurflo | 800 854-3218 | www.shurflo.com |
| Windows (Lance) | Hehr International | 323 663-1261 | |
| Windows (Lance Lite) | Kinro Products | 909 681-4236 | www.kinro.com |
| Winterizing System | Swan Industries Inc. | 541 389-4668 | www.swanindustries.com |

This phone listing is provided to assist you in case of emergencies, if you are stranded somewhere not close to a Lance service center or qualified RV repair facility.

Due to continual product development, some suppliers, phone numbers and web sites may change from those shown.

Lance

America's Favorite Truck Camper

Lance Camper Manufacturing Corporation

43120 Venture Street, Lancaster, California 93535 • 661-949-3322 • www.lancecampers.com