

Lance Truck Camper

Owner's Manual

 **WARNING**

This User's Manual contains safety information and instructions for your camper.

You must read this manual before loading or towing your camper.

You must follow all safety precautions and instructions.

This page intentionally blank.

TABLE OF CONTENTS

LIMITED WARRANTY	6
COVERAGE PROVIDED.....	6
OWNER'S OBLIGATION	6
EXCLUSIONS.....	6
IDENTIFICATION INFORMATION	8
A FEW IMPORTANT WORDS ON SAFETY	9
WELCOME	11
CUSTOMER RELATIONS INFORMATION	12
INFORMATION ABOUT THIS MANUAL	13
PRODUCT CHANGES	13
OWNER'S INFORMATION PACKAGE	13
DEALER RESPONSIBILITY	14
PLANNING AND PREPARATION	14
INSPECTION AND MAINTENANCE	14
REPORTING SAFETY DEFECTS	15
CAMPER AND TRUCK	17
MATCHING TRUCK AND CAMPER.....	17
TIRES	18
ELECTRICAL CONNECTION TO TRUCK.....	19
TRUCK/CAMPER LOAD WORKSHEET	20
SUPPORT EQUIPMENT	23
AIR BAGS.....	23
HEAVY DUTY SHOCKS	23
TIEDOWNS AND TURNBUCKLES.....	23
CABOVER TRUCK STRUTS	24
HITCHING AND TOWING SYSTEMS	24
LOADING AND UNLOADING	25
ELECTRIC CAMPER JACKS.....	25
LOADING/REMOVING CAMPER	27
LOADING CAMPER ON TO TRUCK	28
REMOVING CAMPER FROM TRUCK.....	28
LEVELING/STABILIZING CAMPER.....	28
ON THE ROAD	29
LOADING.....	29
STORAGE	29
PREPARING FOR TRAVEL.....	29
PRE-TRIP CHECKS.....	29
POST-TRIP CLEAN-UP.....	29
SAFE DRIVING RULES	29
RIDING IN CAMPER WHILE TRAVELING.....	30
CAMPGROUND REGULATIONS	30
CARBON MONOXIDE GAS	30

EFFECTS OF PROLONGED OCCUPANCY	31
VENTILATION AND MOISTURE CONTROL	31
DRIPPING CEILING VENTS.....	32
INTERIOR ODOR	32
FIRE AND SAFETY	33
FIRE EXTINGUISHER	33
SMOKE DETECTOR	33
CARBON MONOXIDE AND PROPANE LEAK DETECTOR.....	34
EQUIPMENT	37
ROOF	37
COMPARTMENT DOORS	37
VENTS.....	38
ROOF VENTS.....	38
FANTASTIC ROOF VENT.....	38
HEKI MIDI SKYLIGHT.....	39
CABOVER VENT	39
EXTERIOR LIGHTING	39
ROOF RAILS AND LADDER.....	40
ROOF RACK SYSTEM	40
ENTRY DOOR	40
WINDOWS.....	41
EMERGENCY EXIT WINDOW.....	41
AWNINGS.....	41
SLIDEOUT COVER.....	41
EXTERIOR WASH STATION	42
CAMPER BUMPER/STEP	42
BACKUP CAMERA	42
INTERIOR STORAGE.....	43
BATHROOM	43
TOILET	43
CABOVER AREA.....	43
GALLEY	43
DINETTE CUSHIONS.....	43
DINETTE CONVERSION (DREAM TABLE).....	43
DINETTE CONVERSION (PEDESTAL TABLE)	44
DAY/NIGHT SHADES	44
MINI-BLINDS.....	44
FOLDING DIVIDER DOOR.....	44
FOLD-DOWN BUNK AND CHILD RESTRAINT.....	44
ELECTRICAL SYSTEMS	45
12-VOLT DC SYSTEM	45
BATTERY AND COMPARTMENT.....	45
BATTERY TERMINOLOGY.....	45
BATTERY INFORMATION	45
BATTERY STORAGE PRECAUTIONS	46
BATTERY CHARGING.....	46
BATTERY SEPARATOR.....	46
BATTERY DISCONNECT SWITCH	47
SYSTEMS MONITOR PANEL.....	47
WATER HEATER IGNITION SWITCH.....	47
EXTERIOR LIGHT FUSE BOX.....	47
CAMPER FUSE PANEL.....	48
FUSES.....	48
INTERIOR LIGHTING	48
SOLAR PANEL PRE-WIRE	48
SOLAR PANEL	48

DOCKING LIGHTS	49	WASTE SYSTEM	69
PARK/SAT DISH CABLE INLETS	49	INSULATED AND HEATED WASTE HOLDING	
ROOF MOUNTED HDTV ANTENNA.....	49	TANKS	69
TV ANT/SAT DISH COMBO	50	FRESH WATER FLUSH TOILET.....	69
SATELLITE DISH SELF-POSITIONING.....	50	BLACK WATER HOLDING TANK.....	69
LCD TV	50	DUMPING THE HOLDING TANKS.....	69
EXTERIOR SPEAKERS	50	HOLDING TANK CARE/MAINTENANCE	70
120-VOLT AC SYSTEM.....	51	BLACK TANK FLUSH	70
120-VOLT POWER CORD	51		
120-VOLT GENERATOR POWER.....	51	SLIDE-OUT ROOM SYSTEM (Rack and Pinion)	71
POWER DISTRIBUTION CENTER.....	52	SYSTEM OPERATION.....	71
GROUND FAULT CIRCUIT INTERRUPTER	52	NORMAL OPERATION.....	71
GENERATOR READY.....	52	MANUAL OVERRIDE OPERATION	72
POWER GENERATOR	53	ELECTRICAL SYSTEM MAINTENANCE.....	72
GENERATOR OPERATING SAFETY		MECHANICAL MAINTENANCE	72
PRECAUTIONS AND WARNINGS.....	53	SYSTEM TROUBLESHOOTING	72
GENERATOR MAINTENANCE AND SERVICE.....	54	ELECTRICAL TROUBLESHOOTING	72
GENERATOR/ELECTRICAL COMPONENT			
INCOMPATIBILITY	54	SLIDE-OUT ROOM SYSTEM (In Wall)	73
LOADING THE GENERATOR.....	54	SYSTEM OPERATION.....	73
TYPICAL APPLIANCE LOADS.....	54	NORMAL OPERATION.....	73
POWER VS. ALTITUDE	54	MANUAL OVERRIDE OPERATION	74
		ELECTRICAL SYSTEM MAINTENANCE.....	74
PROPANE GAS SYSTEM	55	MECHANICAL MAINTENANCE	74
BTU'S	55	SYSTEM TROUBLESHOOTING	74
SAFETY PRECAUTIONS.....	55	ELECTRICAL TROUBLESHOOTING	74
FILLING PROPANE TANK.....	56		
USING PROPANE SYSTEM.....	56	GENERAL MAINTENANCE	75
SINGLE PROPANE TANKS.....	56	EXTERIOR MAINTENANCE	75
DUAL PROPANE TANKS.....	56	EXTERIOR GRAPHICS.....	75
PROPANE AT LOW TEMPERATURES.....	57	DAMAGE CHECKS	76
COMBINATION CARBON MONOXIDE		SEALANT RENEWAL	76
AND PROPANE LEAK DETECTOR	57	DOORS AND WINDOWS	76
EXTERIOR PROPANE CONNECTION	57	ACRYLIC WINDOWS/HEKI SKYLIGHT VENT.....	76
PROPANE GAS FUEL SYSTEM.....	58	JACK BRACKETS.....	77
		CAMPER JACKS	77
APPLIANCES	61	TURNBUCKLES	77
LIGHTING PROPANE APPLIANCES.....	61	AIR CONDITIONER.....	77
REFRIGERATOR	61	OVERHEAD VENTS	77
RANGE-OVEN.....	61	SKYLIGHTS.....	77
CONVECTION OR MICROWAVE OVEN.....	62	EXTERIOR LIGHTS	77
AUTOMATIC IGNITION WATER HEATER		WIRING.....	77
W/120V HEATING ELEMENT	62	BATTERY(S).....	77
FORCED AIR FURNACE.....	62	INTERIOR MAINTENANCE	77
ROOF MOUNTED AIR CONDITIONER.....	63	INTERIOR ODOR	77
COMBINATION FURNACE/AIR CONDITIONER		UPHOLSTERY AND DRAPES	78
THERMOSTAT	63	WALL AND CEILING PANELS.....	78
		FLOORS AND CARPETING	78
FRESH WATER SYSTEM	65	WOOD PRODUCT CARE	78
WATER PUMP	65	FIBERGLASS TOP CARE.....	78
WATER TANK FILL.....	65	POWER RANGE HOOD	78
CITY WATER CONNECTION	66	REFRIGERATOR	78
WATER SYSTEM DRAIN.....	66	DRAINS	78
SANITIZING FRESH WATER SYSTEM	66	SHOWER CARE.....	78
WATER FILTER.....	67	SINK CARE.....	78
SHOWER.....	67	MAINTENANCE CHART.....	79
EXTERIOR WASH STATION	67		

WINTERIZATION	81
OPERATING IN FREEZING CONDITIONS	81
STORAGE	81
SHORT-TERM STORAGE.....	81
LONG-TERM STORAGE	81
STORAGE BELOW FREEZING	81
WINTERIZING METHOD.....	82
WATER HEATER BYPASS.....	82
REACTIVATING CAMPER AFTER STORAGE.....	82
TYPICAL BULBS AND FUSES	83

EXTERIOR SEALANT CHART	84
-------------------------------------	----

SCHEMATICS

TYPICAL FRESH WATER SYSTEM.....	85
TYPICAL DRAIN PLUMBING.....	86
TYPICAL PROPANE SYSTEM.....	87
RUNNING LIGHT WIRING	88
DOCKING LIGHT WIRING	89
ELECTRICAL JACK WIRING.....	90
MONITOR PANEL WIRING	91
SLIDE-OUT CIRCUIT WIRING (RACK & PINION).....	92
SLIDE-OUT CIRCUIT WIRING (IN WALL)	93
TYPICAL 12V SYSTEM.....	94
TYPICAL 12V INTERIOR CIRCUIT WIRING	95
STEREO SPEAKER WIRING.....	96
SOLAR PANEL WIRING	97
ATWOOD THERMOSTAT WIRING.....	98
RVP COLEMAN THERMOSTAT WIRING	99
TYPICAL 120V SYSTEM.....	100
TV PREWIRE	101
TV ANTENNA	102
TV/SAT ANTENNA.....	103
SAT DISH ANTENNA	104

SUPPLIERS SERVICE PHONE

AND INTERNET LISTING	106
-----------------------------------	-----

LIMITED WARRANTY

FOR TRUCK CAMPERS MANUFACTURED BY LANCE CAMPER MANUFACTURING CORPORATION ("LANCE CAMPER") SOLD IN THE UNITED STATES AND CANADA

Lance warrants to the original end user purchaser ("Owner") of this Truck Camper ("Camper") to be free of defects in materials and workmanship and for structural integrity, under normal use, with reasonable care and maintenance, for one (1) year from the date of purchase (the "Warranty Period"), subject to the exclusions given below.

COVERAGE PROVIDED

Within the Warranty Period, Lance is obligated to repair or replace any part covered by this warranty proven defective. In the event of such an occurrence, the Owner should contact the selling dealer for a service appointment. If it is not possible to return to the selling dealer, call the Lance Factory Service Department, and they will provide you with the location of the nearest authorized dealer or repair facility. The cost of transporting the Camper to the dealer or service center shall be incurred and paid for by the Owner.

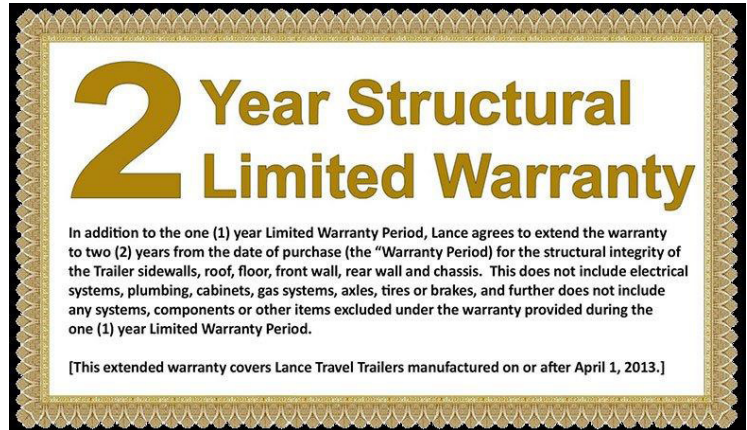

This is the only warranty given with the purchase of the Camper other than express or implied warranties given by the component manufacturers. Any warranties implied by law are limited to the Warranty Period. Any other warranty, express or implied, not provided for in this Limited Warranty is waived by the Owner, to the extent allowed by law.

OWNER'S OBLIGATION

The purchaser must notify Lance or a Lance authorized dealer of any defect promptly upon discovery.

Warranty repairs by a non Lance dealer or service center must be approved by the Lance Factory Service Department prior to any work being started.

EXCLUSIONS

The scope of this warranty is expressly limited to only items actually constructed by Lance. Lance therefore makes no warranty with respect to component parts constructed or assembled by other manufacturers, including, but not limited to, all electrical devices (TV, sound systems, DVD player, antennas, batteries, etc.), the propane appliances, electrical appliances, heaters, refrigerators, plumbing fixtures, light fixtures, lights, entrance door and windows. Such component parts may be warranted by their respective manufacturers, and copies of such warranties are included with the Camper.

This warranty does not cover damage caused by or related to (1) normal wear and tear, (2) accidents, abuse, misuse or negligence, (3) failure to comply with instructions contained in the Owner's Manual, (4) any alteration or modification of the Camper, or (5) environmental conditions, including, but not limited to, road salt, hail, or windstorm. Nor does this warranty apply to parts made out of cloth, leather, wood, paint, or chrome, which have been affected by airborne fallout, including, but not limited to, chemicals and tree sap.

No payment or other compensation will be made for incidental expenses, including, but not limited to, towing, telephone, transportation, lodging, travel, gasoline, loss of pay or indirect or consequential damage including, but not limited to, loss of use of the Camper, inconvenience, damage or injury to person or property, or loss of revenue, which might be paid, incurred or sustained by reason of manufacturer's defect covered by this warranty. Lance does not warranty equipment or accessories installed at any dealership or other place of business, or by any other party.

As the manufacturer of the Camper that you purchased, Lance does not know the purpose you have in mind for your truck and camper, nor does Lance know the Gross Vehicle Weight Rating ("GVWR") of your truck. Therefore, Lance makes no warranties or representations, express or implied, as to the performance of your truck with the Camper or whether the match up of your truck and Camper exceeds the GVWR as specified by your truck's

manufacturer. Specifically, there is no express or implied warranty of merchantability or of fitness for the particular match of your truck to any particular Camper.

This Limited Warranty is intended to comply with the requirements of both State and Federal laws. Any part of this Limited Warranty in conflict with any law shall be ineffective to the extent of any such conflict. This warranty gives you specific legal rights, and you may also have other rights, which may vary from state to state.

IDENTIFICATION INFORMATION

For identification purposes it is recommended that you write the camper serial number inside your camper. Pick a spot behind a drawer or inside a cabinet. Protect yourself from possible theft and be able to identify your property. **You should keep a copy of this information at home.** If the unit is ever stolen, the police can use the appliance serial number to identify the unit. It is also handy to have when service is needed.

PLEASE TAKE A FEW MINUTES TO COMPLETE THE INFORMATION. IT WILL BE A HANDY REFERENCE FOR YOU.

Your Name _____

Camper Model _____

Camper Serial Number _____

Purchase Date _____

Dealer Name _____

Entry Door Key Number _____

Address _____

Insurance Policy Number _____

Agent's Name _____

Agent's Phone Number _____

Air Conditioner

Manufacturer _____

Model _____

Serial Number _____

Range/Oven

Manufacturer Dometic

Model _____

Serial Number _____

Furnace

Manufacturer Dometic

Model _____

Serial Number _____

Refrigerator

Manufacturer Norcold

Model _____

Serial Number _____

Generator

Manufacturer Onan

Model 2.5 KVD-5242b

Serial Number _____

Stereo/DVD

Manufacturer _____

Model _____

Serial Number _____

Convection or Microwave Oven

Manufacturer _____

Model _____

Serial Number _____

Water Heater

Manufacturer _____

Model _____

Serial Number _____

A FEW IMPORTANT WORDS ON SAFETY

Your safety, and the safety of others, is very important. Operating your truck and camper is an important responsibility.

As you read this manual, statements preceded by the following words are of special significance:

WARNING

Indicates a potentially hazardous situation which, if not avoided, may result in death or serious injury.

CAUTION

Indicates a potentially hazardous situation which, if not avoided, may result in damage to the component, camper or your truck.

This information is intended to help you reduce the risk of personal injury and prevent possible damage to others, your truck, camper and its equipment, or the environment.

To help you make informed decisions about safety, we have provided operating procedures and other information on labels in your camper and in this manual. There are also warnings in the appliance manuals in the Owner's Information Package. This information alerts you to potential hazards that could hurt you or others.

Of course, it is not practical or possible to warn you about all the hazards associated with operating or maintaining your camper. You must use your own good judgment.

This manual is filled with important safety information - please read it carefully. If you have any questions regarding operation, maintenance, or service, please contact your dealer immediately so he can assist you.

Lance Camper Manufacturing is required to furnish the following consumer information as provided by the National Fire Protection Association and the American National Standards Institute. The information and warnings found here might also be found in other chapters of this Owner's Manual. Please see chapters titled "PROPANE SYSTEM" and "APPLIANCES" for other safety and operating information.

WARNING

Propane containers must not be placed or stored inside the vehicle. Propane containers are equipped with safety devices, which relieve excessive pressure by discharging gas to the atmosphere.

The following label has been located in the cooking area to remind you to provide an adequate supply of fresh air for combustion.

WARNING

IT IS NOT SAFE TO USE COOKING APPLIANCES FOR COMFORT HEATING. Cooking Appliances need fresh air for safe operation.
BEFORE OPERATION:
Open overhead vent or turn on exhaust fan.
Open window.
FAILURE TO COMPLY COULD RESULT IN DEATH OR SERIOUS INJURY.

Unlike homes, the amount of oxygen supply is limited due to the size of the recreational vehicle, and proper ventilation when using cooking appliances will avoid dangers of asphyxiation. It is especially important that cooking appliances not be used for comfort heating as the danger of asphyxiation is greater when the appliance is used for long periods of time.

WARNING

Portable fuel-burning equipment, including wood and charcoal grills and stoves shall not be used inside the recreational vehicle. The use of this equipment inside the recreational vehicle may cause fires or asphyxiation.

WARNING

Do not bring or store propane containers, gasoline, or other flammable liquids inside the camper. Fire or explosion may be the result.

The following label has been placed near the front on both exterior right and left walls of your camper:

DANGER

ALL PILOT LIGHTS, APPLIANCES AND THEIR IGNITORS (SEE OPERATING INSTRUCTIONS) SHALL BE TURNED OFF BEFORE REFUELING OF MOTOR FUEL TANKS AND/OR PROPANE CONTAINERS. FAILURE TO COMPLY COULD RESULT IN DEATH OR SERIOUS INJURY.

A warning label has been located near the propane container. This label reads:

⚠ WARNING
DO NOT FILL PROPANE CONTAINERS) TO MORE THAN 80 PERCENT OF CAPACITY. FAILURE TO COMPLY COULD RESULT IN A FIRE OR PERSONAL INJURY.

⚠ CAUTION
THIS PROPANE PIPING SYSTEM IS DESIGNED FOR USE WITH PROPANE ONLY. DO NOT CONNECT NATURAL GAS TO THIS SYSTEM.

Securely cap inlet when not connected for use. After turning on gas, except after normal cylinder replacement, test propane piping and connections to appliance for leakage with soapy water or bubble solution. Do not use products that contain ammonia or chlorine.

Overfilling the propane container can result in uncontrolled gas flow, which can cause fire or explosion. A properly filled container will contain approximately 80 percent of its volume as liquid propane.

Overfilled Propane tanks must be bled. This is different than purging the tanks. When the tanks are new, they must be purged of the oxygen in the tanks used during the tank manufacturer's testing procedure prior to being filled with propane. Overfilled tanks will emit liquid into the propane system, which can cause problems/plugging with the regulators used on the tanks, range and generator. A bathroom scale can be used to weigh the tanks prior to re-installing them in the camper. A 5-gallon tank should not weigh more than 35 lbs. when filled. A 7-gallon tank should not weigh more than 50 lbs. when filled. Instructions for bleeding the tanks are located on a label on the tank.

The following label has been placed in the vehicle near the range area:

⚠ DANGER
IF YOU SMELL PROPANE:

1. Extinguish any open flames, pilot lights and all smoking materials.
2. Do not touch electrical switches.
3. Shut off the propane supply at the container valve(s) or gas supply connection.
4. Open doors and other ventilating openings.
5. Leave the area until odor clears.
6. Have the gas system checked and leakage source corrected before using again.

FAILURE TO COMPLY COULD RESULT IN EXPLOSION RESULTING IN DEATH OR SERIOUS INJURY.

Propane regulators must always be installed with the regulator vent facing downward. Make sure the regulator vent faces downward to minimize vent blockage, which could result in excessive gas pressure causing fire or explosion.

CARBON MONOXIDE HAZARD

Your truck and your camper's generator exhaust contain carbon monoxide gas. You should have no problem with carbon monoxide entering into the camper if you maintain your truck and generator properly. Have the exhaust system inspected for leaks whenever:

- The truck and camper is serviced.
- You notice a change in the sound of the exhaust.
- The truck or camper was in an accident that may have damaged the underside.

⚠ WARNING
Carbon monoxide is toxic. Breathing it can cause unconsciousness and even kill you. Avoid any enclosed areas or activities that expose you to carbon monoxide.

High levels of carbon monoxide can collect rapidly in enclosed areas, such as a garage or family room.

WELCOME

Congratulations and welcome to the recreational vehicle lifestyle and the ever-growing family of Lance Truck Camper owners. We sincerely thank you for choosing Lance, "American's Favorite Truck Camper". Your selection of a Lance was a wise investment. Lance Camper is confident that it will give you years of camping pleasure.

At Lance Camper, we work hard to provide our customers with safe and dependable truck campers. We constantly strive to produce a quality product to meet your needs. Our customers are what are most important. If you are satisfied, then we know we have achieved what we set out to do. That is to be the best truck camper manufacturer in the industry.

Your camper has been designed to conform with, or exceed, the American National Standards Institute (ANSI) 1192, National Fire Protection Association (NFPA) 1192, Canadian Standards Association (CSA) Z-240 (for Canadian built units), National Electric Code (NEC), and applicable motor vehicle standards. These standards establish the requirements for electrical, plumbing, fuel systems and equipment, fire and life safety provisions and other requirements for quality and safety. Lance Camper is a member of the Recreational Vehicle Industry Association (RVIA) and the Canadian Recreational Vehicle Industry Association (CRVIA) which oversees that our products are in compliance with the above agencies and organizations.

One of the best ways to enhance the enjoyment of your new Lance camper is to read this manual along with the information provided in the Owner's Information Package. This information will help you learn how to operate all the features of your new camper. Afterwards, keep this Owner's Manual along with the Owner's Information Package in your camper so you can refer to it at any time.

This Owner's Manual covers all Lance models. You may find descriptions of equipment and features that are not on your particular model.

This Owner's Manual, along with the Owners Information Package should be considered a permanent part of the camper, and should remain with the camper when it is sold.

The information, specifications and photography included in this publication were as accurate as possible at the time of publication. For the most current product information and changes, please visit our website at www.lancecamper.com or contact your local Lance dealer. Lance Camper Manufacturing Corporation reserves the right, however, to discontinue or change specifications at any time without notice and without incurring any obligation whatsoever. All weights, fuel, liquid capacities, and dimensions are approximate.

Before calling your Lance dealer or the Lance Camper Customer Service Department, we suggest that you look for the answer to your problem in the Owner's Manual, Owner's Video or the Component Instruction Manuals supplied in the Owner's Information Package.

Several warranties protect your new Lance camper. Read each of the warranties thoroughly so you understand the coverages and are aware of your rights and responsibilities. Lance provides a limited warranty as defined at the front of this manual. Please read that warranty carefully. If you have any questions about the warranty or what it does or does not cover, please contact your Lance dealer. At the time of sale, your dealer will fill out and mail your Lance Warranty Registration Card to the factory. Within three weeks you should receive, by mail, your Owner Registration Card. Contact your dealer if it does not arrive. The card will have your name, serial number and model, date of purchase and dealer name. If your camper ever needs warranty service, present this card to your dealer.

Your appliances and various other components in your camper are warranted by their respective manufacturer and their warranties are included in the Owner's Information Package. Be sure to fill out the warranty registration cards for these items and mail them as soon as possible after taking delivery of your camper.

CUSTOMER RELATIONS INFORMATION

It is best to return your camper to the selling dealer for warranty service. If this is not possible, you can find the nearest dealer on our web site, www.lancecamper.com, under the dealer locator heading, or by contacting the Lance Customer Service Department at 661 949-3322, who can direct you to a dealer in your area.

Service and maintenance on your camper is easily accomplished by establishing a mutually agreeable partnership between you and your Lance dealership. Take the time to get to know the people who will play an important role in helping you keep your camper in prime working condition. Visit the dealer's service center to meet the service manager, technicians, service writers, and those charged with ordering the parts. Ask questions.

Following scheduled maintenance recommendations will save you money in the long run. Carefully read all operation manuals to obtain complete information on prescribed service intervals. Don't forget about your truck. It too needs regular service.

If you prefer to perform general maintenance items on your own, your Lance dealer service department can be a big help when it comes to making sure you obtain the proper replacement parts. All replacement parts must be ordered from your dealership. Lance Camper Mfg. Corp. does not sell retail to the public.

Service and maintenance items may fall outside the scope of your capability. In these instances you may decide to seek the assistance of a qualified RV service center to perform these tasks. Contact your Lance dealership's service center in advance for a scheduled appointment time. Advise the service manager, in writing, the specific items needing repair to give the service center an idea of what parts will be required, and how long the work can be expected to take. Keep in mind that seasonal maintenance needs are a popular time of year at most service centers. Call early to schedule annual tune-ups. Always include your vehicle identification number when contacting your Lance dealer.

Lance Camper dealership personnel are trained professionals. They should be able to answer all your questions. If you encounter a problem that your dealership does not solve to your satisfaction, please discuss it with the dealership's management. The Service Manager or General Manager can help. Almost all problems are solved in this way.

If you are dissatisfied with the decision made by the dealership's management, contact the Lance Camper Customer Service Center at:

Service Manager
Lance Camper Manufacturing Corporation
43120 Venture Street
Lancaster, California 93535-4510 USA
661 949-3322

E-mail inquiries to service@lancecamper.com.

When you call or write, please give us this information:

Vehicle Identification Number
Your name, address, and telephone number
Date of purchase
Name and address of the dealer where your camper was purchased, or who services your camper

This information will be on your Owner Registration Card. The serial number is also located on the identification tag located next to the entry door.

Lance		Owner Registration
Serial No.	Model	Purchase Date
123456	1130	2/1/2000
Jack & Evelyn Smith		
.....		
XYZ Camper Sales Anytown US (555) 555-5555		

INFORMATION ABOUT THIS MANUAL

This Owner's Manual is of a general nature only and does not cover every aspect of all models manufactured by the Lance Camper Mfg. Corp. Each owner should read this manual thoroughly and heed the warnings given herein, as well as those warnings given in the component instruction manuals contained in the Owner's Information Package.

PRODUCT CHANGES

Lance Camper manufactures multiple product levels of truck campers. Some equipment and features shown in this manual may be optional or not available on some models. Photographs or illustrations in this manual are representative of function and may not be specific in their depiction of actual equipment, fabrics, interior or exterior decor or design options as installed on or in your camper. For the most current product information and changes please visit our website at www.lancecamper.com or contact your local Lance Dealer. Subsequent modifications may be evident in the actual product. Specifications are subject to change without notice. All weights, fuel, liquid capacities and dimensions are approximate.

OWNER'S INFORMATION PACKAGE

The owner information package contains valuable documents explaining details of operation for major appliances, systems and equipment built into your camper. Included in this package is warranty information on various appliances and components in your camper. Warranty registration cards for these items should be filled out and mailed as soon as possible after you take delivery of your camper. Since this Owner's Manual does not cover every possible detail of equipment and options installed on or in your camper, these booklets and instructional material in the package will help you operate, maintain and trouble-shoot those items. If you are missing any of the component material, contact your Lance Dealer and request the desired or missing information.

This information should be considered a permanent part of the camper, and should remain with the camper when it is sold.



The Owner's Information Package includes the following items based on the standard features and applicable options on your particular camper:

- Owner's Manual
- Consumer Information - Truck Camper Loading
- Refrigerator Manual
- Range/Oven Manual
- Microwave Manual
- Furnace Manual
- Thermostat Manual
- Water Heater Manual
- Air Conditioner Manual
- Generator Manual
- Electric Jack and Remote Manuals
- Electric Jack Remote Quick Reference Guide
- Slide-Out Syncro Controller Location Reference
- Solar On The Side Reference
- Fiberglass Siding Reference
- Slow-Rise Window Shade Manual
- Water Pump Manual
- Converter Manual
- Battery Charging Relay Manual
- Smoke, Propane and Carbon Monoxide Detector Manuals
- Awning Manual
- Stereo Manual
- LCD TV Manual
- Keyless Entry Door Lock Instructions
- Key Chain

DEALER RESPONSIBILITY

Your camper has been thoroughly inspected at the factory before shipment. However, your dealer is responsible for performing a complete pre-delivery inspection of all your camper's components. This should assure you that all components are in proper working order and free of defects prior to you taking delivery.

During the delivery process, the dealer should have taken you through the inside, as well as around the exterior of the camper, to instruct and explain the proper usage of all of the following items:

Appliances
Dinette Bed Conversions
Electrical System
Fresh Water System
Propane Gas System
Loading and Unloading
Optional Equipment
RV Park Hookup
Waste System
Slide-Out System
Egress Exits

While the dealer has provided basic instructions on how to use your camper, it is ultimately your responsibility to make sure you fully understand how to use the camper prior to doing so. To fulfill this responsibility, in addition to the instructions received from the dealer, you must read all instructional material furnished with the camper. If you do not understand how to operate any appliance or equipment, you should return to your dealer for further instructions.

Your Lance camper comes with applicable loose items based on the standard features and options on your particular camper. Please make sure that you have each of these items:

- Owner's Information Package
- Two sets of keys for entry door, exterior access doors and slideout remote control
- 12 volt Molded Camper Connector (to be installed on your truck by the dealer)
- Fire Extinguisher (mounted)
- Electric or Manual Jack Handle
- Slide-out Crank Handle
- Entry Step with pins (if equipped)
- Solar Pigtail Plug
- Remote for Electric Power Jacks
- Remote for TV/LCD & DVD (LCD/TV option)
- Mattress Cover(s) (if equipped)

- Insulated Covers (if equipped) for single Pane Roof Vents
- Propane Quick Disconnect Fitting for Low Pressure Hookup (if equipped)

PLANNING AND PREPARATION

Proper planning of your trip will ensure a pleasurable experience. A thorough knowledge of your RV is important if you are going to get the most of the convenience and safety built into your camper. You should become as familiar with your camper as you are with your own personal car or truck. If you have trouble or questions, you should consult your dealer.

INSPECTION AND MAINTENANCE

Maintaining your camper according to the maintenance schedules given in this manual helps to keep your camping experiences trouble-free while preserving your investment. When your camper needs maintenance, keep in mind that your Lance Dealer's staff is trained in servicing the many systems in your camper. Your Lance Dealer is dedicated to your satisfaction and will be pleased to answer any questions and concerns. The Maintenance Chart located at the rear of this manual defines the minimum maintenance intervals. Adherence to this schedule will minimize the possibility of failure of important systems of your camper. The time spent inspecting and maintaining your camper will provide you with many years of trouble free recreational pleasure.

ALTERING OR MODIFYING YOUR CAMPER MAY VOID YOUR WARRANTY

Even doing something as simple as hanging a picture; a drill, screw or nail could penetrate an unseen gas line or electrical circuit, which would be hazardous. If you are not sure, call your Lance dealer for help! Also, alterations or modifications to your camper may void your warranty.

Areas between the camper and truck bed are used for ventilation. Filling or blocking these areas could trap and prevent gases from escaping.

REPORTING SAFETY DEFECTS

If you believe that your camper has a defect which could cause a crash or could cause injury or death, you should immediately inform the National Highway Traffic Safety Administration (NHTSA) in addition to notifying Lance Camper Manufacturing Corporation.

If NHTSA receives similar complaints, it may open an investigation, and if it finds that a safety defect exists, it may order a recall and remedy campaign. However, NHTSA cannot become involved in individual problems between you, your dealer, or Lance Camper Manufacturing Corporation.

To contact NHTSA, you may either call the Auto Safety Hotline toll-free at 1-888-327-4236, or write to: NHTSA, 1200 New Jersey Ave., S.E., Washington, D.C. 20590. You can also obtain other information about motor vehicle safety from the Hotline. They are on the web at www.safercar.gov.

This page intentionally blank.

CAMPER AND TRUCK

MATCHING CAMPER AND TRUCK

Selecting the right combination requires understanding a few guidelines. Your Lance Dealer can be a valuable source of information when matching a camper to your truck.

The truck bed is mounted to the frame of the truck with mounts that allow for some movement. It is important to allow enough clearance between your truck and camper to prevent damage due to normal racking, twisting and bouncing during driving conditions. The cabover of the camper should never be closer than 1 1/2" to the tallest point of the cab of the truck. This could be cab marker lights or tracking system antennas, if installed. Also, ensure that there is a minimum of 1/4" clearance between the truck bed side rails and the camper wing.

It may be necessary to place a bed mat in the truck bed to raise the camper to gain the minimum clearance requirements. There must also be a minimum of 1/2" between where the truck and camper meet at the back of the truck taillight. Adding a spacer at the front of the camper or in the front of the truck bed can insure proper clearance. Refer to your Lance Dealer for proper installation.

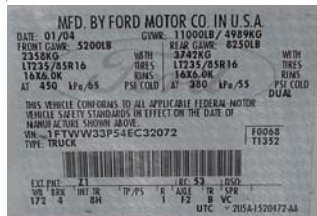

A Federal Certification Label is required by law on all trucks. It is usually located on the driver side door post. It lists the Gross Vehicle Weight Rating (GVWR), the maximum weight at which the vehicle may be operated. It also provides a Gross Axle Weight Rating (GAWR), the maximum weight allowed for each axle. The GAWR, divided by two, is the maximum axle rating for each end of an axle.

Campers are considered "truck payload." New trucks have their payload capacity posted in the glove box or on a specification sheet supplied with the truck owner's manual. Trucks that have many options and/or a 4-wheel drive option have less payload. To calculate payload, the truck manufacturers assume all seat positions are filled with persons weighing 150 pounds each.

One way to determine the actual payload available is to weigh the truck full of fuel and with the number of passengers you will normally be carrying and subtract that weight from the GVWR.

MODEL: 8555 SERIAL: 169106 DEALER: Highway Trailer Sales, Inc.
 THIS TRUCK CAMPER WAS MANUFACTURED BY: LANCE CAMPER MFG. CORP.
 See Camper Certification Label (located on the camper's rear exterior) for month and year of manufacture and for the Vehicle Identification Number.
CONSUMER INFORMATION: TRUCK CAMPER LOADING
 This information is furnished in accordance with the Consumer Information Regulations of the National Highway Traffic Safety Administration. It includes cargo weight data and longitudinal center of gravity location for your camper. This camper conforms to applicable Federal Motor Vehicles Safety Standards in effect on date of manufacture.
CAMPER WEIGHT INFORMATION
CAMPER WEIGHT IS 1340 KGS (2955 LBS) MAXIMUM WHEN IT CONTAINS STANDARD EQUIPMENT, 137 LITERS (36 GAL) OF WATER, 18 KGS (40 LBS) OF PROPANE, AND 0.14 CUBIC METERS (5 CUBIC FT) REFRIGERATOR.
 Check optional equipment listed below for additional weights.
OPTIONAL EQUIPMENT WEIGHTS
 Below is a list of additional or optional equipment this camper is designed to carry and the weight of each item if the installed weight exceeds 20 lbs. Add the weight of options equipped on your unit to the weight listed above to determine the approximate gross weight of your new Lance Camper.
CAMPER WEIGHT IS 1340 KGS (2955 LBS)

Option	Kgs	Lbs	Factory Installed
A/C Coleman 11 High Eff. Wall Control	44	98	No
A/C Coleman 8 Low-Pro Ceiling Control	44	98	No
Aerating Rear Door	21	46	Yes
Batteries RV Deep Cycle 2 Each	50	110	No
Heavy RV Door Cycle	24	53	No
Panel Insulated Windows	10	21	Yes
Extended Cabover Twin Beds	21	46	No
Generator Onan	50	110	Yes
Microwaves Oven	16	35	Yes
Roof Rack System	16	35	Yes

GROSS WEIGHT IS 1488 KGS (3300 LBS)
 Weight does not include dealer installed equipment.
TRUCK-CAMPER MATCH
 To estimate the total cargo load that will be placed on a truck, add the weight of all passengers in the camper, the weight of supplies, tools and all other cargo. The weight of installed additional or optional camper equipment and the manufacturer's camper weight figure, truck and all other cargo. The weight of installed additional or optional camper equipment and the manufacturer's camper weight figure. Select a truck that has a cargo weight rating that is equal to or greater than the total cargo load of the camper and whose manufacturer recommends a cargo center of gravity zone that will contain the camper's center of gravity when it is installed. See Figures 1 and 2.
TRUCK CAMPER LOADING
 When loading this camper, store heavy gear first, keeping it on or close to the camper floor. Place heavy items far enough forward to keep the loaded camper's center of gravity within the zone recommended by the truck manufacturer. Store only light objects on high shelves. Distribute weight to obtain even side-to-side balance of the loaded vehicle. Secure loose items to prevent weight shifts that could affect the balance of your vehicle. When the truck/camper is loaded, drive to a scale and weigh on the front and on the rear axle separately to determine axle loads. The load on an axle should not exceed its gross axle weight rating (GAWR). The total of wheel weights should not exceed the gross vehicle weight rating (GVWR). These axle ratings are given on the vehicle certification label on the left side of the vehicle, normally the dash panel, hinge pillar, and door latch post or door edge next to the driver on January 1, 1972. If weight ratings are exceeded, move or remove items to bring all weights below the ratings.
OTHER RECOMMENDATIONS
 The cargo weight rating and center of gravity location zone of your truck are two important factors which have a direct influence on the handling and braking of your truck/camper combination. Other factors such as road and wind conditions, height of the camper load, and condition of brakes and tires also influence your vehicle's handling and braking. All factors must be considered and reasonable care must be exercised when operating your truck/camper.

Truck manufacturers are also required to provide a "center of gravity zone" for camper loading.

MFG BY: LANCE CAMPER MFG CORP MODEL: 8555 SERIAL: 169106
CONSUMER INFORMATION: TRUCK CAMPER LOADING
 CAMPER WEIGHT IS 1340 KGS(2955 LBS) MAXIMUM WHEN IT CONTAINS STANDARD EQUIPMENT, 137 LITERS(36 GAL) OF WATER, 18 KGS(40 LBS) OF PROPANE, AND 0.14 CUBIC METERS(5 CUBIC FT) REFRIGERATOR.
 CAMPER WEIGHT IS APPROXIMATELY 1488 KGS(3300 LBS) WITH FACTORY INSTALLED OPTIONAL EQUIPMENT WITH AN INSTALLED WEIGHT IN EXCESS OF 8 KGS(20 LBS). THIS WEIGHT INCLUDES 137 KGS(300 LBS) OF WATER AND PROPANE. THIS WEIGHT DOES NOT INCLUDE OPTIONAL EQUIPMENT WEIGHING LESS THAN 8 KGS(20 LBS) WHICH COULD TOTAL AS MUCH AS 68 KGS(150 LBS). ALSO THIS WEIGHT DOES NOT INCLUDE DEALER INSTALLED EQUIPMENT. CONSULT THE DATA SHEET SUPPLIED WITH THE OWNER'S MANUAL FOR WEIGHTS OF OPTIONAL EQUIPMENT.
TO ESTIMATE THE TOTAL CARGO LOAD THAT WILL BE PLACED ON A TRUCK ADD THE WEIGHT OF ALL PASSENGERS IN THE CAMPER, THE WEIGHT OF SUPPLIES, TOOLS AND ALL OTHER CARGO. THE WEIGHT OF INSTALLED ADDITIONAL OR OPTIONAL CAMPER EQUIPMENT AND THE MANUFACTURER'S CAMPER WEIGHT FIGURE. SELECT A TRUCK THAT HAS A CARGO WEIGHT RATING THAT IS EQUAL TO OR GREATER THAN THE TOTAL CARGO LOAD OF THE CAMPER AND WHOSE MANUFACTURER RECOMMENDS A CARGO CENTER OF GRAVITY ZONE THAT WILL CONTAIN THE CAMPER'S CENTER OF GRAVITY WHEN IT IS INSTALLED.
TRUCK CAMPER LOADING
 WHEN LOADING THIS CAMPER, STORE HEAVY GEAR FIRST, KEEPING IT ON OR CLOSE TO THE CAMPER FLOOR. PLACE HEAVY ITEMS FAR ENOUGH FORWARD TO KEEP THE LOADED CAMPER'S CENTER OF GRAVITY WITHIN THE ZONE RECOMMENDED BY THE TRUCK MANUFACTURER. STORE ONLY LIGHT OBJECTS ON HIGH SHELVES. DISTRIBUTE WEIGHT TO OBTAIN EVEN SIDE-TO-SIDE BALANCE OF THE LOADED VEHICLE. SECURE LOOSE ITEMS TO PREVENT WEIGHT SHIFTS THAT COULD AFFECT THE BALANCE OF YOUR VEHICLE. WHEN THE TRUCK/CAMPER IS LOADED, DRIVE TO A SCALE AND WEIGH ON THE FRONT AND ON THE REAR WHEELS SEPARATELY TO DETERMINE AXLE LOADS. THE LOAD ON AN AXLE SHOULD NOT EXCEED ITS GROSS AXLE WEIGHT RATING (GAWR). THE TOTAL OF WHEEL WEIGHTS SHOULD NOT EXCEED THE GROSS VEHICLE WEIGHT RATING (GVWR). THESE WEIGHT RATINGS ARE GIVEN ON THE VEHICLE IDENTIFICATION LABEL THAT IS LOCATED ON THE LEFT SIDE OF THE VEHICLE, NORMALLY ON THE DASH PANEL, HINGE PILLAR, DOOR LATCH POST, OR UPPER REAR AXLE. IF WEIGHT RATINGS ARE EXCEEDED, MOVE OR REMOVE ITEMS TO BRING ALL WEIGHTS BELOW THE RATINGS.
169106-8555
 Dealer: Highway Trailer Sales, Inc. 169106
 Shipdate: 05/21/12
 Ship to: Oklahoma
 Shipcode: 31592
 Expdate: 5/19/12

Lance provides a Consumer Information: Truck Camper Loading sheet with the Owner's Information Package supplied with your camper along with a Consumer Information sheet located on the backside of the wardrobe door. The Consumer Information sheet shows your camper's center of gravity and the wet weight of the camper with factory installed options. The wet weight is the weight of the camper with the water tank full and propane bottles full.

RV's become overloaded when people put too many things into them. There is no easy way to determine the weight you've loaded, so there's a temptation to keep loading until every available space is filled. People are loading by volume, but weight is far more important. Unfortunately, you may have exceeded the load-carrying capacity of the tires before everything is on board. The only way to tell if your truck/camper is overloaded is to weigh it fully loaded.

The most critical point about weighing a vehicle is that it must be weighed with everything on board that will be there while you're traveling. That means you must weigh the truck/camper with passengers, supplies, food, water, propane and the truck full of fuel. Bear in mind that water weighs 8.3 lbs per gallon and propane weighs 4.2 lbs per gallon. These two items alone can add over 400 lbs alone. Limiting your on-board water until you arrive at your destination will lower your total weight. You must know the actual load on the axles and wheels, and there's no other way to do it other than on a commercial scale.

In addition to knowing the total weight, it is crucial to know the weight on each end of each axle. That's the only way you can find out if the load is both within the tire capacity, as well as whether or not the load is properly distributed.

You should be able to find certified scales by looking in your Yellow Pages for moving and storage companies, farm suppliers, gravel pits, recycling companies or commercial truck stops. Be sure to call in advance to determine whether the facility offers public weighing services, their hours of operation and any fees that might be involved.

⚠ WARNING Failure to properly match camper and truck can result in undesirable handling characteristics and create a safety hazard.

Do not load your vehicle beyond its gross vehicle weight rating (GVWR) and/or gross axle weight ratings (GAWR). Both of these ratings are given on an identification label normally located at the driver's doorpost area.

In addition to knowing the overall weight that can be safely loaded in or attached to the truck, you should know how to distribute the weight in the camper so that correct amounts of weight are placed on each truck axle. Proper weight distribution is required for driving stability and will assure that the truck/camper is not rear, front or side heavy. Heavy weights placed at the rear end of the truck/camper may cause undesirable handling characteristics

When loading the camper, store heavy gear first, keeping it on or close to the camper floor. Place heavy things far enough forward to keep the loaded camper's center of gravity within the zone recommended by the truck manufacturer. Store only light objects on high shelves. Distribute weight to obtain even side-to-side balance of the loaded vehicle. Secure loose items to prevent weight shifts that could affect the balance of your vehicle.

TIRES

Tires are available in a variety of load ratings and sizes, and if the tires you currently have cannot handle the load, it maybe possible to replace your tires with tires of higher pound capacity. Bear in mind, that the ultimate capacity of the truck is determined by the weakest link in the system. This could be the tires, wheels, suspension or brakes.

The maximum ratings are molded into the side of the tire. The sidewall of the tire shows maximum and minimum inflation pressure for that load.

Be sure you also know the load and inflation pressure ratings for your wheels as well. Often, these are stamped on the inside of the wheels, but if not, your dealer can help you find out what they are. Never exceed the maximum load or inflation pressure of your wheels.

Driving on under-inflated tires can cause the tires to overheat, which leads to the breakdown of the tire's internal structure. Improper inflation also can reduce your ability to control your vehicle. Tire blowouts occur more during summer months than any other time of the year. Properly inflated tires last longer, run quieter, grip better, increase fuel mileage and safely support and control your vehicle.

Check your tire pressure once a month and each time before you take a trip with your truck and camper. Use a quality air pressure gauge to check the pressure. Do not under-inflate or over-inflate your tires. Inspect your tires for uneven or excessive wear. Look for bulges, cuts, blisters on the sidewalls.

When you're traveling, do as professional commercial drivers do: inspect your tires regularly and check and adjust cold inflation pressure every day that you travel.

CAUTION Individual wheel position weights must not exceed the maximum tire load capacity. Maximum tire load capacity can only be achieved utilizing the maximum allowable psi as listed on the sidewall of the tire.

ELECTRICAL CONNECTION TO TRUCK

Your Lance Camper comes equipped with a 12-volt electrical cord with a molded camper connector. The truck electrical connector will be installed by your Lance Dealer to your truck wiring system. With the wiring and connectors hooked-up, your truck will supply 12-volt DC power to charge your camper battery and provide power for the 12-volt power needs while the truck is operating.

Lance Camper uses a proprietary connection plug that has been designed specifically to handle the amperage requirements of the 12-volt circuit on the 3-way refrigerator.

Under no circumstances should the plug be altered or changed to another type. Common style plugs are not designed to accommodate the 8 gauge wire or amperage demands required for the refrigerator.

amount of amperage. This selection should only be used while traveling when your truck alternator can produce this amount of amperage. Using an 8 gauge wire from your truck battery to the camper will ensure that adequate amperage will be supplied to the refrigerator.

To protect your truck's 12-volt system from overload, a 40-amp circuit breaker should be installed at the power source under the hood. A Battery Separator may be installed on your Lance camper. Its purpose is to protect your truck's starting battery from discharge. To handle the camper's electrical requirements and to charge the camper battery, 8 gauge hot and ground wires must be run from the power source under the truck hood to the 12-volt camper electrical connector location in the truck bed.

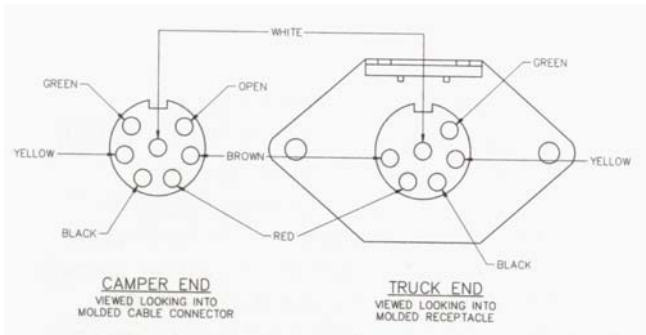
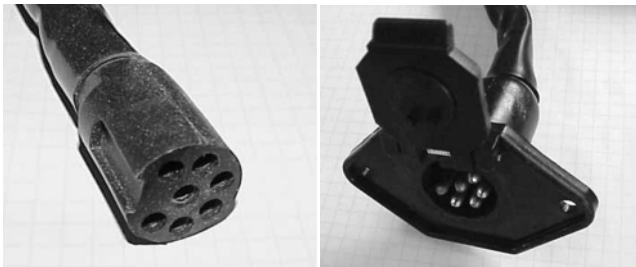

COLOR	GAUGE	FUNCTION
Black	8	12-volt power
White	8	Ground (-)
Green	14	Running Lights
Red	16	Left Turn Signal
Brown	16	Right Turn Signal
Yellow	16	Back-up Lights

NOTE: Do not use less than 8 gauge wire size for charge lines. Also, do not attach them to smaller gauge wires. Your camper maybe equipped with a 3-way refrigerator which uses 120-volt, 12-volt or LP gas to operate. Selecting the 12-volt operation requires a large

TRUCK/CAMPER LOAD WORKSHEET

The truck must be weighed with occupants and full of fuel. Drive onto the scales and get the weight of the total truck. Next pull forward until the front axle is off the scale and get the weight on the rear axle. Subtract the weight on the rear axle from the total truck weight to get the weight on the front axle.

With the camper loaded and ready for a camp outing, pull on the scales as before and get the weight of the total truck and camper. Next pull forward until the front axle is off the scale and get the weight on the rear axle. Subtract the weight on the rear axle from the total truck and camper weight to arrive at the weight on the front axle. Subtract the truck weights from the total truck and camper weight for each axle. This amount should be less than the truck manufacturer's GAWR rating as shown on the Federal Certification Label. If you are over the GAWR rating, you will need to remove or shift weight accordingly.

Once you are less than the GAWR, you need to weigh each individual wheel to insure you are not overweight from side to side. Again pull on to the scales, but with only the right front tire on the scales. Pull forward and get the weight of the right rear tire. Do the same for the left side tires. First the front and then the rear. Take the GAWR rating of the front axle and divide by 2. Do the same for the rear. This is the GAWR for each axle end. Now subtract the individual wheel weights from the individual GAWR for each wheel. If the amount is less you are within the GAWR for that axle end. If the amount is more, you are over the GAWR for that axle end and you will need to adjust how your unit is loaded to bring the weight down within the GAWR.

Proper weight distribution, load management and operating within established limitations will aid in safe and enjoyable travel.

TRUCK/CAMPER LOAD WORKSHEET

TRUCK WEIGHT: INDIVIDUAL AXLE AND GROSS VEHICLE WEIGHTS

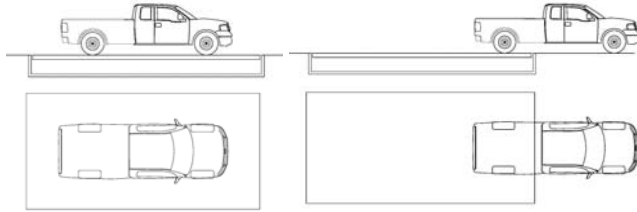

STEP 1A = GVW

STEP 1B = GAW

STEP 1C
GAW = (1A - 1B)

SCALE WEIGHT	LBS.	LBS.	LBS.
--------------	------	------	------

	GVWR	GAWR REAR	GAWR FRONT
FROM FEDERAL CERT. LABEL	LBS.	LBS.	LBS.

TRUCK AND CAMPER WEIGHT: INDIVIDUAL AXLE AND GROSS VEHICLE WEIGHTS

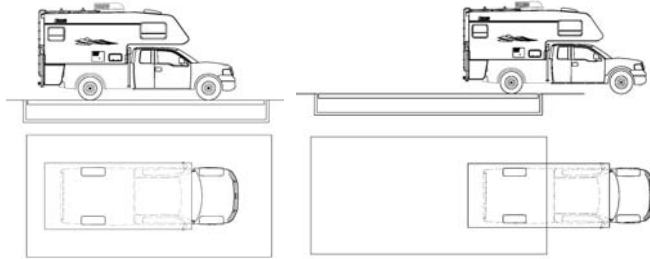

STEP 2A = GVW

STEP 2B = GAW

STEP 2C
GAW = (2A - 2B)

SCALE WEIGHT	LBS.	LBS.	LBS.
--------------	------	------	------

	GVWR	GAWR REAR	GAWR FRONT
FROM FEDERAL CERT. LABEL	LBS.	LBS.	LBS.

TRUCK AND CAMPER WEIGHT: INDIVIDUAL WHEEL POSITION WEIGHTS

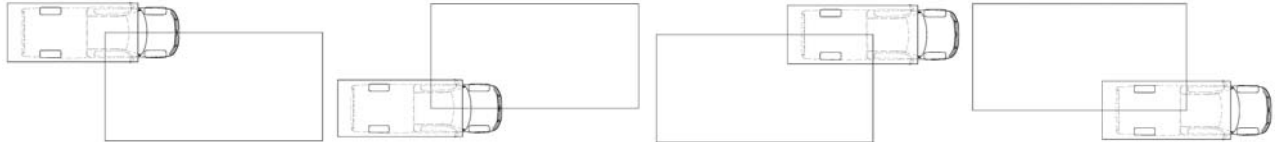

STEP 3A

STEP 3B

STEP 3C

STEP 3D

SCALE WEIGHT	LBS.	LBS.	LBS.	LBS.
--------------	------	------	------	------

FROM FEDERAL CERT. LABEL	FRONT	FRONT	REAR	REAR
GAWR ÷ 2	LBS.	LBS.	LBS.	LBS.

CAUTION Individual wheel position weights must not exceed the maximum tire load capacity. Maximum tire load capacity can only be achieved utilizing the maximum allowable psi as listed on the tire.

This page intentionally blank.

SUPPORT EQUIPMENT

AIR BAGS

Adding air bags can improve vehicle ride, safety, handling and load hauling. Air bags are used to maintain proper weight distribution to all the tires to improve steering, braking and tire wear. Air bags increase spring rate and improve your truck and camper stability. Air bags are used to raise your loaded truck back to the normal ride height. A level, balanced vehicle handles better and provides a safer, more comfortable ride.

HEAVY DUTY SHOCKS

An adjustable shock absorber can significantly increase ride-tuning capabilities in all driving conditions, on and off-road.

TIEDOWNS AND TURNBUCKLES

The camper must be secured to the truck with high quality tiedowns and turnbuckles. The front turnbuckles must be spring or shock loaded. Lance recommends use of HappiJac and/or Torklift tiedowns and turnbuckles.



Front Turnbuckle Installation

The front turnbuckles are the ones with the longer barrel. They are spring loaded. They must be used on the front to ensure proper system performance. Prior to installing the front turnbuckles hold the turnbuckle up by the captive (non-threaded) hook, mark the hook at the point where it enters the barrel with a painted, taped, or scribed line to make future installations easier. Install the turnbuckles on the truck and camper with the threaded hook end up. This will keep moisture from entering and pooling inside the turnbuckle. Tighten the turnbuckle until the mark that you made has drawn away from the base of the barrel by 1/4". This will set the proper preload on the internal spring. **DO NOT TIGHTEN BEYOND THIS POINT!** The turnbuckles can be easily hand tightened to this point. Use a 3/4" wrench **ONLY** to tighten and loosen the jam nut which prevents the turnbuckle from twisting loose.



Rear Turnbuckle Installation

Unlike the front turnbuckles, the rear turnbuckles do not have an internal spring. Rear turnbuckles should **NEVER** be used on the front of the camper. The rear turnbuckles are the pair with the shorter (8") barrels. Install the Tiedown Couplers onto the Anchor bolts in the ends of the rear bumper. Install the turnbuckles, threaded hook up. Tighten by hand until just snug and then tighten the lock nut using a 3/4" wrench. Check eyebolts, turnbuckles, and bracket bolts before each trip and at frequent intervals.



EXCLUSIVE LANCE CABOVER TRUCK STRUTS

(Shock Absorbers)

To dampen the vertical movements of the camper cabover, it is advisable to install the optional Lance Cabover Struts.

The length of the vertical movement built into the strut will allow them to remain connected to the truck and camper under all but the most rough travel conditions.

The struts should be cleaned and lubricated prior to each trip. This will prevent damage to the o-rings in the strut. It is normal to have an oil film on the shaft of the strut for lubrication.

Brackets are sold separately and are available for various types of trucks from your Lance Dealer.



HITCHING AND TOWING SYSTEMS

Lance recommends either a Reese and/or Torklift hitch system for use when towing with your truck and Lance camper. The Reese Titan Class V and/or Torklift Superhitch Series Receiver, along with a custom designed extension bar for campers over 8' are available from authorized Lance Dealers. It can be used with a standard weight carrying ball mount, or for added capacity, a weight distributing hitch bar and ball mount.

Hitch systems should be installed by qualified personnel only. Towing will change the handling and braking characteristics of your truck/camper package. Do not tow from or attach a hitch bar or ball to the camper bumper.



LOADING AND UNLOADING

The camper is loaded, unloaded with the aid of jacks positioned at each corner of the camper. Before operating jacks, read this chapter thoroughly.

ELECTRIC CAMPER JACKS

Electric jacks need 12-volt automotive battery power to operate. The camper battery must be charged and in good condition. If the battery is too low to operate the jacks, charge the battery before using jacks. If the camper is on the truck, starting the truck's engine will supply power to the jacks as long as the 12-volt electrical power cord is connected. If the camper is off the truck and battery power is low, a 12-volt electrical connector extension (available from your Lance Dealer) can be used to connect the camper to the truck to power the jacks. If no power is available, use the manual override operation noted below.



Do not use the electric jacks to raise or lower the camper using only 120-volt power. The converter's charger will be damaged if the jacks are operated with 120-volt power through the 12-volt converter without an automotive battery or with a low battery installed in the camper.

Before operating the remote control electric camper jacks, be sure to read and understand the operating instructions that were provided with your camper pertaining to their safe operation.

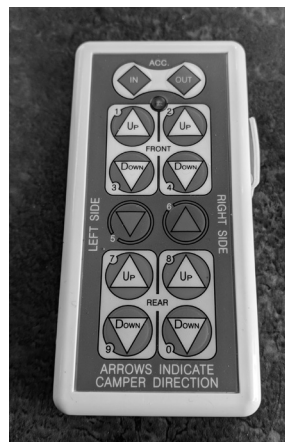

The jacks are operated with a hand held remote control.

The remote control that is provided with the relay module is ready to use without any additional programming.

The remote will control either "Jacks" or Aux Motors" such as the slide room, if equipped.

The remote is powered by a AA battery located under the removable cover on the back of the remote unit. Always have a spare AA battery available for your remote.

To replace the AA battery:

- Remove the six (6) Phillips screws with a #0 Phillips screwdriver.
- Pull the back cover directly away from the front cover.
- Remove the old battery and insert the new battery, making sure it is in the correct orientation.
- Replace the back cover and press the covers together firmly.
- Replace the six Phillips screws.

To Operate the Remote:

- Activate the remote control by pressing the "Up/Down" buttons located in the center of the remote. A green LED will indicate the remote control is activated.
- When controlling jacks, the following operations are possible.
 - Extension or retraction of an individual jack.
 - Extension or retraction of all 4 jacks.
 - Paired operation of front or rear jacks.



The base receiver for your remote jacks is located on the driver's side forward most cabinet, usually in the cabover step.

The receiver uses (5) 25 amp ATC fuses that protect each of the jack circuits. If any of the jacks do not operate while depressing the center located "All Jacks" buttons on the remote, check the fuses.

TO LIFT CAMPER: (Extend Jacks to Ground)

1. Extend front jacks so camper is 2" to 4" higher in front than in the rear (see page 28).
 - a. Power on the remote control.
 - b. Press and hold the Driver Front and Passenger Front jack "Up" (▲) buttons until the front of the camper is 2" to 4" higher than in the rear.
2. Once the camper front is higher than the rear:
 - a. Press the all jacks button.
 - b. Use the "Up" (▲) and "Down" (▼) buttons to position the camper to the desired height.
3. Use the individual jacks buttons to adjust any individual jack:
 - a. Press the desired jack button.
 - b. Use the "Up" (▲) and "Down" (▼) buttons to position the jack as desired.

Note: Jacks may be operated in pairs by pressing the "Up" (▲) and "Down" (▼) buttons to position them as desired. Only the following combinations can be paired in this way:

- Both Front
- Both Rear

TO LOWER CAMPER:

1. Retract rear jacks so camper is 2" to 4" higher in the front than in the rear (see page 28).
 - a. Power on the remote control.
 - b. Press and hold the Driver Rear and Passenger Rear jack "Down" (▼) buttons until the front of the camper is 2" to 4" higher than in the rear.
2. Once the camper rear is lower than the front:
 - a. Press the all jacks button,
 - b. Use the "Up" (▲) and "Down" (▼) buttons to position the camper to the desired height.
3. Use the individual jacks buttons to adjust any individual jack:
 - a. Press the desired jack button.
 - b. Use the "Up" (▲) and "Down" (▼) buttons to position the jack as desired.

Note: Jacks may be operated in pairs by pressing the "Up" (▲) and "Down" (▼) buttons to position them as desired. Only the following combinations can be paired in this way:

- Both Front
- Both Rear

When operating the jacks by remote control, visually inspect all four jacks to insure that they are responding properly and that you are following proper lifting or lowering camper procedures.

When any jack reaches the end of travel, either at full retraction or full extension, an overcurrent situation will cause the remote to shut down operating of all jacks and sound an alarm.

1. At the time of the alarm, press each jack button individually in the direction of travel.
2. When the alarm sounds again, this is the jack which has amped out and cannot be moved farther in that direction. Operation of the other jacks is not affected unless they reach the end of travel and amp out as well.

NOTE: Never leave jacks bound in either the fully extended or fully retracted position.

3. A bind due to uneven loading of the jacks may also cause the motors to amp out. Reverse the jack, correct the load issue and continue to load or unload.

If jacks fail to operate, check these items:

1. Be certain that the AA battery in the remote control unit is fresh. Keep spare batteries available.
2. You are within range for the remote to operate.
3. Adequate 12-volt battery power is available.
4. The jack electrical cord is securely plugged into the exterior socket.
5. Hold the remote vertically (keypad facing you) and have it between the camper and you.
6. If other radio frequencies devices are making the jacks pause, lift your finger from the button and press the button again.

If the jacks still fail to operate, consult your Lance service center for more information and help.

Manual Jack Operation:

In the event it becomes necessary to operate one or more of the jacks manually due to a malfunction of the system or a dead or low camper battery, utilize this procedure.

1. Remove the protective weather cap and insert the hand crank handle into the crank socket on the jack.
2. Flip the motor release/locking lever on the side of the jack to the down position. This will disengage the motor head from the jack, allowing it to turn freely by hand.

3. Manually raise or lower jack to the desired position.
4. Return the locking lever to the up position when not hand cranking. This engages the motor and provides a secure lock for the jack.
5. Remove the crank handle.
6. Return the protective weather cap.



Swing-Out Brackets: (If equipped)

To load or unload campers on dual rear wheel trucks, swing-out brackets are installed on the front jacks to clear the fender. To operate, follow the steps below:

1. Push up on the spring loaded nut located at the bottom of the hinge and swing jack outward from the camper body.
2. The jack will lock in position once at a 90 degree angle from the camper body.
3. Repeat the process for the other front mounted jack.
4. Follow the standard camper loading and removal procedures below.

LOADING/REMOVING CAMPER

Keep children and animals away from area when raising or lowering camper. Avoid putting any part of your body under the camper during the procedure.

Always ensure that all four (4) jack legs are touching the ground. Having one (1) jack off the ground can cause an undesirable weight shift, which can cause excessive side loading of remaining jacks.

Do not tilt the camper sideways while raising or lowering camper on the jacks. The jacks could buckle.

Always raise and/or lower camper with the front either level or higher than the back to avoid weight transfer and damage to jacks or cargo.

Always ensure slide-out rooms and/or awnings are retracted.

Load and unload camper on firm level ground. Unequal load on the jacks can cause the slide-out opening to rack.

Use caution when loading and/or unloading the camper on a windy day. The amount of wind that is dangerous depends on your exposure and the weight of the camper, etc.

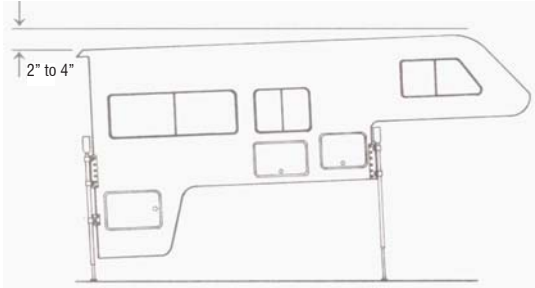

ALWAYS KEEP FRONT HIGHER THAN REAR.

LOADING CAMPER ON TO TRUCK

1. Extend each jack no more than 4" at a time, starting with the front jacks, keeping the camper as level as possible at all times. Repeat this process until the camper will clear the truck body bed by approximately 2" to 4".
2. Slowly back up truck under camper making sure to clear wheel wells and any structure or plumbing located below the living area. This may take more than one try.
3. Continue backing until the truck is within a foot of loaded position. Stop and connect the 12-volt power cord to the 12-volt receptacle in the truck bed.
4. Continue backing under the camper until the bumpers mounted on the crossbar in the truck bed lightly touch the front of the camper.
5. Slowly lower both rear jacks, then front jacks until the camper is resting fully on the truck bed.
6. Raise the jacks and secure in place according to the manufacturer's instructions.
7. Lift and swing front jacks inward (if equipped with swing-out brackets).
8. Secure the camper to the truck with turnbuckles. The front turnbuckles must be spring or shock loaded, while the rear should use solid turnbuckles. Install both the front and rear turnbuckles per manufacturer's instructions.
9. Connect cabover struts (optional).
10. Install crawl through boot (optional).

REMOVING CAMPER FROM TRUCK

1. Position the truck/camper combination on firm level ground. If needed, use 12" sq. 3/4" plywood support pads under each jack to prevent sinking into the ground or asphalt.
2. Disconnect and/or remove the following items:
 - Cabover struts
 - Front and rear turnbuckles
 - 12-volt camper power cord
 - Rear view camera cord (if equipped)
3. Using your remote control, operate all jacks together until the camper clears the truck bed by 4". If necessary to operate the jacks individually, starting with the front jacks, extend the jacks no more than 4" at a time, keeping the camper as level as possible at all times. Repeat the process until the camper has cleared the truck body bed by approximately 4".
4. Slowly drive the truck out from under the camper. Be sure to clear the front overhang.
5. Lower the camper with the rear jacks first, and then the front jacks no more than 4" at a time. Always keep the front of the camper slightly higher than the rear.

Always lower camper back down close to ground level. Do not use tall sawhorses, cinderblocks etc. to support the camper in the raised position. Do not enter or occupy the camper in a raised position.

Your camper is designed to be used while standing on the jacks in a lowered position without damage to the camper.

When lowering camper, do not allow camper bumper or generator exhaust pipes to touch the ground. Damage may occur. Allow two inches of clearance to the ground.

LEVELING/STABILIZING CAMPER

Prior to lowering the jacks, try and park on a flat level spot whenever possible; certainly never on a steep slope. If it is not possible to move to a more level location, use wood blocks under the truck tires to assist in leveling. Be sure that the block is larger than the "footprint" of the tire. No part of the tire should ever "hang over" the edge of the block. This includes duals. This can cause internal damage to the tire. Being level is necessary for comfort, but it is also required for correct operation of your refrigerator and slideout rooms. The jacks should only be used to stabilize the camper when attached to the truck. Attempting to level your camper and truck using the jacks can overload your jacks and cause damage to them, your camper, and your tie-down system.

ON THE ROAD

LOADING

When loading camper gear, store heavy items first and place down low. Distribute weight as evenly as possible from side to side. REMEMBER: overloading or uneven loading can create a serious safety hazard and may shorten the service life of chassis components. Do not load upper cabinets with heavy items. Secure and brace stored items so they won't move during travel, thereby shifting the load in the camper. Do not load heavy items near the end of the camper or on the rear bumper. Carry only as much water as needed for travel use or to balance the load. Whenever possible, empty the waste water holding tanks before traveling.

STORAGE

All cabinets and storage areas should have the heaviest items on the bottom and lighter items overhead. After loading you should have the skillet and can goods on the floor or bottom shelf, and the cereals and crackers in the overheads. Use the unbreakable type plates and saucers, and consider storing your dishtowels around them.

Clothing hung in wardrobes should be kept on hangers that snap over the clothes rods to keep them from "jumping" off on rough roads.

PREPARING FOR TRAVEL

Properly preparing for a trip before you leave can make things more enjoyable. Make a list of items you will need or wish to take. Keep in mind the following categories:

- Bathroom supplies
- Bedding
- Cleaning items
- Clothing
- Fire Extinguisher
- First aid items
- Food
- Holding tank chemical
- Kitchenware
- Personal items
- Road flares
- Tools

PRE TRIP CHECKS

(Exterior)

1. Connect battery(s) and check condition.
2. Check for fluid leaks.
3. Check tires and wheels for damage and proper inflation. Check tires for cuts or other damage.
4. Check tires for unusual tread wear that may indicate a balance or suspension problem.

5. Always keep tires in good condition and when replacing, be certain that the new tires have the load carrying capacity of your truck's G.V.W.R.
6. Check that access doors are securely closed.
7. Check engine and power plant oil levels.
8. Check engine coolant level, windshield washer reservoir, and batteries.
9. Check all running lights, taillights and electrical system.
10. Be sure tie downs and cabover stabilizers are securely tightened.
11. Be sure to use a stable and adequately rated heavy-duty jack that will lift both the truck and camper combined weight.

(Interior)

1. Secure all loose items.
2. Close all drawers and cabinets.
3. Secure range and refrigerator doors.
4. Check that entry door is locked.

(Systems)

1. Fill fresh water tank.
2. Drain holding tanks and secure drain cap.
3. Check operation of interior lights and appliances.
4. Check propane gas level. Check for kinked propane lines and possible leaks.

POST-TRIP CLEAN-UP

1. Clean unit and check for damage.
2. Drain waste-holding tanks.
3. Clean waste drain hose and secure drain cap.
4. Drain fresh water tank and rinse.
5. Close outlet valve on propane tank.
6. Disconnect the battery cables or turn off battery disconnect switch if equipped.

SAFE DRIVING RULES

Your truck will have different handling and stopping characteristics when it is carrying the camper. The following rules will help you develop needed skills for safe truck camper driving.

Travel slowly with your new truck/camper combination, until you have learned the handling and stopping characteristics of the combination. Practice turning, stopping, and backing in a secluded place away from traffic.

Do not permit a driver who is inexperienced to operate your truck/camper combination without your direct supervision. REMEMBER it's slow speed for beginners.

Drive at moderate speeds allowing for adverse highway and wind conditions. Even under the best of conditions, do not exceed 55 miles per hour. As speed

increases, driving stability, stopping ability, and ability to make emergency maneuvers are greatly reduced.

Reduce speed before starting down hills - even short ones - and avoid heavy braking on downgrades. Truck stability is reduced when traveling downhill.

Slow down before entering turns and avoid heavy braking in turns. Truck stability is reduced in turns, and the weight of the camper on the truck will affect the way the truck handles. Avoid quick steering movements that can reduce truck stability.

Maintain at least twice the normal stopping distance while carrying your camper. The increased weight of the camper on the truck requires greater stopping distance.

Use lower gears on long grades. Downshift on upgrades to avoid overheating or undue engine loads. Downshift on downgrades to allow engine braking to assist in controlling vehicle speed. Avoid continuous or frequent brake application. The added weight of the camper can cause brakes to overheat and fade.

Allow ample time for passing. Your acceleration will be much slower when you are carrying the camper.

Become familiar with the position of the truck in traffic, and be cautious when maneuvering to allow for its length and width. Always allow extra room to corner and to change lanes. Learn to use the side mirrors to view the road behind and to the sides. Check them often.

Allow for extra height of your camper. Check for low hanging tree branches or other obstructions whenever you drive, park, or when pulling in for fuel or service. Always check overhead clearance of overpasses and bridges, especially if you drive with the roof vents slightly open or if the camper is equipped with a roof air conditioner, roof rack, TV/radio antenna, or a satellite dish.

Measure your height from the ground to the highest point on the roof. Write it down on a piece of tape and put it in a visible place in your truck. This will help you when you get to that "low overpass".

RIDING IN CAMPER WHILE TRAVELING

For the safety of passengers, it is not advisable to ride in the camper while traveling. In some states it may be illegal. If it is necessary, care must be taken to remain seated while moving.

CAMPGROUND REGULATIONS

You should always check the campground regulations on arrival. This will avoid any unnecessary conflict with the campground management and/or other campground users. **Note: Some Campgrounds do not allow the camper to be removed from the truck.**

CARBON MONOXIDE GAS

Safety Precautions

Carbon monoxide gas is colorless, tasteless, and odor-less. It is a combustion by-product of fuel burning engines. The engines in your truck and generator system (if installed) produce it constantly while they are running. Carbon monoxide gas is deadly. Please read and understand the following warnings and precautions to protect yourself and others from the effects of carbon monoxide gas.

▲ **WARNING** Exhaust gases are deadly. Do not block the tailpipes or situate the vehicle in a place where the exhaust gases have any possibility of accumulating either outside, underneath, or inside your vehicle or any nearby vehicles.

▲ **WARNING** Outside air movement can carry exhaust gases inside the vehicle through windows or other openings remote from the exhaust outlets.

▲ **WARNING** Operate the engine(s) only when safe dispersion of exhaust gases can be assured, and monitor outside conditions to be sure that exhaust continues to be dispersed safely.

▲ **WARNING** Do not under any circumstances operate any engine while sleeping. Beware of exhaust gas (carbon monoxide) poisoning symptoms:

- Dizziness
- Headache
- Weakness and sleepiness
- Nausea
- Vomiting
- Muscular twitching
- Throbbing in temples
- Inability to think coherently

If symptoms indicate the possibility of monoxide gas poisoning:

- Turn off engine(s) immediately
- Get out into fresh air at once
- Summon medical assistance

Check the exhaust systems during routine maintenance and repair any leaks, damage, or obstruction before further operations. Do not modify any exhaust system in any way.

EFFECTS OF PROLONGED OCCUPANCY

Your camper was designed primarily for recreational use and short-term occupancy. If you expect to occupy the camper for an extended period, be prepared to deal with condensation and the humid conditions that may be encountered.

The relatively small volume of space and air tight construction of a modern recreational vehicle means that the normal living activities of even a few occupants will lead to rapid moisture saturation of the air contained in the camper and the appearance of visible moisture, especially in cold weather.

Just as moisture collects on the outside of a glass of cold water during humid weather, moisture can condense on the inside surfaces of your camper during use in cold weather when the relative humidity of interior air is high. This condition is increased because the insulated walls of the camper are much thinner than house walls.

Estimates indicate that a family of four can vaporize up to three gallons of water daily through breathing, cooking, bathing, and washing. Unless this water vapor is carried outside by ventilation, or condensed by a dehumidifier, it will condense on the inside of the windows and walls as moisture, or in cold weather as frost or ice. It may also condense out of sight within the walls or the ceiling where it will manifest itself as warped or stained panels.

Appearance of these conditions may indicate a serious condensation problem. When you recognize the signs of excessive moisture and condensation in your camper, you should take action to minimize their effects.

NOTE: Your camper is not designed to be used as permanent housing. Use of this product for long term or permanent occupancy may lead to premature deterioration of the structure, interior finishes, fabrics, carpeting and drapes. Damage or deterioration due to long-term occupancy may not be considered normal, and may under the terms of the warranty constitute misuse, abuse or neglect, and may therefore reduce your warranty protection.

VENTILATION AND MOISTURE CONTROL

You can reduce interior moisture condensation by taking the following steps:

Ventilate with outside air. Partially open one or more roof vents and one or more windows to provide circulation of outside air into the interior. While this

ventilation may increase furnace-heating load during cold weather, it will greatly reduce water condensation. Even when it is raining or snowing, ventilation air from outside will be far drier than interior air and will effectively reduce condensation inside the camper.

Minimize moisture release inside the camper. Run the range vent fan when cooking and the bath vent fan (or open the bath vent) when bathing to carry water vapor out of the camper. Avoid making steam from excessive boiling or use of hot water. Remove water or snow from shoes before entering to avoid soaking the carpet. Avoid drying overcoats or other clothes inside the camper.

⚠ DO NOT HEAT THE CAMPER INTERIOR WITH THE RANGE OR OVEN!!

In addition to the hazards of toxic fumes and oxygen depletion, open flames add moisture to the interior air, increasing condensation. Do not use an air humidifier inside the camper. Water put into the air by the humidifier will greatly increase condensation.

Ventilate closets and cabinets. During prolonged use in very cold weather, leave cabinets and closet doors partially open to warm and ventilate the interior of storage compartments built against exterior walls. The airflow will warm the exterior wall surface, reducing or eliminating condensation and minimizing possible ice formation.

Install a dehumidifier. During prolonged, continuous use, a dehumidifying appliance may be more comfortable and effective in removing excess moisture from the interior air. While use of a dehumidifier is not a "cure-all", ventilation, and moisture reduction continue to be important, operation of the dehumidifier will reduce the amount of outside air needed for ventilation. Heating load on the furnace will be reduced, and the interior will be less drafty.

DRIPPING CEILING VENTS

During cold weather and even in short term occupancy, condensation frequently forms on ceiling vents and may even accumulate to the point of dripping onto the surfaces below. This is frequently misinterpreted as a “leaking” roof vent but is most often condensation drippage.

Follow the preceding steps to control moisture condensation. Insulated hatch and vent covers are available. Consult your Lance Dealer.

INTERIOR ODOR

New units may have a strong odor and even cause eye and lung irritation when closed up in hot weather. This is due to glues used in production of forest products (plywood, paneling, etc.). This condition passes with time, but in an extreme condition, open the door, windows, and vents to allow the interior to “air out” for several hours.

FIRE AND SAFETY

The hazard and possibility of fire exists in all areas of life, and the recreational lifestyle is no exception. Your camper is a complex device made up of many materials - some of them flammable. But like most hazards, the possibility of fire can be virtually eliminated by recognizing the danger and practicing common sense safety and maintenance habits.

Recreational vehicle fires are generally caused by unattended food cooking on the stove or in the oven, faulty or damaged wiring and electrical devices, fuel leaks (both gasoline and propane), or carelessness. The most common careless acts include smoking in bed, leaving children unattended and cleaning with flammable liquids.

Consider These Fire Safety Suggestions:

Before refueling your truck or any fuel tank in the vicinity of your camper, be sure to turn off all pilots and appliances in your trailer. (See Important Words on Safety on page 9)

Consider the cause and severity of the fire and the risk involved before trying to put it out. If the fire is major or is fed by gasoline, propane or any type of oil product, stand clear of the vehicle and wait for the fire department or other emergency assistance.

If your camper is damaged by fire, do not use it until it has been thoroughly examined and the cause of the fire is found and fixed.

All occupants of the trailer should become familiar with the audible sound of the smoke, propane leak and CO detectors. If an alarm sounds, investigate the cause. Do not remove the detector in an attempt to silence the alarm.

Teach everyone in the camper how to use the entry door locking system and emergency exits. Occasionally open the emergency exit to prevent the seal from sticking. Always keep the dead bolt on the entry door in working condition.

FIRE EXTINGUISHER

The fire extinguisher in your camper is located near the main entry door. Your fire extinguisher should be replaced immediately after use or discharge.

The fire extinguisher furnished with your camper is rated for Class B (gasoline, grease, flammable liquids) and Class C (electrical) fires since these are the most common types of fires in recreational vehicles. Read the instructions on the fire extinguisher. Know how and when to use it. You and your family should be familiar with its operation. If you find it necessary to use the fire extinguisher, stand 45 degrees from the flame and spray



side to side, starting at the top of the flame. Use caution to avoid standing upwind or uphill. If flames are climbing, spray vertical and work the retardant downwards. Dry chemical flame retardant should be cleaned away as soon as possible.

SMOKE DETECTOR

Most fire casualties are caused by inhalation of toxic fumes (smoke) from a fire and not by flame. The smoke detector responds to smoke that enters the sensing chamber. It does not sense gas, heat or flame. A ceiling mounted, battery powered smoke detector is located in the living /cooking area of your camper. Please read the smoke detector Owner's Manual for details on testing and caring for this important safety device.

NOTE: Ensure attention is paid to product expiration of this safety device.



Test the smoke detector after the camper has been in storage, before each trip, and at least once a week during use.

The smoke detector should never be disabled due to nuisance or false alarm from cooking smoke, a dusty furnace, etc. Ventilate your camper with fresh air and the alarm will turn off. Do not disconnect the battery.

Replace the battery once a year or immediately when the low battery "beep" signal sounds once a minute. The detector uses a standard 9-volt battery.

Test smoke detector operation after replacing the battery. If the smoke detector fails to operate with a new battery, replace the detector with a new unit.

COMBINATION CARBON MONOXIDE AND PROPANE LEAK DETECTOR

A permanently installed detector is located near the floor in the forward portion of the main camper floor area. The unit contains an alarm that will sound, alerting you to the presence of propane or carbon monoxide.



⚠ WARNING
TO REDUCE THE RISK OF CARBON MONOXIDE POISONING OR PROPANE GAS EXPLOSION, TEST THIS ALARM'S OPERATION AFTER THE CAMPER HAS BEEN IN STORAGE, BEFORE EACH TRIP AND AT LEAST ONCE PER WEEK DURING USE.

⚠ WARNING
DO NOT USE A CIGARETTE LIGHTER TO TEST THE CO / PROPANE GAS ALARM. Butane gas may damage the sensors.

DO NOT attempt to test the alarm by any other means than by using the TEST/RESET button. DO NOT attempt to produce CO to the alarm. The TEST/RESET button tests all functions of the alarm and is the ONLY safe way to be sure the alarm is working properly.

The alarm may be tested at any time. The TEST/Mute switch is located on the front of the alarm. Press and hold the test button for 1 second. The alarm is working properly if the GREEN indicator light changes color to RED and the alarm beeps 4 times. The Gas LED should also blink Red.

OPERATION

When the unit is first powered up, the CO sensor requires a ten (10) minute initial warm-up period to clean the sensor element and achieve stabilization. The GREEN LED indicator will flash on and off during the 10 minute warm-up period. This unit cannot go into a CO alarm during the warm-up period. After the warm-up period, the GREEN power ON indicator should glow continuously. If the ON indicator light does

not light see the section, "Trouble-Shooting Guide" in the User's Manual for this alarm provided in the Owner's Information Package.

This alarm will operate normally down to 7-volt DC.
It will not work without power.

VISUAL AND AUDIBLE ALARM SIGNALS

The CO / Propane Gas Alarm is designed to be easy-to-operate. The alarm has two indicator lights that display a specific color for each monitored condition. There also is a matching sound pattern for alarm conditions.

CO ALARM

The Red CO LED will flash and the alarm will sound 4 "BEEPS" then silent for 5 seconds. These signals indicate that the CO level is over 70 ppm. IMMEDIATE ACTION IS REQUIRED. This cycle will continue until the TEST/Mute button on the front of the alarm is pressed. Ventilate the Camper. The RED light will stay ON until the CO has cleared, or the alarm will reactivate in approximately 6 minutes if the CO is still present. DO NOT RE-ENTER THE CAMPER. This alarm will return to normal operation after the Camper's properly ventilated.

PROCEDURES TO TAKE DURING A CO ALARM

Actuation of this device indicates the presence of carbon monoxide (CO) or propane gases, which can kill you. If signal sounds (4 beeps and flashing or solid red light), immediately turn off all combustion sources and ventilate the premises. Evacuate the premises immediately. Check that all persons are accounted for. Do not re-enter the camper until it has been aired out and the problem corrected. Have the problem corrected before restarting appliances.

⚠ WARNING Carbon monoxide cannot be seen or smelled and can kill you.

PROPANE GAS ALARM

The Red LED will flash and the alarm will sound a steady tone whenever a dangerous level of propane or methane gas is detected. IMMEDIATE ACTION IS REQUIRED. The detector will continue to alarm until the Test/Mute switch on the front of the alarm is pressed. Ventilate the Camper. The RED Gas LED will continue to flash until the gas is cleared, or the gas alarm will reactivate in approximately 5 minutes if the gas is still present. DO NOT RE-ENTER THE CAMPER. This alarm will return to normal operation after the Camper is properly ventilated.

NOTE: This device detects the presence of propane; it does not disconnect the gas supply.

PROCEDURES TO TAKE DURING A GAS ALARM

Turn the propane off at the tank(s), turn off all propane appliances, extinguish all flames and smoking material and open all doors and major windows to air out the camper. Do not re-enter the camper until the alarm stops sounding. If the alarm sounds a second time after the propane is turned back on, leave the propane off and have a Lance Service Center make the necessary repairs to the source of the propane leak.

Be aware of the difference between a propane leak versus propane escaping from an unlit, open burner. Pure propane from a leaking pipe or fitting is heavier than air and will buildup its heaviest concentration at the floor level first. Propane from open burners is intentionally mixed with air to induce burning and will dissipate into the air. The primary purpose of the detector is to detect propane leaks. The propane from open burners is mixed with air (oxygen) so that it will burn. When mixed with air, the propane becomes only marginally heavier than air and may not sink to the floor. If a burner is left on, the area around the burner, range and adjoining counter space will be combustible and will cause injury and damage if ignited. This condition may exist for an extended time period before the propane can reach the detector's location and be detected. The detector only indicates the presence of propane at the sensor. Propane may be present in other areas.

The detector is powered by the 12-volt DC system and is always powered as long as the camper is connected to the truck, a charged battery, or 120-volt AC power. The fuse for the detector is located in the Power Distribution Center.

NOTE: The detector is continuously powered; disconnect the battery if you are not using your camper. The detector can eventually drain the camper battery.

This page intentionally blank.

EQUIPMENT

SOME FEATURES DESCRIBED HERE DO NOT APPEAR ON ALL LANCE MODELS. SOME FEATURES MAY BE OPTIONAL ON YOUR MODEL.

After taking delivery of your Lance camper, spend some time familiarizing yourself with the exterior and interior features. Your interior has been designed with utility and comfort in mind to provide spaciousness and versatility. Familiarize yourself with the bedding and dining arrangements as well as the various storage areas inside and out.

ROOF

All Lance models have a fully decked and laminated roof that may be walked on from front to rear and are rated at 2,000 lbs. The top decking is a Thermalplastic Membrane. When walking on the roof use deck shoes as leather shoes become slippery and can also leave marks on the decking. When on the roof, use caution to avoid slips and falls. Use caution when loading sharp articles on the roof as you can gouge or puncture the roof. If you add accessories or new equipment on the roof, use a qualified installer, or consult your dealer. Care must be taken when working on the roof to avoid disrupting the seals which could void your warranty.

NOTE: The 650 Model reflects a “Lightweight” roof construction and is not designed for walking on and/or supporting of heavy load. For routine maintenance, such as servicing of sealants, etc., a 4’ x 8’ sheet of plywood should be used to disperse load over the roof structure near the area of service.

COMPARTMENT DOORS



Various exterior compartment doors provide access to certain appliances, controls, and general storage. Exterior compartment doors may not be water tight in all weather and road conditions. Any article which could be damaged by water or dirt should be carried inside the camper or truck.

Outside storage compartments are not sealed or vented enclosures and may be accessible from inside the camper. Do not store hazardous chemicals/ materials or flammable, volatile liquids in these areas.



The Water Heater Door provides access for service of the water heater.



The Propane Tank Compartment Door provides access to the storage propane tank(s) and regulator valve(s). This compartment door must remain unlocked as required by National Fire Protection Association (NFPA) to allow immediate access in case of a propane leak or fire. A large red propane label is located on the door to aid emergency personnel to rapidly locate the gas valve.



The Refrigerator Vent/Door provides access to the rear of the refrigerator for service and supplies inlet ventilation for proper operation.



The Bumper Hinged Door provides storage and convenient access to the waste drain hose and storage tray.



The Exterior Service Center Door provides access to waste tank dump valves, fresh water drain and winterizing valves.

VENTS

All exterior vents and louvers provide needed air circulation. Be sure not to block these vents because damage to equipment, as well as hazards to individuals could result.

ROOF VENTS



The roof vents are operated from inside and have built-in screens. To operate, turn the crank in the center of the vent clockwise to open and adjust. The bath vent may be equipped with a 12-volt exhaust fan. The switch to control the fan is located on the vent. These vents may be left slightly open while traveling, but be careful when traveling where vertical clearance is limited. Vent lids can crack if left open too far.

FANTASTIC ROOF VENT



The Fantastic high-volume power roof vent is designed to quickly exhaust stale hot air. Some models are equipped with a reversing fan that will also draw in fresh air. Due to the proximity of holding tank vents located on the roof, some models do not have this feature.

Operating Instructions:

1. Turn knob counter-clockwise to open vent approximately 3" or more (ceiling vent has a built-in safety switch that will not allow motor to operate unless dome is partially open).
2. Turn the 3-speed switch to desired performance level (O-off, 1-low, 2-medium, or 3-high).
3. Open a window or door for airflow. For best results, close all roof vents and open 1 (one) window the greatest distance from the ceiling fan.
4. Select desired temperature or comfort level on thermostat. Fan motor will start and stop automatically as interior temperature of camper exceeds or drops below selected level.

If equipped with a reverse switch

1. When equipped with a reverse switch, the fan motor must be turned off by:
 - a. Setting the 3-speed switch to "O"-Off.
 - b. Closing the dome.
 - c. Selecting the center position on the IN/OUT rocker switch.
2. Wait for fan blade to stop.
3. Selecting IN will bring air from the exterior into the camper (pressurizes inside).
4. Or selecting OUT will bring air in through any opening in the camper and exhaust through the vent to the exterior.
5. Turn fan motor "On".

HEKI MIDI SKYLIGHT



This skylight is dual pane and opens to three positions. It has a sliding screen and insulated shade.

To open

Depress the button and push the metal bar upwards. The vent has two open ventilation positions and a fully open position.

To close

Raise the metal bar up off the positioning tracks and push toward the rear of the vent, up over the button. The dome is automatically locked when closed.

The shade and screen operate independently of each other and are engaged by connecting to each other and sliding.

Close the skylight completely when traveling and leave shade partially open. The shade could pull up into the vent due to negative pressure in the camper. If camper is parked in extremely bright sunlight, leave shade partially open. If completely closed heat buildup can cause damage to the dome.

- Do not stand on the acrylic glass dome.
- Close the cover completely before driving off. Damage can occur to the shade if the shade is closed and the vent is open while driving.
- Remove any snow/ice or dirt before opening the roof.
- Do not open dome when it rains or when there is a strong wind.

CABOVER VENT



The cabover vent is operated from inside and has a built-in screen. It can be cranked open to allow for ventilation or by pulling on the red lever opened fully to allow access to the roof.

To open using the crank

Turn the crank in the center of the vent counter-clockwise to open and clockwise to close.

To open using the emergency handle

Pull the red lever toward the front of the vent and push the vent assembly upward to open.

EXTERIOR LIGHTING

Your camper is equipped with exterior lights not normally found on autos to comply with state and federal regulations. It's important not to alter the lights or the reflecting markers. Check the exterior lighting frequently and replace any inoperative or damaged lighting fixtures as soon as possible.

ROOF RAILS AND LADDER

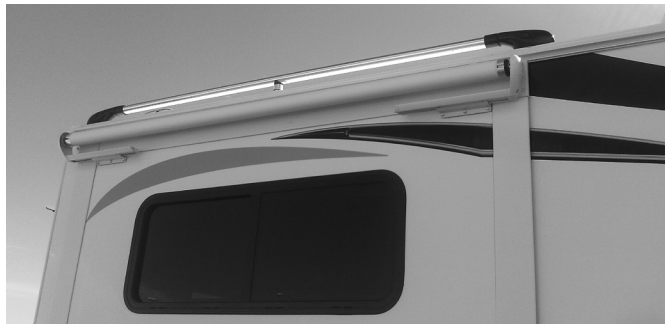

Most models are equipped with roof rails and a ladder. The roof rails are supplied with adjustable tie-down loops that can be used to secure light bulky items, such as lawn chairs.



Some models have the ladder located in front of a storage or generator access door. In order to gain access to the door, the ladder's lower section is hinged allowing it to swing up and be secured in place. Before using the ladder, it must be lowered and locked into the brackets

ROOF RACK SYSTEM



The optional towers and cross bars can be mounted to the roof tracks that allow other accessories to be added to accommodate transporting other items on the roof of your camper. Roof rail capacity with towers and cross bars is 300 lbs. Be sure to spread the load across the rails. Accessories for the crossbars are available from your Lance dealer or a local sporting goods retailer.

⚠ WARNING It is critical that all racks and accessories be properly and securely attached to your camper. Improper attachment could result in an accident or damage to your camper's roof. Check the attachments prior to use and periodically inspect for adjustments, wear and damage.

Large, long or oversize items will require additional strapping/tie downs. Do not underestimate the power of the wind.

ENTRY DOOR

The entry door lock and deadbolt are keyed alike. The key is double sided so it can be installed into the lock either direction. Be sure to write down the key number on the Identification Information Page located in the front of this manual. Your Lance Dealer can obtain duplicates with this number.



The entry door lock is locked by turning the key clockwise one quarter turn. The key can then be removed. To unlock, insert the key and turn counterclockwise one quarter turn. If the door is locked from the outside, it can still open it from the inside by pulling on the paddle handle. If you exit the camper and you close the door, it will be locked. The deadbolt is locked by turning the key counter-clockwise one quarter turn. The key is then returned to the starting position for removal. The deadbolt can be latched from the interior by turning the latch clockwise to lock and counter-clockwise to unlock.

Be sure all occupants in the camper know how to operate the entry door lock and deadbolt as well as the emergency exits in case of emergency.

When traveling, lock the deadbolt. This will reduce the possibility of the door opening while on the road.



Your camper may be equipped with a "Keyless" entry door lock with key fob. Instructional material outlining operation and programming reference can be found in the Owner's Information Package.

The screen door can be operated independently by releasing the catch on the screen door and swinging the screen door away from the main door.

WINDOWS

Windows in your camper are torque pane type. Windows are safety glass or Acrylic. Open window by turning the crank located at the bottom of the window frame, clockwise to open, counterclockwise to close.

EMERGENCY EXIT WINDOW



The emergency exit window is located in the cabover or dinette area of the camper and is identified by the red handle(s) and EXIT label.

Read and understand these instructions before you need to use them. The emergency exit window provides an escape route in case the camper must be evacuated under emergency conditions and the path to the main entry door is blocked.

To operate the emergency exit window, pull the red handle(s) and swing the window outward. The window is hinged at the top.

When parked, be sure the exit window is not blocked by trees or other obstacles.

The cabover skylight can also be used as an exit route.

AWNINGS



closing the awning, as well as maintenance and care instructions.

You should make sure your traveling companion is also familiar with the operation of the awning. If a sudden wind should come up, or if high winds are forecast, the awning should be retracted, stowed and the travel locks engaged. Awnings should be extended at an angle to encourage the run off of rain. Awnings damage such as a bent tube, torn canvas, or broken arms due to high winds or water standing on the canvas are not covered by warranty.

CAUTION Travel locks on all awnings should be engaged before traveling.

SLIDE-OUT COVER



The slide-out cover extends and retracts with the slide room. It helps to divert water off the slide room roof and helps in keeping the roof clean of debris. The room seal can become less effective or even damaged if the slide room roof is not kept clean.

EXTERIOR WASH STATION



The exterior wash station is located on the roadside of the camper. It provides both hot and cold water. It uses water from the fresh water tank or when connected to the city water hookup. The showerhead is equipped with a flow control to allow you to conserve water. The flow control is not a permanent shut off. After use, the water must be shut off at the control valves.

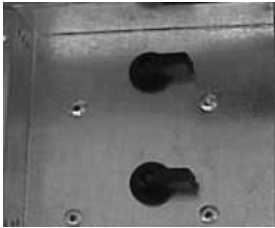

By-pass valves for the exterior wash station are located inside of the entry step, pull-out storage drawer on the left side, above the wash station, or in the lavy behind the toilet paper door.

CAMPER BUMPER/STEP



The aluminum bumper has sealed taillights, backup lights and an illuminated license plate location and storage for the sewer hose. Use the fold down step when entering or exiting the camper. The step can be mounted to the right of the entry for use when towing a boat or trailer.

Side Entry Step



Side entry models are supplied with a double entry step. To extend the double step, pull the complete step assembly out and let it down completely until the step feet come in contact with the ground. Then adjust the feet accordingly to provide a level step.

BACKUP CAMERA



The backup camera if equipped, is located in the center of the rear wall, directly below the center running lights. It is a color camera with a built-in microphone.

On the interior of the camper behind where the camera is mounted is a transmitter and 12-volt power switch. Be sure to switch off power when not using so you do not drain your battery.

The portable monitor that will be located in the truck cab has a 12-volt power plug and a built-in receiver.

INTERIOR STORAGE

Interior storage areas may be found in a number of places in your camper: overhead compartments, wall closets, under the dinette, under the bed, lavy and galley cabinets.

Some wardrobe cabinets are equipped with a 12-volt light that turns ON when the door is opened. If you experience some battery discharging, it could be that the light may not be OFF. Readjust the light striker to insure proper operation when the door is closed.

BATHROOM

The bathroom walls are sealed and waterproof; so do not worry if water splashes on it. Some models are equipped with a power roof vent in the bathroom.

TOILET

The toilet is designed to flush with a minimal amount of water and still provide for proper disposal and odor control. Toilet chemicals are available at most RV retail outlets. Review the manufacturer's owner's manual supplied with the toilet for proper use, maintenance and chemical usage. The toilet paper dispenser is mounted inside the lavy door under the sink. Information on the toilet plumbing can be found in the "Waste System" section.

CABOVER AREA

Do not allow anyone, children especially, to ride in the cabover area while traveling. Any sudden stops could result in injury.

GALLEY

The galley is designed for utility, convenience and comfort. All galley cabinets are equipped with positive locking latches, which prevent them from opening while traveling. Refer to the "Appliance" section for information regarding the appliances.

DINETTE CUSHIONS

The dinette cushions are reversible with a vinyl backing for use when sitting at the dinette with damp swimsuits or clothing.



DINETTE CONVERSION (DREAM TABLE)

To convert the dinette area into a sleeping area:

1. Locate the table locking lever hardware located on the underside of the table.
2. Rotate the lever clockwise 180 degrees. This will un-lock the table slide mechanism and enable the table to be lowered.
3. Pushing firm on the table top in a downward motion, lower table until it comes to rest on the dinette base cabinets.
4. Arrange seat and back cushions as shown in the picture below.

Reverse procedure to return the dinette to the seating position. Ensure the locking lever hardware is rotated 180 degrees counter clockwise to lock the table in position.



DINETTE CONVERSION (PEDESTAL TABLE)

To convert the dinette area into a sleeping area:

1. Remove table top and pedestal table leg. Store both table top and leg in safe place with exception for the 850 Model which the table top will be used for conversion process.
2. Using the provided dinette conversion inserts, (825 and 865 Models), table top (850 Model) and lower foot pedestal top (650 Model), position these on the dinette located supports.
3. Arrange seat and back cushions as shown in the illustrations below per your respective model.

Note: The 850 and 865 Models require use of a loose (floating) cushion which is not used during the seating arrangement, when converted to the sleeping arrangement.

Reverse procedure to return the dinette to the seating position.

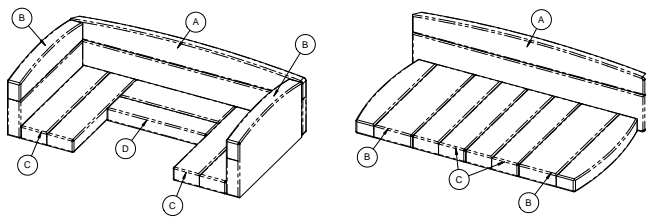

SEATING ARRANGEMENT

BED ARRANGEMENT

825 MODEL

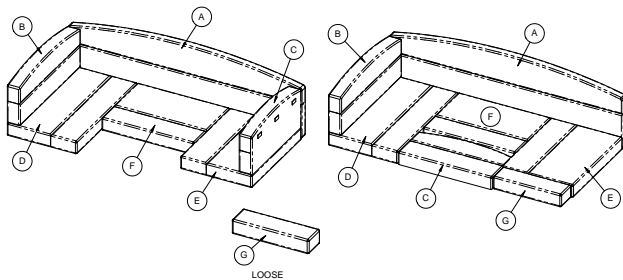

SEATING ARRANGEMENT

BED ARRANGEMENT

850 AND 865 MODELS

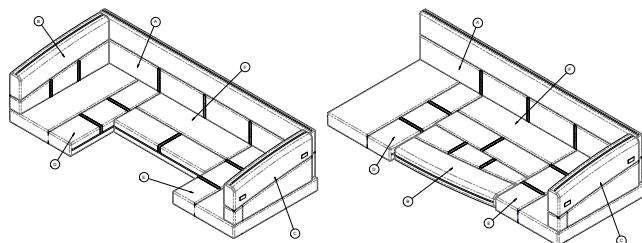

SEATING ARRANGEMENT

BED ARRANGEMENT

650 MODEL

DAY/NIGHT SHADES

The day/night shades are dual-purpose window covering that provides privacy at night and light control during the day.

To operate, pull down on the lower bar on either the day and/or night shade to position at the desired location. To re-track, give the lower bar a slight tug and release. The shades have a built in "slow-rise" feature which will return the shade to its fully open position.

MINI-BLINDS

To raise mini-blinds, release the bottom of the blind from the retainers. Pull straight down on the cord and release at desired height. It is not necessary to pull the cord to one side or the other to secure blind.

To lower mini-blinds, pull straight down on the cord slightly and move it about 45 degrees to either the left or right and lower the blind. To stop the blind in mid-travel, move it back to the straight down position. Re-attach the blind to the retainers when traveling.

To adjust the angle, turn the adjusting rod either direction.

FOLDING DIVIDER DOOR

The divider allows you to separate the cabover area from the main camper. It glides on nylon rollers. It is held closed by a catch. When the divider is open for traveling, be sure to attach the hold back latch to keep it from sliding back and forth.

FOLD DOWN BUNK AND CHILD RESTRAINT



The fold-down bunk is located over the dinette. To lower, pull the latches located at each end and lower the bunk. Flip the center section over to complete the lower platform. Unfold the child restraint and secure the top to the fasteners in the upper flange of the slideout. To store the bunk, reverse the procedure. The bunk is rated for 150 lbs.

ELECTRICAL SYSTEMS

The electrical system consists of a primary 12-volt DC system and a 120-volt AC system. The 12-volt system uses battery power similar to that used in automobiles. The 120-volt system requires a source of 120-volt power provided through the power supply cord or optional generator.

These systems are connected through a power converter. When connected to 120-volt power, the converter transforms 120-volt AC input into 12-volt DC power output and charges the storage battery(s) when installed.

12-VOLT DC SYSTEM

The 12-volt system provides power for the following components:

- Electric Jacks
- Interior Lighting
- Exterior Lighting
- Water Pump
- Power Range Hood
- Furnace Blower
- Refrigerator
- Water Heater Ignition
- Stereo/CD/DVD Player
- TV/Satellite Dish
- Systems Panel Monitor
- Fantastic Fan
- Power Vent
- Starting the Generator
- Slideout Room
- Accessories plugged into 12-volt outlet

BATTERY AND COMPARTMENT



Maintenance of your 12-volt battery(s) is essential for carefree travel. Be sure to use a heavy-duty, minimum 95 amp/hr. (160 RC), RV/Marine deep cycle battery. Certain models can accommodate two batteries. Ensure that they are both the same size and type battery. Check the battery(s) frequently with the condition meter located on the monitor panel. Also check the water level often. The use of a hydrometer is required to test for the specific gravity of the battery acid. Hydrometers are available through an auto parts store.

NOTE: The 12-volt battery(s) is not supplied with the camper by the manufacturer.

BATTERY TERMINOLOGY

Deep Cycle Batteries

The term “deep cycle” refers to a battery that has the capability of deeply discharging hundreds of times. How it differs from an automotive starting battery is that the automotive battery is manufactured to specifically provide a quick burst of energy thousands of times while only being able to deeply discharge less than 50 cycles during its lifetime. A cycle refers to one battery discharge and recharge.

Battery Ratings and Specifications

Marine/RV deep cycle batteries have rating specifications which include cold cranking amps (CCA), marine cranking amps (MCA), reserve capacity (RC) and ampere hours (Ah). RC and approximate Ah ratings may not be listed on the battery decal. However, they should be available through your local battery distributor.

Cold Cranking Amps (CCA)

The amount of current (amps) a battery at 0°F (-17.8°C) can deliver for 30 seconds and maintain at least 1.2 volts per cell (7.2 volts for a 12-volt battery).

Marine Cranking Amps (MCA)

The amount of discharge current a battery tested at 32°F (0°C) can deliver for 30 seconds and maintain at least 1.2 volts per cell (7.2 volts on a 12-volt battery).

Reserve Capacity (RC)

The amount of time a battery can deliver 25 amps at 80°F (26.7°C) without falling below 1.75 volts per cell (10.5 volts on a 12-volt battery). An approximate Ah rating can be attained by multiplying the battery's RC rating by 0.6. Example $180 \text{ RC} \times 0.6 = 108 \text{ Ah}$.

Ampere hours (Ah)

Tested at 80°F (26.7°C). It is the amount of current (in amps) a battery can deliver, multiplied by the amount of hours, without falling below 1.75 volts per cell (10.5 volts on a 12-volt battery). Most marine/RV deep cycle batteries are rated on a 20-hour discharge rate. Example: a 100 Ah battery can deliver 5 amps for 20 hours (amps x hours = Ah). The Ah rating is important when determining the type and amount of battery(s) required to meet your specific component needs.

BATTERY INFORMATION

The battery(s) must be securely strapped in the compartment at all times.

The battery(s) is charged by the truck's charging system while the truck is running or when connected to 120-volt power through the power converter. If equipped, the on-board generator charges the battery while running through the power converter.

Check that the battery liquid level is correct (weekly in warm climate, monthly in cold climate). Don't forget to also check the condition of your truck battery. Add distilled water as required. Clean battery terminals and cables periodically with a wire brush and baking soda. Be sure the caps are securely in place when cleaning. Ensure that the wing nuts on top of the battery are tight. Loose wing nuts can cause arcing and intermittent or loss of 12-volt power. Use caution not to touch battery terminals to metal doorframe when removing or installing the battery. Always disconnect the negative (-) cable first and reconnect it last.

Remove rings, metal watchbands, and other metal jewelry before working around a battery. Use caution when using metal tools. If the tool contacts the battery terminals or metal connected to them, a short circuit could occur which could cause personal injury or fire.

Do not allow battery electrolyte to contact skin, eyes, fabrics or painted surfaces. The electrolyte is a sulfuric acid solution that could cause serious personal injury or property damage. Wear eye protection when working with batteries.

BATTERY STORAGE PRECAUTIONS

When you store your camper for a week or more be sure to disconnect the battery(s). Electronic tuning radios, the propane detector, and the CO detector all draw a small amount of current when the battery is connected. Even disconnected batteries will naturally "self-discharge" about 1 % of capacity per day. If you intend to store your camper for any length of time, remove the battery(s). Store it in a cool, dry place and recharge every month. Batteries will discharge on their own. Recharging will also help prevent problems with battery sulfation which leads to premature battery failure.

BATTERY CHARGING

Normally the battery(s) will be kept charged by either the truck charging system while on the road, the roof mounted solar panel, or by the AC/DC power converter when plugged into AC service. On those occasions when the battery needs to be charged from a different charging source, please follow these safety guidelines:

Disconnect both cables to prevent damage to the camper's electrical system.

Do not smoke near batteries being charged or which have been recently charged. Please note that batteries are being charged while you drive, and while you are connected to 120-volt AC power through the power converter/charging circuit.

Use care when connecting or disconnecting booster leads or cables while charging. Poor connections are a common cause of electrical arcs that can cause explosions.

Check and adjust the electrolyte level before charging. Fill each cell to the indicator level with distilled water. Always remove the vent caps (if equipped) before charging the battery.

Never expose the battery to open flame or electric spark. Chemical action in the battery generates hydrogen gas that is flammable and explosive.

Before connecting the battery cables, turn off all electrical components to avoid sparks. Connect the **BLACK** cable to the **POSITIVE (+)** post on the battery. Connect the **WHITE** cable to the **NEGATIVE (-)** post.

NOTE: This is different than the automotive industry which uses red and black. There are fuses on the front of the power converter that will protect the camper's electrical system if you accidentally connect the battery in reverse.

The 40 amp main circuit breaker (located inside the camper inside of the pullout drawer storage at the stepwell) will not allow power into the camper or the battery(s) to be charged when an overload or short circuit occurs. To reset the breaker, disconnect and reconnect the white negative (-) cable from the battery. If your camper is equipped with a battery disconnect switch, Pushing the battery disconnect switch located on the monitor panel to "store" then "use" will accomplish the same. If the breaker continues to trip, a short circuit or overload condition is indicated. Have the system checked by your Lance Dealer.

BATTERY SEPARATOR



The battery separator eliminates the need to add an isolator to the truck electrical system. The Battery Separator is installed inside the camper where the truck electrical connector enters the camper. The Battery Separator allows both the truck and camper batteries to be charged from the truck alternator. The Battery Separator isolates the batteries, so that the truck battery will not be discharged from camper use. The Battery Separator will begin charging the camper

battery after the truck battery has reached 13.2 volts. If the drain on the truck battery is reduced below 12.8 volts, the Battery Separator will disconnect the truck battery from the camper circuit, thus protecting the truck battery from excessive drain.

BATTERY DISCONNECT SWITCH



SYSTEMS MONITOR PANEL



The systems monitor panel may incorporate controls and instrumentation for the water and holding tank levels, battery voltage level, water pump, water heater ignition, generator start and hour reading.

WATER PUMP CONTROL SWITCH

This rocker switch controls the demand water pump. The water pump is pressure sensitive and starts (with the switch ON) when a faucet is open, causing pressure in the line to drop. When the faucet is closed, pressure builds in the line and the pump stops.

MONITOR PANEL - LEVEL INDICATOR SWITCH(S)

When depressing the monitor switch, indicator lights for the black (waste), grey (sink) and fresh water tank will illuminate, indicating the existing condition of each component. The battery level is a digital display that reflects the battery voltage when the switch is depressed.

Erroneous indications when checking water levels can be caused by:

Water with low mineral content. Level is measured by a very low electrical signal traveling through the liquid. Some water that is low in mineral content may not conduct the signal properly. This condition may be

infrequent, but can exist. Check the panel reading when the fresh water tank is filled. Material trapped on the sides of the holding tanks may give a full reading when the tank is actually empty. Use of a spray to wash out the tank following dumping should help prevent this condition.

NOTE: If the sensor probes mounted in the tanks get coated with grease, the monitor panel may indicate falsely or not at all. Avoid pouring grease, oils, or similar substances down drains or the toilet. If this is unavoidable, the holding tank(s) should be washed out with a soapy water solution.

WATER HEATER IGNITION SWITCH

Your camper is equipped with a dual power (propane/120 volt) water heater with direct spark ignition (DSI). It will have a DSI switch to ignite the propane heater and a 120 volt switch to turn on the electric heating element in the water heater.

EXTERIOR LIGHT FUSE BOX 12-volt and Main Circuit Breaker



The fuse box contains fuses and a 40-amp circuit breaker that feeds power from the truck to the camper fuse panel, refrigerator, jacks, exterior lights and battery. When an overload or short circuit occurs, this breaker will not allow power from the truck into the camper.

The fuse box is located in the forward driver side front corner of the main floor. Circuit titles and fuse sizes are labeled.

To reset the breaker, disconnect and then reconnect the power connector to the truck. If the breaker continues to trip, a short circuit or overload condition is indicated. Have the system checked by your Lance Dealer.

CAMPER FUSE PANEL 12-volt Interior Circuits



A 12-volt interior fuse panel is installed in the Power Distribution Center to protect the interior circuits. Circuit titles and fuse sizes are marked inside the removable access door. If a fuse blows, locate and correct the cause. Turn off all lights and motors, and then install a fuse with the same rating. If fuses continue to blow, a short circuit is indicated. Have the system checked by your Lance Dealer.

FUSES

All the electrical circuits in your camper have fuses to protect them from short or overload. If something electrical in your camper stops working, the first thing you should check for is a blown fuse. Determine from the chart, or the diagram on the fuse panel, which fuse or fuses control that component. Check those fuses first, but check all fuses before deciding that a blown fuse is not the cause. Replace any fuses and check the component's operation.

Do not install fuses with amperage ratings greater than that specified on the label. Replacing a fuse with one that has a higher rating greatly increases the chances of damaging the electrical system. If you do not have a replacement fuse with the proper rating for the circuit, install one with a lower rating until you can replace it with the proper rated fuse.

If the replacement fuse of the same rating blows in a short time, there is probably an electrical problem with your camper. Leave the blown fuse in that circuit and have your camper checked by your Lance Dealer.

INTERIOR LIGHTING

The interior lighting operates on 12-volt DC power only. When connected to a 120-volt source or using the generator, the power converter transforms 120-volts to 12-volts. However; when not connected to 120-volts, the entire load of lights, water pump, exhaust fans, etc., is on your 12-volt battery(s). Use conservatively to minimize battery discharging.

Certain switched lights have lighted (red) switches. These would include the exterior porch lights, docking light and the bath light when it is switched from outside of the bath. These switches illuminate when "on" to remind you that the light is on.

SOLAR PANEL PRE-WIRE



The pre-wire solar panel connector is mounted on the side of the refrigerator roof vent of the camper and/or near the front of the camper. The mating connector is supplied in the loose parts box.

Two wires, 12ga blue (+) and 12ga white (-) run from this location, are looped in the cabinet next to the galley and terminate behind the battery compartment for future connection to the battery. The 12ga blue wire must be fused with a 10-amp fuse when a solar panel is installed.

SOLAR PANEL



The solar panel is mounted on the roof beside the cabover skylight over the cabover bed area. The panel plugs into the connector mounted on the refrigerator roof vent. Inside the cabinet next to the galley cabinet a voltage regulator is mounted. The panel wires terminate at the battery disconnect relay located inside of the storage tray opening in the stepwell. The 12ga blue (+) wire is fused with a 10-amp fuse and connected to the 40-amp circuit breaker. The 12ga white (-) wire terminates at the battery negative (-) post. The solar panel is designed to "trickle charge" your battery system. It is not intended to be a fast charger. It also cannot supply large amounts of current to operate 12-volt DC electrical equipment.

NOTE: Weather conditions will affect the charging rate of the solar panel. Refer to the solar panel manual supplied in your Owner's Information Package.

DOCKING LIGHTS



The Rear Docking Lights are operated either by the backup light circuit from your truck (when put into reverse) or manually with a switch located inside next to the entry door. There are three fuses in the system: the power fuse, which is located on the exterior fuse panel, the backup fuse, also located on the exterior fuse panel and the interior lighting circuit, which is circuit #4 on the power distribution center.

PARK/SAT DISH CABLE INLETS



The park/sat dish cable inlets are located on the driver's side of the camper. The park cable inlet allows for the connection from the campground cable service to the camper. The satellite inlet allows for the connection from a portable dish. Both cables terminate inside the camper at the primary TV location in a wall plate. If your camper is equipped with a TV antenna, the park cable is connected to the 12-volt/TV outlet. With the switch on the outlet in the "OFF" position, the park cable signal is sent through the outlet.

ROOF MOUNTED HDTV ANTENNA



The roof-mounted HDTV antenna is designed for reception of digital signals, as well as UHF and VHF channels. Consult the manufacturer's operation instructions for proper use. The TV jack outlet is located at the primary TV location. If you are dry camping, the booster switch should be turned "OFF" when not viewing the TV to prevent battery drain as the indicator light will use a small amount of current. If using a 12-volt TV, it may be necessary to also unplug it as some TV's use a small amount of power when not being used.



To use the TV antenna, turn "ON" the switch located on the TV jack. A light will show on the indicating the antenna booster is powered. There will be a small continual 12-volt current drain as long as the switch is on. Turning the switch "OFF" changes the TV jack from antenna operation to park cable and ceases the current draw.

NOTE: The 12-volt outlet adjacent to the TV jack is rated for 7.5 amps. DO NOT USE FOR HIGHER RATED APPLIANCES.

Positioning the antenna:

1. Turn on antenna power at wall mount plate.
2. Turn on SureLock Signal Meter power button on side of rotational knob enclosure.
3. Rotate attenuator dial fully clockwise.
 - Step 4 Note: LED lights will illuminate from left (next to power) to right. All LED lights may not illuminate depending on signal strength.
4. Depress button on rotational knob and rotate antenna until maximum number of LED lights illuminate on signal meter.
5. Rotate attenuator dial counter clockwise until last illuminated LED light flickers.
6. Rotate antenna to illuminate last flickering LED Light.
7. Repeat steps 5 and 6 to pinpoint signal reception.
8. Follow instructions for TV or converter box to scan for available channels.

TV ANTENNA/SATELLITE DISH COMBO



Units equipped with a satellite dish have an additional outlet located next to the TV jack. The satellite receiver will connect to this outlet. The system also comes with an Elevation Sensor. The satellite receiver manual will give you the correct elevation to set your dish to. Press the button on the Digital Display. If the antenna is in the travel position, the display will show "LL" for Low Limit. "HL" for High Limit will show when the dish is in the UP position. A 9-volt battery located on the back side of the display powers the Elevation Sensor. Crank the elevation handle to raise the antenna. Stop cranking when the readout displays the correct elevation for your location. Rotate the antenna VERY SLOWLY until the correct satellite signal is acquired. Before installing and connecting a satellite receiving system, be sure you are familiar with the components you intend to install, other hardware or components required, and how they are designed to work together. Always refer to the component manufacturer's installation/operation information before installing or operating a satellite system in your camper.

For operation of the TV or satellite antennas, see their operation manuals located in your Owner's Information Package.

SATELLITE DISH SELF-POSITIONING



Instructional material can be found in the Owner's Information Package.

LCD TV



If equipped, your camper may have a LCD TV. The unit runs on 12-volt.

Instructional material can be found in the Owner's Information Package.



EXTERIOR SPEAKERS

Your camper is equipped with exterior with exterior mounted speakers. The speakers are located on the curbside of the camper. The wiring for these speakers terminates at the stereo location. If a CD/DVD player is installed, the exterior speakers are connected to the "C" speaker control on the stereo.

120-VOLT AC SYSTEM

The 120-volt electrical system supplies power to the following components:

- AC to DC Power Converter
- 120-volt Outlets (interior and exterior)
- Refrigerator
- Roof Mounted Air Conditioner (optional)
- Convection Microwave Oven
- Water Heater

Never operate the 120-volt electrical system without a proper ground.

120-VOLT POWER CORD

Your camper is equipped with a heavy-duty power cord for connection to an external 120-volt, 30 amp rated service. The cord is commonly called the “shore cord”. The cord and plug are molded together to form a weatherproof assembly. Do not cut or alter the cord in any way. Do not remove the ground pin from the attachment plug. If you have to use an adapter to plug into an electrical service, make sure the ground is maintained.

WARNING

Shore power poses a risk of death due to electrocution.

Always use a grounded connection.

Never connect to an ungrounded source of shore power.

Never remove the “third prong” from the shore power plug.

WARNING

Risk of fire.

Connect only to source of correct voltage.

Do not overload electrical circuits.

Do not use an extension cord to connect to shore power.

Replace fuses with like rating.

Never use a two-conductor extension cord, or any cord that does not assure appropriate and adequate ground continuity. Use a 30-amp RV extension cord with a maximum length of 25'. Never plug the 120-volt cord into an ungrounded receptacle.

120-VOLT GENERATOR POWER

Campers that are generator ready or have a generator installed are equipped with an Auto Transfer Switch.



The Automatic Transfer Relay (ATS), relay will automatically switch to generator power when the generator is activated. When the power cord is connected to shore power, the relay switches to shoreline power. To operate the camper from the onboard generator, simply start the generator. After about a 20 second delay to allow the generator to stabilize, the relay will engage, transferring all of the 120-volt AC load to the generator.

POWER DISTRIBUTION CENTER



The power distribution center consists of 120-volt AC, 12-volt DC and the power converter. The 120-volt AC panel board containing a 30-amp main breaker and 15 and/or 20-amp branch circuit breakers. These breakers interrupt the power if the rated current is exceeded. If a breaker trips repeatedly, reduce the load on that circuit and have the system checked by your Lance Dealer.

Switching from 120-volt AC power to 12-volt DC power is automatic when the power cord is plugged in or the generator is on. This powers the 12-volt panel board and the connected circuits are protected by the installed fuses. Battery charging is automatic when plugged into 120-volt AC power. The converter has reverse battery circuitry to prevent damage if the battery is accidentally connected in reverse. There are two 30 amp ATC fuses located in the front of the converter, which are accessed by removing the louvered grill located next to the power distribution center.

These fuses protect the power converter from accidental shorting of the power cables at the battery or reverse polarity caused by accidental cross connecting the battery. Remember **BLACK is POSITIVE (+), WHITE is NEGATIVE (-)**.

The power converter has a cooling fan that will run at appropriate times to cool the converter.

NOTE: Should the converter shutdown during normal operation, heat may be the cause. The converter has a built-in automatic-reset thermal breaker that will reset after a cooling off period. If this occurs frequently, your dealer or qualified personnel should correct the problem. Be sure not to store items in front of the vent openings.

GROUND FAULT CIRCUIT INTERRUPTER



A Ground Fault Circuit Interrupter (GFCI) protects the bathroom, galley, and patio 120-volt receptacles. This device is intended to protect you against the hazards of line to ground electric faults and electrical leakage shocks possible when using appliances in damp areas.

NOTE: The GFCI device does not prevent electrical shock. It does not protect a person who comes in contact with both the "hot" and "neutral" sides of the circuit. It does not protect you against electrical overload.

TEST the GFCI at least once a month while operating on 120-volt AC power. To test the GFCI:

Push the TEST button. The RESET button should pop out, indicating that the protected circuit has been disconnected.

If the reset button does not pop out when the test button is pushed, a loss of ground fault protection is indicated. Do not use the outlet or other outlets on the same circuit. Have the camper electrical system checked out at an authorized Lance Dealer Service Center. Do not use the system until the problem has been corrected.

To restore power, push the RESET button.

NOTE: If the bathroom, galley or patio receptacles don't work, check the GFCI. Reset the button if necessary. If the GFCI continues to trip, have the camper electrical system checked at an authorized Lance Dealer Service Center or by a qualified electrician.

GENERATOR READY

The generator compartment is sized for an Onan RV QG-2500 Propane powered generator provided by Lance Camper Manufacturing Corp. Only qualified Lance Dealer personnel should complete the installation.

Do not use this compartment for the operation of a portable generator.

Generator ready condition includes: the vented compartment door (see caution note), 12-volt pre-wired remote start/stop switch with hour meter, 120-volt and 12-volt wiring and LP gas supply piping with a capped bulkhead fitting.

CAUTION: The generator ready access door has an insert panel installed behind the air inlet grill. This is to help keep most dirt, dust and moisture out of the compartment should it be used for storage. It is mandatory that this be removed when a generator is installed. Also prior to installing a generator, the compartment floor must be removed. Failure to do so will result in generator overheating and possible fire danger.

POWER GENERATOR



Before operating any generator, read and understand this section of the manual and the manufacturer's operating instructions for your generator.

Your camper may be equipped with an Onan propane powered generator, which will provide complete electrical self-containment when public utility 120-volt AC power is unavailable.

The voltage output of the generator is connected to an automatic transfer switching device which when the generator power plant is operating, power is available at all of the 120-volt power outlets in the camper, just as if the power cord were connected to an external source.

The generator circuit breaker provides circuit protection while in the "ON" operating mode. See the Onan Generator Manual for location.

The propane tank(s) supplies fuel to the generator and other gas appliances in the camper. Check propane level frequently to avoid running out of fuel.

NOTE: Refer to your Onan Generator Power Plant Owner's Manual provided in your Owner's Information Package for starting, operating, service and trouble shooting instructions.

To start the generator: Press the START/STOP switch to the start position and hold until the unit starts. Make sure that all electrical equipment is turned off prior to starting and that the propane valve is opened on the propane tank(s).

Always wait at least three minutes after starting generator before turning on or plugging in heavy electrical loads, such as the roof air conditioner and the convection microwave oven.

CAUTION: If the unit is slow to start, DO NOT hold the start switch in the START position for more than 10 seconds. Release the switch, wait 30 seconds minimum and then try again. This will help avoid overheating and damaging the generator starting system. If this fails to start the generator, consult the troubleshooting guide in the Generator Owner's Manual.

To stop the generator:

1. Turn off all electrical loads.
2. Let the generator run at no-load for a few minutes, to stabilize internal engine generator temperatures.
3. Place START/STOP switch in the STOP position.

GENERATOR OPERATING SAFETY PRECAUTIONS AND WARNINGS

Do not block the generator ventilating air inlets or outlets. The engine requires a constant supply of cooling air. Restricted ventilating air inlets or outlets can cause engine failure or fire from engine overheating.

Do not use generator-ventilating air for heating any interior living space. Ventilating air can contain high concentrations of lethal gases.

EXHAUST GAS IS DEADLY!

Exhaust gases contain carbon monoxide, an odorless and colorless gas. Carbon monoxide is poisonous and can cause unconsciousness and death. See the "carbon monoxide safety precautions" section in "on the road" chapter.

Protection against carbon monoxide inhalation also includes proper exhaust system installation and visual and audible inspection of the complete exhaust system at the start of each generator set operation.

Do not block the tailpipe or situate the camper in a place where the exhaust gases have any possibility of accumulating either outside, underneath, or inside your vehicle or nearby vehicles.

Outside air movement can carry exhaust gases inside the vehicle through windows or other openings remote from the exhaust opening. Operate the engine (s) only when safe dispersion of exhaust gases can be assured, and monitor outside conditions to be sure that exhaust continues to be dispersed safely.

Do not under any circumstances operate the generator while sleeping. You would not be able to monitor outside conditions to assure that generator exhaust does not enter the interior, and you would not be alert to exhaust odors or symptoms of carbon monoxide poisoning.

Do not operate the generator when parked in or near high grass or brush areas. Exhaust heat may cause a fire.

Do not use the generator as an emergency power source to a residential or industrial utility line. Such operation could cause death or serious injury to workers for utility companies. Such use is unlawful in some states.

Check the generator exhaust system after every eight (8) hours of operation and whenever the system or camper structure may have been damaged, and repair any leaks or obstructions before further operation.

Do not modify the generator installation or exhaust system in any way.

Disconnect the generator starting battery before performing any maintenance on the generator.

GENERATOR MAINTENANCE AND SERVICE

Specific maintenance requirements are outlined in the Generator Owner's Manual supplied with the camper. Follow these guidelines and/or refer to your Lance Dealer for assistance.

GENERATOR/ELECTRICAL COMPONENT INCOMPATIBILITY

Your generator has been carefully matched to the electrical components and appliances installed in your camper. Adding or changing the type of any electrical component to another type or size can cause an incompatibility with the generator circuitry. This can cause the generator or added component not to function properly.

LOADING THE GENERATOR

The generator can power AC motors, air conditioners, AC/DC converters and other appliances. How much load can be serviced depends upon the generator power rating, temperature and altitude. The generator will shut down or its circuit breakers will trip if the sum

of the loads exceeds the generator's power. Allow the air conditioner to operate on the thermostat setting. If manually operated, it may cause an overload condition.

Applying excessively high electrical loads may damage the generator and may shorten its life.

To avoid overloading the generator, add up the rated watts of all electrical lighting, appliance, tool and motor loads the generator will power at one time. This total should not be greater than the wattage capacity of the generator. If an electrical device nameplate gives only volts and amps, multiply volts time's amps to obtain watts (volts x amps = watts). Some electric motors require more watts of power (or amps of current) for starting than for continuous operation.

TYPICAL APPLIANCE LOADS

Appliance	Load (Watts)	Load (Amps)
Air Conditioner	1400-2000	12-17
Blender	600	5.50
Coffee Maker	550-750	4-6.50
Computer	50-100	.05-.90
Converter	300-350	2-3
Curling Iron	20-50	.20-.50
Electric Blanket	50-200	.50-1.50
Electric Frying Pan	1000-1500	8-13
Hair Dryer	800-1500	7-13
Iron	500-1200	4-10
Microwave	1000-1500	8-13
Refrigerator	600-1000	5-8
Television	200-600	1.50-4
Toaster	750-1200	6.50-10
VCR/DVD Player	150-200	1-1.50

POWER VS. ALTITUDE

Note also that air density decreases as altitude and ambient air temperature increase, causing the generator power to decrease. Power decreases approximately 3.5 percent of rated power for each 1000 feet of increase in elevation and 1 percent each 10°F (5.6°C) rise in temperature above 85°F (29°C).

Elevation above Sea Level	Maximum Power
Up to 500 feet	2500 watts (rated)
2500 feet	2325 watts
5500 feet	2063 watts
above 5500 feet	2063 watts minus 87 watts each 1000 ft

PROPANE GAS SYSTEM

Please observe the warnings and cautions contained in this section as well as the manufacturers supplied information with each gas appliance.

Propane is stored in a high-pressure tank in liquid form and is delivered to the appliances in a gaseous form. The propane container(s) must not be placed or stored inside a vehicle. The container(s) are equipped with safety devices that relieve excess pressure by discharging propane to the atmosphere.

BTU'S

One gallon of propane produces approximately 91,502 BTU's. Using the BTU rating of each gas appliance in your RV, you can determine about how long your supply will last according to your usage.

Dual 5 gallon propane bottles hold approximately 862,026 BTU's. Dual 7 gallon propane bottles hold approximately 1,294,840 BTU's.

Listed below is the rating of the appliances on your Lance camper:

Water Heater	8800 BTU	
Furnace	12000 BTU	
	18000 BTU	
	20000 BTU	
	15000 BTU low	Dual BTU Furnace
	22000 BTU high	
Refrigerator	1500 BTU	
Cooktop	9000 BTU large burner	
	6500 BTU small burners	
	5600 BTU oven	
Generator	31245 BTU ½ load	
	50638 BTU full load	
BBQ	7800 BTU	

SAFETY PRECAUTIONS

Propane is of course highly flammable and also heavier than air. It's treated to have a garlic like odor to detecting a leak. If a leak should occur, the propane can collect in pockets along the floor and thereby dissipate the air. If unnoticed, this could result in suffocation or an explosion.

⚠ DANGER IF YOU SMELL PROPANE

1. Extinguish any open flames, pilot lights and all smoking materials.
Do not touch electrical switches.
Shut off the propane supply at the tank valve(s) or propane supply connection.
Open door and other ventilating openings.
Leave the area until odor clears.
Have the propane system checked and leakage source corrected before using again.
2. Inspect the entire propane system for leaks or damaged parts before each trip.
3. Never check for leaks with an open flame. Use an approved leak detection solution or a non-ammoniated, non-chlorinated soap solution only. If the leak cannot be located, have the system checked by qualified personnel.
4. Always be careful when drilling holes or fastening objects to the camper. A nail or screw could puncture the propane supply lines.
5. Do not restrict access to propane tanks. In an emergency, the tank service valve must be easily accessible. Do not store items or block ventilation openings in the propane compartment.
6. Do not use any propane tanks other than those furnished with your camper.

Turn off main propane valve and individually turn off all propane appliances or electrically disconnect automatic ignition appliances before entering propane bulk plant or motor fuel service station. When not individually turned off, automatic ignition appliances may continue to spark.

Do not fill propane containers to more than 80 % capacity. Overfilling can result in uncontrolled propane flow that can cause fire and explosion. A properly filled container holds about 80 % of its volume as liquid.

7. Propane regulators must always be installed with the diaphragm vent facing downward within 45° of vertical to minimize vent blockage that could result in excessive propane pressure causing fire or explosion.
8. Do not use a wrench or pliers to close the service valve. This valve is designed to be closed leak-tight by hand. If a tool is required to stop a leak, the valve probably needs repair or replacement.
9. When attaching the hose connector to the valve, don't force, jam or cross-thread the fitting. Always check fitting for leaks after tightening.
10. Be sure the tanks are securely fastened whenever they are mounted on the camper.
11. Go to a Lance Dealer for any propane system repairs.
12. Always think safety.

FILLING PROPANE TANK

All new propane tanks must be purged of air and moisture before filling for the first time. The propane tanks should be filled according to the instructions on page 10 and on the tank safety labels.

Filling should be done only at authorized propane fueling stations. Please observe the following instructions when filling the storage tanks.

D.O.T. regulation #173-34 prohibits propane tanks from being refilled inside the RV. The tank(s) must be removed from the compartment to be properly inspected before refilling.

Use propane tanks in their proper position.

1. A small amount of anhydrous methanol (3/4 oz per 5 gal) can be added before filling an empty tank to prevent freeze ups. Check with your propane dealer or the propane tank manufacturer's information in the Owner's Information Package provided with your camper.
2. The law requires at least a 20% vapor space for safety. A special liquid level valve is installed in the tank to indicate when the tank has reached 80% of its volume as liquid propane. Stop filling when liquid appears at this valve.
3. Use vapor only. All propane appliances for cooking, heating, lighting, water heating, and refrigeration are designed to operate on propane vapor only. Therefore, all propane tanks designed for vapor service must be transported, installed and used in the proper position. Propane containers are permanently marked with "TOP" stamped on tank, welded to the tank or "ARROWS must point up" stamped in the guard or bracket to identify the proper position.
4. Do not transport, install or use a vertical cylinder in a horizontal or upside down position. Liquid propane could enter systems designed for vapor only, creating a hazardous condition.
5. Do not carry or store filled or empty propane containers inside your camper. Propane containers are equipped with a safety device that relieves excessive pressure by discharging gas to the atmosphere. Leaks can occur at valves and fittings. Always store propane tanks with the valves closed.
6. Always use the dust cap when transporting or storing disconnected tanks (full or empty).
7. All propane tanks must be securely attached in the proper position for intended use. Use all brackets provided to ensure proper support and positioning.
8. Route all propane lines carefully and avoid kinking the lines. A kinked hose can limit or cutoff the flow of propane through the system.

USING PROPANE SYSTEM

It is normal to have a slight gas odor when initially opening the outlet valve. Fully open and seat valve by hand only to prevent leakage past the valve stem. If an odor seems to linger perform a leak test.

Keep outlet valves closed when not using the propane system.

Do not attempt to adjust the regulator. The manufacturer has preset it. If any adjustment is required, a qualified propane service technician using special equipment must make it.

NOTE: The Owner's Information Package contains a helpful hints pamphlet about propane containers.

SINGLE PROPANE TANKS



Single propane tanks are equipped with a two-stage regulator. Be sure the regulator is securely fastened to the tank with the diaphragm vent facing downward. When using the tank, simply open the valve.

DUAL PROPANE TANKS



Dual propane tanks are equipped with a two-stage automatic changeover regulator, which transfers propane demand automatically to the second tank when the first tank becomes empty.

For proper operation, both outlet valves must be opened. Turn or slide the tank selector knob so it points to the tank you wish to provide service. A small glass window is located on the regulator. A clear or green band will appear in the window indicating that pressure is in the line from the tank. After all propane is used from that tank, the regulator will automatically switch service to the other tank, and a red band will

show in the window, with the arrow or slide pointing to the empty tank.

The empty tank can be removed for filling without disturbing the gas flow to the camper by rotating or sliding the tank selector to the full tank. The red band will disappear from the window indicating pressure supply from the full tank. Turn off the outlet valve on the empty tank before disconnecting.



1. Outlet Valve
2. Two Stage Regulator (Vent Facing Down)
3. Valve Connector

PROPANE AT LOW TEMPERATURES

Propane systems can and do freeze up in very cold weather. It is a common misconception that the regulator or the propane itself freezes. Actually, it is moisture or water vapor that gets trapped in the system or absorbed by the propane that freezes and causes the problem.

Where does the water come from? From a variety of sources. The propane can be saturated with water when it comes out of the gas plant or refinery unless care is taken to see that it is thoroughly dehydrated. The propane can absorb water while it is transported if the tank cars contain water; or the propane storage tanks may have water in them because moist air has been trapped in the tank because a valve was left open.

When this water freezes, the ice can build-up and partially or totally block the propane supply. There are a number of things you can do to prevent this freeze up.

1. Be sure the propane tank is totally moisture-free before it is filled.
2. Be sure the tank is not overfilled. This is also a safety consideration.
3. Keep the valves on empty tanks closed.
4. Have the gas tanks purged by the propane service station if freeze-up occurs.
5. Have the propane service station inject an approved antifreeze or de-icer into the tank(s).
6. Be sure you have the proper propane blend for your traveling area. If you have the proper propane blend, it is very unlikely that the propane is at fault.

If, despite precautions, you do experience freeze-up, try melting the ice by warming the regulator with a cloth soaked in warm water if available or regular tap water. **DO NOT USE AN OPEN FLAME.** If the problem persists, ask your propane supplier to service the tank or regulator as required.

COMBINATION CARBON MONOXIDE AND PROPANE LEAK DETECTOR



Refer to the section on Fire and Safety, page 36 on the operation of the Combo Carbon Monoxide & Propane Leak Detector.

EXTERIOR PROPANE CONNECTION



Your camper may be equipped with an exterior propane connector. This connector allows for the attachment of a portable barbecue that can use the camper's propane. **This connection is for a "low-pressure appliance". Regular portable BBQ's are not designed for low-pressure use.** Some portable BBQ's can be converted to low-pressure by changing the propane valve to a low-pressure valve.

PROPANE GAS FUEL SYSTEM

Propane gas systems are installed to operate a variety of appliances, such as stoves, refrigerators, heating units and electrical generators. The exhaust fumes from burning propane gas contain odorless and can cause death or serious brain injury if inhaled. The exhaust from propane appliances must be directed to the outdoors. You must have an operating carbon monoxide detector in the accommodation space of your camper.

DANGER

You can die or be brain damaged by Carbon Monoxide.

Make certain the exhaust from Propane appliances is directed to the outdoors.

Have a working carbon monoxide detector in the accommodation spaces of your trailer before operating any Propane gas appliance.

Do not operate portable grills, portable stoves, portable lanterns or portable heaters inside the trailer.

When used for the first time, or after a period of storage, the Propane gas lines will be full of air and must be purged of air, before the appliances will stay lit. Have the Propane gas lines purged by your Lance Dealer, or a Propane gas dealer.

A Propane gas system is designed to operate with a supply of Propane gas only, NOT natural gas. A natural gas supply is unsafe for the system's pressure regulation devices.

WARNING

Risk of death due to fire or explosion.

Do not connect a Propane gas system to a supply of natural gas.

Extinguish all pilot lights and turn off all appliances before refilling fuel or Propane gas tanks.

Do not fill the tank with any gas other than Propane.

Do not store Propane gas tanks inside the trailer.

Keep the shutoff valve on your Propane gas tank closed at all times, except when you are operating a Propane gas appliance. Before opening the Propane shutoff valve, turn off all Propane gas appliances. If an appliance is on when you open the shutoff valve, Propane gas can accumulate in the camper, which can result in an explosion.

Do not use a wrench to open or close the shutoff valve. If the shutoff does not completely stop the flow of Propane gas when it is hand-tightened, replace the shutoff valve.

Propane gas leaks can result in fire or explosion. If your camper is equipped with a Propane gas system, it must also be equipped with a Propane gas detector. The Propane gas detector will be located near the floor to detect the heavier-than-air Propane gas. If a leak is suspected, use a soapy water solution to search for the leak. Do not use a solution that contains ammonia or chlorine (common in window and other household cleaning compounds), because those chemicals will cause Propane piping corrosion.

WARNING

Risk of fire or explosion

If Propane gas is detected (by smell or by the Propane gas detector):

- **Do not touch electrical switches**
- **Extinguish flames and pilot lights**
- **Open doors for ventilation**
- **Shut off Propane gas supply at the Propane tank**
- **Leave the area until odor clears**

Correct the source of Propane gas leakage before using Propane appliances.

Do not use a flame to locate the source of a propane gas leak.

Propane gas is compressed into liquid form. Propane gas must be completely vaporized before being burned.

NOTICE

Propane gas will operate at temperatures as low as minus 44 degrees Fahrenheit (-44 F).

Propane gas is prohibited on some roadways, bridges and tunnels. Check a map and with Department of Transportation (or with the AAA) for travel routes that do not have such restrictions.

Propane Gas System Troubleshooting

- Having liquid “gas” at your appliance is an indication that the Propane gas tank is overfilled, or that the temperature is too cold.
- If your Propane gas appliances do not stay lit, it might be because your Propane gas system is contaminated with air or moisture. Many Propane gas vendors have facilities to purge the air from a Propane gas system.
- If your Propane gas system is not providing gas, even when the shutoff valve is open, it might be because the Propane gas regulator has frozen water in it.

WARNING

Risk of fire or explosion.

Never use a flame, heat lamp or hair dryer to thaw a Propane gas regulator.

Use an incandescent light bulb to warm the regulator.

Do not remove the regulator cover or attempt to service the Propane gas regulator.

This page intentionally blank.

APPLIANCES

Follow the operating and maintenance instructions supplied by the appliance manufacturer for safe and dependable use. The following information is supplied as only a supplement to that provided with each appliance. If you have a problem, see your local Lance Dealer or call the appliance manufacturer listed in the back of this manual.

LIGHTING PROPANE APPLIANCES

NOTE: New propane tanks or empty tanks that have been sitting with the valve open for a period of time must be purged of air and moisture prior to filling.

Air trapped in the propane lines may delay the initial lighting of any appliance. It could take several seconds or minutes for the propane to reach the appliance. To purge some of the air from the propane system, first light a burner on the range. The other appliances will then light more quickly.

The first time the furnace or oven is operated, paints and oils used in manufacturing may generate some smoke and fumes. If this occurs, open doors and windows to air out the camper. These materials should burn off in a short time. Always follow the appliance manufacturer's lighting and operating instructions.

REFRIGERATOR



The refrigerator operates on 120-volt AC power, propane and/or 12-volt DC. The operating instructions supplied in the Owner's Information Package will help you with detailed information from the manufacturer.

The recreational vehicle propane type refrigerator operates on the "absorption" principle and therefore must be reasonably level. When your camper is stationary, it should be leveled for comfortable living. If you can occupy the camper comfortably, the refrigerator unit should perform well. If the refrigerator unit is not "close to level", it may not function properly and your food will not be adequately cooled.

When the RV is in motion, the continuous movement will not affect operation. The operating instructions are printed inside near the controls and may be found in the manufacturer's instructions manual.

OPERATING TIPS

Operate the refrigerator on 120-volts for 8 to 12 hours (overnight) before you leave on a trip. This will allow the refrigerator and freezer to get cold and even have some ice ready.

Pre-cool food and drinks before putting them into the camper refrigerator.

For off-truck use, some refrigerator models must have 12-volt battery hookup to power the electronic controls.

Refer to the supplied appliance manuals for proper operating instructions.

RANGE-OVEN



The gas burners and oven use propane gas for fuel. Operation is similar to the range in your home. However, cook temperatures will vary from home ranges depending on the altitude.

Your range is equipped with a spark igniter for lighting the top burners.

The three (3) burner range is equipped with one (front) high output burner when additional heat is needed.

All propane ovens are equipped with a pilot light that must be lit before using the oven. Be sure to turn OFF the pilot when the oven is not needed or before traveling or refueling. For additional information, please refer to the operating manual supplied in your Owner's Information Package.

Before turning on the main propane supply, be sure all burner and oven control knobs are in the "OFF" position.

It is not safe to use cooking appliances for comfort heating. Do not use open flames to warm the living area.

Cooking appliances need fresh air for safe operation.

Before operation:

- 1. Open overhead vent or turn on exhaust fan.**
- 2. Open window.**

The warning label above has been located in the cooking area to remind you to provide an adequate supply of fresh air for combustion. Unlike homes, the amount of oxygen supply is limited due to the size of the recreational vehicle, and proper ventilation when using the cooking appliance(s) will avoid danger of

asphyxiation. It is especially important that cooking appliances not be used for comfort heating as the danger of asphyxiation is greater when the appliance is used for long periods of time. Never use portable fuel-burning equipment, including wood and charcoal grills and stoves inside the vehicle because a fire or explosion may result.

CONVECTION OR MICROWAVE OVEN



Please read all instructions that come with the convection or microwave oven before use. The oven should never be operated empty.

When operating on your generator (if equipped) power is limited. If the roof air conditioner is operating there may not be enough power to operate the microwave. Turn the air conditioner control to “fan only” setting to use microwave.



AUTOMATIC IGNITION WATER HEATER W/120-VOLT HEATING ELEMENT

Your camper is equipped with a fully electronic water heater, which has no pilot light, simply turn ON the water heater switch located on the monitor panel. The water heater will cycle on and off as needed. If the water heater fails to ignite, a red light on the panel will appear. Check to make sure you have adequate gas and battery supply. Move switch off and back on again.

Do not operate the water heater until it is filled with water.

Turn on the hot water at the galley sink, and when water flows continuously the heater is full. Occasionally you may experience “weeping” of the pressure/temperature relief valve. This is normal operation. It is caused by the normal expansion of the water while being heated. The tank is designed with an internal air gap at the top to reduce this weeping phenomenon. In time, though, the heating and expansion of the water will absorb this air. To replace the air and reduce relief valve weeping:

Wait until the water in the heater tank is cool before performing the following steps.

1. Turn off the water heater.
2. Turn off incoming water supply.
3. Open a faucet in the camper.

4. Pull the handle of the relief valve straight out and let water flow until it stops.
5. Release the relief valve handle and let the valve snap shut.
6. Turn on the water supply.
7. Close the faucet when water flows continuously without sputtering.
8. Turn on the water heater.

These procedures will re-establish the air pocket at the top of the tank. If the relief valve weeps again, repeat the above procedure.

CAUTION: Do not plug the pressure-temperature relief valve under any circumstances.

If the water heater will be “out of service” for some time, it should be drained. See “Storage” chapter for more information.

When using hot water faucets in the camper for the first time after heating water, open the valve slowly to reduce water splattering from pressure build up.

FORCED AIR FURNACE (Automatic Ignition)

The furnace is a forced air unit fueled by propane and electronically powered by 12-volts. A wall-mounted thermostat similar to those used in homes controls it. To start the furnace, set thermostat switch to the ON position and set desired temperature. The furnace will cycle on and off as needed. To stop the furnace, set the thermostat to lowest setting and the Off position. If your furnace does not operate properly, check the battery condition and propane supply.



CAUTION: The furnace will not operate properly if your stored personal items block the free flow of air at the registers or return air to the furnace.

The operating manual included in your Owner’s Information Package contains detailed operating and maintenance instructions.

During the initial lighting of a furnace, smoke and fumes may be created as a result of the burning off of manufacturing compounds. This is normal, however, the initial lighting should be done with windows and doors open and should be of adequate duration to completely burn off residue.

Portable propane appliances are not safe for heating inside the camper. Asphyxiation or carbon monoxide poisoning can occur.

ROOF MOUNTED AIR CONDITIONER



The roof-mounted Air Conditioner operates on 120-volt power, which is supplied through the 30-amp power cord, either from an outside 120-volt power service or by the onboard generator, if equipped. The factory installed air conditioner is a high efficiency, power saver unit that has been matched to the capacity of the generator (if equipped).

The air conditioner will provide cooled air for your comfort. However, it is the largest single load of electrical usage. It is important to manage your electrical usage when you have either an air conditioner or microwave oven installed or both.

1. Be sure air conditioner is OFF before connecting electricity.
2. When the air conditioner has been shut down, wait at least five minutes before restarting.
3. Do not operate without a filter installed.

Helpful Notes When Using the Air Conditioner

Keep window curtains closed.

Use kitchen vent fan when cooking.

Air conditioning removes moisture from the air and it is normal to have water discharge off the roof.

Experience has shown that some RV parks may experience reduced power (low voltage) on days with high heat or humidity, commonly referred to as a "brown out". This condition may result in the air conditioner circuit breaker tripping in your power distribution center. This protects your air conditioner motor from damage and is necessary during low voltage conditions. This breaker tripping is sometimes perceived as a fault in your camper, but it is a necessary "safety valve".

If your camper did not come with an air conditioner and you have a generator and you decide to add an air conditioner to your camper, Lance recommends that you consult your Lance Dealer for specific models of power saver, easy start units. Lance recommends that you have your dealer install the air conditioner unit on your camper for the best fit and leak prevention.

COMBINATION FURNACE/AIR CONDITIONER THERMOSTAT



The wall-mounted combination thermostat will operate either the furnace or air conditioner from one location.

The operating instructions included in your Owner's Information Package contain detailed operating and maintenance instructions.

Operating the air conditioner on the optional generator will use most of the electrical power available. Energy management is important when the air conditioner is operating. Care must be taken when turning on too many other 120-volt appliances. Experience will provide knowledge of how to operate the campers' electrical system the best.

This page intentionally blank.

FRESH WATER SYSTEM

Your Camper is outfitted with a system designed to provide fresh (potable) water service from an onboard water tank or a city water connection with a fresh water tank fill located on the roadside of the camper.

When connecting to the city water hookup, use only a non-toxic water hose, available at most RV supply stores. Since water pressures at campgrounds and household hookups vary, you should install an inline pressure regulator at the water supply faucet. This will protect both the camper water system and supply hose from excessively high water pressure.

WATER PUMP



CAUTION: The pump is not equipped with a dry tank shut-off switch. Turn the pump switch OFF if water in tank becomes depleted or when system is not in use. The pump operates when water pressure within outlet plumbing drops below a predetermined pressure. A drop in pressure occurs when a faucet or a toilet valve is opened. When the faucet is closed the pump shuts off as soon as the system is re-pressurized.

Turn the pump ON to pressurize the water system. When the faucet is opened, the water may sputter for a few seconds. This is normal and no cause for alarm. The water flow will become steady when all air is bled from the water lines. If a faucet is open slightly, allowing water to flow slowly, the pump may pressurize the plumbing faster than the water is released, causing the pump to cycle on and off.

A built-in check valve prevents back flow and protects the pump and fresh water tank from excessive city water system pressures. The pump operates at 2.8 GPM and 45 PSI. At free flow the pump draws

approximately 4 amps. A fuse in the power center protects the water pump circuit.

When traveling, always turn OFF the water pump. This will reduce the possibility of water flowing during travel. If the pump cycles on and off when no water is being used, you may have a partly open faucet, a leak in the water system or an empty water tank.

Never attempt to service the pump without first turning off the power and opening all faucets to relieve pressure in the water system. Consult the installation and operation manual for full details in the Owner's Information Package.

WATER TANK FILL



The fresh water system should be sanitized at the initial filling, after a period of storage or if contaminated. See "Sanitize Fresh Water System" in this section.

Fill tank slowly. Do not overfill. Do not leave unattended while filling. Structure damage may occur.

Filling the fresh water tank:

1. Close water tank drain petcock located at the rear or rear side of the camper.
2. Remove cap on fresh water fill inlet.
3. Using a 3/8" hose adapter, fill the water tank through the exterior fill spout slowly at a low volume until water overflows out the vent. Do not force water into spout since air in the tank must be released during filling. Do not put the potable water hose into the mouth of the fill.



3/8" Plastic Hose Adapter For Filling Water Tank

4. Set pump control switch to ON.
5. Open each faucet one by one until water flows evenly, and no air bubbles are evident.
6. Top off water tank through the exterior fill spout to replace water used in filling the water heater and purging the water lines of air.

7. Replace cap and lock the access door.

CITY WATER CONNECTION

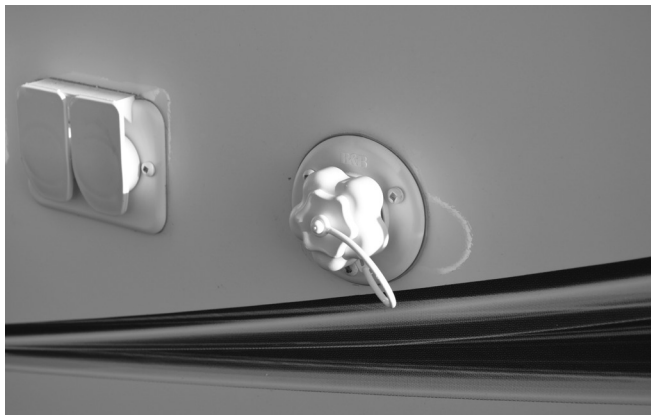

The city water inlet connection is located under the roadside overhang.

It's a good idea to purchase a pressure regulator to protect your camper from possible damage due to excessive water pressure.

To supply city water to your camper's water system and bypass the water pump:

1. Attach a potable water hose to the exterior city water inlet connection.
2. Pump switch should remain in OFF position.
3. Open each faucet until water flows evenly.

WATER SYSTEM DRAIN

The water system should be drained if it will be out of service for more than one week. This will prevent algae and bacteria contamination of your fresh water system.

To drain your camper:

1. The camper should be level and pump control switch in OFF position.
2. Open all faucets and showerhead.
3. Open water tank drain valve.
4. Open water line low point drains usually located in or under shower area.
5. Open water heater drain and relief valves. (See Winterization and Storage section for more information.)



SANITIZING FRESH WATER SYSTEM

Sanitize the fresh water system and piping at initial use, at least once a year and whenever the camper sits for a prolonged period. This will help keep the tank and lines fresh and will discourage the growth of bacteria and other organisms that can contaminate the water supply. Rinse the tank with a chlorine/fresh water solution as follow:

1. Drain water system. (See Drain Water System above).
2. Prepare a chlorine solution with one gallon of water and 1/4 cup household bleach.
3. Pour one gallon of solution for each 15 gallons of tank capacity into fill spout.
4. Fill tank with fresh water.
5. Open each faucet and water heater relief valve until water flows evenly.
6. Set pump switch to OFF.
7. Allow solution to stand for 3 hours.
8. Drain and flush with fresh water.
9. To remove any chlorine taste or odor, fill tank with one-quart vinegar to 5 gallons water. Allow solution to remain in tank several days if possible.
10. Drain and flush with fresh water.

WARNING

POTABLE WATER ONLY. SANITIZE, FLUSH AND DRAIN BEFORE USING. SEE INSTRUCTION MANUAL. FAILURE TO COMPLY COULD RESULT IN DEATH OR SERIOUS INJURY.

WATER FILTER



An in-line water filter attached to the inlet side of the water pump filters dirt, mineral scale, or organic matter out of the fresh water system. If you suspect a clogged filter, it is easily removed and cleaned.

Loosen the clamp at the inlet end of the filter. Pull the water hose off the filter. Unscrew the filter from the water pump. Turn each end of the filter and pull apart. Flush out and clean screen.

- Reverse procedure to install and check for leaks.
- Inspect the filter after the first 90 days of use, clean it if necessary, and inspect annually thereafter.

SHOWER

The showerhead is removable for hand-held use and equipped with a water flow control device to allow you to conserve water while showering. After showering, there may be some water discharge at the sink faucet. This water is draining from the shower hose through an anti-siphon valve in the faucet and is normal.

NOTE: For your protection, this faucet is equipped with a vacuum breaker (backflow preventer) to prevent contamination of your potable water supply. The water in the hand-held shower hose will drain through this vacuum breaker when the faucet is turned OFF. This is not a leak. This drainage is inherent in the design of the vacuum breaker, and is evidence that it is functioning.

Due to design precautions, hand held showerheads, when in the "hold" position must have a built-in leak rate of not less than 1 gallon per 30 minutes of time. This leakage is not a defect but is an attempt to reduce the possibility of scalding accidents due to temperature changes from fluctuating water pressure.

EXTERIOR WASH STATION



The exterior wash station is located in the service center on the roadside compartment for exterior use. It uses water from the fresh water tank or when connected to the city water hookup. The showerhead is equipped with a flow control to allow you to conserve water. This flow control is not a permanent shut off. After use of the shower, the water must be shut off at control valves or possible damage could occur to the showerhead and/or hose.

For severe weather camping, by-pass valves are provided to shut off the water to the exterior wash station to prevent the system from freezing.

This page intentionally blank.

WASTE SYSTEM

The waste holding system in your camper is made up of sinks, shower, toilet plumbing drain and vent lines, “gray water” holding tank, and “black water” holding tank. The holding tanks make the system completely self-contained and allow you to dispose of wastewater at your convenience. A flexible sewer hose is used to connect the holding tank outlet to the inlet of an approved wastewater dump station or sewer system.

The holding tanks are made of seamless plastic that will not corrode. On most units with dual tanks, one retains toilet waste and the other retains liquid waste from the sinks and shower. Drain all wastes at an approved site.

INSULATED AND HEATED WASTE HOLDING TANKS

To help keep the waste tanks and dump valves from freezing when using in below freezing temperatures, an insulated cover is installed to enclose the waste tanks and valves. When the furnace is in operation, warm air is discharged into the compartment.

NOTE: In extremely cold weather, non-toxic antifreeze should be added to both tank contents to provide the maximum protection.

FRESH WATER FLUSH TOILET

Your camper is equipped with a marine-type recreational vehicle toilet. This toilet is especially designed to operate with a minimum of water usage. The flushing mechanism, a hand-operated lever, allows a valve in the bottom of the bowl to open, permitting the contents to be flushed into the holding tank below. A stream of water under pressure from the camper’s water system swirls around the bowl, cleaning and flushing the contents. Most models have two levers, each working independently of the other so the bowl can be filled with water prior to use. For additional information, please refer to the operating manual supplied with the toilet.

NOTE: The toilet requires a water supply for proper use. This can be from either a city water hookup, if available, or from the on board fresh water tank supply. The 12-volt water pump switch must be in the “ON” position when using water from the tank.

BLACK WATER HOLDING TANK

This holding tank must be primed with 2 gallons of water and one odor control chemical package at each initial use. Add more odor control chemical if needed until dumping is required. Refer to the chemical package available at most RV outlets for specific instructions.

DUMPING THE HOLDING TANKS

The holding tanks terminate in a valve arrangement that permits each tank to be dumped separately or together. The valves are called “knife valves”. A blade closes the opening in the sewer drain pipes. The blade is connected to an extension handle that is pulled to release the contents of the tank(s).



During self-containment use, the sewer outlet line should be securely capped and valves closed to prevent leakage of waste material on the ground or pavement.

Holding tanks are enclosed sewer systems and as such must be drained into an approved dump station. Both black and gray water holding tanks must be drained and thoroughly rinsed to prevent accumulation of harmful or toxic materials.

Dump the holding tanks only when they are about 2/3 full. If necessary, fill the tanks with water to 2/3 full. This provides sufficient water to ensure complete flushing of waste material into the sewer line. Whenever possible, dump the holding tanks before traveling.

The holding tanks outlet is set up to be used with a removable fitting that locks onto the outlet with a clockwise twist. The sewer drain hose is clamped on this fitting when you need to drain the holding tanks. When you are operating self-contained, or you store the camper, install the protective cap in place of the removable hose.

The sewer (dump) hose is compressed and stored in the camper’s hose carrier.

When you want to drain the holding tanks:

1. Attach the sewer hose to the dump outlet.
2. Extend the hose and insert the hose end into the sewer or dump station inlet, pushing it firmly into the opening to be secure. In some cases, adapters may be necessary between the hose and inlet.
3. Arrange the sewer hose so it slopes evenly and is supported to maintain the slope.
4. Dump the black water holding tank first. Grasp the handle of the black water knife valve firmly and slide the valve open with a steady pull.

5. Allow enough time for the tank to drain completely. Rinse and flush the tank and drain hose through the toilet with a bucket of water or a hose.
6. When the tank flow stops, push the handle in to close the valve.
7. Pull the handle for the grey water holding tank. Repeat steps 4 through 6. This tank is dumped last to aid in flushing the outlet and drain hose.
8. Remove the sewer hose and replace the outlet cap.
9. Rinse out the sewer hose with fresh water and remove the sewer hose from the dump station.
10. Replace sewer or dump station cover(s).
11. Store the sewer hose.

NOTE: To facilitate draining, the camper should be slightly higher in the front and raise the passenger side of the camper to drain towards the driver's side.

If you are parked at a site with a sewer hookup, keep the black water knife valve closed to allow the waste level to build up. The outlet will probably clog if you leave the knife valve open continually. Run enough water into the tank to cover the bottom. This will aid the break up of solid wastes. The gray water knife valve may be left open.

HOLDING TANK CARE/ MAINTENANCE

Since holding tanks don't rely on any sophisticated mechanical devices for their operation, they are virtually trouble-free. The most common problem is also an unpleasant one, clogging. You can minimize chances of clogging by keeping the following considerations in mind:

- Keep the black water tank knife valve closed. Be sure to cover the tank bottom with water after dumping.
- Movement while driving will help liquefy the solids.
- Use only toilet tissue formulated for use in septic tank or RV sanitation systems.
- Keep both knife valves closed and locked, and the drain cap tightly in place when using the system on the road.
- Use only cleaners that are approved for use in septic tank or RV sanitation systems.
- Use a special holding tank deodorant chemical approved for septic tank systems in the black and gray water holding tanks. These chemicals aid the breakdown of waste and make the system much more pleasant to use.
- Do not put facial tissue, paper, grease, ethylene glycol-based or other automotive antifreeze, sanitary napkins or household toilet cleaners in the holding tanks.
- Do not put anything solid in either tank that could scratch or puncture the tank.

If the drain system does get clogged:

Use a hand-operated probe to loosen stubborn accumulations. Seriously clogged P-traps may require disassembly. Be careful not to over tighten when reassembling.

Do not use harsh household drain cleaners. Do not use motorized drain augers.

Sometimes the holding tank valve will get clogged. In this case, a hand-operated auger may be necessary. Be ready to close the valve quickly once the clog is cleared. If the seal gets damaged, it must be replaced.

BLACK TANK FLUSH



With the knife valves open, attach a garden hose to the tank flush inlet located on the driver side skirt area. The inlet connects directly to the flushing system to flush your black holding tank. A jet head placed in the tank is designed to spray water in a fan like pattern will give maximum coverage to flush tank and clean probes of the majority of residue. Turn on the water supply to the garden hose and allow the water to run for approximately three minutes to flush tank. Turn off the water supply, disconnect the hose and close the knife valves.

CAUTION

Do not use the same hose you use for filling the potable water tank or for the connection to the city water inlet. Use a different hose to insure that you will not contaminate your fresh water supply.

SLIDE-OUT ROOM SYSTEM (Rack and Pinion)



The slide-out room uses a rack and pinion mechanism to move the room. The pinion gears are driven by a 12-volt DC electric motor by the camper battery(s). The electric jack controller operates the slide-out room.

Note: On models reflecting use of multiple slide-out rooms, do not extend and/or retract rooms at the same time, as it may overload electrical circuit draw.

SYSTEM OPERATION

During the extension or retraction of the slide-out you may hear some noises that are associated with the electrical motor, mechanical system or the room sliding by the seals. These sounds are normal. Some of the slide-out components need a “break-in” period so they can seat properly. After a dozen or so room cycles, these break-in noises should decrease. Please note that some noises associated with the electrical and mechanical systems will always be noticeable during slide-out operation. If very loud noises occur, contact your Lance Dealer.

When the slide-out room is extended outside of the camper, elements such as rain, snow, dirt or other debris may cling to the outside surfaces of the room and could affect the function of the slide-out room. When the room is retracted, material clinging to the exterior surfaces may be brought into the camper. Always check the exterior surfaces of the slide-out room before retracting it. Remove excess water, snow, dirt, or other debris. Ensure that the outside surfaces are as clean and dry as possible.

The seals around the outside of the slide-out are not designed to act as a squeegee. Do not depend on them to remove water.

NORMAL OPERATION

Read and understand this section of the Owner's Manual to avoid injury and/or property damage. Keep people and objects clear of the slide-out room during operation.

The camper must be level before operating the slide-out room.

Remove any obstructions that may restrict the slideout room movement.

Before extending or retracting the slideout room, open a vent, window or door. The operation of the slide-out room can create enough vacuum or pressure to damage windows or doors.

CAUTION

DO NOT MOVE THE CAMPER WITH THE ROOM EXTENDED.



Operation of the slide room is by the electric jack remote.

The remote will control either “Jacks” or “Aux Motors” such as the slide room, if equipped.

To operate the remote:

- Activate the remote control by pressing the “In/Out” buttons. A green LED will indicate the remote is activated.
- To extend slide room, press the “Out” button.
- To retract slide room, press the “In” button.

MANUAL OVERRIDE OPERATION



The slide-out room system can be overridden to extend or retract the room in case there is an electrical power interruption or failure, or other system malfunction. During manual operation of the slideout, the confined working quarters can cause pinch and crush hazards. Ensure that the slide out path is clear of obstructions in the interior of the camper. If the slide-out room will not move when the switch is engaged, check the following:

The battery is connected and fully charged.

The power fuse located on the electric jack control unit in the cabover step is not blown.

There are no other obstructions in the room's path.

The camper is level and not in a rack or twisted position.

The override switch is in the "On-Locked" position.

Located generally near the entry door is a manual over-ride switch. Turning this switch to the Off/Unlocked position will let the electric slide motor turn easier. This will allow you to crank the room in or out. After the room has been extended or retracted, turn the switch back to On/Locked position.

CAUTION

Failure to re-engage the manual override switch could cause the slideout to move during use or in transit.

When fully retracted contact your Lance dealer for service, if required. When the motor is disengaged, the slideout room **WILL NOT** lock in place. It will not be sealed from either the interior or exterior. When the room has been fully retracted, be sure to re-engage the motor to seal and lock the room.

ELECTRICAL SYSTEM MAINTENANCE

Disconnect all power sources before performing any service work on the system. This includes the 120-volt AC power to the converter, the battery and the connection between the trailer and the tow vehicle.

The slide-out room system requires a minimum battery voltage of 12-volts. Be sure the battery is fully charged for best performance.

Maintain the battery as outlined in the Battery Section under Electrical Systems. Check the terminals and other connections at the battery, fuse panel and the control switch. Be sure the connections are tight, clean, undamaged and corrosion-free.

MECHANICAL MAINTENANCE

The slide-out room mechanism is designed to be virtually maintenance free. During long-term storage, apply a seal dressing such as 303© Protectant to the slide-out room seals. 303© Protectant is available at most RV or auto parts supply stores. This dressing will also lubricate the seals and make it easier to extend and retract the slide room.

SYSTEM TROUBLESHOOTING

The camper body, the slide-out room and the slide-out room mechanism make up a slide-out room system. Each needs to function properly with the others. Every unit has its own characteristics. Symptoms of malfunction may appear to be the same, but troubleshooting and fixing a problem must include a thorough check of all the interrelated components. When something restricts room travel, the drive mechanism is designed to stop. If the room is restricted, the system may put undue pressure on the camper body, slide-out room or mechanism. The room may not seal properly and the obstruction may cause fatigue and premature system failure.

Before troubleshooting the system or contacting an authorized Lance Service Center, make sure the battery is fully charged and there are no obstructions to room movement.

ELECTRICAL TROUBLESHOOTING

There are no field serviceable parts in the motor or control system, therefore electrical troubleshooting and service by the owner is limited to thorough checking of wiring and connections, checking the fuse at the fuse box and proper battery maintenance. Contact your Lance Dealer for any other service requirements.

SLIDE-OUT ROOM SYSTEM (Schwintek In-Wall)



The slide-out room uses an in-wall mechanism to move the room. The mechanism is driven by two (2) 12-volt DC motors by the camper battery(s). The electric jack controller operates the slide-out room.

Note: On models reflecting use of multiple slide-out rooms, do not extend and/or retract rooms at the same time, as it may overload electrical circuit draw.

SYSTEM OPERATION

During extension or retraction of the slide-out you may hear some noises that are associated with the electrical motor, mechanical system or the room sliding by the seals. These sounds are normal. Some of the slide-out components need a “break-in” period so they can seat properly. After a dozen or so room cycles, these break-in noises should decrease. Please note that some noises associated with the electrical and mechanical systems will always be noticeable during slide-out operation. If very loud noises occur, contact your Lance Dealer. When the slide-out room is extended outside of the camper, elements such as rain, snow, dirt or other debris may cling to the outside surfaces of the room and could affect the function of the slide-out room.

When the room is retracted, material clinging to the exterior surfaces may be brought into the camper.

Always check the exterior surfaces of the slide-out room before retracting it. Remove excess water, snow, dirt, or other debris. Ensure that the outside surfaces are as clean and dry as possible.

The seals around the outside of the slide-out are not designed to act as a squeegee. Do not depend on them to remove water.

NORMAL OPERATION

Read and understand this section of the Owner’s Manual to avoid injury and/or property damage. Keep people and objects clear of the slide-out room during operation.

The camper must be level before operating the slide-out room.

Remove any obstructions that may restrict the slide-out room movement.

Before extending or retracting the slideout room, open a vent, window or door. The operation of the slide-out room can create enough vacuum or pressure to damage windows or doors.

CAUTION

DO NOT MOVE THE CAMPER WITH THE ROOM EXTENDED.

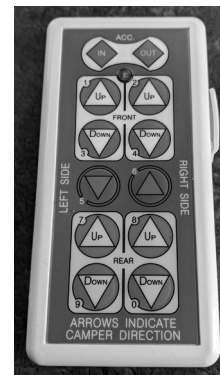

Operation of the slide room is by the electric jack remote.

The remote will control either “Jacks” or “Aux Motors” such as the slide room, if equipped.

To operate the remote:

- Activate the remote control by pressing the “In/Out” buttons. A green LED will indicate the remote is activated.
- To extend slide room, press the “Out” button.
- To retract slide room, press the “In” button.

MANUAL OVERRIDE OPERATION

The slide-out room system can be overridden to extend or retract the room in case there is an electrical power interruption or failure, or other system malfunction. During manual operation of the slideout, the confined working quarters can cause pinch and crush hazards. Ensure that the slide out path is clear of obstructions in the interior of the camper.

If the slide-out room will not move when using the remote, check the following:

The battery is connected and fully charged.

The power fuse located on the electric jack control unit in the cabover step is not blown.

There are no other obstructions in the room's path.

The camper is level and not in a rack or twisted position.

In the event that the slide-out room fails to operate after review of the troubleshooting steps mentioned above, proceed with the following:

1. Locate the control board.
2. Un-plug both motors connectors at control board.
3. The slide-out room may now be pushed in or out as desired. Larger slide-out room(s) may need several individuals to push. When pushing the slide-out room, push both sides equally to ensure the slide-out room remains even. Once slide-out room is fully retracted or in, plug both motors connectors back in at the control board, this applies a brake to the motor and keeps the slide-out room locked in position.



CAUTION

DO NOT MOVE THE CAMPER UNLESS THE MOTORS ARE PLUGGED IN AT THE CONTROL BOARD.

ELECTRICAL SYSTEM MAINTENANCE

Disconnect all power sources before performing any service work on the system. This includes the 120-volt AC power to the converter, the battery and the connection between the camper and the truck.

The slide-out room system requires a minimum battery voltage of 12-volts. Be sure the battery is fully charged for best performance.

Maintain the battery as outlined in the Battery Section under Electrical Systems. Check the terminals and other connections at the battery, fuse panel and the control board. Be sure the connections are tight, clean, undamaged and corrosion-free.

MECHANICAL MAINTENANCE

The slide-out room mechanism is designed to be virtually maintenance free. During long-term storage, apply a seal dressing such as 303[®] Protectant to the slide-out room seals. 303[®] Protectant is available at most RV or auto parts supply stores. This dressing will also lubricate the seals and make it easier to extend and retract the slide room.

SYSTEM TROUBLESHOOTING

The camper body, the slide-out room and the slide-out room mechanism make up a slide-out room system. Each needs to function properly with the others. Every unit has its own characteristics. Symptoms of malfunction may appear to be the same, but troubleshooting and fixing a problem must include a thorough check of all the interrelated components. When something restricts room travel, the drive mechanism is designed to stop. If the room is restricted, the system may put undue pressure on the camper body, slide-out room or mechanism. The room may not seal properly and the obstruction may cause fatigue and premature system failure.

Before troubleshooting the system or contacting an authorized Lance Service Center, make sure the battery is fully charged and there are no obstructions to room movement.

ELECTRICAL TROUBLESHOOTING

There are no field serviceable parts in the motor or control system, therefore electrical troubleshooting and service by the owner is limited to thorough checking of wiring and connections, checking the fuse at the fuse box and proper battery maintenance. Contact your Lance Dealer for any other service requirements.

GENERAL MAINTENANCE

This section explains why it is important to keep your camper well maintained, how to preserve the appearance of the exterior and interior and to follow basic maintenance safety precautions. Also included are several things you can do to help prevent corrosion. This section also includes Maintenance Schedules for when service should be performed on your camper and instructions for simple maintenance tasks you may want to take care of yourself. Regularly maintaining your camper is the best way to protect your investment. Proper maintenance is essential to your safety and will also reward you with many years of trouble-free use of your camper.

The Maintenance Schedules specifies how often you should have your camper serviced and what things need attention. It is essential that you have your camper serviced as scheduled to retain its high level of safety and dependability.

EXTERIOR MAINTENANCE

Some exterior parts of your camper are made of fiberglass, metal, rubber and plastic materials. The finish on these parts is durable, but not indestructible. Any material and finish will deteriorate over time. Exposure to sunlight, moisture, and airborne pollutants can chemically alter the composition of the base and finish materials and cause dulling and fading of the finish. Generally, changes in the finish due to weathering are cosmetic. They are on the surface of the part and do not affect its strength.

The best insurance against these effects is routine maintenance. If the finish is not washed thoroughly and waxed, the surface can deteriorate very rapidly. The following guidelines can help you reduce these weathering effects:

Wash the exterior at least once a month using a mild liquid detergent. Never use strong abrasives to clean the exterior surfaces. Wash your camper in a shady area, not in direct sunlight. If the camper is parked in the sun, move it into the shade and let the exterior cool down before you start. Chemical solvents and strong cleaners can damage the siding, roofing, metal and plastic trims on your camper. Rinse the camper thoroughly with cool water to remove loose dirt. Fill a bucket with cool water. Mix in a mild detergent, such as dishwashing liquid or a product made especially for auto or RV washing. Wash the camper using the water and mild detergent solution and a soft-bristle brush, sponge, or soft cloth. Start at the top and work your way down. Rinse frequently. Check the surface for road tar, tree sap, etc. Remove these stains with tar remover or turpentine. Rinse it off immediately so it

does not harm the finish. Remember to re-wax these areas, even if the rest of the camper does not need waxing. When you have washed and rinsed the whole exterior, dry it with a chamois or soft towel. Letting it air-dry will cause dulling and water spots. As you dry your camper, inspect around the seals and repair as necessary.

Wax the exterior at least once a year, preferably twice. Use automotive waxes or cleaners/polishes developed for use on fiberglass boats, showers and tubs. Be sure to follow the directions on the wax container. Some cleaners and waxes are recommended for use on only certain types of surfaces. Exterior streaking is reduced with more frequent waxing. Do not use abrasive cleaners or rubbing compounds. Always wash and dry the whole camper before waxing it. Rubbing alcohol can be used on caulking that show signs of yellowing.

You should clean your roof at least four (4) times a year. For normal cleaning use a mild liquid detergent and water mixture, or Murphy's Oil Soap™ with a soft nylon brush or sponge. Do not use solid or granulated cleaners, as they will mar the finish. For more difficult stains, use a cloth dampened with mineral spirits. DO NOT use mineral spirits in a large area or allow it to soak into the roof membrane.



CAUTION

ROOF IS SLIPPERY WHEN WET.

EXTERIOR GRAPHICS

The pressure sensitive vinyl graphics installed on the exterior surface of your camper require little maintenance and should be treated similarly to a painted surface. The following cleaning and maintenance recommendations should be followed to ensure the maximum appearance and performance of your exterior graphics.

Wash your graphics with the same solution as noted above for washing the exterior of your camper. Be sure to rinse thoroughly.

Test any cleaning solution on a small section of the graphic before using the cleaning solution on a larger surface. A non-abrasive cleaner, suitable for high quality painted surfaces, is recommended. The cleaning solution should be neither high acidic nor highly alkaline; a pH range of 3 to 11 is recommended. The cleaning solution should be free of strong solvents or alcohol. Avoid contact of window cleaners that contain ammonia.

DAMAGE CHECKS

It is important to periodically check the exterior for damage. Pay particular attention to the following areas:

- Waste tanks and plumbing lines.
- Propane tanks and assembly.
- Sealant around doors, roof, vents and windows.
- Exterior lighting.

SEALANT RENEWAL

The adhesives and sealants used in the construction of your camper were developed to remain waterproof under sustained effects of weather and vibration. However, even the finest materials will eventually dry out and lose their effectiveness under the constant heat of the sun, attack by other elements and road vibration. This section outlines the procedures that you must follow to maintain the weather-resistant integrity of your camper. Leak damage caused by neglecting to follow these procedures may affect your warranty.

Your Lance Dealer can perform the resealing inspection and work for you, and has current information on sealants used in your camper and can recommend the appropriate sealants if you prefer to do this work yourself. Always use the recommended sealants.

To protect your camper from possible water intrusion damage, your unit should be inspected thoroughly and resealed bi-annually. Inspect the sealant around the roof moldings, windows and doors at least every six months. If any of the following are evident during inspection, the affected areas must be resealed:

Weathering or drying of sealant.
Sealant cracked or peeling.
Voids in sealant.
Shrunken or separated sealant.

Clean all areas to be resealed with mineral spirits. Make sure that all areas to be resealed are absolutely dry before new sealant is applied.

Mineral spirits is a flammable liquid. Use extreme care when handling. Do not expose to open flame, sparks, or smoking materials. Do not use in unventilated areas.

Check and tighten any loose fasteners. Be careful not to over-tighten, or stripping will occur.

If you find any of the above:

If areas on the roof need to be resealed, remove any loose or cracked sealant being careful not to damage the roof. Use a wooden or plastic scraper that will not

gouge, pierce, or otherwise damage the roof. The roof can be cut or punctured by sharp objects.

Apply the new sealant in a continuous bead along the seams and flanges, being careful not to leave any voids. Apply enough sealant to flow over the heads of all fasteners.

Allow at least 48 hours for the sealant to set completely (firm and tack-free when pushed with the thumb) before washing or waxing the camper.

DOORS AND WINDOWS

Lubricate door hinges, locks and window mechanisms periodically with powdered graphite. Clean window frames and tracks to ensure easy operation. Clean the glass windows, inside and out, with a commercially available glass cleaner. You can also use a mixture of one part white vinegar to ten parts water. This will remove the haze that builds up on the inside of the glass windows. Use a soft cloth or paper towels to clean all glass. Clean the seals with a damp cloth or mild detergent every three to six months, taking care not to use strong solvents, as they will damage the seals. A coat of natural silicone lubricant applied after the seal has dried will keep it flexible. This is a good practice for all the rubber seals in your camper. If the camper is exposed to salt air, more frequent lubrication will be required.

ACRYLIC WINDOWS/HEKI SKYLIGHT VENT

Keep your acrylic windows and/or skylight vent looking and performing like new by using the proper care, products and techniques, and by understanding a little about the material you are working with. Acrylic windows and/or skylight vent can be scratched with a rough cloth, harsh soaps, or cleaning products and these must be avoided. When cleaning a window/skylight vent always remove as much abrasive dirt as possible without touching the surface. It's also a good idea to remove jewelry, which can cause deep scratches. Ideally this would involve flushing the surface with water and allowing the accumulated bug residue to soak, possibly with a mild dish washing liquid added to the water. Use a non-abrasive soap or detergent and water. Use a soft sponge, cloth or chamois and rinse often to keep it free of grit. Wash up and down or side to side, never in a circular motion. After a final flushing with more water carefully dry with a clean soft cloth, a good rule of thumb is to gently (let the weight of the cloth do the work) wick up the excess water on your first pass which will also wick up any residual loose particles. With windows, start at the top of the window and work down turning the cloth to a fresh side after each pass. Again do not use a circular motion on the windows/skylight vent. Acrylic Cleaning Kits are available from your Lance Dealer.

NOTE:

Never use abrasive, caustic cleaners, alcohol or solvents as they can cause permanent damage to the finish.

DO NOT USE WINDEX as it will damage the acrylic.

Never use any petroleum based cleaners, or caustic chemicals on your windows/skylight vent.

DO NOT USE WD-40 (as it is petroleum based).

Never use a razor blade, putty knife or abrasive pad to clean your windows/skylight vent.

Do not use a high pressure spray nozzle when rinsing your windows/skylight vent after washing.

Avoid washing windows/skylight vent in direct sunlight.

JACK BRACKETS

The corner jack brackets need to be inspected each time the camper is to be loaded or removed from the truck. These brackets can loosen and the seals separate during regular use due to rocking, while loading or unloading or while the camper is being stored. Retighten the bolts until they are snug and reseal the brackets as needed. Do not over-tighten as this can cause the fasteners to strip-out.

CAMPER JACKS

The internal parts of the jacks are permanently lubricated at the factory and do not require any further lubrication. At least once each camping season fully extend the jacks and clean dirt and grime from outside of the inner tube. Coat the entire outside of the tube with silicone spray lubricant. This will protect the finish of the inner tube and provide lubrication between the jack's tubes. Clean dirt and apply automotive polish or wax to the outer tube of the jacks to maintain the appearance.

TURNBUCKLES

Each time the turnbuckles are installed, and any time they begin to squeak, place a few drops of oil into the turnbuckle barrel at the captive hook end. This will reduce squeaking caused when the turnbuckles dry out.

It is important that the turnbuckles be kept clean and protected from corrosive agents, such as salt spray, acid rain, etc. This is best done by cleaning and waxing the turnbuckles with a good automotive wax or chrome polish.

AIR CONDITIONER

The air conditioner mounting bolts should be checked for tightness after the first 500 miles. Removing the interior shroud and inspecting the four (4) bolts located in the corners of the roof opening accomplishes this. Aside from securing the air conditioner to the roof, these fasteners apply pressure to the sealing gasket between the air conditioner and the top of the roof. Loose fasteners could cause water intrusion around the roof opening.

OVERHEAD VENTS

The vents can be cleaned from the top of the camper. Use soapy water on the vent cover. The screens may be vacuumed or lightly brushed to remove accumulation of leaves or other debris. Lubricate the gears and mechanism yearly with a light, water resistant grease.

SKYLIGHTS

The skylights should be cleaned at least once a year. Rinse the skylights with lukewarm water. Wash with mild soap and lukewarm water using a soft cloth or sponge and gently wash to loosen dirt and grime. **DO NOT SCRUB** or use brushes or squeegees. Repeat rinse and dry with a soft cloth to prevent water spotting.

EXTERIOR LIGHTS

Check the operation of your camper's exterior lights prior to each trip. This should also include your truck's lighting. An inoperative bulb or fixture can create an unsafe condition by reducing your ability to signal your intentions to other drivers. When replacing exterior bulbs, take care that the sealant around the light is not disturbed. When replacing exterior LED fixtures, ensure the new fixture is installed using a recommended sealant. Your Lance Dealer can assist you with replacement of the fixture and/or provide information on the appropriate sealants if you prefer to do this work yourself.

WIRING

Make sure the connector-plug prongs and receptacles are clean. Lightly coat all electrical terminal connections with non-conducting (dielectric), light waterproof grease. Clean the prongs with very fine sandpaper, being careful not to damage the contact area.

BATTERY(S)

Your camper is outfitted with a battery(s) that operates lighting, jacks, slide-outs or other accessories. The battery(s) may be kept charged either by the truck, by the generator or shore power.

A disconnect switch is provided to disconnect the battery(s) when you do not plan to be using the camper for an extended period, such as seasonal storage.

The battery must be kept in a charged condition during storage. The battery could freeze and break if it becomes discharged.

INTERIOR MAINTENANCE**INTERIOR ODOR**

New campers may have a strong odor and even cause eye irritation when closed up in hot weather. This is due to glues used in the cabinetry and paneling. This condition passes with time but in an extreme condition open the entry door and all windows and allow the inside to air out for several hours.

UPHOLSTERY AND DRAPES

Draperies, mattress covers, upholstery and wall pads are manufactured from quality materials and should be dry cleaned only. Some dry cleaning methods will damage vinyl or plastic found on cushions and drapes. Be sure to consult your local cleaners. Frequent vacuuming or light brushes between cleanings will help prevent accumulation of dirt and grime. Use of water based or detergent based cleaners may cause shrinking. Water stains may become permanent. Minor spills should be cleaned up quickly to avoid staining. The affected area should be blotted, not rubbed, to prevent the stain from working deeper into the fabric. On vinyl upholstery, remove dirt and dust with a vacuum cleaner. Wipe the vinyl with a soft cloth and dampen in a solution of mild soap and water. Use the same solution with a soft-bristle brush on more difficult spots. You can also use commercially-available spray or foam-type vinyl cleaners.

▲ WARNING Do not use lacquer thinner, nail polish remover, carbon tetrachloride, gasoline, or naphtha for any cleaning purpose. These products may cause damage to the material being cleaned, and are highly flammable or poisonous.

WALL AND CEILING PANELS

The paneling and ceiling of your camper may be any of several finishes and textures. Never use harsh detergents or abrasive cleaners on walls or ceilings. Most surfaces will clean with a soft cloth moistened with mild liquid detergent in warm water. Do not use large amounts of water, which could saturate the material.

FLOORS AND CARPETING

Vinyl flooring requires only washing and periodic waxing. Vacuum the carpeting frequently to remove dirt. Ground-in dirt will make the carpet wear out faster. Periodically shampoo the carpet to keep it looking new. Use one of the foam-type carpet cleaners on the market. Follow the instructions that come with the cleaner, applying it with a sponge or soft brush. Keep the carpeting as dry as possible by not adding water to the foam.

WOOD PRODUCT CARE

Remove dust with a clean slightly damp cloth. Apply a quality furniture polish and buff with a soft, dry cloth. Never use harsh detergents and solvents.

FIBERGLASS TOP CARE

Do not use abrasive cleaners or scouring powders. Use of abrasive cleaners will dull or damage the surface of this product and could leave scratches. If material gets scratched, easy polishing brings back the original shine. It is recommended you use a gel cleaner or household cleaner made for fiberglass and acrylic.

Do not use scouring pads, steel wool, "scotch brite" type scratch pads, or any other abrasive scrubbers. Wipe only with a soft cloth or sponge.

Always use a cutting board when using knives or sharp objects. Always allow pans to cool before setting them on the countertop surface.

POWER RANGE HOOD

Clean the filter in detergent and hot water periodically and wipe down the surface of the unit with mild soap and water. Use a soft cloth for both washing and drying.

REFRIGERATOR

Clean interior with mild soap and water after each trip. Defrost freezer and empty ice trays. When defrosting, place dry towels in the refrigerator to absorb the water. Place trays containing hot water into freezer compartment. After defrosting (when the freezer compartment and condenser are frost-free), remove the damp towels and water trays and use a clean cloth towel to dry off refrigerator.

DRAINS

If a stoppage develops in the sink or shower drain, DO NOT use lye or any strong chemicals. Strong chemicals can harm the plastic in your waste system. A standard wire drain cleaner is recommended.

SHOWER CARE

For routine cleaning use a non-abrasive cleaner. Household fiberglass cleaners are recommended. Never use harsh detergents or abrasive cleaners. Never use a razor blade or steel wool to clean the surfaces.

SINK CARE

Do not use abrasive cleaners or scouring powders. Use of abrasive cleaners will dull or damage the surface of this product and could leave scratches. If material gets scratched, easy polishing brings back the original shine. It is recommended you use a gel cleaner or household cleaner made for fiberglass and acrylic.

Do not use scouring pads, steel wool, "scotch brite" type scratch pads, or any other abrasive scrubbers. Wipe only with a soft cloth or sponge.

Always use a cutting board or a sink protector when using knives or sharp objects. It is recommended that you use protective mats, racks, or dishpans to help protect your sink. Always allow pans to cool before setting them in your sink.



Camper Maintenance Chart

Service to be performed	Every Trip	Weekly	Monthly	6 Months	Annually
Inspect wiring, connector plug & receptacles	X				
Check exterior lighting	X				
Inspect and tighten mounting bolts on each jack corner bracket	X				
Check that camper anchors are secure	X				
Check that cabover stabilizers are secure and lubricated	X				
Inspect propane system compartment for leaks and kinked lines		X			
Test propane leak detector for proper operation		X			
Inspect generator exhaust muffler and tailpipe clamps (if equipped)		X			
Check smoke detector operation		X			
Check CO detector operation		X			
Check fire extinguisher			X		
Inspect battery cables, terminals, wing nuts			X		
Charge battery charge (in storage)			X		
Check battery electrolytes (in use)			X		
Test GFCI			X		
Wash Exterior			X		
Inspect camper jacks and lubricate				X	
Inspect roof sealants				X	
Inspect access doors, moldings, and window sealants				X	
Perform LP leak and Pressure Test (will require qualified personnel)					X
Inspect all hot, cold, and drain plumbing					X
Sanitize fresh water tank (may require qualified personnel)					X
Complete pressure check and system check					X
Perform appliance service (will require qualified personnel)					X
Wax exterior					X
Clean and lube overhead vents					X
Lube locks, hinges, and hardware					X
Replace smoke detector battery					X
Inspect and tighten the A/C mounting bolts					X

This page intentionally blank.

WINTERIZATION

OPERATING IN FREEZING CONDITIONS

If water freezes inside the system, it can damage piping and equipment.

Keeping the interior warm will aid in preventing water in the storage tank, pump and piping from freezing. Open inside cabinets and allow warm air to circulate over the water system components.

Add non-toxic anti-freeze to the holding tank(s). Refer to the instructions that came with the anti-freeze. Install a winter cover on the air conditioner.

Propane for the appliances will work down to 44 degrees below zero (-44°).

The windows have weep holes, which drain water from the window tracks. In heavy rain and wind, water could be blown into the camper through these holes. Put a piece of sponge in the track over the hole to prevent this from occurring.

STORAGE

The following checklists will help you perform the steps necessary to prepare your camper for storage. Use the checklist that applies to the storage conditions you anticipate. These checklists do not include every detail required, and you may want to expand them to suit your needs.

SHORT-TERM STORAGE

(Less than 45 days - Above Freezing)

1. Wash the exterior.
2. Park the camper as level as possible front to rear and side to side.
3. Before disconnecting the battery cables, check the charge in the battery. Recharge as necessary. Clean terminals, top and sides of battery and battery box. Leave the battery disconnected or switch the battery disconnect switch to the "STORE" position.
4. Drain the holding tanks, toilet, and fresh water tank. Turn off the water pump and water heater.
5. Turn off the propane at tank valve.
6. Turn off the refrigerator, furnace, all range and oven burner valves and pilot.
7. Remove all perishables from refrigerator and galley cabinets. Leave the refrigerator door open to reduce odor buildup. An open box or tray of baking soda in the refrigerator will help absorb odors.
8. Slightly open (1/4") a roof vent.
9. Close and lock all windows. Be sure the vent fan and range hood fan switches are off.
10. Cap and close the holding tank drain, city water inlet and fresh water fill spout.

11. Turn off all radios, TV's, interior and exterior lights.
12. Close the mini blinds and day/night shades.
13. Disconnect the 120-volt power cord and store in compartment.
14. If removing the camper from the truck, see procedure and warnings in the "Loading and Unloading Camper" section.
15. Check the camper weekly.

LONG-TERM STORAGE - Above Freezing

1. Perform all the preceding short-term storage steps.
2. Operate air conditioner periodically to lubricate compressor seals.
3. Remove and place the battery in a cool, dry area. Check the battery charge every 30 days. Recharge as necessary.
4. Check the sealants around all roof seams, body seams and windows. Reseal if necessary. See "Sealant Renewal" section.
5. Prepare the generator (if equipped). See generator Operating Manual included in the Owner's Information Package.
6. Remove the smoke detector's battery. Leave the cover open as a reminder to replace the battery.
7. Cover exterior vents; water heater, furnace, air conditioner shroud, range hood, refer, to prevent insects and small animals from getting in the camper. Be sure to remove all covering materials before using appliances and vents.

STORAGE BELOW FREEZING

To avoid damage to the plumbing fixtures and other components, we recommend that your camper plumbing systems be properly drained and have antifreeze protection. The following is a procedure checklist you can follow if you prefer to winterize your camper yourself. Many owners prefer to have a Lance Dealer Service Center perform this service.

1. Perform all steps in the short and long term storage procedures.
2. Drain the fresh water tank by opening the water tank drain and leave open.
3. Turn the water pump ON and open all hot and cold water faucets. When the flow of water stops, turn the pump OFF. Open the low point drains on the hot and cold water pipes.
4. Drain the water heater by opening the drain plug at the bottom of the heater and open the pressure relief valve.
5. Depress the toilet flush pedal or hand-operated lever. Shut OFF all faucets, close the water line drain valves, fresh water tank drain valve, water heater drain and pressure relief valve.
6. Drain the showerhead and hose by disconnecting the hose at the faucet from the inside and outside shower.

7. Drain the waste water system by following the normal procedure for draining the holding tanks. See "Waste System" section.
8. Be sure ALL water from ALL plumbing has been drained.

Draining the water system alone will not provide adequate cold weather protection. If the camper is to be unheated during freezing temperatures, consult your dealer for the best winterizing procedure for your climate. Your dealer can supply you with one of the special non-toxic antifreezes that are safe and approved for use in RV water systems. Follow the instructions furnished with the antifreeze.

Do not use automotive or windshield washer antifreeze in the camper water system. These could be harmful if swallowed.

WINTERIZING METHOD (IF EQUIPPED)



1. Make sure the water pump switch is off.
2. Insert the hose from the winterizing valve into a container of RV approved non-toxic antifreeze.
3. Turn the water heater bypass valve to Bypass position and drain the water heater by removing the drain plug and opening the safety relief valve. Open faucets to relieve pressure. (Hot and Cold) Open the hot and cold low point drains.
4. Drain the water tank by opening the tank drain and leave open to drain completely.
5. After the system is completely drained, close all faucets and turn off the low point drain valves.
6. Turn the winterize valve to "Winterize" position.
7. Turn ON the water pump switch.
8. Open the hot water faucet farthest from the water tank. When antifreeze appears, let at least one cup run down the drain to winterize the P-trap. Do the same to all other water outlets, hot and cold, including shower, toilet and outside shower.
9. Turn OFF the pump switch.
10. Open a water faucet to relieve pressure, and then close.
11. The procedure is complete.

WATER HEATER BYPASS (IF EQUIPPED)



The water heater bypass valve is located behind the water heater and is used when winterizing the water system for storage. By rotating the lever to the bypass position, antifreeze will not enter the water heater requiring less antifreeze to protect the water system plumbing. Follow the instructions shown on the placard.

NOTE: Be sure to drain the water heater by opening the drain plug at the bottom of the heater and open the pressure relief valve.

To De-Winterize:

1. First fill the water tank.
2. Turn the winterizing valve to normal flow position.
3. Turn the water heater bypass valve to "bypass"; this will keep antifreeze from entering the water heater.
4. Turn ON the water pump switch.
5. Open the water faucet farthest from water tank, catching antifreeze in a container for future use, until clear water appears. Shut off the faucet. Do this to all other faucets and the showerhead, including outside shower.
6. Turn the water heater bypass valve to normal flow position.
7. Open a hot water faucet until water appears.
8. Your system is now ready for use.

REACTIVATING CAMPER AFTER STORAGE

The following procedure checklist assumes that you stored the camper with care. If you didn't and extensive freeze damage or other serious deterioration may have occurred, please consult your Lance Dealer Service Center for advise.

Outside Area

1. Thoroughly inspect the outside of the camper and open all doors and compartments. Check for animals or insect intrusion, water damage or other deterioration.
2. Remove all appliance vent, ceiling vent and air conditioner coverings. Be sure all furnace, water heater, and refrigerator openings are clear and free of debris or insect nests, webs, etc.

NOTE: Spiders and other small insects climb into burner tube(s). The spiders spin webs, build nests and lay eggs. These webs and nests can be very small, but they are very strong and can block the flow of gas.

Mud Daubers are another insect to watch out for. It is not uncommon for Mud Daubers to build their mud huts in places like the furnace exhaust ports. This can be dangerous in two ways. First by causing a restriction that could cause carbon monoxide to build up on the inside of the camper, second, the same restriction can also cause heat and flame problems which could cause a fire. Both scenarios are dangerous and can cause death.

3. Open vents and windows.

12-Volt System

1. Prior to the battery installation, check charge level. Refill and recharge as necessary. Inspect cable ends and ensure that terminals are clean and free of corrosion. Place the battery into the compartment, install tiedowns, and connect cables. Turn battery switch to "USE" position. Check battery condition on monitor panel.
2. Be sure all 12-volt DC and 120-volt AC circuit breakers are ON.
3. Inspect and operate all 12-volt lights and accessories.

Fresh Water System

1. If the fresh water system has been winterized, drain the antifreeze from fresh water system.
2. Turn the water pump on and open all faucets until flow of antifreeze stops.
3. Do not let antifreeze stand on plastic sinks or outside shower components or stains may occur.
4. Open the water heater bypass valves.
5. Flush and sanitize the fresh water system as outlined in the "Fresh Water System" section.
6. Operate all faucets and fixtures in the fresh water system. Check for leaks at all joints and fittings. Repair if necessary.

Propane System

1. Turn on propane valves and inspect all pipes and fittings in the propane system. Check for leaks as outlined in the "Propane System" section.
2. Operate each propane appliance. Observe all burners and pilot flames for proper color and size. If there are any problems, refer to an authorized Lance Dealer Service Center.

General

1. Install new 9-volt battery in smoke detector.
2. Check the monitor panel operation.
3. Open and operate vents and vent fans.

120-Volt System

1. Inspect the 120-volt electrical system: Power cord, converter, and outlets. If defects are found, refer service to a Lance Dealer Service Center.
2. Prepare the AC generator (if equipped) for operation following instructions in the generator operating manual in your Owner's Information Package.
3. Operate 120-volt AC appliances and air conditioner.

Maintenance

1. Check the sealant around all roof, body seams, and windows. Reseal if necessary. See "Sealant Renewal" subsection of the "MAINTENANCE" section.
2. Lubricate all exterior locks, hinges and latches.
3. Wash and wax the exterior. Inspect the body for scratches or other damage. Touch-up or repair as necessary.

Camper Loading and Checkout

1. Load the camper onto the truck following the procedure in the "LOADING AND UNLOADING" section.
2. Check the operation of taillights, turn signals, backup lights, clearance lights, license plate lights, and emergency flashers.

Your camper should now be ready for a new traveling season. If you choose, your Lance Dealer can double check your preparation and correct any defects or make any necessary adjustments.

TYPICAL BULBS AND FUSES

The following is a list of typical 12-volt bulbs and fuses used in your camper. It is wise to keep a couple of spares of each type on hand.

Fuses	Amp
Blade type (ATC) (ATM)	1, 2, 3, 7.5, 10, 15, 20 & 30 2

Lights	Bulb Number
Reading light	MR16 GU5.3
Range hood light	#921
Wardrobe light	#563
Docking light	#H3-12V55W

Happy Camping

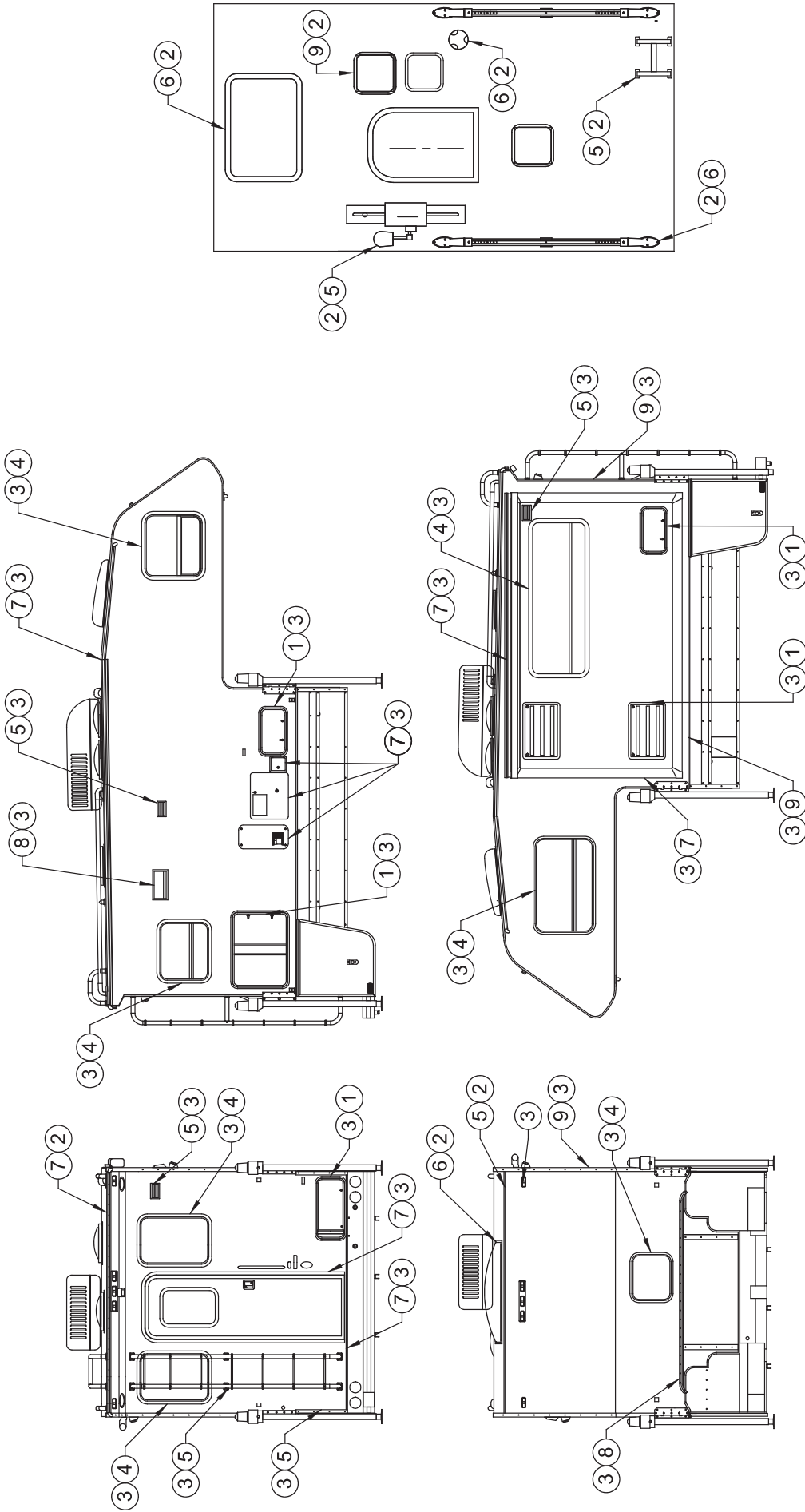

EXTERIOR SEALANT CHART
TYPICAL MODEL

#	PART #	TITLE
1	MA115	ADHESIVE STABOND STASEAL 4000
2	MA125	SEALANT TPO ROOF LAP SEAL
3	MC115	CAULKING GEOCEL 2300 CLEAR SAUSAGE
4	MT111	SEAL EPDM "D" .360 x .500 x 500' 2RL/CS
5	MT209	PUTTYTAPE BUTYL 3/32 x 1 1/2 5011-4827
6	MT213	PUTTYTAPE BUTYL 1/8 x 1 5011-3236
7	MT214	PUTTYTAPE BUTYL 3/16 x 3/4 5011-2444
8	MT220	PUTTYTAPE BUTYL 3/32 x 1 5229-3222
9	MT221	PUTTYTAPE BUTYL 3/16 x 1 1/2 5011-4834

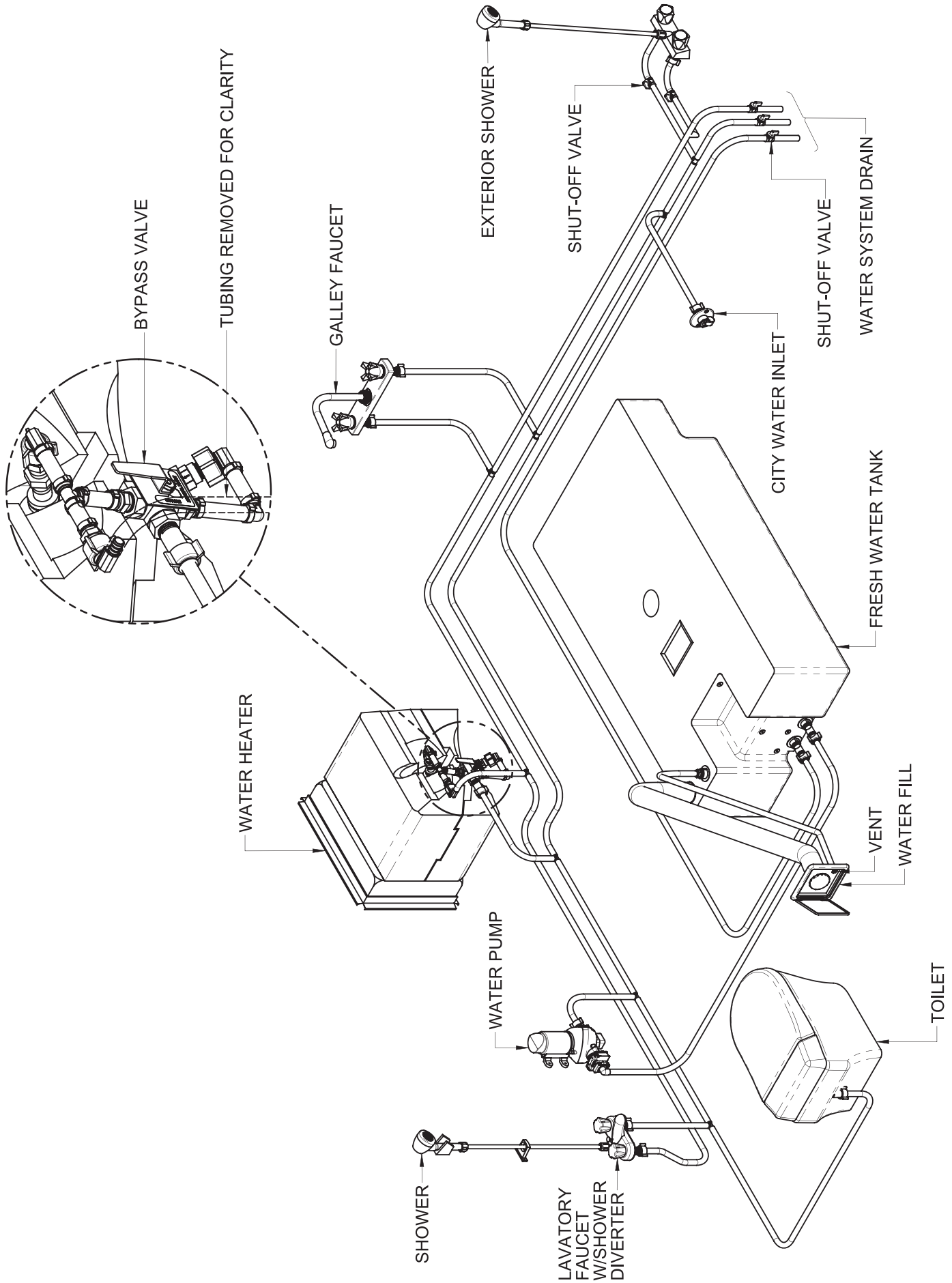

TYPICAL FRESH WATER SYSTEM

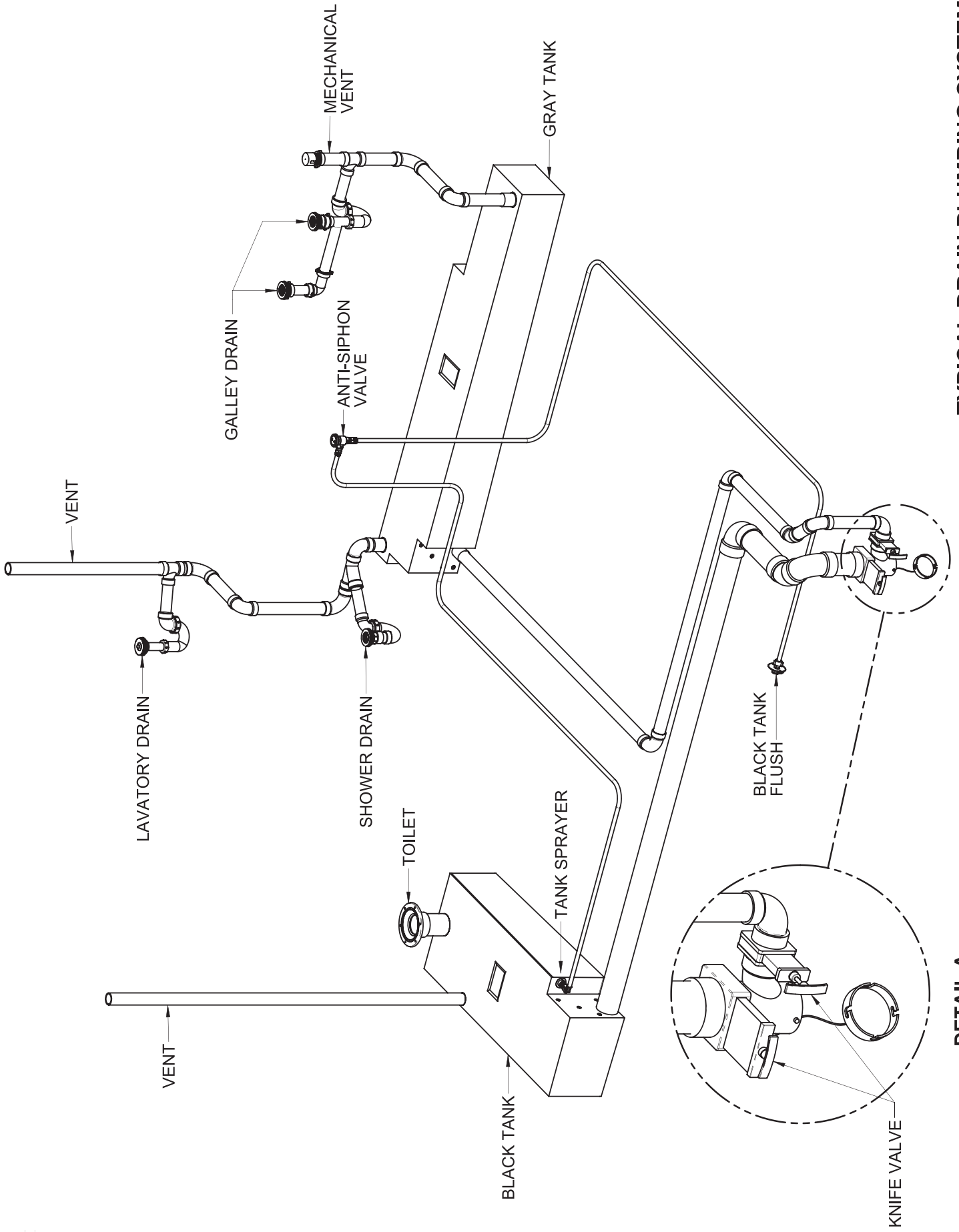

TYPICAL DRAIN PLUMBING SYSTEM

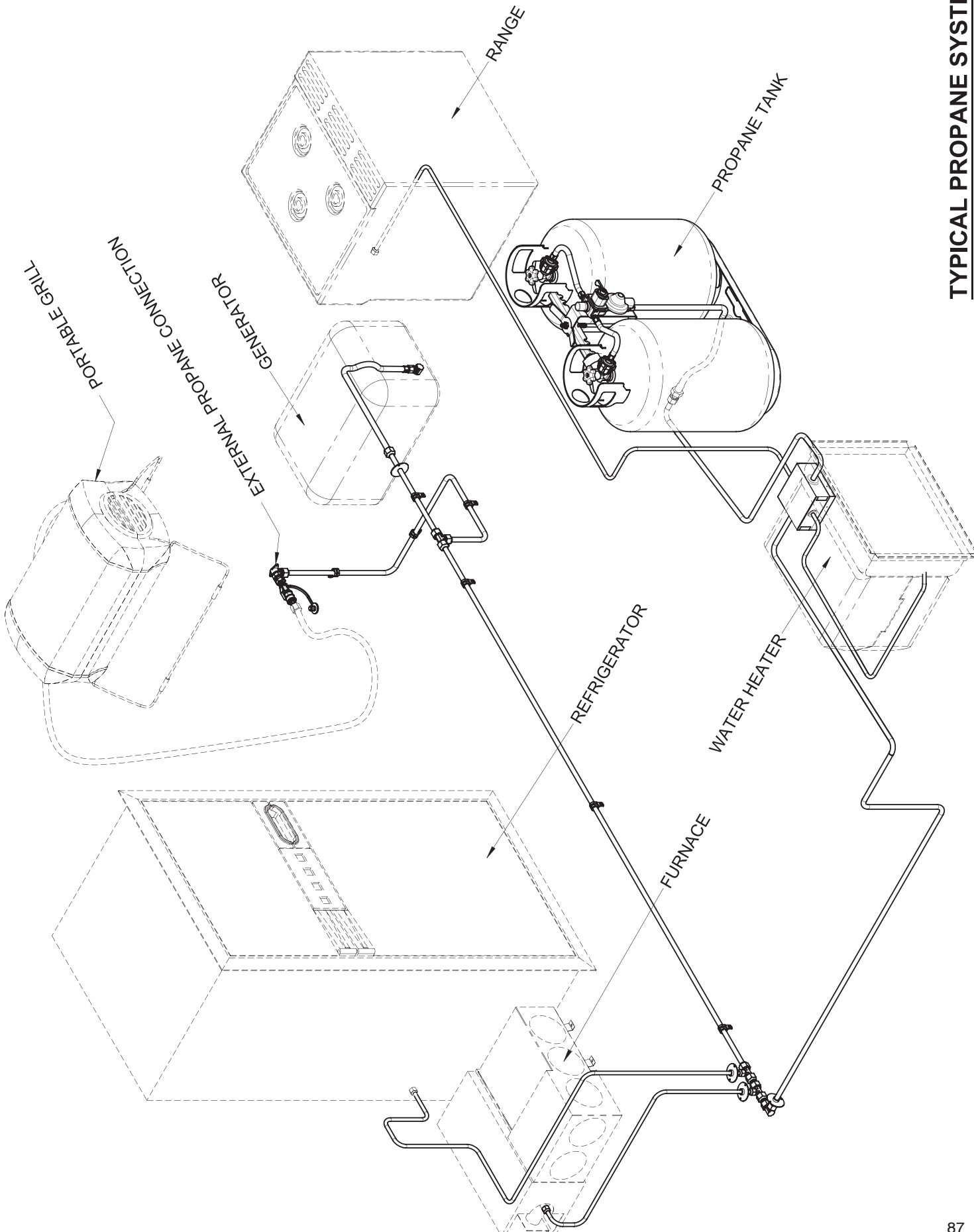

TYPICAL PROPANE SYSTEM

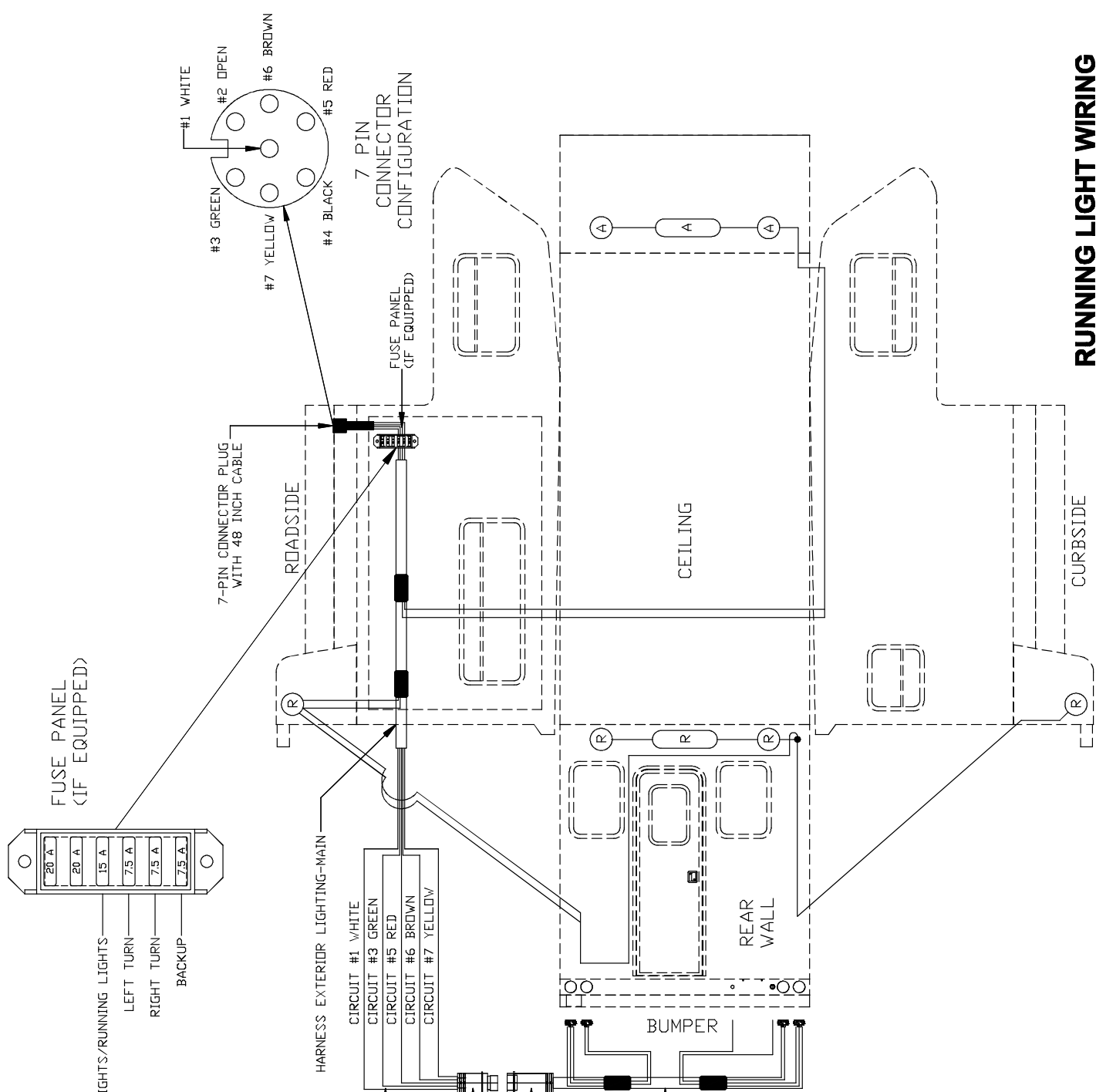

RUNNING LIGHT CIRCUITS	
CIR	WIRE SIZE/ COLOR
1	GROUND #8 GA - WHITE
2	OPEN #14 GA - GREEN
3	RUNNING LIGHTS #8 GA - BLACK
4	HOT FEED #16 GA - RED
5	LEFT TURN / STOP #16 GA - BROWN
6	RIGHT TURN / STOP #16 GA - BROWN
7	BACK-UP #16 GA YELLOW

- (A) AMBER CLEARANCE/ SIDE MARKER LIGHT
- (R) RED CLEARANCE/ SIDE MARKER LIGHT

RUNNING LIGHT WIRING

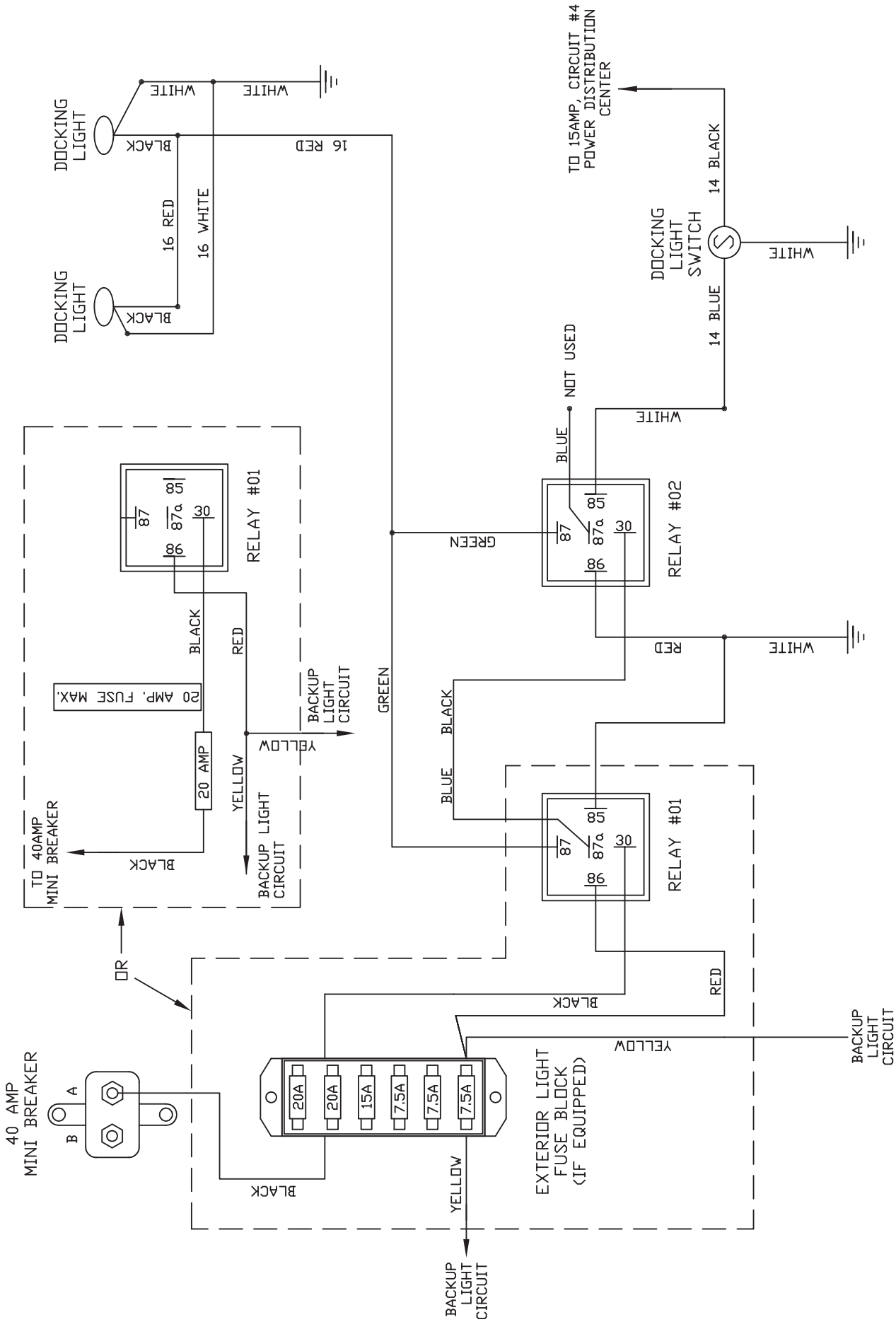

DOCKING LIGHT WIRING

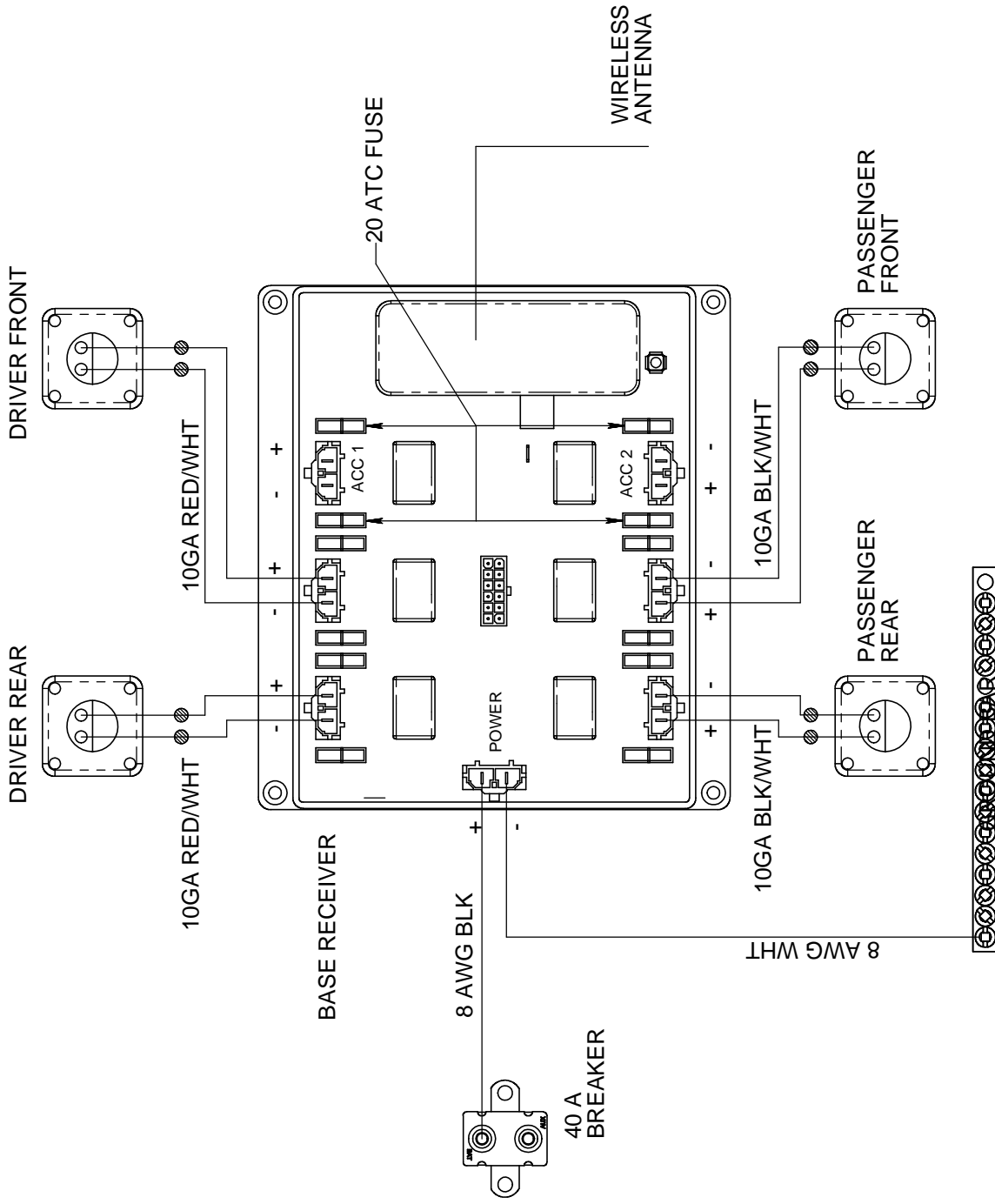

ELECTRICAL JACK WIRING

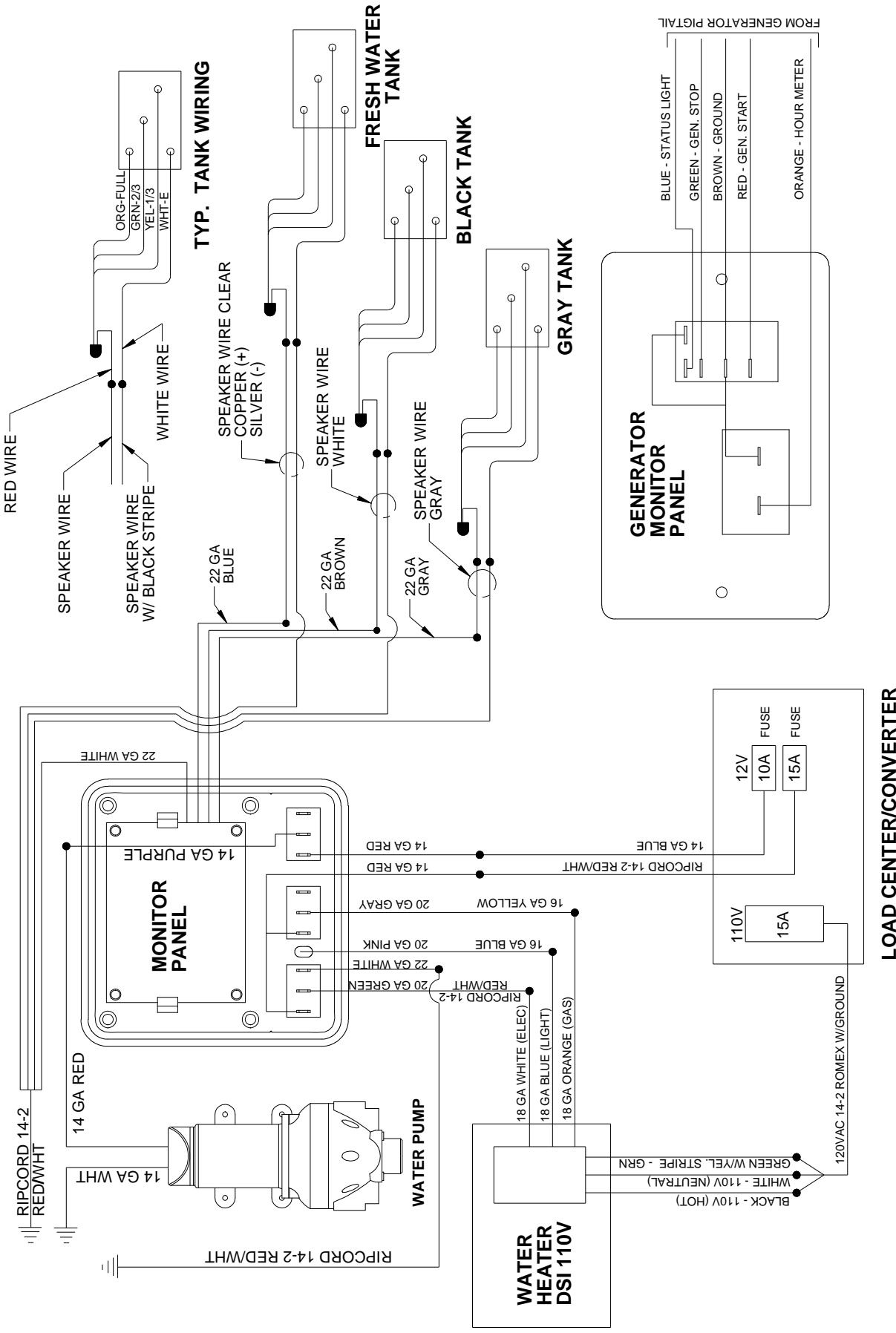

MONITOR PANEL WIRING

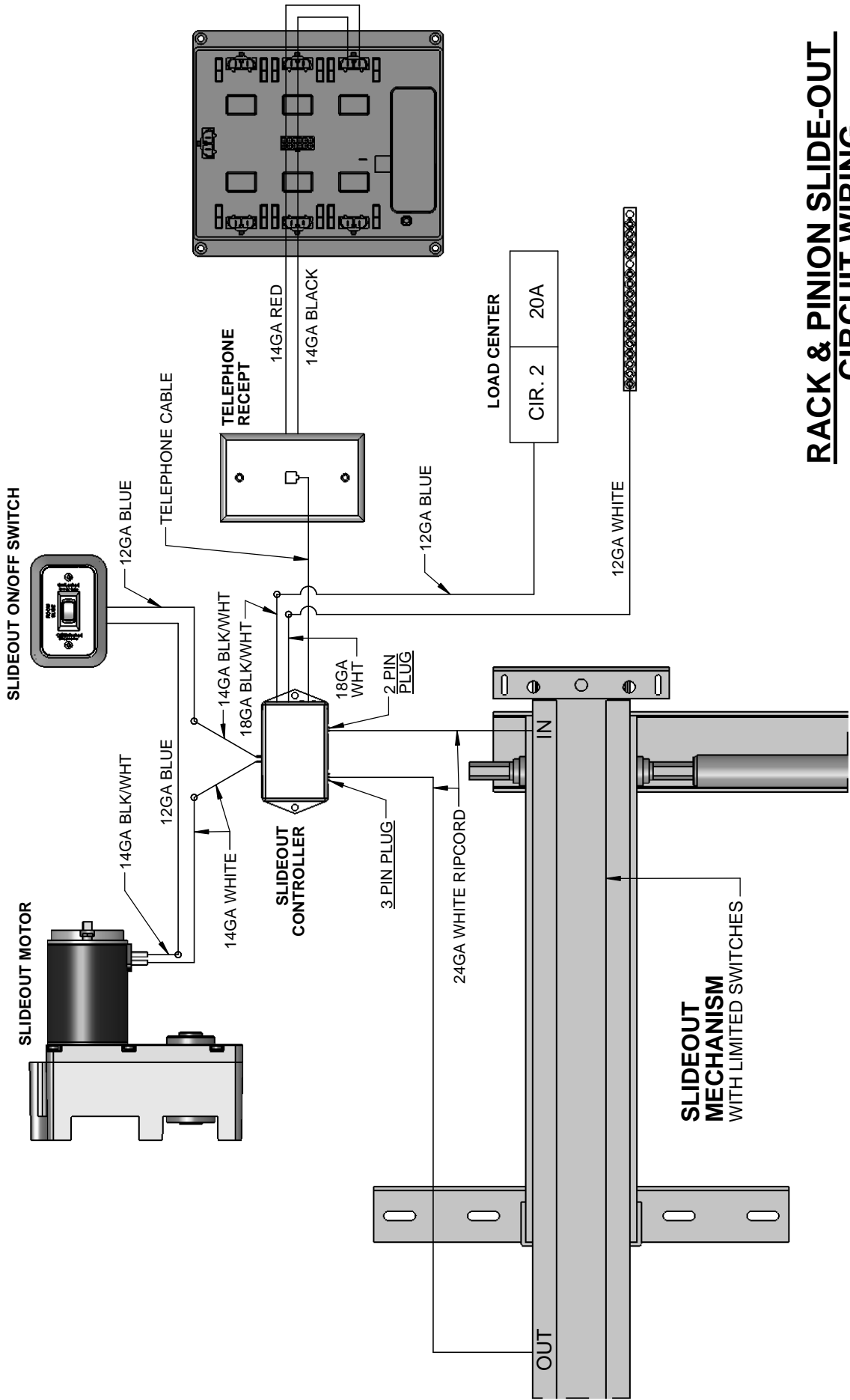

RACK & PINION SLIDE-OUT
CIRCUIT WIRING

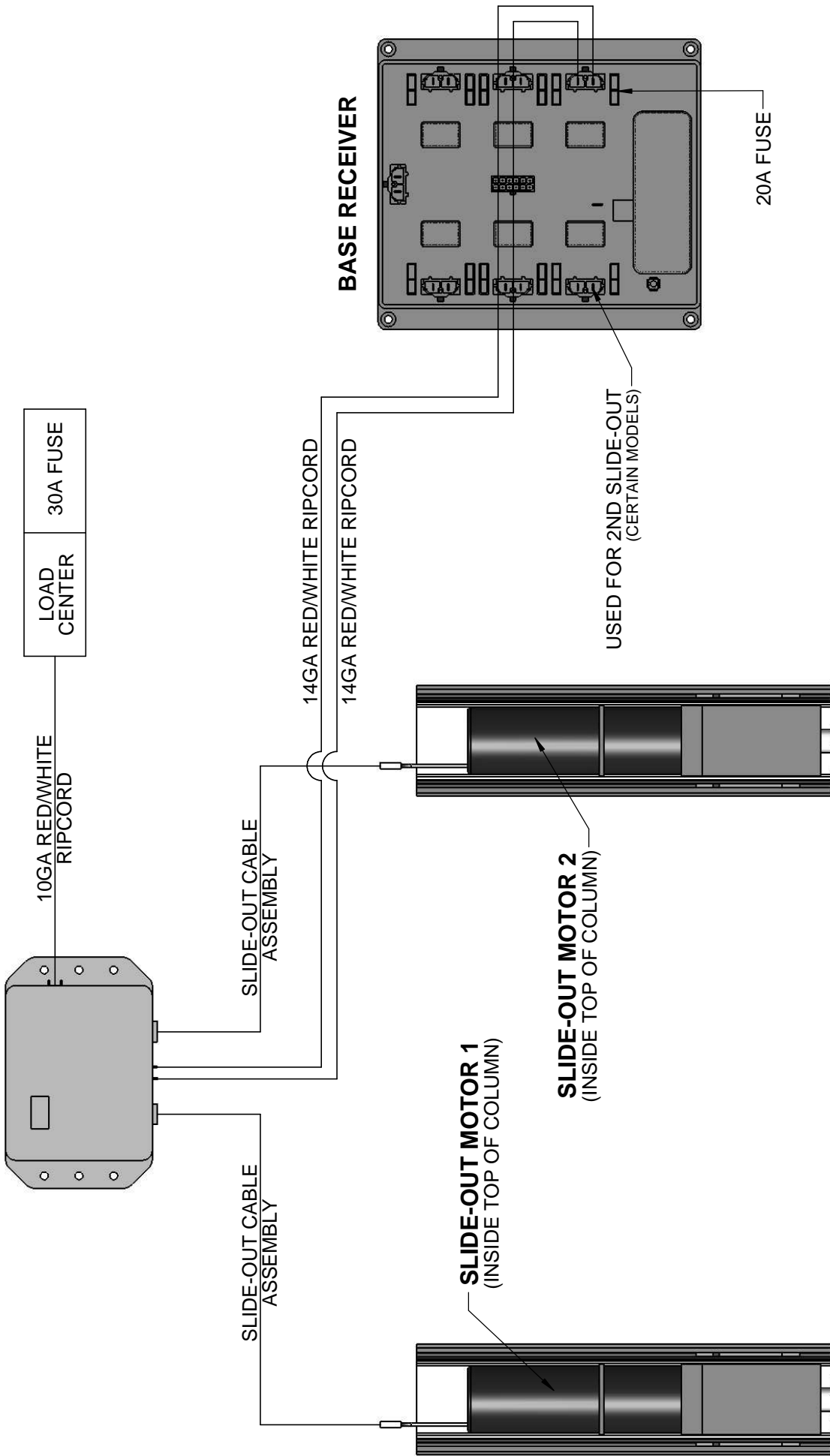

**IN-WALL SLIDE-OUT
CIRCUIT WIRING**

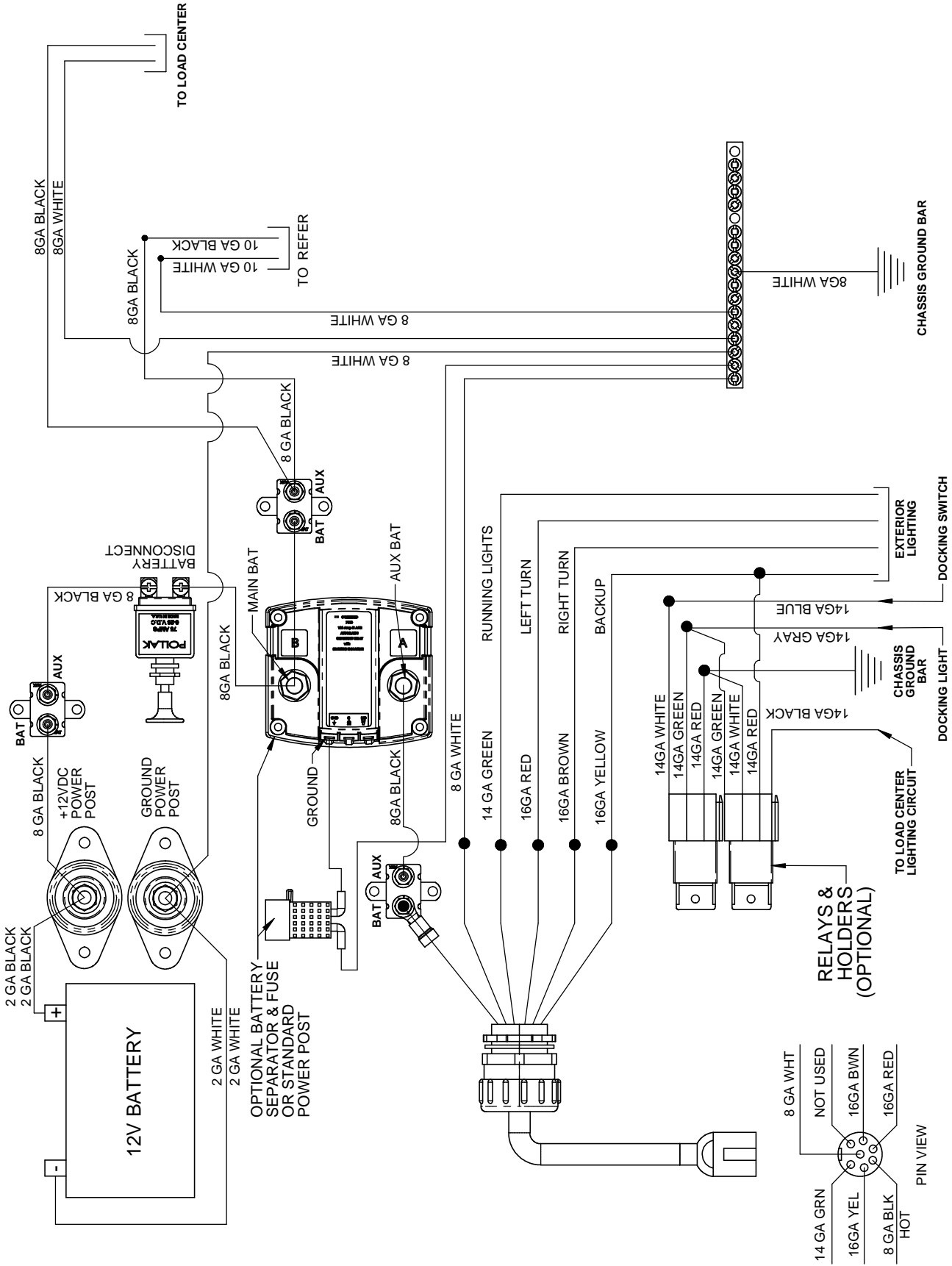

TYPICAL 12V SYSTEM

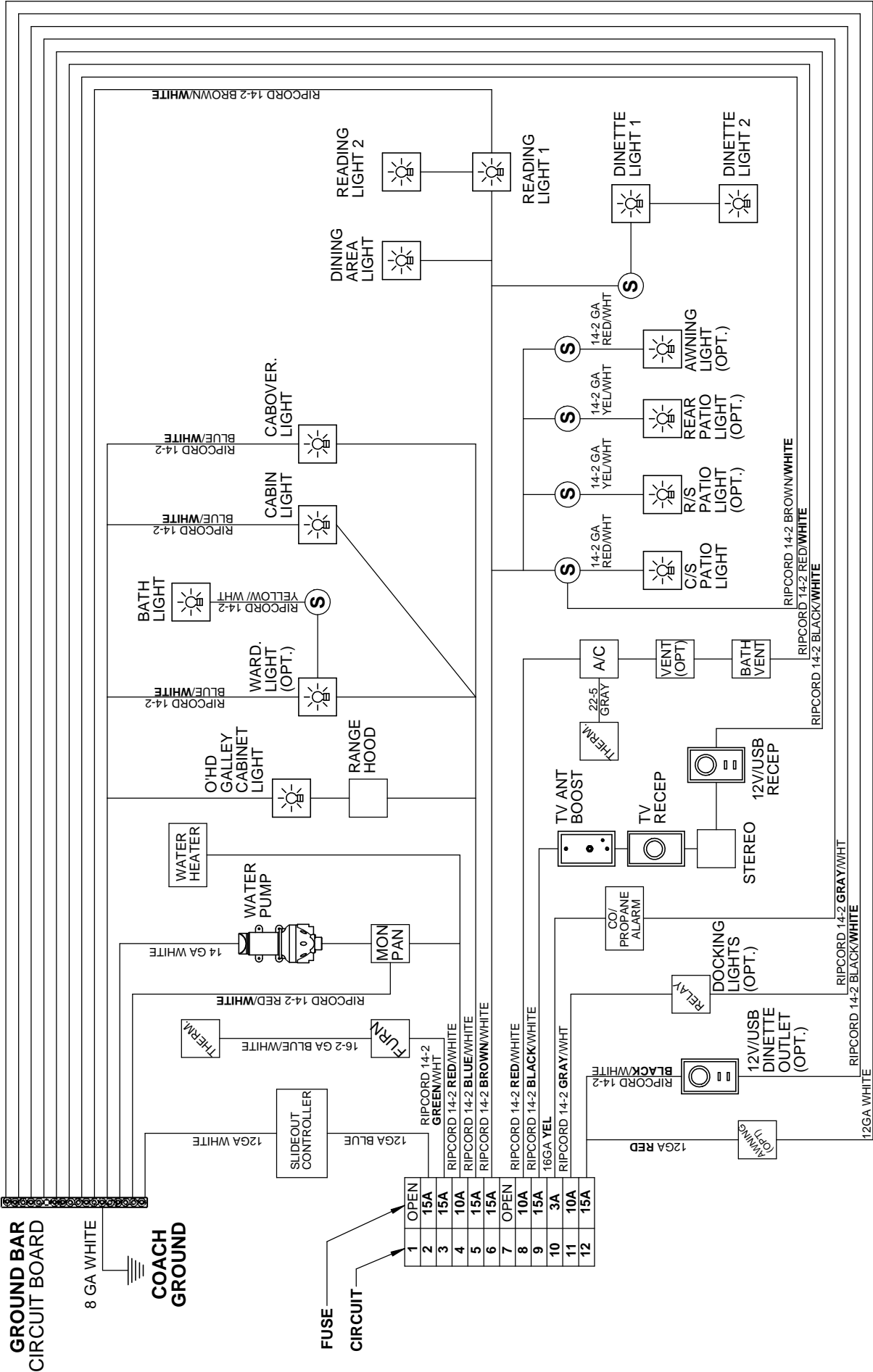

TYPICAL 12V INTERIOR CIRCUIT WIRING

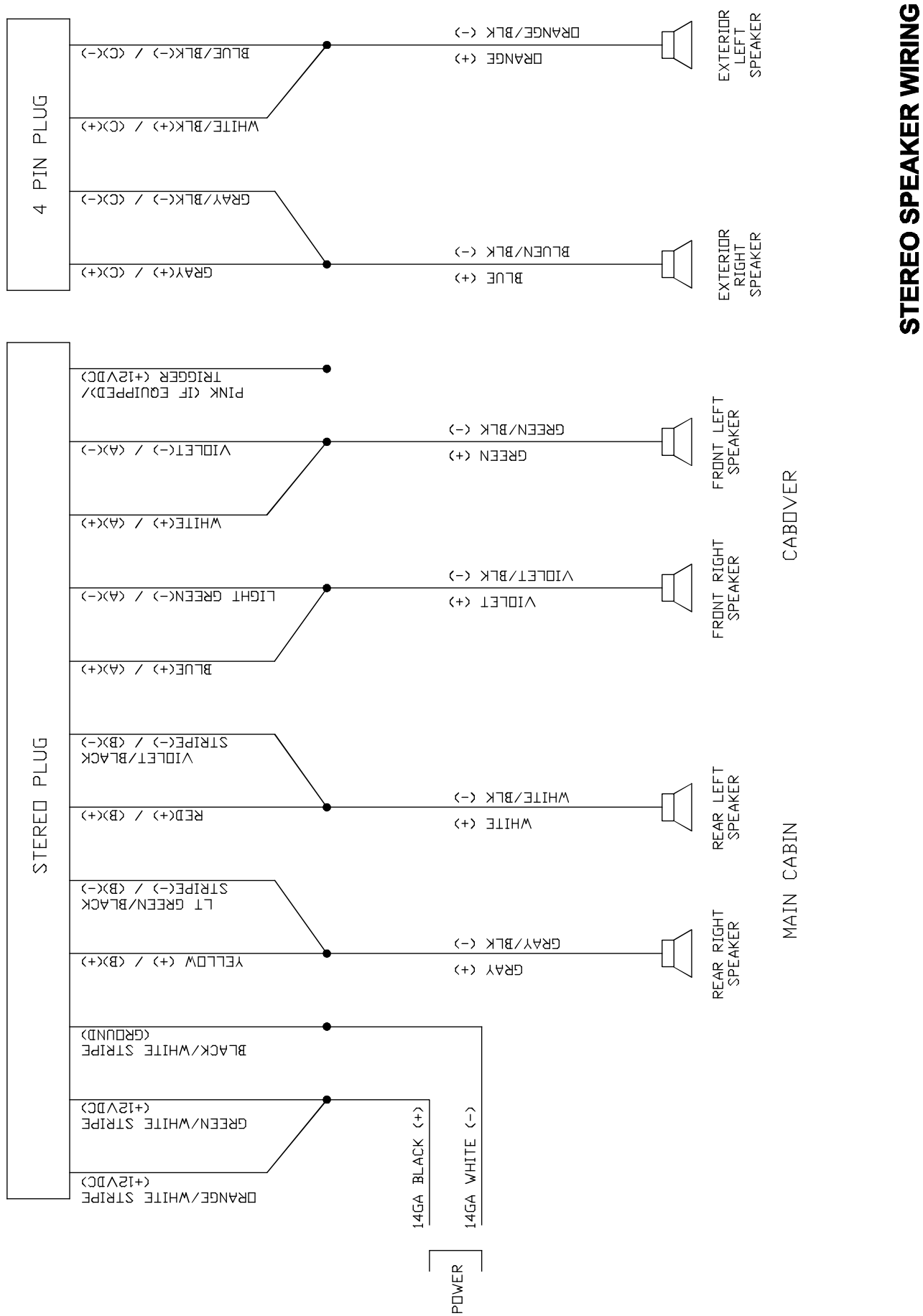

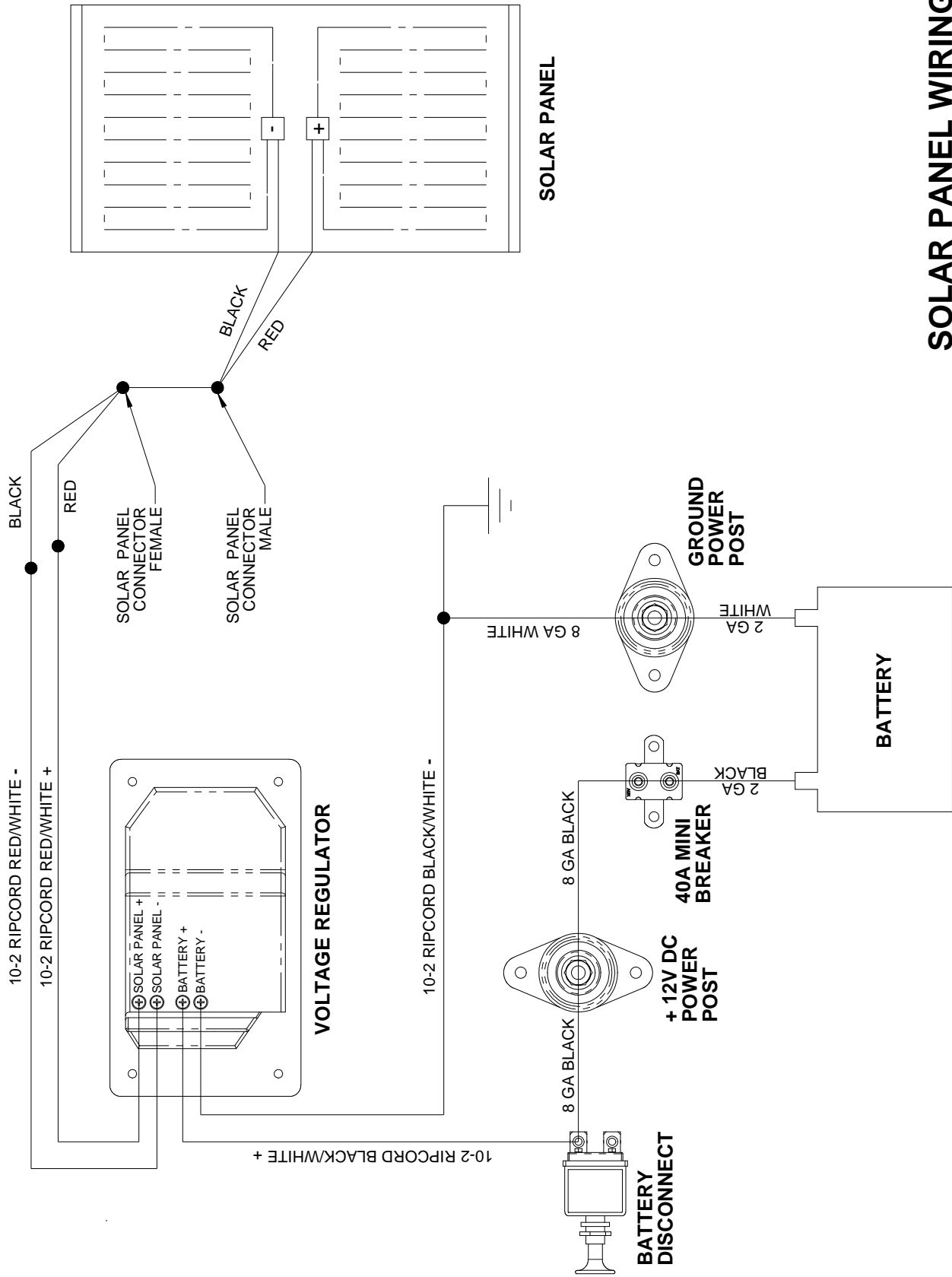

SOLAR PANEL WIRING

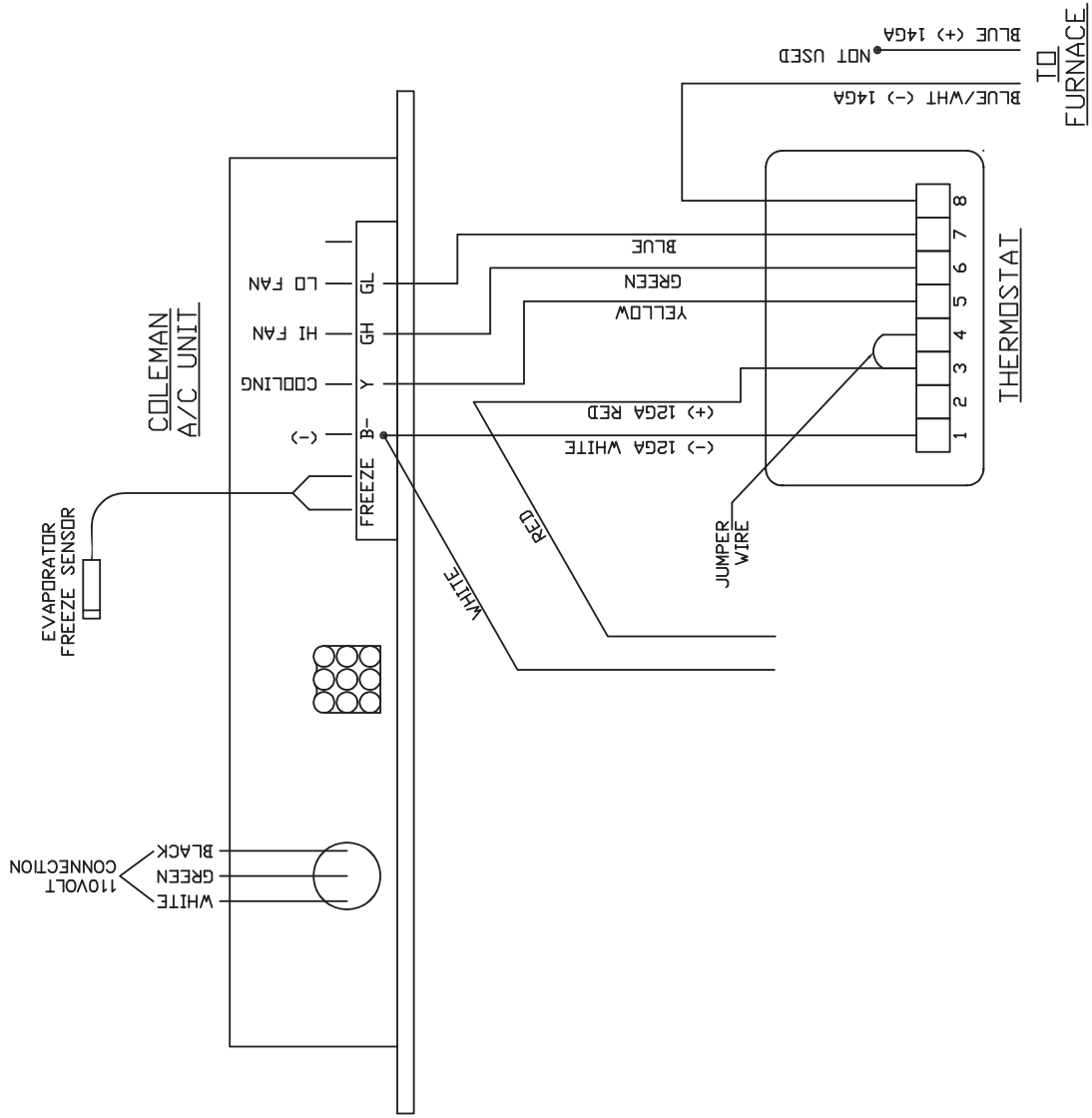

ATWOOD THERMOSTAT WIRING

THERMO WIRE LAYOUT	
BLUE	B- (-12VDC)
RED	+12VDC
YELLOW	Y (COOLING)
GREEN	GH (HIGH FAN)
GRAY	GL (LOW FAN)

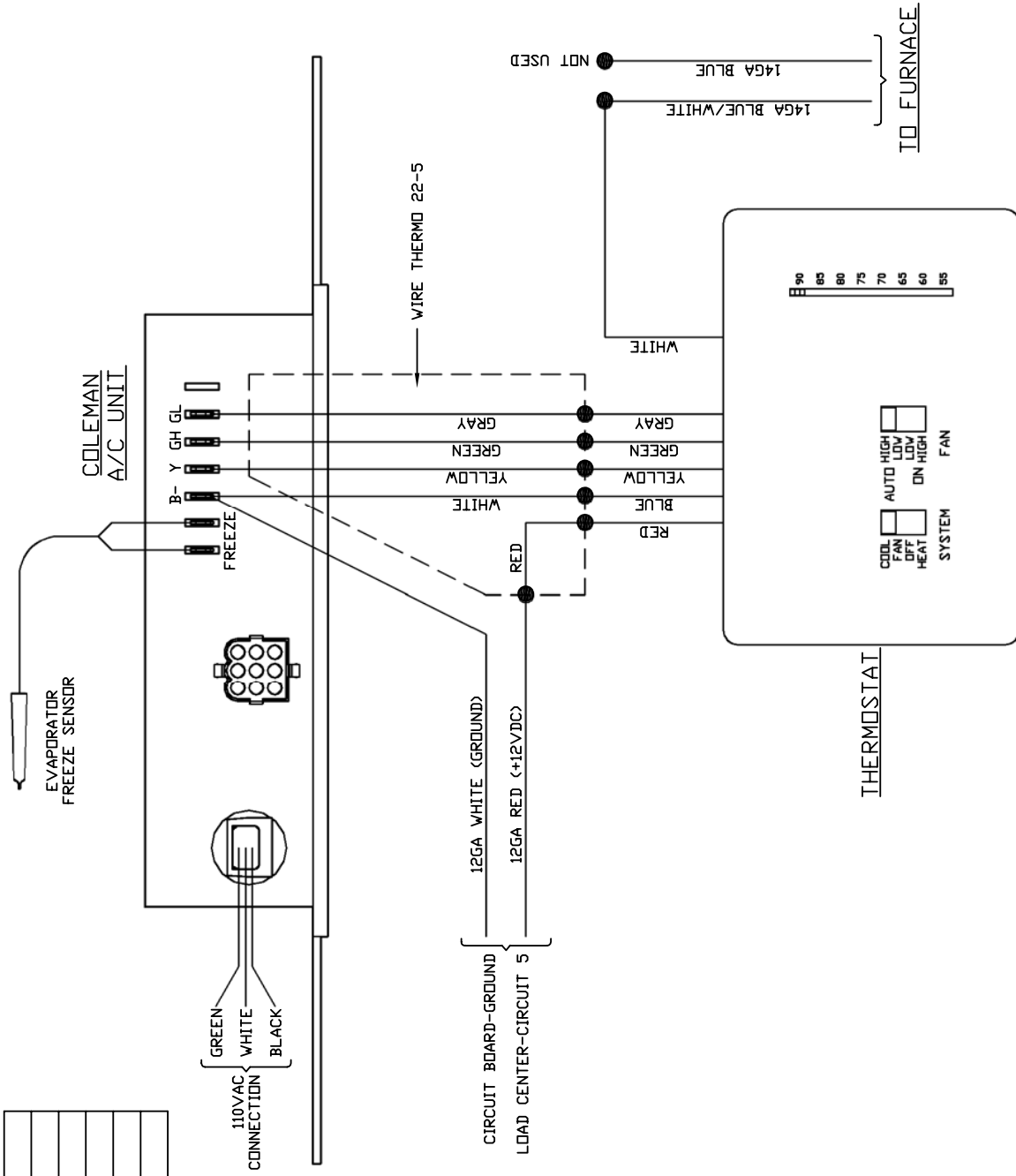

RVP COLEMAN THERMOSTAT WIRING

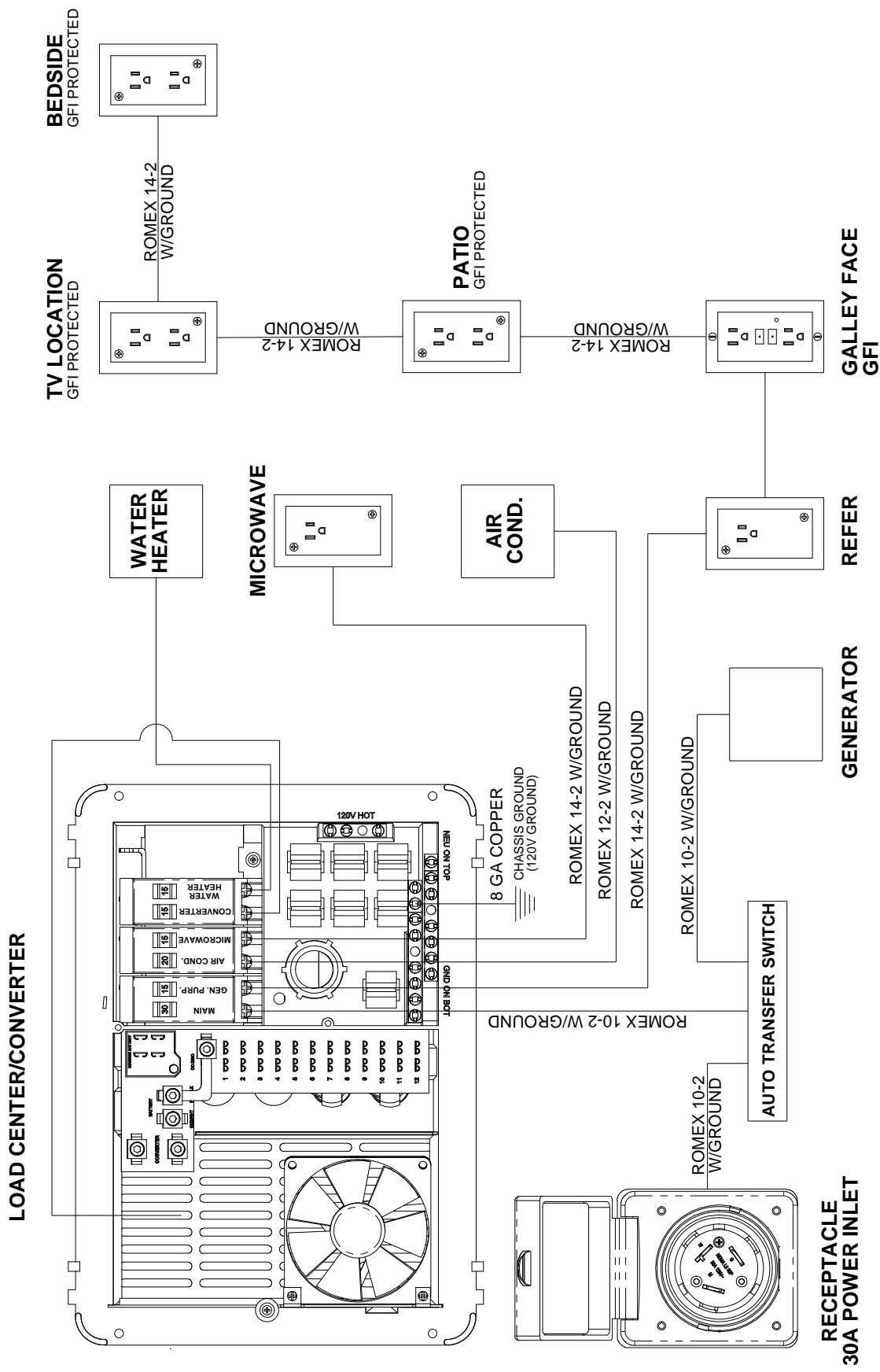

TYPICAL 120V SYSTEM

CEILING

2ND TV LOCATION
CERTAIN MODELS

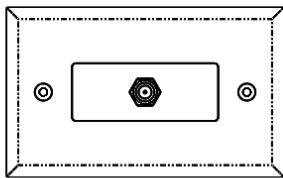

TV LOCATION

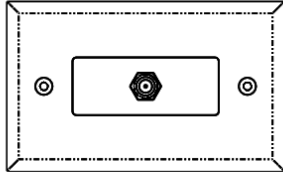

EXTERIOR DRIVER SIDE

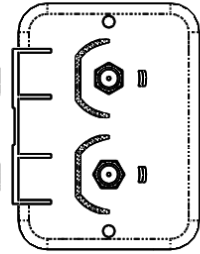

P S

CABOVER
CERTAIN MODELS

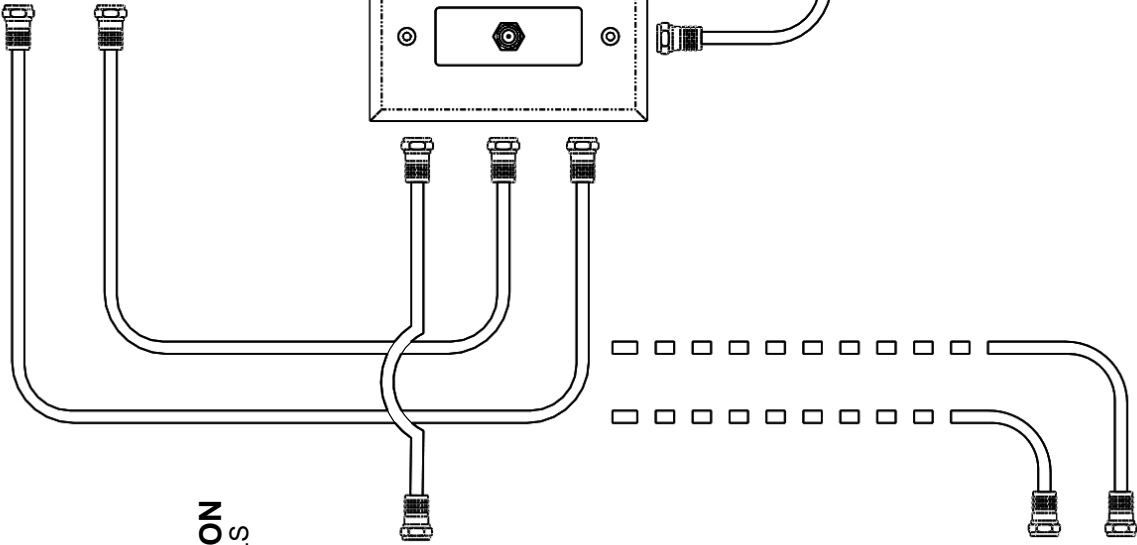
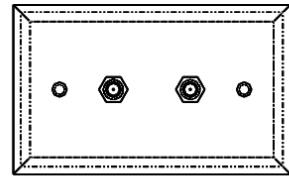

TV ANTENNA

CEILING

2ND TV LOCATION
CERTAIN MODELS

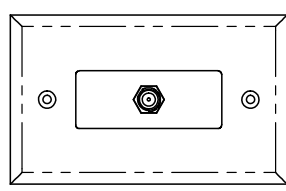

TV LOCATION

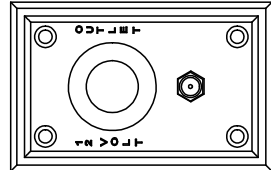
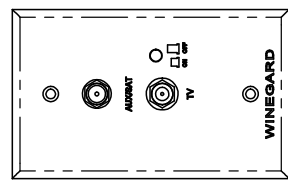

EXTERIOR
DRIVER SIDE

P S

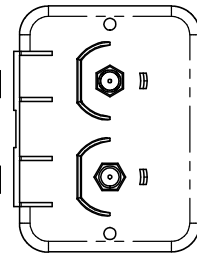

CABOVER
CERTAIN MODELS

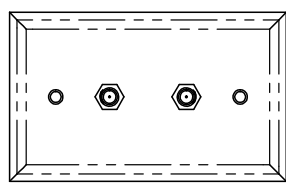

TV ANTENNA

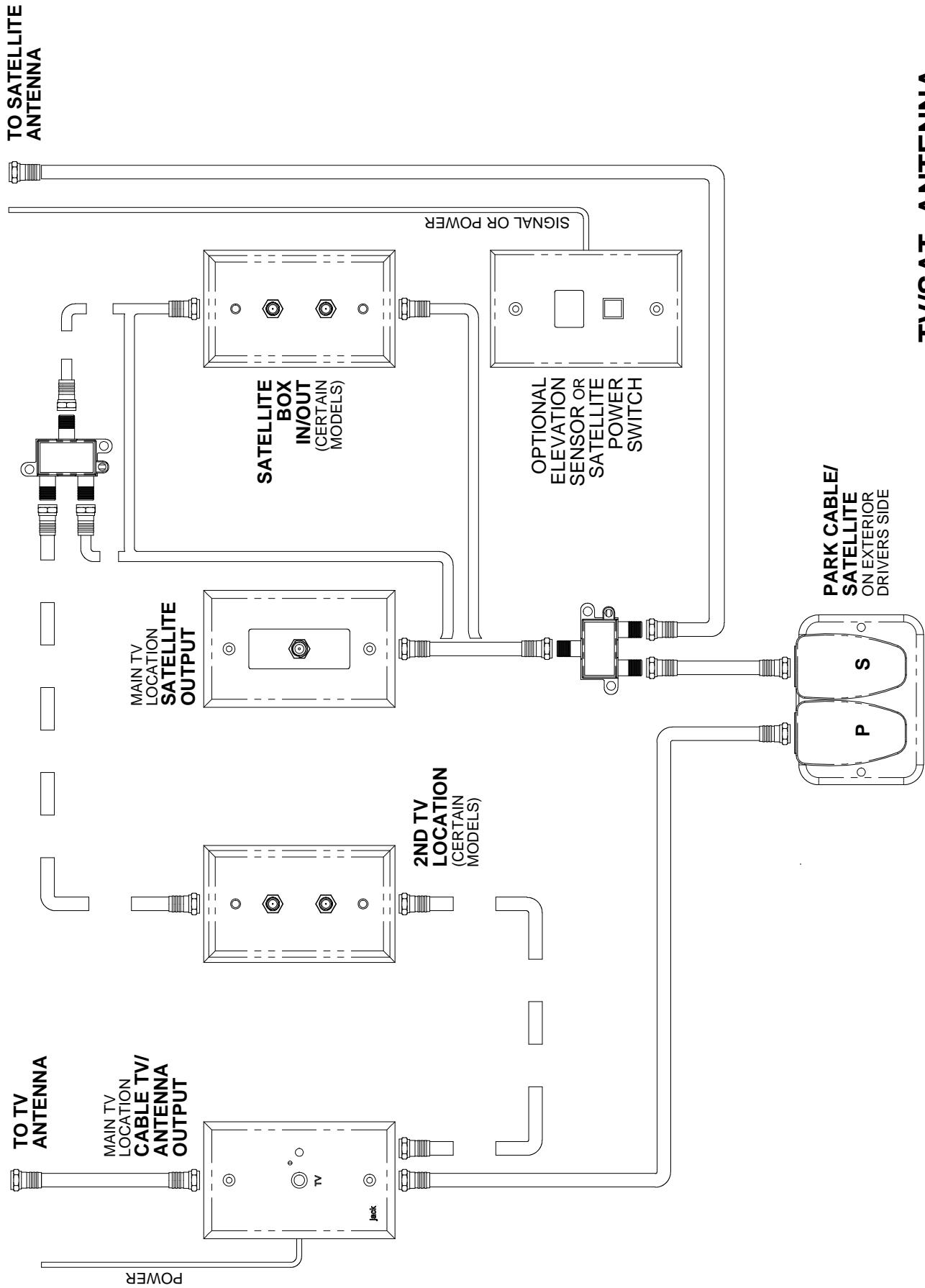

TV/SAT. ANTENNA

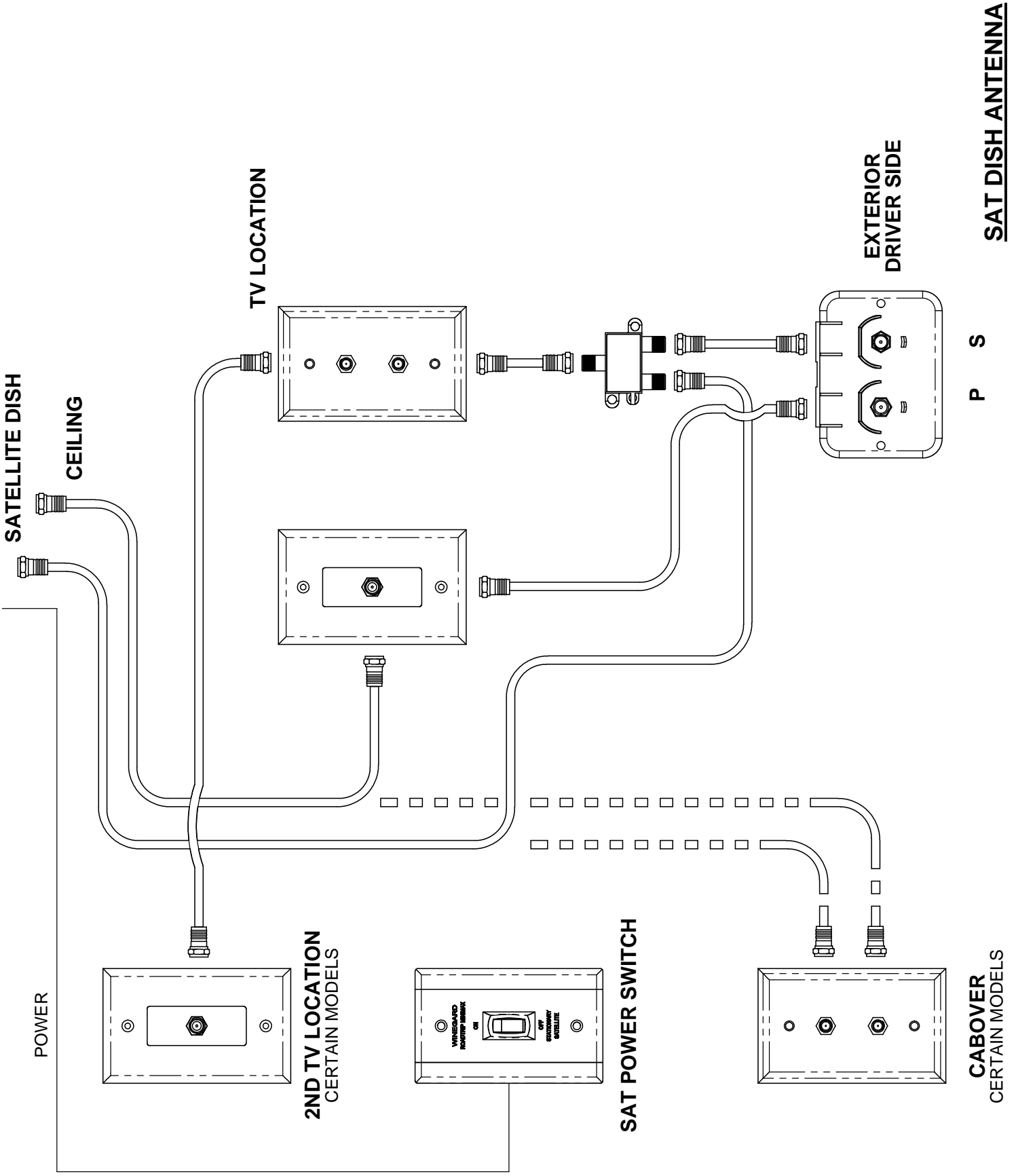

This page intentionally blank.

SUPPLIER SERVICE PHONE AND INTERNET LISTING

PRODUCT	SUPPLIER	PHONE	WEB SITE
Lance Service Department	Lance Camper Mfg. Corp.	661.949.3322	www.lancecamper.com
Access Doors	MNM Mfg.	318.898.1099	www.mnmmfg.com
Air Bags	Air Lift	800.248.0892	www.airliftcompany.com
Air Conditioner	RVP	316.832.3427	www.airxcel.com
Awning	Carefree of Colorado	800.621.2617	www.carefreeofcolorado.com
Backup Camera/Monitor	ASA	800.332.1506	www.asaelectronics.com
Battery Separator	Blue Sea Systems	888.222.7617	www.blueseas.com
Camper Cover	ADCO	800.541.2326	www.adcoprod.com
Carbon Monoxide and Propane Detector	M.T.I.	800.383.0269	www.mtiindustries.com
Convection Oven	Sharp	800.237.4277	www.sharppusa.com
Fire Extinguisher	BRK Electronics	800.323.9005	www.firstalert.com
Furnace	Dometic Corporation	877.898.7088	www.dometic.com
Generator	Onan	800.888.6626	www.onan.com
Jacks	Lippert Components	574.535.1125	www.lci1.com
Mattress	Serta Mattress Co.	888.557.3782	www.serta.com
Microwave Oven	High Pointe	800.334.8251	
Monitor Panel	American Technology	800.238.2687	www.atcomp.com
Power Center (Converter)	Progressive Dynamics, Inc.	269.781.4241	www.progressivedyn.com
Propane Tank	Manchester Tank	800.640.6327	www.manchestertank.com
Radio/CD/DVD	ASA	888.332.1506	www.asaelectronics.com
Range (w/oven)	Dometic Corporation	877.898.7088	www.dometic.com
Range Vent	YENG Industries	877.729.1205	www.yengindustries.com
Refrigerator	Norcold Inc.	800.543.1219	www.norcold.com
Regulator – Propane	Fairview	800.688.4088	www.fairviewfittings.com
Roofing	LaSalle Bristol	800.718.7187	www.lasallebristol.com
Roof Rails/Ladder/Rack	Topline Mfg.	800.653.0605	www.toplinemfg.com
Roof Vent	Dometic Corporation	877.898.7088	www.dometic.com
Roof Vent	Dometic Corporation	877.898.7088	www.dometic.com
Shock Absorbers	Rancho Shocks	734.384.7804	www.gorancho.com
Sink	American Stone Cast	574.206.0097	
Skylight	Dometic Corporation	800.898.7088	www.dometic.com
Skylight	GS Plastics, Inc.	574.262.1527	
Slide-Out Mechanism	Lippert Components	574.535.1125	www.lci1.com
Smoke Alarm	M.T.I.	800.383.0269	www.mtiindustries.com
Solar Panel	Evergreen Solar	508.357.2221	www.evergreensolar.com
Solar Panel Regulator	Go Power	866.247.7652	www.gpelectric.com
Tank Flush	Swan Industries, Inc.	541.389.4668	www.swanindustries.com
Thermostat	Dometic Corporation	877.898.7088	www.dometic.com
Tiedowns	Lippert Components	574.535.1125	www.lci1.com
Tiedowns	Torklift International	800.246.8132	www.torklift.com
Toilet	Thetford Corporation	800.521.3032	www.thetford.com
TV - LCD	ASA	888.332.1506	www.asaelectronics.com
TV Antenna	King Controls	952.922.6889	www.kingcontrols.com
Sat Dish	Winegard	319.754.0600	www.winegard.com
Water Heater	Dometic Corporation	877.898.7088	www.dometic.com
Water Heater - Tankless	Green RV Products	949.259.4024	www.greenrvproducts.com
Water Pump	Shurflo	800.854.3218	www.shurflo.com
Windows - Acrylic	Dometic Corporation	800.366.3842	www.dometic.com
Windows - Glass	SE-GI Products	949.297.8530	www.segiwindows.com
Winterizing Valve	Swan Industries Inc.	541.389.4668	www.swanindustries.com

This phone listing is provided to assist you in case of emergencies, if you are stranded somewhere not close to a Lance Service Center or qualified repair facility.

Due to continual product development, some suppliers, phone numbers and web sites may change from those shown.
6/19