

# STTF

Shree Ram Technical  
Training Foundation



**Design  
Innovation  
Training  
Manufacturing**



**KARNAM 3D**  
*Ideas to reality*

**STTF** **Banking  
Academy**

**STTF** **Agro  
Machines**

**STTF** **Data  
Tech**

**STTF** **Branding  
Solutions**

**STTF** **Placement  
Services**

**STTF** **English  
lab**

- Content Writing
- Banking Exam Coaching
- Digital Marketing Training
- Mechanical CAD / Civil CAD
- Software Development
- Sensor Technology
- IOT
- EV Technology
- JAVA FSD
- Python FSD
- AR / VR
- PLC SCADA
- Robotics & Automation Training
- Academic Projects Assistance
- Industrial Projects Service
- Placement Services
- 3D Printing Services.
- Agro Machines Manufacturing
- NPD Service
- Placement Training OJT
- GD&T Training
- Communicative English



Scan for WhatsApp

STTF, ShubhaSiri towers. Besides, JH Patel college  
#1692/2, BIET Rd, Siddaveerappa Layout, Davanagere

6364226016 / 6364226012 / 8197568543



www.stffindia.com



# STTF Profile

STTF, established in 2018, is dedicated to providing advanced technical education. Over the years, we've successfully trained over 1000 students in Davanagere. Specializing in Automotive design, Engineering Design Services, Functional Gauges Design, Product Development, Manufacturing, Robotics, IOT, JAVA/Python Full Stack development, 3D Printing services, Prototyping, and Govt exams Coaching.

Committed to enhancing student employability, we offer internships, workshops, and seminars in collaboration with colleges to foster skill development and job opportunities.

## Our Brands...





# *Agricultural equipments*

STF

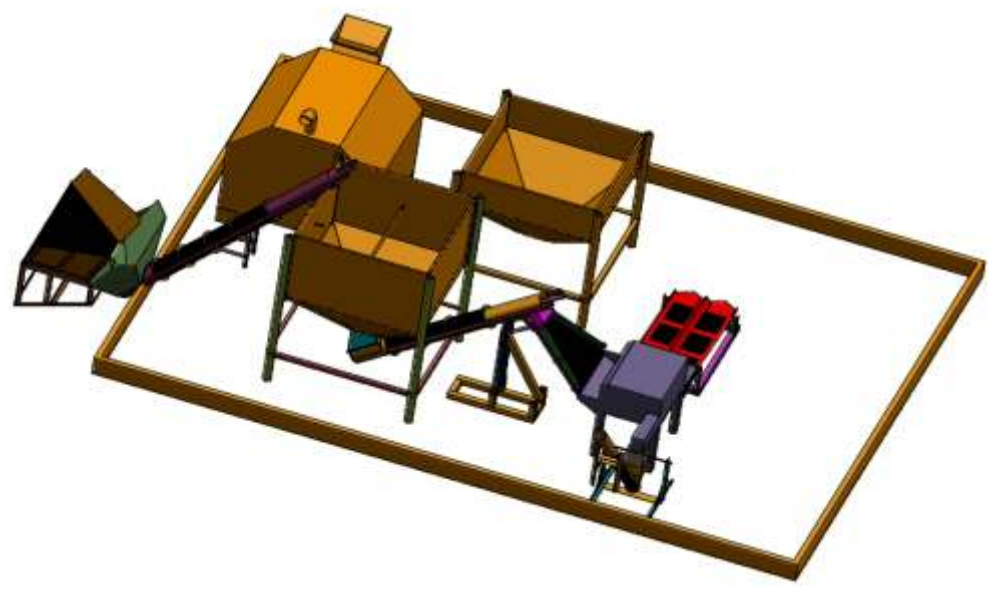
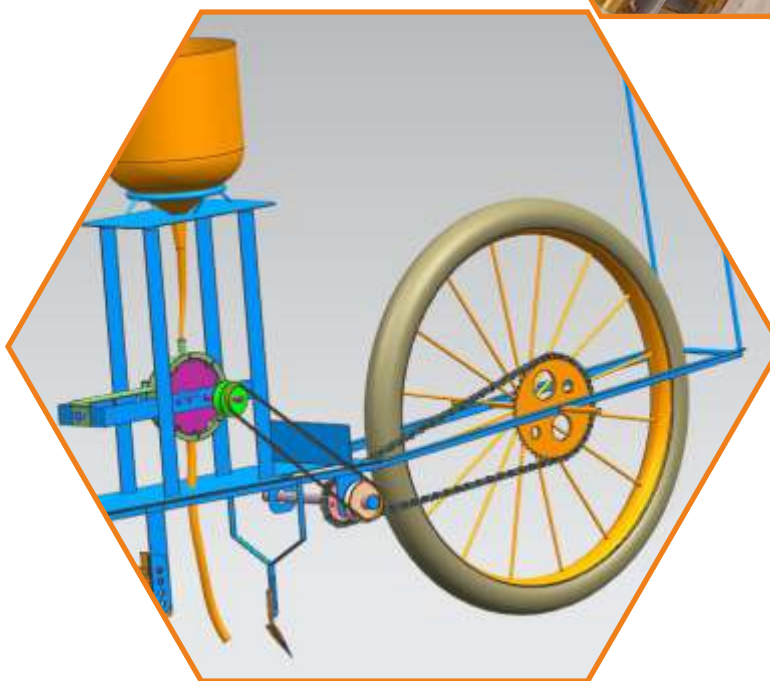



# 3D Printing Lab

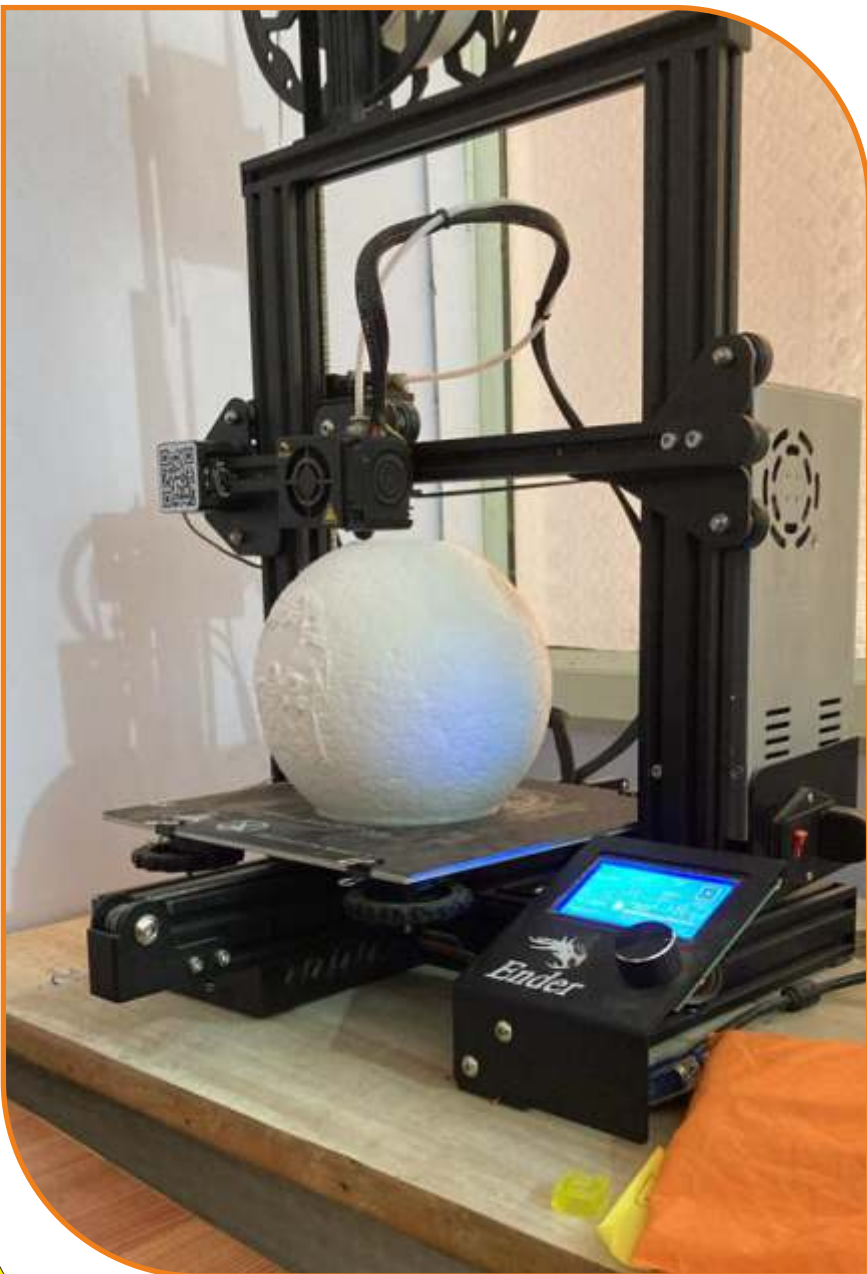
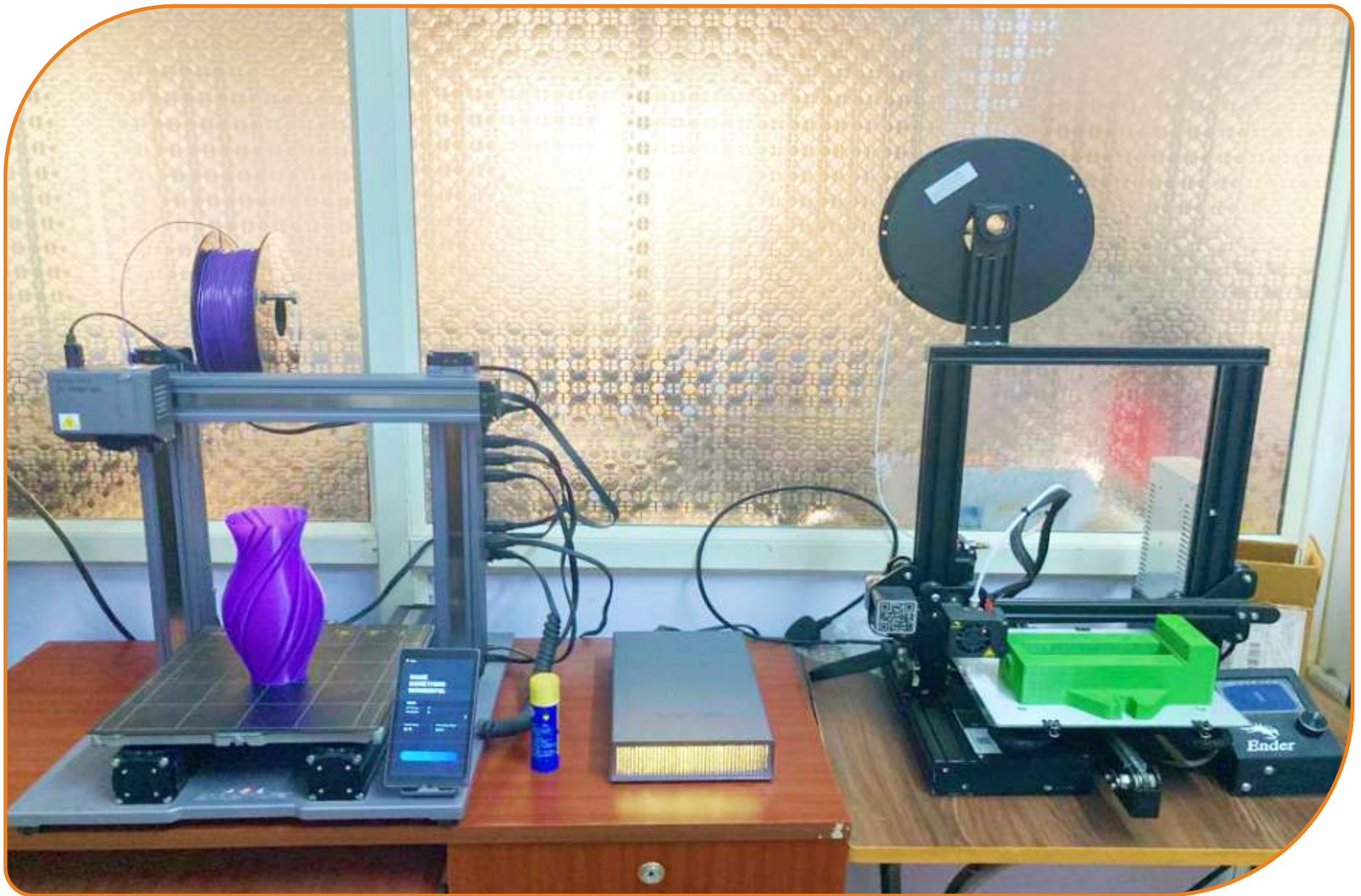



# 3D Printed Products

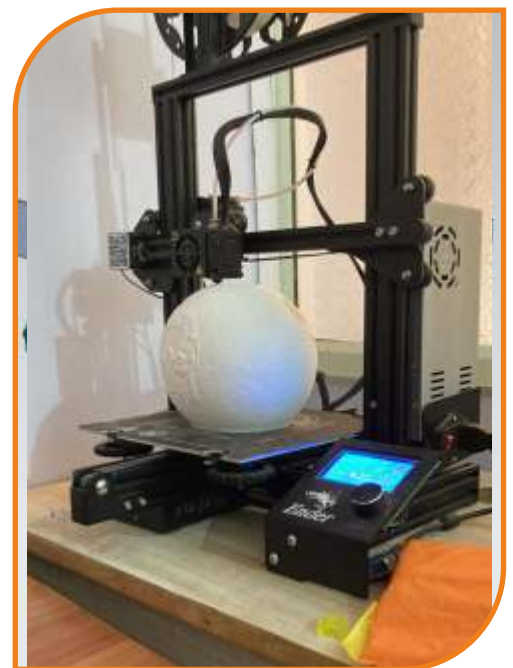
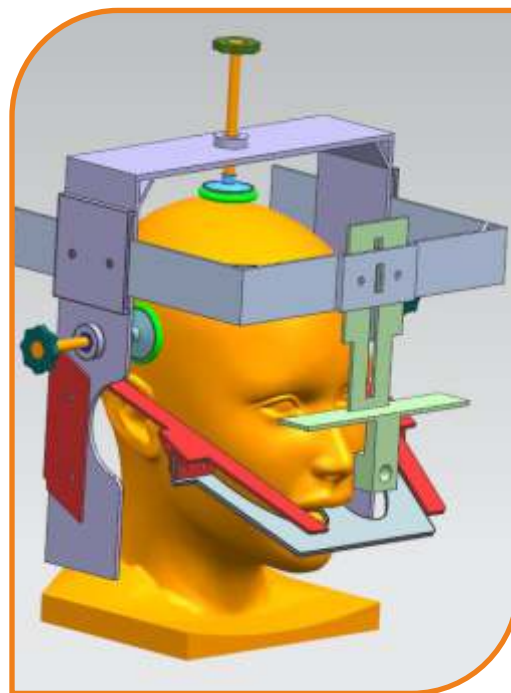
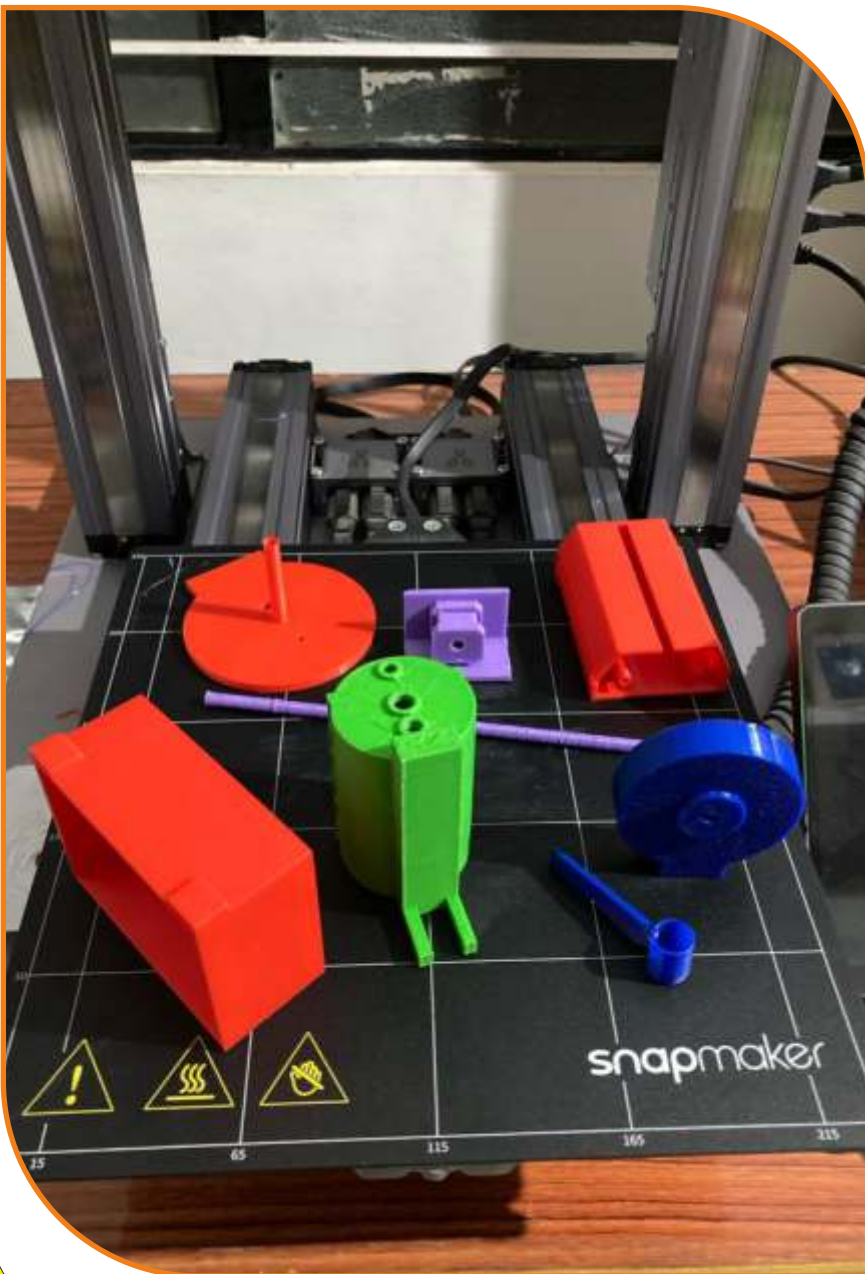
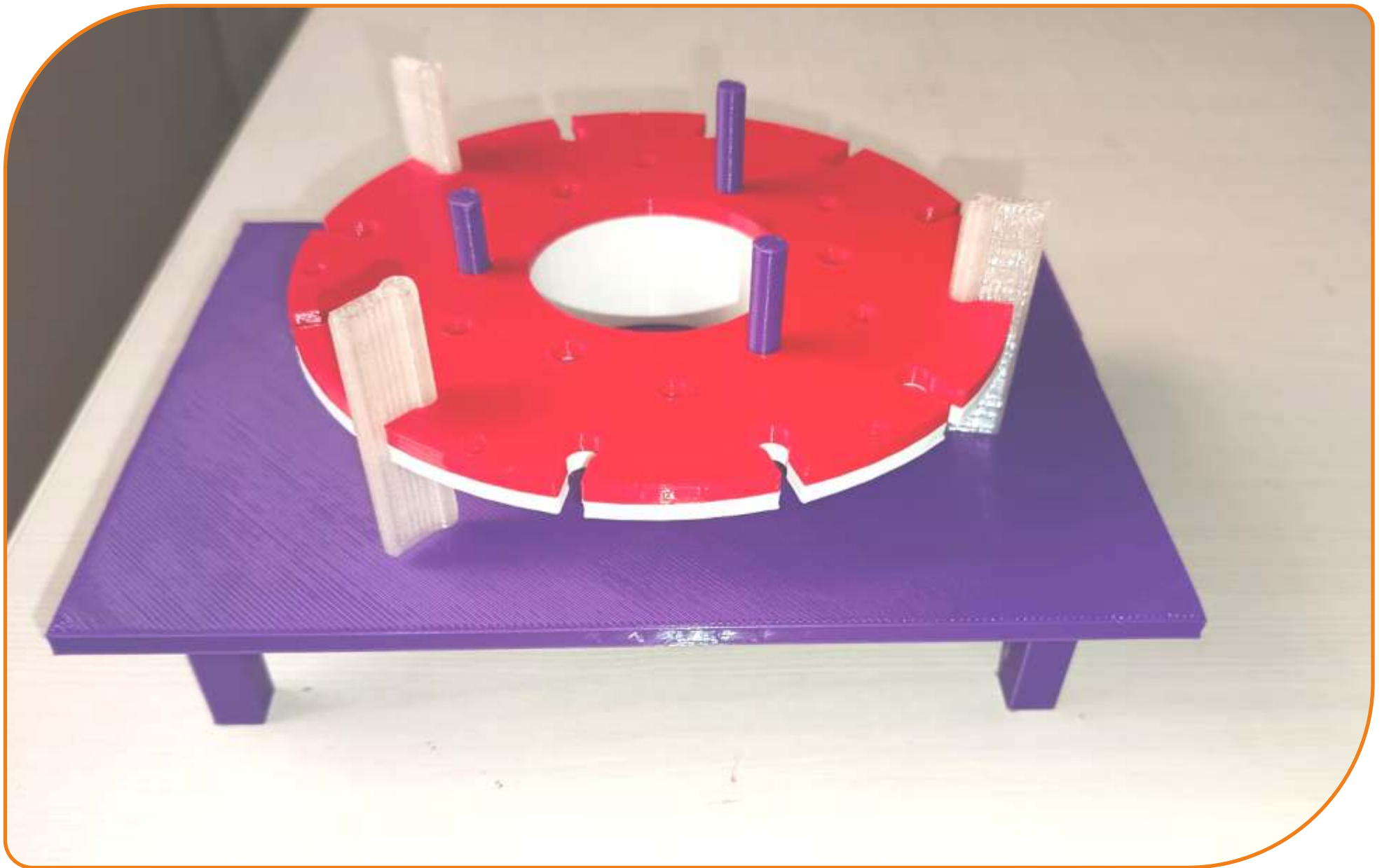



# STTF Courses



## IT COURSES

Data science with python  
Data Science with R Programming  
JAVA Full stack Development  
Python Full Stack Development  
Digital Marketing  
Graphics Design  
Advance Excel  
Advance JAVA(J2EE)  
ASP.Net MC  
Content Writing

C++  
Core JAVA  
Core Python Programming  
C#  
Mobile App Development  
PHP  
Tableau  
Tally ERP  
Web Design

**Competitive-  
Exams /  
Banking  
Exam  
Coaching**



# STTF College Tie-Ups



MOU signed with BIET Davanagere on 25/09/2021

## ಜಿ.ವಿಂ.ಐ.ಟಿ ಮೆಕ್ಯಾನಿಕಲ್ ಇಂಜಿನಿಯರಿಂಗ್ ವಿಭಾಗವು ಕ್ಯಾಡ್ ಡೆಸ್ಟಿನೊಂದಿಗೆ ಒಡಂಬಡಿಕೆ



ದಾವಣಗೆರೆ-ಇತ್ತೀಚಿನ ಸಂತ್ರಸ್ತರನ್ನು ಮತ್ತು ಅವಿಜ್ಞಾನಗಳಿಂದ ವಿಧ್ಯಾರ್ಥಿಗಳಿಗೆ ತಿಕ್ಕಣ ನೀಡಲು ಜಿ.ವಿಂ.ಐ.ಟಿ ಯಲ್ಲಿ ಮೆಕ್ಯಾನಿಕಲ್ ಇಂಜಿನಿಯರಿಂಗ್ ವಿಭಾಗವು ಅನೇಕ ಯೋಜನೆಗಳನ್ನು ಆರಂಭಿಸಿದೆ. ದಿನಾಂಕ 13/09/2021 ರಂದು ಮೆಕ್ಯಾನಿಕಲ್ ಇಂಜಿನಿಯರಿಂಗ್ ವಿಭಾಗವು ಕ್ಯಾಡ್ ಡೆಸ್ಟಿನೊಂದಿಗೆ (MoU) ಒಡಂಬಡಿಕೆಗೆ ಸಹಿ ಹಾಕಿದೆ. ಅನೇಕ ಕೈಗಾರಿಕಾ ಕ್ಷೇತ್ರದಲ್ಲಿ ಗುಣ ಮತ್ತು ವಿಸ್ತಾರ ಆಧುನೀಕರಣದ ಮೂಲಕ ಜನರಿಂದ ದುಡ್ಡು ಹಣ್ಣು ಒಂದು ಪ್ರಮುಖ ತಾಂತ್ರಿಕ ಕಾರ್ಯವೆ ಸಂಸ್ಥೆಯಾಗಿದೆ.

ಅನುಕರಣಿಸಿದೊಂದಿಗೆ ವಿವರವಾದ ಉತ್ಪಾದನಾ ಪ್ರಕ್ರಿಯೆಗಳನ್ನು ಪಡೆಯಲು ವಿಧ್ಯಾರ್ಥಿಗಳಿಗೆ ಸಹಾಯ ಮಾಡುತ್ತದೆ. 3ಡಿ ಮುದ್ರಣ ಸಂಪನ್ಮೂಲವನ್ನು ಕಾರ್ಯನಿರ್ವಹಿಸಿ ಕೈಬಿಡಿಸಿ ವಿಧ್ಯಾರ್ಥಿಗಳಿಗೆ ಉದ್ಯಮದಲ್ಲಿ ಬಳಸುವ ಸುಧಾರಿತ ಉತ್ಪಾದನಾ ಸಂಪನ್ಮೂಲಗಳನ್ನು ಆರ್ಥಮಾಡಿಕೊಳ್ಳಲು ಸಹಾಯ ಮಾಡುತ್ತದೆ. ಈ ಸಹಾಯಧರದಲ್ಲಿ ಕಾರ್ತವ್ಯ ಪ್ರಾಂಶುಪಾಲರಾದ ಡಾ. ವೈ. ವಿ. ವಿ. ಪ್ರಸಾದ್, ಮೆಕ್ಯಾನಿಕಲ್ ವಿಭಾಗದ ಪ್ರಮುಖಸ್ಥರಾದ ಡಾ. ಸಿ.ವಿ. ಪ್ರಸಾದ್, ವಿಭಾಗದ ಪ್ರಾಧ್ಯಾಪಕರಾದ ಶಿವಪ್ರಕಾಶ್ ಪಿ ಮತ್ತು ಪ್ರವಾಂಶ ಎಂ ಆರ್ ಕ್ಯಾಡ್

MOU signed with GMIT Davanagere on 13/09/2021



## Our Motto

**"Empowering through Quality Education and Inspiring Innovative Thinking is our motto at STTF. We prioritize the holistic development of every student, where our highly experienced instructors not only deliver comprehensive theoretical content but also place a strong emphasis on imparting practical knowledge of the highest quality."**



**MOU signed with Achariya Arts & Science College  
Puducherry, Tamil nadu**



# STTF College Tie-Ups



MOU signed with JIT Davanagere on 04/09/2021





# CNC Training



Manual & CAM Programming for-  
CNC & VMC Machines.

Practical Operating training on-  
CNC & VMC Machines



# Highlights of our GD&T Training

**Industry Experienced Trainers**

**ASME Y14.5 GD&T Standard Advanced Training**

**55 Assemblies**

**250 - '3D Models'**

**Gauges design exercises**

**Work Book**

**Reference book**



## CAD Courses

**Mechanical CAD**

**Electrical CAD**

**Civil CAD**

**Live projects**

## QA/QC

Quality Inspection Training Course

Quality Management Training Course

Six Sigma Yellow belt, Six sigma green belt





# STTF

*Systematic  
Training  
In pace with  
Latest Technology*

## Vision

To become a premier organization in Technical Training, enhancing innovative thoughts of youth , Engineering & Product development Services and Creating industry ready workforce to cater needs of the society

## Mission

"Empowering through continuous skill improvement, our mission at STTF is to develop innovative processes that shape highly employable candidates. Utilizing the latest facilities, trends, and techniques, we strive to meet the dynamic needs



# PROGRAMS



Class room Training  
Online Training  
Internships  
Projects  
Industrial Skills





# Our Industrial Tie - Ups

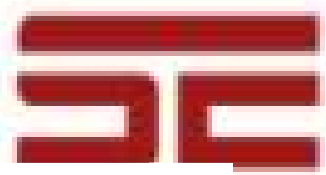

Smitra Gauges



**DELTA CNC**

**JOGNICS**  
*Since 1981*

SANCHAR Industries

**V-TEC cnc**

**AUTOCRAT**  
**ENGINEERS**



# Photo Gallery



## Contact Us

STTF, ShubhaSiri towers.  
Besides, JH Patel college  
#1692/2, BIET Rd,  
Siddaveerappa Layout,  
Davanagere

[www.sttfindia.com](http://www.sttfindia.com)  
[sttf001@gmail.com](mailto:sttf001@gmail.com)



6364226016  
6364226012  
8197568543



6364226016  
6364226012

WhatsApp QR Code



Facebook QR Code



LinkedIn QR Code



Website QR Code

