

# CAMARGUE®

## PRODUCT INFORMATION



# TABLE OF CONTENTS

<b>Description</b> .....	<b>3</b>
<b>Benefits</b> .....	<b>4</b>
Design .....	4
Quality .....	5
Customisation .....	6
Comfort .....	6
<b>Technical details</b> .....	<b>7</b>
Standard configuration .....	8
Camargue > 244" .....	9
Camargue weight .....	10
Camargue snow load .....	11
<b>Accessories</b> .....	<b>12</b>
<b>Certificates &amp; testing</b> .....	<b>14</b>
<b>Configuration</b> .....	<b>15</b>
Type .....	15
Construction method .....	19
Columns .....	21
Profiles .....	23
Waterproof wall connection .....	24
Blade orientation .....	25
Mounting bases .....	26
Water drainage .....	28
<b>Other tools</b> .....	<b>29</b>





## DESCRIPTION

**Modular aluminium patio cover with rotating blades and integrated side elements.**

- Modular support structure
- Integrated side elements and accessories
- Can be joined in multiple parts on both the span and pivot side, even after first installation
- Can be controlled using RTS



One roof section

SUN  
PROTECTION

VENTILATING

WATER-  
RESISTANT

# BENEFITS

## Design

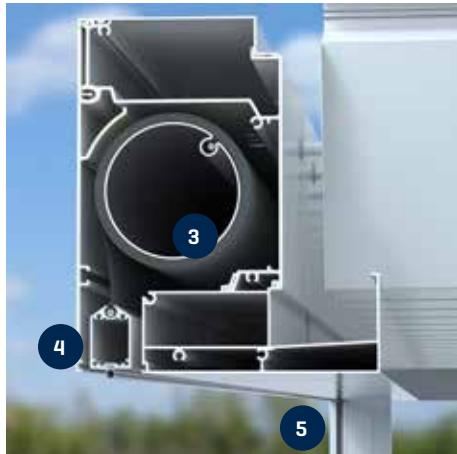

### 1 MODULAR DESIGN

Expandable to include multiple roof sections, even after initial installation. The structure can be endlessly expanded on both the span and pivot side to cover large surface areas.

### 2 INVISIBLE SCREWS

Create an elegant and sleek structure

### 3 THE FABRIC ROLLER TUBE IS FULLY INTEGRATED INTO THE STRUCTURE

#### INNOVATION

No visible screen head box disrupting the aesthetic

### 4 THE BOTTOM BAR DISAPPEARS INTO THE HEAD BOX

### 5 FIXSCREEN SIDE GUIDING CHANNELS ARE INTEGRATED INTO THE COLUMNS

#### INNOVATION

Full aesthetic integration with the Camargue structure



### 6 MINIMAL GAPS BETWEEN THE BLADES

Lend a stunning and sleek finish

### 7 INTEGRATED MOTOR

Forms a stunning minimalist design, without a motor disrupting the aesthetic.



## Quality

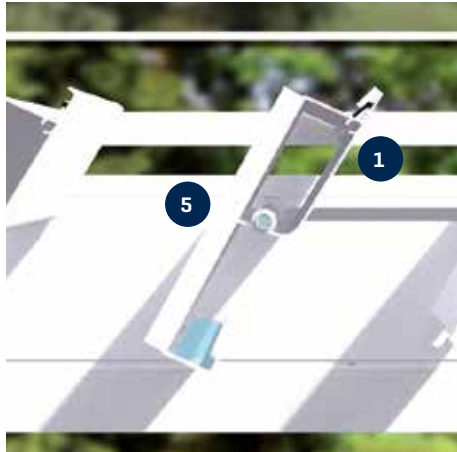

### 1 DOUBLE-WALLED BLADES FOR EXTRA STRENGTH

Load-bearing capacity: 40.96psf

### 2 F2 TECHNOLOGY

#### INNOVATION

With a span system that ensures the rigidity of its support structure, Camargue remains stable even in strong winds. [pivot  $\geq 177''$ ]

### 3 UNIQUE END CAPS

Provide a solid corner connection and perfect water drainage

### 4 NO HOLES IN THE WATER CHANNEL

An additional chamber means no holes need to be drilled in the water channel when affixing side infills

### 5 WELDED ALUMINIUM DRIPS, POWDER-COATED TO MATCH THE BLADE COLOUR

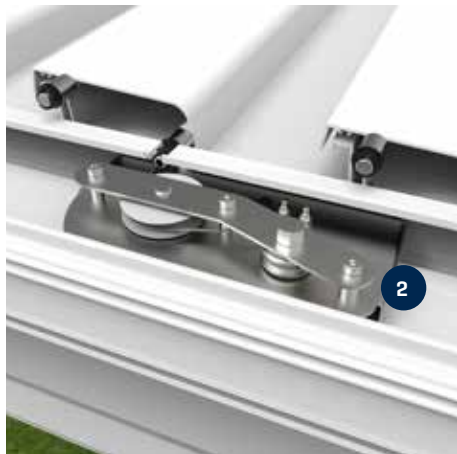

### 6 INTEGRATED WATER DRAINAGE WITH LARGE FLOW

Through the wide blade gutters, water flows towards gutters with diffusers to prevent splashing before being drained via PVC drainpipes integrated into the columns.

### 7 RIGID STRUCTURE

Span system lends rigidity to the support structure

## Customisation



### 1 WIDEST RANGE OF SIDE INFILLS

---

### 2 BACK ORDERS POSSIBLE

---

### 3 ACCESSORIES

---

For more information about the possible accessories, see the 'Accessories' section and/or the product information for the various accessories.

## Comfort

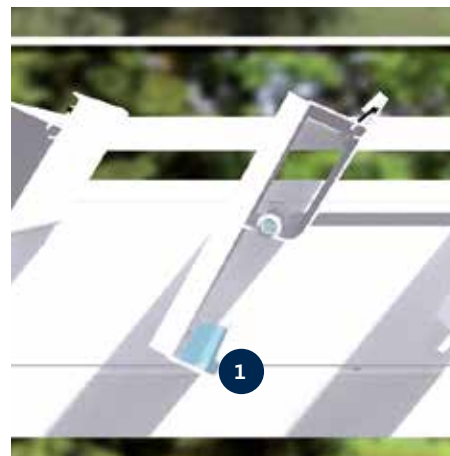

### 1 SPECIALLY DEVELOPED GUTTER BORDER

---

#### INNOVATION

Prevents the patio and furniture from getting wet when the blades are opened after a rain shower

### 2 SILENT AND SOFT CLOSING MECHANISM

---

By adding a brush to the blades

### 3 QUICK INSTALLATION

---

Thanks to maximum pre-assembly and the modular structure of the various junctions

### 4 MAXIMUM NATURAL LIGHT

---

Blades open up to 150°

# TECHNICAL DETAILS



Dimensions	
Span	Min. 71" * - max. 177"
Pivot	Min. 71" * - max. 244"/277" **
Passage height	Min. 17" - max. 110"
Total height with blades closed	Passage height + 10 15/64"
Total height with blades 90° open	Passage height + 1' 1 31/32"
Minimum height required when installed under a roof overhang	Passage height + 1' 2 3/8"
Blade rotation	Max. 150°
Minimum number of water drainage points < 172sqm	1
Minimum number of water drainage points > 172sqm	2***
Operating methods	
Somfy RTS	✓
Home automation ready	✓

\* Smaller dimensions [span min. 1' 7 11/16" and pivot min. 4' 1 29/64"] possible by special request to pre-sales - drawing office.

\*\* Pivot > 244" possible subject to a number of conditions. See the "Camargue > 244" ".

\*\*\* Please note: If only one column is used, the water drainage capacity will be limited to 0.40GPM [gallons per minute]

## Electrical bladed roof drive

Parameters	Value
Supply voltage	110V AC, 50 Hz
Transformer current range	0 - 2.5 Ampère
Transformer power	100 W
Motor voltage	24 Volt DC
Motor nominal current	3 Ampère
Protection rating	IP 66 Dynamic
Maximum running time with continuous use	Approx. 2 minutes
Automatic	16 A curve C



## Standard configuration

### Structure

- Free-standing or façade mounted [against whole wall or partial connection]
- Standard mounting bases [visible, invisible or cast]
- Custom span, pivot and passage height made to measure
- Motor drive with choice of motor position
- Blade orientation [sun protection or maximum sunlight]

### Finish

- Seaside Quality A
- Monocolour or dual colour according to Renson® standard colours
- Integrated water drainage [incl. PVC drainage pipes and anti-splash diffusers in the gutter]
- Adjustable installation and drainage holes



## Camargue > 244"

- Maximum pivot dimension: 277"
- Maximum span dimension: 157" (once pivot length is greater than 244")
- Number of columns per free-standing pivot side: minimum three.
- Maximum free space between two columns: 232"
- Shifted column: NOT possible
- Join on the pivot side to obtain a longer span: NOT possible
- Join on the span side to obtain a longer pivot: IS possible
- Minimum number of water drainage points: three, of which two on the lowest side
- Heat & Sound Beam: NOT possible on the pivot side
- Maximum number of Led blades: 3
- Maximum number of glass blades: 5
- Maximum number of Lineo Fix blades: 4



## Camargue weight

		Total weight (lbs) of entire Camargue														
		Span														
Pivot	Dimensions in inches	# blades	78	86	94	102	110	118	125	133	141	149	157	165	173	177
		108	10	541	565	587	611	635	660	684	706	730	754	779	803	825
	117	11	563	587	613	638	662	688	713	739	763	788	814	838	865	876
	125	12	585	611	638	664	691	717	743	770	796	823	849	876	902	915
	134	13	605	633	662	688	717	746	772	801	829	856	885	913	940	955
	142	14	627	657	686	715	743	774	803	832	863	891	920	948	979	993
	150	15	649	680	710	741	772	803	834	865	893	924	955	986	1017	1032
	159	16	671	704	735	768	799	832	863	896	926	960	990	1023	1054	1072
	167	17	693	726	759	792	827	860	893	926	960	993	1026	1059	1094	1109
	176	18	715	750	783	818	854	889	922	957	993	1028	1061	1096	1131	1149
	184	19	737	772	810	845	880	918	953	988	1026	1061	1098	1134	1169	1187
	193	20	759	796	834	871	909	946	984	1021	1059	1096	1134	1171	1209	1226
	201	21	781	818	858	896	935	975	1012	1052	1090	1129	1169	1206	1246	1266
	210	22	801	843	882	922	962	1004	1043	1083	1123	1165	1204	1244	1284	1303
	218	23	823	865	907	948	990	1032	1072	1114	1156	1198	1239	1281	1323	1343
	227	24	845	889	931	975	1017	1061	1103	1145	1189	1231	1275	1317	1361	1383
	235	25	867	911	955	999	1043	1090	1134	1178	1222	1266	1310	1354	1398	1420
	244	26	889	935	979	1026	1072	1116	1162	1209	1255	1299	1345	1392	1438	1460
	252	27	911	957	1004	1052	1098	1145	1193	1239	1286	1334	1381			
	261	28	933	982	1030	1079	1127	1173	1222	1270	1319	1367	1416			
	269	29	955	1004	1054	1103	1154	1202	1253	1303	1352	1403	1451			
	277	30	975	1028	1079	1129	1180	1231	1284	1334	1385	1436	1486			

The table above shows the weight of the frame; the weight of the columns and mounting bases is not included. Each column in the configuration adds an extra weight of 12.57lbs/column metre.

### Standard mounting base weight

- invisible mounting base: 4.52lbs
- cast mounting base: 7.92lbs
- visible mounting base: 9.81lbs
- visible [corner]: 6.80lbs

### Reinforced mounting base weight

- invisible mounting base: 15.97lbs
- visible mounting base: 24.88lbs
- visible [corner]: 19.87lbs

## Camargue snow load

		Maximum snow load Camargue (psf)										
		Span										
Pivot	Dimensions in inches	78	88	98	108	118	127	137	147	157	167	177
		157	177	115	78	55	40	30	23	17	13	10
	167	177	115	78	55	40	30	23	17	13	10	8
	177	177	115	78	55	40	30	23	17	13	10	8
	187	176	115	78	55	40	30	23	17	13	10	8
	196	148	115	78	55	40	30	23	17	13	10	8
	206	126	109	78	55	40	30	23	17	13	10	8
	216	108	94	78	55	40	30	23	17	13	10	8
	226	93	80	71	55	40	30	23	17	13	10	8
	236	81	70	61	54	40	30	23	17	13	10	8
	244	72	62	55	49	40	30	23	17	13	10	8



# ACCESSORIES



Comfort pack		Back order
Fixscreen + Lineo Led	-	-
<b>Side infills</b>		
Integrated Fixscreen	✓	✓
Algarve Fixscreen	-	-
Lapure Fixscreen	-	-
Triangle	-	-
Loggia sliding panels	✓	✓
Loggiascreen Canvas sliding door	✓	✓
Glass sliding panels*	✓	✓
Linius wall*	✓	✓
Linarte wall*	✓	✓
Outdoor curtains	✓	✓
<b>Comfort</b>		
<b>Lighting</b>		
Lineo Led	✓	✓
UpDown Led	✓	✓
Colomno Led	✓	-
Lapure Led	-	-
<b>Comfort and design</b>		
Beam Heat & Sound	✓	✓
Lineo Luce	✓	✓
Lineo Fix	✓	✓
Lineo Heat	✓	✓
Waterproof wall mounting	✓	-
Protecto protective profile	✓	✓
<b>Automation</b>		
Wind sensor	✓	✓
Rain sensor	✓	✓
Sun sensor	-	-

\* subject to use of reinforced mounting bases on adjacent columns



Styling		Back order
Classic Line	-	-
Wooddesign roof blades	✓	✓
Columns		
Extra column	✓	-
Shifted column	✓	-
Adjustable wall column	✓	-



# CERTIFICATES & TESTING

## CE – DoP documents

- CE / DoC / DoP / ETA
- EUROCODE / abZ

## Certificates

- Miami Dade – NOA
- UL / ETL certificate US – Canada / CCC
- REACH / seaside/coastal powder coating guarantee
- RoHS / AluEco
- VMRG sun protection

## Declarations

- Declaration of material codes
- Declaration of testing – overview
- Declaration of powder coating
- Declaration of anodisation layer thickness
- Declaration of glass properties
- Declaration of fire resistance / reaction
- Declaration of endurance cycles
- Declaration of safety resistance water pocket
- Declaration of electrical safety
- Declaration of UV resistance / gtot + others
- Declaration of asbestos

## Test reports – calculations

- Water testing / sand resistance test / IP test
- Cycle testing
- Wind [load] testing / verification certificate
- Static load test / calculation
- Environmental statement [recycled aluminium]
- Anchoring requirements
- Gravity-wind load deflection & structural test
- Wind resistance, air flow of the blades

<b>Wind guarantee of roof with blades closed</b>	up to 99mph – HC 2 (Hurricane Category 2)
<b>Wind guarantee of roof with blades open</b>	/*
<b>Fixscreen wind guarantee when closed</b>	up to 37mph
<b>Max. wind speed for roof or Fixscreen operation</b>	up to 31mph
<b>Water drainage flow</b>	0.66GPM [gallons per minute]
<b>Load-bearing capacity</b>	40.96psf

\* We recommend against opening the blades in high winds > 31mph, as there is a risk that the blades may start vibrating and operating the blades is only permitted up to 31mph.

# CONFIGURATION

## Type

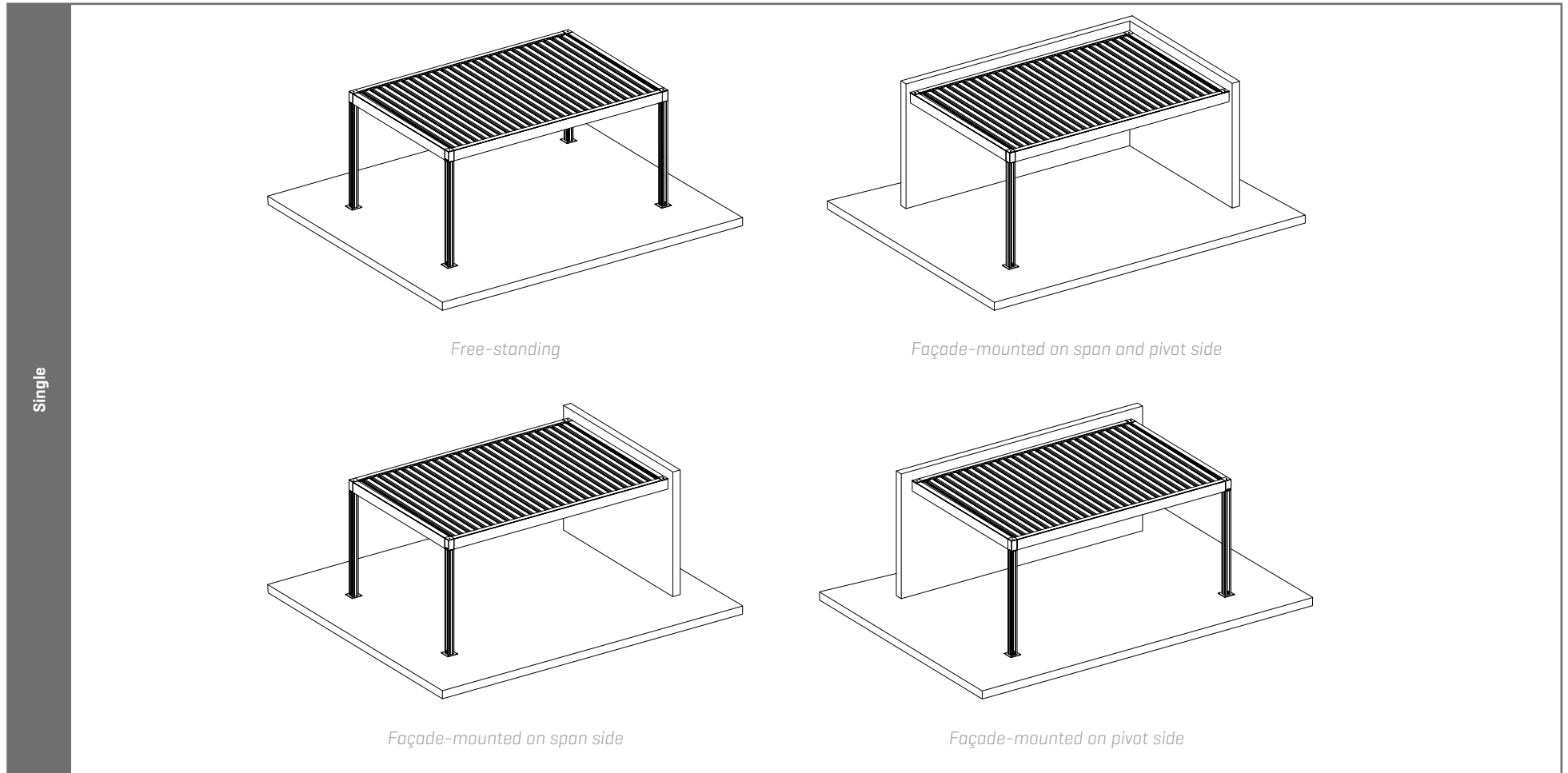

Two sections joined on pivot side

Free-standing

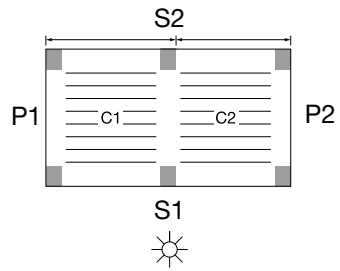

Two roof sections + six columns

Façade-mounted on span side

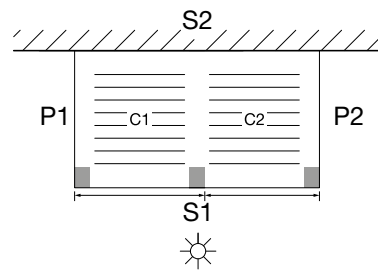

Two roof sections + three columns

Façade-mounted on pivot side

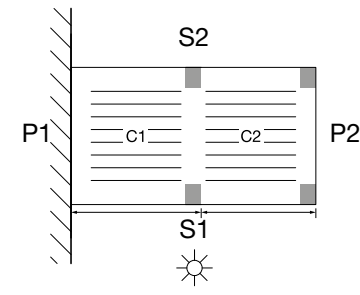

Two roof sections + four columns

Three sections joined on pivot side

Free-standing

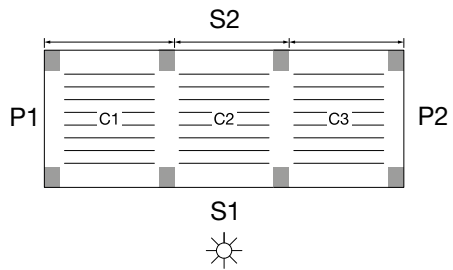

Three roof sections + eight columns

Façade-mounted on span side

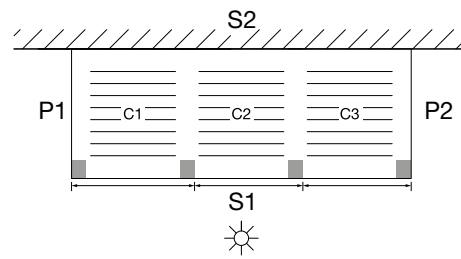

Three roof sections + four columns

Façade-mounted on pivot side

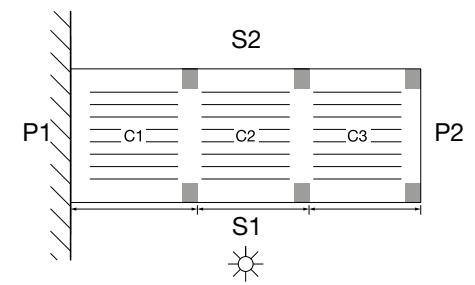

Three roof sections + six columns



Two sections joined on span side

**Free-standing**

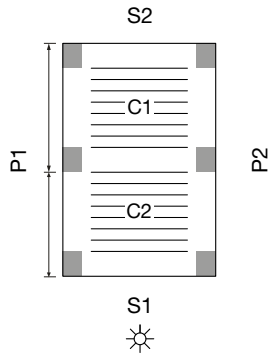

Two roof sections + six columns

**Façade-mounted on span side**

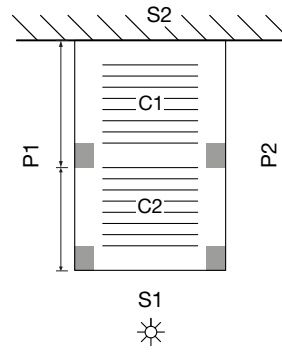

Two roof sections + four columns

**Façade-mounted on pivot side**

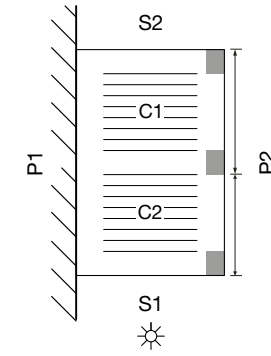

Two roof sections + three columns

Three sections joined on span side

**Free-standing**

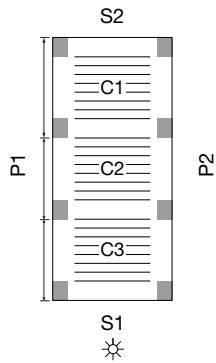

Three roof sections + eight columns

**Façade-mounted on span side**

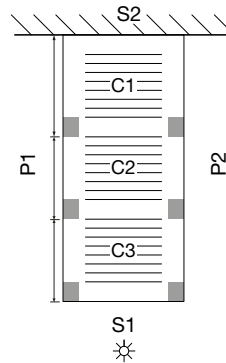

Three roof sections + six columns

**Façade-mounted on pivot side**

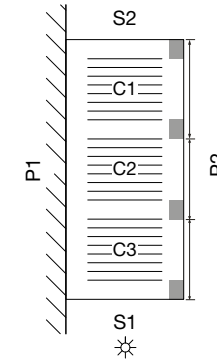

Three roof sections + four columns

Matrix shape

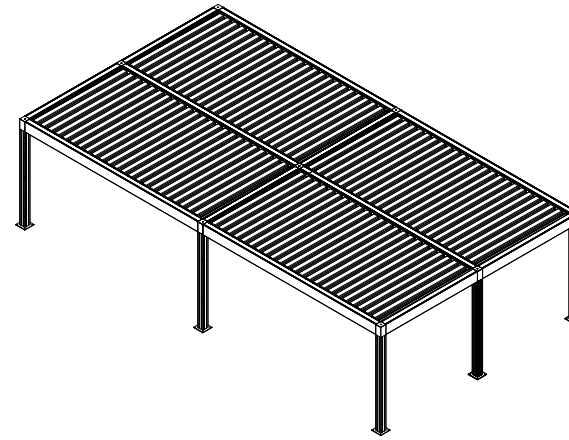
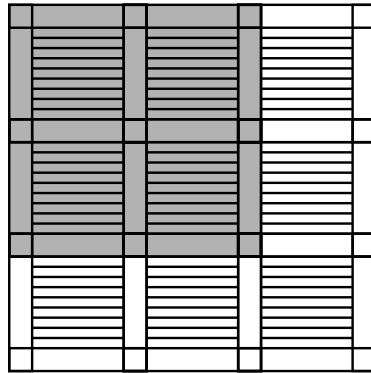

*only possible via presales*

L shape

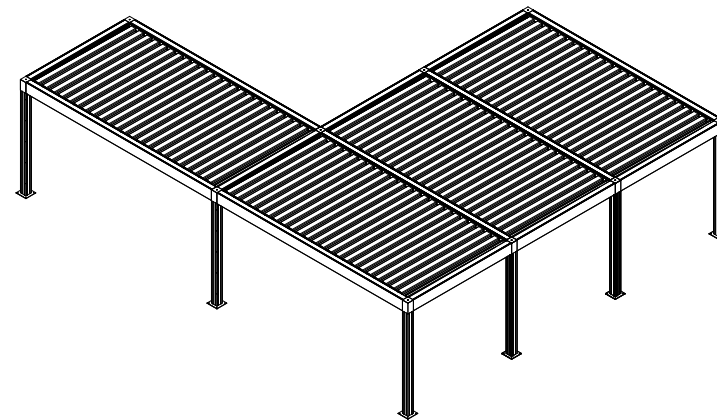
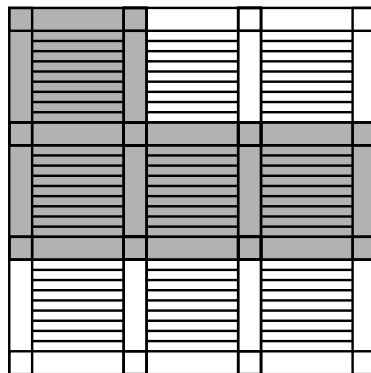

*only possible via presales*

## Construction method

Free-standing

The sides are completely separate from any walls; the cover is not mounted against any walls.

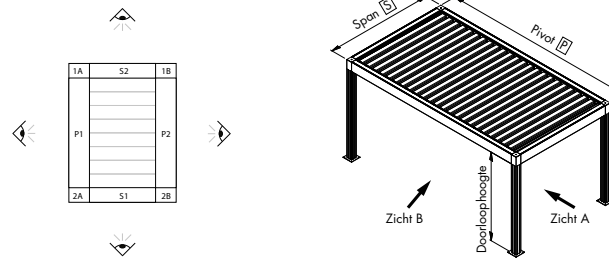

Full-length wall mounted

The full length of the side is mounted against a wall.

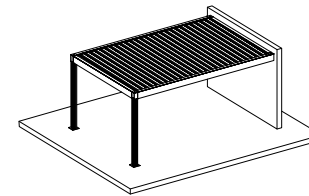
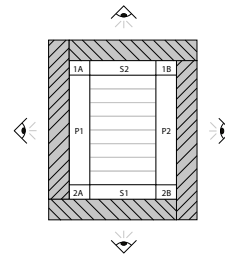

full-length wall mounted [façade mounted] on span side

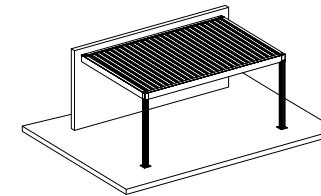

full-length wall mounted [façade mounted] on pivot side

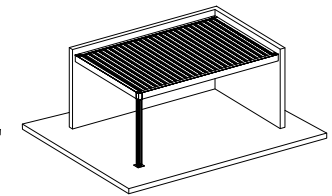

full-length wall mounted [façade mounted] on span and pivot side

Wall to the left

Only part of the side is mounted against a wall. Viewed from outside of the cover, the wall is located on the left side of the beam.

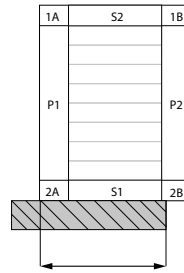

wall length

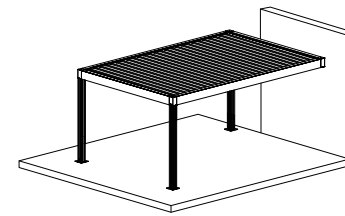

wall to the left [span]

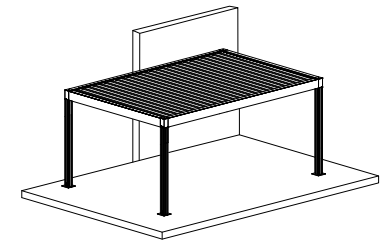

wall to the left [pivot]

Wall to the right

Only part of the side is mounted against a wall. Viewed from outside of the cover, the wall is located on the right side of the beam.

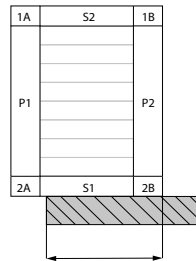

wall length

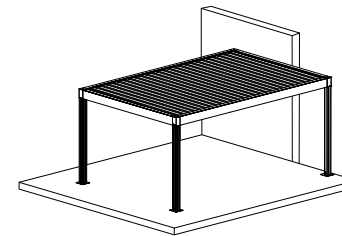

wall to the right [span]

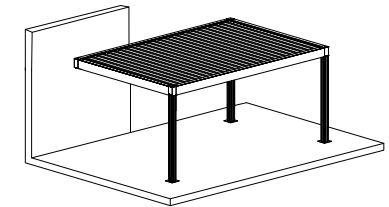

wall to the right [pivot]

Wall in the middle

A limited part of the cover is mounted against a wall. There is a free-standing section of the cover both to the left and to the right of the wall.

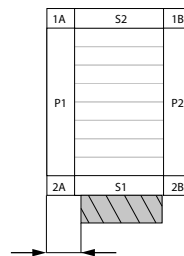

distance on the left to the wall

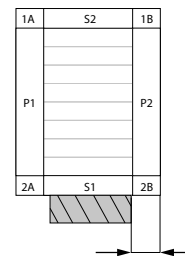

distance on the right to the wall

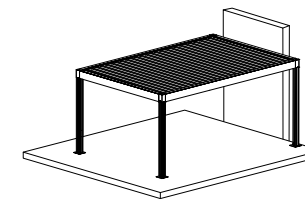

wall in the middle [span]

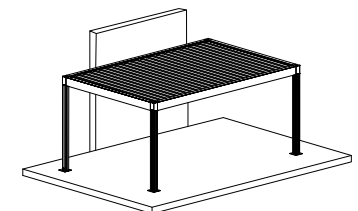

wall in the middle [pivot]



## Columns

### Corner column

A column is provided for each corner as standard. When installing against a wall that guarantees sufficient stability, the column on this side may be omitted.

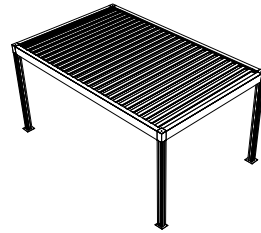

### Shifted column

A column may be shifted in the direction of the pivot to a maximum of 1/5 of the pivot length. This guarantees the stability of the construction at all times.

A shifted column in Camargue and Camargue Skye is entered by entering the required distance from the corner. It is not possible to shift a column in the span direction.

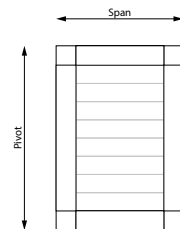
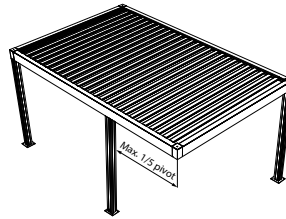

### Adjustable wall column

When installing Fixscreens at a right angle to a façade, a column must be fitted. Given the fact that outside walls are not always built perfectly plumb, a visually disruptive opening may form between the wall and the column. An adjustable wall column guarantees a flush connection and compensates for an angle of  $25/64''$  to the front or  $25/64''$  to the rear.

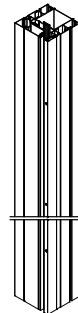
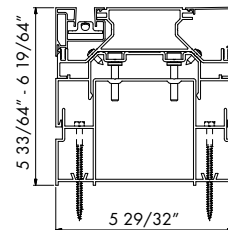

### Shorter/longer columns

A column that is longer (positive overlength) or shorter (negative overlength) than the entered passage height may be ordered. Opting for a positive overlength can be useful to keep a roof perfectly level when your patio slopes downward, for example. Alternatively, if one of the columns is to be installed on a small wall, for example, it can be shortened (negative overlength).

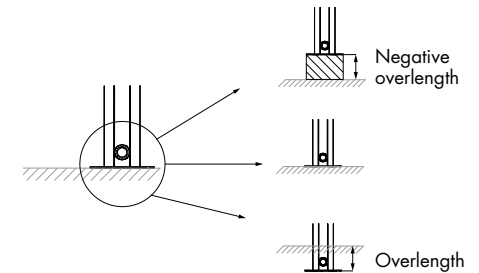

Positive overlength is possible up to the maximum passage height [110"] plus 19" [129"].

Negative overlength is possible up to the minimum passage height [= 19"].

Overlength only affects the price if the column length >118".

## Additional column

By adding an additional column, one side of the covering is divided into two parts. The position of the additional column is always viewed from side P1 [additional column on span] or S1 [additional column on pivot].

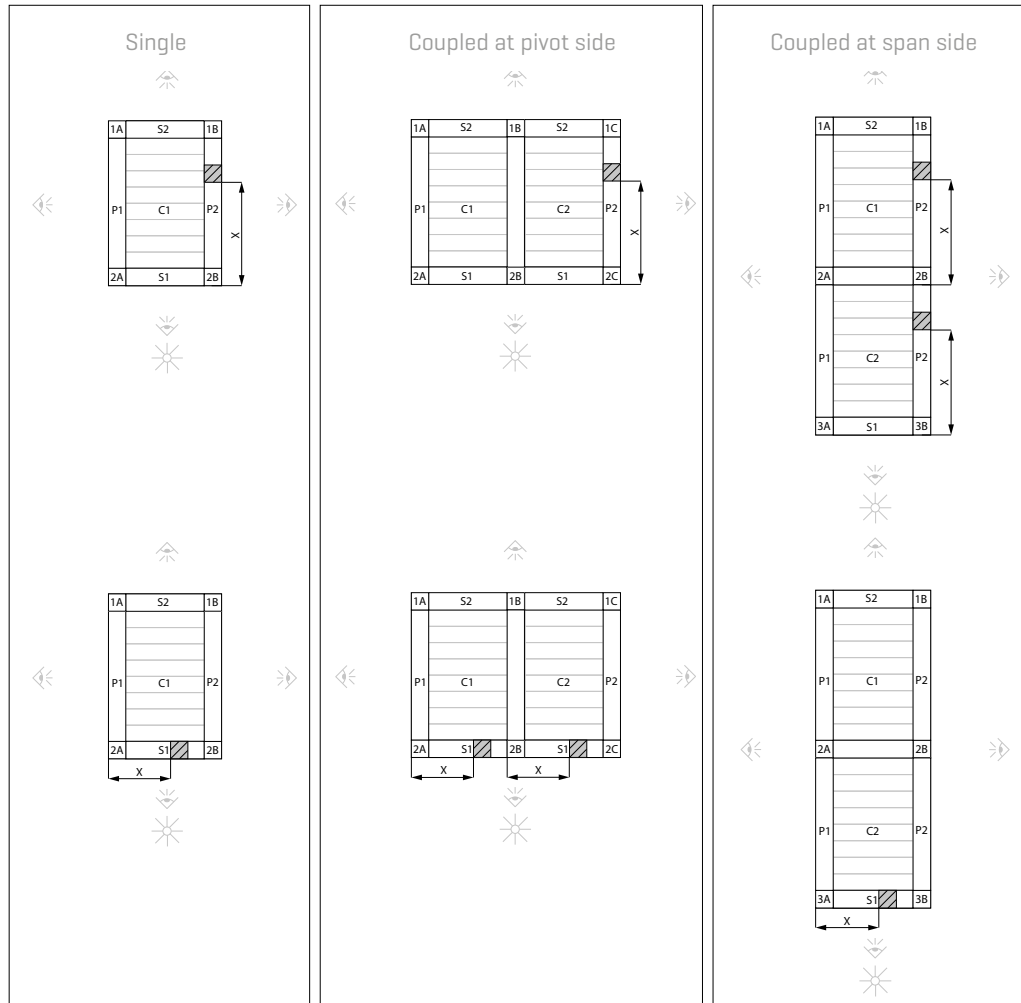
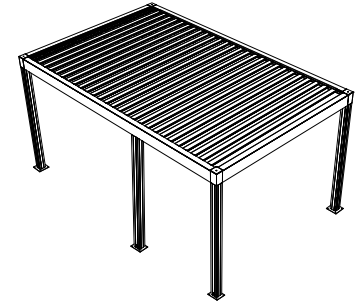

X = position of the intermediate column [mm]

# Profiles

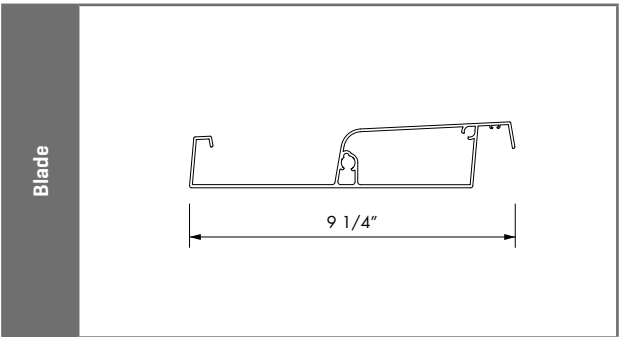
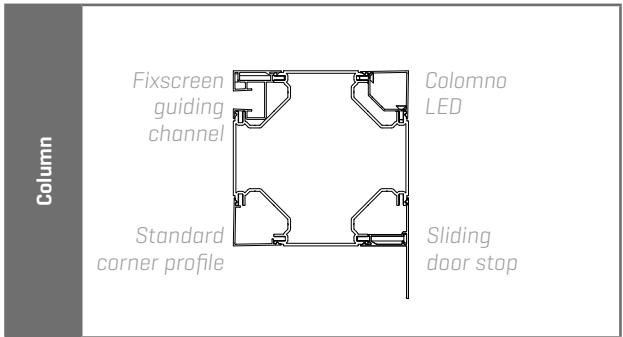
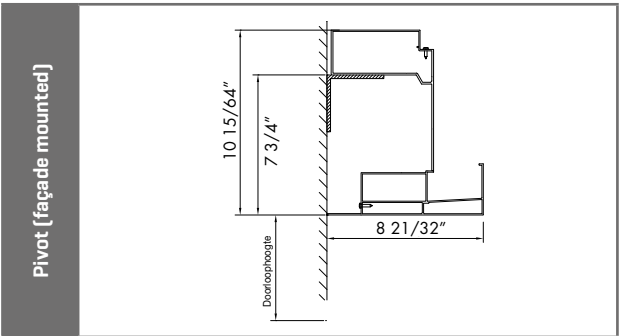
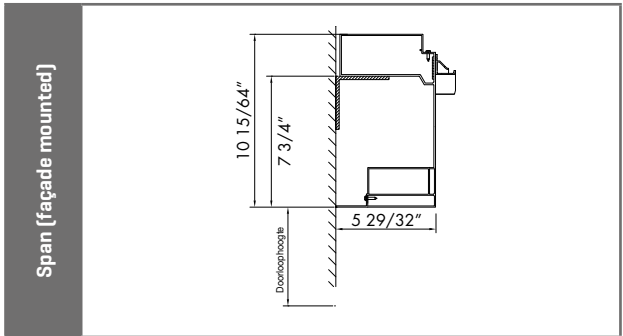
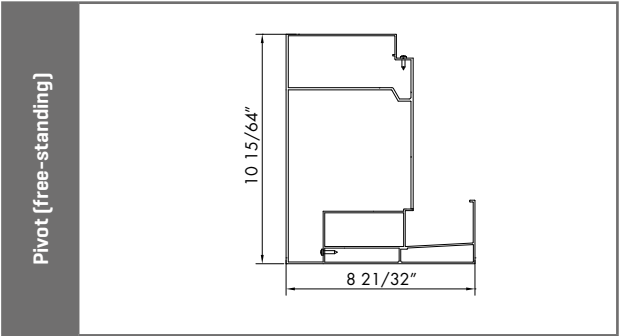
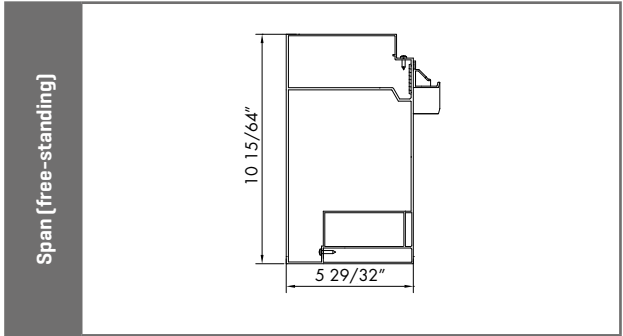
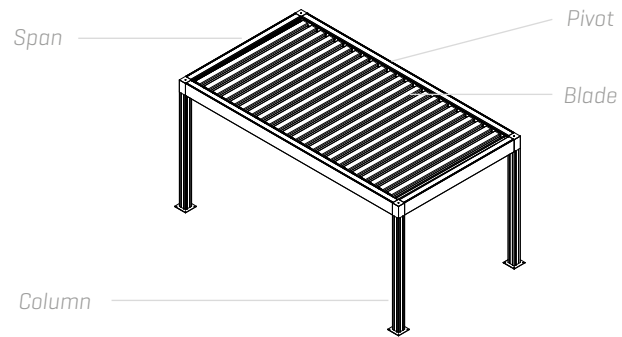

## Waterproof wall mounting

This [optional] solution guarantees a waterproof connection between Camargue and the façade. This is only applicable to covers with a side fully or partially mounted against a wall, and not to free-standing covers placed against a wall.

- Prevents water seepage between the façade and Camargue
- Also sealed against powder snow
- Compensates for irregularities in the façade up to 25/32"
- Easy installation and disassembly
- Controls accessible without removing and re-applying silicone

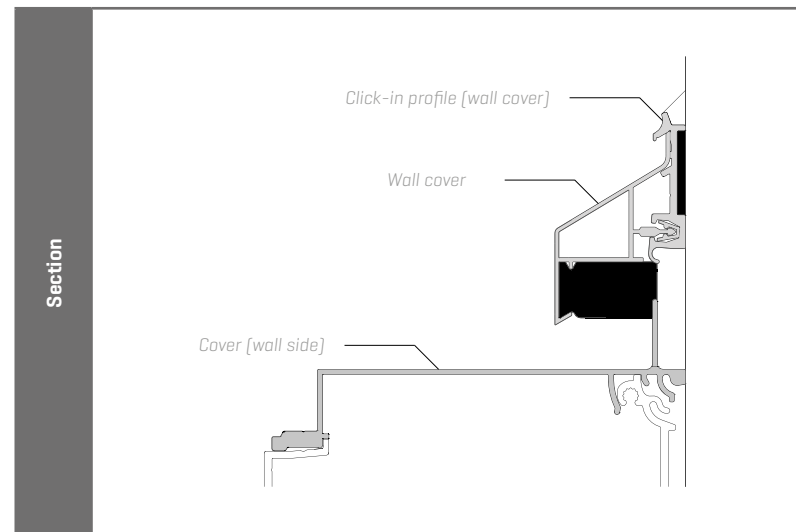
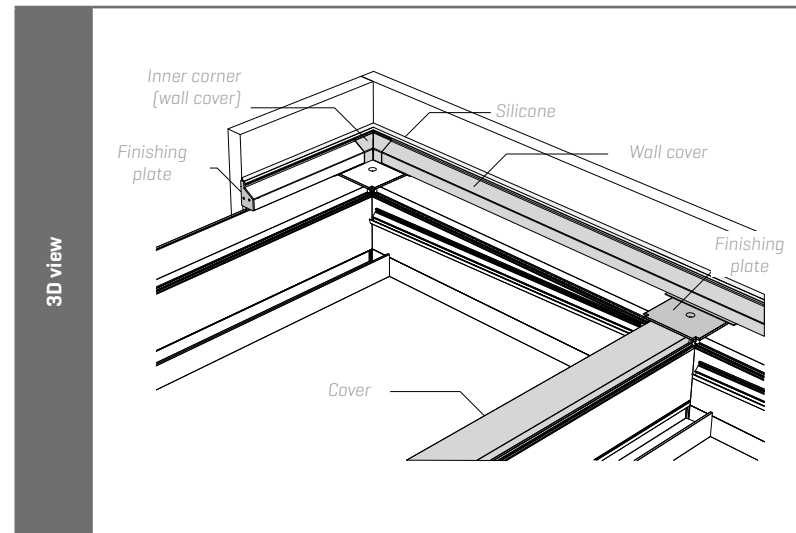



## Blade orientation

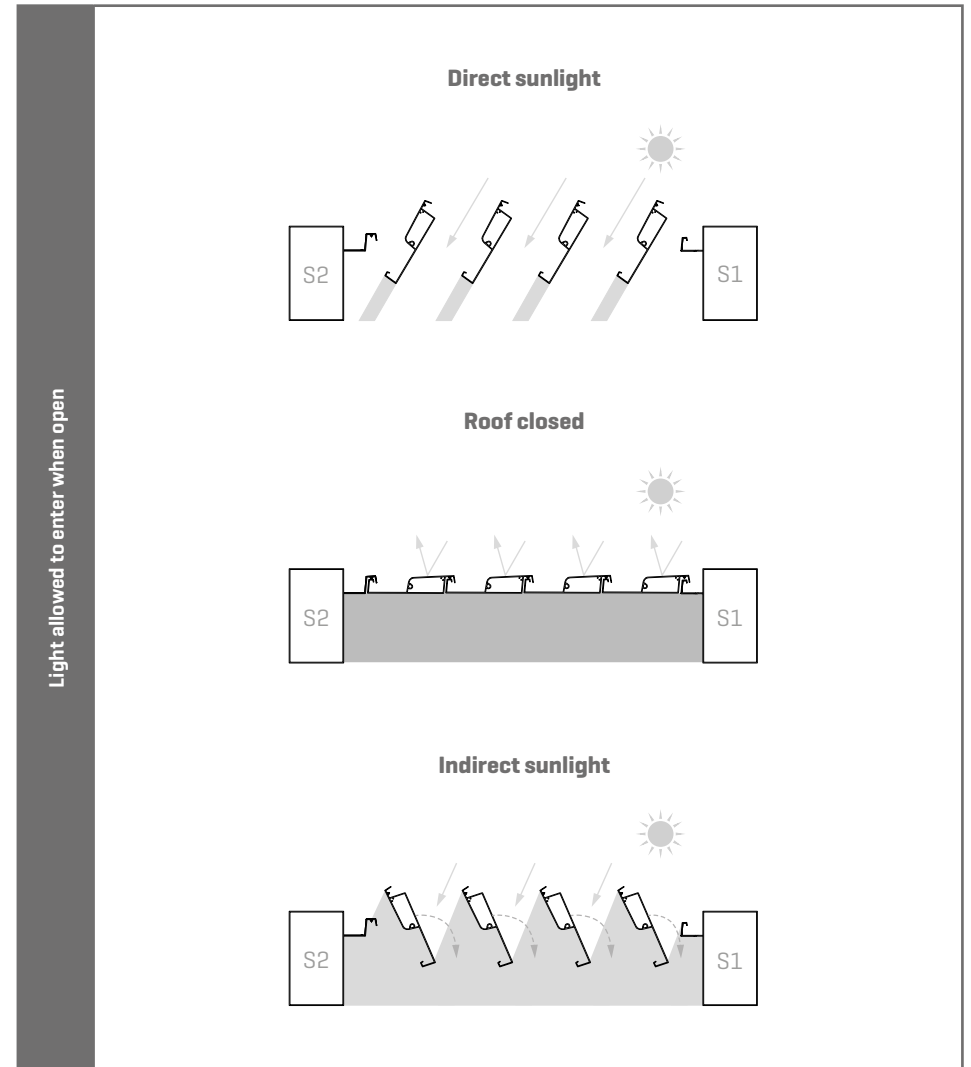
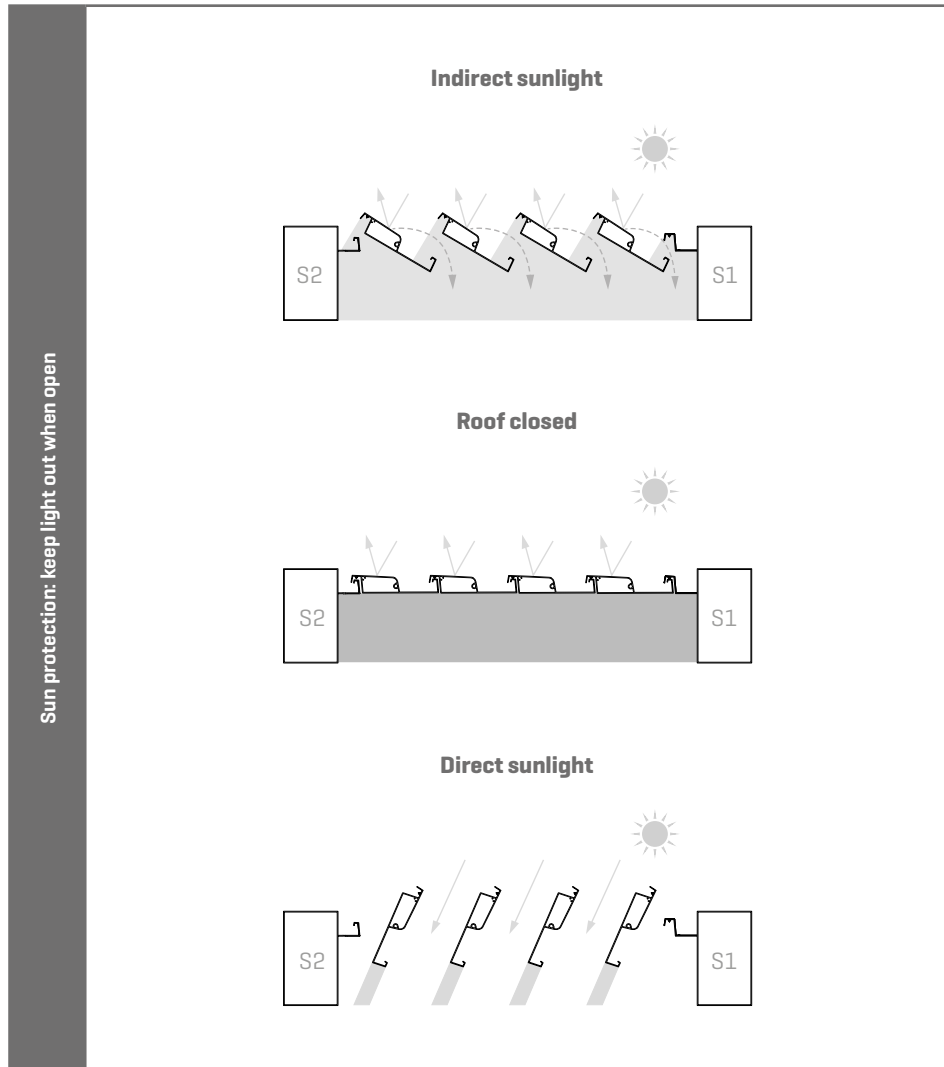

## Mounting bases

The strength requirements determine whether or not reinforced mounting bases are needed.

### Standard mounting bases

For use in normal circumstances, without increased wind load.

- Base plate thickness:  $15/64$ "
- Core length:  $11\ 13/16$ "
- Visible base plate:  $10\ 5/8$ " x  $10\ 5/8$ "

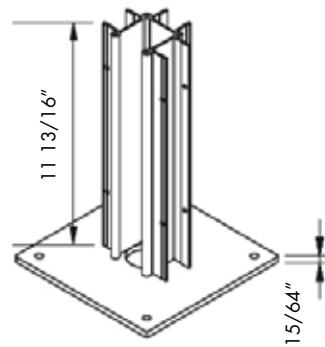

### Reinforced mounting bases

At locations with increased wind loads, the cover must be equipped with reinforced mounting bases to guarantee the stability of the structure.

Examples include coastal areas, installation at a height or on a rooftop terrace.

- Base plate thickness:  $25/64$ "
- Core length:  $4\ 10\ 55/64$ "
- Visible base plate:  $10\ 5/8$ " x  $10\ 5/8$ "

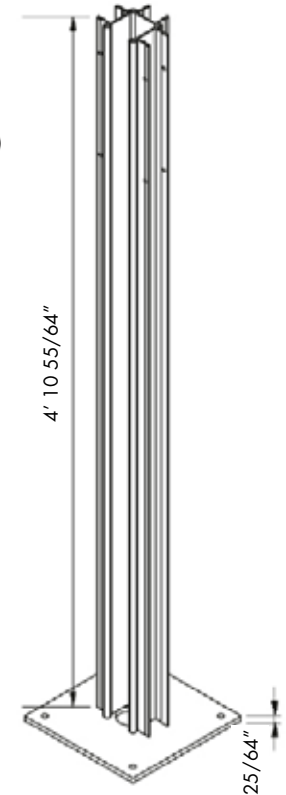

## Mounting bases

The choice of reinforced or non-reinforced mounting bases will be made automatically based on the strength requirements and/or side infill selection. You can select a finish for your mounting bases from the possible options below.

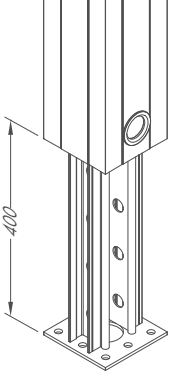
				
<b>Type</b>	Visible mounting base		Invisible mounting base	Cast mounting base
<b>Application</b>	Not against a structure	Pivot or span against a structure	All applications	Cast in concrete foundation
<b>Non-reinforced mounting base</b>	Available at standard price			
<b>Reinforced mounting base</b>	Available at a surcharge			Not available

## Water drainage

Water will be drained down an integrated drainpipe in the columns of your choice. Starting at 172sqm, a minimum of two drainage outlets must be arranged for each roof section, of which at least one drain must be on the lowest side of the blades (not on the motor side). For all other dimensions, at least one drain must be arranged on the lowest side of the blades (not on the motor side).

### Please note!

If there is only one water-draining column and the surface area is greater than 172sqm, the drainage capacity of the roof will only be 0.40GPM [gallons per minute].

### Three options for the height of the drainpipe:

- $2\frac{19}{32}$ " + overlength relative to the bottom side of the base [standard]. In case of overlength, you can choose to have the overlength size included in the standard distance of  $2\frac{19}{32}$ ". For example: an overlength of  $3\frac{15}{16}$ " means water drainage at  $6\frac{17}{32}$ " relative to the bottom side of the mounting base.
- $2\frac{19}{32}$ " relative to bottom side of the base, regardless of whether or not overlength is applicable.
- Variable height  
Minimum distance above ground level =  $1\frac{37}{64}$ ".  
Maximum distance = passage height -  $1' 4\frac{11}{32}$ ".  
The height is always measured from the bottom side of the mounting base to the centre of the drainage hole.

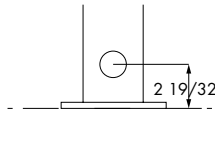
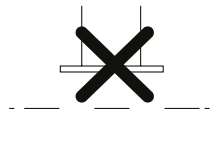
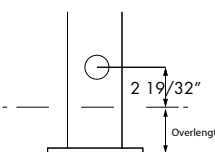
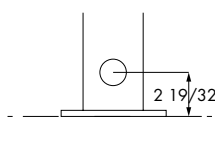
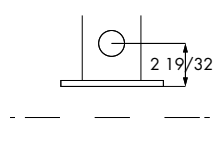
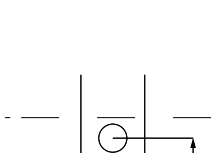
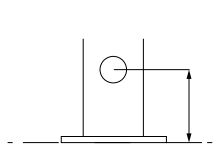
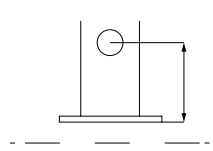
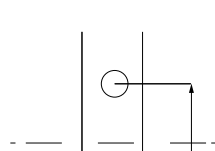
	Passage height	Negative overlength	Positive overlength
$2\frac{19}{32}$ " + overlength relative to bottom side of base [standard]			
$2\frac{19}{32}$ " relative to bottom side of base			
Variable height [mm]			

# OTHER TOOLS

Want to find out more? Visit the Professional Portal on our website ([www.renson.eu](http://www.renson.eu)) to access the following tools.

- Technical drawings
- Training documents
- Installation manual
- User manual
- [Digital photo book & social media](#)
- ...

