

# Conowingo Models



## 44-Ton Boxbug Doodlebug

HO SCALE



[www.conowingomodels.com](http://www.conowingomodels.com)  
<https://www.facebook.com/ConowingoModels/>  
railrunner130@hotmail.com



Thank you for purchasing this kit!

You will need to purchase an HO-scale Bachmann 44-Ton Switcher to complete this conversion. We tried the 70-Ton version, but decided that it doesn't quite fit the bill. You may try to fit it on another body, but we didn't develop any instructions for that.

1. Bracing-
  - 1a. Note the scored line towards the rear of the main body halves. Using a pencil, retrace that line on the inside. This will form a bend later on.
  - 1b. Using 1/16 stripwood, brace the top and bottom of the main body using a glue of your choice. The bracing on the bottom is actually more of a guide for where it connects to the frame, so keep it straight and shore up the front lip and area under the freight door. Be sure the ends allow for flexibility at the bends and where the rear piece will connect at the bottom. Apply clamps as necessary to ensure a snug fit.
  - 1c. Add two stripes of glue to the pre-cut pieces of cardstock. You want the stripes to straddle the bends from step 1a, so that the glue does not go over the bend.

1d. Apply the remaining bracing to the front and rear pieces.

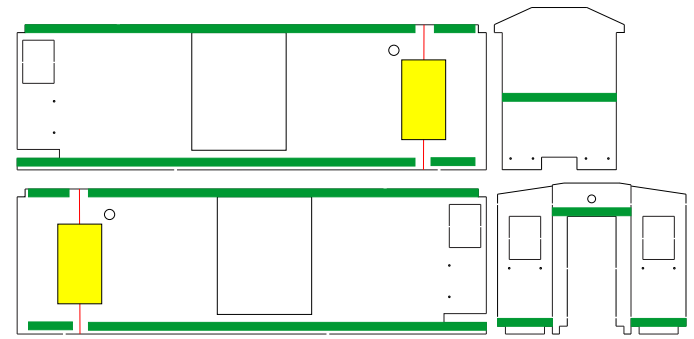

2. Prepare the tarpaper roofing. We recommend using the tutorial by Jason Jensen Trains on Youtube. Look for episode 010. It explains the process better than we can. We recommend painting the undersides and edges of the chipboard roof with a grimy black, so that anything that isn't covered blends in.
3. We left the 3d printed parts on their carriers, figuring that they'd transport better that way. Carefully cut away from the part with your hobby knife. (Some parts not shown)



4. Prepainting the parts are advisable with this kit. Read ahead for ideas on what you want to paint and what colors you would choose to use. With the door and windows, we opted to remove/not include the muntins and rails.
5. Build the clerestory-
  - 4a. Locate four of the five blocks, the two basswood clerestory pieces, two 1/32 plywood trim pieces and two acetate pieces.
  - 4b. Ensure all the windows and trim piece knock outs are removed.
  - 4c. Paint the basswood and plywood pieces as desired.
  - 4d. When dry, glue the basswood and plywood pieces together as shown below. You may want to clamp the pieces together to keep them flat. Do this part for each half.

4e. Glue the four blocks into place on one half. The tall side goes up.

4f. Take the two acetate pieces, cut them to fit between the blocks and glue them into place. You may choose to cut some scrap wood and use it in place of the acetate. This could simulate a conversion of the doodlebug from a passenger configuration to a freight configuration.

4g. Glue the two halves together, ensuring they are square. We found that clamping these two pieces together helps immensely.

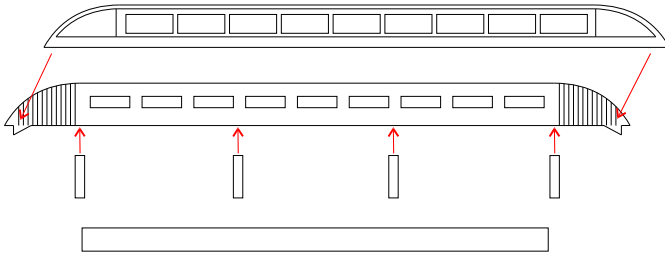

6. Prepare the mechanism-

Remove the shell by removing the two screws on the center side portion of the underside. KEEP THE SCREWS! Some undercarriages may need to be painted to fall in line with your desired paint scheme.

7. Add the front panels to the body as shown below. We recommend using a slower drying glue for this as it may take some manipulating to get it right.

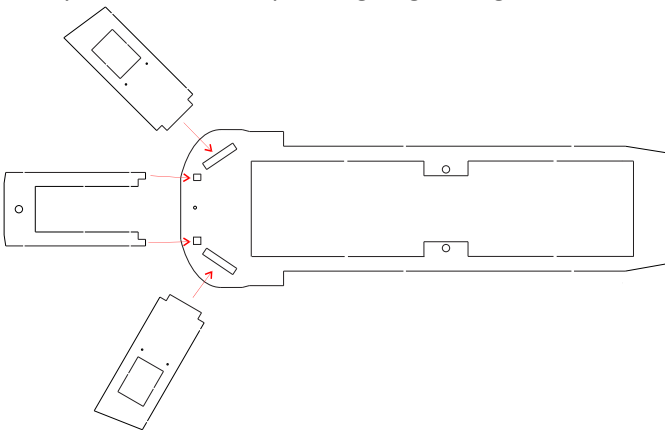

8. Bend the two side pieces at the bend lines that you had previously braced with cardstock. Try not to break them. If you are worried about breakage, wet them with some water first.

9. Add some glue to the bottom piece of 1//16 stripwood on the side pieces. Next, slide them into place, being careful not to break the lips on the forward end of each. If they do break, you can glue

them back into place. It happened with the pilot model. (We subsequently moved the bracing locations.) The bend lines should match up with the bend in the aft section of the body frame.

10. To square off the side pieces, glue the rear panel into place, using the notches to engage the side pieces. You should also glue the small brace (see diagram below) to the notches above the front windows.

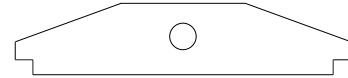

11. Roofing Preparation-

11a. Glue down the long strip of chipboard to the clerestory. We recommend a fast-drying glue to more easily adhere the chipboard into place.

11b. Glue down the tarpaper pieces onto their respective roofing pieces as desired.

The pilot model has pieces which overlap, like the roof of a building. However, prototype roofing is usually a single piece.

Should you do your roof like ours, we recommend cutting pieces to about 1.5 inches long and gluing them down starting at the rear and overlapping pieces as you go forward so that the seams face the rear.

12. Size, cut and install the 1/32 stripwood to the sides of the pieces shown in step 7 so that the seams are hidden. We recommend a fast-drying glue for this step.

13. Adding the cargo doors-

13a. Cut and glue the 1/16 trim for the cargo doors as shown below. The small void between the top and side pieces is only for clarity purposes.

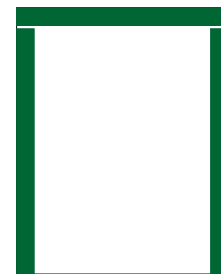

13b. Locate the two cargo door sills. They should be glued into place with the wider part on the outside of the doodlebug and the narrower part inside the doorway, between the trim pieces installed above.



13c. This step is optional. Some people may want the cargo doors to be plain jane. Refer to the step below for a visual representation of this step.

Take the 1/32 scribe piece (x2) (Shown in yellow) and orient them so that the scribe runs vertically.

Take the larger piece of laserboard (shown in white) and glue it so that it is centered on the bottom of the scribe.

Take the smaller piece of laserboard (shown in red) and glue it so that it is centered on the larger piece of laserboard.

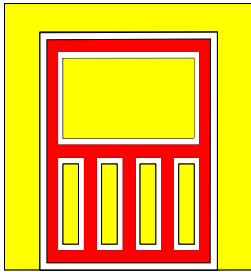

13d. The cargo doors can now be glued into place. The trim on the cargo doors should be centered on the door opening with the bottom of the trim at the bottom, touching the door sill.

It is not advisable to modify the door and leave the door open unless you have something (like built crates) to block the visibility of the mechanism.

14. Glue the Adlake markers into place as shown below.



15. Glue the headlight into place above the door. Ensure the lip is facing outward. We recommend painting the inside of the headlight and rear wall either silver or a brass color for an older look.

16. Add the LED for the headlight to the body. It can pass through the hole above the front door and the brace. You may choose to glue the headlight into place along with the LED now or later. Glue the acetate lens into place when everything is where you want it. We used a clear drying glue.

17. Due to the differences in the generations of the Bachmann, we did not include instructions on

converting each to DCC. We have included an approximate guide on the last page. WE ARE NOT WIRING EXPERTS. USE AT YOUR OWN RISK!

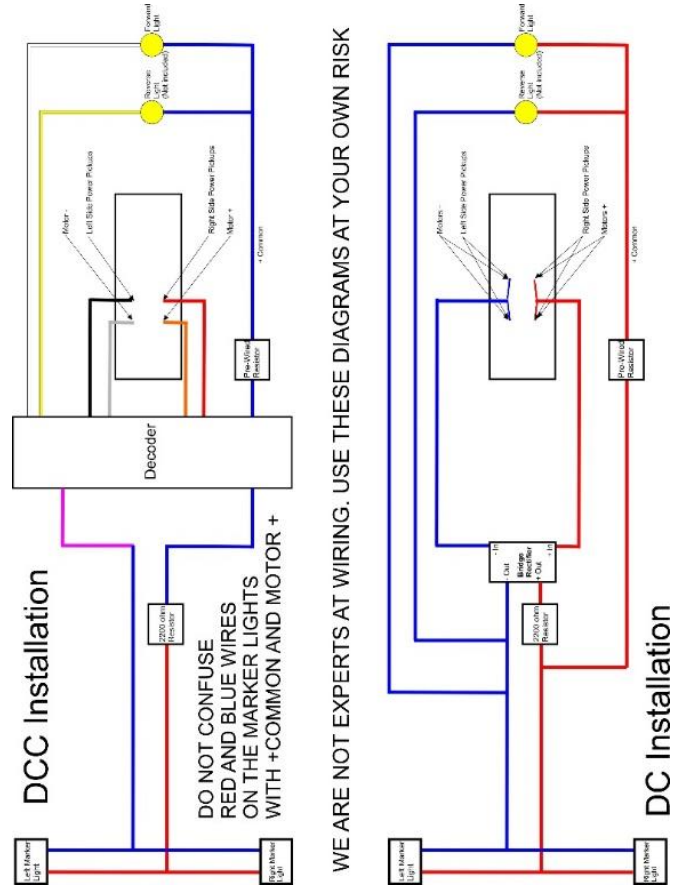

18. Cut out the two narrow strips of cardstock and glue them to the bottoms of the clerestory pieces so that the excess is on the outboard side. You will accomplish more quickly with a fast-drying glue.

19. Once dry, bend the cardstock a bit so that the roofing will attach without binding.

20. Fit the new body into place on the mechanism. Be sure to align the screw holes. Using the screws from step 6, attach the mechanism and body together.

21. Fit and glue the clerestory into place. It should fit evenly side to side and front to rear on the flat parts of the front door and rear wall.

22. Fit and glue side roofing pieces in place, ensuring the stubbier end is towards the rear.

23. Bell assembly.

23a. Locate the bell hanger on the laserboard sheet. It looks like the piece below on the left. The areas

shown in red are bends. Laserboard tends to be stiff, so manipulate it with your fingers. You want it to form a shelf with a backer. You might consider cutting off the shorter wing pieces (as shown on the middle diagram). It may fit together better that way.

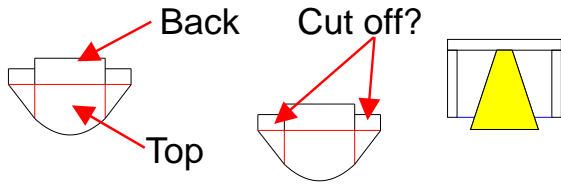

for more exciting, funky buildings and rolling stock for your model railroad!

Many thanks to my family, Geoff Bunza, Jeff Grove, Steve Milley and Mark Schreier for their support!

23b. Glue the bell into place using a fast-drying adhesive.

23c. Glue the bell assembly into a place of your choosing.

We chose to install it above the right, forward window, out of the engineer's line of site.

24. Locate where you want to install the whistle. We chose to install it above and behind the right, rear, window. Drill a small hole and glue the whistle into place with the air line barely in the hole. The whistle should be vertical.

25. Fit and glue into place the pilot. Be careful to place it so that it doesn't interfere with the front truck. The pilot model suffers slightly from this issue. It also looks a little off.

26. Apply decals as you see fit. Below is how we recommend adding the fictional Conowingo Railroad decals. The sides mirror one another.

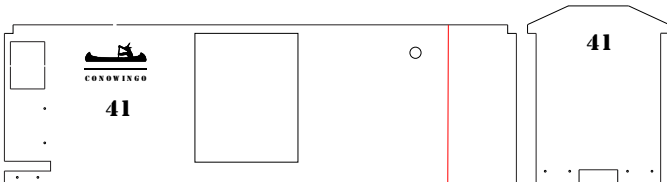

27. Please share your photos on our Facebook page!

<https://www.facebook.com/ConowingoModels>

Once again, thank you for your purchase!

If there are any parts missing, please e-mail me what you need to complete the kit and I'll send it your way. I'm a one-man shop and I do occasionally miss things. Also suggestions for improvement are welcome.

Please send photos!

See the Conowingo Models website

[www.conowingomodels.com](http://www.conowingomodels.com)

Or our Facebook page

<https://www.facebook.com/ConowingoModels/>