

# Conowingo Models



## Passenger Car #1

HO/Hon3 Scale



[www.conowingomodels.com](http://www.conowingomodels.com)

<https://www.facebook.com/ConowingoModels/>  
[conowingomodels@yahoo.com](mailto:conowingomodels@yahoo.com)

August 2023



### KIT CONTENTS

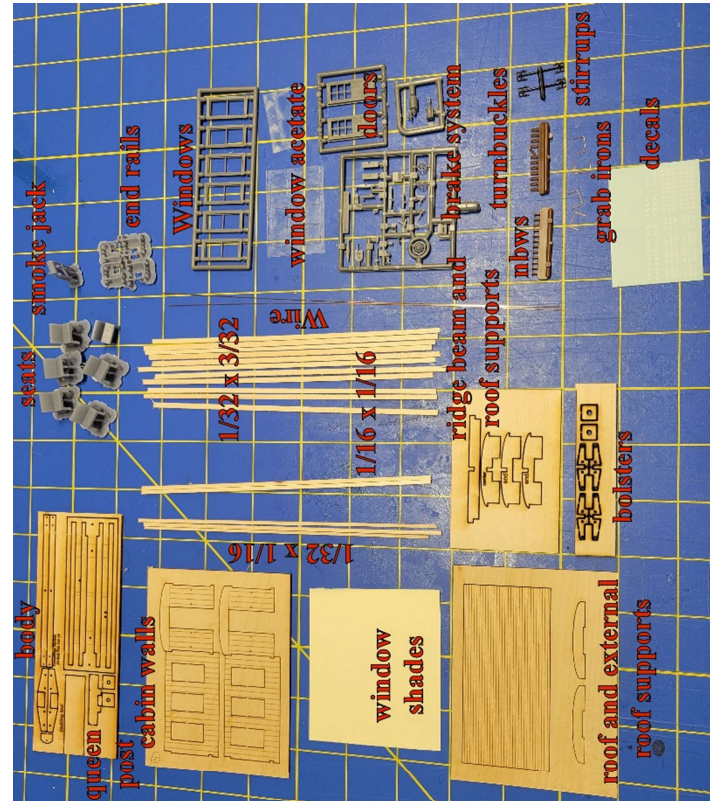

### Items not identified

1. Construction paper for roofing not shown.

### **Thank you for purchasing this kit!**

The enclosed passenger car is fictional but the flat car base is based on some real-world information.

Supplied are the basic directions. For more tips and some additional instructions, please see [conowingomodels.com](http://conowingomodels.com)

We update instructions over time to improve them, show new techniques, etc. See our website to download the latest instructions.

The instructions for this kit are a bit segmented. They are designed to keep the modeler moving forward. It won't look that way at first, because there are a lot of starts and stops associated with bracing and painting.

This kit is intended for HO and HOn3 customers.

The guidance provided in this kit may seem a bit fragmented, but it's intentionally structured to maintain a steady progression for modelers. Initially, it might not appear this way, as there are numerous interruptions related to bracing and painting.

### 3D PARTS PREP

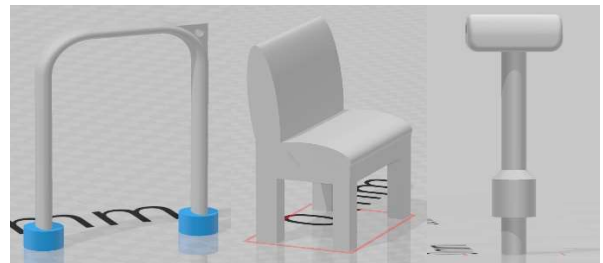

1. Pictured are the 3D printed parts. They were shipped in their carriers to help prevent breakage. Carefully cut out each piece.

## BRACING

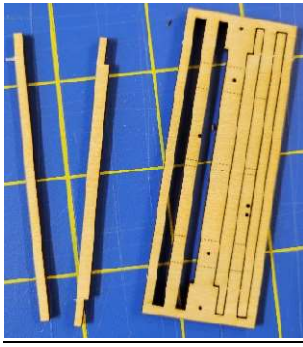

1. Take the frame out of its carrier. Observe that one side has marked lines indicating the placement of bolsters and queen posts; this side should face downward. Additionally, you'll notice the designated positions for the coupler boxes.
2. Plan where you intend to incorporate additional weight. According to NMRA standards, specifically RP-20, a 24-foot model should weigh approximately 2.75 ounces. An unweighted example equipped with Tichy trucks weighed just 1.05 ounces. Neglecting to include sufficient weight will result in a railcar that behaves erratically and doesn't stay on the tracks. We recommend using tungsten putty, which can be obtained from Amazon or other sources, for this purpose. It's a highly effective choice for enhancing the rolling stock's stability. After you've attached the decking, bolsters, and queen posts, use the tungsten putty to fill the gaps in the main body, and don't forget to add weight within the cabin as well.

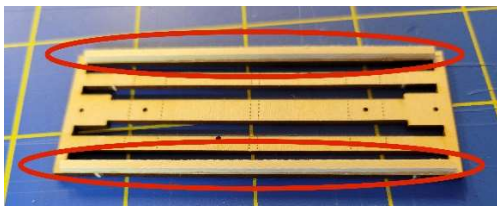

3. Measure, cut, and affix the 1/16 x 1/16 stripwood to both sides of the body's underside (specifically, the right and left sides, not the top and bottom). If you deem it necessary to maintain the flatness of the body, you can also include additional weights.

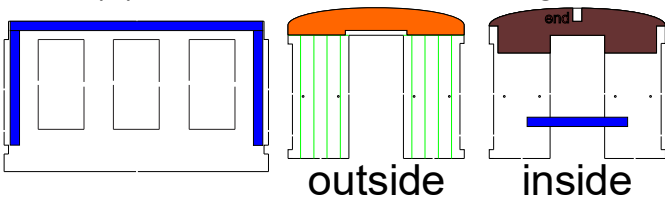

4. Remove both end walls, both side walls, and the two roof supports labeled "end" as illustrated above. (Only one set is displayed for clarity.)

5. Align, trim, and glue the roofing supports, as indicated in the illustration. The exterior is denoted in orange, while the interior is depicted in brown. Ensure that the roofline matches perfectly. Keep in mind that there will be a slight gap around the exterior of the door opening to accommodate the doors. If you're uncertain, perform a test fit with a door. Additionally, avoid applying glue in the region of the top notch on the interior piece.
6. Referring to the illustration above, precisely fit, cut, and apply glue to attach the 1/16 bracing for the inside walls. Leave a small gap on the side to accommodate the glue. Ensure that they align with the end walls (or the notch on the side walls) and do not extend below the bottom of the end walls. The two components should fit together like a tab and slot.
7. Add weights to ensure the glue sets properly.

We had thought about introducing vertical support between the windows on the side walls. However, such support would decrease the seating area. You have the option to include this bracing, but it's advisable to first plan your seating arrangement accordingly.

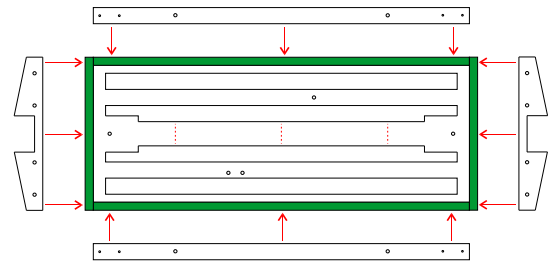

8. Locate the sides and ends for the body piece.
9. Glue these parts in vertically, as shown in the picture above. Keep in mind that the pieces in the kit might look a little different from the ones in the illustration.



10. Add weights and other bracing/support to ensure the end and side pieces will adhere at a 90° angle.

## PAINTING

If you want to replicate the weathering effect, stain the side and end walls before painting.

Make sure the bracing is complete and dry before moving forward.

The instructions assume a red car with white trim, but feel free to use different colors!



### PAINT WHITE

- 6x Windows
- 2x Doors



### PAINT GRIMY BLACK

- 8x NBWs (nut, bolt, washers). You will need to remove them from the 3D printed joiner.
- 4x Turnbuckles
- Brake wheel/brake components
- Needle
- 2x Trucks (some kits)
- 2x Coupler pockets
- Smoke jack
- 4x Bolsters (or 8 if not yet assembled)
- 1x queen posts
- Underside of the frame (optional, it won't show)
- 4x Stirrups



### PAINT RED

- 2x End walls
- 2x Side walls
- 4x 1/32 x 1/16 Corner trim
- 2x 1/32 x 3/32 Roof trim
- 2x Over door panels
- 6x Seats



### PAINT BEIGE

- Paint the interior walls of the car when the exterior walls are dry. (Optional)



### STAIN GREY

- Outside and top deck of the car frame
- Support piece for the brake wheel
- 9x 1/32 x 3/32 stripwood (multiple colors/shades)



1. Using masking tape, set out two lines as shown above. Tuck the ends under so they stick to your chosen surface. We use old cardboard soda cartons.



2. Adhere the above noted stripwood to the masking tape.



3. Stain the stripwood, using multiple colors and varying amounts. This will add character to the wood.

- We'll address painting the interior floor later.



4. Add weights to flatten until dry.



### STAIN LIGHT BROWN

**\*\*\* Do this step ONLY after the roof has been glued into place**

- Scribed side and edges of wood roof piece.

### FINISHING DOORS AND WINDOWS



1. Add the glazing to the doors utilizing a clear-drying glue.



2. Add the glazing to the windows utilizing a clear-drying glue.



## ROOFING MATERIAL PREP

This kit offers two roofing options. Even if you decide not to use the construction paper method, we strongly recommend completing this step regardless. The reason is that the roof on the pilot model split during the roof painting process. Although it can be repaired, you might prefer to avoid that situation altogether or at least be prepared to deal with it quickly if it does happen.

1. Locate the black construction paper carrier sheet containing the roof. When studying actual passenger cars, this section typically looks like a single piece of rubberized material. While there might be seams, they are usually well-covered for waterproofing purposes. We will employ a similar tarpaper roofing technique to complete this section.



2. You have the option to use it as-is to depict a brand-new roof. However, we suggest promptly applying spray paint in three different shades of grey, as illustrated above. The goal is to avoid a uniform appearance; half-sprayed splotches can provide a more realistic effect.



3. Use either a 400-grit sanding sponge or sandpaper and gently rub it along the length of the construction paper strip to blend the paint colors together.

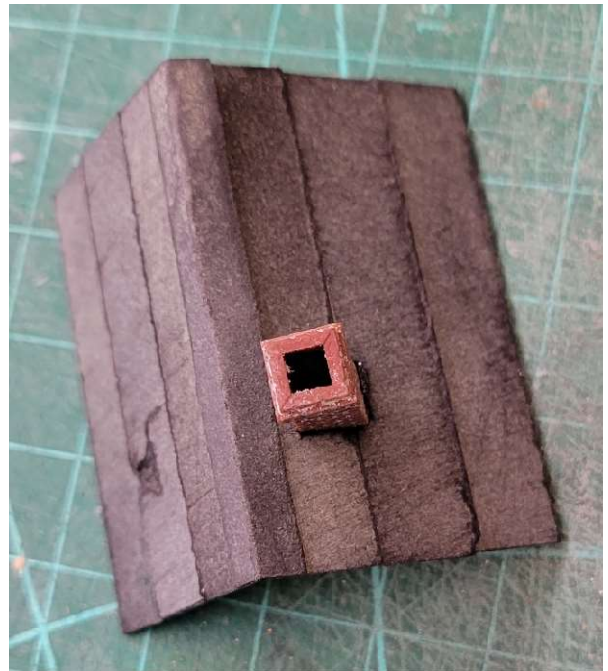

4. If you wish, you can use the sanding sponge to create some wear and tear on the edges and sides of the construction paper, allowing the black to show through and depict roofing age or damage. (The roof of Madam Marie's is shown as an example of the effect.) For the passenger car roof, we opted for very subtle damage.

## DECKING

We haven't previously discussed using a ponce wheel to create decking nails on the deck boards. If you decide to include nails, you can add them either after step 1 or after step 4.

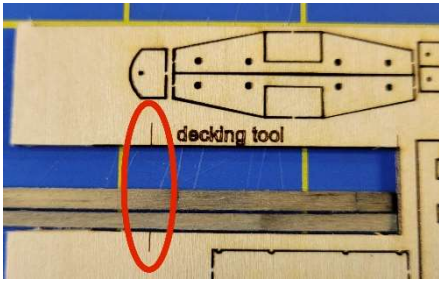

1. Measure and cut each piece of 1/32 x 3/32 wood to align with the frame's width. If your kit includes a "decking tool" on the 1/16 parts tray, you can use it for this purpose. Use the highlighted notches to measure proper width. Our preferred method for efficient and precise deck board production was using the Ultimotion Slicer.
2. We prefer to take our pile of deck boards and mix them up. It ensures lots of variation in the wood colors.



3. Starting at one end, use glue to affix the deck boards one by one. Make sure they are aligned straight and leave small gaps to accommodate for expansion and contraction.

- As you approach the opposite end, begin adding boards to that end and progress toward the center. This step is crucial because any gap that may occur is less noticeable when it's not at the ends. If you do encounter a gap, trim a deck board piece to fit. In the

provided photo, the trimmed piece is the seventh from the top, and it blends in seamlessly.

- Do not worry about the unstained wood cuts, you will cover that up later.

4. When all the deck boards are in place, flip the body over and add weights. You want the car deck to dry flat.

## UNDER DECKING

We've included two different ways to model the truss rods in this kit. You can either use the wires or the thread. We will describe each separately. You may choose to add the brake system before this section.

1. Locate the eight bolster pieces.
2. Pair up the bolster pieces into four sets, making sure they fit together correctly. Laser cutters don't always create perfect 90-degree cuts, and while this usually isn't a problem, in this instance, accuracy is crucial.
3. Glue together each pair, ensuring that the needle will go through the truss rod holes.



- Glue the bolsters to their respective positions on the underbody as shown above. The center of the bolster should match up with the laser cut line. (This is an early development photo, with parts missing and the bolster centers installed.)
4. Place the queen post piece horizontally on the underdeck, following the example shown in the On30 version below. You'll only have one queen post. Alternatively, you could choose to add it after you've installed the truss rods as we did on the On30 pilot model, but it might be more challenging to do so.





## BRAKE INSTALLATION (OPTIONAL)

We have included the brake system installation guides from Tichy Train Group. On the pilot models, we generally don't include brakes because we're mainly concerned about the overall appearance of what goes on top of the deck, not under. We offer two things to consider-

1. The brake component location and how it relates to the trucks. If the components interfere with the trucks, it will adversely affect how the car performs.
2. Should you decide to install the brakes, we recommend you do so before adding the truss rods.
3. We found the below diagram slightly confusing, yet still helpful. Tichy has renumbered the parts since the diagrams were drawn. Ignore the part numbers and follow the shapes.
4. Do **not** install the brake wheel until the end. They will fall off, often disappearing to the floor long before the model is finished. Info on brake wheel installation can be found on the last page.

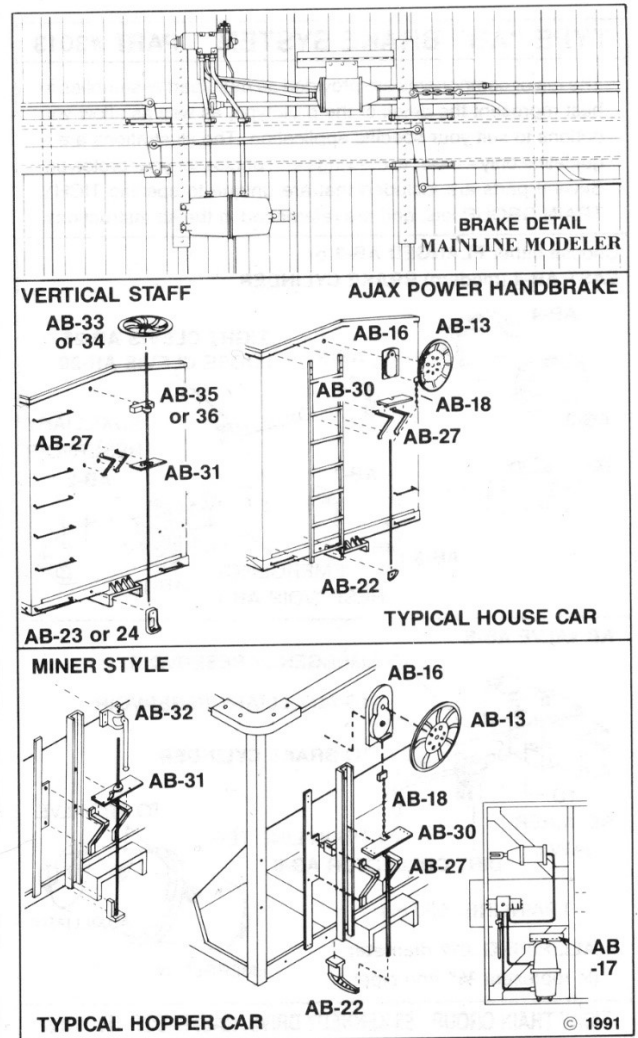
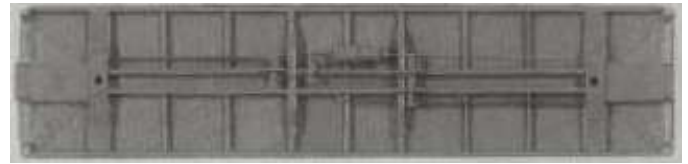
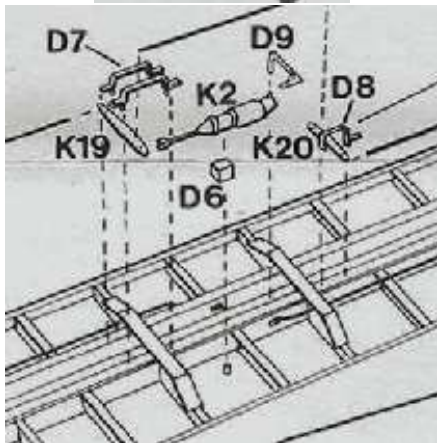
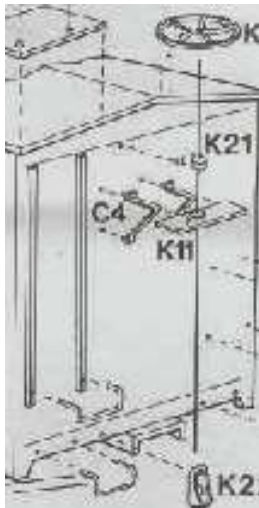

(Courtesy Tichy Train Group)

Parts 3 and 4 can be installed on the underside of the body in the locations indicated below.

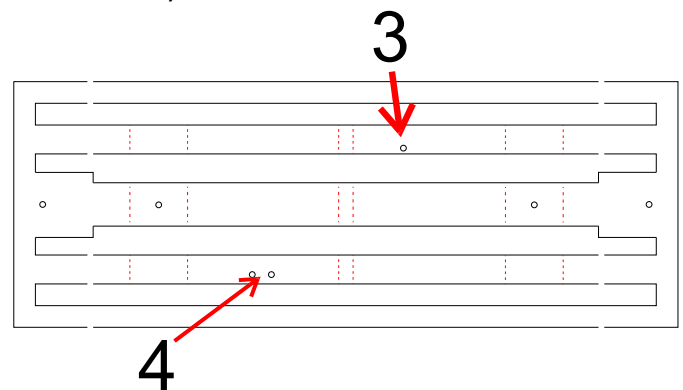

## WIRE TRUSS RODS (OPTIONAL)

You have the option to install either wire truss rods or thread truss rods. If you want to install thread truss rods, disregard this section and proceed to the next.

In the next steps, you'll use two pieces of wire to thread the four truss rods. If you decide to cut the two wires into four beforehand, make sure to attach the turnbuckles first. The space between the turnbuckle and the wire is nearly non-existent. As a result, it's nearly impossible to thread if you add the turnbuckle to the cut end. This is true even when working with the pre-cut ends!

1. Take one piece of wire and add a small, 90° bend at one end.
2. Feed the wire through one hole in the bolster.
3. Add a turnbuckle to the wire.
4. Run the wire across and through the corresponding hole on the opposite bolster as shown below. Orientation of the bent end does not matter. It is merely to hold the wire taught when tightened.

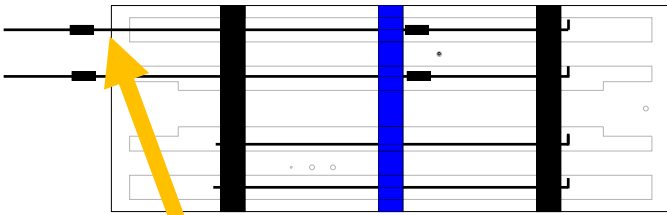

5. Add a second turnbuckle to the wire as shown above.
6. Repeat for the second piece of wire.
7. Ensuring the turnbuckle stays on the excess beyond the end of the body, cut the wire. You want the pieces of wire to be approximately even. (Shown short for clarity)
8. Repeat for the second wire.
9. Using a cut off piece of wire, with the turnbuckle in the middle, (it doesn't have to be centered) feed both ends of the wire through the third set of bolsters. Keep them as straight as you can. This prevents unwanted kinks.

10. Repeat step 9 for the last remaining wire.

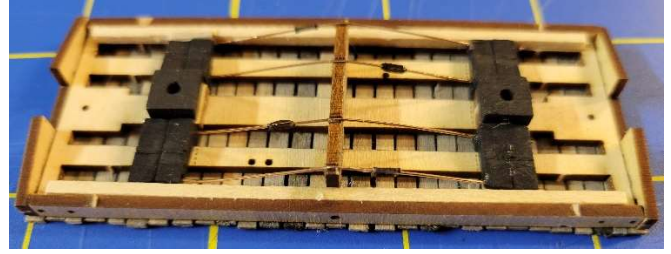

11. Apply glue to the bottom of the queen post and insert it vertically into its laser-marked position. Make sure the wires run over their corresponding notches on the queen post. Please note that the photo above doesn't display the excess wire that you will have.
12. Apply glue, preferably CA (cyanoacrylate), but you can use your preferred adhesive, to the bent end around the holes in the bolsters. Apply it to just the wires on one end.
13. Individually, delicately pull the wires from the end that hasn't been glued to get rid of any slack. Aim to have the truss rods as straight as you can. You might not eliminate all the slack, but keep adjusting until you're content. Be cautious not to damage the queen post or bolsters while doing this.
14. Bend each wire on the excess end to lock it in place.
15. Apply glue, preferably CA (cyanoacrylate), but you can use your preferred adhesive, to this end around the holes.
16. Apply a small amount of glue to each turnbuckle. Random placement is fine, but staying within 50% of the center is more prototypical. They should not be on the queenpost
17. Once it's dry, trim the excess wire. It doesn't need to be perfectly precise, as it won't be visible as long as you touch it up with black paint later on.

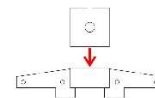

18. Glue the center bolster pieces into place on each bolster. We typically use one 1/16 piece and 1/8 piece as shown above.

## Threaded Truss Rods (Optional)

1. Apply glue to the bottom of the queen post and insert it vertically into its laser-marked position as shown in step 10 of the Wire Truss Rods section.
2. Take the length of thread and tie an overhand knot at one end. (We used three knots and a bit of CA glue at the first bolster because the thread is thin.)
3. Carefully guide the thread through the bolsters, as demonstrated below.
- As you are threading the bolsters, place a turnbuckle on the thread between each bolster. Random is fine. Do not glue them in place yet.
- You should have one turnbuckle for every span of the truss rods (a total of 4). Knots shown as circles. You will only have one knot at this point.
- The wooden queen post has notches for the thread to pass over. Ensure the thread is in the notches and that the turnbuckles aren't on the queen post.

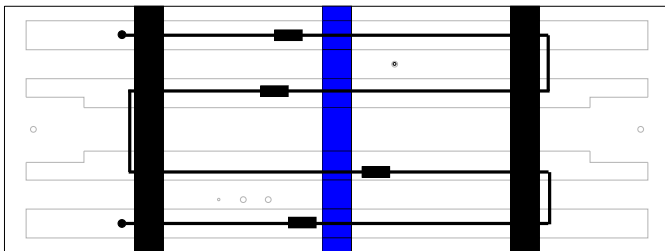

4. Gently pull the thread to remove sagging. Be careful not to break the queen post or pull the knot through the bolster.
5. Once taut, add the final knot (or several) as close to the bolster as you can get it.
6. Apply some CA to the thread at the end of the bolster to hold it in place.
- We hung the whole assembly from the workbench with a small clamp while it dries to keep tension on it. It doesn't hurt to add CA to each bolster where the thread carries through.
7. When it's dry, cut the excess thread.

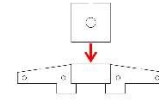

19. Glue the center bolster pieces into place on each bolster. We typically use one 1/16 piece and 1/8 piece as shown above.

## CABIN BUILDING



1. Assemble the walls, two at a time by putting one end wall and one side wall together at a 90° angle. The walls are set up to be tab and slot, so they should fit together easily.



2. Once the glue has set and you're happy with the shape of the walls, glue the two halves together to form a box.
  - It may help to get a large rubber band and utilize the car body to help form the shape. Be careful as the walls are thin and could break easily.
  - Do not glue the cabin together unless you are happy with the alignment.



- We recommend using the car body as a jig to hold the four walls square.

- Referring to the image above, please note that the side walls will not align perfectly with the end walls. However, the side walls should reach down to the bottom of the curvature of the end walls.

3. Let dry.

4. Center the cabin on top of the body.

- If you choose to paint the cabin floor, mark the position, remove the walls and paint the floor now.

5. Glue the cabin into place, ensuring it is centered on the body.



6. Fit, cut and glue a piece of 1/32 x 3/32 stripwood across the top of each side of the car.



7. Wrap each corner with pieces of 1/32 x 1/16 stripwood as shown above. Your main goal is to cover the notches and ends of where the walls come together.

- You may need to add some wood filler to cover the bottom notches.

8. Glue the grab irons in their designated positions. To maintain uniform depth, you can insert a scrap piece of 1/16 stripwood between the end walls and the backside of the grab irons.

9. When dry, glue the doors and windows into place.

10. Cut and glue the window blinds to fit. Varying their heights can add a sense of realism, indicating wear and use.

11. Glue the seats into place as you so desire. Ours all faced one direction.

### ROOFING

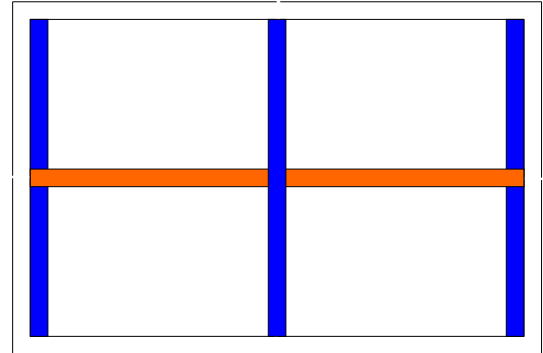

1. Insert the ridge beam so it sits on top of the end wall supports and glue into place.

2. Glue the center roof support into the notch on the ridge beam.

3. Soak the wood roofing piece in some water. Get it good and wet. After a few minutes it will start to warp.

4. Once the roof starts warping, figure out how you are going to apply it to the cabin.

- You will want it to sit evenly forward to backward and side to side.

- There will be some overhang, so decide if you want to cut it off or leave it.

- On the pilot model, we chose to glue it down so the excess ended up on one side. We cut it off when it dried. Unfortunately, when we tried to trim it after drying, we were dissatisfied with the uneven and irregular results.

5. Apply glue to the top of the ends, sidewalls and roof supports. We used a slower glue to give us time to get it positioned properly. Be careful not to add too much glue – you don't want a drippy mess.

6. Carefully, but quickly, position the roof where you want it and secure with rubber bands. We used some stripwood to apply pressure to the top and lower sides of the roof so it contours properly.

7. When the roof is dry, either paint or stain the underside and edges of the roof.

8. If you decided to paint the roof, apply layers of paint according to the following guidelines (adjust as needed):

- If you're using oil or solvent-based paint, you shouldn't encounter issues with cracking. However, alcohol-based stains or acrylics can increase the risk of cracking.

- Paint the whole roof with a coat of black/grimy black

- Dry brush on an uneven coat of medium or dark grey.

- Dry brush on another uneven layer of grey, lighter than the previous grey.

- When dry, lightly sand from front to rear to blend the colors together.

- In the event that the roof cracks, it can be repaired. We used glue and simply repainted the roof. Otherwise, a light coat of wood putty and repaint would work as well.

9. If you opted for the construction paper method, take the prepared roofing material, cut it to the appropriate size, and affix it with glue. Be cautious not to use excessive glue, as it can create a mess.

- Applying some pressure can assist in keeping it properly contoured on the roof's surface.

### TICHY TRUCKS (OPTIONAL)

1. If you purchased the Tichy trucks, assemble the trucks and coupler boxes (some kits) as shown below.

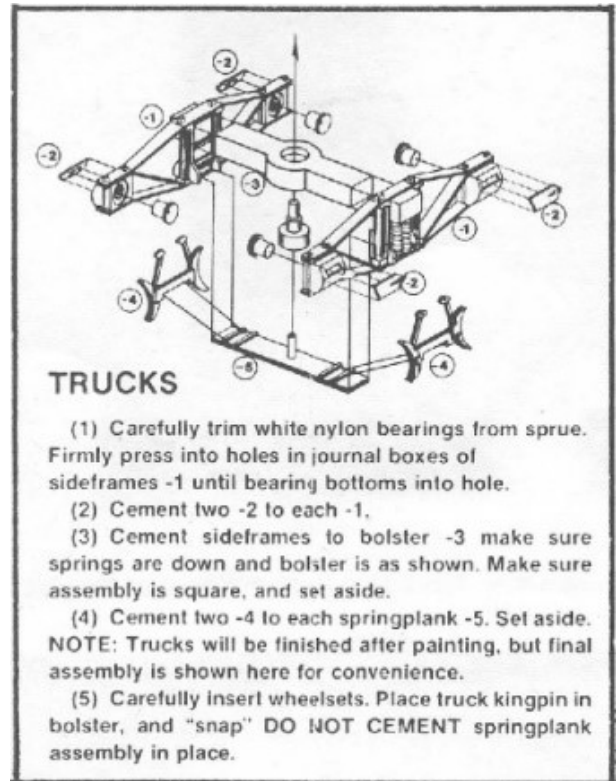

(Courtesy Tichy Train Group)

### FINISHING TOUCHES

1. Trim the deck boards as desired. We've found that lightly sanding it with a sanding sponge works well.

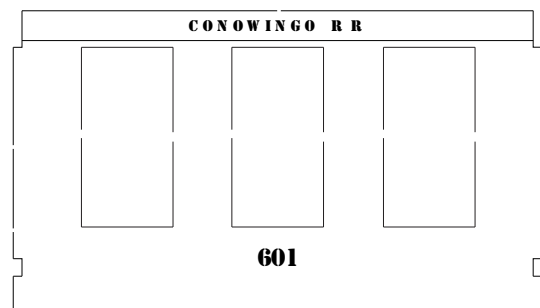

2. The under sides, side rails and end pieces can be further painted/stained and lettered at this point, or you can choose to do so later if you so choose.

3. Install the coupler boxes. We recommend applying some CA to the frame where the coupler boxes will go, followed by appropriate screws (unfortunately, the screws included with some kits are for the trucks and are too long for this application).

4. Install the trucks using the screws and insulating fiber washers (some kits). For those unfamiliar, the washers go between the truck and bolster to smoothen truck movement. Tichy Arch Bar trucks (some kits) can now have the spring planks installed. Despite the instructions, We've found that a dab of CA helps keep the spring planks in place.

If the screws don't hold, add a drop or two of CA into the holes and try again. Work the trucks so they don't get glued into place.

5. Install the doors and windows using a bit of glue around the edges. As a general rule, we recommend not gluing the bottom edge of the door. This allows for the possibility of a small amount of light to pass through, looking more realistic.
6. Install the end rails.
7. Install the smoke jack at one end of one of the cabin walls. The 3d part has a shaft that can be either removed or you can cut a hole in the roof to accommodate. Either way, glue the smoke jack into place.



8. Install the end bolts (NBWs) and stirrups using glue. Either CA or white/wood glue seems to work equally well. The bolts have holes cut for them. There are also holes cut to serve as guides for the stirrups. Orientation of the NBWs doesn't matter, however they should be random and not all oriented the same way.
9. For the brake wheel run the pin through the brake wheel. Glue the wheel and rod to the wood piece, sharpened end down and in the notch. We glued ours to the end of the car. Different variations are highly encouraged!



10. Do any necessary paint touch-ups and final weathering.
11. Please share your photos on our Facebook page!  
<https://www.facebook.com/ConowingoModels>

Once again, thank you for your purchase!

If there are any parts missing, please e-mail us what you need to complete the kit and we'll send it your way. Suggestions for improvement are welcome. Please join us on Facebook and post your photos!

See the Conowingo Models website  
[www.conowingomodels.com](http://www.conowingomodels.com)  
Or our Facebook page  
<https://www.facebook.com/ConowingoModels/>  
for more exciting, funky buildings and rolling stock for your model railroad!

Many thanks to my family, Jeff Grove, Steve Milley and Mark Schreier for their support!