

TABLE OF CONTENTS

COMPUTERIZED SLING CERTIFICATION, RE-CERTIFICATION.....	3, 4
THE LIFTPRO ASSURANCE OF QUALITY	5
SLING TAGGING AND TRACKING	5
Standard Sling Types.....	6
Custom Slings Fabricated to Your Specifications	7
“Red Core Yarn” Advisory.....	7
Special Considerations for Large Hooks, Shackles, Etc.....	7
Custom Slings Fabricated to Your Specifications	8
Custom Lifting & Moving Devices	9
Glass Pack Slings.....	10
Sling Strengths and Webbing Considerations:	
& Web Strengths.....	11
Nylon, Polyester Webbing	11
Environmental Chart	11
Optional Wear Protection for Slings.....	12
Load Lifting Considerations:	
Stress on a Sling Can Be More Than the Load.....	12
Calculating the Load On the Legs of a Sling	13
Choker Hitch Rated Capacity Adjustment	13
SYNTHETIC FLAT WEB SLINGS:	
TYPE 1 - Triangle-Choker (TCa/TCs) 1-2 Ply.....	14
TYPE 2 - Triangle-Triangle (TTa/TTs) 1-2 Ply.....	14
TYPE 3 - Eye & Eye Flat (EEf) 1-4 Ply	15
TYPE 4 - Eye & Eye Twist (EEt) 1-4 Ply	16
TYPE 5 - Endless Grommet (EN) 1-4 Ply	17
TYPE 6 - Endless Grommet (EN) 1-4 Ply	18
TYPE 3 - Eye & Eye Flat (EEf) 5-6 Ply	19
TYPE 4 - Eye & Eye Twist (EEt) 5-6 Ply	19
TYPE 5 - Endless Grommet (EN) 5-6 Ply	20
TYPE 6 - Reversed Eye (RE) & TYPE 7 - Flat Eye (FE) 1-4 Ply	21
TYPE 8 - Wide Body Basket (WBB), 1-2 Ply	22
TYPE 9 - Load Balancer Basket (LBB), 1 Ply	23
TYPE 10 - Multi-Leg Bridles (MLB)	24
Examples of Wear and Abuse	25
Operating Practices for Synthetic Web Slings	26, 27
HARDWARE:	
Aluminum/Steel Triangles & Chokers	28
Eye Hooks	29
Oblong Master Rings	30
Sling Saver Shackles, Web Sling Hooks, Web Sling Shackles (Pull Pin).....	31
TIE DOWNS, RATCHET, WINCH STRAPS	
Synthetic Sling Ratchets	32
Ratchet Tie Downs	33
Winch Straps.....	34
Operating Practices for Synthetic Web Sling Tiedowns	35
Vehicle Recovery Straps.....	36
Custom Polyester Marine Slings.....	37
ORDER BLANK	38
CUSTOM SLING ORDERING GUIDELINES	39
SLING INSPECTION SERVICES	40
TRAINING SEMINARS	40

CERTIFIED LIFTING EQUIPMENT

You wouldn't trust . . .

an un-certified Voltmeter



or . . .

an un-certified Air Quality Device . . .



WHY would you trust
Un-certified Lifting Equipment?

LiftPRO, Inc. by NESCO
Pioneered Computerized

**Sling Certification,
Certified Load Testing
and Certified Weighing**

On-Site Certified Load Testing & Weighing with
LiftPRO's Certified 5,000, 250,000, 300,000 and
600,000 lb. Portable Load Cell

Providing Load Testing & Weighing for overhead,
Jib, and construction cranes as well as load-weight
verification

Proof & Break Testing at LiftPRO's facilities
with their Certified 300,000 lb. Test Bed

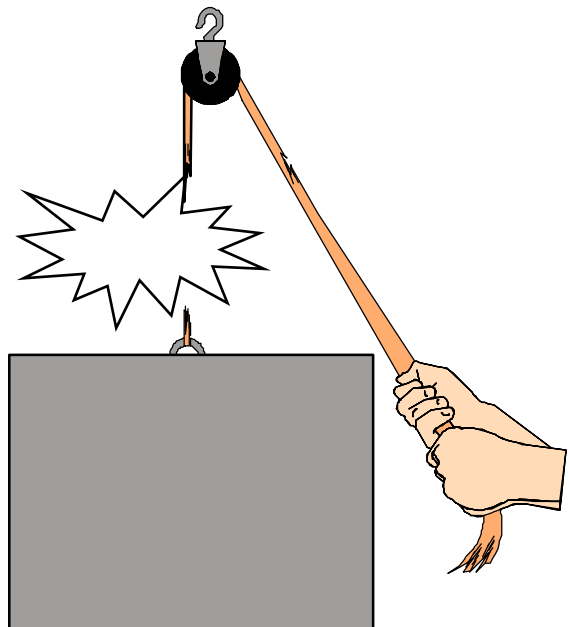

CERTIFIED LIFTING EQUIPMENT

LiftPRO, Inc. Pioneered Computerized Sling Certification and Certified Load Testing & Weighing Services for Our Customers

- LiftPRO led the way with the first Computerized Test Bed in the United States and was instrumental the development of testing software that is currently being used around the world!
- LiftPRO leads the industry with their 5,000; 250,000; 300,000 & 600,000 lb. Certified Portable Load Testers!

Our Load Testers Generate Computer Printouts (see samples below) to Document Your Test Results:

Certificate of Testing

NESCO, INC.
Quality Rigging and Testing
5959 Seville Road — Duluth, MN 55811
(218) 729-9211 (800) 950-3183 FAX: (218) 729-7630

Customer Name: NESCO
 Description: EE1-9U1
 Test Method: BREAK
 Size: 1 IN.
 Length: 5 FT.
 Test Duration: 1.7 Minutes
 Peak Load: 9,980 LB

Test Number: 96-03-90
 Serial Number: 96-03-90
 Test Date: 3/14/96
 Order Number:
 Invoice Number:

Plot of Load (LB) vs Time (Minutes)

Proof Test Equipment was Calibrated to ASTM E4 +/- 1% and is Traceable to The National Institute of Standards and Technology.

Test Results:
 Acceptable
 Not Acceptable

Certified by: _____
 John Doe

Certificate of Calibration

CUSTOMER: NESCO
 LOCATION: 5959 Seville Road; Duluth, MN 55811
 MACHINE MFG: Home Built
 MACHINE MODEL: 300K A&D Mark II
 SERIAL NUMBER: C79020

Ph: 800-950-3183
 FX:
 Compression Tension
 Horizontal Vertical

RANGE: 3,000 TO 30,000				ERROR				RANGE: 60,000 TO 300,000				ERROR			
#	STANDARD	MACHINE	%	LBS.	#	STANDARD	MACHINE	%	LBS.	#	STANDARD	MACHINE	%	LBS.	
I	3,008.0	3,000.0	0.27%	8.0	L	60,166.0	60,000.0	0.28%	166.0	J	120,178.0	120,000.0	0.15%	178.0	
J	6,012.0	6,000.0	0.20%	12.0	L	180,230.0	180,000.0	0.13%	230.0	J	240,098.0	240,000.0	0.25%	98.0	
J	12,052.0	12,000.0	0.43%	52.0	L	240,599.0	240,000.0	0.25%	599.0	J	24,076.0	24,000.0	0.32%	76.0	
J	18,098.0	18,000.0	0.54%	98.0	L	299,448.0	300,000.0	0.18%	552.0	L	30,102.0	30,000.0	0.34%	102.0	
L	30,102.0	30,000.0	0.34%	102.0											
TEST # NA								TEST # NA							
MvV: NA								MvV: NA							

RANGE: 3,000 TO 30,000				ERROR				RANGE: 60,000 TO 300,000				ERROR			
#	STANDARD	MACHINE	%	LBS.	#	STANDARD	MACHINE	%	LBS.	#	STANDARD	MACHINE	%	LBS.	
I	3,006.0	3,000.0	0.20%	6.0	L	60,134.0	60,000.0	0.22%	134.0	J	120,147.0	120,000.0	0.12%	147.0	
J	6,003.0	6,000.0	0.05%	3.0	L	180,164.0	180,000.0	0.09%	164.0	J	240,659.0	240,000.0	0.27%	659.0	
J	12,044.0	12,000.0	0.37%	44.0	L	240,659.0	240,000.0	0.27%	659.0	J	24,048.0	24,000.0	0.19%	48.0	
J	18,074.0	18,000.0	0.41%	74.0	L	299,525.0	300,000.0	0.16%	475.0	L	30,085.0	30,000.0	0.28%	85.0	
J	24,048.0	24,000.0	0.19%	48.0											
L	30,085.0	30,000.0	0.28%	85.0											
TEST # NA								TEST # NA							
MvV: NA								MvV: NA							

Calibration in accordance w/ ASTM E4-96 +/- 1% and traceable to the National Institute of Standards and Technology (NIST), from a lower limit of 3,000 LBS to an upper limit of 300,000 LBS. Any reading outside of the lower/upper limit does not meet ASTM E-4 specifications. Elastic calibration device has been verified to ASTM E74-95 traceable to NIST, and load values corrected for temperature of 23°C/74°F.

DISCLAIMER: The information on the Certificate of Calibration is a statement of fact that on the date of calibration the instrument had an accuracy as indicated. This Certificate of Calibration is not a guarantee or warranty that the instrument will have the same percentage of accuracy as determined on the date of calibration. Calibration has no control over the operation, maintenance, repairs, and/or overall condition of the instrument, and hereby disclaim any and all liability for damage or loss from deterioration, obsolescence, malfunction, or substandard performance of said instrument, which shall remain the sole responsibility of the machine's custodian and/or owner.

STANDARDS USED					
#	SERIAL NO.	CALIBRATION DATE	"A" LOWER LIMIT	"A" UPPER LIMIT	
I	840218B	3-27-97	NIST Lc	1,644 LBF Tension	6,000 LBF
J	840218B	3-27-97	NIST Hl	3,400 LBF Tension	60,000 LBF
L	840218C	3-21-97	NIST Hl	8,380 LBF Tension	600,000 LBF

Remarks: Auto Ranging - AS FOUND

*Weights calibrated by Department of Agriculture, State of Missouri, Division of Weights & Measures
 **Tensometer Cast Standard Weight (11 each) Class F

DATE: 10/02/97
 Calibrated by: John Doe

**Load Testing & Weighing for Overhead, Jib, Construction Cranes,
 Load-Weight Verification; Certify/Re-Certify your Sling Inventory
 Certified Load Testing; Certified Weighting; Proof & Break Testing**

ASSURANCE OF QUALITY, SLING TRACKING

LiftPRO Provides Assurance of Quality and Sling Tracking Capability

LiftPRO insists on highest quality materials. To maintain standards for quality and durability, materials are repeatedly tested to verify break limits.

- Materials received include Certificates of Conformance
- All received material is tested in our Certified Test Bed
- Materials are accepted only if they meet our Standards

LiftPRO's stringent inspections throughout each stage of the manufacturing process assures the highest quality.

- All items manufactured are subjected to numerous inspections by our expertly trained staff
- Finished Products are subjected to Random Testing
- LiftPRO, Inc. has developed their own Quality Assurance Manual which is continually reviewed and revised to improve effectiveness

SLING IDENTIFICATION AND TRACKING:

LiftPRO's slings are tagged to document sling specifications and to provide *absolute tracking* of individual slings. Specifications include:

- Sling Manufacturer's Name and Locations
- Webbing Material Lot Number – Enables Tracking to Identify Exact Shipment of Webbing Material
- Sling Manufacture Date
- Sling Material - Nylon or Polyester
- Lifting Capacity of Sling for Vertical, Choker & Basket Hitches
- Type, Width and Length of Sling

LOT # 39035	DATE OF MFG.: 08/30/06	LIFTPRO by NESCO, Inc.	CLASSIC	WEB SLING	<input checked="" type="checkbox"/> NYLON	
		Duluth, MN & St. Paul, MN			<input type="checkbox"/> POLYESTER	LOAD CAP. FOR NEW SLING
		VERTICAL	CHOKER			BASKET
		6400 LBS	5100 LBS			12800 LBS
		TYPE	WIDTH			LENGTH
		EE2-902	2 IN			12 FT

10 STANDARD SLING TYPES

LiftPRO Helps You Select the Best Sling for Every Lift . . .

TYPE 1



TRIANGLE CHOKER
Width to 12"

Slip-through triangle provides smooth, even choke for single-leg lifts.

TYPE 2



TRIANGLE-TRIANGLE
Width to 12"

Choice of several permanently attached fittings of steel or aluminum alloy offers a greater variety of attachments or hitch configurations.

TYPE 3



EYE & EYE FLAT
Width to 12"

Eye is formed by folding back the webbing and sewing it flat against the sling body.

TYPE 4



EYE & EYE TWIST
Width to 12"

Fabric is turned 180° before sewing to form an eye which lays 90° to the sling body. This allows for easier chocking.

TYPE 5



ENDLESS OR GROMMET
Width to 12"

Fabric is overlapped and sewn to form an endless grommet; areas of hook contact may be tapered and reinforced for longer wear.

TYPE 6

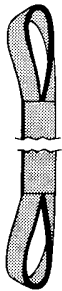

REVERSED EYE
Width to 12"

Eye is formed by folding back the webbing and sewing it side by side.

TYPE 7

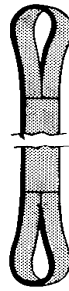

FLAT EYE
Width to 12"

Fabric is turned 180° to form an eye which lays on the same plane as the sling body.

TYPE 8



WIDE BODY BASKET
Width to 48"

Wide body slings provide greater stability in basket hitches. Eyes are folded and sewn to form hook openings.

TYPE 9



LOAD BALANCER BASKET
Width to 48"

A light-duty basket for use where load balancing or cradling is required.

TYPE 10



MULTI-LEG BRIDLES

Bridles offer a variety of leg designs for quick hook-up on repetitive lifts. Three or more legs available on special request.

WARRANTY

Any warranty, expressed or implied as to quality, performance, or fitness for use is always premised on the condition that the published rated capacities apply only to new, unused slings and assemblies, that the mechanical equipment on which such products are used is properly designed and maintained, that such products are properly stored, handled, used and maintained, and properly inspected on a regular basis during the period of use.

LIFTPRO CUSTOM SLINGS FABRICATED

Slings—Fabricated To Your Job Specifications

Because the lifting of loads is a vital operation, and because the sling user's needs are frequently unique, virtually all sling orders are custom made. Therefore, it is essential that each order provide the following information to guide manufacturing:

LiftPRO, Inc. manufactures slings to a tolerance of + or - 2% for one and two ply slings. Tolerance for three and four ply slings is + or - 4%. Specify matched lengths if required and call **LiftPRO, Inc.** for special requirements. To order Bridle Slings, see page 25.

HOW TO ORDER

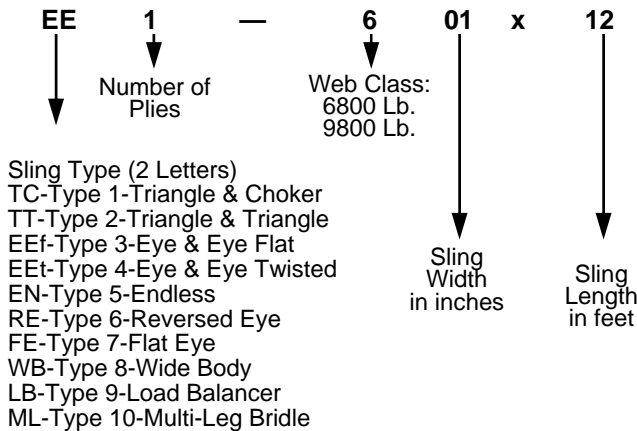

HOW TO MEASURE

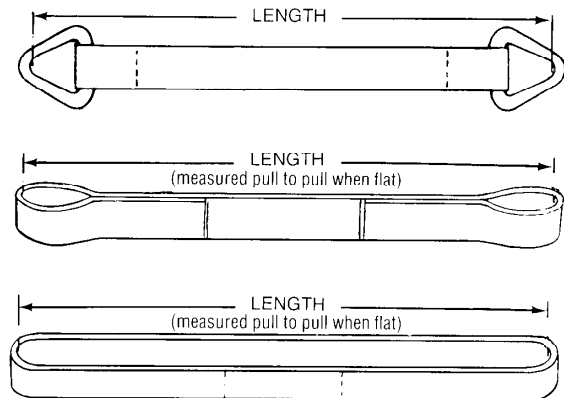

Red Core Yarn Advisory

LiftPRO advises not to rely solely on exposure of "red core yarn" as an indication of web wear!

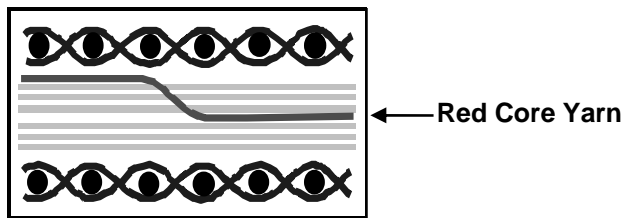

The exposure of red core yarn is often used as a visual indication of wear to a web. This should not be the sole indicator of wear!
 Web manufacturers weave a "red core yarn" at 1"

spacing throughout their webbing, and ideally, the red core is placed at the center (core) of the webbing. However, manufacturers cannot guarantee precise placement of the red fibers. During the manufacturing process, the red core yarn may "float," causing a variation in the yarn placement from center to the top or bottom of the webbing. **It is possible to cut through as much as 90% of the webbing without exposing the red core yarn!**

Therefore, LiftPRO, Inc. advises not relying solely on exposure of the red core yarn as an indication of web wear. LiftPRO believes there are many indicators of wear to a sling, including cuts, abrasions, etc.

Special Considerations for Large Hooks, Shackles, etc.

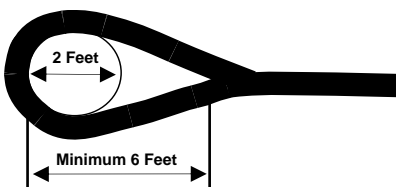

The ratio of the length of an eye splice to the diameter of the object over which the eye is to be placed should be a minimum three-to-one relationship and preferably a five-to-one. **EXAMPLE:** If you have a hook or shackle two feet in diameter, the eye splice should be six-to-ten feet in length. By using this ratio the angle of the two legs of the eye splice at its throat will not be so severe as to cause a parting or tearing action at this point.

LIFTPRO CUSTOM SLINGS FABRICATED

Slings—Fabricated To Your Job Specifications

Lifting the Head Valve of a Diesel Ship - 60" Wide x 24' Long Sling, Built by LiftPRO.

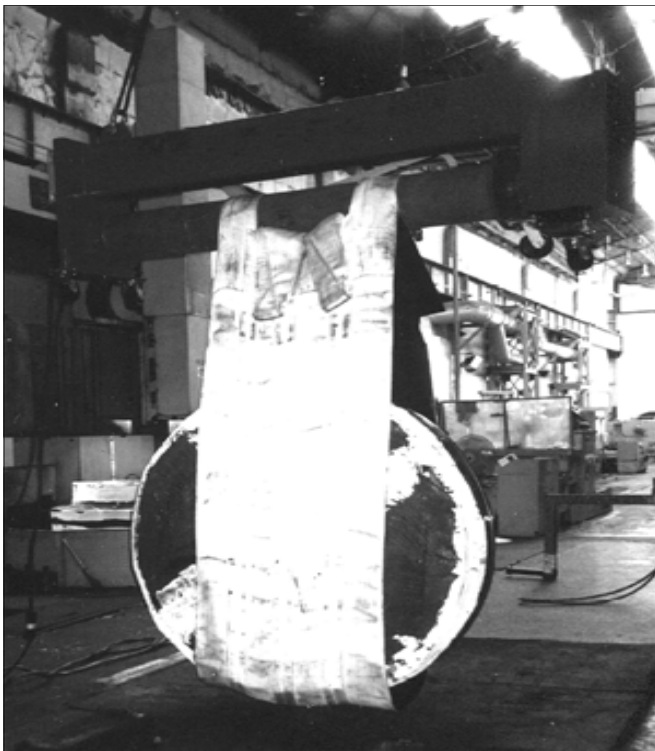

Custom Slings (4' Wide x 22' Long), Rubber Covered Slings for Enhanced Gripping of Large Loads, Built by LiftPRO.

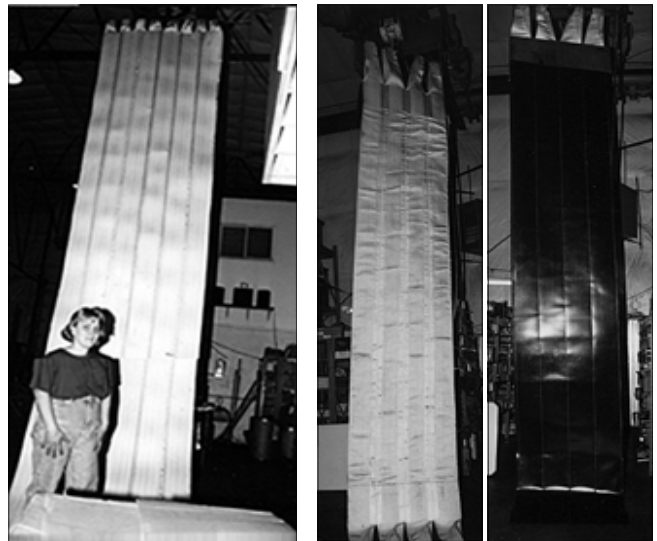

Cordura Covered Basket Sling, Built by LiftPRO.

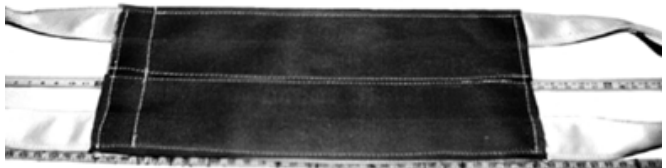

PVC Covered Slings for Extra Wear and Durability, Built by LiftPRO.



Rubber Covered Sling for Enhanced Gripping, 12" Wide x 50' Long, Built by LiftPRO.

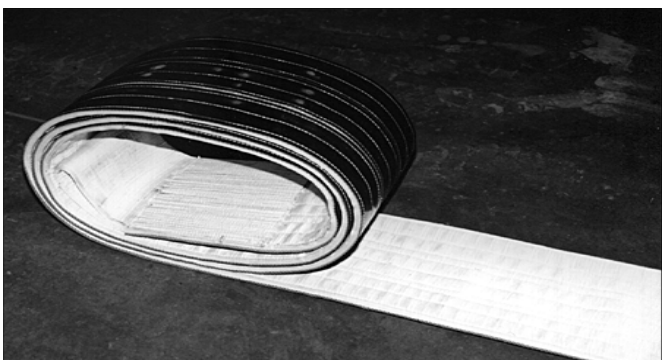

LIFTPRO CUSTOM LIFTING & MOVING DEVICES

Lifting/Moving Devices—Fabricated To Your Job Specifications
Partner with LiftPRO to Solve the Lifting Needs of *Your* Unique Industry

Roll Stands **Developed by LiftPRO**
to Store Large Cylindrical Objects
such as Paper Rolls.

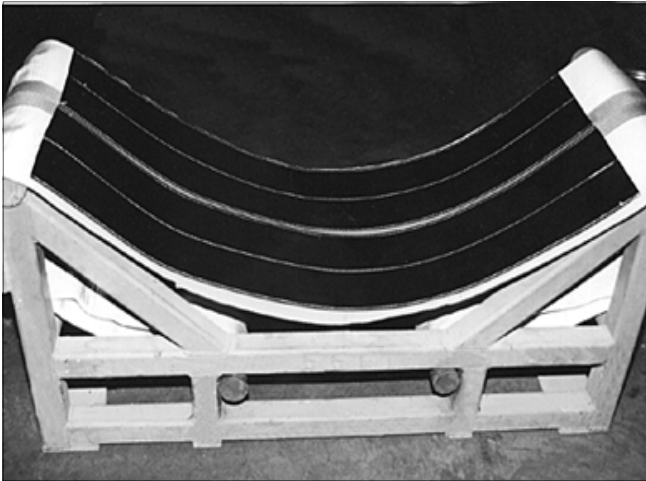

Rubber Covered Slings **Developed by LiftPRO** for Enhanced Gripping,
12" Wide x 50' Long.

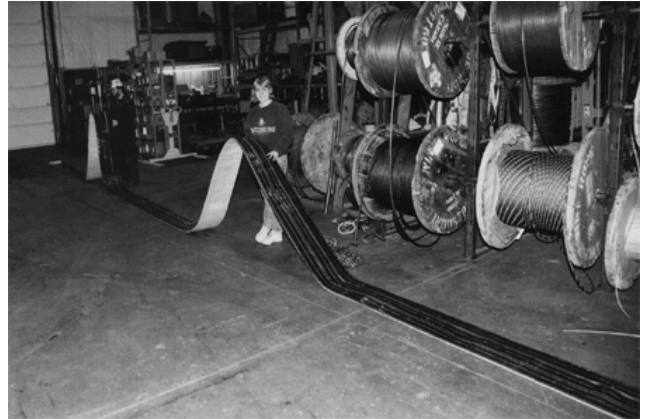

Ladder Slings

Nylon Felt Threading Tail **Developed by LiftPRO** and used by the Paper Industry
to Pull Felts through Paper Machines.



Pipe Stabilizing & Lifting Slings
Custom Designed by LiftPRO can be quickly wrapped around a pipe or cylindrical object and clipped together to provide a snug choker hitch. Slings are available in any custom length to fit your lifting specifications. Rated sling capacity is 2,500 lbs.



GLASS PACK SLINGS

Glass Pack Slings—Fabricated To Your Job Specifications

Stabilize Bundles of Glass—**Glass Pack Sling General Construction:**

- Made from flexible, durable polyester webbing to providing minimal stretch
- Cordura covering to extend wear
- Lined with rubber for cutting resistance & durability
- PVC wear sleeve is anchor stitched at top to maintain placement
- side straps are equipped with PVC wear pads which extend the full dimensions of the straps
- Reinforced top eye of sling, fixed size or adjustable with sliding collar to fit any size spreader bars
- Optional hole at sling bottom for glass pack “boot”
- Available in custom width or lengths to meet your specific lifting requirements

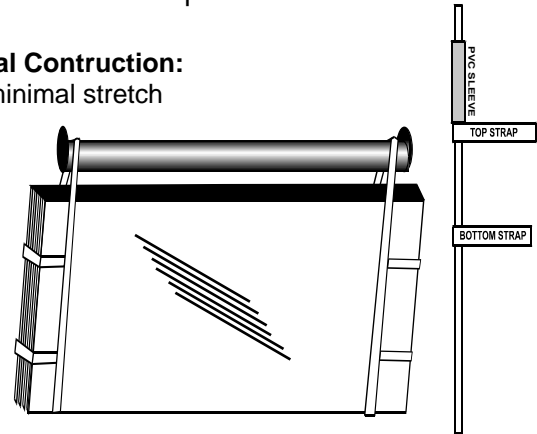

Use the Drawings Below to Determine Your Glass Pack Sling Dimensions

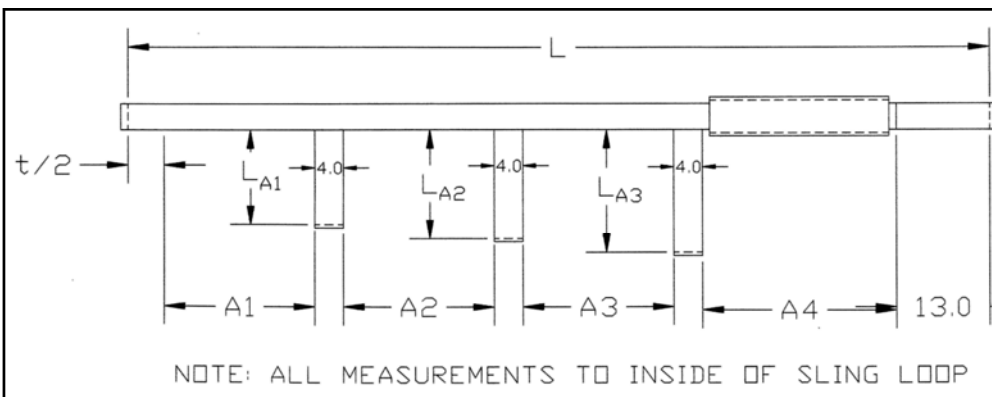

Three Strap Sling Drawing

Load/Sling = _____ Lbs.

- | | |
|----------------------|------------------------------|
| Offset-5= _____ Ins. | |
| L= _____ Ins. | |
| A1= _____ Ins. | L _{A1} = _____ Ins. |
| A2= _____ Ins. | L _{A2} = _____ Ins. |
| A3= _____ Ins. | L _{A3} = _____ Ins. |
| A4= _____ Ins. | t/2= _____ Ins. |

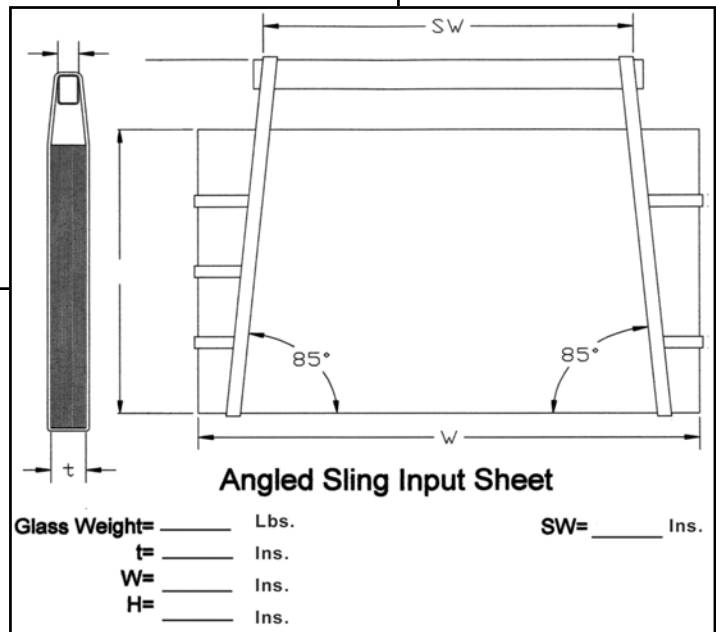

SLING STRENGTH, WEBBING CONSIDERATIONS

Sling Strength & Sling Webbing Considerations

During the 40 year history of wire rope and wire rope slings, the strength of slings has increased 10 - 15% each time the strength of steel is upgraded. Leading the way in increased synthetic sling strength, LiftPRO offers a **synthetic sling that is 10 - 30% stronger than conventional Flat Web Slings.**

With the introduction of this sling, our customer can downsize one size and still have the same lifting capacity. Customers realize savings with LiftPRO by downsizing and retaining lifting capacity.

We have developed our own facilities to manufacture this sling. We have designed and constructed our own sewing machines, test equipment and quality assurance programs. Through years of constant, dedicated research. LiftPRO has developed the strongest slings in their class.

NOTE OF CAUTION:

LiftPRO, Inc. has done extensive research to achieve these results. DO NOT assume all slings are created equally. Please consult the tags on your slings before lifting to assure you are using the proper sling for your specific application.

Sling Webbing Available in Nylon and Polyester

Heavy webbing that is engineered and loomed specifically for industrial uses is available in two strength ratings on all models of slings. The two are identifiable in all tables in this catalog by the second digit in the 4-digit stock number: The number "6" indicates the lower strength, "9" identifies the higher. Both are offered in nylon and polyester.

NYLON is usually selected for use where the sling will not be exposed to either acids or to bleaching agents. It is unaffected by grease or oil, and has good resistance to aldehydes, ethers and strong alkalis. Nylon should never

be exposed to temperatures above 194° F. Elastic stretch at rated capacity of a nylon sling will be approximately 6%.

POLYESTER webbing has good resistance to common industrial acids and hot bleaching solutions, but should never be exposed to concentrated sulfuric acid or strong alkaline solutions. Polyester webbing has elastic stretch of approximately 3% at sling rated capacity, and is frequently used where minimum stretch is desirable. This material should never be exposed to temperatures greater than 194° F.

Environmental Chart

	Acid	Alcohol	Aldehydes	Strong Alkalis	Bleaching Agents	Dry Cleaning Solvents	Ethers	Halogen. Hydrocarbons	Hydrocarbons	Keytones	Oil, Crude	Oil, Lubricating	Soaps, Detergents	Water, Seawater	Weak Alkalis
NYLON	no	ok	ok	ok	no	ok	ok	ok	ok	ok	ok	ok	ok	ok	ok
POLYESTER	*	ok	no	**	ok	ok	no	ok	ok	ok	ok	ok	ok	ok	ok
	* Disintegrated by concentrated sulfuric acid														
	** Degraded by strong alkalis at elevated temperatures														

OPTIONAL WEAR PROTECTION, SLING STRESS

Optional Wear Protection for Slings

Only two of the 10 sling types described in the catalog include any form of protection or reinforcement as standard equipment—Types 6 and 7. Therefore, if slings are to be used under abrasive conditions, wear pads should be specified when ordering to assure an economic and useful life.

LiftPRO provides custom sling covers of conveyor belting, cordura or leather for protection from abrasions and cuts. Cordura nylon fabric is the standard padding material offered, and will be used unless otherwise specified. Pads of chrome leather, or the webbing material as used in the sling body, may be specified on special order.

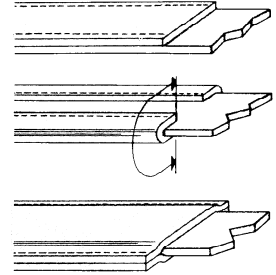

THREE TYPES OF WEAR PADS:

REGULAR pads are an extra layer sewn to webbing at wear points on either or both sides of the sling body or eyes. Multiple layers are available on request.

EDGE GUARD pads are sewn along edges of the sling body where protection is desired.

SLEEVE or **TUBE** pads protect both sides and may be shifted along the sling. This type offers the advantage of remaining stationary as the sling stretches while the load is being lifted.

Where a unique arrangement of padding is desired, a sketch should accompany the order.

Stress on a Sling Can Be More Than the Load

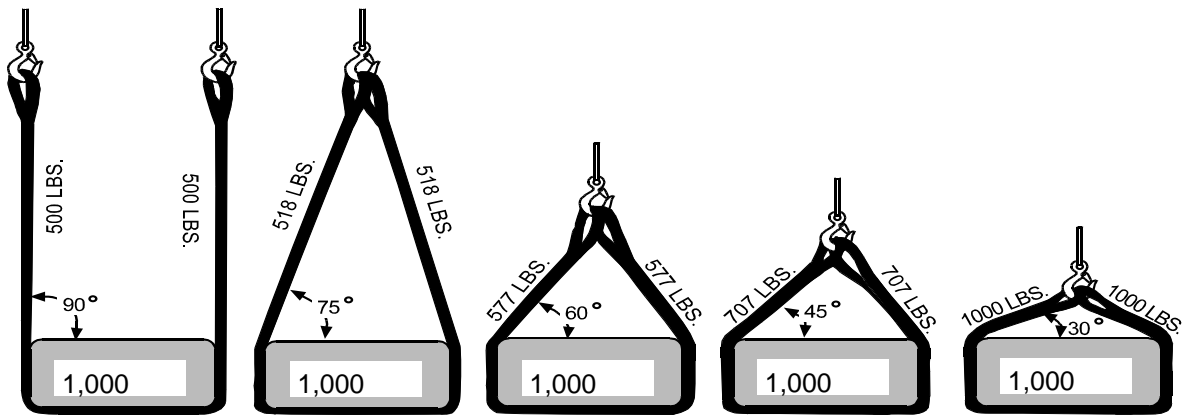

A sling with adequate capacity for a given lift can be broken by rigging the load improperly. It is therefore important that sling users develop an understanding—or a “feel”—for the effect which angles have in the rigging of a sling.

The above drawings show that rigging the lifting device “close” to the load—thereby increasing the angle at which sling legs are spread—increases sharply the tension placed on legs of the sling.

Obviously all lifts cannot be made with two hooks, as in the first illustration above, but rigging in this manner does equally divide a load when its center of gravity is at the midpoint. The same rule applies to multi-leg

bridles—in that the same load is applied to each leg of the bridle.

The most general conclusion that may be made from the four drawings of single-hook lifts is that because of the angle, there is less stress on a longer sling than on a shorter one—when rigged as a basket, as these are. Compare the loading on individual legs of the sling rigged with a 75-degree angle with the sling which has a 30-degree angle.

Therefore, a rule of thumb would be to select the longest sling practical within limitations imposed by overhead lifting clearance.

CALCULATING LOAD LEVELS

Angles of Bridles

LEG ANGLE (Degrees)	LOAD FACTOR
90	1,000
85	1,003
80	1,015
75	1,035
70	1,064
65	1,103
60	1,154
55	1,220
50	1,305
45	1,414
40	1,555
35	1,743
30	2,000

As the horizontal angle between the legs of a sling and the load decreases, the load on each leg increases. The effect is the same whether a single sling is used as a basket, or two slings are used with each in a straight pull, as with a 2-legged bridle.

Anytime pull is exerted at an angle on a leg—or legs—of a sling, the load per leg can be determined by using the data in the table at left. Proceed as follows to calculate this load—and determine the rated capacity required of the sling, or slings, needed for a lift.

1. First, divide load to be lifted by number of legs to be used. This provides load per leg if the lift were being made with all legs lifting vertically.
2. Determine angle between legs of sling and the horizontal.
3. Then MULTIPLY load per leg (as computed in No. 1 above) by the Load Factor for leg angle being used (from the table at the left) — to compute the ACTUAL load on each leg for this lift and angle.

ACTUAL LOAD MUST NOT EXCEED THE RATED SLING CAPACITY.

Thus, in the third illustration on the previous page, (sling angle at 60°): $1000 \div 2 = 500$ (load Per Leg if a vertical lift) $500 \times 1.154 = 577$ lbs. = ACTUAL LOAD on each leg at the 60° included angle being used.

In the fourth illustration on the previous page, (sling angle of 45°): $1000 \div 2 = 500$ (Load Per Leg if a vertical lift) $500 \div 1.414 = 707$ lbs. = ACTUAL LOAD on each leg at the 45° horizontal angle being used.

Choker Hitch Rated Capacity Adjustment

SLING ANGLES in this manual depart from the traditional method of vertical angles measured at the sling hook. It has long been the opinion of sling users that it is easier to measure a sling angle relative to the ground or horizontal. The method is the same whichever angle is used. When the horizontal angle is used you must use the trigonometric sine of the horizontal angle. When the vertical angle is used, you must use the trigonometric cosine of the vertical angle (see illustration).

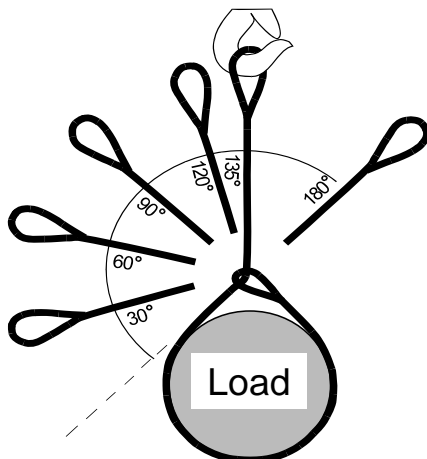

CHOKER HITCH configuration affect the rated capacity of a sling. This is because the sling leg or body is passed around the load, through one end attachment or eye and is suspended by the other end attachment or eye. The contact of the sling body with the end attachment or eye causes a loss of sling strength at this point. If a load is hanging free, the normal choke angle is approximately 135 degrees. When the angle is less than 135 degrees an adjustment in the sling rated capacity must be made (see illustration at left).

As you can see, the decrease in rated capacity is dramatic. Choker hitches at angles greater than 135 degrees are not recommended since they are unstable. Extreme care should be taken to determine the angle of choke accurately.

ANGLE OF CHOKE (Degrees)	RATED CAPACITY PERCENT*
OVER 120	100
90-120	87
60-89	74
30-59	62
0-29	49







**Percent of sling rated capacity in a choker hitch

TRIANGLE WEB SLINGS

TYPE 1 - Triangle-Choker (TCa/TCs) 1-2 Ply &
TYPE 2 - Triangle-Triangle (TTa/TTs) 1-2 Ply



Rated Capacity in Pounds

STOCK NO.	WIDTH	PLY	VERTICAL 	CHOKER** 	BASKET HITCH			
								
*1-602	2"	1	2200	1700	4400	3800	3000	2200
*1-902	2"	1	3200	2500	6400	5500	4500	3200
*2-602	2"	2	4800	3800	9600	8300	6700	4800
*2-902	2"	2	6400	5100	12800	11100	9000	6400
***3-602	2"	3	6700	5300	13400	11600	9400	6700
***3-902	2"	3	8800	7000	17600	15000	12300	8800
***4-602	2"	4	8900	7100	17800	15000	12500	8900
***4-902	2"	4	11700	9300	23400	20000	16400	11700
*1-603	3"	1	3600	2800	7200	6200	5000	3600
*1-903	3"	1	4800	3800	9600	8300	6700	4800
*2-603	3"	2	6600	5200	13200	11000	9200	6600
*2-903	3"	2	9400	7500	18800	16000	13200	9400
***3-603	2"	3	9720	7700	19400	16000	13600	9700
***3-903	2"	3	13230	10500	26400	22500	18700	13200
***4-603	2"	4	12960	10300	25900	22000	18200	12900
***4-903	2"	4	17640	14100	35200	30000	24800	17600
*1-604	4"	1	4600	3600	9200	7500	6400	4600
*1-904	4"	1	6200	4900	12400	10500	8700	6200
*2-604	4"	2	9200	7300	18400	15500	12900	9200
*2-904	4"	2	12500	10000	25000	21000	17600	12500
***3-604	4"	3	12960	10300	25900	22500	18200	12900
***3-904	4"	3	17600	14000	35200	30000	24700	17600
***4-604	4"	4	17000	13600	34000	29000	23900	17000
***4-904	4"	4	23500	18800	47000	40500	33000	23500
*1-606	6"	1	6900	5500	13800	11500	9700	6900
*1-906	6"	1	9400	7500	18800	16000	13200	9400
*2-606	6"	2	12300	9800	24600	21000	17300	12300
*2-906	6"	2	18000	14400	36000	31000	25300	18000
***3-606	6"	3	19000	15200	38000	32500	26700	19000
***3-906	6"	3	26000	20800	52000	44500	36600	26000
***4-606	6"	4	25500	20400	51000	44000	35900	25500
***4-906	6"	4	35000	28000	70000	60000	45200	35000
*1-908	8"	1	12500	10000	25000	21000	17600	12500
*2-908	8"	2	25000	20000	50000	43000	35200	25000
***3-908	6"	3	35000	28000	70000	60000	49200	35000
***4-908	6"	4	47000	37600	94000	81500	66100	47000
*1-910	10"	1	15500	12400	31000	26500	21800	15500
*2-910	10"	2	31000	24800	62000	53500	43600	31000
***3-910	10"	3	44000	35200	88000	76000	61900	44000
***4-910	10"	4	58000	46400	116000	100000	81600	58000
*1-912	12"	1	18500	14800	37000	32000	26000	18500
*2-912	12"	2	37000	29600	74000	64000	52000	37000
***3-912	12"	3	52000	41600	104000	90000	73200	52000
***4-912	12"	4	70000	56000	140000	121000	98500	70000

* **Triangle-Chokers:** Add TCa for Aluminum fitting or TCs for steel fitting.

***Triangle-Triangle:** Add TTa for Aluminum fittings or TTs for steel fitting.

** Choker rated capacities apply to Type 1 Slings Only; Aluminum fittings available in widths up to 6" in 1-ply.

*** Must be used with 4-ply rated triangles.

Warning: Never use aluminum fittings where fumes, vapors, mists or liquids of caustic nature are present. Do not use horizontal sling angles less than 30°.

EYE AND EYE WEB SLINGS, 1-4 PLY

TYPE 3 - Eye & Eye Flat (EEf) 1-4 Ply & TYPE 4 - Eye & Eye Twist (EEt) 1-4 Ply

Standard Sling Eye Types:

FLAT



Single Fold to 1/2 Width



FLAT TWISTED



Double Fold to 1/2 Width









FLAT TAPERED



Double Fold to 1/3 Width



Rated Capacity in Pounds

STOCK NO.	WIDTH	PLY	VERTICAL 	CHOKER 		BASKET HITCH			EYE LENGTH L	EYE WIDTH W
						 60°	 45°	 30°		
EE-1-601	1"	1	1100	900	2200	1900	1545	1100	9"	1"
EE-1-901	1"	1	1600	1300	3200	2700	2250	1600	9"	1"
EE-2-601	1"	2	2300	1800	4600	3900	3250	2300	9"	1"
EE-2-901	1"	2	3100	2500	6200	5300	4350	3100	9"	1"
EE-3-601	1"	3	3600	2900	7200	6200	4900	3600	9"	1"
EE-3-901	1"	3	4400	3500	8800	7600	6100	4400	9"	1"
EE-4-601	1"	4	4300	3400	8600	7400	6000	4300	9"	1"
EE-4-901	1"	4	5800	4600	11600	10000	8000	5800	9"	1"
EE-1-615	1-1/2"	1	1700	1400	3400	2900	2300	1700		
EE-1-915	1-1/2"	1	2350	1900	4700	4000	3300	2350		
EE-2-615	1-1/2"	2	3400	2700	6800	5800	4700	3400		
EE-2-915	1-1/2"	2	4700	3700	9400	8100	6600	4700		
EE-3-615	1-1/2"	3	5100	4100	10200	8800	7100	5100		
EE-3-915	1-1/2"	3	7000	5600	14000	12000	9800	7000		
EE-4-615	1-1/2"	4	6800	5400	13600	11700	9500	6800		
EE-4-915	1-1/2"	4	9300	7400	18600	16000	13000	9300		
EE-1-602	2"	1	2200	1700	4400	3800	3000	2200	9"	2"
EE-1-902	2"	1	3200	2600	6400	5500	4500	3200	9"	2"
EE-2-602	2"	2	4800	3800	9600	8300	6700	4800	9"	2"
EE-2-902	2"	2	6400	5100	12800	11100	9000	6400	9"	2"
EE-3-602	2"	3	6700	5400	13400	11600	9400	6700	12"	2"
EE-3-902	2"	3	8800	7000	17600	15000	12300	8800	12"	2"
EE-4-602	2"	4	8900	9400	17800	15000	12500	8900	12"	2"
EE-4-902	2"	4	11700	9360	23400	20000	16400	11700	12"	2"
EE-1-603	3"	1	3600	2900	7200	6200	5000	3600	9"	1-1/2"
EE-1-903	3"	1	4800	3800	9600	8300	6700	4800	9"	1-1/2"
EE-2-603	3"	2	6600	5300	13200	11000	9200	6600	12"	1-1/2"
EE-2-903	3"	2	9400	7500	18800	16000	13200	9400	12"	1-1/2"
EE-3-603	3"	3	9700	7800	19400	16000	13600	9700	12"	1-1/2"
EE-3-903	3"	3	13200	10600	26400	22500	18600	13200	12"	1-1/2"
EE-4-603	3"	4	13000	10600	26000	22000	18200	13200	12"	1-1/2"
EE-4-903	3"	4	17600	14100	35200	30000	24800	17600	12"	1-1/2"

EEf = Eye & Eye Flat Sling
EEt = Eye & Eye Twisted Sling

Table Continued on following page . . .

EYE AND EYE WEB SLINGS, 1-4 PLY

TYPE 3 - Eye & Eye Flat (EEf) 1-4 Ply & TYPE 4 - Eye & Eye Twisted (EEt) 1-4 Ply

Standard Sling Eye Types:

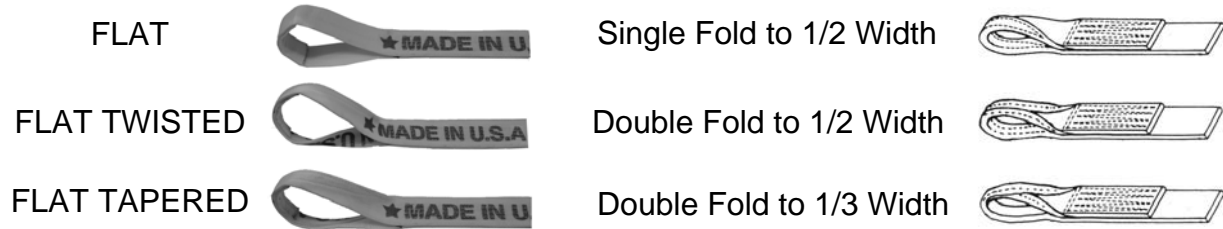







Table Continued from preceding page . . .

Rated Capacity in Pounds

STOCK NO.	WIDTH	PLY	VERTICAL	CHOKER	BASKET HITCH			EYE LENGTH L	EYE WIDTH W	
										
EE-1-604	4"	1	4600	3700	9200	7500	6400	4600	12"	2"
EE-1-904	4"	1	6200	5000	12400	10500	8700	6200	12"	2"
EE-2-604	4"	2	9200	7400	18400	15500	12900	9200	12"	2"
EE-2-904	4"	2	12500	10000	25000	21000	17600	12500	12"	2"
EE-3-604	4"	3	13000	10400	26000	22500	18200	13000	12"	2"
EE-3-904	4"	3	17600	14100	35200	30000	24700	17600	12"	2"
EE-4-604	4"	4	17000	13600	34000	29000	23900	17000	12"	2"
EE-4-904	4"	4	23500	18800	47000	40500	33000	23500	12"	2"
EE-1-606	6"	1	6900	5500	13800	11500	9700	6900	12"	2"
EE-1-906	6"	1	9400	7500	18800	16000	13200	9400	12"	2"
EE-2-606	6"	2	12300	9800	24600	21000	17300	12300	12"	2"
EE-2-906	6"	2	18000	14400	36000	31000	25300	18000	12"	2"
EE-3-606	6"	3	19000	15200	38000	32500	26700	19000	12"	2"
EE-3-906	6"	3	26000	20800	52000	44500	36600	26000	12"	2"
EE-4-606	6"	4	25500	20400	51000	44000	35900	25500	15"	3"
EE-4-906	6"	4	35000	28000	70000	60000	45200	35000	15"	3"
EE-1-908	8"	1	12500	10000	25000	21000	17600	12500	15"	3"
EE-2-908	8"	2	25000	20000	50000	43000	35200	25000	15"	3"
EE-3-908	8"	3	35000	28000	70000	60000	49200	35000	15"	4"
EE-4-908	8"	4	47000	37600	94000	81500	66100	47000	15"	4"
EE-1-910	10"	1	15500	12400	31000	26500	21800	15500	18"	3-1/2"
EE-2-910	10"	2	31000	24800	62000	53500	43600	31000	18"	3-1/2"
EE-3-910	10"	3	44000	35200	88000	76000	61900	44000	24"	5"
EE-4-910	10"	4	58000	46400	116000	100000	81600	58000	24"	5"
EE-1-912	12"	1	18500	14800	37000	32000	26000	18500	24"	4"
EE-2-912	12"	2	37000	29600	74000	64000	52000	37000	24"	4"
EE-3-912	12"	3	52000	41600	104000	90000	73200	52000	24"	6"
EE-4-912	12"	4	70000	56000	140000	121000	98500	70000	24"	6"

EEf = Eye & Eye Flat Sling
EEt = Eye & Eye Twisted Sling





ENDLESS GROMMET WEB SLINGS, 1—4 PLY

TYPE 5 - Endless Grommet (EN) 1-4 Ply



Rated
Capacity
in Pounds



STOCK NO.	WIDTH	PLY	VERTICAL	CHOKER	BASKET HITCH			
								
EN-1-601	1"	1	2300	1840	4600	3900	3200	2300
EN-1-901	1"	1	3100	2480	6200	5300	4300	3100
EN-2-601	1"	2	4600	3680	9200	7900	6400	4600
EN-2-901	1"	2	6200	4960	12400	10600	8700	6200
EN-3-601	1"	3	6400	5120	12800	11000	9000	6400
EN-3-901	1"	3	8800	7040	17600	15200	12300	8800
EN-4-601	1"	4	8600	6880	17200	14800	12000	8600
EN-4-901	1"	4	11700	9360	23400	20200	16400	11700
EN-1-602	2"	1	4600	3680	9200	7900	6400	4600
EN-1-902	2"	1	6200	4960	12400	10700	8700	6200
EN-2-602	2"	2	9200	7360	18400	15900	12900	9200
EN-2-902	2"	2	12500	10000	25000	21600	17600	12500
EN-3-602	2"	3	12900	10320	25800	22300	18100	12900
EN-3-902	2"	3	17600	14080	35200	30400	24700	17600
EN-4-602	2"	4	17200	13760	34400	29700	24200	17200
EN-4-902	2"	4	23500	18800	47000	40700	33000	23500
EN-1-603	3"	1	6900	5520	13800	11900	9700	6900
EN-1-903	3"	1	9400	7520	18800	16200	13200	9400
EN-2-603	3"	2	13800	11040	27600	23900	19400	13800
EN-2-903	3"	2	18800	15040	37600	32500	26400	18800
EN-3-603	3"	3	19400	15500	38800	33600	27300	19400
EN-3-903	3"	3	26400	21100	52800	45700	37100	26400
EN-4-603	3"	4	25900	20700	51800	44800	36400	25900
EN-4-903	3"	4	35200	28100	70400	60900	49500	35200
EN-1-604	4"	1	9200	7360	18400	15900	12900	9200
EN-1-904	4"	1	12500	10000	25000	21600	17600	12500
EN-2-604	4"	2	18400	14720	36800	31800	25900	18400
EN-2-904	4"	2	25000	20000	50000	43300	35200	25000
EN-3-604	4"	3	25800	20600	51600	44600	36300	25800
EN-3-904	4"	3	35000	28000	70000	60600	49200	35000
EN-4-604	4"	4	34000	27200	68000	58800	47800	34000
EN-4-904	4"	4	47000	37600	94000	81400	66100	47000

Nylon or polyester web slings are designed for use in vertical, choker and basket hitches. Legs may be spaced for load stability. Hook points can be tapered to fit hoist hooks, and are reinforced by request.





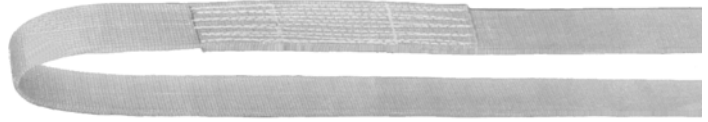

ENDLESS GROMMET WEB SLINGS, 1—4 PLY

TYPE 5 - Endless Grommet (EN) 1-4 Ply



Rated
Capacity
in Pounds



STOCK NO.	WIDTH	PLY	VERTICAL 	CHOKER 	BASKET HITCH			
								
EN-1-604	4"	1	9200	7360	18400	15900	12900	9200
EN-1-904	4"	1	12500	10000	25000	21600	17600	12500
EN-2-604	4"	2	18400	14720	36800	31800	25900	18400
EN-2-904	4"	2	25000	20000	50000	43300	35200	25000
EN-3-604	4"	3	25800	20600	51600	44600	36300	25800
EN-3-904	4"	3	35000	28000	70000	60600	49200	35000
EN-4-604	4"	4	34000	27200	68000	58800	47800	34000
EN-4-904	4"	4	47000	37600	94000	81400	66100	47000
EN-1-606	6"	1	13700	10960	27400	23700	19200	13700
EN-1-906	6"	1	18800	15000	37600	32500	26400	18800
EN-2-606	6"	2	27600	22080	55200	47800	38800	27600
EN-2-906	6"	2	37500	30000	75000	64900	52800	37500
EN-3-606	6"	3	38500	30800	77000	66600	54200	38500
EN-3-906	6"	3	52900	42300	105800	91600	74400	52900
EN-4-606	6"	4	51800	41400	103600	89700	72900	51800
EN-4-906	6"	4	70500	56400	141000	122100	99200	70500
EN-1-908	8"	1	25000	20000	50000	43300	35200	25000
EN-2-908	8"	2	50000	40000	100000	86600	70400	50000
EN-3-908	8"	3	70500	56400	141000	122100	99200	70500
EN-4-908	8"	4	94000	75200	188000	162800	132500	94000
EN-1-910	10"	1	31300	25040	62600	54200	44700	31300
EN-2-910	10"	2	62000	49600	124000	107300	87200	62000
EN-3-910	10"	3	88200	70560	176400	152700	124100	88200
EN-4-910	10"	4	117600	94080	235200	203600	165500	117600
EN-1-912	12"	1	37600	30080	75200	65100	52900	37600
EN-2-912	12"	2	75000	60000	150000	129900	105600	75000
EN-3-912	12"	3	105800	84600	211600	183200	148900	105800
EN-4-912	12"	4	141000	112800	282000	244200	198500	141000

*Customer must specify that sling is to be tapered at hook contact area.

** Also available with sewn-in pear links for 6-inch and above.

EYE & EYE FLAT WEB SLINGS, 5-6 PLY



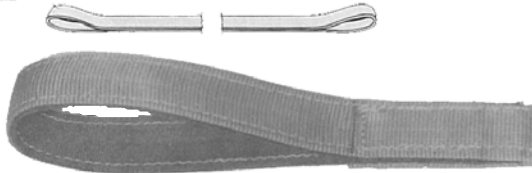

TYPE 3 - Eye & Eye
Flat (EEf) 5-6 Ply

TYPE 4 - Eye & Eye
Twist (EEt) 5-6 Ply

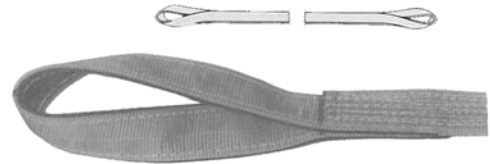

Rated
Capacity
in Pounds



STOCK NO.	WIDTH	PLY	VERTICAL	CHOKER	BASKET HITCH			
								
EE-5-S903	3"	5	23500	18800	47000	40700	33300	23500
EE-6-S903	3"	6	28200	22500	56400	48800	39900	28200
EE-5-S904	4"	5	31300	25000	62600	54200	44300	31300
EE-6-S904	4"	6	37600	30000	75200	65100	53200	37600
EE-5-S906	6"	5	47000	37600	94000	81400	66600	47000
EE-6-S906	6"	6	56400	45100	112800	97700	79900	56400
EE-5-S908	8"	5	62700	50100	125400	108600	88800	62700
EE-6-S908	8"	6	75200	60100	150400	130200	106500	75200
EE-5-S910	10"	5	78400	62700	156800	135800	111000	78400
EE-6-S910	10"	6	94000	75200	188000	162800	133100	94000
EE-5-S912	12"	5	94000	75200	188000	162800	133100	94000
EE-6-S912	12"	6	112800	90200	225600	195400	159700	112800



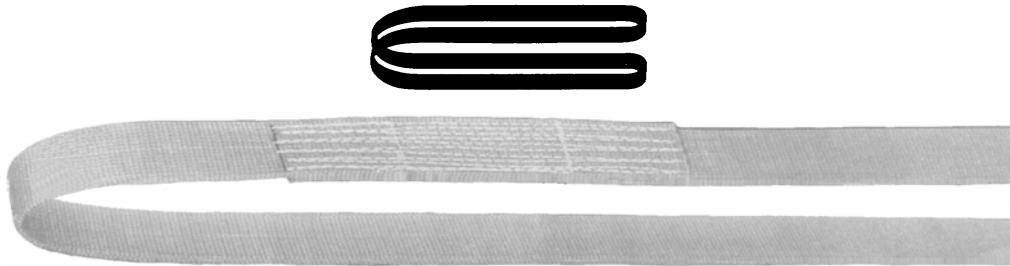

Nylon or polyester web slings are designed for use in vertical, choker and basket hitches. Legs may be spaced for load stability. Hook points can be tapered to fit hoist hooks, and are reinforced by request.

ENDLESS GROMMET WEB SLINGS, 5-6 PLY

TYPE 5 - Endless Grommet (EN) 5-6 Ply

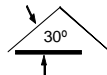

Rated Capacity in Pounds

STOCK NO.	WIDTH	PLY	VERTICAL	CHOKER		BASKET HITCH		
								
EN-5-S903	3"	5	47000	37600	94000	81400	66500	47000
EN-6-S903	3"	6	56400	45100	112800	97700	79900	56400
EN-5-S904	4"	5	62700	50100	125400	108600	88800	62700
EN-6-S904	4"	6	75200	60100	150400	130200	106500	75200
EN-5-S906	6"	5	94000	75200	188000	162800	133100	94000
EN-6-S906	6"	6	112800	90200	225600	195400	159700	112800
EN-5-S908	8"	5	125400	100300	250800	217200	177600	125400
EN-6-S908	8"	6	150500	120400	301000	260700	213100	150500
EN-5-S910	10"	5	156800	125400	313600	271600	222000	156800
EN-6-S910	10"	6	188100	150400	376200	325800	266300	188100
EN-5-S912	12"	5	188100	150500	376200	325800	266300	188100
EN-6-S912	12"	6	225800	180600	451600	391100	319700	225800

Nylon or polyester web slings are designed for use in vertical, choker and basket hitches. Legs may be spaced for load stability. Hook points can be tapered to fit hoist hooks, and are reinforced by request.



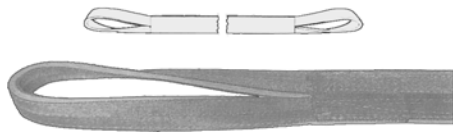

CLASSIC WEB SLINGS, 1-4 PLY

TYPE 6 - Reversed Eye (RE) 1-4 Ply & TYPE 7 - Flat Eye Twist (FE) 1-4 Ply

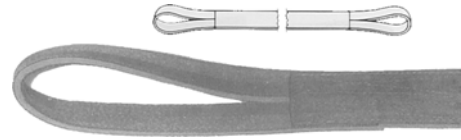

Rated
Capacity
in Pounds



STOCK NO.	WIDTH	PLY	VERTICAL	CHOKER	BASKET HITCH			EYE WIDTH W	EYE LENGTH L	
										
*-1-602	2"	1	2400	1920	4800	4200	3400	2400	1"	9"
*-1-902	2"	1	3200	2600	6400	5500	4500	3200	1"	9"
*-2-602	2"	2	4800	3800	9600	8300	6800	4800	1"	12"
*-2-902	2"	2	6400	5100	12800	11100	9000	6400	1"	12"
*-1-604	4"	1	4800	3800	9600	8300	6800	4800	2"	12"
*-1-904	4"	1	6400	5100	12800	11100	9000	6400	2"	12"
*-2-604	4"	2	9600	7700	19200	16600	13600	9600	2"	12"
*-2-904	4"	2	12800	10200	25600	22200	18100	12800	2"	12"
*-3-604	4"	3	13300	10700	26600	23100	18800	13300	2"	15"
*-3-904	4"	3	17800	14200	35500	30800	25100	17800	2"	15"
*-4-604	4"	4	17800	14200	35500	30800	25100	17800	2"	15"
*-4-904	4"	4	23700	18900	47400	41100	33400	23700	2"	15"
*-1-606	6"	1	7200	5800	14400	12500	10200	7200	1-1/2"	12"
*-1-906	6"	1	9600	7700	19200	16600	13600	9600	1-1/2"	12"
*-2-606	6"	2	13300	10700	26600	23100	18800	13300	1-1/2"	15"
*-2-906	6"	2	17800	14200	35500	30800	25100	17800	1-1/2"	15"
*-3-606	6"	3	20000	15600	40000	34600	28200	20000	3"	18"
*-3-906	6"	3	26600	21300	53300	46200	37600	26600	3"	18"
*-4-606	6"	4	26600	21300	53300	46200	37600	26600	3"	18"
*-4-906	6"	4	35500	28400	71000	61600	50200	35500	3"	18"

*Use letter prefix RE or FE to indicate Type 6 or Type 7.

REVERSED EYE

An exceptionally durable sling that features full body and eye protection. The hook openings are 90° to the sling body for tighter choker hitches, and easy vertical and basket hitch rigging.

FLAT EYE

Slings of the same construction as type 6 except that the hook openings are on the same plane as the sling body. The flat eye permits rigging through narrower openings and easier removal from under load. Rigs effectively in choker and basket hitches.

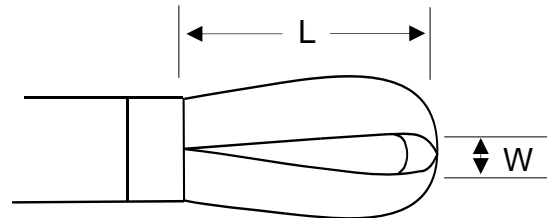



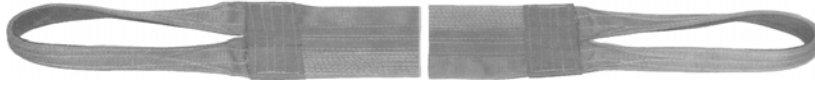

CLASSIC WEB SLINGS, 1-2 PLY

TYPE 8 - Wide Body Basket (WBB)



Rated Capacity in Pounds

STOCK NO.	WIDTH	PLY	BASKET HITCH				EYE WIDTH W	EYE LENGTH L
								
WBB-1-606	6"	1	14400	13900	12500	10200	12"	1-1/2"
WBB-1-906	6"	1	19200	18600	16600	13600	12"	1-1/2"
WBB-2-606	6"	2	26640	25800	23100	18800	15"	1-1/2"
WBB-2-906	6"	2	35520	34300	30800	25100	15"	1-1/2"
WBB-1-608	8"	1	19200	18600	16600	13600	12"	2"
WBB-1-908	8"	1	25600	24700	22200	18080	12"	2"
WBB-2-608	8"	2	34560	33400	29900	24400	15"	2"
WBB-2-908	8"	2	46080	44500	39900	32500	15"	2"
WBB-1-610	10"	1	24000	23200	20800	16900	15"	1-3/4"
WBB-1-910	10"	1	32000	30900	27700	22600	15"	1-3/4"
WBB-2-610	10"	2	42000	40600	36400	29700	18"	2-1/2"
WBB-2-910	10"	2	56000	54100	48500	39500	18"	2-1/2"
WBB-1-612	12"	1	28800	27800	24900	20300	15"	2"
WBB-1-912	12"	1	38400	37100	33300	27100	15"	2"
WBB-2-612	12"	2	49000	47300	42400	34600	18"	3"
WBB-2-912	12"	2	65300	63100	56600	46100	18"	3"
WBB-1-916	16"	1	51200	49500	44400	36200	18"	3"
WBB-2-916	16"	2	81900	79200	71000	57800	24"	4"
WBB-1-920	20"	1	64000	61900	55500	45200	24"	3-1/2"
WBB-2-920	20"	2	96000	92800	83200	67800	24"	5"
WBB-1-924	24"	1	76800	74200	66600	54200	24"	4"
WBB-2-924	24"	2	107500	103900	93200	75900	24"	6"

*Narrower taper available on special request only.

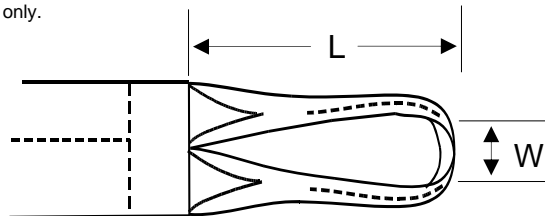



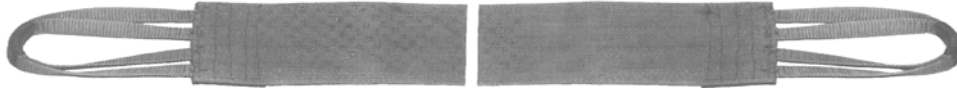

Designed for use in basket hitches where a wide sling is needed for load stability and where width is required for proper handling of fragile or highly finished surfaces. Eyes of slings are tapered to fit on hoist or crane hooks and are reinforced to provide increased durability.

CLASSIC WEB SLINGS, 1 PLY

TYPE 9 - Load Balancer Basket (LBB)



Rated Capacity in Pounds

STOCK NO.	WIDTH	PLY	BASKET HITCH				EYE WIDTH W	EYE LENGTH L
								
LBB-1-606	6"	1	3000	2600	2100	1500	1"	9"
LBB-1-906	6"	1	6000	5200	4200	3000	1"	9"
LBB-1-608	8"	1	3000	2600	2100	1500	1"	12"
LBB-1-908	8"	1	6000	5200	4200	3000	1"	12"
LBB-1-610	10"	1	3000	2600	2100	1500	1"	12"
LBB-1-910	10"	1	6000	5200	4200	3000	1"	15"
LBB-1-612	12"	1	3000	2600	2100	1500	1"	18"
LBB-1-912	12"	1	6000	5200	4200	3000	1"	18"
LBB-1-616	16"	1	5000	4300	3500	2500	2"	18"
LBB-1-916	16"	1	10000	8700	7100	5000	2"	24"
LBB-1-620	20"	1	5000	4300	3500	2500	2"	24"
LBB-1-920	20"	1	10000	8700	7100	5000	2"	24"
LBB-1-624	24"	1	5000	4300	3500	2500	2"	24"
LBB-1-924	24"	1	10000	8700	7100	5000	2"	24"

*Narrower taper available on special request only.

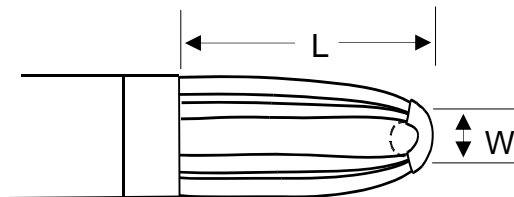

Designed for use where sling width is required for load stability and for protection of finished surfaces or fragile loads. These slings have lower rated capacity than the Wide Body Basket. Eyes are constructed to fit properly on small hoist hooks.

CLASSIC MULTI-LEG BRIDLES

TYPE 10 - Multi-Leg Bridles (MLB)

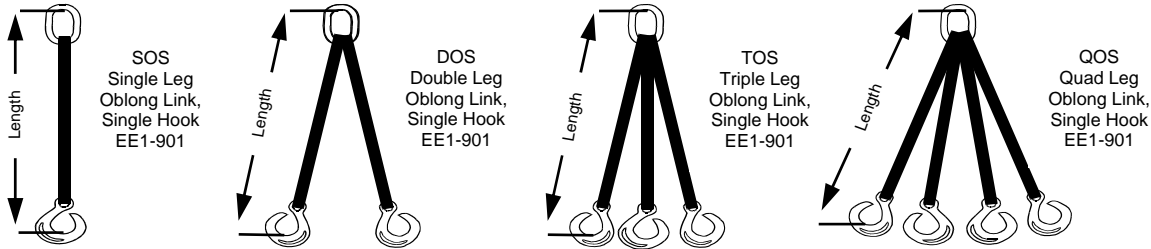

Because the lifting of loads is a vital operation, and the sling user's needs are frequently unique, virtually all sling orders are custom made. Therefore, it is essential that each order provide the following information to guide manufacturing:

HOW TO ORDER

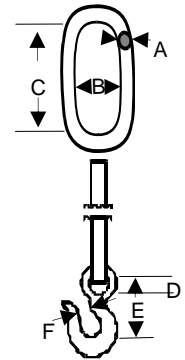
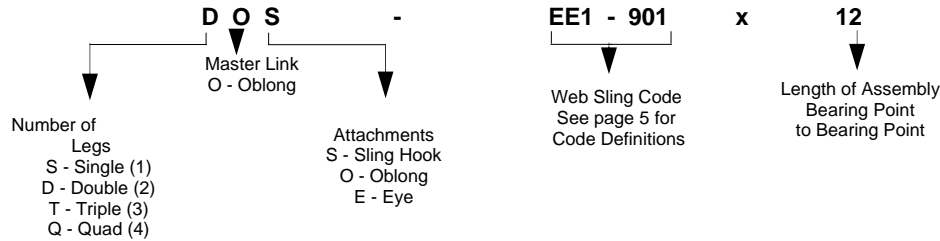

Rated Capacity in Pounds for Bridle Slings

STOCK NO.	WIDTH	PLY	NUMBER OF LEGS	RATED CAPACITY				Oblong Link Dimensions (inches)			Sling Hook Dimensions (inches)		
				90°	60°	45°	30°	A	B	C	D	E	F
EE1-901	1	1	Single	1600	1300	1100	800	1/2	2-1/2	5	3/4	3-1/8	1
EE1-901	1	1	Double	3200	2700	2200	1600	1/2	2-1/2	5	3/4	3-1/8	1
EE1-901	1	1	Triple	4800	4100	3300	2400	3/4	3	6	3/4	3-1/8	1
EE1-901	1	1	Quad	6400	5500	4500	3200	1	4	6	3/4	3-1/8	1
EE2-901	1	2	Single	3000	2500	2100	1500	1/2	2-1/2	5	7/8	3-21/32	1-1/16
EE2-901	1	2	Double	6000	5100	4200	3000	3/4	3	6	7/8	3-21/32	1-1/16
EE2-901	1	2	Triple	9000	7700	6300	4500	3/4	3	6	7/8	3-21/32	1-1/16
EE2-901	1	2	Quad	12000	10300	8400	6000	1	4	8	7/8	3-21/32	1-1/16
EE1-902	2	1	Single	3000	2500	2100	1500	1/2	2-1/2	5	7/8	3-21/32	1-1/16
EE1-902	2	1	Double	6000	5100	4200	3000	3/4	3	6	7/8	3-21/32	1-1/16
EE1-902	2	1	Triple	9000	7700	6300	4500	3/4	3	6	7/8	3-21/32	1-1/16
EE1-902	2	1	Quad	12000	10300	8400	6000	1	4	8	7/8	3-21/32	1-1/16
EE2-902	2	2	Single	6000	5100	4200	3000	3/4	3	6	1-1/4	4-11/16	1-1/4
EE2-902	2	2	Double	12000	10300	8400	6000	1	4	8	1-1/4	4-11/16	1-1/4

*TA = Ton Alloy
Identify by code, leg and end attachments.
Other end attachments available.
Capacities of Hardware correspond to the Sling Capacities.

WARNING: Do not exceed rated capacities. Ratings must be reduced when slings are used at angles of less than 90° from horizontal.

EXAMPLES OF WEAR AND ABUSE

Far too many web slings have to be thrown away prematurely simply because abusive and careless work habits caused irreparable damage. Following are examples of damage typically caused by abuse and misuse. Regardless of whether a sling shows damage from abuse or normal wear, however, the overriding rule in all cases is that sling eyes should be cut and the sling discarded immediately whenever damage is detected.

Tensile Break

A tensile break is characterized by a frayed appearance at the point of failure or damage. Such damage is caused by loading the sling beyond its existing strength. The example pictured was pulled to destruction on a testing machine.

Cuts

A cut is easily identified by a clean break in the webbing structure or fibers, and usually results from the sling contacting a sharp object or unprotected edge of a load. Such damage may be found anywhere in the body or eyes of a web sling. Red Guard warning yarns are woven into webbing of many slings to provide a warning when a serious cut has occurred. Cuts from contact with sharp corners during lifts can often be avoided by using wear pads or sling for protection of the fabric. **LiftPRO advises not to rely solely on exposure of "red core yarn" as indication of web wear! See "Red Core Yarn Advisory" on page 3.**

Cut and Tensile Damage

The sample shown below illustrates a typical shop failure in which a sling is used after having received a cut by a sharp object along one edge of the sling body. The cut severely reduces lifting capacity and continued usage will result in the sling breaking much as shown. Such a failure often occurs at a level far below the Rated Capacity of the sling.

Abrasion Damage

The most common abrasion damage occurs either when a sling slips while in contact with a load during a lift, or when being pulled from under a load. Abrasion is characterized by frayed fibers on the surface which exposes the "picks," or cross fibers of the webbing that hold in place the load-bearing (lengthwise) fibers. Further abrasion at this point will expose the Red Guard warning yarns to signal the inspector or sling user that serious damage and loss of lifting capacity has occurred. Any damage to load-bearing fibers should be viewed critically.

Acid Damage

Although Polyester webbing has considerable resistance to certain acids, and Nylon should never be exposed to possible contact with an acid, any contact with strong acids should be avoided. Metal fittings on slings should not be exposed to any acid or corrosive liquid.

EXAMPLE A — The damage shown here to Nylon webbing occurred when sulfuric acid (such as used in an automobile battery) was heated to 100° C. (212° F.) and dropped on the webbing. The charring of surface fibers seen here is typical of acid damage. The deterioration shown will continue over time and severely affect webbing strength.

EXAMPLE B — A piece of Nylon webbing was immersed in sulfuric acid at room temperature for three weeks, resulting in the significant damage shown. Note that fibers are softened and swollen and the entire fabric is grossly distorted, virtually destroying the webbing. Precautions should be taken never to store slings where they may be exposed to acid fumes (which can be as destructive as liquid) or to possible contact with acid.

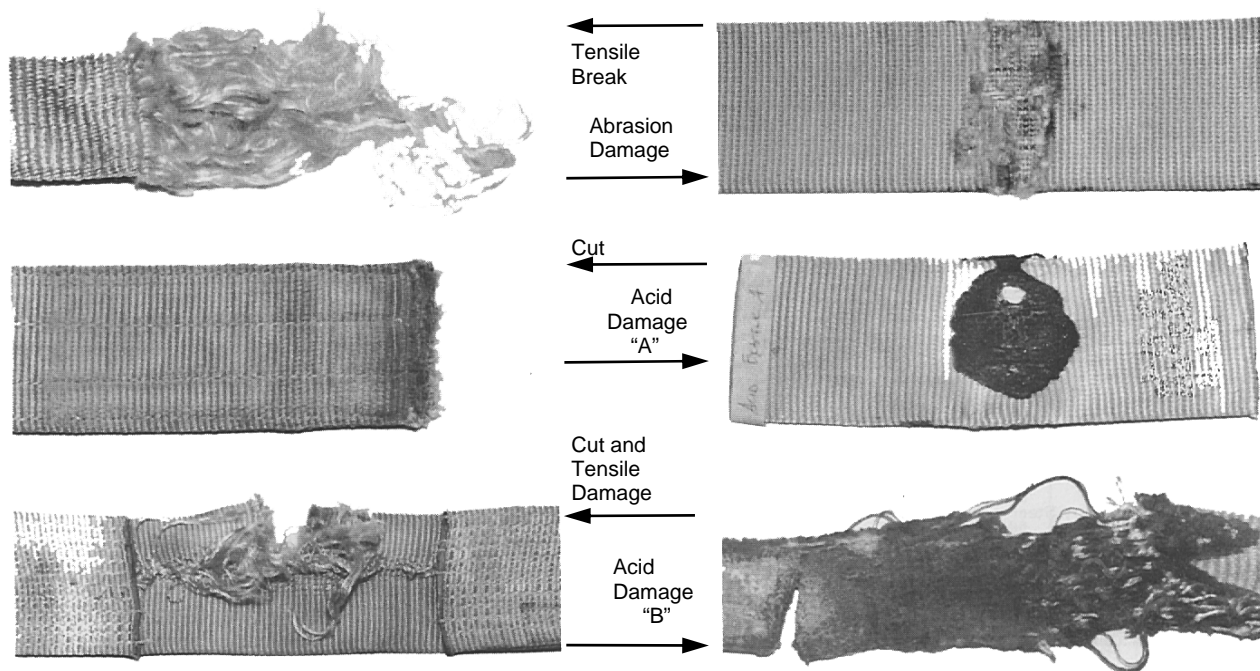

OPERATING PRACTICES FOR SYNTHETIC SLINGS

Recommended Operating Practices:

PURPOSE

The purpose of this chapter is to provide guidelines for the qualified person responsible for web sling selection, rigging, inspection and use.

MECHANICAL CONSIDERATIONS

- 1 Determine weight of the load. The weight of the load shall be within the rated capacity of the web sling.
- 2 Select a web sling having suitable characteristics for the type of load, hitch and environment.
- 3 Web slings shall not be loaded in excess of the rated capacity. Consideration shall be given to the sling to load angle which affects rated capacity.
- 4 Web slings with fittings which are used in a choker hitch shall be of sufficient length to assure that the choking action is on the webbing, and never on the fitting.
- 5 Web slings used in a basket hitch shall have the load balanced to prevent slippage.
- 6 The opening in fittings shall be the proper shape and size to ensure that the fitting will seat properly in the hook or other attachments.
- 7 Web slings shall always be protected from being cut by sharp comers, sharp edges, protrusions or abrasive surfaces.
- 8 Web slings shall not be dragged on the floor or over abrasive surfaces.
- 9 Web slings shall not be twisted, shortened, lengthened, tied in knots, or joined by knotting.
- 10 Web slings shall not be pulled from under loads when the load is resting on the web sling.
- 11 Do not drop web slings equipped with metal fittings.
- 12 Web slings that appear to be damaged shall not be used unless inspected and accepted as usable.
- 13 The web sling shall be hitched in a manner providing control of the load.
- 14 Personnel, including portions of the human body, shall be kept from between the sling and the load, and from between the sling and the crane hook or hoist hook.
- 15 Personnel shall stand clear of suspended loads.
- 16 Personnel shall not ride the web sling or the load being lifted.
- 17 Shock loading shall be avoided.
- 18 Twisting and kinking the legs (branches) shall be avoided.
- 19 Load applied to the hook shall be centered in the base (bowl) of hook to prevent point loading on the hook.
- 20 During lifting, with or without the load, personnel shall be alert for possible snagging.
- 21 The web slings legs (branches) shall contain or support the load from the sides above the center of gravity when using a basket hitch.
- 22 Web slings shall be long enough so that the rated load (rated capacity) is adequate when the sling to load angle is taken into consideration.
- 23 Only web slings with legible identification tags shall be used.
- 24 Tags and labels should be kept away from the load, hook and point of choke.
- 25 Web slings shall not be constricted or bunched between the ears of a clevis, shackle, or in a hook.
- 26 Place blocks under load prior to setting down the load to allow removal of the web sling, if applicable.

Inspection:

- 1 Initial Inspection—Before any new or repaired web sling is placed in service, it shall be inspected by a designated person to insure that the correct web sling is being used as well as to determine that the web sling meets the requirements of this specification.
- 2 Frequent Inspection—This inspection shall be made by a qualified person handling the web sling each time it is used.
- 3 Periodic Inspection—This inspection shall be conducted by designated personnel. Inspection frequency should be based on:
 - a. Frequency of web sling use
 - b. Severity of service conditions
 - c. Experience gained on the service life of web slings used in similar applications
 - d. Inspections should be conducted at least annually

ENVIRONMENTAL CONSIDERATIONS

- 1 Web Slings should be stored in a cool, dry, and dark place to prevent loss of strength when not in use through exposure to ultra-violet rays. Web slings shall not be stored in chemically active areas.
- 2 Chemically active environments can affect the strength of web slings in varying degrees ranging from little to total degradation. The web sling manufacturer, or qualified person should be consulted before slings are used in a chemically active environment.

ACIDS - Nylon is subject to degradation in acids, ranging from little to total degradation.

Polyester is resistant to many acids, but is subject to degradation, ranging from little to moderate in some acids.

Each application shall be evaluated, taking into consideration the following:

- a. Type of acid
- b. Exposure conditions
- c. Concentration
- d. Temperature

ALKALIS - Polyester is subject to degradation in alkalis, ranging from little to total degradation. Nylon is resistant to many alkalis, but is subject to degradation ranging from little to moderate in alkalis.

Each application shall be evaluated, taking into consideration the following:

- a. Type of Alkalis
- b. Exposure conditions
- c. Concentration
- d. Temperature

- 3 Nylon and polyester web slings shall not be used at temperatures in excess of 194° F (90° C), or at temperatures below minus 40° F (-40° C).

- 4 Web slings incorporating aluminum fittings shall not be used where fumes, vapors, sprays, mists, or liquids of alkalis and/or acids are present.

Environmental Considerations continued . . .

OPERATING PRACTICES FOR SYNTHETIC SLINGS

Environmental Considerations continued . . .

- 5 Environments in which synthetic web slings are continuously exposed to ultra-violet light can affect the strength of synthetic web slings in varying degrees ranging from slight to total degradation.

CAUTION: Degradation can take place without visible indications.

- a. Factors which affect the degree of strength loss are:
 - (1) Length of time of continuous exposure
 - (2) Web sling construction and design
 - (3) Other environmental factors such as weather conditions and geographic location
- b. Procedures to minimize the affects of ultra-violet light
 - (1) Store web slings in a cool, dry and dark place when not being used for prolonged periods of time
- c. Some visual indications of ultra-violet degradation are:
 - (1) Bleaching out of web sling color
 - (2) Increased stiffness of web sling material
 - (3) Surface abrasion in areas not normally in contact with the load
- d. Proof Testing—Slings used in environments where they are subject to continuous exposure to ultra-violet light shall be proof tested to twice the rated capacity semi-annually, or more frequently depending on severity of exposure.

Removal from Service:

A web sling shall be removed from service if any of the following are visible:

5. If sling rated capacity or sling material identification is missing or not readable.
6. Acid or alkali burns.
7. Melting, charring, or weld spatter of any part of the webbing.
8. Holes, tears, cuts, snags or embedded particles.
9. Broken or worn stitching in load bearing splices.
10. Excessive abrasive wear.
11. Knots in any part of the webbing.
12. Distortion and excessive pitting or corrosion or broken fittings.

Other apparent defects which cause doubt as to the strength of the web sling.

Inspection Records:

Written web sling inspection records, utilizing the identification for each sling as established by the user, should be kept on file for all web slings. These records should show a description of the new web sling and its condition on each subsequent inspection.

Repair of Web sling Webbing:

- 1 Sling webbing with structural damage shall never be repaired.
- 2 Type I and Type II web slings, and other web slings utilizing hardware, may be re-webbed utilizing existing fittings. It shall be the responsibility of the manufacturer repairing the web sling to determine if the hardware is re-usable.
- 3 All re-webbed Type I and Type II, and other web slings utilizing fittings, shall be proof tested to two (2) times their vertical rated capacity before being placed back into service. A certificate of proof testing shall be provided.
- 4 Temporary repairs of webbing, fittings, or stitching shall not be permitted.

Recommended Standard Specification for Synthetic Web Slings, ©1994
Web Sling & Tiedown Association, Inc.
5024-R Campbell Blvd.
Baltimore, MD 21236

NOTE:

LiftPRO, Inc. assumes no responsibility for the misuse or misapplication of any of its products. Products are provided with the express understanding that the purchaser and/or user are thoroughly familiar with the correct application and proper use. Warnings and definitions are provided as an aid to the user in understanding correct application and proper use. These charts are not a substitute to proper training.

ALUMINUM, STEEL TRIANGLES & CHOKERS

ALUMINUM TRIANGLES

Size	A	B	C	D	E	F	G	Approx. Weight in lbs.	WLL in lbs.	Min. Break Strength
T2	4	3-5/8	2-1/4	1-3/4	15/16	2-3/8	9/16	.31	3360	16800
T3	5-1/4	5	3-1/4	2	1-3/16	3-	5/8	.75	5000	25000
T4	6-1/4	6-5/8	4-3/8	2-3/8	1-7/16	4	11/16	1.1	6700	33500
T5	7-1/4	7-3/4	5-3/8	2-3/4	1-5/8	4-3/4	3/4	1.6	8400	42000
T6	8-	8-7/8	6-3/8	3-1/8	1-3/4	5-1/2	15/16	2.5	9700	48500

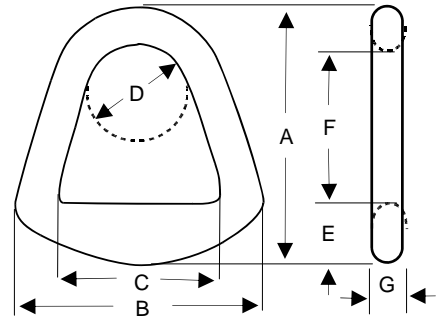

ALUMINUM CHOKERS

Size	A	B	C	D	E	F	G	Approx. Weight in lbs.	WLL in lbs.	Min. Break Strength
C2	6-1/8	5-1/4	2-1/8	1-3/4	15/16	2-3/8	9/16	.75	3360	16800
C3	7-1/2	7-1/8	3-1/8	2	1-1/8	3-5/16	5/8	1.2	5000	25000
C4	8-3/4	8-3/4	4-1/8	2-3/8	1-7/16	4	11/16	1.8	6700	33500
C5	10	10-3/8	5-1/8	2-3/4	1-11/16	4-3/4	3/4	2.9	8400	42000
C6	11-5/16	11-3/4	6-1/8	3-1/8	1-3/4	5-1/2	15/16	5.1	9700	48500

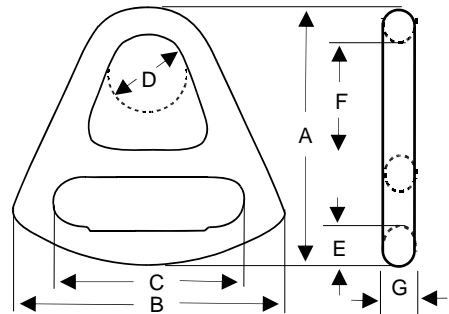

STEEL TRIANGLES

Size	A	B	C	D	E	F	G	Approx. Weight	WLL in lbs.	Min. Break Strength
ST2	4-3/4	3-27/32	2-1/4	2	1-1/4	2-3/4	3/8	1	6600	33000
ST3	6-1/4	5-3/8	3-1/4	2	1-7/8	3-1/2	3/8	1-3/4	8400	42000
ST4	7-5/8	6-1/2	4-1/4	3	2-3/8	4-1/4	3/8	2-3/4	11200	56000
ST5	9-1/4	7-31/32	5-1/4	2-3/4	2-5/8	5-1/2	1/2	4-3/4	14000	70000
ST6	10-1/16	9-1/2	6-1/4	3-1/4	3-1/8	5-9/16	1/2	6-1/2	16800	84000
ST8	12	11-3/32	8-1/4	3-3/4	3-3/8	7-1/2	3/4	12-1/2	22400	112000
ST1	15-3/16	14-3/16	10-1/4	5	4-1/8	9-3/8	3/4	21-1/2	28000	140000
ST1	16-1/4	16-5/8	12-1/4	5-1/4	5	9-1/2	3/4	25	32000	160000

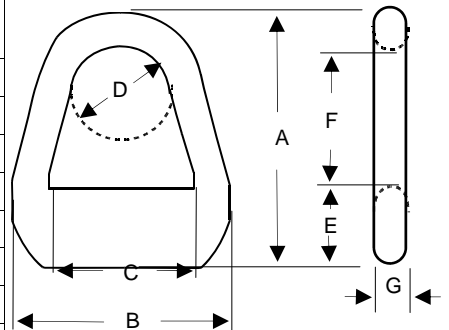

STEEL CHOKERS

Size	A	B	C	D	E	F	G	Approx. Weight in lbs.	WLL in lbs.	Min. Break Strength
SC2	7	5-3/4	2-1/4	2	1-1/4	2-1/2	3/8	2-1/4	6600	33000
SC3	8	7-11/16	3-1/4	2	1-7/8	2-7/8	3/8	3-1/4	8400	42000
SC4	10-1/4	9-13/16	4-1/4	3	2-3/8	4	3/8	5-1/2	11200	56000
SC5	11-5/8	12-1/16	5-1/4	2-3/4	2-5/8	5	1/2	9-1/4	14000	70000
SC6	13	13	6-1/4	3-1/4	3-1/8	5-1/2	1/2	13	16800	84000
SC8	15	14-3/4	8-1/4	3-3/4	3-3/8	7-1/2	3/4	23-3/4	22400	112000
SC1	17-	18-5/16	10-1/4	5	4-1/8	8-7/8	3/4	36	28000	140000
SC1	19-1/2	21-1/2	12-1/4	5-1/4	5	9-1/2	3/4	47-3/4	32000	160000

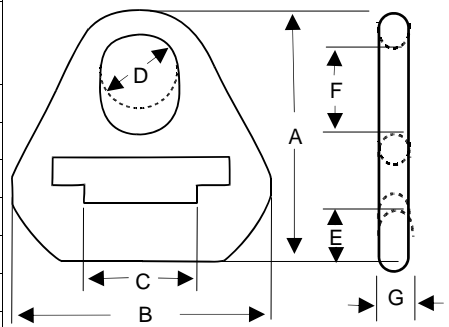

EYE HOOKS

EYE HOOKS													
Working Load Limits (tons)		Weight (lbs.)	Dimensions (in.)										Deformation Indicator
Carbon	Alloy	320	A	B	C	D	E	F	G	H	I	J	K
3/4	1	.55	4.34	1.47	3.22	2.88	.75	2.00	.75	.81	1.25	.97	1.50
1	1-1/2	.75	4.94	1.75	3.69	3.19	.91	2.25	.84	.94	1.38	1.06	1.50
1-1/2	2	1.25	5.56	2.03	4.09	3.62	1.13	2.53	1.00	1.16	1.50	1.12	2.00
2	3	1.70	6.38	2.41	4.69	4.09	1.25	2.84	1.12	1.31	1.63	1.25	2.00
3	4-1/2	3.60	7.91	2.94	5.78	4.94	1.56	3.56	1.44	1.62	2.00	1.50	2.50
5	7	7.08	10.09	3.81	7.38	6.50	2.00	4.44	1.18	2.06	2.50	1.88	3.00
7-1/2	11	13.00	12.44	4.69	9.06	7.56	2.44	5.50	2.25	2.62	3.00	2.25	4.00
10	15	18.50	13.94	5.38	10.06	8.69	2.84	6.19	2.59	2.94	3.25	2.50	4.00
15	22	33.809	17.09	6.63	12.53	11.00	3.50	7.31	2.97	3.50	4.25	3.38	5.00
20	30	60.00	19.47	7.00	14.06	13.62	3.50	8.78	3.62	4.62	5.00	4.00	6.50
20	30	-	-	-	-	13.62	-	8.78	3.62	4.62	5.00	4.00	6.50
25	37	105.00	24.81	8.50	18.19	14.06	4.50	11.38	4.56	5.00	5.38	4.25	7.00
25	37	-	-	-	-	14.06	-	11.38	4.56	5.00	5.38	4.25	7.00
30	45	148.00	27.44	9.31	20.12	15.44	4.94	12.63	5.06	5.50	6.00	4.75	8.00
30	45	-	-	-	-	15.44	-	12.63	5.06	5.50	6.00	4.75	8.00
40	60	228.00	32.31	10.75	23.72	18.50	5.69	14.81	6.00	6.50	7.00	5.75	10.00
40	60	-	-	-	-	18.50	-	14.81	6.00	6.50	7.00	5.75	10.00
50*	75*	-	-	-	-	20.62	-	16.53	6.69	7.25	7.75	6.50	11.50
50*	75*	-	-	-	-	20.62	-	16.53	6.69	7.25	7.75	6.50	11.50
-	100*	-	-	-	-	23.00	-	17.38	8.59	9.88	6.81	5.88	12.00
-	100*	-	-	-	-	23.00	-	17.38	8.59	9.88	6.81	5.88	12.00
-	150*	-	-	-	-	24.38	-	18.00	9.12	10.94	6.75	6.00	13.00
-	200*	-	-	-	-	26.69	-	19.75	9.75	11.81	7.50	6.60	13.00
-	300*	-	-	-	-	30.12	-	22.69	10.62	12.94	9.50	8.00	15.00

*Shank Hooks only.

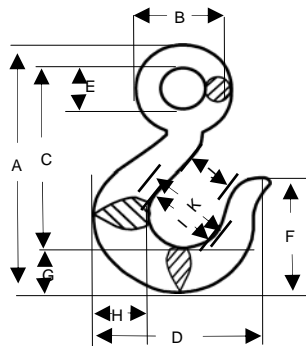

OBLONG MASTER RINGS

Manufactured with a 5:1 Design Factor

Oblong Master Ring Specification, with Specifications

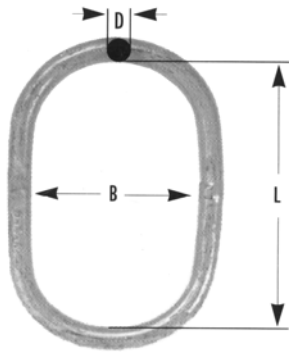

Size ins.	Product Code	WLL (lbs.)	Dimensions (ins.)			Weight
			L	B	D	
3/8	589614	3,300	3.9	2.4	.43	.4
1/2	589615	7,000	4.7	2.8	.55	.9
5/8	589616	11,400	5.5	3.2	.67	1.5
3/4	589617	12,300	5.9	3.5	.75	2.2
7/8	589618	17,200	6.3	3.7	.87	3.3
1	589619	29,900	7.5	4.3	.99	4.8
1-1/4	589620	35,200	7.9	4.7	1.2	7.7
1-3/8	589621	45,300	9.5	5.5	1.3	11.0
1-1/2	589622	68,000	9.9	5.9	1.5	15.0
1-5/8	589623	70,400	9.9	5.9	1.6	18.0
1-3/4	589624	84,900	11.8	7.1	1.8	26.0
2	589625	102,600	11.8	7.9	2.0	33.0
2-1/4	589626	143,100	11.8	7.9	2.2	40.0
2-1/2	589627	160,000	13.8	7.9	2.4	55.0
2-3/4	589628	220,200	15.8	9.9	2.8	88.0
3-1/4	589629	275,300	15.8	9.9	3.2	117.0

Oblong Master Ring with Sub-Assemblies Specifications

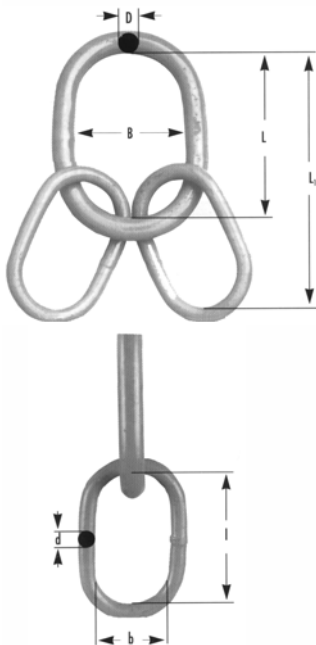

Size ins.	Product Code	WLL (lbs.)	Dimensions (ins.)							Weight
			L1	L	B	D	l	b	d	
3/4	589630	8,816	10.2	5.9	3.5	.75	4.3	2.4	.55	3.1
7/8	589631	14,105	11.8	6.3	3.7	.87	5.5	3.2	.67	6.2
1	589632	14,720	13.4	7.5	4.3	.98	5.9	3.5	.75	7.0
1-1/4	589633	28,211	14.2	7.9	4.7	1.2	6.3	3.7	.87	13.0
1-5/8	589634	52,896	16.9	9.9	5.9	1.6	7.1	4.1	1.1	29.0
2	589635	70,528	19.7	11.8	7.9	2.0	7.9	4.3	1.3	51.0
2-1/4	589636	88,160	22.0	11.8	7.9	2.2	10.2	5.5	1.5	70.0
2-1/2	589637	132,240	24.0	13.8	7.9	2.4	10.2	5.5	1.8	100.0
2-3/4	589638	176,320	26.8	15.8	9.9	2.8	11.0	6.3	2.0	150.0
3-1/4	589639	220,400	26.8	15.8	9.9	3.1	11.0	6.3	2.2	190.0

*Based on Single Leg Sling. Minimum Ultimate Load is 5 Times Working Load Limit. **Welded Master Link

WEB SLING HOOKS & SHACKLES

Web Sling Nom Size	Round Sling Size	Work. Load Limit*	S-252 Bolt Type		S-253 Screw Type		Sling-Saver Shackles Dimensions in Inches														
			S-252	S-252 Weight	A	B	C	D	E	F	G	H	J	K	L	M	N	P	R		
1	1 & 2	3-1/4	1020485	1.4	1020575	1.4	7/8	9/16	1-3/8	3/4	1-1/2	3/8	3-3/8	3-11/16	1-1/16	1-1/2	3/4	2-	3-3/16	3/8	1
1-1/2	3 & 4	6-1/2	1020496	4.1	1020584	3.4	1-1/4	3/4	1-3/4	7/8	1-7/8	1/2	4-1/16	4-1/4	1-1/4	1-3/4	1	3-3/8	4	1/2	1-3/16
2	5 & 6	8-3/4	1020507	6.9	1020593	6.1	1-3/8	11/16	2-1/4	1	2-3/4	9/16	5-1/2	4-11/16	1-1/2	2-1/16	1-1/16	4-3/16	4-1/2	1/2	1-3/8
3	7 & 8	12-1/2	1020518	8.9	1020602	8.3	1-9/16	11/16	3-1/4	1-1/4	3	3/4	6-1/4	5-7/8	1-7/8	2-9/16	1-3/8	5-9/16	5-9/16	9/16	1-3/4
4	9 & 10	20-1/2	1020529	22.3	1020611	18.8	2-1/16	1-1/4	4-1/2	1-1/2	5-3/4	7/8	9-3/4	7-3/16	2-1/4	3-1/16	1-3/4	7-1/2	6-7/8	3/4	2-1/16
5	11 & 12	35	1020540	50.7	1020620	43.5	2-1/2	1-3/4	5-1/2	2	6-1/4	1-1/16	11-1/2	9-1/4	3	4-3/16	2-1/4	9-3/16	8-11/16	1	2-7/8
6	13	50	1020551	86.9	1020629	74.3	3	2-1/16	6-1/2	2-1/4	7-11/16	1-1/4	13-3/4	10-3/8	3-3/8	4-3/4	2-3/4	11	10-3/16	1-3/16	3-3/16

Shackle Body: Carbon Steel, Heat Treated and Tempered.

Shackle Pin: Alloy Steel, Heat Treated and Tempered.

Finish: Hot Dip Galvanized

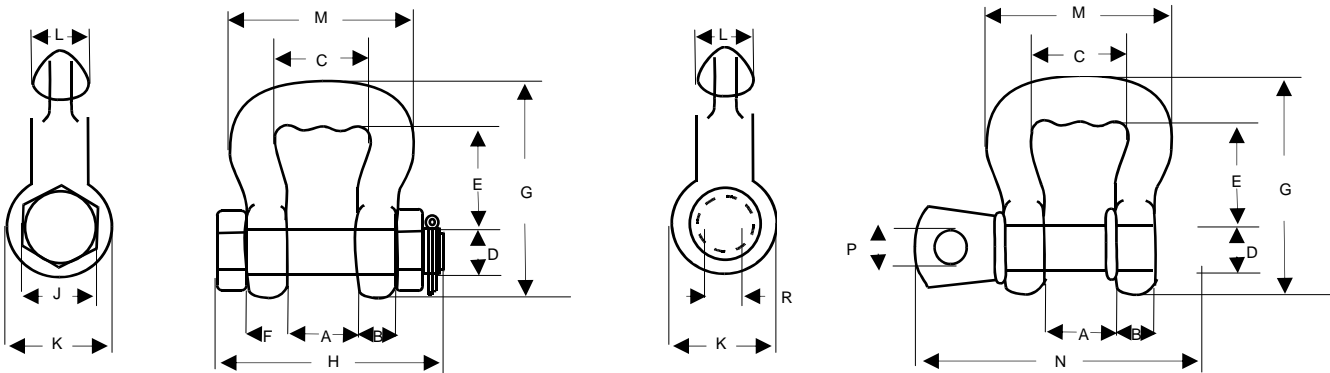

Web Sling Nom. Size (ins.)	Round Sling Size (No.)	Working Load Limit* (tons)	Web Sling Hook Dimensions							Weight Each
			A	B	C	D	F	G	H	
1*	1	1-1/2	5-1/4	2-1/4	4	3-1/16	1-3/8	3/4	7/8	
2*	2	3	7-1/16	3-11/16	5-1/4	4	1-9/16	1-1/16	1-1/4	
3*	3	5	9-1/4	5-1/16	7-1/16	4-3/4	2	1-3/8	1-9/16	
7/8	3/4	1-1/2	9/16	3/4	7/8	2-1/4	1	1	2	1-1/16
1-1/16	1/16	2-1/2	7/8	1-1/16	1-1/16	2-3/4	1-11/16	1-3/16	2	2-7/8
1-1/2	1-1/4	3-3/4	1-1/16	1-9/16	1-1/4	3-1/2	2-9/16	1-1/2	2-1/2	6-9/16

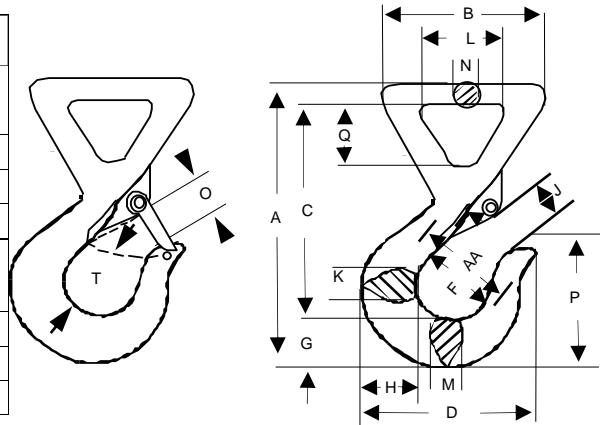

*Note: Proof load is 2-1/2 times Working Load Limit. Average straightening load (ultimate load) is 5 times Working Load Limit.

Web Sling Shackles (Pull-Pin Shackle) - Dimensions									
Web Sling Nom. Size	Working Load limit	Part Weight		A	B	C	E	F	
2	8,050	SS-2	1.2	2	2-5/8	9/16	1-5/8	1/2	
3	13,050	SS-3	2.4	3	3-3/16	3/4	1-7/8	15/16	
4	10,800	SS-4	3.1	4	3-7/16	3/4	1-7/8	1-1/4	
5	18,000	SS-5	4.3	5	4-1/8	13/16	2-1/8	1-7/16	
6	18,000	SS-6	6.8	6	4-7/8	15/16	2-1/8	3-1/4	
6	24,000	SS-6H	9.3	6	5	1-1/8	2-5/8	3-1/4	

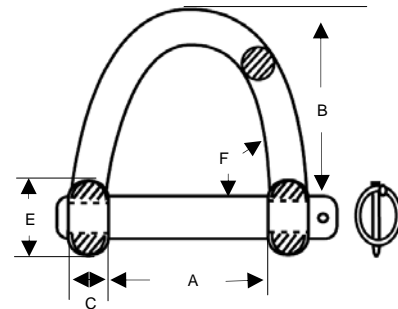

SYNTHETIC WEB RATCHETS

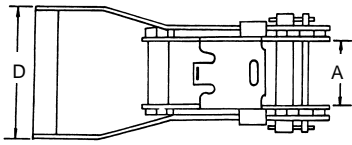

Ratchets

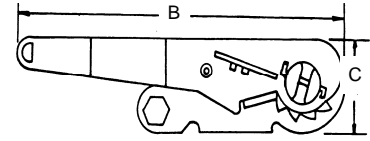

ITEM NO.	TIE DOWN TYPE	A WEB SIZE (IN.)	B LENGTH (IN.)	C HEIGHT (IN.)	D HANDLE WIDTH (IN.)	WORKING LOAD LIMIT (WLL)(IN LBS.)	BREAKING STRENGTH (LBS.)
600-18	4" Ratchet Buckle	4.00	12.88	3.19	5.38	8,000	24,000
600-10	3" Ratchet Buckle	3.00	13.07	3.19	4.13	7,332	22,000
600-03	2" Ratchet Long/Wide Handle	2.00	9.17	2.36	4.09	4,000	12,000
600-08	2" Ratchet Regular/Wide Handle	2.00	7.64	2.36	4.02	4,000	12,000
600-04	1" Ratchet Wide-Handle	1.00	4.72	1.57	2.36	1,000	3,000

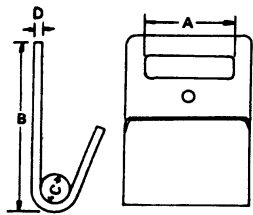

"J" or Flat Hook

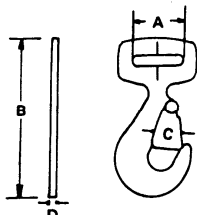

Flat Snap Hook

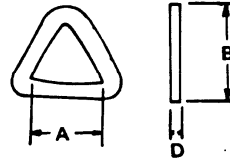

Delta Ring

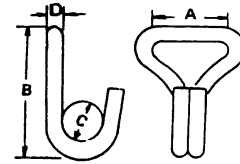

Narrow Hook

ITEM NO.	TIE DOWN TYPE	A WEB SIZE (IN.)	B LENGTH (IN.)	C HEIGHT (IN.)	D HANDLE WIDTH (IN.)	WORKING LOAD LIMIT (WLL)(IN LBS.)	BREAKING STRENGTH (LBS.)
600-13	2" "J" or Flat Hook	2.00	3.82	0.65	0.18	3,332	10,000
600-02	4" "J" or Flat Hook	4.00	3.82	0.65	0.2	5,000	15,000
600-06	2" Flat Snap Hook	2.00	6.02	0.83	0.24	3,332	10,000
600-11	2" Flat Snap Hook	2.00	4.29	0.87	0.18	1,600	5,000
600-07	2" Twisted Snap Hook	2.00	6.02	0.83	0.24	3,666	11,000
600-20	2" Delta Ring	2.00	1.81	-	0.27	1,670	5,000
600-02	4" Delta Ring	4.00	4.33	-	0.6	6,666	
600-19	2" Narrow Hook	2.00	2.29	1.00	0.45	3,332	10,000

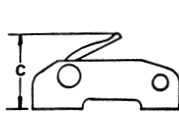

Cam Buckle

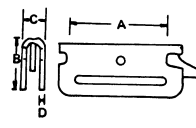
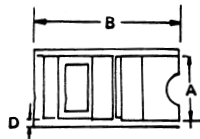

Track Fitting

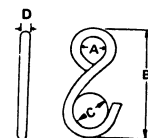

"S" Hook

ITEM NO.	TIE DOWN TYPE	A WEB	B LENGTH	C HEIGHT	D HANDLE	WORKING LOAD LIMIT	BREAKING STRENGTH
600-09	1" Cam Buckle	1.00	2.25	1.26	0.12	500	1,500
645-01	2" Cam Buckle	2.00	2.99	1.18	0.13	1,000	3,000
645-02	2" E Track Fitting	2.00	1.18	0.55	0.12	1,166	3,500
600-05	1" "S" Hook	1.00	4.13	1.00	0.31	666	2,000

SYNTHETIC WEB RATCHET TIE DOWNS



1" Ratchet Strap, Long Handle and S Hooks

Type Number: 470-1-RH-SH
 Strap Length: As Required
 Webbing Breaking Strength: 3,600 lbs.
 Assembly Breaking Strength: 1,200 lbs.
 Working Load Limit: 400 lbs.



2" Ratchet Strap, Long Wide Handle and Chain Anchor

Type Number: 470-2-LH-CHA
 Strap Length: 27 ft.
 Webbing Breaking Strength: 10,000 lbs.
 Assembly Breaking Strength: 9,000 lbs.
 Working Load Limit: 3,000 lbs.



2" Ratchet Strap, Long Wide Handle and Wire Hook

Type Number: 470-2-LH-WH
 Strap Length: As Required
 Webbing Breaking Strength: 10,000 lbs.
 Assembly Breaking Strength: 9,000 lbs.
 Working Load Limit: 3,000 lbs.



2" Ratchet Strap with Long Wide Handle and Flat Hook

Type Number: 470-2-LH-FH
 Strap Length: As Required
 Webbing Breaking Strength: 10,000 lbs.
 Assembly Breaking Strength: 9,000 lbs.
 Working Load Limit: 3,000 lbs.



3" Ratchet Strap with HD Handle and Flat Hook

Type Number: 470-3-HDH-FH
 Strap Length: As Required
 Webbing Breaking Strength: 15,000 lbs.
 Assembly Breaking Strength: 13,000 lbs.
 Working Load Limit: 4,000 lbs.



3" Ratchet Strap with HD Handle and Grab Hook

Type Number: 470-3-HDH-GH
 Strap Length: As Required
 Webbing Breaking Strength: 15,000 lbs.
 Assembly Breaking Strength: 13,000 lbs.
 Working Load Limit: 4,000 lbs.



3" Ratchet Strap with HD Handle and Chain Anchor

Type Number: 470-3-HDH-CHA
 Strap Length: As Required
 Webbing Breaking Strength: 15,000 lbs.
 Assembly Breaking Strength: 13,000 lbs.
 Working Load Limit: 4,000 lbs.



4" Ratchet Strap with HD Handle and Flat Hook

Type Number: 470-4-HDH-FH
 Strap Length: As Required
 Webbing Breaking Strength: 20,000 lbs.
 Assembly Breaking Strength: 18,000 lbs.
 Working Load Limit: 5,000 lbs.



4" Ratchet Strap with HD Handle and V-Ring

Type Number: 470-4-HDH-VR
 Strap Length: As Required
 Webbing Breaking Strength: 20,000 lbs.
 Assembly Breaking Strength: 18,000 lbs.
 Working Load Limit: 5,000 lbs.

SYNTHETIC WEB WINCH STRAPS



2" Webbing with Flat Hook
Type Number: 470-2-WEB-FH
Strap Length: As Required
Webbing Breaking Strength: 10,000 lbs.
Assembly Breaking Strength: 9,000 lbs.
Working Load Limit: 3,000 lbs.

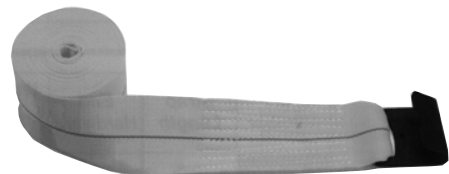

4" Webbing with Flat Hook
Type Number: 470-4-WEB-FH
Strap Length: As Required
Webbing Breaking Strength: 10,000 lbs.
Assembly Breaking Strength: 9,000 lbs.
Working Load Limit: 3,000 lbs.



4" Webbing with Delta Ring
Type Number: 470-4-WEB-DR
Strap Length: As Required
Webbing Breaking Strength: 10,000 lbs.
Assembly Breaking Strength: 9,000 lbs.
Working Load Limit: 3,000 lbs.



4" Webbing with Chain Anchor
Type Number: 470-4-WEB-CHA
Strap Length: As Required
Webbing Breaking Strength: 20,000 lbs.
Assembly Breaking Strength: 18,000 lbs.
Working Load Limit: 5,000 lbs.



4" Webbing with Sewn Eye
Type Number: 470-4-WEB-EYE
Strap Length: As Required
Webbing Breaking Strength: 20,000 lbs.
Assembly Breaking Strength: 18,000 lbs.
Working Load Limit: 5,000 lbs.

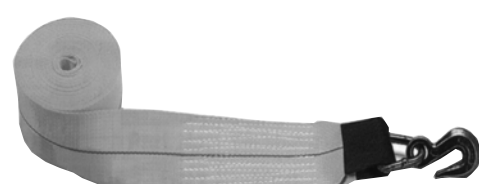

4" Webbing with Grab Hook
Type Number: 470-4-WEB-GH
Strap Length: As Required
Webbing Breaking Strength: 20,000 lbs.
Assembly Breaking Strength: 18,000 lbs.
Working Load Limit: 5,000 lbs.

OPERATING PRACTICES FOR SYNTHETIC WEB TIEDOWNS

Recommended Operating Practices

The purpose of this information is to provide guidelines for the care, use and inspection of synthetic web tiedowns.

Mechanical Considerations:

1. Determine weight of the cargo to be secured, including expected gravity "G" forces.
2. Select tiedown having suitable characteristics for the type of load and environment.
3. Tiedowns shall not be loaded in excess of the Working Load Limit (WLL). Consideration shall be given to the angle from the vertical (cargo tiedown to load angle) which affects working load capacity.
4. Tiedown shall be attached to provide control of the load and positioned in accordance with applicable regulations.
5. Tiedowns shall not be dragged on the floor, ground, or over an abrasive surfaces.
6. Tiedowns shall not be tied in knots, or joined by knotting.
7. Tiedowns shall not be pulled from under loads when the load is resting on the Tiedown.
8. Tiedowns shall always be protected from being cut by sharp corners, sharp edges, protrusions or abrasive surfaces.
9. Tiedowns with metal fittings shall not be dropped.
10. The opening in fittings shall be the proper shape and size to insure that the fitting will seat properly in the anchorage point or other attachments. If the anchor point is inadequate to support the force of the tiedown system, then the load rating of the tiedown will be limited to the strength of the anchor point.
11. Tiedowns shall not be used for lifting

Environmental Considerations:

1. Tiedowns should be stored in a cool, dry, and dark place and should not be exposed to sunlight when not in use.
2. Chemically active environments can affect the strength of synthetic web tiedowns in varying degrees ranging from none to total degradation. The tiedown manufacturer, should be consulted before tiedowns are used in a chemically active environment.

ACIDS

1. Nylon is subject to degradation in acids, ranging from none to total degradation.
2. Polyester is resistant to some acids, but is subject to degradation ranging from little to moderate with other acids.
3. Each application shall be evaluated, taking into consideration the following:
 - a. Type of Acid
 - b. Exposure Conditions
 - c. Concentration
 - d. Temperature

ALKALIS

1. Polyester is subject to degradation by alkalis, ranging from little to total degradation.
2. Nylon is resistant to some alkalis, but is subject to degradation ranging from little to moderate with other alkalis.
3. Each application shall be evaluated, taking into consideration the following:
 - a. Type of alkali
 - b. Exposure conditions
 - c. Concentration
 - d. Temperature
3. Nylon and Polyester webbing shall not be used at temperatures in excess of 194° F (90° C). Both types are routinely used at temperatures as low as -40° F (-40° C).
4. Tiedowns incorporating aluminum fittings shall not be used where fumes, vapors, sprays, mists or liquids of alkalis and/or acids are present.
5. Environments in which synthetic webbing tiedowns are continuously exposed to ultra-violet light can affect the strength of synthetic webbing tiedowns in varying degrees ranging from slight to total degradation.
 - a. Factors which can determine the degree of strength loss are:

- (1) Length of time of continuous exposure
- (2) Webbing construction and design
- (3) Other environmental factors such as weather conditions and geographic location.

- b. Suggested procedures to minimize effects of ultra-violet light.
 - (1) Store webbing tiedowns in a cool, dry and dark place when not being used for prolonged periods of time.
 - (2) Inspect webbing tiedowns weekly or more often, depending on frequency of use.
 - (3) Impregnate a coating into the webbing.
- c. Visual indications of possible ultra-violet degradation are:
 - (1) Bleaching out of webbing.
 - (2) Increased stiffness of webbing material.
 - (3) Surface abrasion in areas not normally in contact with the load.

CAUTION: Degradation can take place without visible indications.

Inspection:

3. Initial Inspection—Before any tiedown is placed in service, it shall be inspected to insure that the correct tiedown is being used as well as to determine that the tiedown meets requirements of this specification.
4. Frequent Inspection—This inspection shall be made by the person handling the tiedown each time it is used.
5. Periodic Inspection—This inspection shall be conducted by designated personnel. Inspection frequency should be based on:
 - a. Frequency of use
 - b. Severity of service conditions
 - c. Experience gained on the service life of tiedowns used in similar applications
 - d. Inspections should be conducted at least monthly

Tiedown Replacement:

Tiedown shall be removed from service if any of the following are visible:

3. Acid or alkali burns.
 4. Melting, charring, or weld spatter of any part of the webbing.
 5. Holes, tears, cuts, snags or embedded particles.
 6. Broken or worn stitching in load bearing stitch patterns.
 7. Excessive abrasive wear.
 8. Knots in any part of the webbing.
 9. Distortion and excessive pitting or corrosion or broken fittings.
- Other apparent defects which cause doubt as to the strength of the tiedown.

Inspection Records:

Tiedown inspection records shall be established by the user.

Repair of Tiedown Webbing:

No repairs of webbing, fittings, or stitching shall be permitted.

Recommended Standard Specification for Synthetic Web Tiedowns, ©1991
Web Sling & Tiedown Association, Inc.
5024-R Campbell Blvd.
Baltimore, MD 21236

NOTE:

LiftPRO, Inc. assumes no responsibility for the misuse or misapplication of any of its products. Products are provided with the express understanding that the purchaser and/or user are thoroughly familiar with the correct application and proper use. Warnings and definitions are provided as an aid to the user in understanding correct application and proper use. These charts are not a substitute for proper training.

SYNTHETIC WEB VEHICLE RECOVERY STRAPS



CAPACITY RATING INFORMATION

There is a great amount of misinformation regarding vehicle recovery straps. Ratings used on the vehicle recovery straps are often misleading, at best.

When an object or a vehicle is stuck or buried in snow, mud, gravel, etc., you do not know exactly how much force it will take to pull the object free unless you put a measuring device between the object and the pulling vehicle to establish the precise force required.

We, at LIFTPRO, INC., feel that a vehicle recovery strap should never be used in an application that exceeds the working load limit (WLL) of the strap. The WLL of vehicle recovery straps is 1/3 (one-third) of the ultimate breaking strength of the strap. If a strap or a vehicle recovery sling is

used near the ultimate breaking strength, several things may occur:

1. Permanent damage can be caused to the strap and if it doesn't break, it can reduce the strength of the strap for the next application, resulting in a break during a future vehicle Recovery task.
2. You may put yourself, or others near the objects in danger if the strap breaks.
3. You may exceed the Anchor Points and cause them damage.

LiftPRO has taken the opportunity to show you two ratings (the actual working load limit, "WLL" next to the breaking strength) as an advisory of how our competitors may rate their straps.

FLAT VEHICLE RECOVERY STRAPS				FLAT VEHICLE RECOVERY STRAPS				FLAT VEHICLE RECOVERY STRAPS			
SIZE	PLY	WORKING LOAD LIMIT (IN LBS.)	BREAKING STRENGTH (IN LBS.)	SIZE	PLY	WORKING LOAD LIMIT (IN LBS.)	BREAKING STRENGTH (IN LBS.)	SIZE	PLY	WORKING LOAD LIMIT (IN LBS.)	BREAKING STRENGTH (IN LBS.)
1"	1 PLY	2,900	8,800	4"	3 PLY	35,100	105,600	8"	5 PLY	116,500	350,000
1"	2 PLY	5,800	17,600	4"	4 PLY	46,800	140,800	8"	6 PLY	139,800	420,000
1"	3 PLY	8,700	26,400	4"	5 PLY	58,500	176,000	10"	1 PLY	29,300	88,000
1"	4 PLY	11,600	35,200	4"	6 PLY	70,200	211,200	10"	2 PLY	58,600	176,000
2"	1 PLY	5,800	17,600	6"	1 PLY	17,500	53,000	10"	3 PLY	87,900	264,000
2"	2 PLY	11,700	35,200	6"	2 PLY	35,000	106,000	10"	4 PLY	117,200	352,000
2"	3 PLY	17,600	52,800	6"	3 PLY	52,500	159,000	10"	5 PLY	146,500	440,000
2"	4 PLY	23,200	70,400	6"	4 PLY	70,000	212,000	10"	6 PLY	175,800	528,000
3"	1 PLY	8,800	26,400	6"	5 PLY	87,500	265,000	12"	1 PLY	35,300	106,000
3"	2 PLY	17,600	52,800	6"	6 PLY	105,000	318,000	12"	2 PLY	70,600	212,000
3"	3 PLY	26,400	79,200	8"	1 PLY	23,300	70,000	12"	3 PLY	105,900	318,000
3"	4 PLY	35,200	105,600	8"	2 PLY	46,600	140,000	12"	4 PLY	141,200	424,000
4"	1 PLY	11,700	35,200	8"	3 PLY	69,900	210,000	12"	5 PLY	176,500	530,000
4"	2 PLY	23,400	70,400	8"	4 PLY	93,200	280,000	12"	6 PLY	211,800	636,000

CUSTOM POLYESTER MARINE SLINGS

Fabricated by LiftPRO, Inc. to Your Specific Needs

Optional Attachments:

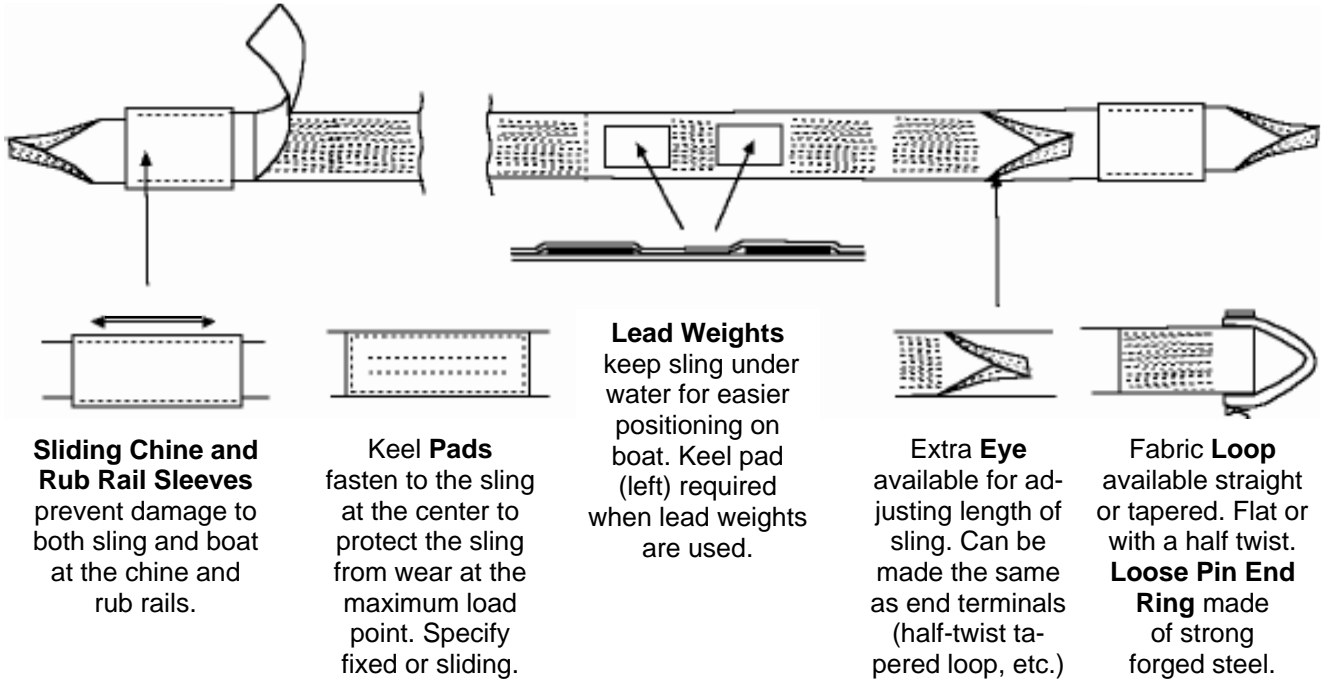

Sliding Chine and Rub Rail Sleeves prevent damage to both sling and boat at the chine and rub rails.

Keel Pads fasten to the sling at the center to protect the sling from wear at the maximum load point. Specify fixed or sliding.

Lead Weights keep sling under water for easier positioning on boat. Keel pad (left) required when lead weights are used.

Extra Eye available for adjusting length of sling. Can be made the same as end terminals (half-twist tapered loop, etc.)

Fabric Loop available straight or tapered. Flat or with a half twist. **Loose Pin End Ring** made of strong forged steel.

POLYESTER MARINE SLING SIZES

Sling Width	Sling Number	Basket Cap. in Lbs.	Fabric Eye Disconnect
3"	MS1-903P	9,300	N/A
4"	MS1-904P	12,400	N/A
6"	MS1-906P	18,600	N/A
8"	MS2-908P	44,000	3 & 2
10"	MS2-910P	31,000	3 & 2
12"	MS1-912P	37,200	3 & 2
12"	MS2-912P	66,000	3 & 2
16"	MS1-916P	44,000	4 & 3
16"	MS2-916P	88,000	4 & 3

WARNING! Do Not Exceed Rated Capacity!

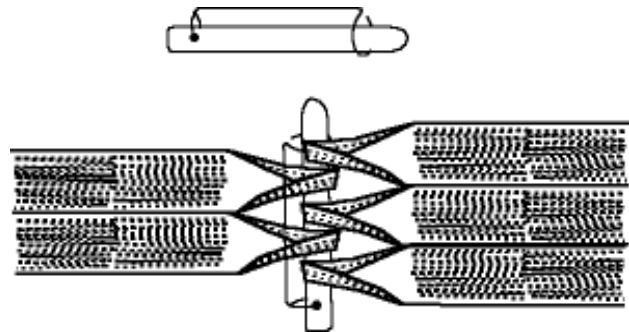

Fabric-Eye Disconnect and Disconnect Pins available for slings 8" wide and larger.

CAUTION: If slings are exposed to continuous Ultra Violet (sun) rays for 24 months, the slings must be discarded.

FAX OR MAIL YOUR ORDER

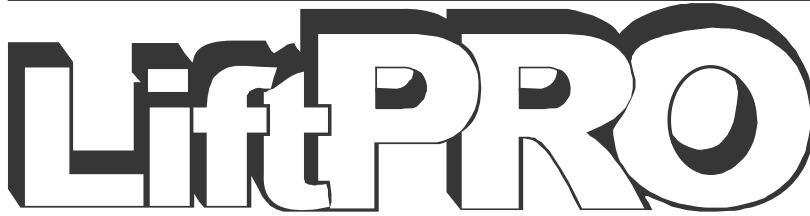

Manufactured By
NESCO, INC.

*Serving you with
Over 20 Years of
Lifting Experience*

BILLING ADDRESS:	SHIPPING ADDRESS (If different than billing address):
Company/Individual:	Company/Individual:
Street Address:	Street Address:
City, State, Zip:	City, State, Zip:

WEB SLINGS

Quantity	Sling Type	Number of Plies		Web Class	Sling Width (Inches)		Sling Length (Feet)
EXAMPLE:	EE	1	-	6	01	x	12
			-			x	
			-			x	
			-			x	

MULTI-LEG BRIDLES

Quantity	Number of Legs	Master Link Type	Attachments		Sling Type	Number of Plies		Web Class	Sling Width (Inches)		Sling Length (Feet)
EXAMPLE:	D	O	S	-	EE	1	-	9	01	x	12
				-			-			x	

OTHER

Quantity	Description



5959 Seville Road
Duluth, MN 55811
(218) 729-9211
FAX: (218) 729-7630
WATTS: (800) 950-3183

**Fax or mail your order
to LiftPRO, Inc.
at either location**

2554 Como Avenue
St. Paul, MN 55108
(651) 644-6901
FAX: (651) 644-3305
WATTS: (800) 568-WIRE



Visit us on the Web at: www.liftpro.com

CUSTOM SLING ORDERING GUIDELINES

Web Slings

WEB SLING ORDERING NUMBERS:

Because the lifting of loads is a vital operation, and because the sling user's needs are frequently unique, virtually all sling orders are custom made. Therefore, it is essential that each order provide the following information to guide manufacturing:

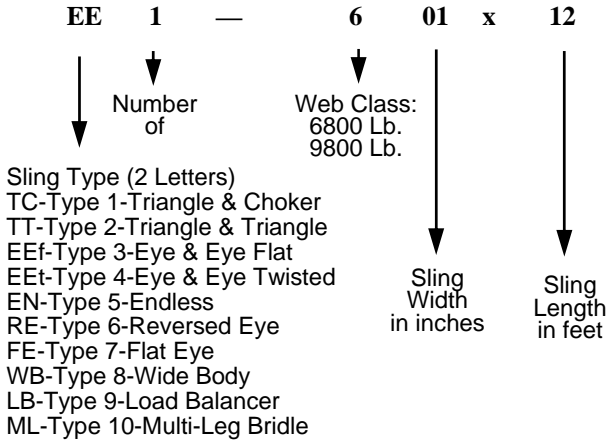

MEASURING WEB SLINGS

LIFTPRO, INC. manufactures slings to a tolerance of + or - 2% for one and two ply slings. Tolerance for three and four ply slings is + or - 4%. Specify matched lengths if required and call LIFTPRO, INC. for special requirements.

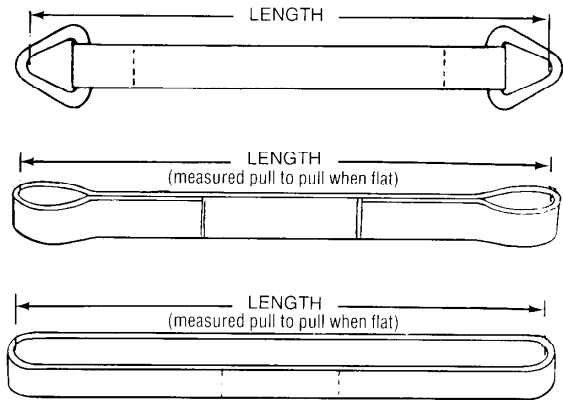

Multi-Leg Bridles (MLB) (see page 22 for capacities)

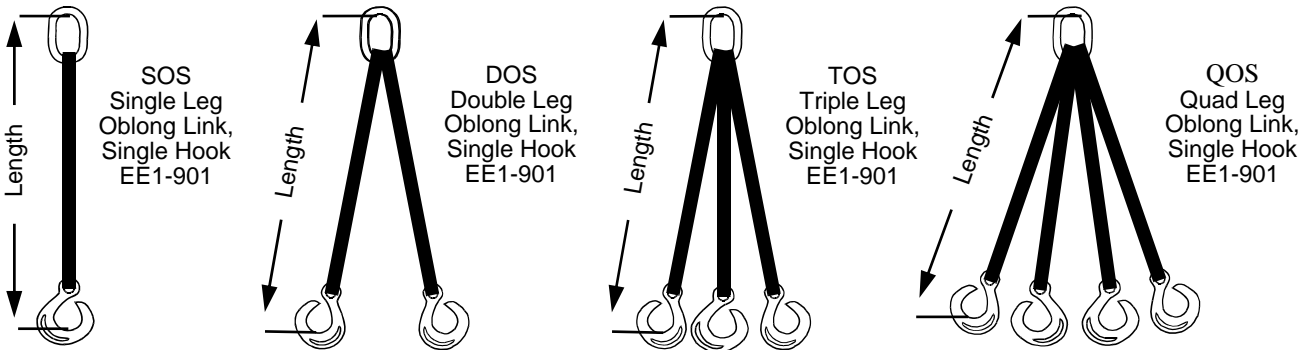

MULTI-LEG BRIDLE ORDERING NUMBERS

Because the lifting of loads is a vital operation, and the sling user's needs are frequently unique, virtually all sling orders are custom made. Therefore, it is essential that each order provide the following information to guide manufacturing:

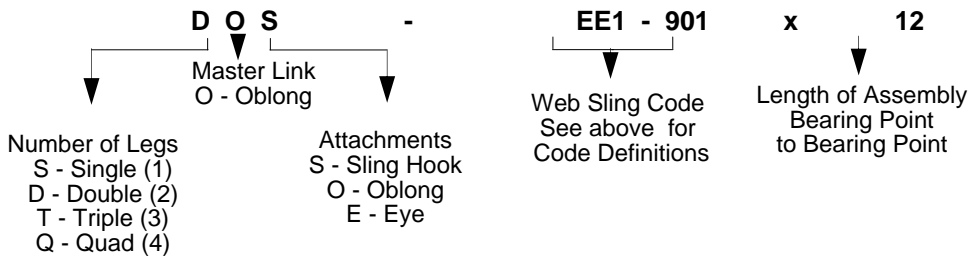

LINK DIMENSIONS

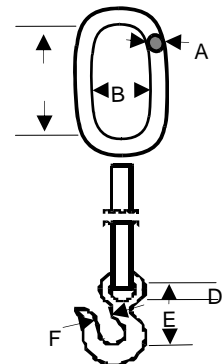

CONTACT LIFTPRO FOR . . .

Sling Inspection Services

OSHA AND ASME B30.9 regulations require inspection of slings at least annually by trained personnel.

LiftPRO, Inc. offers inspection of
your entire inventory of
flat web slings
chain slings
round slings

Gemini Slings, Series I & Series II
and wire rope slings
to assure compliance with standards

Extensive, documented inspections are conducted by knowledgeable LiftPRO, Inc. personnel.

Training Seminars

LiftPRO, Inc. takes an active role in assuring knowledgeable sling implementation by conducting seminars to train new employees or refresh employees on several aspects of sling usage:

- choice of sling
- sling application
- sling inspection
- care & use of sling,
- and sling maintenance

Seminars are provided by knowledgeable LiftPRO, Inc. personnel – nationally recognized lifting and rigging experts.



5959 Seville Road
Duluth, MN 55811
(218) 729-9211
FAX: (218) 729-7630
WATTS: (800) 950-3183

**Fax or mail your order
to LiftPRO, Inc.
at either location**

2554 Como Avenue
St. Paul, MN 55108
(651) 644-6901
FAX: (651) 644-3305
WATTS: (800) 568-WIRE



Visit us on the Web at: www.liftpro.com

