

PERFORMANCE and SPECIFICATION

	MODEL 172	SKYHAWK	FLYER
GROSS WEIGHT	2250 lbs	2250 lbs	2250 lbs
SPEED:			
Top Speed at Sea Level	139 mph	140 mph	104 mph
Cruise,	131 mph	132 mph	102 mph
75% Power at 7000 ft., Landplane			
75% Power at 6500 ft., Floatplane			
RANGE:			
Cruise,	535 mi	540 mi	415 mi
75% Power at 7000 ft., Landplane	4.1 hr	4.1 hr	4.1 hr
75% Power at 6500 ft., Floatplane	131 mph	132 mph	102 mph
39 Gallons, No Reserve			
Optimum Range at 10,000 ft.	780 mi	780 mi	550 mi
39 Gallons, No Reserve	7.8 hr	7.8 hr	8.0 hr
	100 mph	100 mph	69 mph
RATE OF CLIMB AT SEA LEVEL	700 fpm	700 fpm	550 fpm
SERVICE CEILING	14,550 ft	14,550 ft	11,150 ft
TAKE-OFF:			
Take-Off Run	825 ft	825 ft	1020 ft
Total Distance Over 50-ft Obstacle	1430 ft	1430 ft	2390 ft
LANDING:			
Landing Run	690 ft	690 ft	590 ft
Total Distance Over 50-ft Obstacle	1140 ft	1140 ft	1340 ft
EMPTY WEIGHT (Approximate)	1260 lbs	1330 lbs	1410 lbs
BAGGAGE	120 lbs	120 lbs	120 lbs
WING LOADING: Pounds/Sq Foot	12.9 lbs	12.9 lbs	12.8 lbs
POWER LOADING: Pounds/HP	15.5	15.5 lbs	15.3 lbs
FUEL CAPACITY: Total	42 gal.	42 gal.	42 gal.
OIL CAPACITY: Total	8 qts	8 qts	8 qts
PROPELLER: Fixed Pitch, Dia.	76 inches	76 inches	80 inches
POWER:			
Continental Engine	O-300-C	O-300-D	
145 rated HP at 2700 RPM			
O-300-C	Equipped with mechanically engaged starter.		
O-300-D	Equipped with all electric push-button starter, vacuum pump provisions on accessory case.		

Congratulations

Welcome to the ranks of Cessna owners! Your Cessna has been designed and constructed to give you the most in performance, economy, and comfort. You will find flying it, either for business or pleasure, a pleasant and profitable experience.

This Owner's Manual has been prepared as a guide to help you get the most pleasure and utility from your airplane. It contains information about your Cessna's equipment, operating procedures, and performance; and suggestions for its servicing and care. We urge you to read it from cover to cover, and to refer to it frequently.

Our interest in your flying pleasure has not ceased with your purchase of a Cessna. World-wide, the Cessna Dealer Organization backed by the Cessna Service Department stands ready to serve you. The following services are offered only by your Cessna Dealer:

- 1 FACTORY TRAINED MECHANICS to provide you with courteous expert service.
- 2 FACTORY APPROVED SERVICE EQUIPMENT to provide you with the most efficient and accurate workmanship possible.
- 3 A STOCK OF GENUINE CESSNA SERVICE PARTS on hand when you need them.
- 4 THE LATEST AUTHORITATIVE INFORMATION FOR SERVICING CESSNA AIRPLANES, since Cessna Dealers have all of the Service Manuals and Parts Catalogs, kept current by Service Letters and Service News Letters published by Cessna Aircraft Company.

We urge all Cessna owners to use the Cessna Dealer Organization to the fullest.

A current Cessna Dealer Directory accompanies your new airplane. The Directory is revised frequently, and a current copy can be obtained from your Cessna Dealer. Make your Directory one of your cross-country flight planning aids; a warm welcome awaits you at every Cessna Dealer.

TABLE OF CONTENTS

	Page
SECTION I – DESCRIPTION	1-1
SECTION II – OPERATING CHECK LIST	2-1
SECTION III – OPERATING DETAILS	3-1
SECTION IV – OPERATING LIMITATIONS	4-1
SECTION V – CARE OF THE AIRPLANE	5-1
DEALER FOLLOW-UP SYSTEM	5-6
SECTION VI – OPERATIONAL DATA	6-1
SECTION VII – OPTIONAL SYSTEMS	7-1
FLOATPLANE	7-1
AUXILIARY FUEL TANK SYSTEM ...	7-12
ALPHABETICAL INDEX	Index-1

This manual describes the operation and performance of both the Cessna Model 172 and the Cessna Skyhawk. Equipment described as "Optional" denotes that the subject equipment is optional on the Model 172. Much of this equipment is standard on the Skyhawk model.

* If optional rotating beacon is installed on vertical fin, add 2-1/2" to maximum height of airplane. With the nose gear depressed and a rotating beacon installed, this dimension is 8'-11".

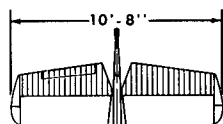
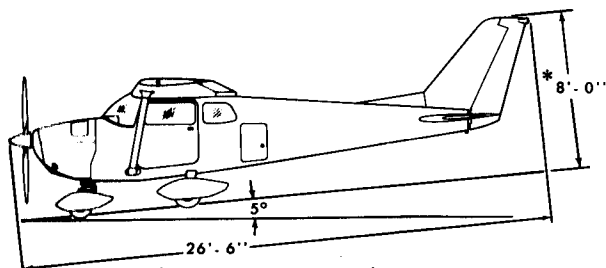

PRINCIPAL DIMENSIONS

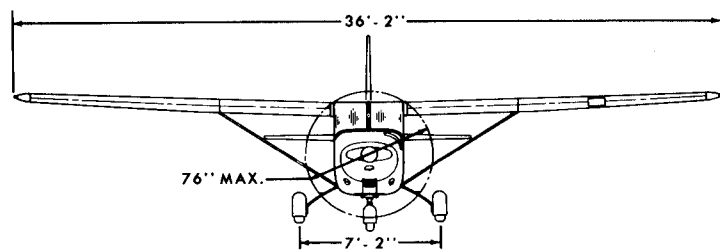
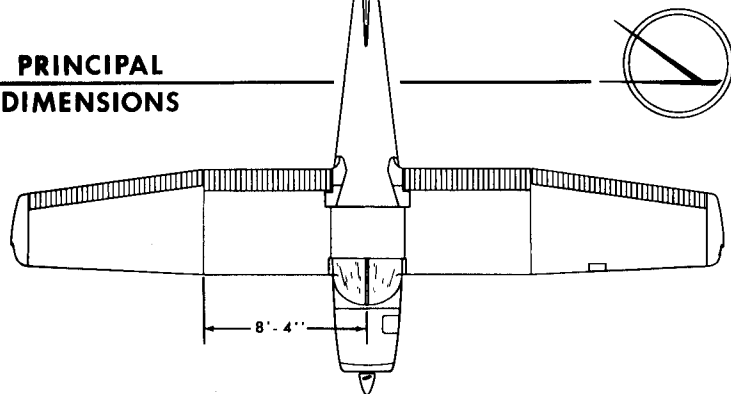

Section 1



description



One of the first steps in obtaining the utmost performance, service, and flying enjoyment from your Cessna is to familiarize yourself with your airplane's equipment, systems, and controls. This can best be done by reviewing this equipment while sitting in the airplane. Those items whose function and operation are not obvious are covered herein.

ENGINE CONTROLS.

THROTTLE.

The throttle, largest of the engine controls, is a push-pull type control. Engine speed is increased by pushing the throttle in or decreased by pulling it out.

NOTE

To prevent the throttle from creeping, tighten the knurled friction-type locknut on the control. Turning the nut clockwise increases friction on the throttle; turning it counterclockwise decreases friction.

MIXTURE CONTROL KNOB.

The mixture control incorporates a locking lever to prevent inadvertent pulling out of the knob, resulting in leaning or shutting off the fuel supply in the carburetor. To lean the mixture, depress the locking lever while pulling out on the mixture control knob. This operation can be accom-

plished with one hand, using the thumb to depress the locking lever and two fingers to pull out the control. The locking lever is intended only to prevent inadvertent leaning; the control knob may be pushed in, for rich mixture, without depressing the lever.

CARBURETOR AIR HEAT KNOB.

The carburetor air heat knob proportions the hot and cold air entering the carburetor. Pulling the knob out provides heated air for the carburetor, while pushing it in decreases the temperature. The full-hot position is all the way out and full cold is all the way in.

STARTER HANDLE.

Pulling out on the "T" shaped starter handle engages the engine starter. It is spring-loaded to return to the disengaged position.

NOTE

Do not pull out on starter handle

when the propeller is turning. Engaging the starter with the engine rotating may damage the starter drive.

IGNITION-STARTER SWITCH.

On the Skyhawk, a key-operated switch controls the magneto ignition system and functions as a starter switch when turned full clockwise and pushed in. The switch has five positions; the four positions for ignition are labeled clockwise "OFF", "R", "L" and "BOTH." The fifth position, for starting, is labeled "START PUSH." The switch is spring loaded in this fifth position; when the key is released, the switch will return to "BOTH."

FUEL SYSTEM.

Fuel is supplied to the engine from two 21-gallon aluminum tanks, one located in each wing. From these tanks fuel flows by means of gravity through a fuel selector valve and

fuel strainer to the engine carburetor.

Refer to figure 1-1 for fuel quantity data. See the Servicing Diagram (figure 5-1) for a summary of fuel system servicing information.

FUEL SELECTOR VALVE.

A rotary type fuel selector valve is located at the aft end of the cabin floor tunnel between the front seats. The valve has four positions which are labeled "BOTH OFF," "LEFT TANK," "RIGHT TANK," and "BOTH ON." The "BOTH OFF" position seals both wing tanks off from the rest of the fuel system and allows no fuel to pass beyond the selector valve. The "LEFT TANK" position allows fuel to flow from the left wing tank to the engine. The "RIGHT TANK" position permits fuel to flow from the right wing tank to the engine. The "BOTH ON" position provides fuel flow from both tanks simultaneously to provide maximum safety.

FUEL QUANTITY DATA (U.S. GALLONS)					
TANKS	NO.	USABLE FUEL ALL FLIGHT CONDITIONS	ADDITIONAL USABLE FUEL (LEVEL FLIGHT)	UNUSABLE FUEL (LEVEL FLIGHT)	TOTAL FUEL VOLUME EACH
LEFT WING	1	19.5 gal.	1.0 gal.	0.5 gal.	21.0 gal.
RIGHT WING	1	19.5 gal.	1.0 gal.	0.5 gal.	21.0 gal.

Figure 1-1.

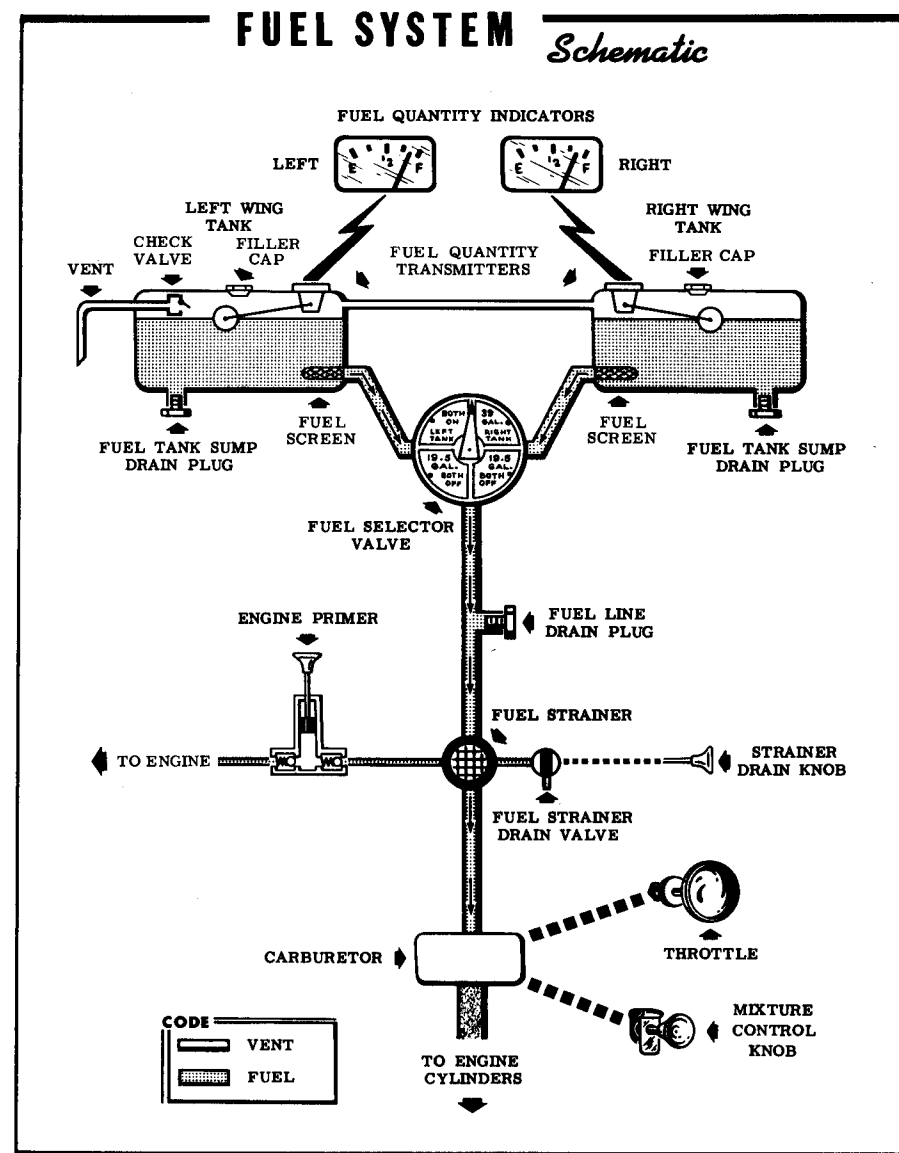
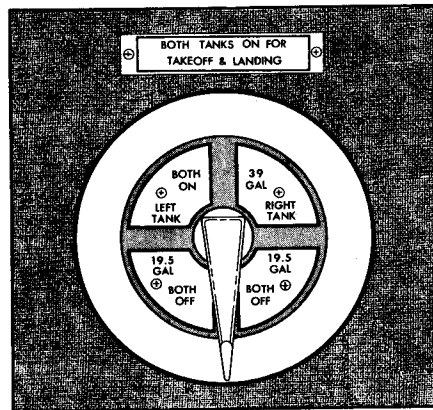

Figure 1-2.



NOTE

The fuel selector valve handle indicates the setting of the valve by its position above the valve dial. (The illustration above shows the valve in the "BOTH OFF" position.)

FUEL QUANTITY INDICATORS.

Two electrically-operated magnetic type fuel quantity indicators are provided, each working in conjunction with an electric fuel level transmitter in its respective fuel tank. Turned on by the master switch the indicators continue to function until the master switch is turned off.

FUEL STRAINER DRAIN KNOB.

The fuel strainer drain knob opens a valve on the bottom of the fuel strainer, to drain off any water and sediment that may have collected. The drain valve is spring-loaded; when the knob is pulled, the valve

opens, and when the knob is released, the valve closes.

Before the first flight each day, and after each refueling, about two ounces of fuel (three or four seconds of drain operation) should be drained from the strainer.

ELECTRICAL SYSTEM.

Electrical power is supplied by a 12-volt, direct-current system powered by an engine-driven generator. A 12-volt storage battery serves as a stand-by power source, supplying current to the system when the generator is inoperative, or when the generator voltage is insufficient to close the reverse-current relay.

FUSES.

Fuses protect the majority of electrical circuits in the airplane. The circuits controlled by each fuse are indicated above each fuse retainer. Fuse capacity is indicated on each fuse retainer cap. Fuses are removed by pressing the fuse retainers inward and rotating them counter-clockwise until they disengage. The faulty fuse may then be lifted out and replaced. Spare fuses are held in a clip on the inside of the map compartment door.

The stall warning and optional turn-and-bank indicator circuits are protected by an automatically resetting circuit breaker which provides intermittent emergency operation of these devices in case of a faulty circuit. The optional rotating beacon system and optional pitot and stall warning heater systems are pro-

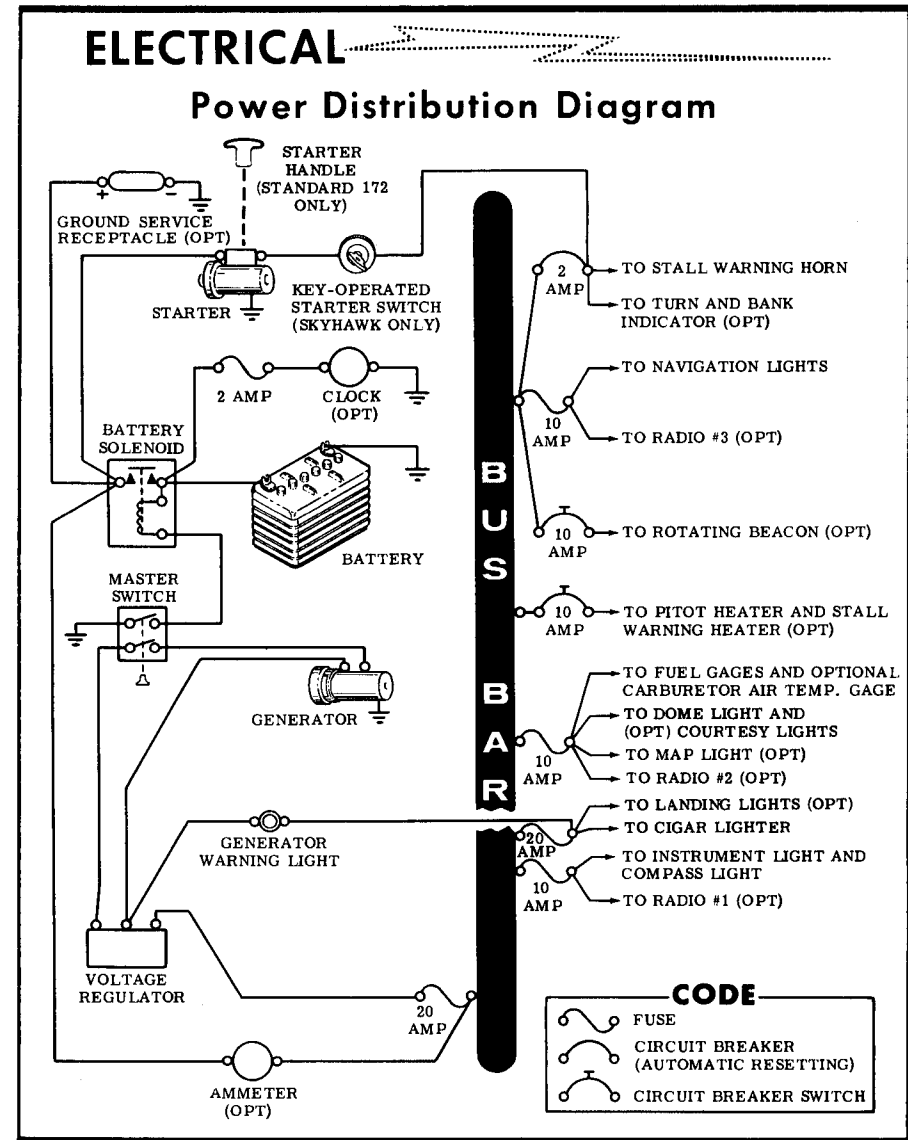

Figure 1-3.

ected by separate circuit breaker switches. The optional clock is protected by a separate fuse mounted near the battery.

GENERATOR WARNING LIGHT.

The red generator warning light indicates generator output. The light remains off as long as the generator functions properly. If a malfunction interrupts generator output, the light will illuminate. It also will illuminate when the battery or external power is on, before starting the engine, and whenever engine speed is insufficient to produce generator output. The light does not show battery drain.

STALL WARNING INDICATOR.

The stall warning indicator is an electric horn, controlled by a transmitter unit in the leading edge of the left wing. This system is in operation whenever the master switch is turned on. The transmitter responds to changes in the airflow over the leading edge of the wing as a stall is approached. In straight-ahead and turning flight, the warning will come 5 to 10 MPH ahead of the stall.

Under safe flight conditions, the only time you may hear the warning horn will be a short beep as you land.

LANDING LIGHTS.

A three-position, push-pull switch controls the optional landing lights. To turn one lamp on for taxiing, pull the switch out to the first stop. To

turn both lamps on for landing, pull the switch out to the second stop.

BRAKE SYSTEM.

The hydraulic brakes on the main wheels are conventionally operated by applying toe pressure to either the pilot's or copilot's rudder pedals. To set the parking brake, apply toe pressure to the pedals, pull out on the parking brake knob, then release toe pressure. To release the parking brake, push the knob in, then apply and release toe pressure.

CABIN HEATING AND VENTILATION SYSTEM.

Fresh air for heating and ventilating the cabin is supplied by a system composed of two manifold type heaters, a cabin air blending valve, carburetor air mixing valve, and four cabin air outlets. The system is controlled by two push-pull control knobs on the instrument panel labeled "CABIN HT" and "CABIN AIR." Both manifold heaters provide a continuous supply of heated air for the cabin, except when carburetor heat is required; then cabin heat is supplied by the right manifold only. Heated air from the left manifold is used for carburetor heat when the carburetor air knob on the instrument panel is pulled aft.

The "CABIN HT" knob controls cabin air temperature. With the knob pulled full aft, hot air flows into the cabin. Pushing the knob forward allows blending from hot to cold as required. With the knob full forward, hot air from the manifolds is

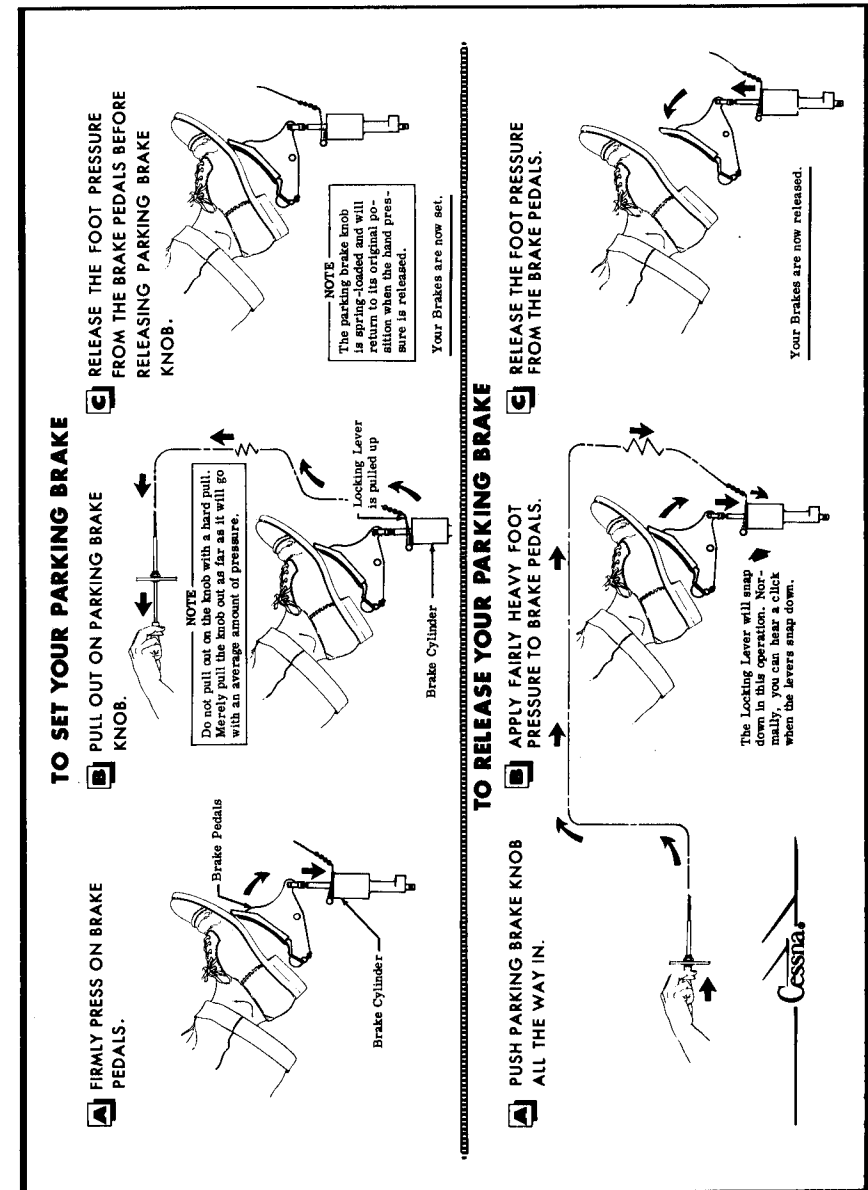

Figure 1-4.

Description

bypassed out of the cabin air blending valve into the engine compartment to prevent possible overheating of the manifolds and system ducting. Simultaneously, cold air is ducted into the cabin.

The "CABIN AIR" knob controls a sliding firewall shut-off valve to stop all flow of air into the cabin. To stop the flow of air pull the knob full aft.

NOTE

The "CABIN AIR" knob must not be pulled aft while the "CABIN HT" knob is aft, as the bypass on the blending valve is closed when

cabin heat is on, and overheating of ducts can result.

VENTILATORS.

Two ventilators, one in each upper corner of the windshield, are provided to supply additional ventilating air. To operate, pull the ventilator out and rotate to the desired position.

Two additional ball and socket ventilators are available as optional equipment for installation just forward of each rear door post in the ceiling, for rear seat passengers. To regulate the air, turn the knurled ring on the rim of the ventilator.

Description

INTERNAL CABIN DIMENSIONS

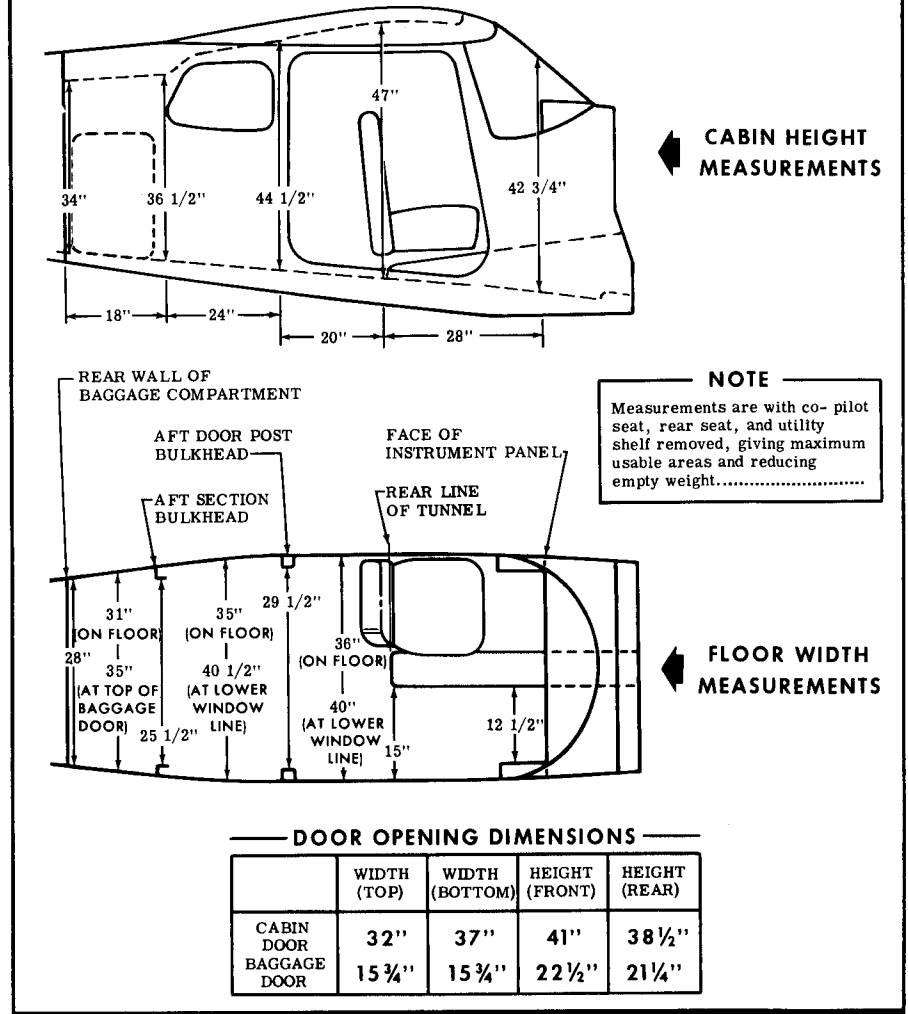

Figure 1-5.

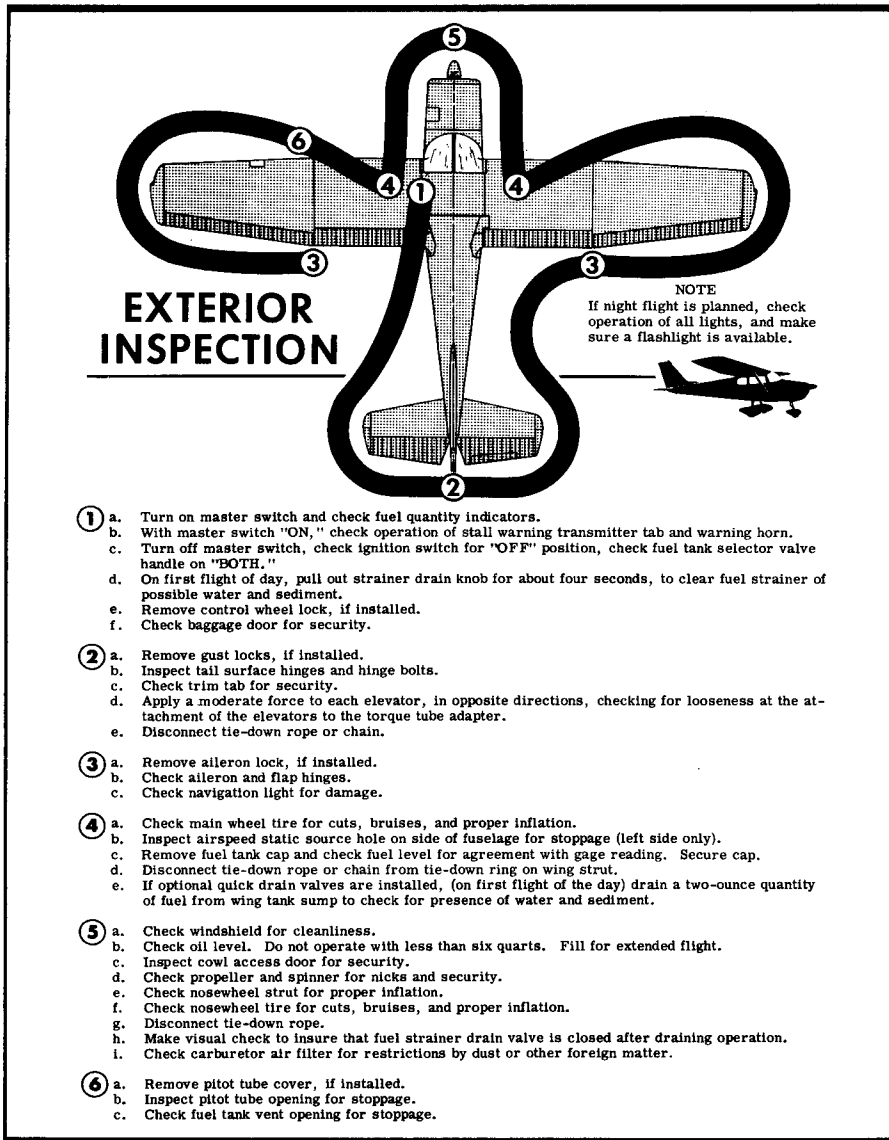

Figure 2-1.



This section lists, in Pilot's Check List form, the steps necessary to operate your airplane efficiently and safely. It is not a check list in its true form as it is considerably longer, but it does cover briefly all of the points that you would want to or should know concerning the information you need for a typical flight.

The flight and operational characteristics of the airplane are normal in all respects. There are no "unconventional" characteristics or operations that need to be mastered. All controls respond in the normal way within the entire range of operation of the airplane. All airspeeds mentioned in Sections II and III are indicated airspeeds. Corresponding true indicated airspeeds may be obtained from the Airspeed Correction Table in Section VI.

BEFORE ENTERING THE AIRPLANE.

- (1) Make an exterior inspection in accordance with Figure 2-1.

BEFORE STARTING THE ENGINE.

- (1) Seats and Seat Belts - Adjust and lock.
- (2) Flight Controls - Check.
- (3) Brakes - Test and set.
- (4) Master Switch - "ON."
- (5) Trim Tab - Set.
- (6) Fuel Selector - "BOTH ON."

STARTING ENGINE.

- (1) Carburetor Heat - Cold.
- (2) Mixture - Rich.
- (3) Primer - As required.
- (4) Ignition Switch - "BOTH."
- (5) Throttle - Open 1/8" (to idle position).
- (6) Propeller Area - Clear
- (7) Starter - Engage.

BEFORE TAKE-OFF.

- (1) Throttle Setting - 1600 RPM.
- (2) Engine Instruments - Within green arc.
- (3) Magnetos - Check (100 RPM maximum drop).
- (4) Carburetor Heat - Check and "ON."
- (5) Flight Controls and Seat Latching - Recheck.
- (6) Wing Flaps - 0° or 10°.
- (7) Trim Tab - "TAKE-OFF."
- (8) Cabin Doors - Closed and locked.
- (9) Flight Instruments and Radios - Set.

TAKE-OFF.**NORMAL TAKE-OFF.**

- (1) Flaps - Up.
- (2) Carburetor Heat - Cold.
- (3) Power - Full throttle.
- (4) Elevator Control - Lift nosewheel at 60 MPH.
- (5) Climb Speed - 80 MPH.

MAXIMUM PERFORMANCE TAKE-OFF.

- (1) Flaps - Up.
- (2) Carburetor Heat - Cold.
- (3) Brakes - Apply.
- (4) Power - Full throttle.
- (5) Brakes - Release.
- (6) Elevator Control - Slightly tail low.
- (7) Climb Speed - 60 MPH.

CLIMB.**NORMAL CLIMB.**

- (1) Airspeed - 80 to 90 MPH.
- (2) Power - Full throttle.
- (3) Mixture - Full rich (unless engine is rough).

MAXIMUM PERFORMANCE CLIMB.

- (1) Airspeed - 78 MPH at sea level to 76 MPH at 10,000 ft.
- (2) Power - Full throttle.

- (3) Mixture - Full rich (unless engine is rough).

CRUISING.

- (1) Engine Speed - 2100 to 2650 RPM.
- (2) Trim Tab - Adjust.
- (3) Mixture - Lean.

LET-DOWN.

- (1) Mixture - Rich.
- (2) Power - As desired.

BEFORE LANDING.

- (1) Fuel Selector - "BOTH ON."
- (2) Mixture - Rich.
- (3) Airspeed - 70 to 80 MPH (flaps up).
- (4) Carburetor Heat - Apply before closing throttle.
- (5) Flaps - As desired (below 100 MPH).
- (6) Airspeed - 65 to 75 MPH (flaps down).
- (7) Trim Tab - Adjust.

NORMAL LANDING.

- (1) Touchdown - Main wheels first.
- (2) Landing Roll - Lower nosewheel gently.
- (3) Braking - Minimum required.

AFTER LANDING.

- (1) Flaps - Up.
- (2) Brakes - Set (at parking area).
- (3) Mixture - Full lean.
- (4) Ignition Switch - "OFF."
- (5) Master Switch - "OFF."

Notes

 section 3

operating details

The following paragraphs cover in somewhat greater detail the items entered as a Check List in Section II. Not every item in the list is discussed here. Only those items on the Check List that require further explanation will be found in this section.

PRE-FLIGHT CHECK.

The exterior inspection described in Section II is recommended for the first flight of the day. Inspection procedures for subsequent flights normally are limited to brief checks of the tail surface hinges, fuel and oil quantity, and security of fuel and oil filler caps. If the airplane has been subjected to long-term storage, recent major maintenance, or operation from marginal airports, a more extensive exterior inspection is recommended.

After major maintenance has been performed, the flight and trim tab controls should be double-checked, for free and correct movement.

The security of all inspection plates on the airplane should be checked following periodic inspections. If the airplane has been waxed and polished it is a good practice to check the external static pressure source hole for stoppage.

If the airplane has been exposed to much ground handling in a crowded hangar, it should be checked for dents and scratches on wings, fuselage, and tail surfaces, as well as

damage to navigation and landing lights, and radio antennas. Outside storage for long periods may result in water and obstructions in the airspeed system lines, condensation in fuel tanks, and dust and dirt on the intake air filters and engine cooling fins.

Operation from a gravel or cinder field will require extra attention to propeller tips and abrasion on leading edges of the horizontal tail.

Airplanes that are operated from rough fields, especially at high altitudes are subjected to abnormal landing gear abuse. A frequent check of all components of the landing gear shock strut, tires, and brakes is important.

If night flying is anticipated, all exterior and interior lights should be checked for proper illumination. Cold weather flights involve a careful check of other specific areas that will be discussed in a separate paragraph.

STARTING ENGINE.

Ordinarily the engine starts easily with one or two strokes of primer

TAXIING DIAGRAM

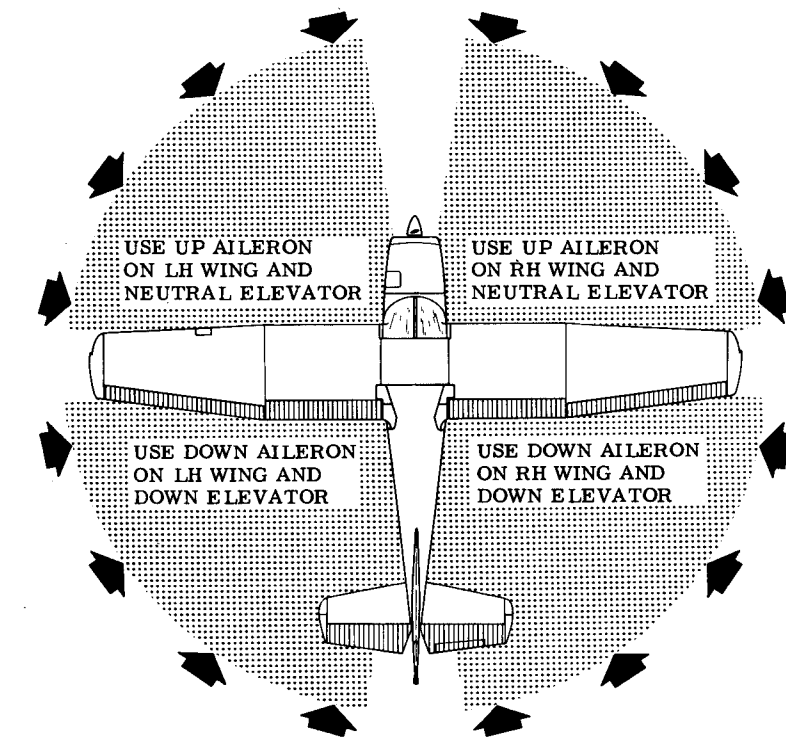

NOTE

Strong quartering tail winds require caution. Avoid sudden bursts of the throttle and sharp braking when the airplane is in this attitude. Use the steerable nose wheel and rudder to maintain direction.

WIND DIRECTION

in warm temperatures to six strokes in cold weather, with the throttle open approximately 1/8 inch. In extremely cold temperatures, it may be necessary to continue priming while cranking. Weak intermittent explosions followed by puffs of black smoke from the exhaust stack indicates overpriming or flooding. Excess fuel can be cleaned from the combustion chambers by the following procedure: Set the mixture control in full lean position, throttle full open, ignition switch "OFF," and crank the engine through several revolutions with the starter. Repeat the starting procedure without any additional priming. If the engine is underprimed (most likely in cold weather with a cold engine) it will not fire at all, and additional priming will be necessary. As soon as the cylinders begin to fire, open the throttle slightly to keep it running. After starting, if the oil gage does not begin to show pressure within 30 seconds in the summertime and about twice that long in very cold weather, stop engine and investigate. Lack of oil pressure can cause serious engine damage. After starting, avoid the use of carburetor heat unless icing conditions prevail.

TAXIING.

Release the parking brake before taxiing and use the minimum amount of power necessary to start the airplane moving. During taxi, and especially when taxiing downwind, the RPM should be held down to prevent excessive taxi speeds. Taxiing should be done at a speed slow enough

to make the use of brakes almost entirely unnecessary. Using the brakes as sparingly as possible will prevent undue wear and strain on the tires, brakes, and landing gear. Normal steering is accomplished by applying pressure to the rudder pedal in the direction the airplane is to be turned. For smaller radius turns, at slow speed, the brakes may be used on the inside wheel. At slow taxi speed, this airplane may be pivoted about the outboard strut fitting without sliding the tires. When taxiing in crosswinds it is important that speed and use of brakes be held to a minimum and that all controls be utilized (see taxiing diagram on page 3-2) to maintain directional control and balance.

NOTE

Caution should be used when taxiing over rough fields to avoid excessive loads on the nosewheel. Rough use of brakes and power also add to nosewheel load. A good rule of thumb: "Use minimum speed, power, and brakes."

Taxiing over loose gravel or cinders should be done at low engine speed to avoid abrasion and stone damage to the propeller tips. Full throttle runups over loose gravel are especially harmful to propeller tips. When take-offs must be made over a gravel surface, it is very important that the throttle be advanced slowly. This allows the airplane to start rolling before high RPM is developed, and the gravel will be blown back of the propeller rather than pulled into

it. When unavoidable small dents appear in the propeller blade, they should be immediately corrected as described in Section V under propeller care.

BEFORE TAKE-OFF.

Most of the warm up will have been conducted during taxi, and additional warm up before take-off should be restricted to the checks outlined in Section II. Since the engine is closely cowed for efficient in-flight cooling, precautions should be taken to avoid overheating on the ground. Full throttle checks on the ground are not recommended unless the pilot has good reason to suspect that the engine is not turning up properly. If a full throttle run-up is necessary the engine should run smoothly and turn 2230 to 2330 RPM with carburetor heat off. Engine run-ups should not be performed over loose gravel or cinders because of possible stone damage or abrasion to the propeller tips.

If the ignition system produces an engine speed drop greater than 100 RPM, the warm up should be continued a minute or two longer prior to rechecking the system. If there is doubt concerning the operation of the ignition system, checks at higher engine speed may confirm the deficiency. In general, a drop in excess of 100 RPM with a warm engine at 1600 RPM should be considered excessive. If the engine accelerates smoothly and the oil pressure remains steady at some value between 30 to 60 lbs/sq. in. the engine is warm enough for take-off.

The engine should be checked for smooth idling at approximately 500 RPM, although prolonged idling is done above 600 RPM for better engine lubrication.

If instrument or night flights are contemplated, a careful check should be made of vacuum pump operation. A suction of 4.5 inches of mercury is desirable for gyro instruments. However, a range of 3.75 to 5.0 inches of mercury is considered acceptable. The condition of the generator is also important since satisfactory operation of all radio equipment and electrical instruments is essential to instrument flight. The generator is checked by noting that the warning light is out with engine speed above 1000 RPM.

A simple last-minute recheck of important items should include a glance to see that the mixture and carburetor heat knobs are full in, all flight controls have free and correct movement, and the fuel selector is set to "BOTH ON."

TAKE-OFF.

Since the use of full throttle is not recommended in the static run-up, it is important to check full-throttle engine operation early in the take-off run. Any signs of rough engine operation or sluggish engine acceleration is good cause for discontinuing the take-off. If this occurs, you are justified in making a thorough full-throttle static run-up before another take-off is attempted.

Normal and obstacle clearance take-offs are performed with flaps up. The use of 10° flaps will shorten

the ground run approximately 10%, but this advantage is lost in the climb to a 50-foot obstacle. Therefore the use of 10° flap is reserved for minimum ground runs or for take-off from soft or rough fields with no obstacles ahead.

If 10° of flaps are used in ground runs, it is preferable to leave them extended rather than retract them in the climb to the obstacle. The exception to this rule would be in a high altitude take-off in hot weather where climb would be marginal with flaps 10° (1st notch).

Flap deflections of 30° (3rd notch) and 40° (4th notch) are not recommended at any time for take-off. General rules for flap operation during take-off are as follows:

DON'T, under marginal conditions, leave flaps down so long that you are losing both climb and airspeed. DON'T release flaps with airspeed below flaps up stalling speed (See Stalling Speed Table in Section VI). DO slowly release the flaps as soon as you reasonably can after take-off, preferably 50 feet or more over terrain obstacles.

Consult the take-off chart (figure 6-2) for take-off distances under various gross weight, altitude, and headwind conditions.

Take-offs into strong crosswinds normally are performed with the minimum flap setting necessary for the field length, to minimize the drift angle immediately after take-off. The airplane is accelerated to a speed slightly higher than normal,

then pulled off abruptly to prevent possible settling back to the runway while drifting. When clear of the ground, make a coordinated turn into the wind to correct for drift.

CLIMB.

For detailed data, see the Climb Performance Chart in Section VI. Normal climbs are conducted at 80 to 90 MPH with flaps up and full throttle for best engine cooling. The mixture should be full rich unless the engine is rough due to too rich a mixture. The best rate-of-climb speeds range from 78 MPH at sea level to 76 MPH at 10,000 feet. If an obstruction dictates the use of a steep climb angle, the best angle-of-climb speed should be used with flaps up and full throttle. These speeds vary from 56 MPH at sea level to 67 MPH at 10,000 feet.

NOTE

Steep climbs at these low speeds should be of short duration because of poor engine cooling.

CRUISE.

Normal cruising is done at 65% to 75% power. Cruising power of approximately 75% is obtained with 2450 RPM at sea level, 2550 RPM at 5000 feet, and 2650 RPM at 10,000 feet. These RPM's require progressively higher throttle openings as altitude is increased until, at 7000 feet, full throttle is reached and results in 75% power.

Cruising can be done most efficiently at high altitudes because of lower air density and therefore lower airplane drag. This is illustrated in the following table for 70% power at various altitudes.

Altitude	RPM	True Airspeed
Sea Level	2410	121
5000 feet	2530	126
8000 feet	Full Throttle	130

For detailed cruise performance, refer to the Cruise Performance Chart in Section VI. It should be noted that greater range can be obtained at lower power settings. Therefore if a destination is slightly out of reach in one flight at normal cruise speed it may save time and money to make the trip non-stop at a lower speed. Range and endurance figures in Section VI are given for lean mixture from 2500 feet to 12,500 feet and for rich mixture at 2500 feet and 5000 feet. All figures, are based on zero wind, 39 gallons of fuel for cruise, McCauley 1C172/EM7653 propeller, 2250 pounds gross weight and standard atmospheric conditions. At any altitude, the mixture should be leaned by pulling the knob out until maximum RPM is obtained with fixed throttle and then the control is pushed in toward "full rich" until RPM starts to decrease. The mixture should be readjusted for each change in power, altitude, or carburetor heat.

Allowances for fuel reserve, headwinds, take-off and climb, and varia-

tions in mixture leaning technique should be made and are in addition to those shown on the charts. Other indeterminate variables such as carburetor metering characteristics, engine and propeller condition, and turbulence of the atmosphere may account for variations of 10% or more in maximum range.

STALLS.

The stalling speeds are shown in Section VI for forward c.g., normal category, full gross weight conditions. They are presented as true indicated airspeed because indicated airspeeds are inaccurate near the stall. Other loadings result in slower stalling speeds. The horn stall warning indicator produces a steady signal 5 to 10 MPH before the actual stall is reached and remains on until the airplane flight attitude is changed. Fast landings will not produce a signal.

The stall characteristics are conventional for the flaps up and flaps down condition. Slight elevator buffeting may occur just before the stall with flaps down.

LANDING.

Normal landings are made power off with any flap setting. Slips are prohibited in full flap approaches because of a downward pitch encountered under certain combinations of airspeed and sideslip angle.

Approach glides are normally made at 70 to 80 MPH with flaps up, or 65 to 75 with flaps down, depending upon the turbulence of the air.

Landings are usually made on the main landing wheels to reduce the landing speed and the subsequent need for braking in the landing roll. The nosewheel is lowered gently to the runway after the speed is diminished to avoid unnecessary nose gear strain. This procedure is especially important in rough field landings.

Excessive braking in the landing roll is not recommended because of the probability of skidding the main wheels with the resulting loss of braking effectiveness and damage to the tires.

For a short field landing, make a power off approach at 60 MPH with flaps 40° (fourth notch) and land on the main wheels first. Immediately after touchdown, lower the nose gear to the ground and apply heavy braking as required. Raising the flaps after landing will provide more efficient braking.

When landing in a strong crosswind, use the minimum flap setting required for the field length. Use a wing low, crab, or a combination method of drift correction and land in a nearly level attitude. Hold a straight course with the steerable nosewheel and occasional braking if necessary.

COLD WEATHER OPERATION.

Prior to starting on cold mornings, it is advisable to pull the propeller through several times by hand to "break loose" or "limber" the oil, thus conserving battery energy. In extremely cold (-20°F) weather the use of an external pre-heater is rec-

ommended whenever possible to reduce wear and abuse to the engine and the electrical system. Cold weather starting procedures are as follows:

- (1) Clear propeller.
- (2) Turn master switch "ON."
- (3) With magneto switch "OFF" and throttle closed, prime the engine four to ten strokes as the engine is being turned over.
- (4) Turn magneto switch to "BOTH."
- (5) Open throttle 1/8" (to idle position) and engage starter to start engine.

NOTE

In extremely cold weather a few strokes of the primer as the engine fires will enable the engine to keep running. (Avoid over-priming.) After priming, push primer all the way in and turn to locked position to avoid possibility of engine drawing fuel through the primer. Do not attempt a second start until engine has come to a complete stop from the first attempt. Failure to do this may result in damage to the starting gear.

During cold weather operations, no indication will be apparent on the oil temperature gage prior to take-off if outside air temperatures are very cold. After a suitable warm-up period (2 to 5 minutes at 1000 RPM), accelerate the engine several times to higher engine RPM. If the engine accelerates smoothly and the oil pressure remains normal and

Operating Details

steady, the airplane is ready for take-off.

When operating in sub-zero temperature, avoid using partial carburetor heat. Partial heat may increase the carburetor air temperature to the 32° to 80°F range, where

icing is critical under certain atmospheric conditions.

For operation at temperatures consistently below freezing, a winterization kit is available at your Cessna Dealer for a nominal charge.

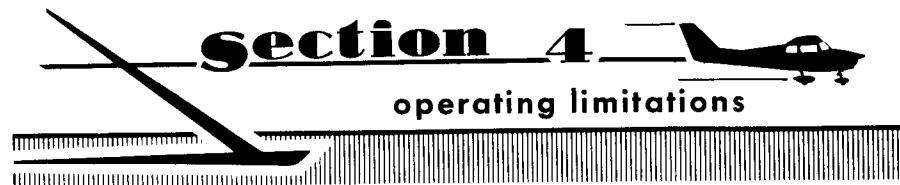

OPERATIONS AUTHORIZED.

Your Cessna with standard equipment as certificated under FAA Type Certificate No. 3A12 is approved for day and night operation under VFR.

Additional optional equipment is available to increase its utility and to make it authorized for use under IFR day and night. An owner of a properly-equipped Cessna is eligible to obtain approval for its operation on single engine scheduled airline service on VFR.

MANEUVERS - NORMAL CATEGORY.

The airplane exceeds the requirements of the Civil Air Regulations, Part 3, set forth by the United States Government for airworthiness. Spins and aerobatic maneuvers are not permitted in normal category airplanes in compliance with these regulations. In connection with the foregoing, the following gross weights and flight load factors apply:

Gross Weight	2250 lbs.
Flight Load Factor *Flaps Up	+3.8 -1.52
Flight Load Factor *Flaps Down	+3.5

*The design load factors are 150% of the above and in all cases the structure meets or exceeds design loads.

Your airplane must be operated in accordance with all FAA approved markings, placards and check lists in the airplane. If there is any information in this section which contradicts the FAA approved markings, placards and check lists, it is to be disregarded.

MANEUVERS - UTILITY CATEGORY.

This airplane is not designed for purely aerobatic flight. However, in the acquisition of various certificates such as commercial pilot, instrument pilot and flight instructor, certain maneuvers are required by the FAA. All of these maneuvers are permitted in this airplane when operated in the utility category. In connection with the utility category, the following gross weight and flight load factors apply, with recommended entry

speeds for maneuvers as shown.

Maximum Design Weight	1950 lbs.
Flight Maneuvering Load Factor, Flaps Up	+4.4 -1.76
Flight Maneuvering Load Factor, Flaps Down	+3.5

No acrobatic maneuvers are approved except those listed below:

Maneuver	Entry Speed
Chandelles	115 mph (100 knots)
Lazy Eights	115 mph (100 knots)
Steep Turns	115 mph (100 knots)
Spins	Slow Deceleration
Stalls (Except Whip Stalls)	Slow Deceleration

The baggage compartment and rear seat must not be occupied.

Aerobatics that may impose high inverted loads should not be attempted. The important thing to bear in mind in flight maneuvers is that your Cessna is clean in aerodynamic design and will build up speed quickly with the nose down. Proper speed control is an essential requirement for execution of any maneuver and care should always be exercised to avoid excessive speed which in turn can impose excessive loads. In the execution of all maneuvers avoid abrupt use of controls.

AIR SPEED LIMITATIONS.

The following are the certificated true indicated airspeed limits for your Cessna:

Maximum (Glide or dive, smooth air)	160 mph (red line)
Caution Range (Level flight or climb)	140-160 mph (yellow arc)
Normal Range (Level flight or climb)	59-140 mph (green arc)
Flap Operating Range	55-100 mph (white arc)
Maneuvering Speed*	115 mph

*The maximum speed at which you can use abrupt control travel without exceeding the design load factor.

ENGINE OPERATION LIMITATIONS.

Power and Speed	145 bhp at 2700 rpm
---------------------------	---------------------

ENGINE INSTRUMENT MARKINGS.

OIL TEMPERATURE GAGE.

Normal Operating Range	Green Arc
Maximum Allowable	Red Line

OIL PRESSURE GAGE.

Minimum Idling	10 psi (red line)
Normal Operating Range	30-60 psi (green arc)
Maximum	100 psi (red line)

FUEL QUANTITY INDICATORS.

Empty (1-1/2 gallons unusable each tank)	E (red line)
--	--------------

TACHOMETER

Normal Operating Range:	
At sea level	2200-2450 (inner green arc)
At 5000 feet	2200-2550 (middle green arc)
At 10,000 feet	2200-2650 (outer green arc)
Maximum Allowable	2700 (red line)

CYLINDER HEAD TEMPERATURE GAGE.

Normal Operating Range	350° to 475°F (green arc)
Maximum	525°F (red line)

WEIGHT AND BALANCE.

The information presented in this section will enable you to operate your Cessna within the prescribed weight and center of gravity limitations.

In figuring your loading problems be certain that you use the Licensed Empty Weight of your particular airplane as shown on its Weight and Balance Data sheet. This sheet, plus an Equipment List, is included with each airplane as it leaves the factory. The FAA requires that any change in the original equipment affecting the empty weight center of gravity be recorded on a Repair and Alteration Form FAA-337.

READ BEFORE WORKING LOADING PROBLEM FOR YOUR AIRPLANE

To figure the weight for your airplane in the same manner as the sample problem on page 4-5, proceed as follows:

- Step 1. Take the licensed Empty Weight and Moment/1000 from the Weight and Balance Data sheet carried in your airplane and write them down in two columns in the manner shown in the sample problem.
- Step 2. Write down the weight and moment/1000 for the oil in the proper columns. Since you usually have full load of oil for a trip, you figure 8 qts. at 15.0 lbs. and a moment of -0.3. You may use these same figures every time and consider this also a non-variable.

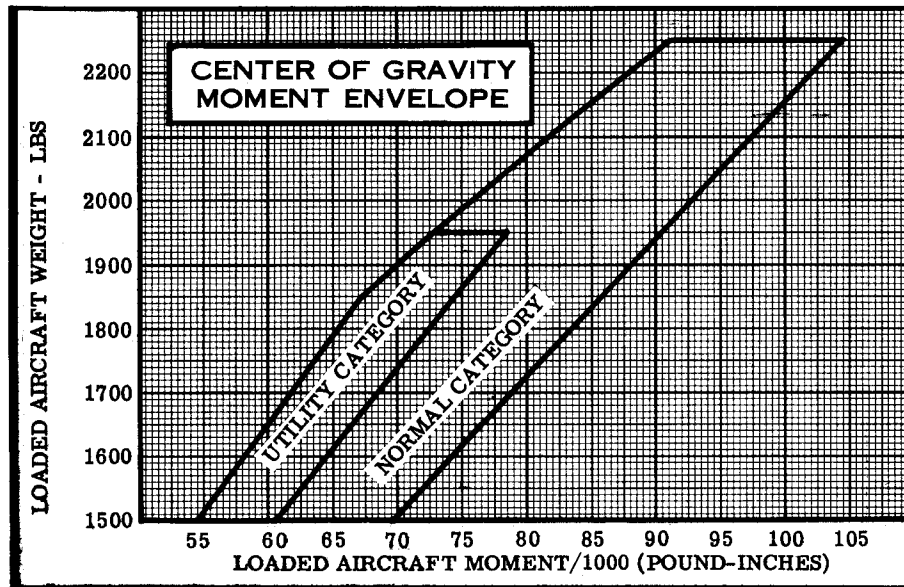
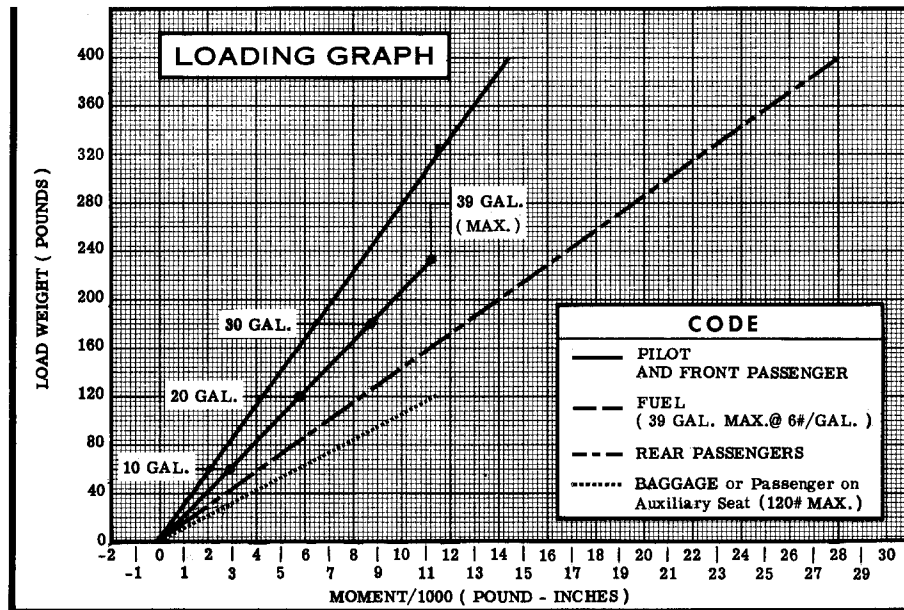

Step 3. Add the weight of yourself and the front passenger. Refer to the loading graph (on page 4-4) and find this weight at the left side of the graph and then go across the graph horizontally to the right until you intersect the line identified as "PILOT AND FRONT PASSENGER." After intersecting the line drop down vertically to the bottom line and read the moment/1000 given on the scale. Now write down this weight and moment/1000 for you and the front passenger in the proper columns.

Step 4. Proceed as you did in Step 3, except use the line identified as "FUEL" and 6 lbs. per gallon for the amount of gasoline you are carrying, and read the moment/1000 from the loading graph. Write the weight and moment/1000 in the proper columns.

Step 5. Proceed as you did in Step 3, except use the line identified as "REAR PASSENGERS," and read the moment/1000 for the combined weight of the rear passengers being carried. Write the weight and moment/1000 in the proper columns.

SAMPLE LOADING PROBLEM	Sample Airplane		Your Airplane	
	Weight (lbs)	Moment (lb - ins. /1000)	Weight	Moment
1. Licensed Empty Weight (Sample Airplane) ...	1305.5	49.5	1417	
2. Oil - 8 Qts.*	15.0	-0.3	15.0	-0.3
3. Pilot & Front Passenger	340.0	12.2	110	
4. Fuel - (22.5 Gal at 6#/Gal)	135.0	6.5	234	
5. Rear Passengers	340.0	23.8	0	
6. Baggage (or Passenger on Auxiliary Seat)	114.5	10.9	0	
7. Total Aircraft Weight (Loaded)	2250.0	102.6	1026	

8. Locate this point (2250 at 102.6) on the center of gravity envelope, and since this point falls within the envelope the loading is acceptable.

*Note: Normally full oil may be assumed for all flights.

Operating Limitations

- Step 6. Proceed as you did in Step 3, except use the line identified as "BAGGAGE OR PASSENGER ON AUXILIARY SEAT," and read the moment/1000 for the number of pounds of baggage (or weight of passenger) being carried. Write the weight and moment/1000 in the proper columns.
- Step 7. Add the weight column. The total must be 2250 lbs., or below, or you must lighten your aircraft load. Add the moment column (remember to subtract rather than add the oil moment because it is a minus quantity).
- Step 8. Refer to the Center of Gravity Moment Envelope. Locate the total weight on the scale on the left hand side of the graph and, from this point, follow a line horizontally to the right. Locate the total moment/1000 on the scale running across the bottom of the graph and, from this point, follow a line vertically up until you intersect the line running horizontally from your total weight. If the point, where the two lines intersect is within the envelope, your airplane is loaded within approved limits. If the point of intersection falls outside the envelope, your load must be adjusted before flight.

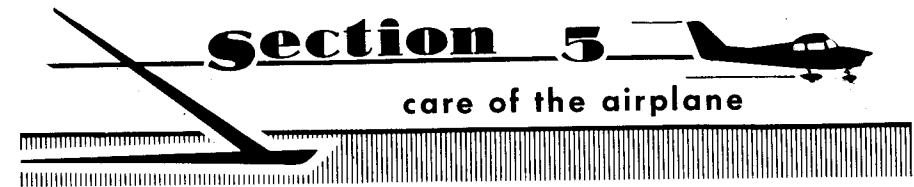

If your airplane is to retain that new plane performance, stamina, and dependability, certain inspection and maintenance requirements must be followed. It is always wise to follow a planned schedule of lubrication and maintenance based on the climatic and flying conditions encountered in your locality.

Keep in touch with your Cessna Dealer and take advantage of his knowledge and experience. He knows your airplane and how to maintain it. He will remind you when lubrications and oil changes are necessary and about other seasonal and periodic services.

GROUND HANDLING.

The airplane is most easily and safely maneuvered by hand with a tow-bar attached to the nosewheel. Always use the tow-bar (optional equipment) when one is available. When moving the airplane by hand, if no tow-bar is available, push down at the front edge of the stabilizer next to the fuselage to raise the nosewheel off the ground. When the nosewheel is held clear of the ground the airplane can be turned readily in any direction by pivoting it about the main gear. Do not push down on the empennage by the tip of the elevator nor shove sidewise on the upper portion of the fin. When moving the airplane forward or backwards, push at the wing strut root fitting or at the main gear strut.

MOORING YOUR AIRPLANE.

Proper tie-down procedure is your

best precaution against damage to your parked airplane by gusty or strong winds. To tie down your airplane securely, proceed as follows:

- (1) Tie sufficiently strong ropes or chains (700 pounds tensile strength) to the wing tie-down fittings at the upper end of each wing strut.
- (2) Secure the opposite ends of these ropes or chains to tie-down rings in the ground.
- (3) Tie a rope or chain through the nose gear tie-down ring and secure the opposite end to a tie-down ring in the ground.
- (4) Securely tie the middle of a length of rope to the ring at the tail. Pull each end of the rope away at a 45° angle and secure it to tie-down rings positioned on each side of the tail.
- (5) Install surface control locks between the flap and aileron of each wing.
- (6) Install the control lock in the control wheel shaft.

(7) Install a surface control lock over the fin and rudder.

STORAGE.

The all-metal construction of your Cessna makes outside storage of it practical. However, inside storage of the plane will increase its life just as inside storage does for your car. If your airplane must remain inactive for a time, cleanliness is probably the most important consideration, whether it is stored inside or outside. A small investment in cleanliness will repay you many times not only in keeping your airplane looking like new but in keeping it new. A later paragraph in this section covers the subject in greater detail.

Do not neglect the engine when storing the airplane. Turn the propeller over by hand or have it turned over every few days to keep the engine bearings, cylinder walls and internal parts lubricated. Full fuel tanks will help prevent condensation and increase fuel tank life.

Regular use helps keep airplanes in good condition. An airplane left standing idle for any great length of time is likely to deteriorate more rapidly than if it is flown regularly, and should be carefully checked over before being put back into service.

WINDSHIELD AND WINDOWS.

The windshield is a single piece, full floating, "free-blown" unit of "Longlife" plastic. To clean the plastic, wash with plenty of soap and water, using the palm of the hand to

feel and dislodge any caked dirt. A soft cloth, sponge, or chamois may be used, but only as a means of carrying water to the plastic. Dry with a clean, damp chamois. Rubbing with a dry cloth builds up an electrostatic charge so that it attracts dust particles from the air. Wiping with a damp chamois will remove this charge as well as the dust.

Remove oil and grease by rubbing lightly with a cloth wet with kerosene. Do not use gasoline, alcohol, benzene, acetone, carbon tetrachloride, fire extinguisher or deicing fluids, lacquer thinner or glass window cleaning spray as they will soften the plastic and cause crazing.

After cleaning, if no great amount of scratching is visible, wax the surface with a good grade of commercial wax. Waxing fills in minor scratches and helps to avoid further scratching. Apply the wax in a thin, even coat and bring it to a high polish by rubbing lightly with a clean, dry, soft flannel cloth.

Do not use a canvas cover to protect the windshield when the airplane is tied out, unless freezing rain or snow is expected. Canvas covers may cause crazing.

ALUMINUM SURFACES.

The clad aluminum surfaces of your Cessna require only a minimum of care to keep them bright and clean. The airplane may be washed with clear water to remove dirt; oil and grease may be removed with gasoline, naphtha, carbon tetrachloride or other non-alkaline solvents. While household detergent soap powders

are effective, they should be used cautiously since some are strongly alkaline and may attack the aluminum.

Dulled aluminum surfaces may be cleaned effectively with a mixture of about two quarts of denatured alcohol, two quarts of water and a package of powdered Bon Ami.

After cleaning, and periodically thereafter, waxing with a good automotive wax will preserve the bright appearance and retard corrosion. Regular waxing is especially recommended for airplanes operated in salt water areas as a protection against corrosion.

PAINTED SURFACES.

The painted exterior surfaces of your new Cessna have been finished with high grade materials selected for their toughness, elasticity, and excellent adhesion. With a minimum of care, they will retain their original beauty for many years.

As with any paint applied to a metal surface, the desired qualities of the paint develop slowly throughout an initial curing period which may be as long as 90 days after the finish is applied. During this curing period some precautions should be taken to avoid damaging the finish or interfering with the curing process. The finish should be cleaned only by washing with clean, cold water and mild soap, followed by a rinse with cold water and drying with cloths or a chamois. Do not use polish or wax, which would exclude air from the surface. Do not rub or buff the finish and avoid flying through rain, hail or

sleet. Once the finish has cured completely, it may be waxed with a good automotive wax. A heavier coating of wax on the leading edges of the wings and tail and on the nose cap and propeller spinner will help reduce the abrasion encountered in these areas.

Fluids containing dyes, such as fuel and hydraulic oil, accidentally spilled on the painted surface, should be flushed away at once to avoid a permanent stain. Spilled battery electrolyte must be flushed off at once, and the area neutralized with an alkali such as baking soda solution, followed by a thorough rinse with clear water.

PROPELLER CARE.

Preflight inspection of propeller blades for nicks, and wiping them occasionally with an oily cloth to clean off grass and bug stains will assure long, trouble-free service. It is vital that small nicks on the propeller, particularly near the tips and on the leading edges, are dressed out as soon as possible since these nicks produce stress concentrations, and if ignored, may result in cracks. Never use an alkaline cleaner on the blades; remove grease and dirt with carbon tetrachloride or Stoddard solvent.

Your Cessna Dealer should be consulted about other repair and maintenance work. Civil Air Regulations require that all maintenance except dressing small blade nicks, cleaning, and minor repairs to the spinner be done by an FAA authorized propeller repair station.

INTERIOR CARE.

To remove dust and loose dirt from the upholstery and carpet, clean the interior regularly with a vacuum cleaner.

Blot up any spilled liquid promptly with cleansing tissue or rags. Don't pat the spot, press the blotting material firmly and hold it for several seconds. Continue blotting until no more liquid is taken up. Scrape off sticky materials with a dull knife, then spot clean the area.

Oily spots may be cleaned with household spot removers, used sparingly. Before using any solvent read the instructions on the container and test it on an obscure place in the fabric to be cleaned. Never saturate the fabric with a volatile solvent; it may damage the padding and backing materials.

Soiled upholstery and carpet may be cleaned with a foam-type detergent, used according to the manufacturer's instructions. Keep the foam as dry as possible and remove it with a vacuum cleaner, to minimize wetting the fabric.

The plastic trim, headliner, instrument panel and control knobs need only be wiped off with a damp cloth. Never use a volatile solvent on plastic.

INSPECTION SERVICE AND INSPECTION PERIODS.

With your airplane you will receive an Owner's Service Policy. This policy has coupons attached to it which entitle you to a no-charge initial inspection and a no-charge

100 hour inspection. If you take delivery from your Dealer, he will perform the initial inspection before delivery of the airplane to you. If you pick up the airplane at the factory, plan to take your Cessna to your Dealer reasonably soon after you take delivery on it. This will permit him to check it over and make any minor adjustments that may appear necessary. Also plan an inspection by your Dealer at 100 hours or 90 days whichever comes first. This inspection also is performed by your Dealer for you at no charge. While these important inspections will be performed for you by any Cessna Dealer, in most cases you will prefer to have the Dealer from whom you purchase the airplane accomplish this work for you.

Civil Air Regulations require all airplanes to have a periodic (annual) inspection as required by the administrator, made by a person designated by the administrator, and in addition, 100-hour periodic inspections made by an "appropriately rated mechanic" if the airplane is flown for hire. The Cessna Aircraft Company recommends the 100-hour periodic inspection for your airplane. The procedure for this 100-hour inspection has been carefully worked out by the factory and is followed by the Cessna Dealer organization. The complete familiarity of the Cessna Dealer organization with Cessna equipment and with Cessna procedures provides the highest type of service possible at lower cost.

Time studies of the 100-hour inspection at the factory and in the field have developed a standard flat

rate charge for this inspection at any Cessna Dealer. Points which the inspection reveals require modification or repairs will be brought to your attention by the Dealer and quotations or charges will be made accordingly. The inspection charge does not include the oil required for the oil change.

Every effort is made to attract the best mechanics in each community to Cessna service facilities. Many Dealers' mechanics have attended Cessna Aircraft Company schools and have received specialized instruction in maintenance and care of Cessna airplanes. Cessna service instruction activity in the form of service bulletins and letters is constantly being carried on so that when you have your Cessna inspected and serviced by Cessna Dealers' mechanics the work will be complete and done in accordance with the latest approved methods.

Cessna Dealers maintain stocks of genuine Cessna parts and service facilities consistent with the demand.

Your Cessna Dealer will be glad to give you current price quotations on all parts that you might need and will be glad to advise you on the practicability of parts replacement versus repairs that might be necessary.

AIRPLANE FILE.

There are miscellaneous data, information and licenses that are a part of the airplane file. The following is a check list for that file. In addition, a periodic check should be

made of the latest Civil Air Regulations to insure that all data requirements are met.

- A. To be displayed in the airplane at all times:
 - (1) Aircraft Airworthiness Certificate (Form FAA 1362).
 - (2) Aircraft Registration Certificate (Form FAA 500A).
- B. To be carried in the airplane at all times:
 - (1) Airplane Radio Station License (if transmitter installed).
 - (2) Weight and Balance Report or latest copy of the Repair and Alteration Form (Form FAA-337).
 - (3) Airplane Equipment List.
 - (4) Airplane Log Book.
 - (5) Engine Log Book.
- C. To be maintained but not necessarily carried in the airplane at all times:
 - (1) A form containing the following information: Model, Registration Number, Factory Serial Number, Date of Manufacture, Engine Number, and Key Numbers (duplicate keys are available through your Cessna Dealer).

Most of the items listed are required by the United States Civil Air Regulations. Since the regulations of other nations may require other documents and data, owners of exported airplanes should check with their own aviation officials to determine their individual requirements.

LUBRICATION AND SERVICING.

Specific lubrication and servicing information is presented in figure 5-1. In addition, all pulleys, the trim tab actuator rod, control surface hinge bearings, bellcrank clevis bolts, flap handle, brake pedal pivots, rudder pedal crossbars, shimmy dampener pivots, door hinges and latches, Bowden controls, throttle, and the control wheel shaft universals should be lubricated every 1000 hours or oftener, with SAE 20 general-purpose oil.

Generally, roller chains (aileron, tab wheel and tab actuator) and control cables collect dust, sand and grit if they are greased or oiled. Except under seacoast conditions, chains and cables should be merely wiped clean occasionally with a dry cloth.

DEALER FOLLOW-UP SYSTEM.

Your Cessna Dealer has an owner follow-up system to notify you when he receives information that applies to your Cessna. In addition, if you wish, you may choose to receive similar notification directly from the Cessna Service Department. A subscription card is supplied to you in your airplane file for your use, should you choose to request this service. Your Cessna Dealer will be glad to supply you with details concerning these follow-up programs, and stands ready through his Service Department to supply you with fast, efficient, low cost service.

SERVICING DIAGRAM

*If optional quick drain valves are installed, drain fuel tank sumps daily.

RECOMMENDED FUEL:
AVIATION GRADE---80/87
OCTANE
RECOMMENDED ENGINE OIL:
AVIATION GRADE
SAE 40 ABOVE 50°F
SAE 20 BELOW 50°F
HYDRAULIC FLUID:
SPEC. NO. MIL-H-5606

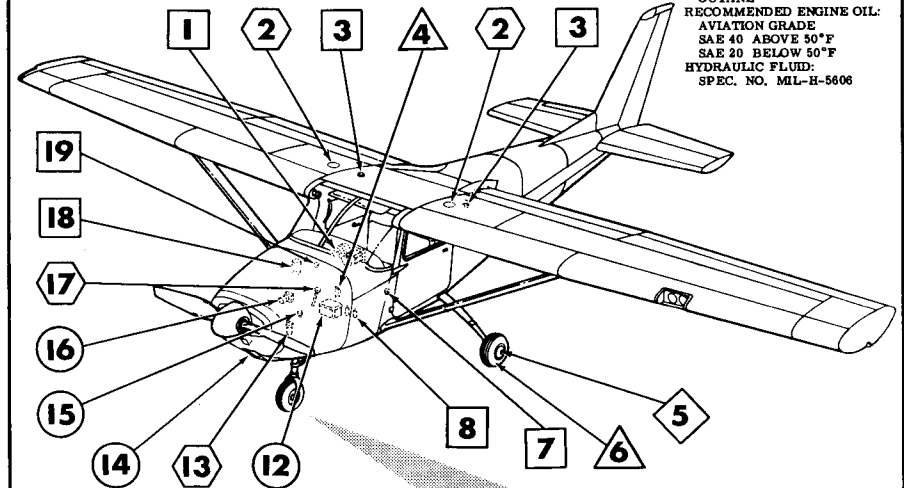

SERVICING INTERVALS

-  CHECK OR SERVICE DAILY
-  SERVICE EVERY 25 HOURS
-  SERVICE EVERY 100 HOURS
-  SERVICE EVERY 500 HOURS
-  SERVICE OR CHECK AS REQUIRED

Symbol denotes servicing interval. Number within symbol refers to item to be serviced as shown in adjoining specifications.

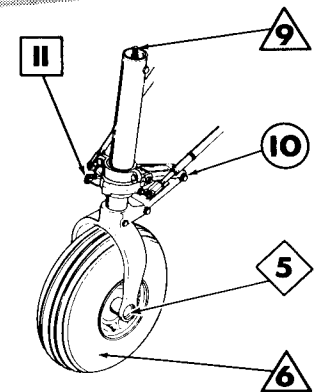

Figure 5-1. (Sheet 1 of 4)

SERVICING PROCEDURES

- 1 GYRO INSTRUMENT AIR FILTERS (OPT)**
Replace every 100 hours and when erratic or sluggish responses are noted with normal suction gage readings.
- 2 FUEL TANK FILLERS**
Service after each flight with 80/87 octane aviation grade fuel. The capacity of each tank is 21 gallons.
- 3 FUEL TANK SUMP DRAINS**
Every 100 hours, remove drain plug, drain off water and sediment, and reinstall plug. Safety wire plug to adjacent wing structure. If optional quick drain valves are installed, (on first flight of day) drain a two-ounce quantity of fuel.
- 4 GROUND SERVICE RECEPTACLE (OPT)**
Connect to 12-volt, DC, negative-ground power unit for cold weather starting and lengthy ground maintenance of the electrical system. When auxiliary power unit is used, master switch should be left off until the plug has been pulled.
- 5 WHEEL BEARINGS**
Repack with MIL-G-7711 or aircraft wheel bearing grease at first 100 hours, 500 hours thereafter; oftener if more than the usual amount of water, mud, ice or snow is encountered.
- 6 TIRES**
Maintain pressure of 35 psi on the nosewheel and 23 psi on the main wheels. Inflate tires with filler needle stored in map compartment. Remove oil and grease from tires with soap and water; periodically inspect them for cuts, bruises and wear.
- 7 FUEL LINE DRAIN PLUG**
Every 100 hours, remove drain plug, drain off water and sediment, and reinstall plug. Safety wire plug.
- 8 BRAKE MASTER CYLINDERS**
Every 100 hours, check fluid level in brake master cylinders. Fill with MIL-H-5606 (red) hydraulic fluid. Filling

Figure 5-1. (Sheet 2 of 4)

- with a pressure pot connected to the brake bleeder ports is preferable, although fluid may be poured through the plugs on the top of the master cylinders.
- 9 NOSE GEAR SHOCK STRUT**
Keep strut inflated and filled with MIL-H-5606 (red) hydraulic fluid. See Service Manual for detailed instructions.
- 10 NOSE GEAR TORQUE LINKS**
Every 25 hours, lubricate through grease fittings with MIL-L-7711 general purpose grease. Wipe off excess.
- 11 SHIMMY DAMPENER**
Every 100 hours, check fluid level in shimmy dampener. Fill with MIL-H-5606 (red) hydraulic fluid. See Service Manual for detailed instructions.
- 12 BATTERY**
Check level of electrolyte every 25 hours (or at least every 30 days), oftener in hot weather. Maintain level by adding distilled water. Immediately neutralize spilled electrolyte with baking soda solution, then flush with water. Keep battery clean and battery connections tight. Neutralize corrosion deposits with baking soda solution, then rinse thoroughly.
- 13 FUEL STRAINER**
Drain approximately two ounces of fuel before each flight and after refueling to remove water and sediment. Make sure drain valve is closed after draining. Disassemble and clean bowl and screen each 100 hours.
- 14 CARBURETOR AIR FILTER**
Service every 25 hours or oftener when operating in dusty conditions. Under extremely dusty conditions, daily maintenance of the filter is recommended. Service in accordance with instructions on the filter frame.
- 15 OIL SUMP DRAIN**
Every 25 hours, change engine oil. Drain oil by removing plug in sump. Remove lower cowling and provide protection

Figure 5-1. (Sheet 3 of 4)

for lower engine components and nosewheel tire when draining.

16 ENGINE OIL SCREEN

Remove and wash screen (located on right rear side of engine accessory section) with Stoddard solvent (Fed. Spec. P-S-661) whenever engine oil is changed.

17 OIL FILLER AND DIPSTICK

When preflight check shows low oil level, service with aviation grade engine oil; SAE 40 above 50°F and SAE 20 below 50°F. Oil capacity is 8 quarts. Do not operate with less than 6 quarts and completely fill the sump if an extended flight is planned. Your Cessna was delivered from the factory with straight mineral oil (non-detergent) and should be operated with straight mineral oil for the first 25 hours. The use of mineral oil during the 25-hour break-in period will help seat the piston rings and will result in less oil consumption. After the first 25 hours, either mineral oil or detergent oil may be used. If a detergent oil is used, it must conform to Continental Motors Corporation Specification MHS-24. Your Cessna Dealer can supply an approved brand.

18 VACUUM SYSTEM OIL SEPARATOR (OPT)

Every 100 hours, remove separator and flush with Stoddard solvent (Fed. Spec. P-S-661); then dry with compressed air and reinstall.

19 SUCTION RELIEF VALVE INLET SCREEN (OPT)

Every 100 hours, check inlet screen for dirt or obstructions if suction gage readings appear high. Remove screen and clean with compressed air or wash with Stoddard solvent (Fed. Spec. P-S-661).

The military specifications listed are not mandatory, but are intended as guides in choosing satisfactory materials. Products of most reputable manufacturers meet or exceed these specifications.

Figure 5-1. (Sheet 4 of 4)

section 6



operational data



The operational data shown on the following pages are compiled from actual tests with airplane and engine in good condition and using average piloting technique and best power mixture. You will find this data a valuable aid when planning your flights. However, inasmuch as the number of variables included precludes great accuracy, an ample fuel reserve should be provided. The range performance shown makes no allowance for wind, navigational error, pilot technique, warm-up, take-off, climb, etc. All of these factors must be considered when estimating reserve fuel.

To realize the maximum usefulness from your Cessna, take advantage of the high cruising speed. However, if range is of primary importance, it may pay you to fly at a low cruising rpm thereby increasing your range and allowing you to make the trip non-stop with ample fuel reserve. Use the range table on page 6-3 to solve flight planning problems of this nature.

In the table, (Figure 6-3), range and endurance are given for lean mixture, from 2,500 feet to 12,500 feet and for rich mixture at altitudes of 2,500 feet and 5,000 feet. All figures are based on zero wind, 39 gallons of fuel for cruise, McCauley 1C172/EM7653 propeller, 2250 pounds gross weight, and standard atmospheric conditions. For lean mixture figures, mixture is leaned to maximum RPM. Allowances for fuel reserve, headwinds, take-offs and climb, and variations in mixture leaning technique should be made and are in addition to those shown on the charts. Other indeterminate variables such as carburetor metering characteristics, engine and propeller conditions, and turbulence of the atmosphere may account for variations of 10% or more in maximum range.

AIRSPEED CORRECTION TABLE

FLAPS UP											
IAS	40	50	60	70	80	90	100	110	120	130	140
TIAS	59	62	66	73	81	90	99	108	118	127	136
FLAPS DOWN											
IAS	40	50	60	70	80	90	100	—	—	—	—
TIAS	49	57	65	73	82	91	100	—	—	—	—

Figure 6-1.

TAKE-OFF DATA

TAKE-OFF DISTANCE WITH FLAPS UP, FROM HARD SURFACE RUNWAY

GROSS WEIGHT LBS.	AT SEA LEVEL & 59°F		AT 2500 FT. & 50°F		AT 5000 FT. & 41°F		AT 7500 FT. & 32°F	
	IAS AT 50 FT.	HEAD WIND MPH	GROUND RUN	TO CLEAR 50' OBSTACLE	GROUND RUN	TO CLEAR 50' OBSTACLE	GROUND RUN	TO CLEAR 50' OBSTACLE
1600	56	0	380	725	460	845	555	1000
		15	215	470	265	560	330	670
		30	95	265	125	320	160	395
1900	61	0	560	1000	675	1185	820	1420
		15	335	675	415	805	515	980
		30	165	400	210	480	275	610
2250	67	0	825	1430	995	1710	1220	2100
		15	520	985	640	1205	795	1500
		30	280	625	355	770	455	985

NOTE: INCREASE DISTANCE 10% FOR EACH 25°F. ABOVE STANDARD TEMPERATURE FOR PARTICULAR ALTITUDE.

CLIMB DATA

GROSS WEIGHT LBS.	AT SEA LEVEL & 59°F			AT 5000 FT. & 41°F			AT 10000 FT. & 23°F			AT 15000 FT. & 50°F		
	BEST CLIMB IAS MPH	RATE OF CLIMB FT/MIN	GAL. OF FUEL USED	BEST CLIMB IAS MPH	RATE OF CLIMB FT/MIN	GAL. OF FUEL USED	BEST CLIMB IAS MPH	RATE OF CLIMB FT/MIN	GAL. OF FUEL USED	BEST CLIMB IAS MPH	RATE OF CLIMB FT/MIN	GAL. OF FUEL USED
1600	71	1220	1.0	69	955	1.8	67	680	2.6	65	425	3.8
1900	75	940	1.0	73	710	2.1	71	475	3.3	69	245	5.2
2250	78	700	1.0	77	490	2.5	76	285	4.4	75	80	8.5

NOTE: FLAPS UP, FULL THROTTLE, AND MIXTURE LEANED FOR SMOOTH OPERATION ABOVE 5000 FT. FUEL USED INCLUDES WARM-UP AND TAKEOFF ALLOWANCE.

Figure 6-2.

SKYHAWK CRUISE AND RANGE PERFORMANCE

STANDARD ATMOSPHERIC CONDITIONS
39 GALLONS OF FUEL (NO RESERVE)

ZERO WIND
GROSS WEIGHT- 2250 POUNDS

RICH MIXTURE							
ALTITUDE	RPM	%BHP	TAS, MPH	GAL./HOUR	ENDR. HOURS	MILES/GAL.	RANGE, MILES
2500	2700	91	136	12.6	3.1	10.7	420
	2600	81	129	11.1	3.5	11.6	450
	2500	72	123	10.1	3.9	12.2	475
	2400	64	117	9.2	4.2	12.6	495
	2300	57	110	8.5	4.6	13.0	505
	2200	50	104	7.8	5.0	13.4	520
	2100	45	98	7.2	5.4	13.6	530
5000	2700	84	134	12.0	3.2	11.2	435
	2600	76	129	10.9	3.6	11.8	460
	2550	71	125	10.4	3.8	12.0	470
	2500	67	122	9.9	3.9	12.3	480
	2400	60	115	9.1	4.3	12.6	490
	2300	54	109	8.4	4.6	13.0	505
	2200	47	103	7.7	5.1	13.3	520
2100	42	97	7.1	5.5	13.7	535	
LEAN MIXTURE							
2500	2700	91	137	11.5	3.4	11.9	465
	2600	81	131	10.3	3.8	12.8	500
	2500	72	125	9.2	4.2	13.6	530
	2400	64	119	8.1	4.6	14.6	570
	2300	57	112	7.2	5.4	15.6	605
	2200	50	106	6.4	6.1	16.6	645
	2100	45	100	5.7	6.8	17.5	685
5000	2700	84	136	10.7	3.7	12.8	500
	2600	76	131	9.6	4.1	13.6	530
	2550	71	127	9.0	4.3	14.1	550
	2500	67	124	8.5	4.6	14.5	565
	2400	60	117	7.6	5.1	15.4	600
	2300	54	111	6.8	5.7	16.4	640
	2200	47	105	6.0	6.5	17.4	680
2100	42	99	5.4	7.2	18.4	715	
7500	2650	74	132	9.4	4.2	14.1	550
	2600	70	129	8.9	4.4	14.5	565
	2500	63	123	7.9	4.9	15.4	600
	2400	56	116	7.1	5.5	16.3	635
	2300	50	110	6.4	6.1	17.3	675
	2200	45	104	5.7	6.8	18.2	710
	2100	41	99	5.2	7.6	19.3	750
10,000	2650	69	131	8.7	4.5	15.0	585
	2600	65	127	8.3	4.7	15.4	600
	2500	59	121	7.4	5.2	16.3	635
	2400	53	115	6.7	5.8	17.1	670
	2300	47	109	6.0	6.5	18.2	710
	2200	43	104	5.4	7.2	19.1	745
	2100	39	100	5.0	7.8	20.0	780
12,500	2600	61	126	7.7	5.0	16.3	635
	2500	55	120	7.0	5.6	17.2	670
	2400	50	114	6.3	6.2	18.0	700
	2300	45	109	5.7	6.8	18.9	740
	2200	41	104	5.2	7.4	19.8	770

For standard 172 performance, subtract 1 MPH from the higher cruise speeds shown.

Figure 6-3.

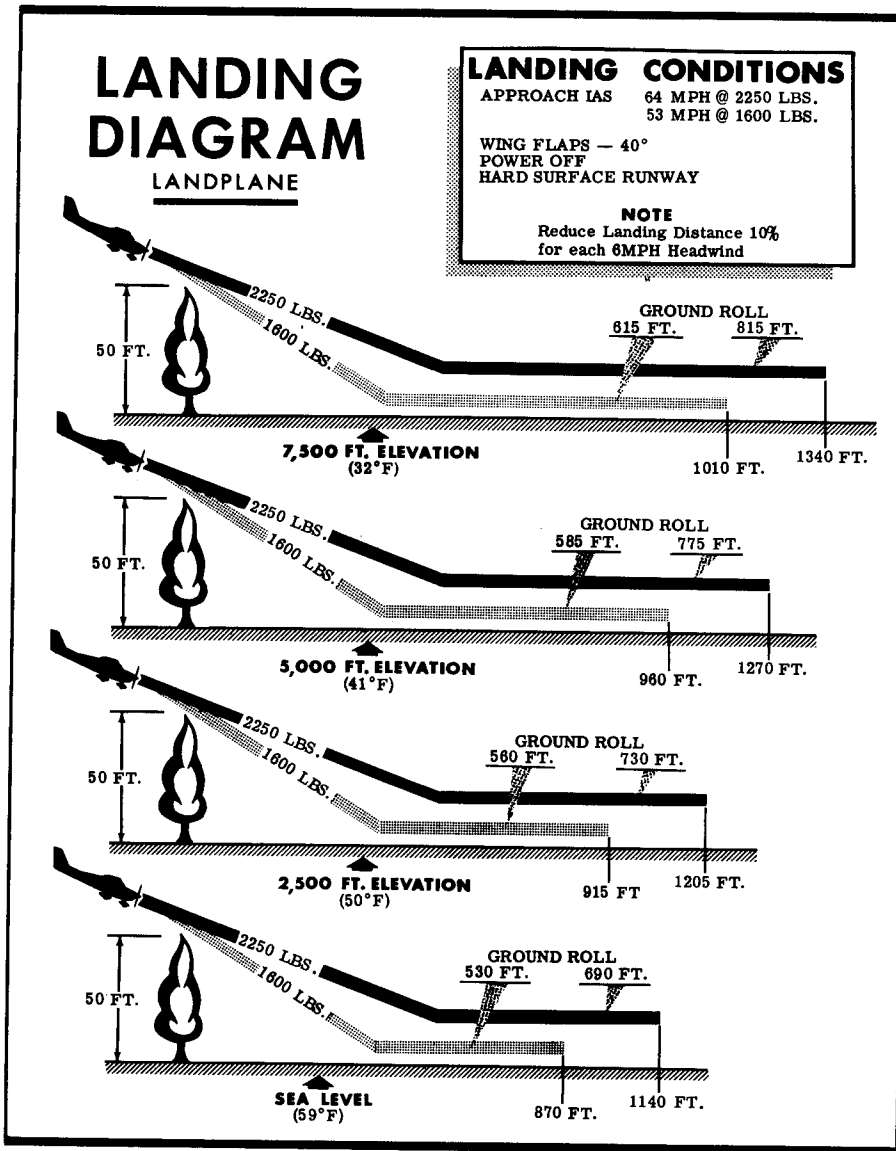

Figure 6-4.

STALLING SPEEDS				
POWER OFF — MPH, TIAS				
GROSS WEIGHT — 2250 POUNDS				
CONDITION	0°	20°	40°	60°
FLAPS UP	58	60	67	83
FLAPS 10°	54	56	62	77
FLAPS 40°	52	54	59	73

Figure 6-5.

Notes

Section 7



optional systems



This section contains a description, operating procedures, and performance data (when applicable) for the "major item" optional equipment systems in your airplane. Not all optional equipment is discussed here, rather it is those installations whose complexity and function is such that a detailed coverage is necessary for efficient utilization of the system. Optional equipment of a more simple nature, or equipment which is standard equipment on deluxe versions of the airplane, are discussed in other portions of this manual.

FLOATPLANE

DESCRIPTION

THE FLOATPLANE.

Your Cessna floatplane is identical to the landplane with the following exceptions:

(1) Floats, incorporating a water rudder steering system, replace the landing gear wheels, struts, and springs. A water rudder retraction handle, connected to the water rudder by cables and a spring, is located on the cabin floor tunnel. A hook for securing the handle in the "water rudder up" position is located near the elevator trim tab control wheel. Additional fuselage structure is added to support the float installation.

(2) The standard propeller is re-

placed with a propeller of larger diameter and flatter pitch.

(3) An oil radiator is installed under the engine just behind the cowl nose cap.

(4) An additional structural "V" brace is installed between the top of the front door posts and cowl deck.

(5) A seaplane placard is added.

(6) The entire airplane has additional corrosion-proofing.

WATER RUDDER STEERING SYSTEM.

The retractable water rudder is mounted at the aft end of the right float (left float water rudder is available as optional equipment) and is connected by a system of cables and

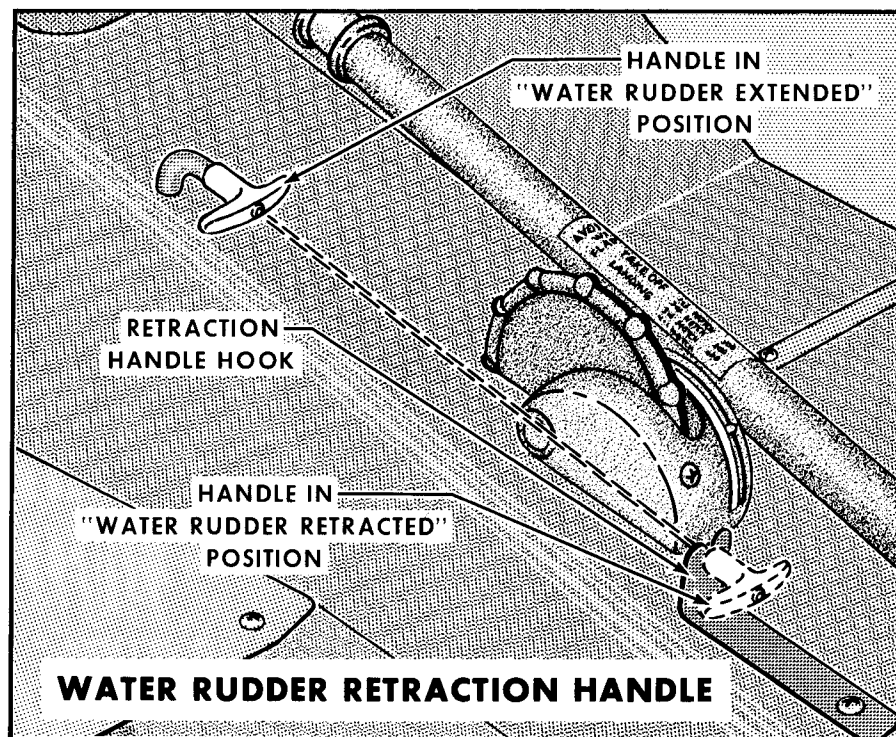

springs to the airplane rudder pedals. When the water rudder is extended, normal operation of the pedals moves the water rudder to provide steering control for taxiing.

A water rudder retraction handle, located on the cabin floor, is used to manually raise and lower the water rudder, through cables and a spring. During take-off, landing, and in flight

the retraction handle is normally stowed on the water rudder retraction handle hook, located on the control tunnel near the elevator trim tab control wheel. When the handle is stowed on the hook, the water rudder is up. Removing the handle from the hook will extend the water rudder to the operating position.

OPERATING CHECK LIST

BEFORE ENTERING FLOATPLANE.

- (1) Inspect the floats for dents,

cracks, scratches, etc.

- (2) Remove the cover plates and inspect the floats for water, remov-

ing accumulation with a sponge or pump. Reinstall cover plates, tightening only enough for a snug fit.

procedure is described on page 7-4 under "Minimum Run Take-off."

BEFORE STARTING ENGINE.

- (1) Operate and visually check water rudders for proper retraction and rudder action.

- (2) Water rudder -- Down for taxiing.

TAKE-OFF.

NORMAL TAKE-OFF.

- (1) Water rudder -- Up.
- (2) Set wing flaps 10° (first notch).
- (3) Hold the control wheel full back and advance the throttle slowly.

- (4) Place the airplane in a planing attitude (on the step) by slowly moving the control wheel forward when the bow wave moves aft of the wing strut position.

- (5) As airplane accelerates, apply light control wheel back pressure and allow airplane to fly off smoothly.

- (6) Climb at 60 MPH IAS to clear obstacles.

NOTE

To reduce take-off water run, the technique of raising one float out of the water may be used. This

CLIMB.

The maximum rate-of-climb is obtained at full throttle and 67 MPH IAS (see the TAKE-OFF and CLIMB DATA charts on page 7-8).

BEFORE LANDING.

- (1) Water rudder -- Up.
- (2) Maintain 65-70 MPH with flaps extended.

LANDING.

- (1) Touchdown in conventional manner at desired flap setting.

- (2) Maintain full up elevator as floatplane decelerates to taxi speed.

CAUTION

With forward loading, a slight nose down pitch may occur if the elevator is not held full up as floatplane comes down off the step.

AFTER LANDING.

- (1) Water rudder -- Down.

OPERATING DETAILS

TAXIING.

Taxi with water rudders down. It is best to limit the engine speed to 1000 RPM for normal taxi because water piles up in front of the float

bow at higher engine speeds. Taxiing with higher engine RPM may result in engine overheating but will not appreciably increase the taxi speed.

For minimum taxi speed in close

quarters, use idle RPM with full carburetor heat and a single magnet. This procedure is recommended for short periods of time only.

Although taxiing is very simple with the water rudders, it is sometimes necessary to "sail" the floatplane in close quarters. In addition to the normal flight controls, the wing flaps, ailerons, cabin doors, and water rudder will aid in "sailing."

To taxi great distances, it may be advisable to taxi on the step with the water rudder retracted. Turns on the step may be made with safety providing they are not too sharp and if ailerons are used to counteract the overturning tendency.

TAKE-OFF.

NORMAL TAKE-OFF.

The use of 10° flaps (first notch) throughout the take-off run is recommended (take-off distances are given on page 7-8). Apply full throttle smoothly and hold the control wheel full back. Watch the point where the bow wave leaves the float and move the control wheel forward slowly as this point moves aft of the wing strut. Slow control movement and light control pressures produce the best results. Attempts to force the airplane into the planing attitude will generally result in loss of speed and delay in getting on the step. The airplane will assume a planing attitude which permits acceleration to take-off speed (50 to 60 MPH IAS) at which time the airplane will fly off smoothly.

MINIMUM RUN TAKE-OFF.

To shorten the take-off run, the following procedure is recommended: With the airplane in the planing position, allow the airspeed to build up to 40 MPH IAS, at which speed one float can be raised out of the water by slowly applying full aileron. When one float leaves the water apply slight elevator back pressure to complete the take-off. Care must be taken to stop the rising wing as soon as the float is clear of the water, and in crosswinds, raise only the downwind wing. With one float out of the water, the airplane accelerates to take-off speed almost instantly.

If porpoising is encountered while on the step, apply additional back pressure to correct the excessively nose-low attitude.

CROSSWIND TAKE-OFF.

Start run with flaps up and water rudder extended for better directional control. Flaps are lowered to 10° and the water rudder retracted when the airplane is on the step and the remainder of the take-off is normal. If the floats are lifted from the water one at a time, the downwind float should be lifted first.

CLIMB.

Best rate-of-climb is obtained with the floatplane at 67 MPH IAS (see chart on page 7-8) with the flaps up and full throttle. Full rich mixture is used below 5000 feet for engine cooling. For obstruction clearance with 10° flaps, climb at 55 MPH IAS.

Such climbs should be of short duration due to reduced cooling at less than best rate-of-climb speeds.

CRUISE.

Observe the same engine speed

limits as for the landplane. This allows 67% power for a floatplane equipped with a McCauley 1A175/SFC 8040 propeller. Speed, range and endurance are shown on page 7-9 in the CRUISE PERFORMANCE chart.

WEIGHT AND BALANCE

The information presented in this section will enable you to operate your floatplane within the prescribed weight and center of gravity limitations.

In figuring your loading problems be certain that you use the Licensed Empty Weight of your particular floatplane as shown on its Weight and Balance Data Sheet. This sheet plus an Equipment List is included with each floatplane as it leaves the factory. When the floats have been installed by anyone other than the factory, the Repair and Alteration Form FAA-337 must be consulted for the proper weight and balance information. Refer to Section IV for procedure to be used when working loading problems.

SAMPLE LOADING PROBLEM	Sample Airplane		Your Airplane	
	Weight (lbs)	Moment (lb - ins. /1000)	Weight	Moment
1. Licensed Empty Weight (Sample Airplane) ...	1451.2	55.1		
2. Oil - 8 Qts.*	15.0	-0.3	15.0	-0.3
3. Pilot & Front Passenger	340.0	12.2		
4. Fuel - (39.0 Gal at 6#/Gal)	234.0	11.2		
5. Rear Passenger (1)	170.0	11.9		
6. Baggage	9.8	0.9		
7. Total Aircraft Weight (Loaded)	2220.0	91.0		
8. Locate this point (2220 at 91.0) on the center of gravity envelope, and since this point falls within the envelope the loading is acceptable.				

*Note: Normally full oil may be assumed for all flights.

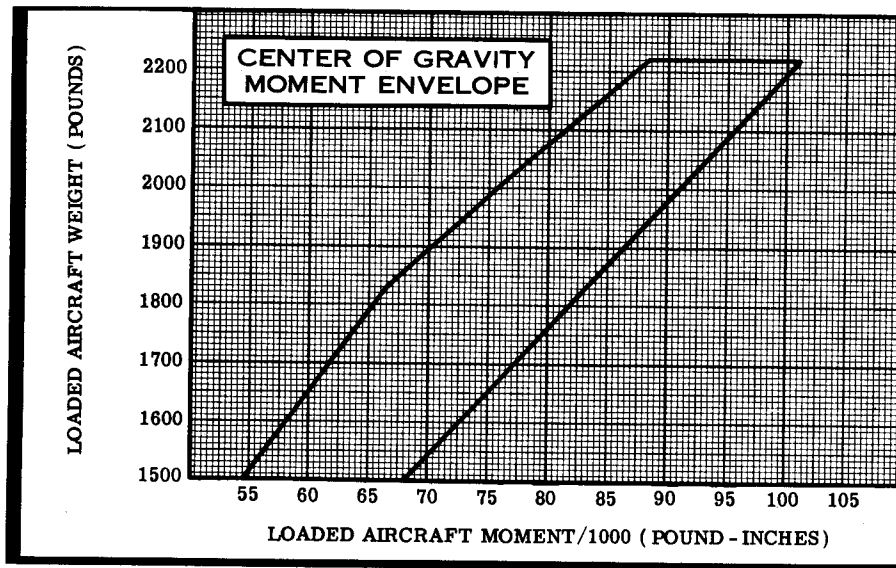
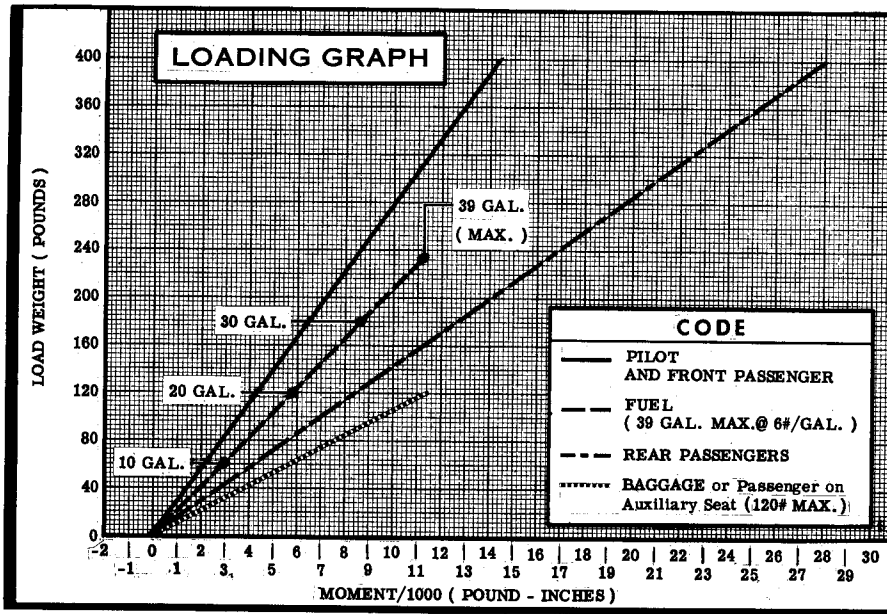

OPERATIONAL DATA

In the Cruise Performance Chart on page 7-9, range and endurance are given for lean mixture, from 2500 feet to 12,500 feet and for rich mixture at altitudes of 2500 feet to 5000 feet. All figures are based on zero wind, 30 gallons of fuel for cruise, McCauley 1A175/SFC 8040 propeller, 2220 pounds gross weight, and standard atmospheric conditions. For lean mixture figures, mixture is leaned to maximum RPM. Allowances for fuel reserve, headwinds, take-off and climb, and variations in mixture leaning technique should be made and are in addition to those shown on the charts. Other indeterminate variables such as carburetor metering-characteristics, engine and propeller conditions, and turbulence of the atmosphere may account for variations of 10% or more in maximum range.

FLOATPLANE		<i>Airspeed Correction Table</i>										FLOATPLANE	
FLAPS UP													
IAS	40	50	60	70	80	90	100	110	120	130			
CAS	61	64	67	73	80	89	98	108	117	126			
FLAPS DOWN													
IAS		50	60	70	80	90	100						
CAS		55	64	73	82	91	100						

Figure 7-1.

TAKE-OFF DATA

TAKE - OFF DISTANCE WITH 10° FLAPS

GROSS WEIGHT POUNDS	HEAD WIND MPH	IAS AT 50 FT	AT SEA LEVEL & 59°		AT 2500 FT. & 50° F		AT 5000 FT. & 41° F		AT 7500 FT. & 32° F	
			WATER RUN	TO CLEAR 50' OBS.	WATER RUN	TO CLEAR 50' OBS.	WATER RUN	TO CLEAR 50' OBS.	WATER RUN	TO CLEAR 50' OBS.
1700	0	53	805	1260	985	1515	1215	1840	1530	2300
	15		425	745	535	915	670	1130	870	1440
	30		135	350	210	445	280	575	385	760
1950	0	56	1135	1715	1405	2105	1750	2625	2240	3390
	15		625	1045	775	1290	1010	1665	1320	2190
	30		255	520	345	675	460	895	635	1230
2220	0	60	1620	2390	2020	3010	2570	3900	3360	5370
	15		930	1505	1190	1940	1545	2560	2070	3625
	30		420	800	565	1070	770	1470	1070	2170

Note INCREASE DISTANCES 10% FOR EACH 25° F ABOVE STANDARD TEMPERATURE FOR PARTICULAR ALTITUDE.

CLIMB DATA

GROSS WEIGHT POUNDS	AT SEA LEVEL & 59° F			AT 5000 FT. & 41° F			AT 10,000 FT. & 23° F			AT 15,000 FT & 5° F		
	BEST CLIMB IAS MPH	RATE OF CLIMB FPM	GALS. FUEL USED	BEST CLIMB IAS MPH	RATE OF CLIMB FPM	GALS. FUEL USED	BEST CLIMB IAS MPH	RATE OF CLIMB FPM	GALS. FUEL USED	BEST CLIMB IAS MPH	RATE OF CLIMB FPM	GALS. FUEL USED
1700	58	930	1.0	55	690	2.1	54	445	3.3	53	210	5.6
1950	62	730	1.0	61	510	2.4	59	290	4.1	58	70	7.6
2220	66	550	1.0	65	350	2.9	61	145	5.6	-	-	-

Note FLAPS UP, FULL THROTTLE, MIXTURE LEANED FOR SMOOTH OPERATION ABOVE 5000 FT. FUEL USED INCLUDES WARM-UP AND TAKE-OFF ALLOWANCE.

Figure 7-2.

FLOATPLANE CRUISE PERFORMANCE

STANDARD ATMOSPHERE CONDITIONS GROSS WEIGHT 2220 POUNDS
ZERO WIND 39 GALLONS OF FUEL

CRUISE PERFORMANCE WITH RICH MIXTURE

ALTITUDE	RPM	%BHP	TAS, MPH	GAL./ HOUR	ENDR. HOURS	MILES/ GAL.	RANGE STA. MILES
2500	2700	84	104	10.7	3.6	9.7	380
	2600	75	99	9.7	4.0	10.2	400
	2500	67	94	8.8	4.4	10.7	415
	2400	59	89	8.0	4.9	11.1	435
	2300	52	83	7.2	5.4	11.5	450
	2200	47	78	6.6	5.9	11.7	455
	2100	42	72	6.1	6.4	11.8	460
5000	2700	78	103	10.5	3.7	10.2	380
	2600	70	98	9.6	4.1	10.2	400
	2500	62	93	8.7	4.5	10.7	415
	2400	55	87	7.9	4.9	11.1	430
	2300	50	82	7.3	5.4	11.2	440
	2200	45	76	6.7	5.8	11.3	440
	2100	40	70	6.2	6.3	11.3	440

CRUISE PERFORMANCE WITH LEAN MIXTURE

ALTITUDE	RPM	%BHP	TAS, MPH	GAL./ HOUR	ENDR. HOURS	MILES/ GAL.	RANGE STA. MILES
2500	2700	84	104	10.7	3.7	9.7	380
	2600	75	99	9.5	4.1	10.4	405
	2500	67	94	8.5	4.6	11.1	430
	2400	59	89	7.5	5.2	11.8	460
	2300	52	83	6.7	5.9	12.5	490
	2200	47	77	6.0	6.6	13.0	510
	2100	42	72	5.3	7.3	13.5	525
5000	2700	78	103	9.9	3.9	10.4	405
	2600	70	98	8.9	4.4	11.0	430
	2500	62	93	7.9	4.9	11.7	460
	2400	55	87	7.0	5.5	12.4	485
	2300	50	82	6.3	6.2	13.0	505
	2200	45	76	5.6	6.9	13.4	525
	2100	40	70	5.1	7.6	13.7	535
7500	2700	72	102	9.2	4.3	11.1	415
	2600	65	96	8.2	4.8	11.7	455
	2500	58	91	7.4	5.3	12.4	485
	2400	52	85	6.6	5.9	13.0	505
	2300	47	80	5.9	6.6	13.4	525
	2200	42	74	5.4	7.2	13.7	535
	2100	39	69	5.0	7.9	13.9	540
10,000	2700	67	100	8.5	4.6	11.8	460
	2600	60	95	7.7	5.1	12.3	480
	2500	54	89	6.9	5.7	12.9	505
	2400	49	83	6.2	6.3	13.4	520
	2300	45	78	5.7	6.9	13.7	535
	2200	41	73	5.2	7.5	13.9	540
	2100	38	69	4.9	8.0	14.1	550
12,500	2700	62	98	7.9	4.9	12.5	485
	2600	56	92	7.1	5.5	13.0	505
	2500	51	87	6.5	6.0	13.4	520
	2400	47	81	5.9	6.6	13.7	535
	2300	43	76	5.5	7.1	13.9	540
	2200	40	71	5.1	7.7	14.0	545

Figure 7-3.

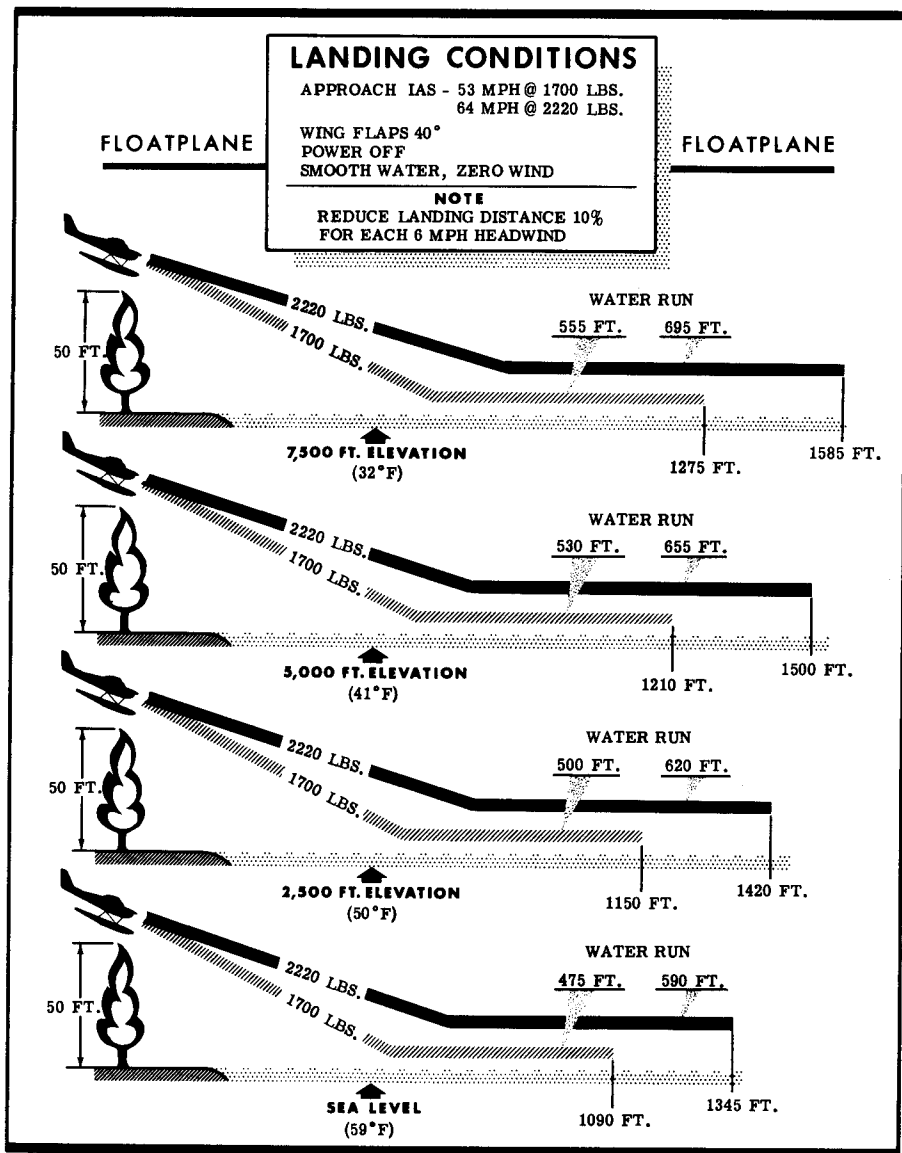

Figure 7-4.

POWER OFF	FLOATPLANE <i>Stalling Speeds</i>	MPH TIAS			
		ANGLE OF BANK			
<i>Gross Weight</i> 2220 lbs.		0°	20°	40°	60°
CONDITION					
FLAPS UP		59	61	67	83
FLAPS 10°		54	56	62	77
FLAPS 40°		52	54	59	74

Figure 7-5.

AUXILIARY FUEL TANK SYSTEM

An optional auxiliary fuel tank system (figure 7-6) is available to increase the airplane operating range. System components include an 18 gallon fuel tank (17.55 gallons usable) installed on the baggage compartment floor, an electric fuel transfer pump behind the tank, an electrically-operated fuel quantity indicator and fuel transfer pump switch on the instrument panel, a fuel tank filler provision on the right side of the fuselage, a fuel tank sump drain valve at the front of the tank on the bottom of the fuselage, and the necessary plumbing.

The auxiliary fuel system is connected to the right main fuel tank plumbing above the right cabin door.

AUXILIARY FUEL SYSTEM OPERATION.

To operate the auxiliary fuel system, proceed as follows:

Prior to flight:

- (1) Turn on master switch and check fuel quantity indicator for reading.
- (2) Momentarily pull on transfer pump switch and listen for pump operation. Turn off master switch.
- (3) Check quantity of fuel in tank for agreement with fuel quantity indicator. Fill tank for anticipated requirements.
- (4) Drain small amount of fuel from fuel tank drain valve to check for possible water and sediment.

During flight:

- (1) Take-off, climb, and land with

fuel selector valve handle set "BOTH ON" for maximum safety.

(2) After leveling off at cruise altitude, switch to "RIGHT TANK" and operate from this tank until the fuel supply is exhausted.

(3) Switch to "LEFT TANK" for operation, then pull on transfer pump switch and refill right main fuel tank from auxiliary tank. Push transfer pump switch to "OFF" when fuel transfer is completed.

NOTE

Transfer of fuel will take from 45 minutes to 1 hour.

(4) Return fuel selector valve handle to "BOTH ON" position after refilling right tank, or if desired, switch again to right main tank.

IMPORTANT

Do not operate the transfer pump with the fuel selector turned to either "BOTH" or "RIGHT TANK" positions after fuel transfer has been completed, as total or partial engine stoppage will result from air being pumped into fuel lines. If the pump should accidentally be turned on with the fuel selector in either of these positions, and engine stoppage occurs, the engine will restart in from 3 to 5 seconds after turning off the transfer pump as the air in the fuel line will be evacuated rapidly.

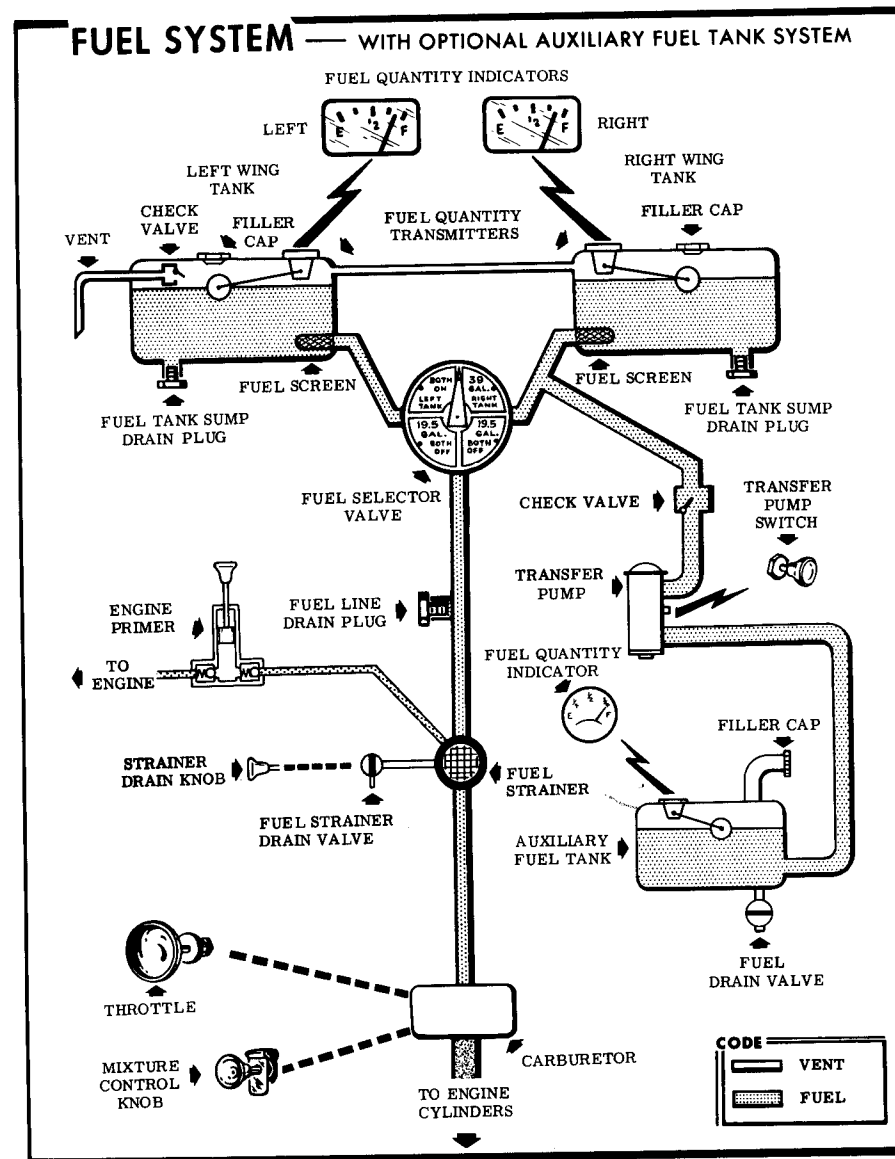

Figure 7-6.

Notes

ALPHABETICAL INDEX

A

After Landing, 2-3
 floatplane, 7-3
 Air Filters, Gyro Instruments, 5-8
 Airplane File, 5-5
 Airspeed Correction Table, 6-1
 floatplane, 7-7
 Airspeed Limitations, 4-2
 Aluminum Surfaces, 5-2
 Ammeter, 1-5
 Authorized Operations, 4-1
 Auxiliary Fuel Tank System, 7-12
 operation, 7-12
 schematic, 7-13

B

Buggage, Weight, inside cover page
 Battery, 1-5, 5-9
 solenoid, 1-5
 Before Entering Airplane, 2-1
 floatplane, 7-2
 Before Landing, 2-3
 floatplane, 7-3
 Before Starting Engine, 2-1
 floatplane, 7-3
 Before Take-Off, 2-2, 3-4
 Brake Operation, Parking, 1-7
 Brake System, 1-6
 master cylinders, 5-8
 Button, Starter, 1-2, 1-5

C

Cabin Heating and Ventilating
 System, 1-6
 Cabin Ventilators, 1-8

Capacity, Fuel, inside cover page
 Carburetor, 1-3
 Carburetor Air Filter, 5-9
 Carburetor Air Heat Knob, 1-1
 Care,
 interior, 5-4
 propeller, 5-3
 Center of Gravity Moment
 Envelope, 4-4
 floatplane, 7-6
 Check, Preflight, 3-1
 Climb, 2-2, 3-5
 data, 6-2
 floatplane, 7-3, 7-4, 7-8
 maximum performance, 2-2
 normal, 2-2
 Clock, 1-5
 Cold Weather Operation, 3-7
 Control Knob, Mixture, 1-1, 1-3
 Controls, Engine, 1-1
 Crosswind Take-off, Floatplane, 7-4
 Cruise and Range Performance, 6-3
 floatplane, 7-9
 Cruising, 2-3, 3-5
 floatplane, 7-4

D

Data, Climb, 6-2
 floatplane, 7-8
 Data, Fuel Quantity, 1-2
 Data, Landing, 6-4
 floatplane, 7-10
 Data, Take-off, 6-2
 floatplane, 7-8
 Dealer Follow-up System, 5-6
 Diagram,
 exterior inspection, 1-10
 landing, 6-4

servicing, 5-7
 taxiing, 3-2
 Dimensions,
 internal cabin, 1-9
 principal, iv
 Drain Knob, Fuel Strainer, 1-3, 1-4
 Drain Plug, Fuel Line, 1-3, 5-8
 Drain Plugs, Fuel Tank
 Sump, 1-3, 5-8
 Drain Valves, Fuel Tank Sump, 5-7

E

Electrical System, 1-4
 battery, 1-5, 5-9
 battery solenoid, 1-5
 fuses, 1-4
 generator, 1-5
 generator warning light, 1-5, 1-6
 power distribution diagram, 1-5
 voltage regulator, 1-5
 Empty Weight, inside cover page
 Engine, inside cover page
 before starting, 2-1
 controls, 1-1
 instrument markings, 4-2
 operation limitations, 4-2
 primer, 1-3
 starting, 2-1, 3-1
 Envelope, Weight and Balance, 4-4
 Exterior Inspection Diagram, 1-10

F

File, Airplane, 5-5
 Floatplane, 7-1
 after landing, 7-3
 airspeed correction table, 7-7
 before entering, 7-2
 before landing, 7-3

before starting, 7-3
 center of gravity moment
 envelope, 7-6
 climb, 7-3, 7-4, 7-8
 crosswind take-off, 7-4
 cruise, 7-4, 7-9
 landing, 7-3, 7-10
 loading graph, 7-6
 minimum run take-off, 7-4
 normal take-off, 7-3, 7-4
 sample loading problem, 7-5
 stall speeds, 7-11
 take-off, 7-3, 7-4, 7-8
 taxiing, 7-3
 water rudder steering
 system, 7-1
 weight and balance, 7-5
 Fuel Specification and Grade, 5-7
 Fuel System, 1-2
 capacity, inside cover page
 line drain plug, 1-3, 5-8
 quantity data, 1-2
 quantity indicators, 1-3, 1-4
 quantity transmitters, 1-3
 schematic, 1-3
 selector valve, 1-2, 1-3, 1-4
 strainer drain knob, 1-3, 1-4
 strainer, 1-3, 5-8
 tank fillers, 1-3, 5-8
 tank sump drains, 1-3, 5-8
 Fuses, 1-4

G

Generator, 1-5
 Generator Warning Light, 1-5, 1-6
 Gross Weight, inside cover page
 Ground Handling, 5-1
 Ground Service Receptacle, 1-5, 5-8
 Gyro Instrument Air Filters, 5-8

H

Handle, Starter, 1-1, 1-5
 Heating and Ventilating System, 1-6

I

Ignition-Starter Switch, 1-2, 1-5
 Indicator,
 fuel quantity, 1-3, 1-4
 stall warning, 1-6
 Inspection Diagram, Exterior, 1-10
 Inspection Service-Periods, 5-4
 Instrument Markings, 4-2
 Interior Care, 5-4
 Internal Cabin Dimensions, 1-9

K

Knob,
 carburetor air heat, 1-1
 engine primer, 1-3
 fuel strainer drain, 1-3, 1-4
 mixture control, 1-1, 1-3
 parking brake, 1-7

L

Landing, inside cover page, 3-6
 after, 2-3
 before, 2-3
 diagram, 6-4
 floatplane, 7-3, 7-10
 normal, 2-3
 Let-Down, 2-3
 Light,
 generator warning, 1-5, 1-6
 landing, 1-6

Limitations, Airspeed, 4-2
 Limitations, Engine Operating, 4-2
 Loading Graph, 4-4
 floatplane, 7-6
 Loading Problem, Sample, 4-5
 floatplane, 7-5
 Lubrication and Servicing, 5-6

M

Maneuvers, Normal Category, 4-1
 Maneuvers, Utility Category, 4-1
 Master Switch, 1-5
 Maximum Performance Climb, 2-2
 Maximum Performance
 Take-off, 2-2
 Minimum Run Take-off, Float-
 plane, 7-4
 Mixture Control Knob, 1-1, 1-3
 Mooring Your Airplane, 5-1

N

Normal Category, Maneuvers, 4-1
 Normal Climb, 2-2
 Normal Landing, 2-3
 Normal Take-off, 2-2
 floatplane, 7-3, 7-4
 Nose Gear,
 shock strut, 5-9
 torque links, 5-9

O

Oil Specification and Grade, 5-7
 Oil System, 1-4
 capacity, inside cover page
 oil filler and dipstick, 5-10

oil screen, 5-10
 sump drain, 5-9
 Operating Limitations, Engine, 4-2
 Operation, Auxiliary Fuel
 Tank System, 7-12
 Operation, Cold Weather, 3-7
 Operation, Parking Brake, 1-7
 Operations Authorized, 4-1

P

Painted Surfaces, 5-3
 Parking Brake Operation, 1-7
 Performance, Specifications,
 inside cover page
 Power Loading, inside cover page
 Pre-Flight Check, 3-1
 Primer, Engine, 1-3
 Principal Dimensions, iv
 Propeller, inside cover page
 care, 5-3

Q

Quantity Data, Fuel 1-2
 Quantity Indicators, Fuel, 1-3, 1-4
 Quantity Transmitters, Fuel, 1-3

R

Range, inside cover page
 Range and Cruise Performance, 6-3
 floatplane, 7-9
 Rate of Climb, inside cover page
 Receptacle, Ground Service, 1-5,
 5-8
 Retraction Handle, Water
 Rudder, 7-2

Index-4

S

Sample Loading Problem, 4-5
 floatplane, 7-5
 Schematic, Auxiliary Fuel
 Tank System, 7-13
 Schematic, Fuel System, 1-3
 Selector Valve, Fuel, 1-2, 1-3, 1-4
 Service Ceiling, inside cover page
 Servicing Diagram, 5-7
 Servicing Procedures, 5-8
 Shimmy Dampener, 5-9
 Shock Strut, Nose Gear, 5-9
 Speed, inside cover page
 Stall Warning Indicator, 1-6
 Stalling Speeds, 6-5
 floatplane, 7-11
 Stalls, 3-6
 Starter, 1-5
 Starter-Ignition Switch, 1-2, 1-5
 Starter Handle, 1-1, 1-5
 Starting Engine, 2-1, 3-1
 Steering System, Water Rudder, 7-1
 Storage, 5-2
 Strainer Drain Knob, Fuel, 1-3, 1-4
 Suction Relief Valve Inlet
 Screen, 5-10
 Sump Drain Plugs, Fuel Tank,
 1-3, 5-8
 Sump Drain Valves, Fuel Tank, 5-7
 Surfaces,
 aluminum, 5-2
 painted, 5-3
 Switch, Master, 1-5

T

Table of Contents, iii
 Take-off, inside cover page,
 2-2, 3-4
 before, 2-2, 3-4
 data, 6-2

Ventilators, Cabin, 1-8
 Voltage Regulator, 1-5

W

Water Rudder Retraction
 Handle, 7-2
 Water Rudder Steering System,
 Floatplane, 7-1
 Warning Light, Generator, 1-5, 1-6
 Weight,
 empty, inside cover page
 gross, inside cover page
 Weight and Balance, 4-3
 floatplane, 7-5
 loading graph, 4-4
 moment envelope, 4-4
 sample loading problem, 4-5
 Wheel Bearings, 5-8
 Windshield and Windows, 5-2

U

Utility Category, Maneuvers, 4-1

V

Vacuum System Oil Separator, 5-10
 Valve, Fuel Selector, 1-2, 1-3, 1-4

floatplane, 7-3, 7-4, 7-8
 maximum performance, 2-2
 normal, 2-2
 Taxiing, 3-3
 diagram, 3-2
 floatplane, 7-3
 Throttle, 1-1, 1-3
 Tie-down Procedure, 5-1
 Tires, 5-8

Index-5

Aircraft Weight and Balance Revision

Tail Number: N1528Y	Date: Feb 15, 2011
Prepared by: SAE Aviation 5022 Central Pkwy Conroe Tx 77303	Work Order No:
	Type Certificate Data No:

Aircraft Make: C172C	Model: 172	Serial No: 17249228	Time: 2934
Registered Owner: Guy Grumbles		Address: 3410 Fir Forest Dr Spring Tx 77388	

Maximum Weight 2220	CG Range	FWD	AFT
As Received; Date of Previous Weight and Balance: May 14, 1994	Useful Load: 832.5	EW: 1367.5	EWCG: 36.0
Moment: 52725.0			

Notes:

Description	Weight	Arm	Moment
Removed unknown, unused nav equipment	-7.25	0.1	-0.73
	0.00	0.00	0.00
	0.00	0.00 ^W	0.00
	0.00	0.00	0.00
	0.00	0.00	0.00
	0.00	0.00	0.00
	0.00	0.00	0.00
	0.00	0.00	0.00
	0.00	0.00	0.00
	0.00	0.00	0.00
	0.00	0.00	0.00
	0.00	0.00	0.00
	0.00	0.00	0.00
	0.00	0.00	0.00

<input checked="" type="checkbox"/> As Calculated <input type="checkbox"/> As Weighed	Moment	52724.28	New Empty Weight CG	38.20	New Useful Load
	Weight	1360.25			
Signature Scott Egisdahl 					
Repair Agency or License No: A&P3515858					

SAMPLE LOADING PROBLEM	Sample Airplane		Your Airplane	
	Weight (lbs)	Moment (lb - ins. /1000)	Weight	Moment
1. Licensed Empty Weight (Sample Airplane) ...	1305.5	49.5		
2. Oil - 8 Qts.*	15.0	-0.3	15.0	-0.3
3. Pilot & Front Passenger	340.0	12.2		
4. Fuel (22.5 Gal at 6#/Gal)	135.0	6.5		
5. Rear Passengers	340.0	23.8		
6. Baggage (or Passenger on Auxiliary Seat)	114.5	10.9		
7. Total Aircraft Weight (Loaded)	2250.0	102.6		

8. Locate this point (2250 at 102.6) on the center of gravity envelope, and since this point falls within the envelope the loading is acceptable.

*Note: Normally full oil may be assumed for all flights.

