



**ROOTT**

Catalogo Prodotti  
2022-2023

Welcome to



Experience



High quality and safety standards

Operiamo un sistema di gestione della qualità basato sulla norma EN ISO 13485:2016. I prodotti dell'azienda sono certificati in conformità alle disposizioni della Direttiva Europea 93/42/CEE.

# Indice

1	Risultati clinici
3	TRATE International
6	Garanzia ROOTT
7	Superficie Bioattiva
8	Impianto ROOTT R
14	Protesica ROOTT R
30	Impianto ROOTT M
32	Impianto ROOTT P
38	Protesica ROOTT M
38	Protesica ROOTT P
42	Impianto ROOTT S
46	Protesica ROOTT S
50	Impianto ROOTT C
54	Protesica ROOTT C
57	Strumenti
67	Cassetta chirurgica
68	Digital Solution
76	Informazioni

# 5 anni di eccellenti risultati clinici con gli impianti ROOTT

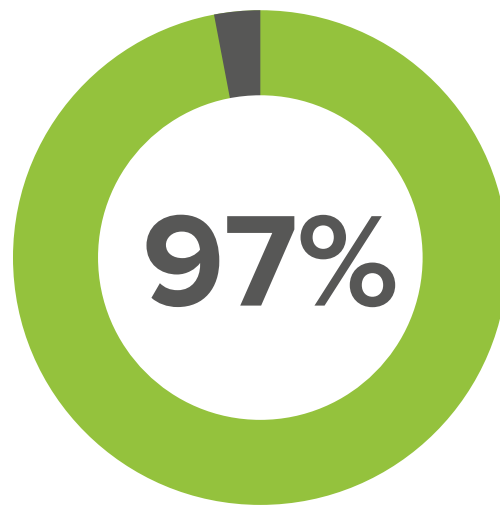

## Tasso medio di sopravvivenza

Lo studio di follow-up clinico post commercializzazione ha mostrato un tasso di sopravvivenza medio, dei sistemi implantari ROOTT, significativamente elevato, pari al 97,86%

Report del 24-05-2021

### **Elevati standard di qualità e sicurezza**

I dispositivi medici presenti in questo catalogo sono conformi alla vigente normativa UE.



## Confidenza con l'approccio tradizionale



CEMENTATA



AVVITATA



TELESCOPICA

**ROOTT R**



## Alternative poco invasive



CEMENTATA



AVVITATA



TELESCOPICA

**ROOTT** **M** **P**  
**S** **C**

# WE IMPLANTS

International Network

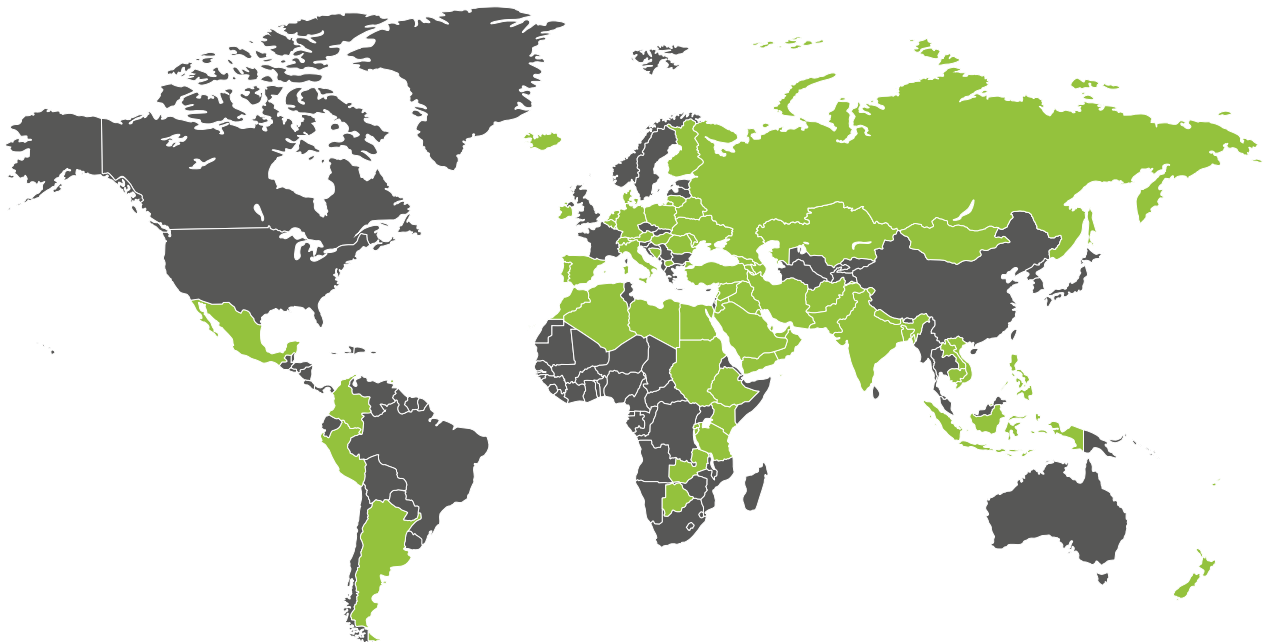

**70+**  
DISTRIBUTORI

**10+**  
FILIALI

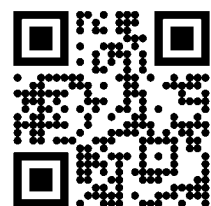

## Dieci traguardi di TRATE in dieci anni

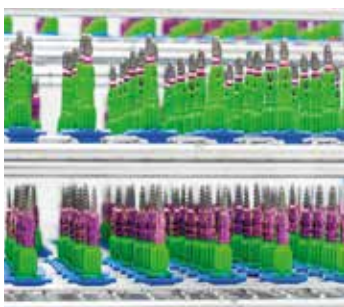

- Oltre 1,1 milioni di impianti inseriti.
- Più di 100 dipendenti dedicati.
- 11 filiali internazionali, 71 distributori e una comunità di oltre 25.000 medici che credono nei nostri prodotti.
- La varietà di oltre 1000 prodotti di facile utilizzo e 9 categorie di impianti ROOTT con sovrastrutture e strumenti chirurgici associati.
- Open Dental Community, professionisti dell'odontoiatria implantare che offrono formazione di qualità, competenza internazionale ed eccellenza.
- Oltre 50 eventi educativi in Germania, Dubai, Italia, Spagna, Svizzera, Olanda, India, Austria ed altri paesi.
- Eccellente servizio clienti pronto a fornire un'assistenza completa e creare partnership con garanzia internazionale dei prodotti.
- TRATE è presente in 15 International Dental Expos.
- La struttura di più di 3000 mq è dedicata per metà alla produzione e, per la restante parte ad uffici amministrativi e di ricerca.
- La politica del prezzo equo e la qualità dei prodotti coinvolgono un pubblico sempre più ampio a livello internazionale.

# TRATE



## Affidabili, efficienti, sicuri

Realizziamo i nostri prodotti con materiali e procedure nel rispetto delle più severe normative internazionali, per garantire ai nostri clienti prodotti premium, SEMPRE.

Il **titanio** utilizzato per la costruzione degli impianti ROOTT è fornito dalla **Zapp AG (Germania)**, produttore leader di leghe medicali, fornitore globale di fiducia per l'industria medica.

Risponde ai requisiti normativi **ISO 5832-3** Lega di titanio **Ti6Al4V ELI (Grado 23)**.

Il nostro processo di pulizia e confezionamento in camera bianca risponde a tutti i requisiti normativi **ISO Classe 6 (ISO-14644)** e viene effettuata all'interno dei nostri siti produttivi.

Solo dopo un accurato controllo dei processi produttivi e di pulizia, gli impianti dentali ROOTT vengono inviati al processo di sterilizzazione che viene effettuato da **BBF Sterilisations-service GmbH (Germania)**, un fornitore leader per la sterilizzazione gamma e l'analisi microbiologica dei dispositivi medici.



Entrambi i fornitori sono convalidati dall'ente di accreditamento nazionale tedesco **DAkkS** e certificati secondo **ISO 9001**, **ISO 13485**, **ISO 11137** e **ISO 11607-1** per fornire la sterilizzazione gamma, servizi di analisi di laboratorio microbiologico e convalida degli imballaggi.



Life Time  
Warranty



## Garanzia

É GARANTITO CHE CON GLI IMPIANTI **ROOTT** I VOSTRI PAZIENTI SARANNO FELICI A LUNGO

I sistemi implantari **ROOTT** rappresentano una soluzione premium in Europa e nel mondo nell'ambito dell'odontoiatria moderna che garantisce affidabilità e durata al di sopra dei normali standard.

### **Ve lo possiamo garantire!**

Siamo talmente sicuri della qualità di tutti i nostri sistemi, che i prodotti non utilizzati possono essere cambiati con altri prodotti di valore uguale o superiore, entro dodici mesi dalla data di fatturazione.

## Condizioni di garanzia

Gli impianti **ROOTT** sono garantiti a vita.

TRATE AG garantisce la sostituzione con un prodotto uguale o equivalente.

## Come fruire della Garanzia

Per beneficiare dei vantaggi della garanzia, il clinico deve comunicare con il distributore di riferimento TRATE Italia o direttamente con il produttore TRATE AG attraverso il modulo dedicato, scaricabile dal sito internet, debitamente compilato in tutte le sue parti.

### ATTENZIONE

Per poter fruire della garanzia leggere attentamente il regolamento e le condizioni previste, consultabili sui siti:

- [www.trate.com](http://www.trate.com)
- [www.trateitalia.it](http://www.trateitalia.it)
- [www.roott.it](http://www.roott.it)

# Trattamento di Superficie Bioattiva



## SEM Implant Surface

### Surface Morphology

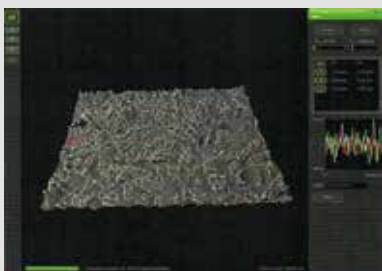

x 10.000 magnification

### Surface Morphology

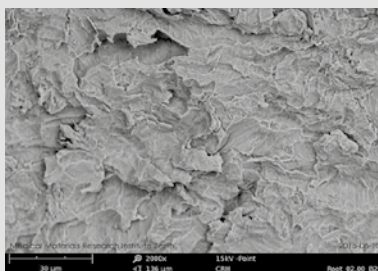

x 2.000 magnification

Test effettuati presso dedeMED

Medical Material Institute Research Berlin

### Quantitative elemental analysis

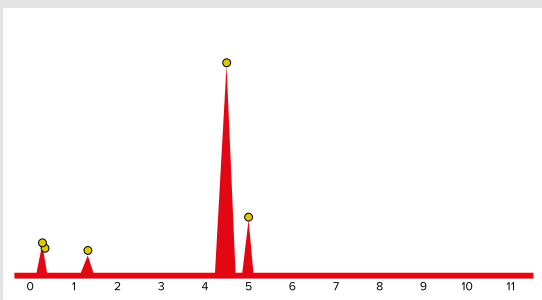

### Quantitative elemental analysis

	Atomic percentage	Certainty
Ti	87.4%	1.00
V	8.3%	0.98
Al	4.3%	0.98

Il dipartimento di Research and Development della TRATE AG in collaborazione con diverse università europee, ha sviluppato una superficie Bioattiva con un trattamento **Resorbable Blast Media (RBM)** e mordenzatura acida.

Per il processo di sabbiatura (RBM) viene utilizzata una miscela di idrossiapatite e trisfosfato di calcio (**HA/TCP**). Questo ha permesso di ottenere una topografia superficiale ideale con un valore **RA medio di 1.5 µm**.

Evidenze scientifiche hanno dimostrato come le caratteristiche della superficie, unitamente alla morfologia dell'impianto, favoriscono una risposta biologica ottimale dopo l'inserimento.

Questo garantisce la massima **attività osteogenica** in grado di stimolare una adeguata vascolarizzazione ossea, una rapida e maggiore formazione ossea, una importante riduzione del tempo di guarigione, garantendo anche una elevata stabilità nell'inserimento implantare post estrattivo.

# ROOTT R

Two-piece implant

Conical connection - All in One



Il titanio utilizzato per la costruzione degli impianti TRATE risponde ai requisiti normativi ISO 5832-3 Lega di titanio Ti6Al4V ELI (Grado 23).



10.3° conicità e esagono interno



Connessione Sicura



No microgap / No micromovimenti

## Stabilità Primaria



V Shape Design, Inserzione Efficiente, incremento dei valori BIC



Superficie Osteogenica RBM Sabbata HA/TCP e Acidificata



Spire Progressive, Migliore capacità di taglio, Condensazione Osso

## Nel Packaging

Contenuto:

- Prenditore manuale
- Vite di copertura
- Transfer per impronta
- Abutment Multifunzionale
- Impianto



Ampia gamma di diametri e lunghezze  
Unica connessione implantare

Ø: 3.0 - 5.5 mm  
L: 6 - 16 mm

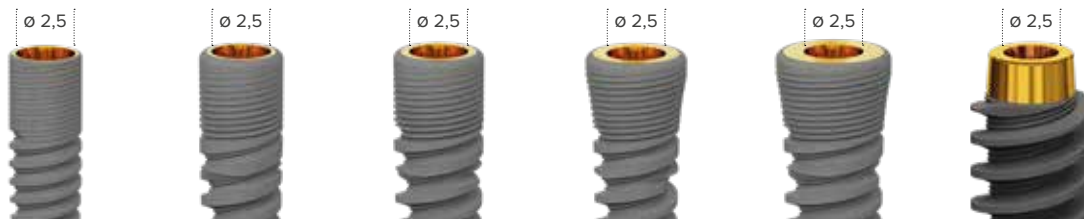

## Soluzioni protesiche

Libertà e flessibilità con lo switching platform e la connessione conica Morse per tutti i componenti protesici.



Tecnica Telescopica

## Abutment Multifunzionale

Incluso nel packaging

Realizzato in Ti6Al4V ELI (Grado 23).

### Può essere usato per

- Carrier per l'inserimento dell'impianto (fino a 40 N/cm)
- Abutment per carico immediato
- Abutment provvisorio
- Abutment definitivo
- Base per formatore gengivale individuale
- Scansione intraorale



# ROOTT **R**

M1.6x0.35 6H

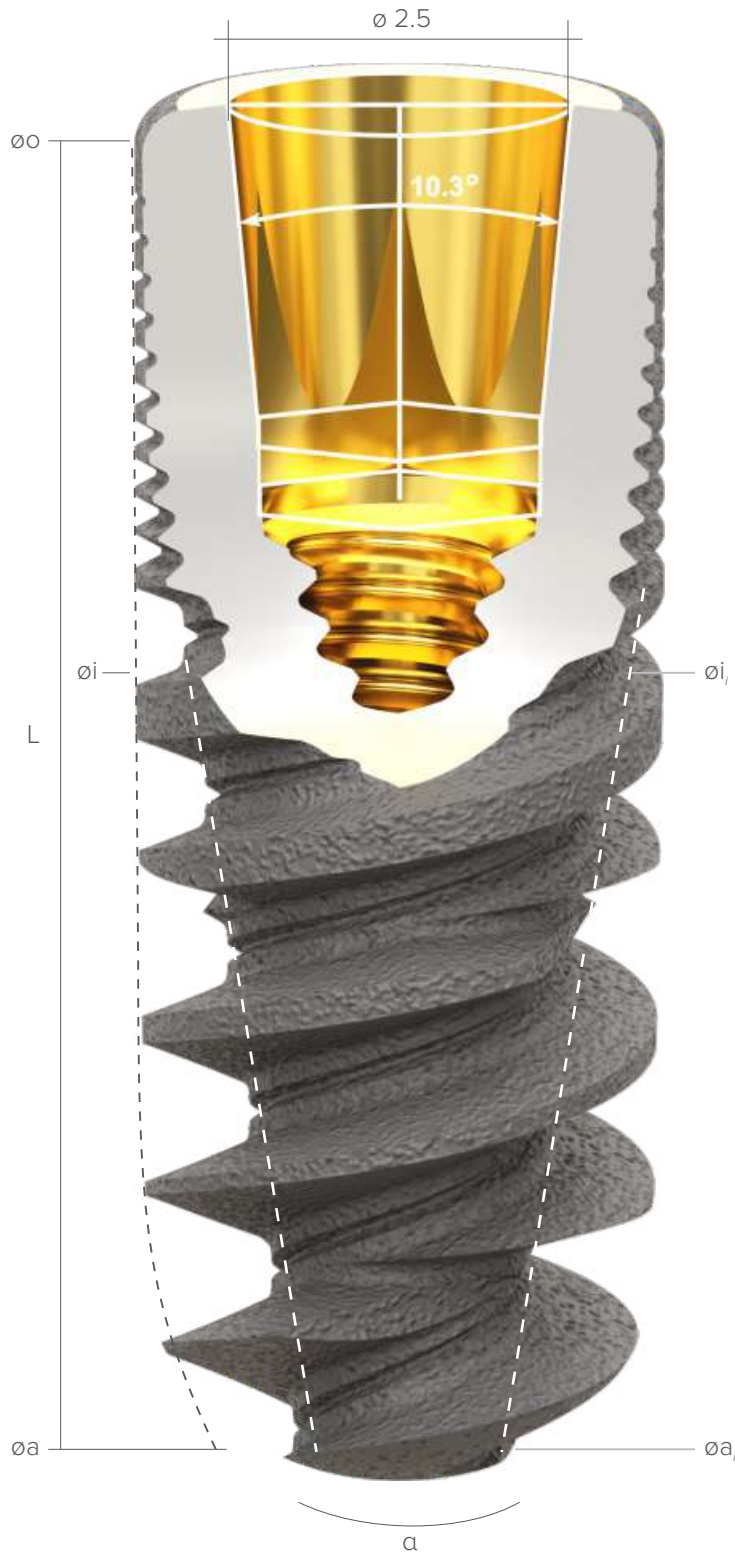

$o$  - diametro occlusale (mm);  $i$  - diametro intraosseo (mm);  $a$  - diametro apicale (mm);  
 $\alpha$  - angolo interno totale (gradi  $^\circ$ );  $s$  - area quadrata intraossea (mm<sup>2</sup>);  $i$  = interno

ø 3.0

ø 3.5

ø 3.8

ø 4.2

ø 4.8

o / L

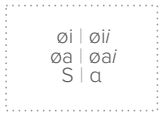

Ti6Al4V ELI

R3506

3.5 | 3.3  
3.4 | 1.8  
85 | 24



R3806

3.8 | 3.4  
3.7 | 1.6  
95 | 28



R4206

4.2 | 3.6  
4.1 | 1.9  
106 | 26.5



R4806

4.8 | 3.9  
3.6 | 1.8  
132 | 38.5



6 mm

R3508

3.5 | 3.3  
3.4 | 1.7  
111 | 20



R3808

3.8 | 3.4  
3.7 | 1.3  
128 | 21



R4208

3.6 | 3.2  
3.5 | 1.2  
125 | 21



R4808

4.8 | 3.9  
3.6 | 1.8  
179 | 38.5



8 mm

R3010

3.0 | 2.5  
2.8 | 1.4  
114 | 14



R3510

3.5 | 3.2  
3.3 | 0.8  
137 | 21



R3810

3.8 | 3.4  
3.6 | 1.2  
159 | 15



R4210

3.6 | 3.2  
3.4 | 1.2  
154 | 15



R4810

4.8 | 3.2  
1.4 | 1.0  
196 | 40



10 mm

R3012

3.0 | 2.5  
2.7 | 1.4  
137 | 10



R3512

3.4 | 3.2  
3.3 | 0.7  
164 | 17



R3812

3.7 | 3.4  
3.6 | 1.2  
190 | 12



R4212

3.5 | 3.2  
3.4 | 1.1  
182 | 12



R4812

4.8 | 3.2  
1.7 | 1.0  
248 | 40



12 mm

R3014

3.0 | 2.5  
2.5 | 1.4  
159 | 7.5



R3514

3.4 | 3.2  
3.2 | 0.7  
188 | 14



R3814

3.7 | 3.4  
3.5 | 1.1  
220 | 10



R4214

3.5 | 3.2  
3.3 | 1.1  
209 | 10



R4814

4.8 | 3.2  
1.7 | 1.0  
302 | 40



14 mm

R3016

2.9 | 2.4  
2.4 | 1.4  
178 | 6



R3516

3.3 | 3.2  
3.1 | 0.6  
215 | 12



R3816

3.6 | 3.4  
3.4 | 1.0  
249 | 9



R4216

3.4 | 3.2  
3.1 | 0.8  
234 | 10



R4816

4.8 | 3.2  
1.7 | 1.0  
355 | 40



16 mm

# ROOTT **R**



o - diametro occlusale (mm); i - diametro intraosseo (mm); a - diametro apicale (mm);  
 $\alpha$  - angolo interno totale (gradi  $^\circ$ ); s - area quadrata intraossea (mm<sup>2</sup>); i = interno

ø 5.5

ø 6.5

ø 7.5

ø 8.5

o / L

R5506

5.5 | 3.9  
4.1 | 1.8  
167 | 38.5



R6506

6.5 | 3.9  
4.1 | 1.8  
226 | 38.5



R7506

7.5 | 3.9  
4.1 | 1.8  
302 | 38.5



R8506

8.5 | 3.9  
4.1 | 1.8  
381 | 38.5



6 mm

R5508

5.5 | 3.9  
4.1 | 1.8  
230 | 38.5



R6508

6.5 | 4.0  
4.1 | 1.8  
317 | 38.5



R7508

7.5 | 4.0  
4.1 | 1.8  
431 | 38.5



R8508

8.5 | 4.0  
4.1 | 1.8  
550 | 38.5



8 mm

R5510

5.5 | 3.2  
1.7 | 1.0  
246 | 40



R6510

6.5 | 3.5  
3.8 | 1.0  
338 | 40



R7510

7.5 | 3.5  
3.8 | 1.0  
456 | 40



R8510

8.5 | 3.5  
3.8 | 1.0  
566 | 38.5



10 mm

R5512

5.5 | 3.2  
1.7 | 1.0  
315 | 40



R6512

6.5 | 3.5  
3.8 | 1.0  
435 | 40



R7512

7.5 | 3.5  
3.8 | 1.0  
591 | 40



R8512

8.5 | 3.5  
3.8 | 1.0  
741 | 40



12 mm

R5514

5.5 | 3.2  
1.7 | 1.0  
385 | 40



R6514

6.5 | 3.6  
3.8 | 1.0  
533 | 40



R7514

7.5 | 3.6  
3.8 | 1.0  
726 | 40



R8514

8.5 | 3.6  
3.8 | 1.0  
917 | 40



14 mm

R5516

5.5 | 3.2  
1.7 | 1.0  
454 | 40



16 mm

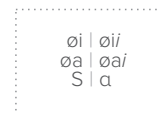

Ti6Al4V ELI



## Opzioni Protetiche per tecnica cementata e avvitata

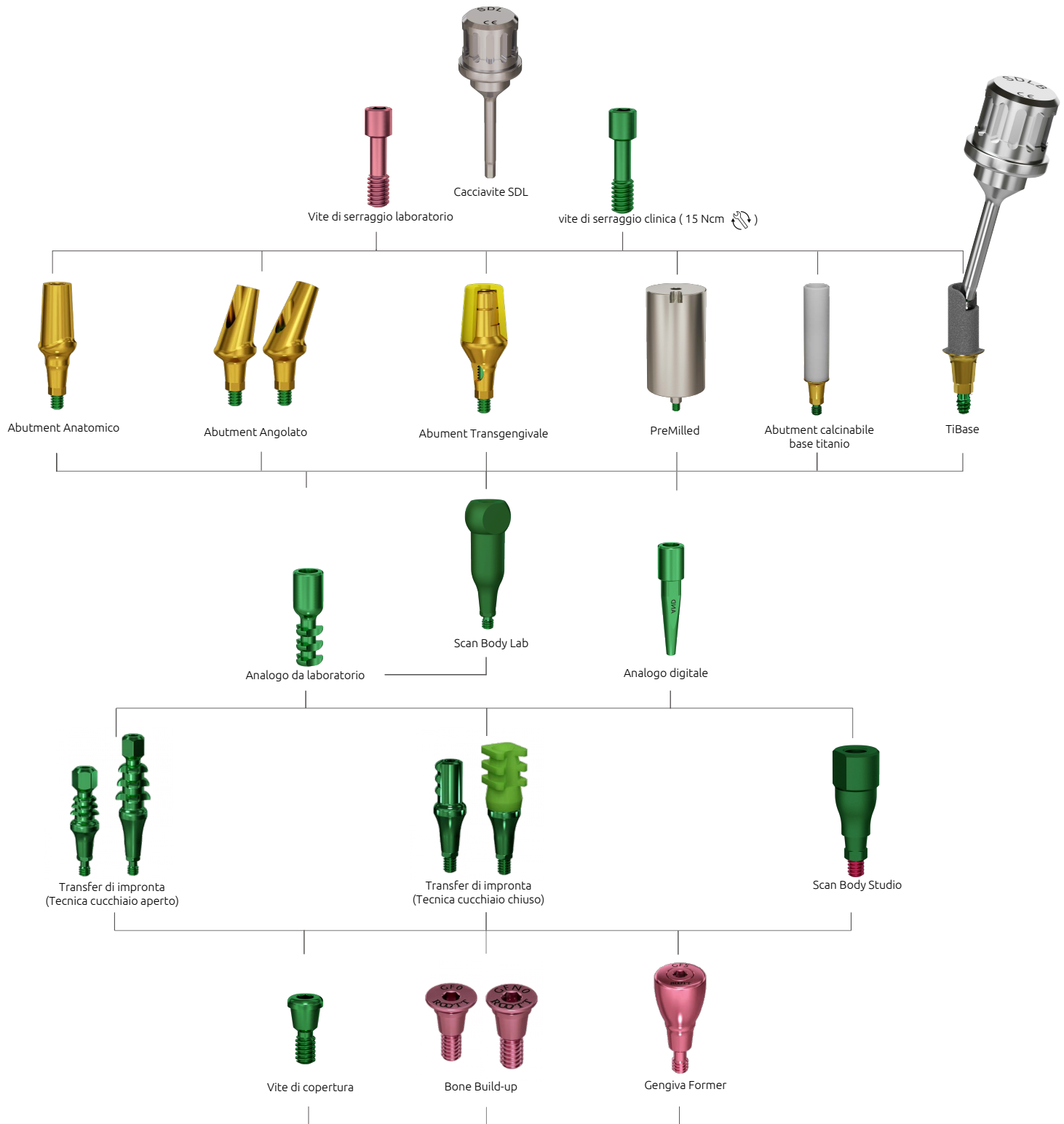

CRE

**Può essere usato per**

- Carrier per l'inserimento dell'impianto (fino a 40 N/cm)
- Abutment per carico immediato
- Abutment provvisorio
- Abutment definitivo
- Base per formatore gengivale individuale
- Scansione intraorale

# Healing abutments



Instructions

## Bone build-up



## Regular



## One-piece



# Transfers & implant analogs

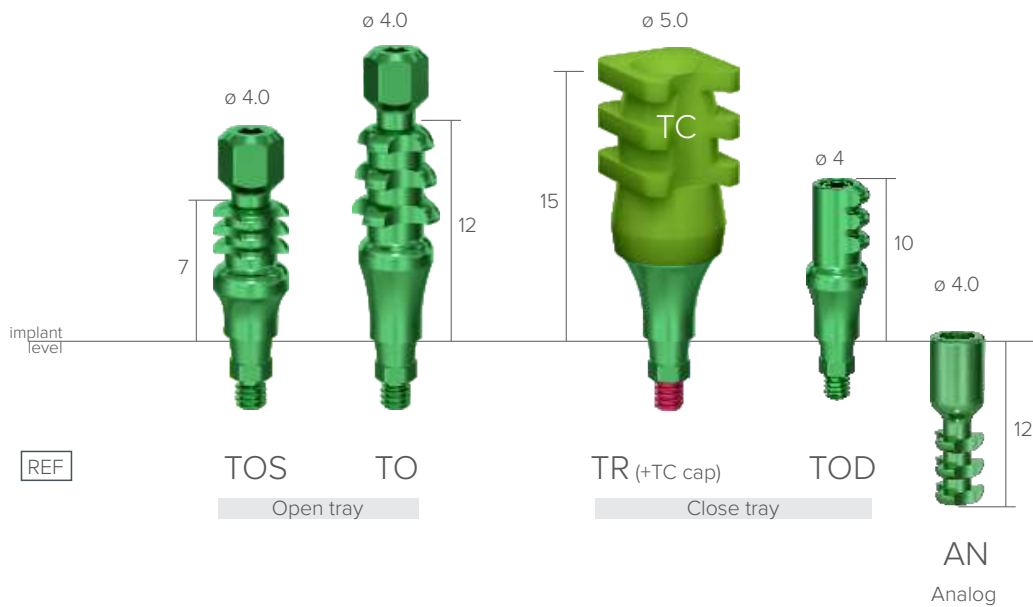

Instructions

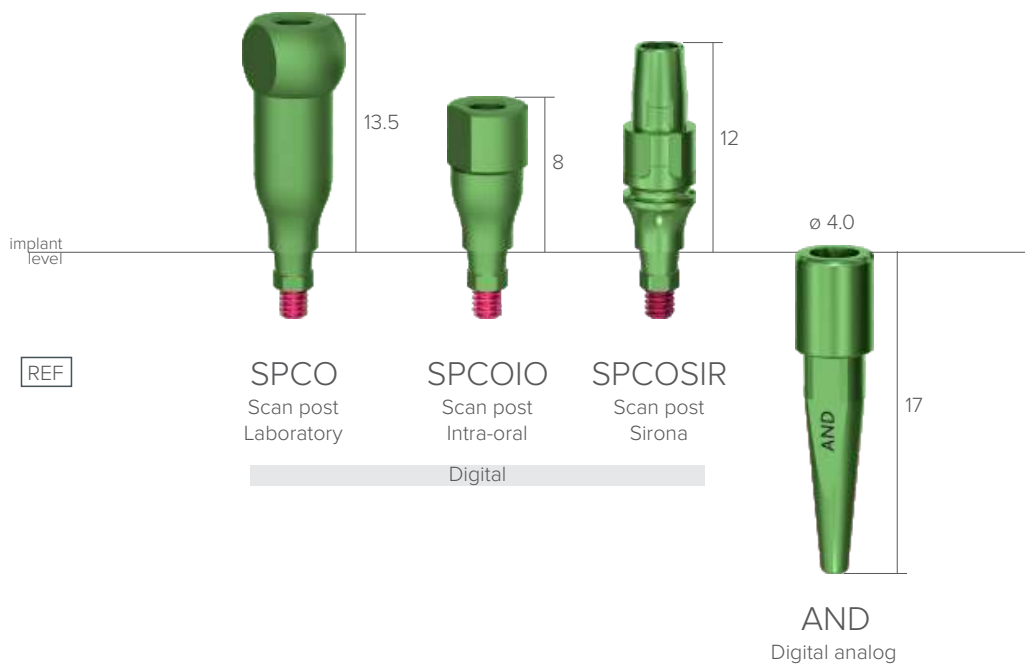

# Abutments



Instructions

## Straight anatomical abutments

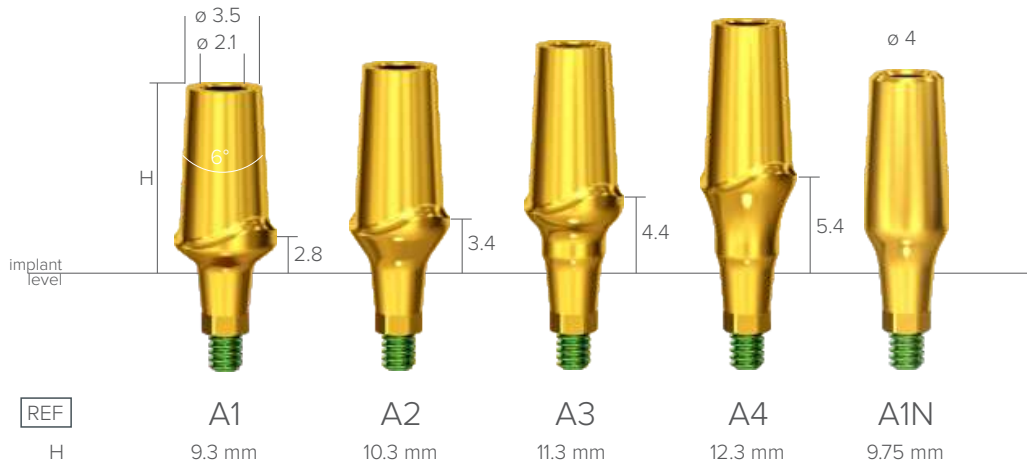

## 15° angled anatomical abutments

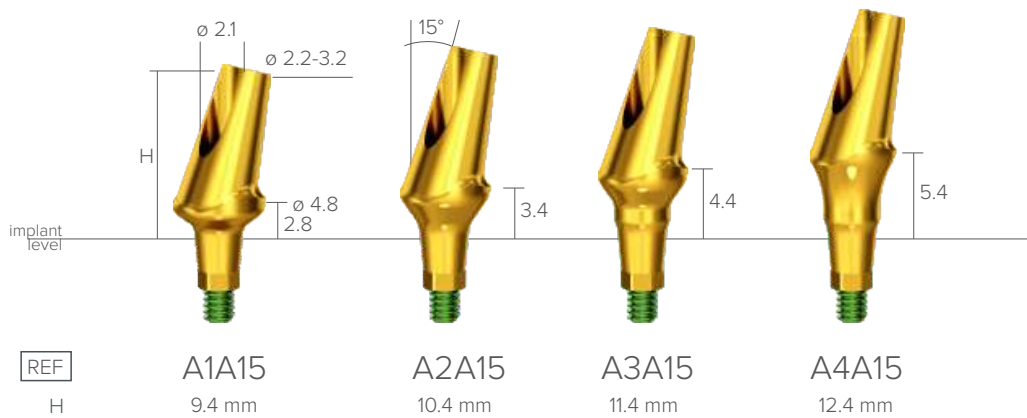

## 25° angled anatomical abutments

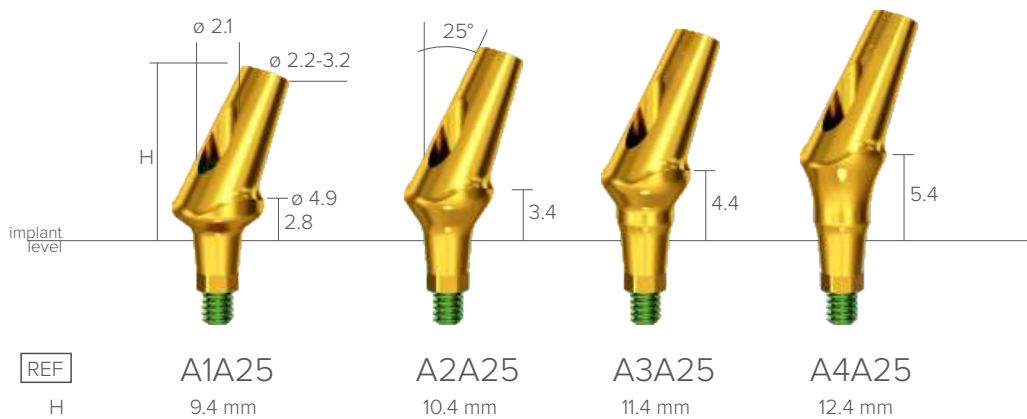

## Transgingival abutments

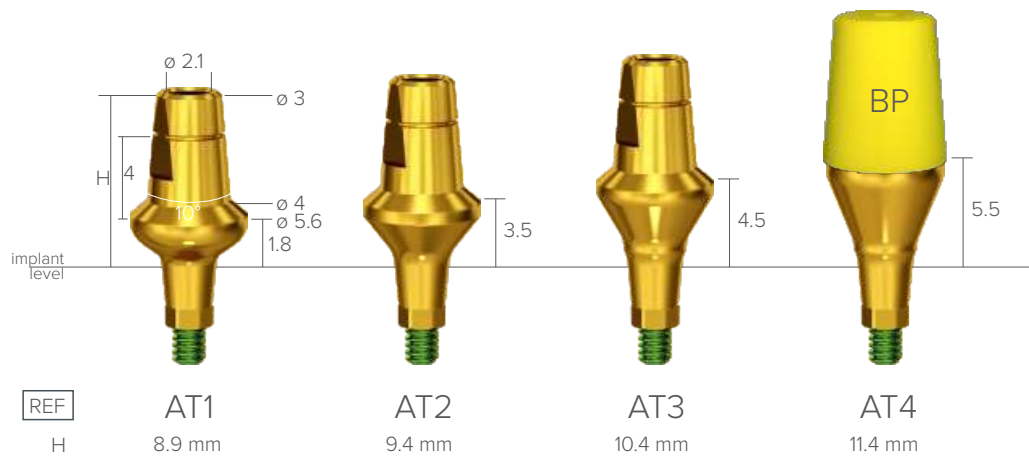

BP — free burn out part with each transgingival abutment

## How it works

Place BP cap on AT abutment



Adjust height by cutting



Use wax for modelling future crown



Fix crown to AT abutment



# Titanium base

## Regular

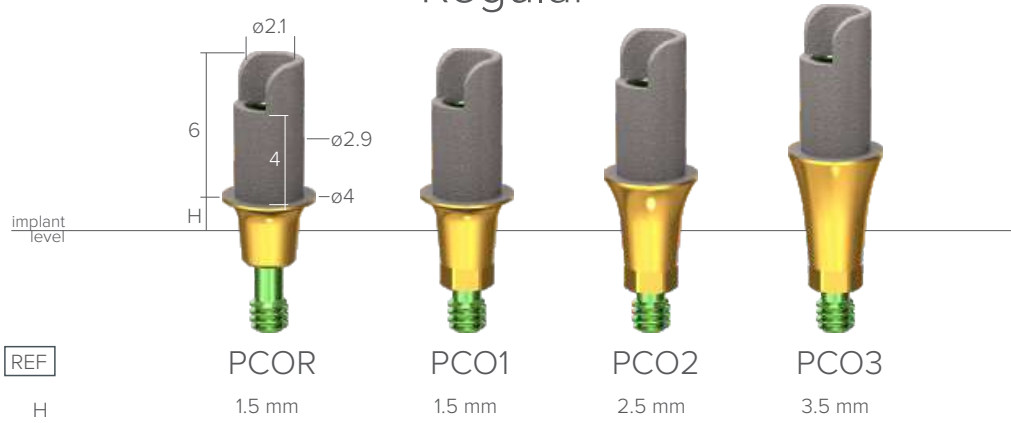

## Short



## For Sirona

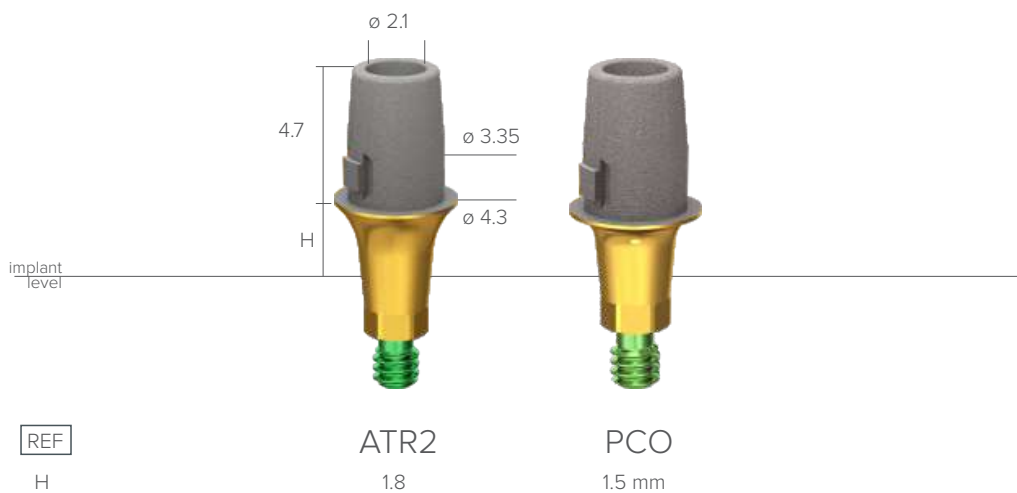

## Pre-milled abutments



PMAB  
Ø 11.5mm



PMABP  
PEEK  
Ø 11.5mm

## Burn-out abutments



AB

Burnout with  
positioning

Can be used with  
PCO1S...PCO3S



ABR

Burnout without  
positioning

Can be used with  
PCO1...PCO3,  
PCO1S...PCO3S



ABM

Burnout with  
titanium base



A1NP

Burnout straight,  
narrow

REF

## Opzioni Protetiche per tecnica conometrica



Cappette in PEEK

Cappette in Titanio



Abutment per tecnica conometrica  
Diritto

Abutment per tecnica conometrica  
angolato

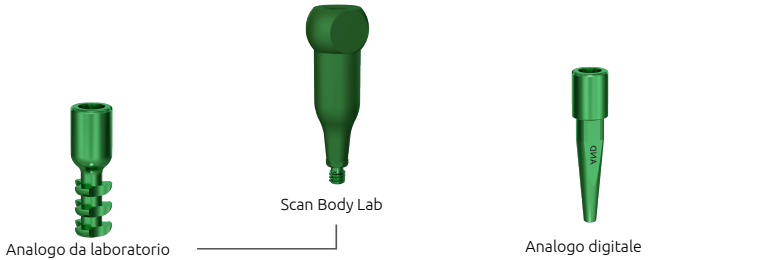

Analogo da laboratorio

Scan Body Lab

Analogo digitale

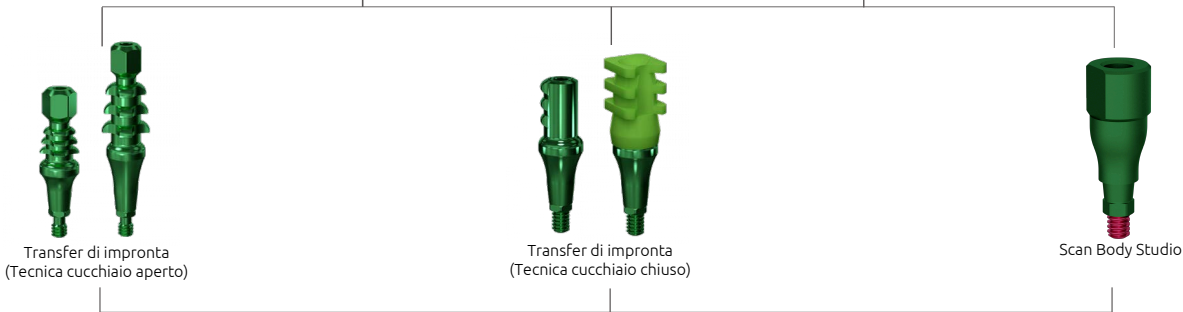

Transfer di impronta  
(Tecnica cucchiaio aperto)

Transfer di impronta  
(Tecnica cucchiaio chiuso)

Scan Body Studio



Vite di copertura

Bone Build-up

Gengiva Former



CRE

**Può essere usato per**

- Carrier per l'inserimento dell'impianto (fino a 40 N/cm)
- Abutment per carico immediato
- Abutment provvisorio
- Abutment definitivo
- Base per formatore gengivale individuale
- Scansione intraorale



## One-piece abutments for telescopic fixation

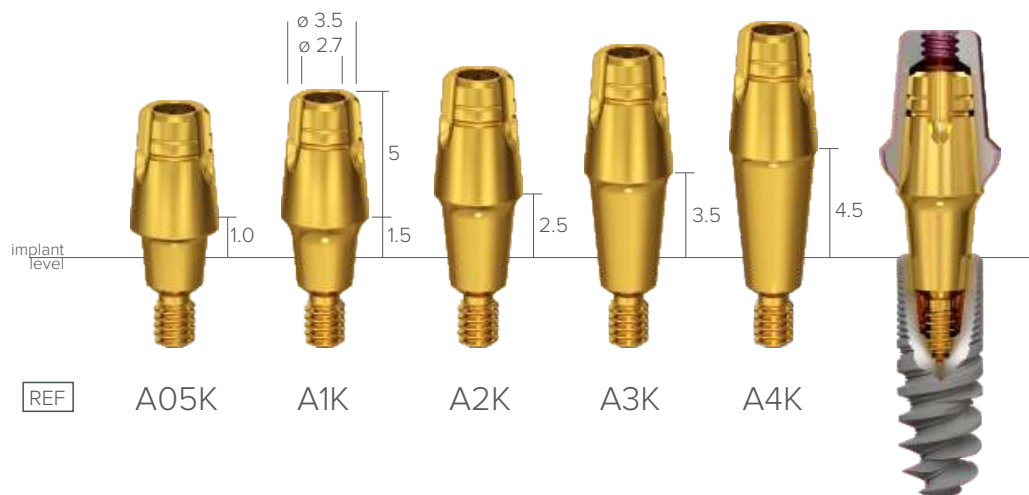

## Narrow abutments for telescopic fixation



## Titanium abutments for telescopic fixation



## PEEK abutments for telescopic fixation

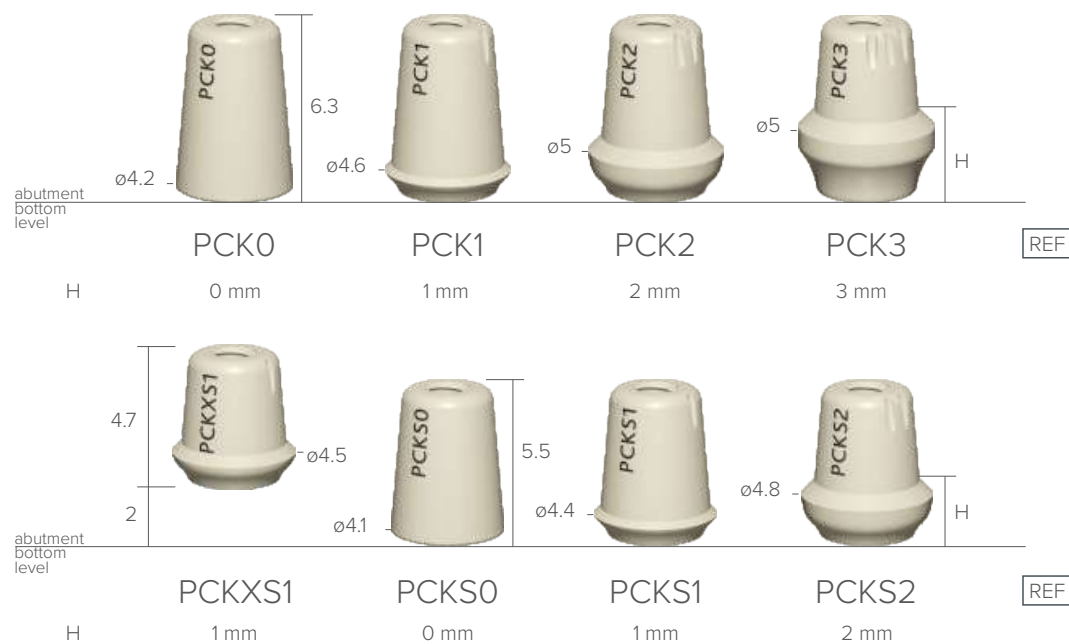

## Opzioni Protetiche per tecnica avvitata per Multi Unit

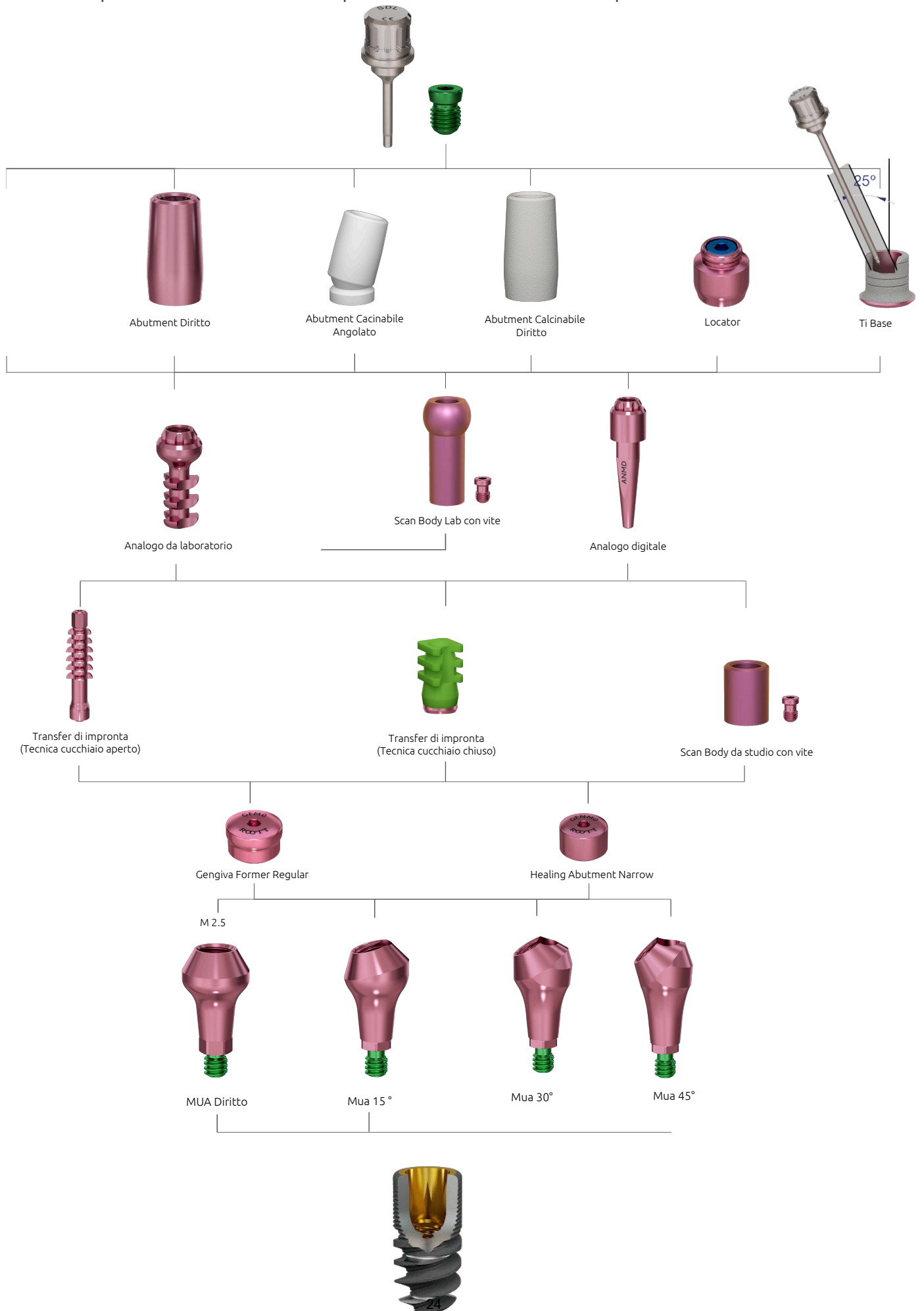

# Multi-unit abutments

## Small multi-unit abutments



## Regular multi-unit abutments

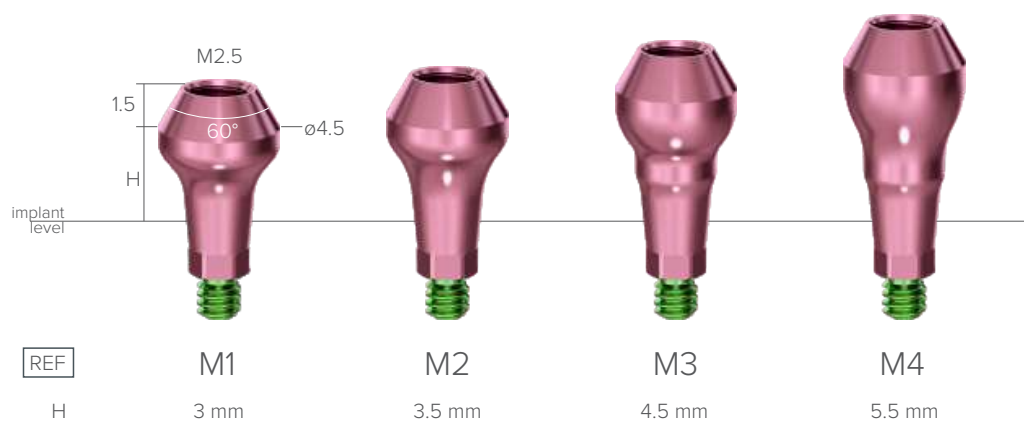

## 15° angled multi-unit abutments



## 30° angled multi-unit abutments



## 45° angled multi-unit abutments



# Superstructures for multi-unit abutments

## Transfers & analogs

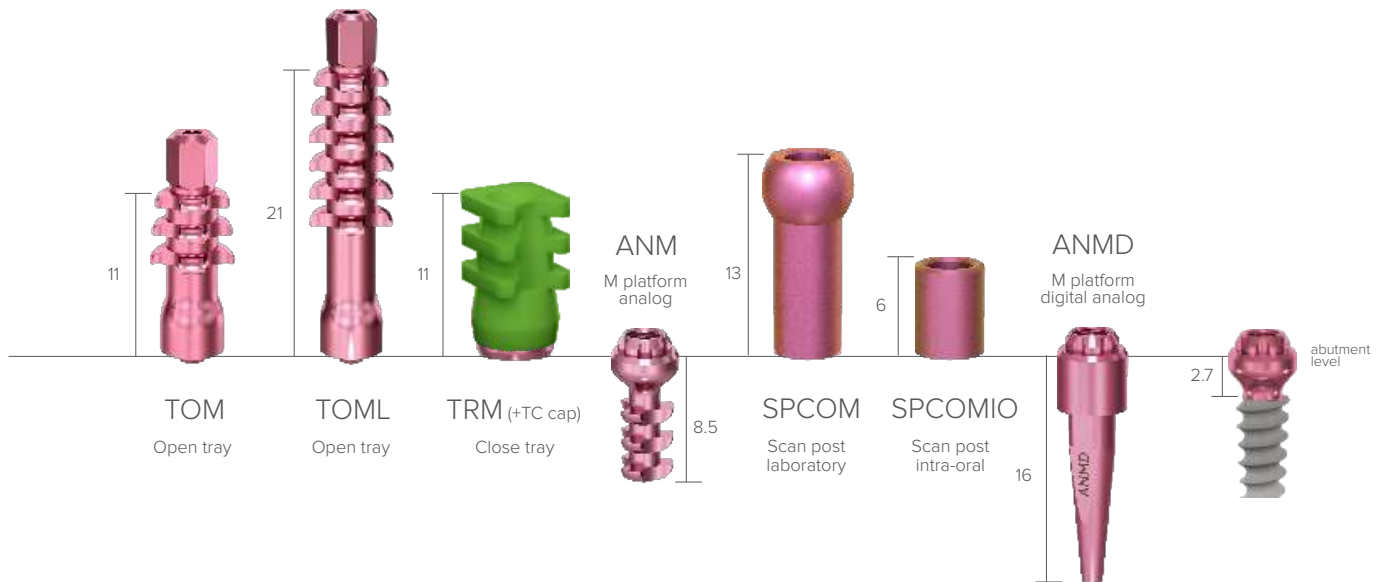

## Abutments



## Healing abutments



# Superstructures for small multi-unit abutments

## Transfers & analogs



## Abutments



## Healing abutments



# Attachments

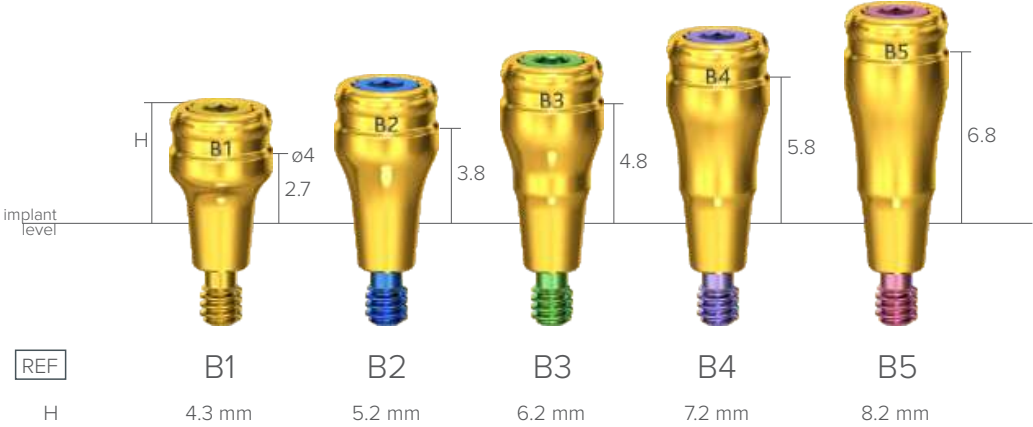



## MUA Integrated Implant



Design Anatomico



Carico Immediato



MUA Integrato (compensazione fino a 60°)



Restauro multiplo

## Ultra Resistente

Ø2.5 mm - passo vite



Facile, Pratico,  
Zero possibilità di  
svitamento



Ottimo Fissaggio  
Resiste alle forze  
occlusali

Il titanio utilizzato per la costruzione degli impianti TRATE risponde ai requisiti normativi ISO 5832-3 Lega di titanio Ti6Al4V ELI (Grado 23).



# Ampia gamma di diametri e lunghezze

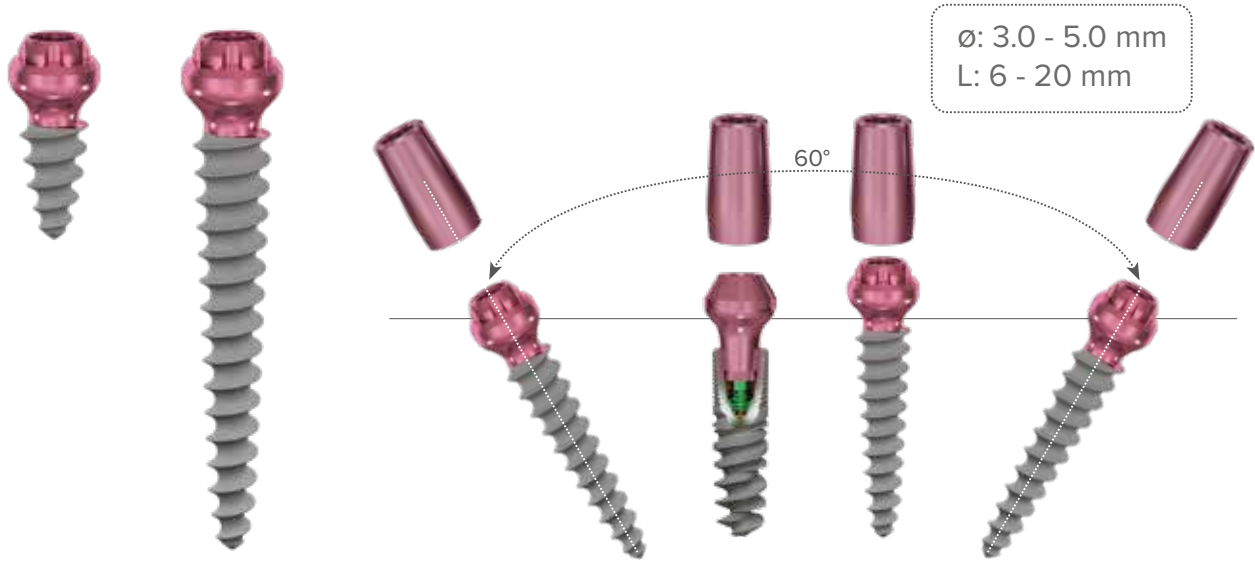

## Diverse soluzioni cliniche, un'unica piattaforma protesica

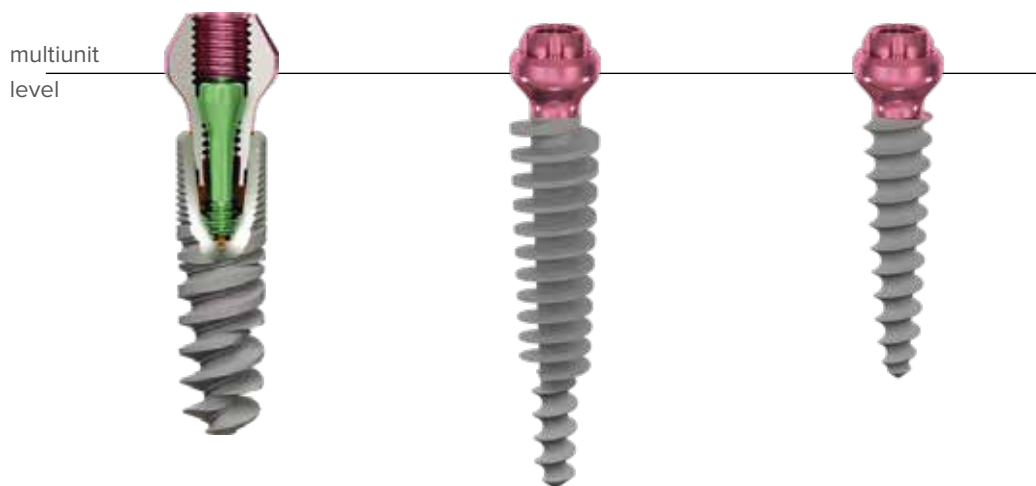

Superficie Osteogenica RBM  
Sabbia HA/TCP e Acidificata



**Open Dental  
Community**  
Innovations and development

## Pterygoid Implant

M2.5x0.35 6H



Design Anatomico



Carico Immediato



MUA Integrato (compensazione fino a 60°)



Restauro multiplo

## Ultra Resistente

Ø2.5 mm - passo vite



Facile, Pratico,  
Zero possibilità di  
svitamento



Ottimo Fissaggio  
Resiste alle forze  
occlusali

Il titanio utilizzato per la costruzione degli impianti TRATE risponde ai requisiti normativi ISO 5832-3 Lega di titanio Ti6Al4V ELI (Grado 23).



# Diametri e lunghezze



Ø: 3.0 - 5.0 mm  
L: 6 - 20 mm

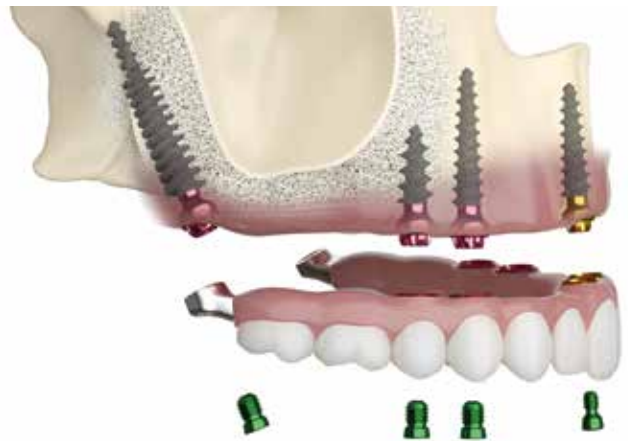

## Diverse soluzioni cliniche, un'unica piattaforma protesica

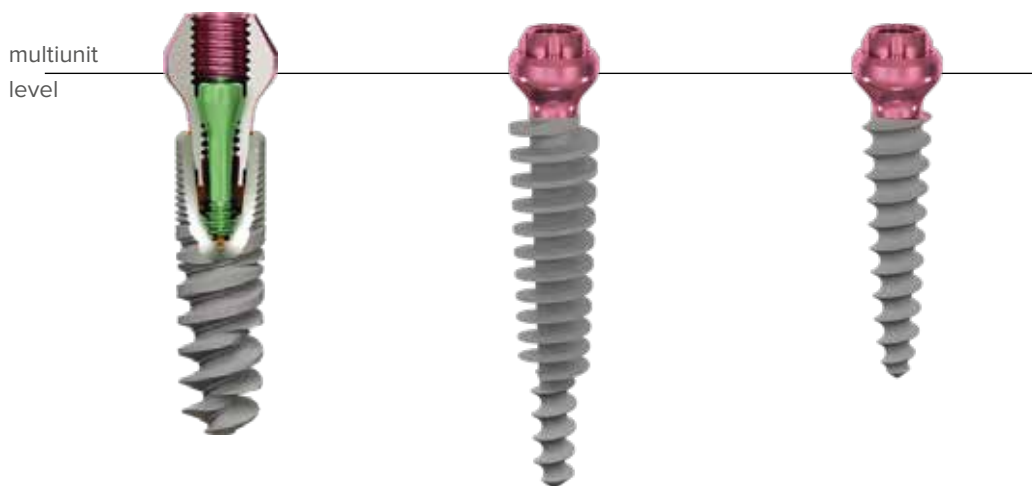



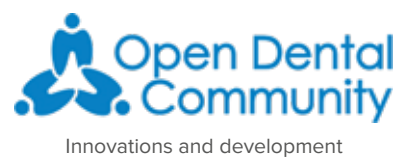



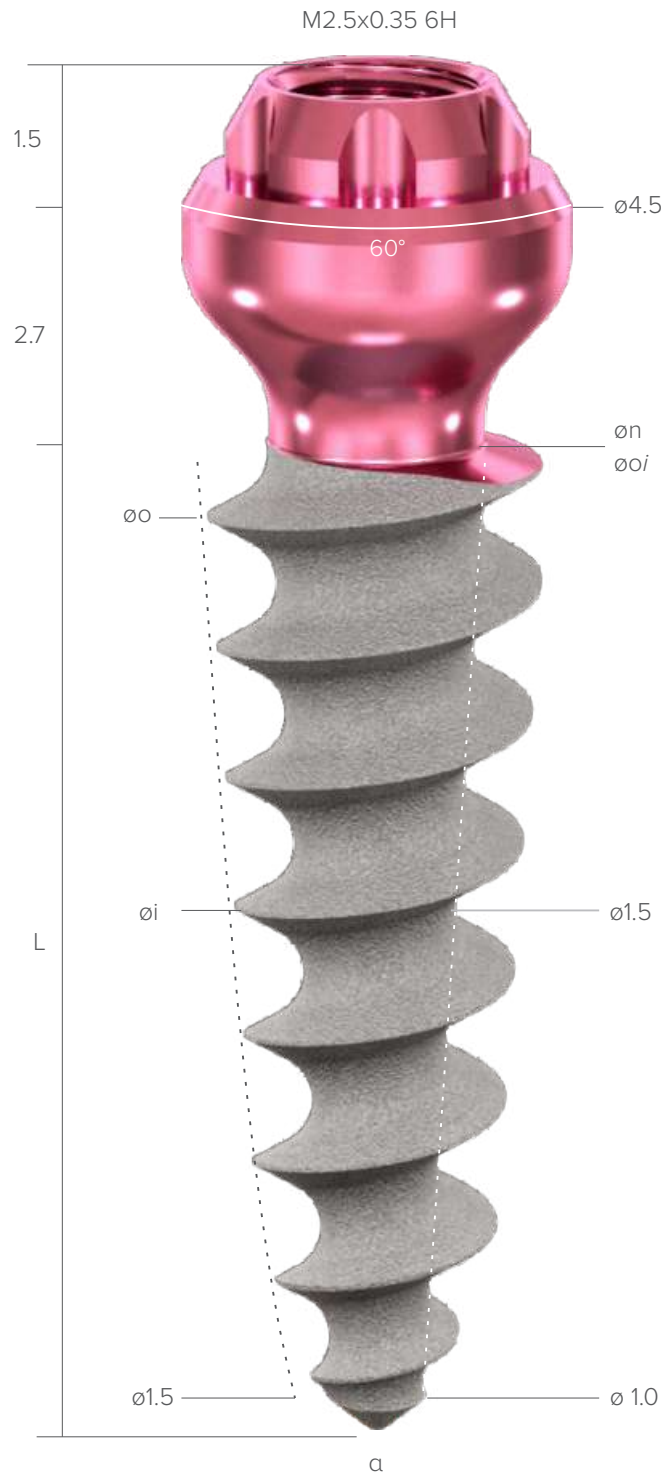





























Superficie Osteogenica RBM  
Sabbia HA/TCP e Acidificata



# ROOTT M



o - diametro occlusale (mm); i - diametro intraosseo (mm); a - diametro apicale (mm); n- Diametro collo - α - angolo interno totale (gradi °); s - area quadrata intraossea (mm<sup>2</sup>); i = interno

o / L	6 mm	8 mm	10 mm	12 mm	14 mm	16 mm	18 mm	20 mm
ø 3.0		C3008m	C3010m	C3012m	C3014m	C3016m	C3018m	C3020m
øi 2.5 n 2.05		s 63 a 8 	s 79 a 6 	s 95 a 5 	s 112 a 4 	s 128 a 4 	s 145 a 3 	s 161 a 3 
ø 3.5	C3506m	C3508m	C3510m	C3512m	C3514m	C3516m	C3518m	C3520m
øi 2.8 n 2.05	s 54 a 15 	s 72 a 11 	s 91 a 9 	s 109 a 7 	s 127 a 6 	s 146 a 6 	s 164 a 5 	s 182 a 5 
ø 4.0	C4006m	C4008m	C4010m	C4012m	C4014m	C4016m		
øi 3.3 n 2.55	s 63 a 15 	s 86 a 11 	s 108 a 9 	s 130 a 7 	s 152 a 6 	s 174 a 6 		
ø 5.0	C5006m	C5008m	C5010m	C5012m	C5014m			
øi 4.3 n 2.55	s 82 a 15 	s 111 a 11 	s 141 a 9 	s 170 a 7 	s 200 a 6 			
ø 6.0	C6006m	C6008m	C6010m	C6012m	C6014m			
øi 5.3 n 2.55	s 124 a 15 	s 175 a 11 	s 219 a 9 	s 266 a 7 	s 313 a 6 			
ø 8.0	C8006m	C8008m	C8010m	C8012m	C8014m			
øi 7.3 n 2.55	s 321 a 15 	s 462 a 11 	s 596 a 9 	s 731 a 7 	s 865 a 6 			

# ROOTT **P**

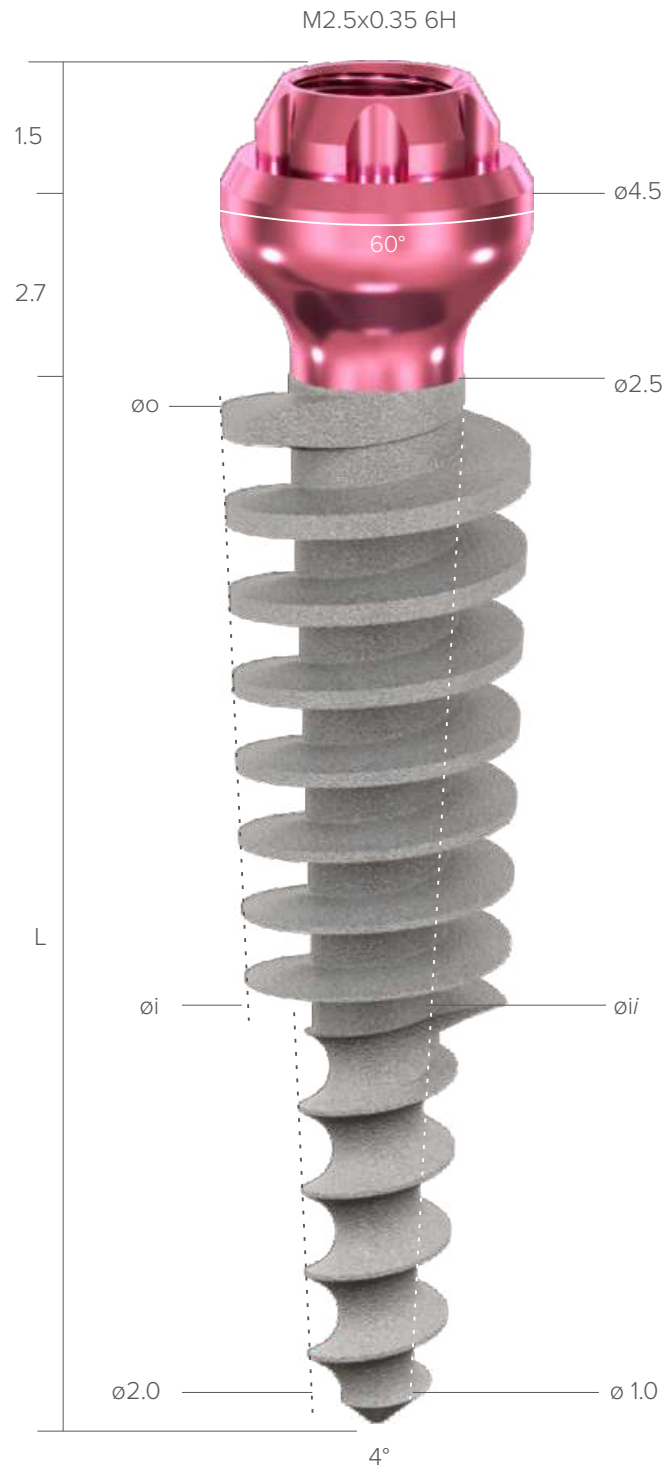

o - diametro occlusale (mm); i - diametro intraosseo (mm); a - diametro apicale (mm); n- Diametro collo -  $\alpha$  - angolo interno totale (gradi °); s - area quadrata intraossea (mm<sup>2</sup>); i = interno

o / L    16 mm            18 mm            20 mm            22 mm            24 mm            26 mm

ø 3.5    C3516mp    C3518mp    C3520mp    C3522mp    C3524mp    C3526mp

i 2.8  
i/ 1.7  
s 175

i 2.7  
i/ 1.7  
s 198

i 2.5  
i/ 1.5  
s 220

i 2.6  
i/ 1.5  
s 248

i 2.6  
i/ 1.5  
s 274

i 2.6  
i/ 1.5  
s 297



ø 4.5    C4516mp    C4518mp    C4520mp    C4522mp    C4524mp    C4526mp

i 3.9  
i/ 1.8  
s 251

i 3.7  
i/ 1.7  
s 290

i 3.6  
i/ 1.5  
s 329

i 3.4  
i/ 1.4  
s 369

i 3.3  
i/ 1.2  
s 402

i 3.3  
i/ 1.3  
s 443





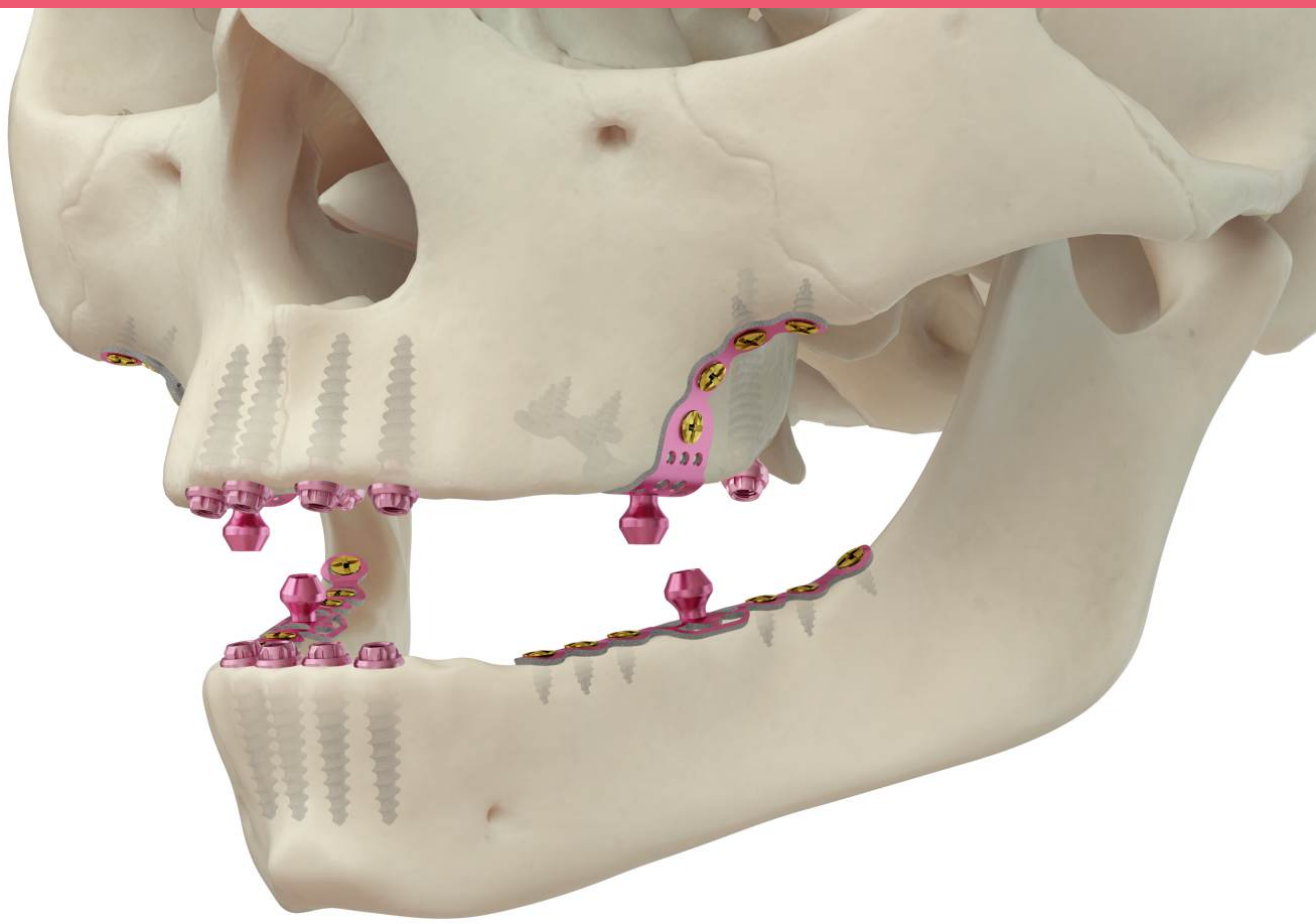

Semplifica il tuo lavoro

Diverse soluzioni cliniche, un'unica piattaforma protesica

One platform Multi-Unit

multiunit  
level



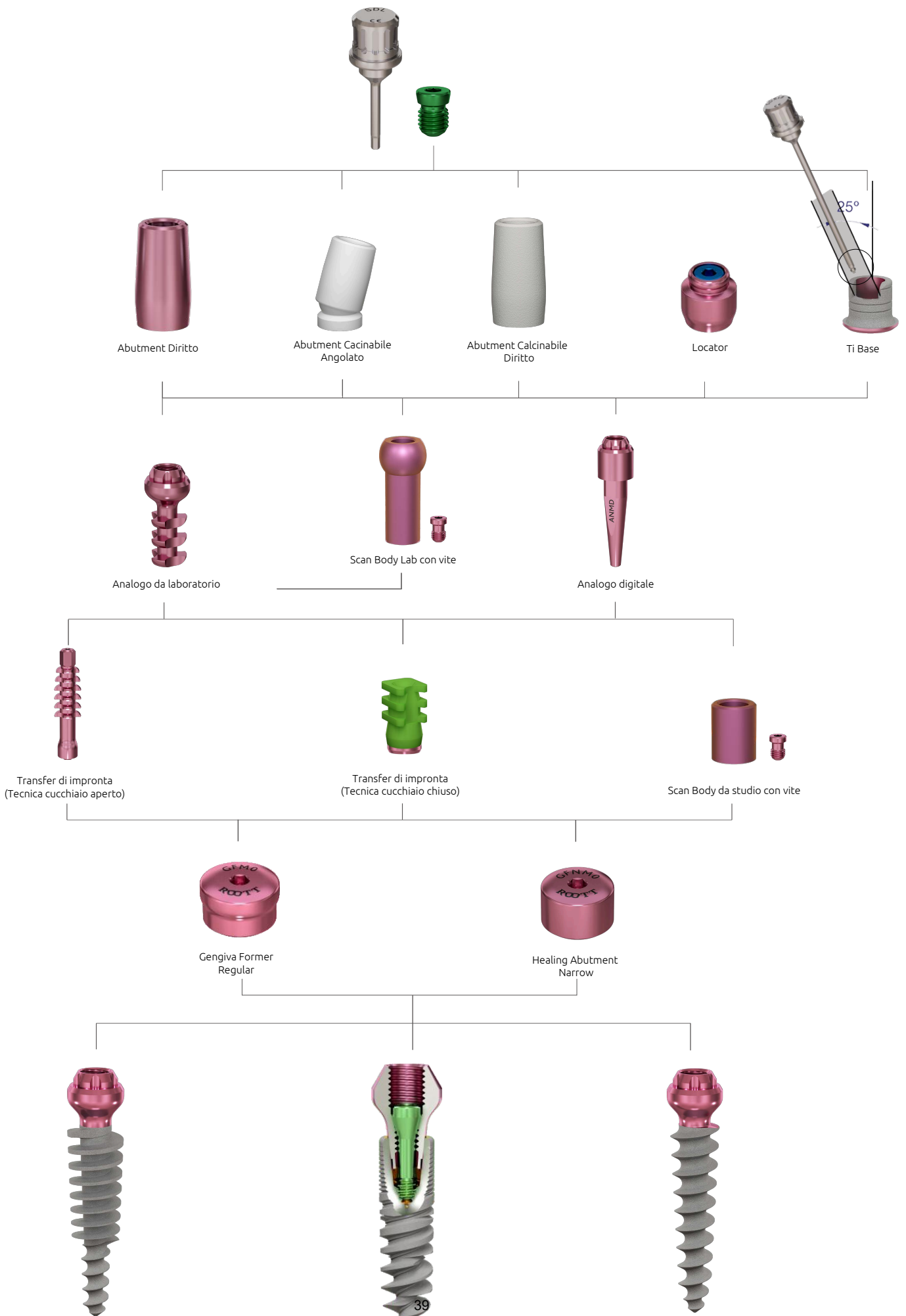

# Transfers & implant analogs

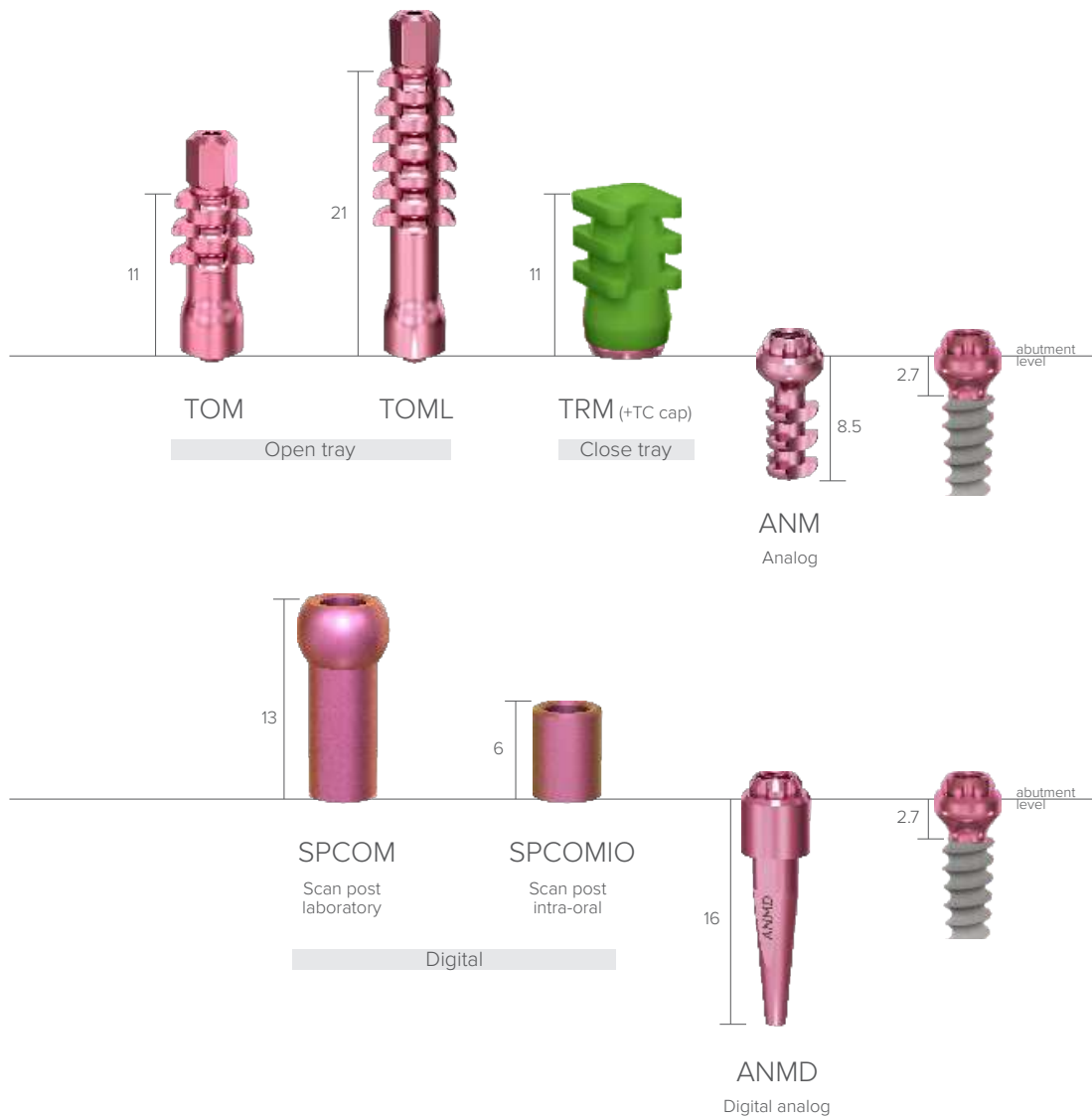

## Abutments



# Healing abutments

## Regular



## Narrow



## MUA Integrated Implant

### All in One

M1.8x0.35 6H



Il titanio utilizzato per la costruzione degli impianti TRATE risponde ai requisiti normativi ISO 5832-3 Lega di titanio Ti6Al4V ELI (Grado 23).



Design Anatomico



Carico Immediato



MUA Integrato (compensazione fino a 60°) diametro ridotto



Restauro multiplo

## Nel Packaging

Contenuto:

- Prenditore manuale
- Transfer per impronta
- Abutment Multifunzionale
- Impianto



## Diametri e lunghezze



Ø: 3.0 - 3.5 mm  
L: 8 - 16 mm

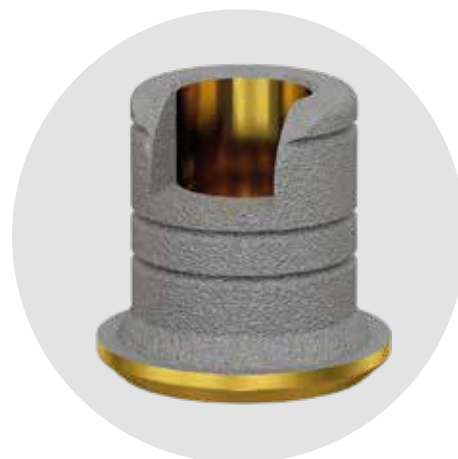

## Abutment Multifunzionale

Incluso nel packaging

Realizzato in Ti6Al4V ELI (Grado 23).

### Può essere usato per

- Carrier per l'inserimento dell'impianto (fino a 40 N/cm)
- Abutment per carico immediato
- Abutment provvisorio
- Abutment definitivo
- Scansione intraorale



Superficie Osteogenica RBM  
Sabbata HA/TCP e Acidificata

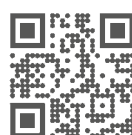

# ROOTT **S**

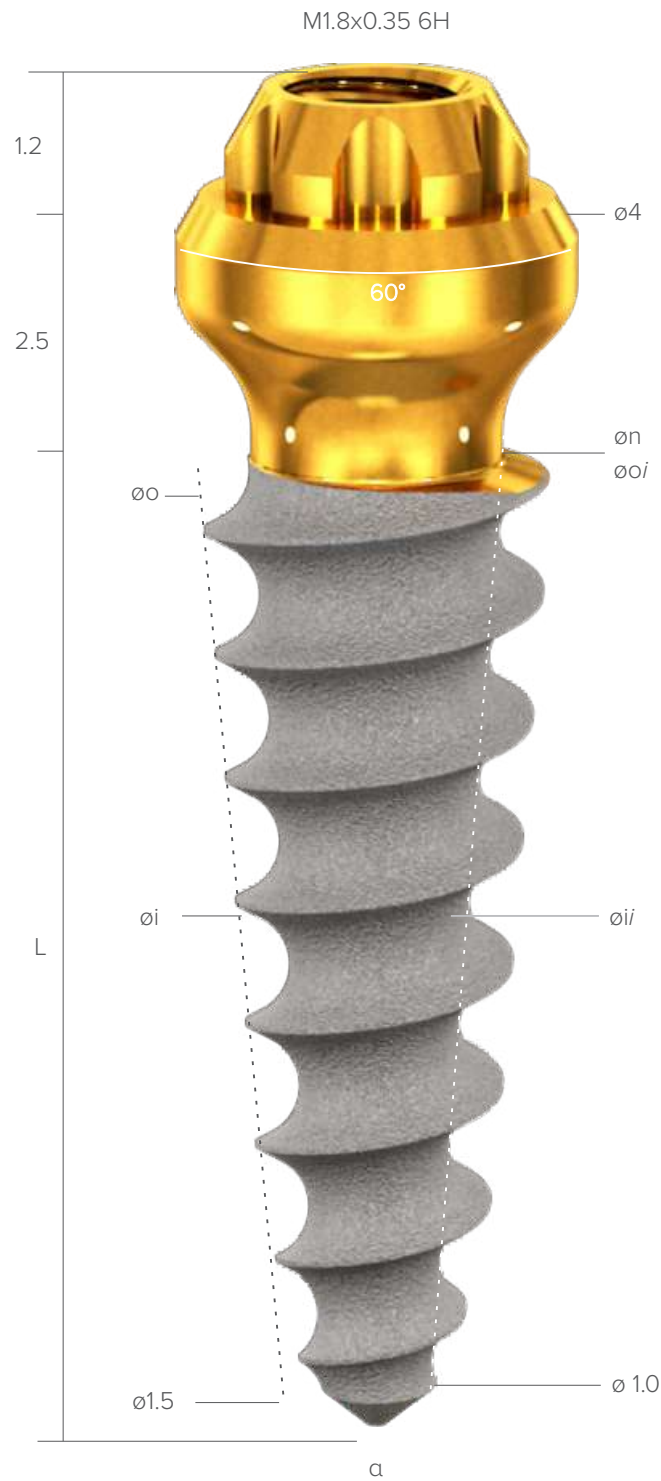

o - occlusal diameter (mm); i - intraosseous diameter (mm); a - apical diameter (mm); n - neck diameter;  
α - total internal angle (°); s - intraosseous square area (mm<sup>2</sup>); i = internal.

o / L      6 mm                  8 mm                  10 mm                  12 mm                  14 mm                  16 mm

ø 3.0  
øi 2.5  
øi' 1.5  
n 2.05



ø 3.5  
øi 2.8  
øi' 1.8  
n 2.55





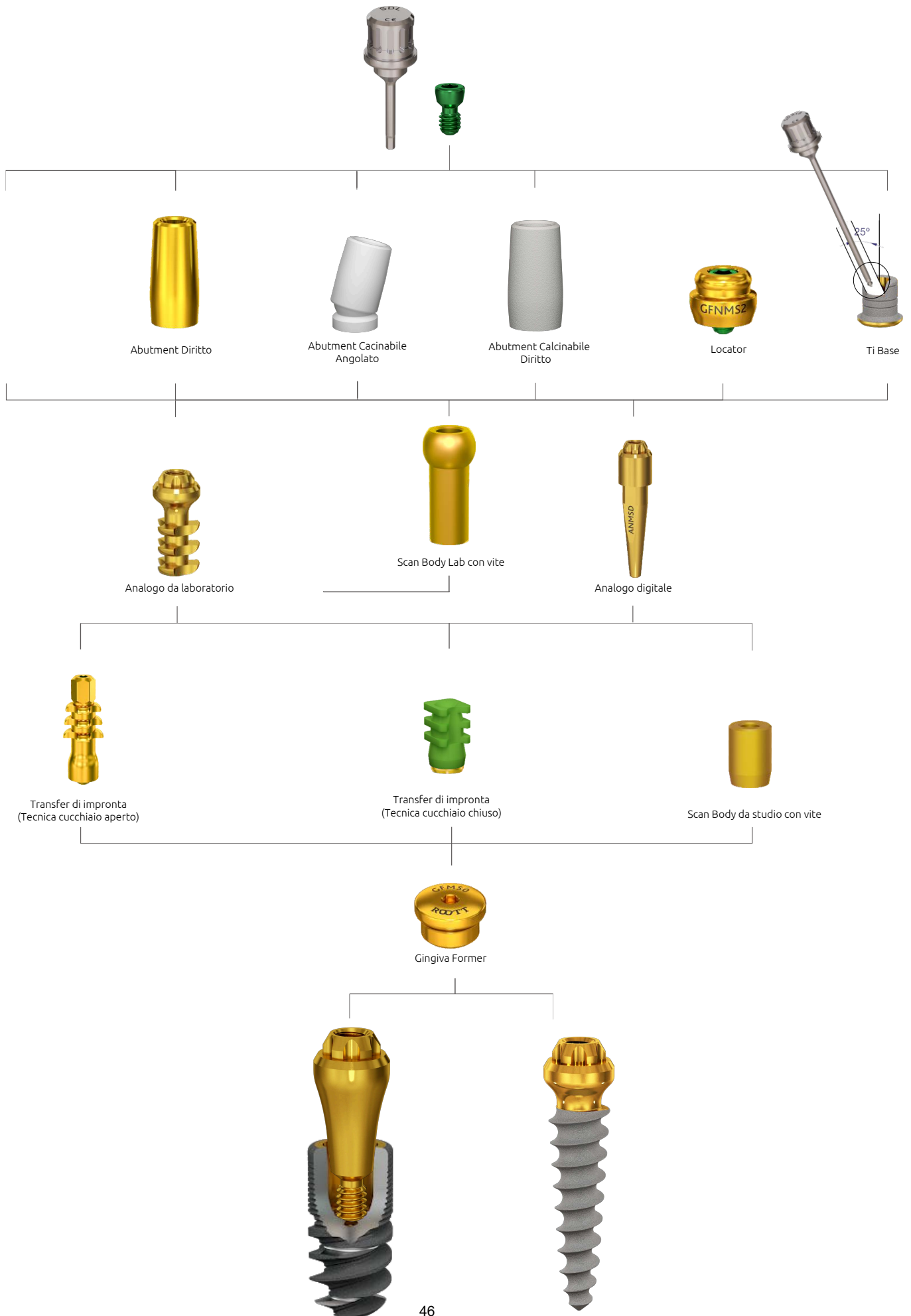

# Transfers & implant analogs

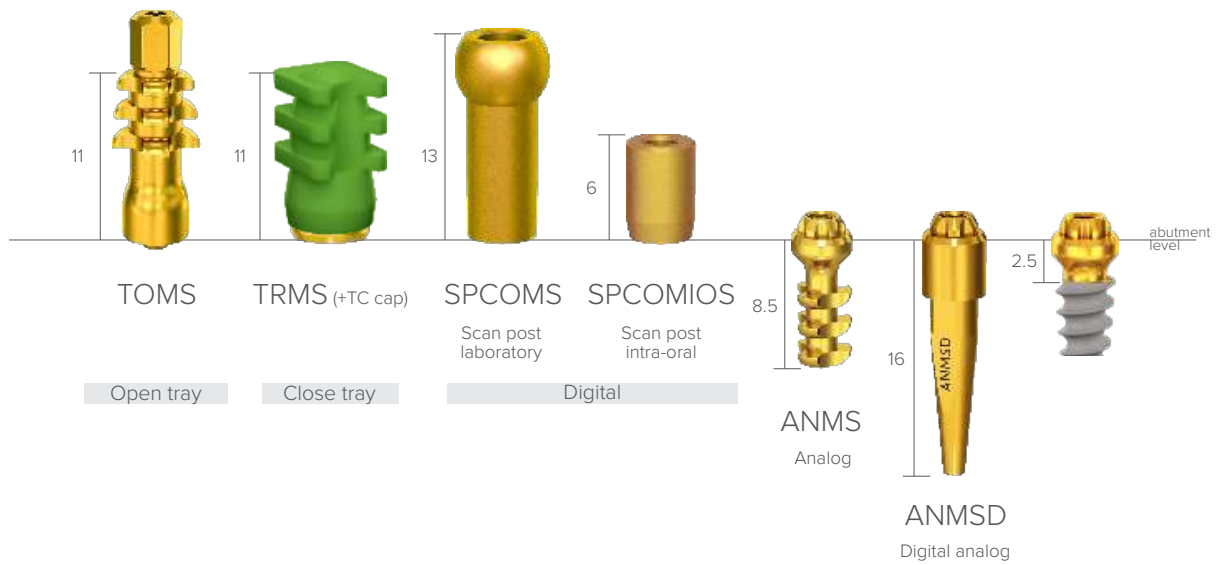

# Abutments



# Healing abutments

## Regular



## Narrow



## Soluzioni Conometriche



### Telescopica con **ROOTT R**

Le componenti telescopiche del sistema **ROOTT** permettono al clinico di offrire al paziente una riabilitazione funzionale in tempi rapidi, con risultati estetici eccellenti.

Con questa tecnica si possono eliminare le viti protesiche e l'utilizzo di cementi a contatto con i tessuti molli.

### Telescopica con **ROOTT C**

Questa soluzione permette al clinico di offrire una sistemica protesica garantendo vantaggi sia per lo studio sia per il paziente.



## Compressive Implant



Risparmio di tempo e costi



Carico Immediato



Ottimo per creste sottili



Può evitare l'aumento osseo



Collo  
Pieghevole



Il titanio utilizzato per la costruzione degli impianti TRATE risponde ai requisiti normativi ISO 5832-3 Lega di titanio Ti6Al4V ELI (Grado 23).

# Ampia gamma di diametri e lunghezze

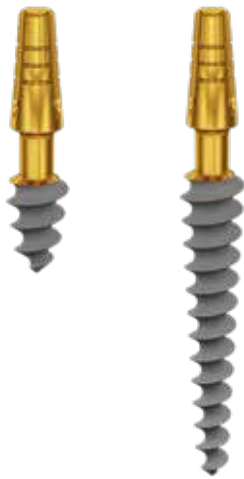

Ø: 3.0 - 5.5 mm  
L: 6 - 20 mm

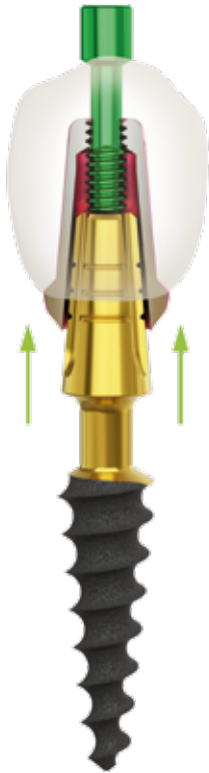

## Abutments per telescopica





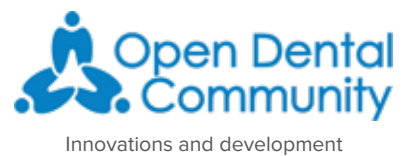
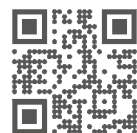
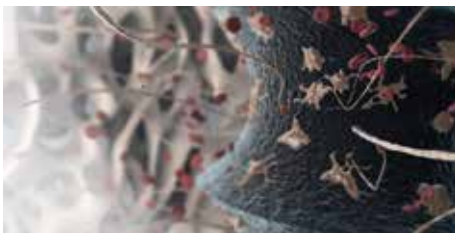

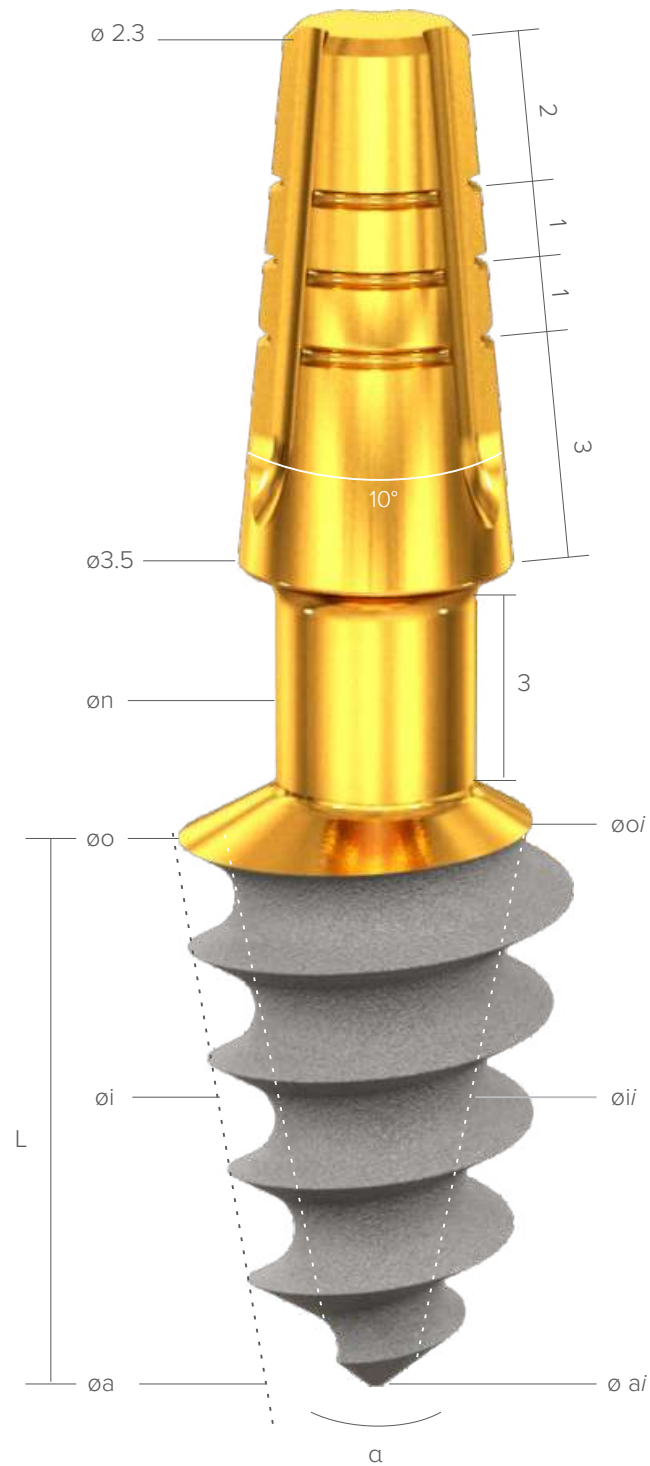











































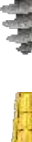



Superficie Osteogenica RBM  
Sabbia HA/TCP e Acidificata





o - occlusal diameter (mm); i - intraosseous diameter (mm); a - apical diameter (mm); n - neck diameter;  
 $\alpha$  - total internal angle (°); s - intraosseous square area (mm<sup>2</sup>); i = internal.

L / o	ø 3.0	ø 3.5	ø 4.0	ø 4.5	ø 5.0	ø 5.5	ø 6.5	ø 7.5	ø 8.5
	oi 2.05 n 2.05	oi 2.46 n 2.05	oi 2.95 n 2.05	oi 3.05 n 2.35	oi 3.55 n 2.35	oi 4.04 n 2.55	oi 4.0 n 2.55	oi 4.0 n 2.55	oi 4.04 n 2.55
6 mm	 C3006 2.4   1.4 1.9   0.9 4.5   1.2	 C3506 2.6   1.6 1.9   0.9 4.9   1.7	 C4006 3.1   2.0 2.4   1.2 5.9   1.8	 C4506 3.5   2.1 2.9   1.4 7.3   1.8	 C5006 3.9   2.4 3.2   1.7 8.2   2.1	 C5506 4.1   2.7 3.2   1.8 8.8   2.7	 C6506 5.1   2.6 4.5   1.9 12.6   2.7	 C7506 6.1   2.3 5.8   2.6 14.4   2.7	 C8506 7.1   2.7 7.1   2.6 15.8   2.6
8 mm	 C3008 2.4   1.4 1.9   0.9 5.9   1.9	 C3508 2.6   1.6 1.9   0.9 6.5   1.3	 C4008 3.1   2.0 2.4   1.2 8.0   1.3	 C4508 3.6   2.2 2.9   1.4 10.0   1.3	 C5008 4.0   2.5 3.2   1.8 11.3   1.5	 C5508 4.2   2.7 3.2   1.8 12.1   1.9	 C6508 5.2   2.7 4.4   1.9 17.7   1.9	 C7508 6.2   2.6 5.6   2.1 20.8   1.9	 C8508 7.2   2.7 6.7   2.3 23.1   1.9
10 mm	 C3010 2.4   1.4 1.9   0.9 7.4   1.7	 C3510 2.6   1.6 1.9   0.9 8.2   1.0	 C4010 2.9   1.8 1.9   0.8 9.2   1.3	 C4510 3.4   1.9 2.4   1.0 11.7   1.3	 C5010 3.7   2.2 2.6   1.2 13.1   1.5	 C5510 3.8   2.4 2.5   1.0 13.9   1.9	 C6510 4.9   2.4 3.6   1.2 21.1   1.9	 C7510 5.8   2.7 4.5   2.4 25.1   1.9	 C8510 3.8   2.4 2.5   1.0 28.7   1.9
12 mm	 C3012 2.3   1.3 1.7   0.7 8.6   1.6	 C3512 2.6   1.6 1.8   0.8 9.7   1.9	 C4012 2.8   1.8 1.8   0.8 10.9   1.1	 C4512 3.3   1.9 2.4   0.9 13.9   1.1	 C5012 3.8   2.4 2.8   1.4 16.3   1.2	 C5512 3.9   2.5 2.5   1.1 16.7   1.6	 C6512 4.9   2.4 3.6   1.2 25.8   1.6	 C7512 5.9   2.4 4.8   1.3 30.9   1.6	 C8512 6.9   2.4 5.9   1.4 35.7   1.6
14 mm	 C3014 2.4   1.3 1.9   0.7 9.9   1.5	 C3514 2.6   1.5 1.8   0.7 11.1   1.8	 C4014 2.9   1.8 1.8   0.8 12.8   1.0	 C4514 3.3   1.9 2.3   0.9 16.2   1.0	 C5014 3.6   2.2 2.4   0.9 17.9   1.2	 C5514 3.8   2.3 2.3   0.8 19.1   1.4	 C6514 4.8   2.4 3.4   0.9 29.7   1.4	 C7514 5.8   2.4 4.5   1.1 35.9   1.4	 C8514 6.8   2.4 5.6   1.2 41.5   1.4
16 mm	 C3016 2.4   1.4 1.7   0.8 11.8   1.4	 C3516 2.6   1.6 1.8   0.8 12.9   1.6	 C4016 2.9   1.8 1.8   0.8 14.6   1.8	 C4516 3.3   1.9 2.3   0.8 18.4   1.9					
18 mm	 C3018 2.4   1.3 1.7   0.7 12.8   1.4	 C3518 2.6   1.7 1.8   0.8 14.6   1.6	 C4018 2.9   1.8 1.8   0.8 16.4   1.7	 C4518 3.3   1.9 2.2   0.8 20.6   1.8					
20 mm	 C3020 2.4   1.3 1.7   0.7 14.3   1.4	 C3520 2.6   1.6 1.8   0.7 16.1   1.5	 C4020 2.9   1.8 1.8   0.7 18.0   1.7	 C4520 3.3   1.9 2.2   0.8 22.9   1.7					

oi | oii  
oa | oai  
S | a

Ti6Al4V ELI



# External platform

## Transfers



## Analogs



## Healing abutments



# Telescopic abutments, titanium

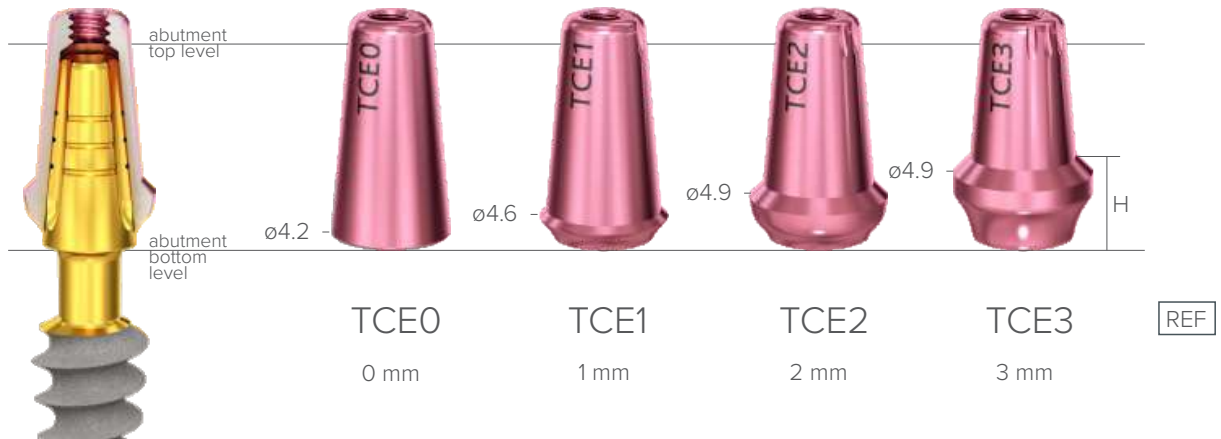

# Telescopic abutments, PEEK

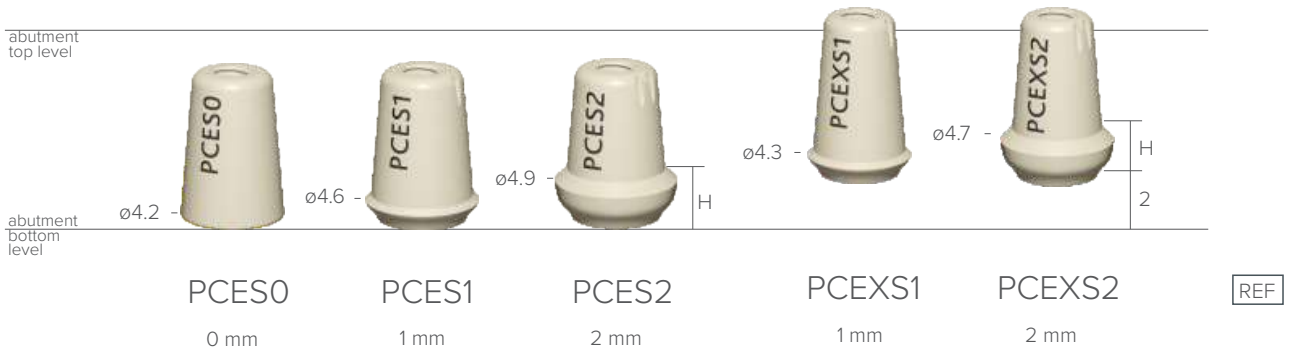
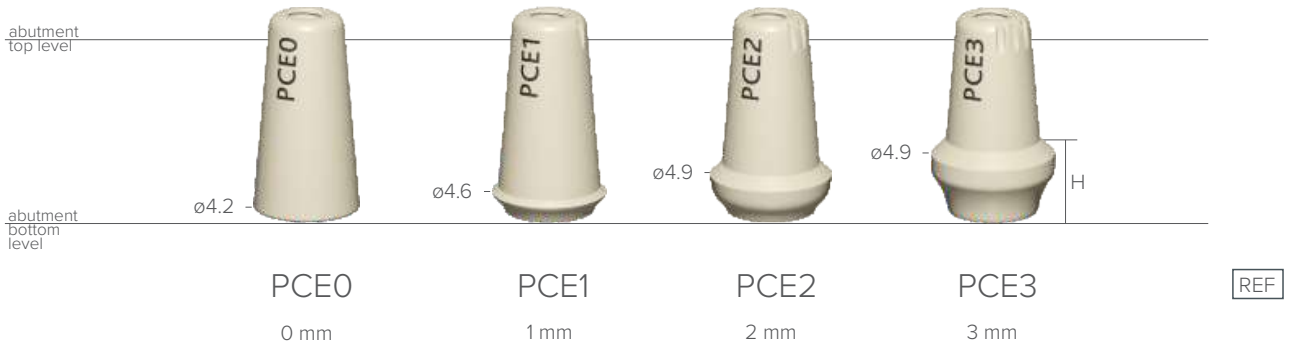

# Burn-out abutments

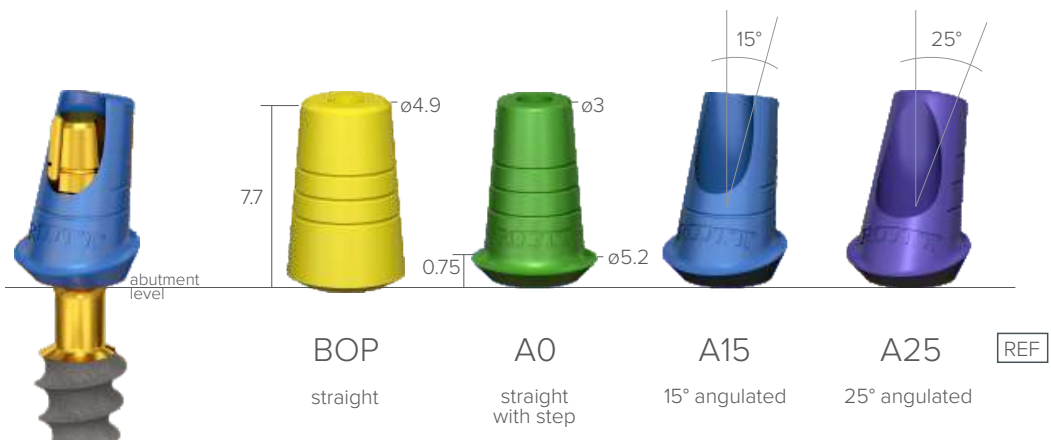

# INSTRUMENTS



# Frese Universali ROOTT

Le frese ROOTT sono state progettate per offrire una efficiente osteotomia sia in fase di taglio che in fase di densificazione ossea.

L'elica variabile garantisce un migliore controllo della perforazione e la scanalatura permette l'estrazione ossea.

La forma riduce l'attrito riducendo drasticamente il riscaldamento dell'osso.

Il tagliente posteriore angolato, specificatamente progettato, consente di compattare l'osso invertendo il senso di rotazione su qualsiasi motore chirurgico, ottenendo una densificazione ossea lì ove necessario.



# Instruments

## Drills

### Lance drill



### Twist drills



### Universal drills



### ROOTT<sup>R</sup>



### ROOTT<sup>C</sup>



### ROOTT<sup>B</sup>



# Taps

## ROOTT **R**



TR30xx  
10-16 mm



TR35xx  
6-16 mm



TR38xx  
6-16 mm



TR42xx  
6-16 mm



TR48xx  
6-16 mm



TR55xx  
6-16 mm

## ROOTT **C**



CS30xx  
6-20 mm



CS35xx  
6-20 mm



CS40xx  
6-20 mm



CS45xx  
6-20 mm



CS50xx  
6-14 mm



CS55xx  
6-14 mm

## Universal taps



CS2518F



CS3018F



CS4016F

# Handles



ETH

Surgical handle, handpiece

ETR

Surgical handle, ratchet



ETAO

Surgical handle, AO



DW

Handle for implant driver

# Gauges

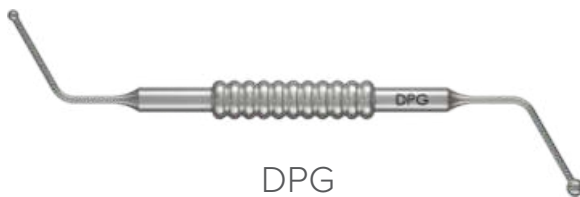

DPG

Implant depth gauge



DIR

Alignment bar



P2

Parallel pin



# Screwdrivers

1.25 mm



SD    SDL    SDXL    SDLB    SDXLB    SDH    SDHL    SDHXL    SDAO    SDM    SDML

Ball hex    Ball hex

For ratchet

For handpiece

For AO handle

Manual

# Implant drivers

**ROOTT** R

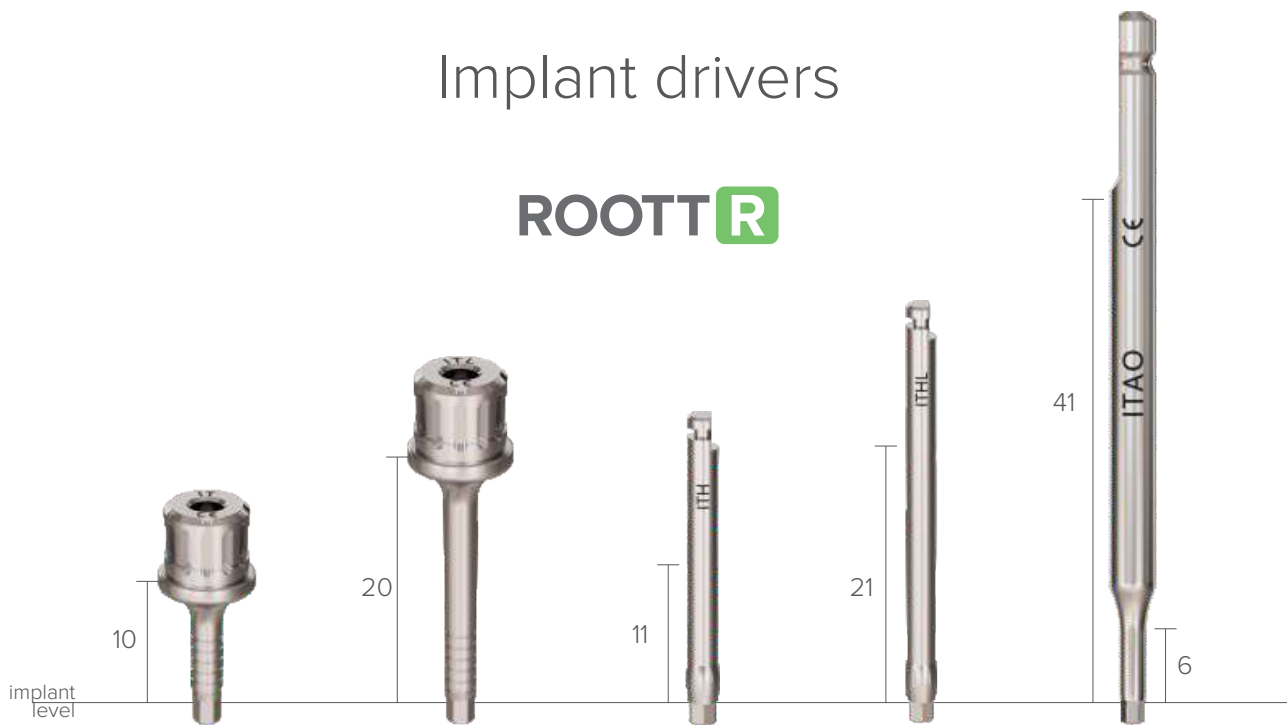

IT

ITL

ITH

ITHL

ITAO

For ratchet

For handpiece

For AO handle

# ROOTT C CS



# ROOTT M P

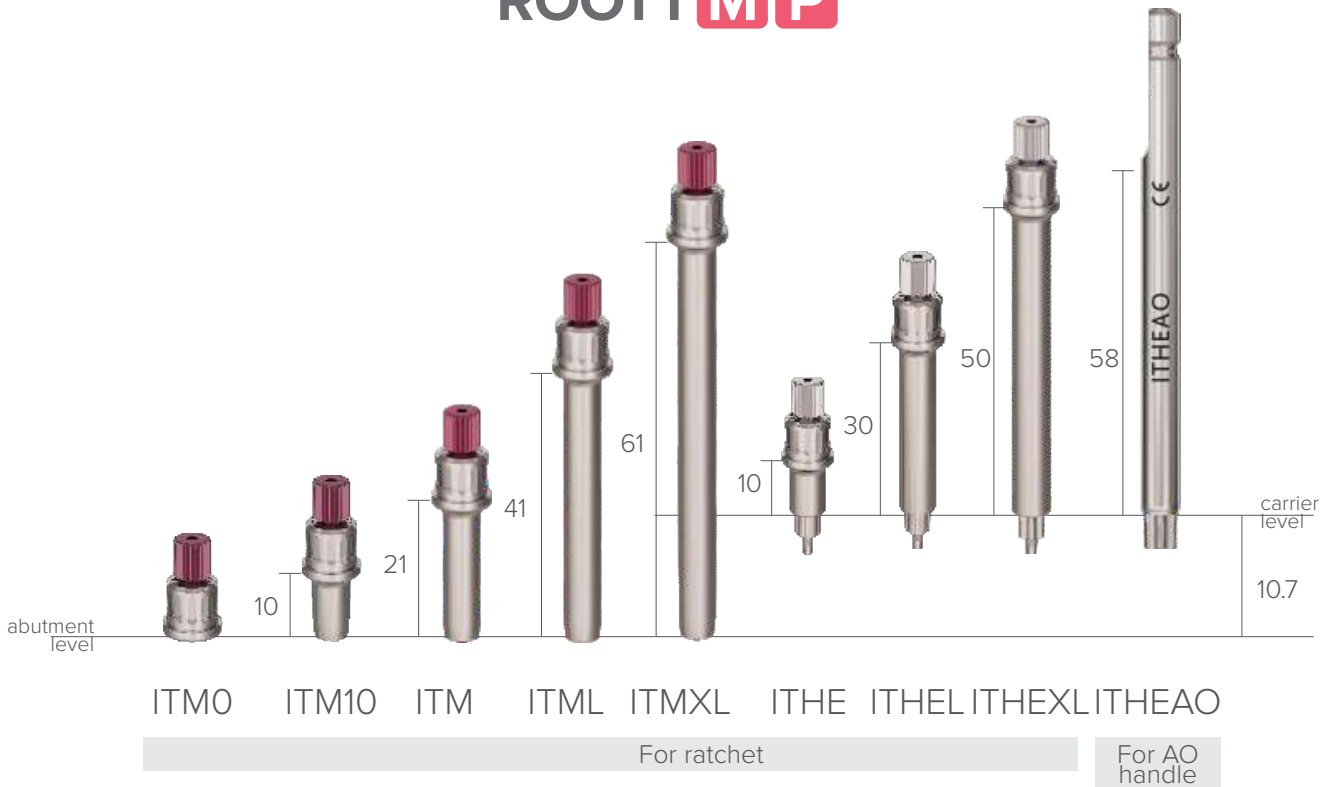

# ROOTT **S**

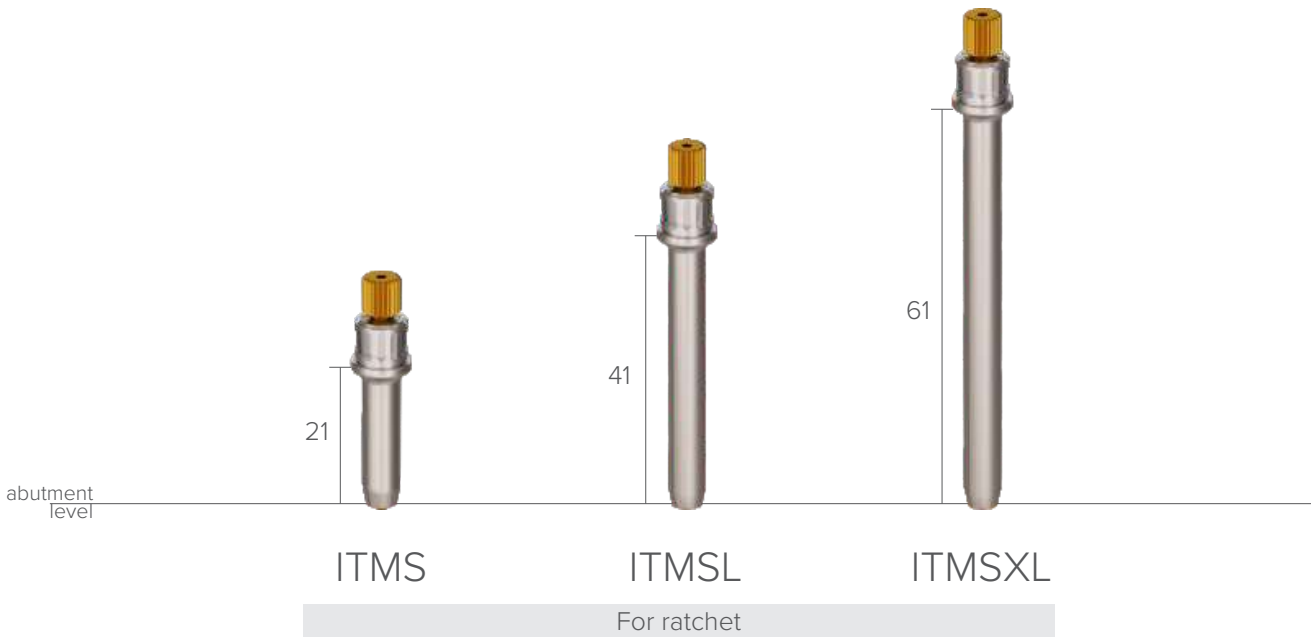

## General instruments



TW50  
Torque wrench 10-50 Ncm



TW70  
Torque wrench 10-70 Ncm



RW, RWS  
Ratchet wrench



BT  
Abutment bender for ROOTT **C**



ET  
Drill extension for handpiece



ETAO  
Drill extension for AO handle

## Abutment extractors



SR, SRL  
Abutment extractors for ROOTT **R**

# Guided system

## Stoppers



Stoppers S1 compatible with drills  
DB2020, D2020, D2516, D2816,  
DC3006.....DC4520

S1L02 S1L04 S1L06 S1L08 S1L10 S1L12 S1L14 S1L16



Stoppers S2 compatible with drills  
D3216, D3616, D4016, D4316,  
DC5006.....DC5514

S2L02 S2L04 S2L06 S2L08 S2L10 S2L12 S2L14 S2L16



Stoppers S3 compatible with drills  
D4616, D516, D5316

S3L02 S3L04 S3L06 S3L08 S3L10 S3L12 S3L14 S3L16

## Sleeves and drills handles



SL02 SLS1 SLS2 SLS3

A02SL3 A02SL2 A02SL1

A1SL3 A1SL2

A2SL3

# Casetta chirurgica



TRS



TRS-mini

# Meet the intelligence with DIGITAL SOLUTIONS

Time-efficient and accurate options enhance quality possibilities and bring the modern approach to the dental industry that dental professionals seek.

Precision is essential considering the right angle, size, depth and width for dental professionals; therefore, ROOTT offers the digital workflow allowing the possibility of designing a complete dental solution. The digital library will provide options and introductions into using software and transferring the skills into the digital workflow from the tools required to design the exterior to components offered to solve basic or complex cases.



ROOTT  
digital  
libraries



# Digital workflow

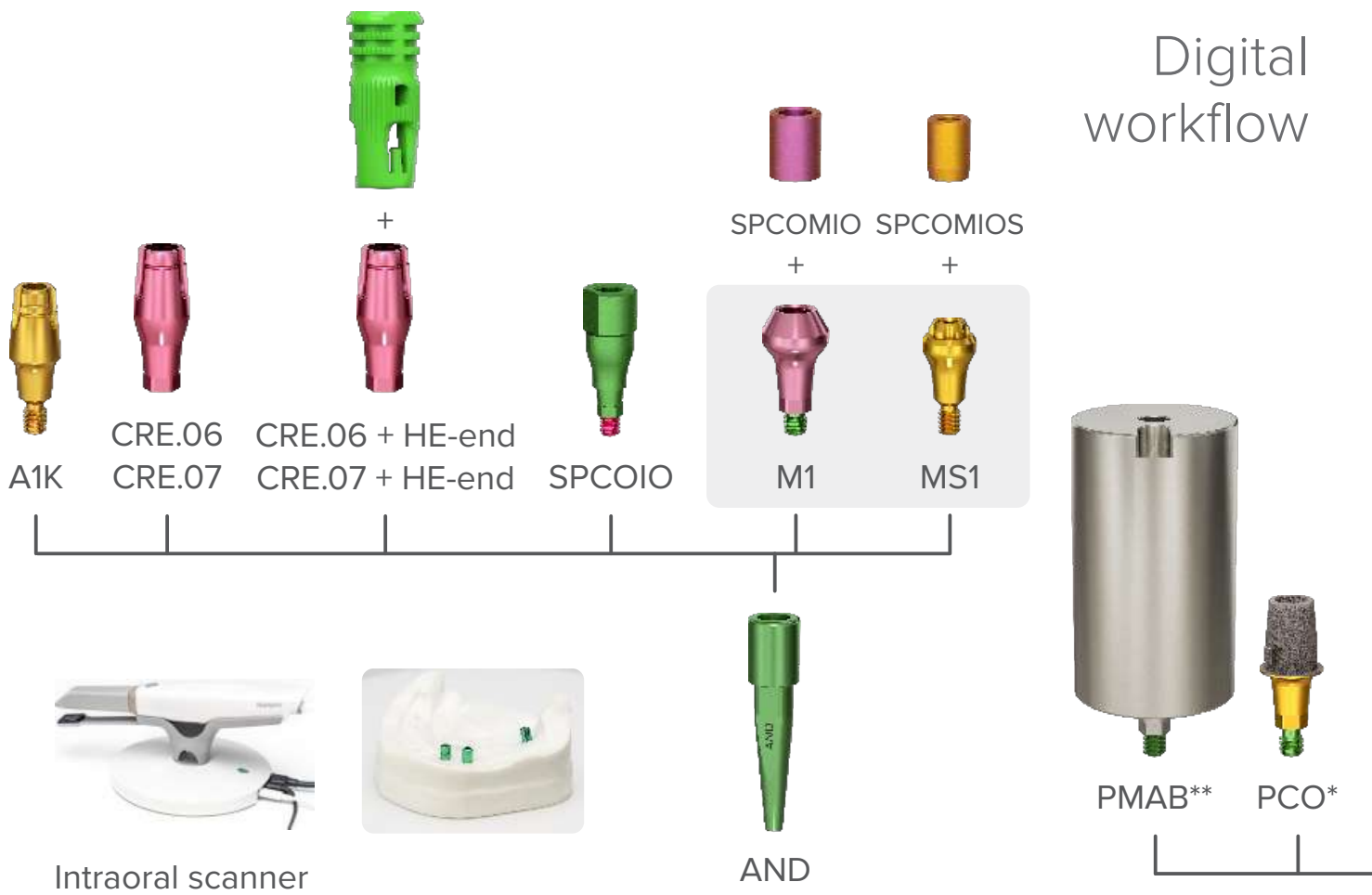

## Scan/Impression

Extraoral scanner

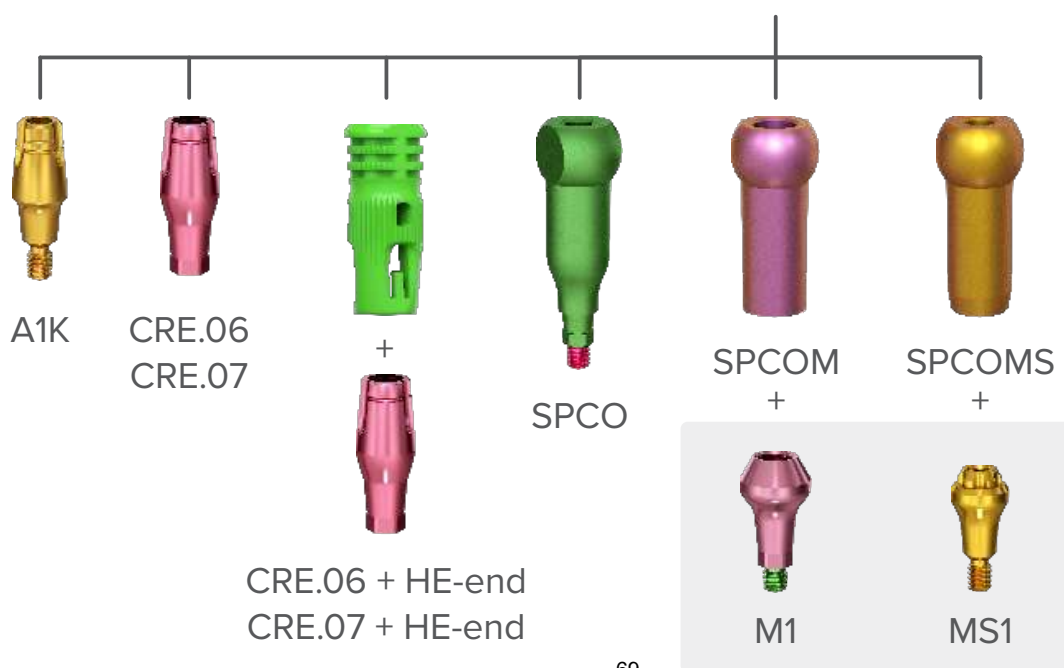



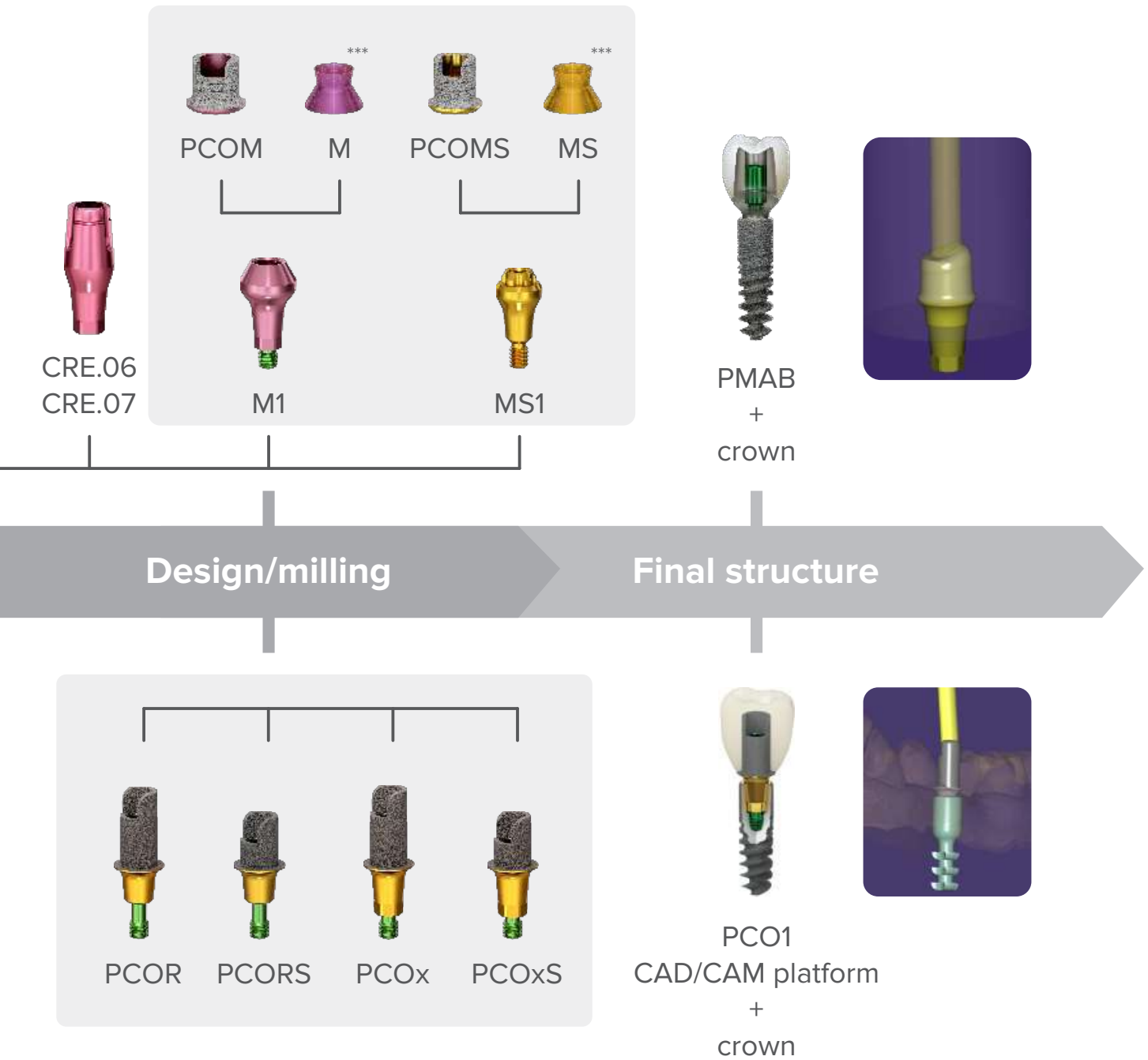

\* Cerec part for Sirona  
 \*\* Premilled abutment blank  
 \*\*\* MU abutment is only accessible in digital library with angulation option and used with SFPCOMS screw for MS1, SFPCOM screw for M1

Abutments in the light grey background are angulated from 0° to 20° and are easily handled with an SDLB screw driver.

# Digital workflow



ANED



TRA



TOES



TOEA



TOE



HE



7mm



5mm



4mm



3mm

External platform



TCE  
TCES  
TCEXS



PCE  
PCES  
PCEXS

Intraoral

Scan/Impression

Extraoral



ANE



ANA



TRA



TOES



TOEA



TOE



HE



7mm



5mm



4mm



3mm

External platform



TCE  
TCES  
TCEXS



PCE  
PCES  
PCEXS

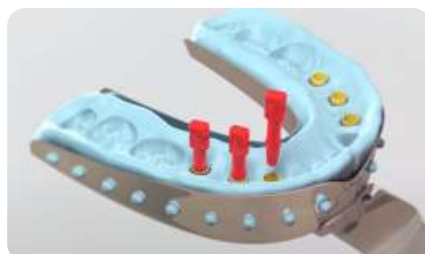



Metal framework

Prosthesis with cement

Design/milling

Final structure

Telescopic abutments  
External platform

Prosthesis with  
telescopic solutions



# Digital workflow

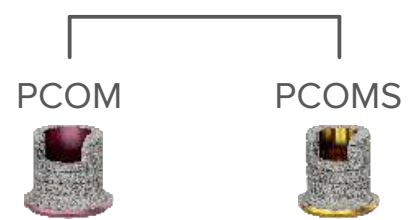
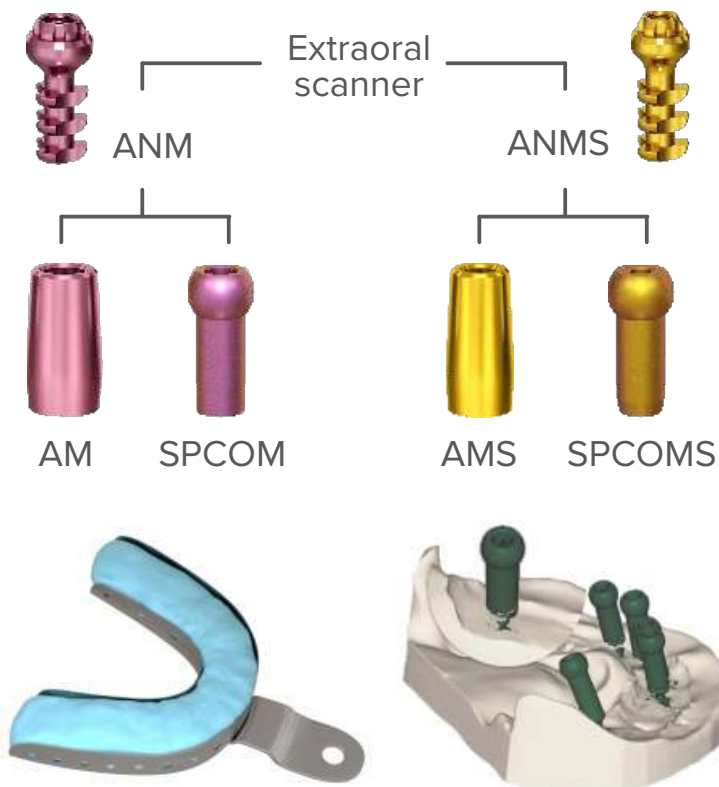
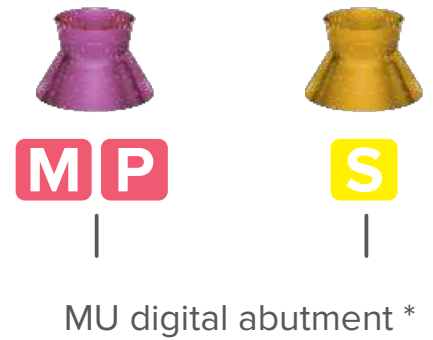
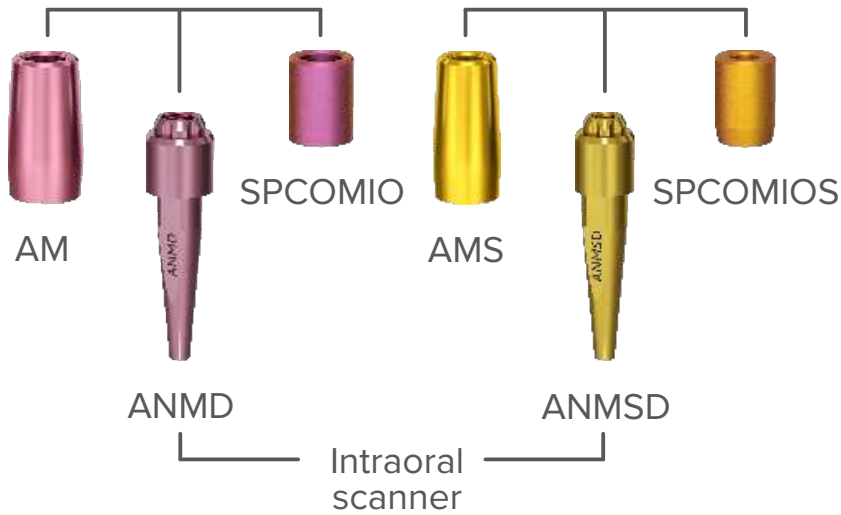
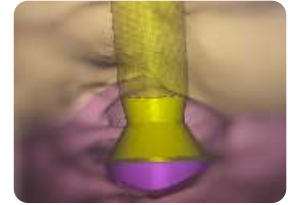
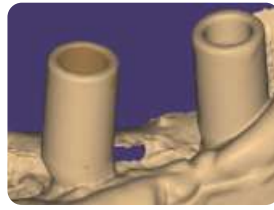
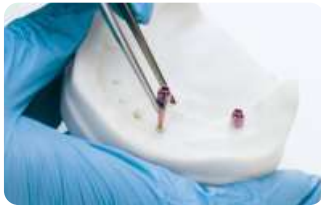



Metal Framework

Final structure

PCOM



PCOMS

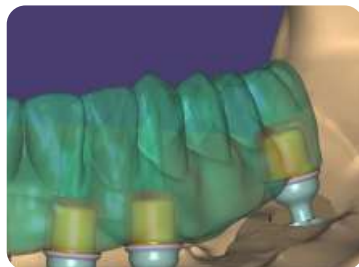

\* MU abutment is only accessible in digital library with angulation option and used with SFPCOMS screw for ROOTT S, SFPCOM screw for ROOTT M/P.

# Together with specialists for standards that matters

ROOTT has always sought excellence and reliability by utilizing innovative approaches and solutions right from the design stage. Since its foundation, ROOTT has put research and cutting-edge innovation at the forefront of its mission. This is the result of diligent, dedicated work and close cooperation with the Open Dental Community (Luxembourg) – an independent, international team of expert dentists and academic professionals, which provides a significant link between industry and dental professionals.

**ROOTT never compromises on functionality and simplicity dedicated to dental professionals.**

## **Simplicity**

Built with profound knowledge and insight of what is necessary for practitioners to achieve perfection in their successful clinical practice.

## **Functionality**

To ensure functionality and flexibility every product is probed, diligent and dedicated for every specialist need. Each and every single piece of product is created with the research of doctors.



Innovations and development network of dental specialists around the world.  
Life learning concept and constant improvement of global dental knowledge and skills.

# Informazioni

## Uso dei prodotti

Gentile Dottore, i prodotti **ROOTT** sono parte integrante di un concetto generale sviluppato per garantire la sicurezza e il successo degli utilizzatori.

Ai professionisti dentali, che utilizzano impianti dentali **ROOTT** o altri prodotti **ROOTT**, sono richieste conoscenze cliniche e tecniche al fine di garantire l'impiego sicuro ed adeguato di tali prodotti in conformità con le istruzioni per l'uso.

Il prodotto **ROOTT** deve essere utilizzato in conformità con le istruzioni per l'uso fornite dal fabbricante. È responsabilità del professionista dentale utilizzare il dispositivo in conformità alle istruzioni per l'uso e determinare se il dispositivo è idoneo alla specifica situazione del paziente. Le istruzioni per l'uso dei nostri prodotti sono disponibili in formato elettronico sul sito web.

Alcuni prodotti e componenti **ROOTT** possono non essere disponibili in determinati Paesi; qualora ci fosse un'esigenza specifica, potete farne richiesta presso i nostri uffici o attraverso i nostri partner commerciali.

---

### Puoi scaricare il catalogo completo dal nostro sito internet



<https://www.roott.it>



[info@mgdentale.it](mailto:info@mgdentale.it)



+39 347 41 42 070



+39 391 47 17 939

### Seguici



Pagine social:

Roott Italy

Roott Global

Open Dental Community

Gruppi:

Roott Italia

Open Dental Community

Canale Video:

Roott Italy Channel



---

**TRATE** AG

**MG** Implant Solution

Headquarters Bahnhofstrasse , 16, 6037 Root, Switzerland

Official ROOTT Store via Vescovo, 56 35020 Legnaro PD

[info@trate.com](mailto:info@trate.com)

[info@mgdentale.it](mailto:info@mgdentale.it)