

Estd. 2014



PARAMAX Inc.

Specializing in Ship Chandling from 2014

About Us

We at Paramax Inc are suppliers of Industrial and Marine items. We were established in 2014 to provide excellent service and supply of safety items to the Indian Navy Ships and Indian Coastguard. Since then, we have grown over the years and have excelled at being Ship Chandlers.

We are an experienced firm as we have been in the business since 2014 and our major clients include Indian Navy, Indian Coast Guard, Ship Building Centre (Visakhapatnam), Hindustan Shipyard Ltd. Visakhapatnam Port Trust, L&T.

Our Vision

Our vision is to provide our clients with efficient and timely supply of quality marine products and to empower our customers with safety and security for them operate and travel on the seas and shores with freedom.

Our Mission

Our mission is to become pioneers in the field of supply and service of marine products and provide quality products and services to ensure safety and security of our clients and to have a positive impact on the world and people around us.

Our Product Range:

Safety Equipment:



Liferaft Lashing Belt



Distress Flare - LTA, MOB, Smoke, Hand Flare & Parachute Signal



HRU for Liferaft & EPIRB's



Work Vest



Life Buoy



Life Buoy / S.I. Light



Life Buoy Life Line



Life Jacket Light



Nautical & SS Whistle

Fireman Outfit:



Fireman Helmet



Explosion Proof
Torch



Fireman Rubber Boots



Insulated Handle
Fire Axe



Fireman Safety
Waist Belt



Fire Proof Lifeline

SCBA / Self Contained Breathing Apparatus

The RHZK series Positive Pressure Air Breathing Apparatus is a kind of automatic open-type air breathing device. It is mainly applicable in firefighting, chemical industry, ships & vessel, petroleum, smelting and mine industries. It can help the fireman or the ambulance men to safely extinguish the fire, to safely deal with an emergency, or to safely carry out the rescue work in adverse circumstances where there are full of dense smoke, poisonous gas, steam, or lack of oxygen.



Components and materials

- Full face mask with silicone strap
- Air Hose with quick connector
- Supply valve with gas switch
- Pressure gauge with alarming whistle
- Back support kits (with shoulder belt and waist belt)
- Pressure Reducer
- Gas Cylinder and cylinder valve
- Plastic packing case

Technical Data

- Cylinder Volume: 6L
- Working Pressure: 30MPa
- Performance time 55-60 min
- Alarm Pressure: 4-6 MPa
- Approval: CCS/EC

Model	Working pressure (Mpa)	Volume (L)	Air Deposit (L)	Using Term (min)	Alarm Pressure (Mpa)	Weight (Kg)	Packing (mm)
RHZK6/30	30	6	1800	50-60	43196	714	750×300×480

EEBD / Emergency Escape Breathing Device

Emergency Escape Breathing Device are only used for escape from a compartment that a hazardous atmosphere to provide personal breathing protection. It has a pressure gauge on the cylinder to indicate the cylinder pressure. The hood is a flame resistant head cover which completely covers the head, neck, and may cover portions of the shoulders, there is a clear window on it.



This EEBD is based on the IMO MSC.98 (73) adoption of the resolution, on July 1, 2002 as required by mandatory type "international fire safety systems" design and manufacture of marine products.

This product is certified by the CCS, with shipping. It consists of compressed air bottle, pressure reducer, pressure gauge, gas ducts, hoods, backpacks and other components can provide individuals more than 15 minutes of constant gas, available in a toxic, hazardous, smoke, oxygen environment personnel escape use.

- Model: THRS 15
- Cylinder Volume: 3L
- Working Pressure: 21MPa
- Performance time: 15 min
- Alarm Pressure: 4-6 MPa
- Approval: CCS/EC

Fire Extinguisher



ABC, DCP, Mechanical Foam, Co2, Water Co2 - IRS & ISI Approved

Fire Nozzle & Coupling



Fire Hydrant



Foam Applicator



Fire Hose Box



International Shore Connection



Fire Hose



Fire Axe



Fire Bucket



Heat & Smoke Detector



SOPEP / Oil Spill Kit

Marine Specific Oil Fuel Spill Kits are specifically designed to recover oil spills from water. Housed in durable bins, these mobile kits can be stored close to spill prone areas for immediate spill response. Ideal for the control, containment and clean up of oil spills in ponds, dam, rivers, bays, harbours, and waterways. Making these spill kits the perfect solution when protecting jetties, shorelines and riverbanks from oil contamination.

240 Liters



120 Liters



Description	Size	Qty 240L	Qty 120L
Oil Absorbent Pads	16" x 20", 2mm	100	50
Oil Absorbent Socks	3" x 4'	5	3
Oil Absorbent Socks	3" x 8'	5	2
Oil Absorbent Pillows	18" x 18"	5	3
Nitrile Gloves		1 Pair	1 Pair
Goggles		1	1
Spill Response Guide		1	1
Disposal Bags		10	5
Spillkit Label		1	1
Wheeled Bin	240 / 120 Ltr	1	1

POLYFORM Fender & Buoy

Heavy Duty and All Purpose

FENDER: F - Series



Model	F1	F2	F3	F4	F5	F6	F7	F8	F11	F13
Size (Dia. X Length)	6x24in. 15 x 61 cm	9x24in. 22x61 cm	9x29in. 22x74.5 cm	9x41in. 22x104 cm	12x30.5in. 29x77.5 cm	12x43in. 29x109 cm	15x40in. 37.5 x 102 cm	15x57in. 37.5x144 cm	21x 57 in. 59x145.5 cm	29.5 x 74in. 75x188 cm
Eye Diameter	22	28	28	28	28	28	28	28	28	40
Piece / Carton	20	10	10	10	10	10	5	5	3	2

BUOY: A - Series

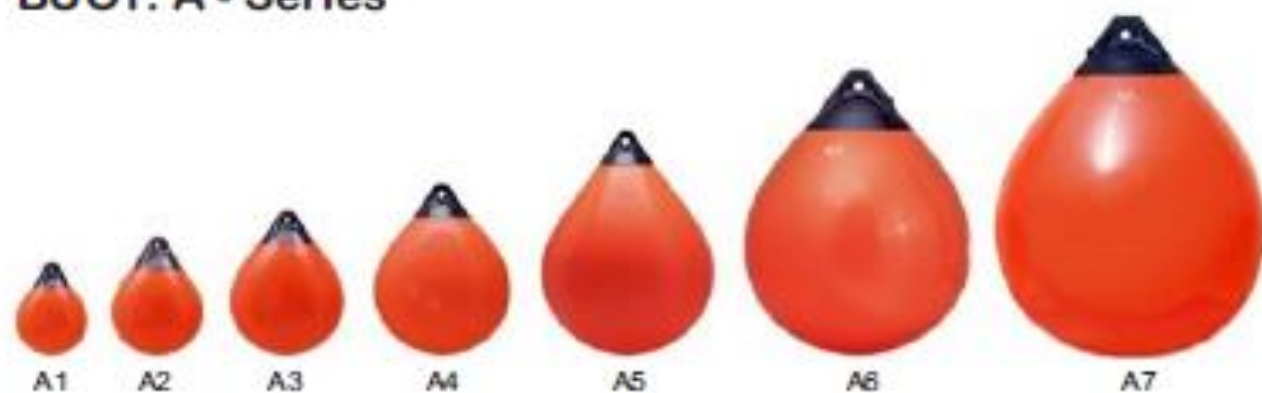

Model	A1	A2	A3	A4	A5	A6	A7
Size (Dia. X Length)	12 x 15in. 29.5 x 38 cm	15.5 x 19.5 in. 39x 50 cm	18 x 23 in. 46 x 57.5 cm	21.5 x 28 in. 55 x 71 cm	28x 37 in. 71 x 94 cm	34 x 44 in. 85 x 112 cm	43.5 x 56 in. 110 x 142 cm
Eye Diameter	22	25	28	28	28	35	60
Piece / Carton	10	10	7	7	5	3	2

Pneumatic Fender



Black



White

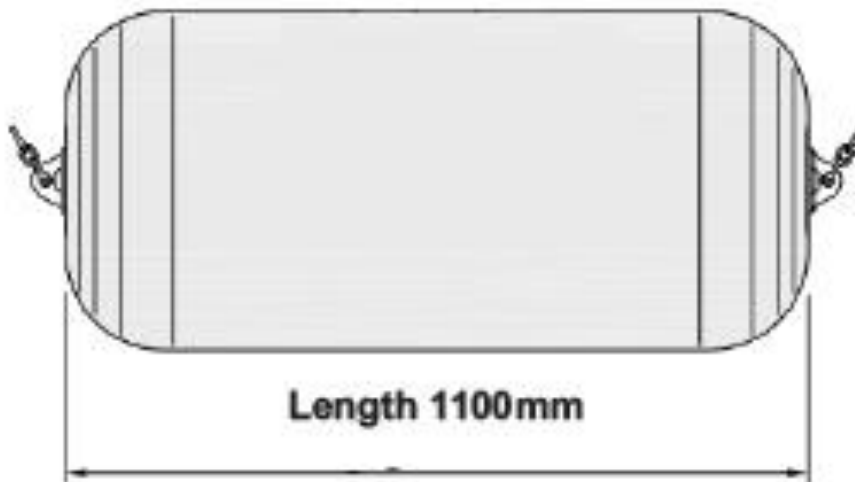

Length 1100mm



Diameter 660mm

Pneumatic fenders 1100mm x 660mm have a special outer rubber double-layered cover, which consists of a single cover and an extra tyre cord layer, resulting in better resistance to operational damages. These Fender is use for critical protective medium against collision during ship to ship transfer operation and ship to dock. At each end of this fender, a flange with shackle and swivel is mounted to which a chain or cable can be attached.

- Available in Black & White Color
- Can filled by Air or Foam
- High energy absorption with a low reaction force
- Adjust performance by varying internal pressure
- Suitable for areas with tidal difference
- Low maintenance
- Low transportation costs

PLASTIMO

Offshore® 105 & 135

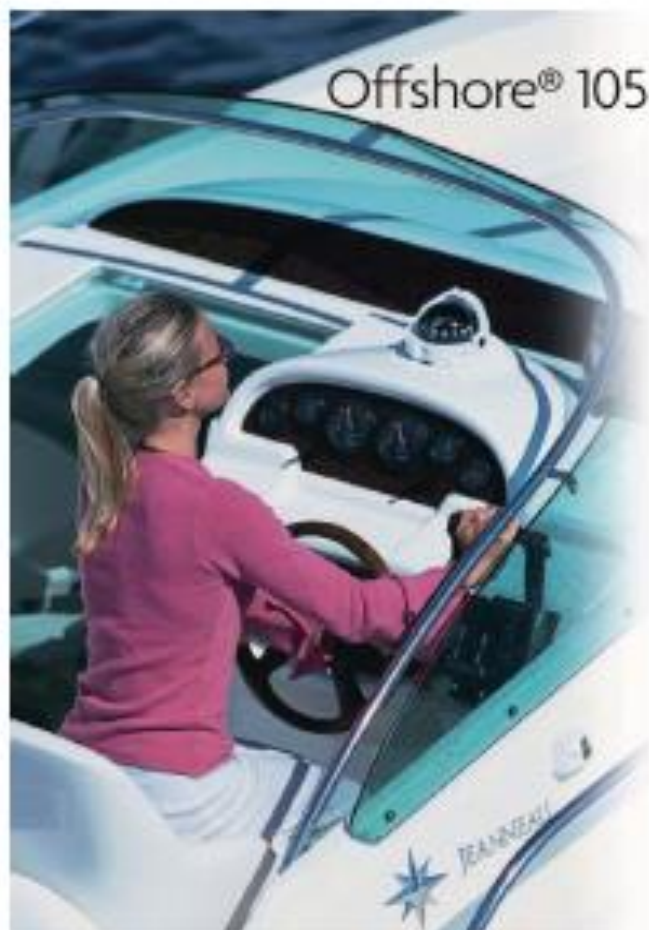

ISO 613 5 year warranty

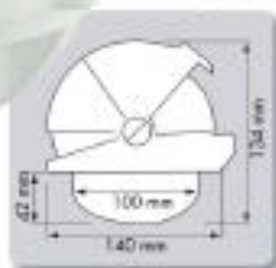

Offshore® 105

	OFFSHORE 105
Boat size	Powerboats of 5 to 9 m (17 to 30 ft).
Compass card	Graduated every 5°, approx. Ø 91 mm. Hoisting numerals every 30°.
Hood/sunshade	Articulated protective hood: built-in sliding cover, composed of 3 telescopic parts.
Mounting	Comes as standard in a flushmount version. Can be bracket-mounted with the addition of optional bracket.
Resistance to vibrations and hull pounding	Magnetic cell mounted on shock absorbers.
Lubber line	1 lubber line.
Compensation	Supplied as standard.
Lighting	• On flat card: 2 bulbs, 12 V. • On corical card: 1 bulb, 12 V.
Approval/homologation	ISO 613 compliant.

OFFSHORE 105	Flushmount	Optional bracket kit*
• BLACK COMPASS		
black flat card	17263	17268*
black corical card	17264	17268*
• WHITE COMPASS		
black flat card	17265	17267*
black corical card	17266	17267*
white corical card	48972	17267*

*The bracket kit includes the actual bracket and the adequate screws. A bracket mount support consists of one flushmount compass, plus one bracket kit (products both references when ordering).

Solar Navigation Light ALD3NM



blue, amber, red, green, white 5 kinds of color available

FEATURE & BENEFITS

1. All components of the item are replaceable
2. Waterproof design ensures the long life span and suitable for all environment application
3. High intensity output and high transparent housing bring over 5km visual range at night
4. Industrial-level self-contained solar LED beads
5. Optional colors for whatever condition our client use them to
6. Automatic operation from dark to dawn, if the battery is in low voltage, it starts flashing every 8 seconds
7. Adjustable intensity intelligently meets various needs in different environmental applications
8. Internal switch and vandal resistance design avoid mal-operation and destruction by mistake
9. Easy installation requires no special tools and technicians
10. No special maintenance and servicing for up to 10 years with exception of battery replacement if it dies

DIMENSIONS & WEIGHT

Height	8.353" (212mm)
Width	8.648" (227mm)
Weight	3.3 lb (1.5 kg)



TECHNICAL FEATURES AND SPECIFICATIONS

Solar Panel	2.5Wp, High-efficiency mono cells with glass encapsulation				
Light Source	High power LED, Colour-specific				
Battery	Replaceable & Recyclable LFP (average 7 year life)				
Vertical Divergence	0 to 30°				
Flash Patterns	35-40 Flash Per Minute				
Construction	Premium grade UV stabilized				
Coloured Lens Option	Can be Customized for big order quantity				
Available LED Colours	Red, green, blue, amber, or white				
Horizontal Output	360°				
Mounting Options	4 bolts				
Ambient Operating Temperature	-22 to 122 °F (-30 to 50 °C)				
Ambient Storage Temperature	-40 to 176 °F (-40 to 80 °C)				
Visual Range	Flashing Up to 4NM and Steady Up to 3NM				
Autonomy At Full Charge	Red	Green	Blue	Amber	White
Steady 75% Intensity	30h	20h	30h	26h	21h
Flashing 75% Intensity	470h	300h	300h	340h	310h
IP65 Waterproof Rating	Yes				

Configuration

1. Effective intensity adjustment



The effective intensity of ALD3NM is a measure of its apparent brightness, we have 4 kinds of programmed intensity.

you can use slotted screwdriver change a ALD3NM light's effective intensity easily



intensity can be adjusted from 25%, 50%, 75% and 100% of total intensity, four levels of intensity adjustment manually

2. Flash / steady adjustment



adjust the switch to ON, then it's flashing mode, adjust the switch to OFF, then it's steady mode

3. Toggle switch



Turn On or Off easily by your finger moving the toggle switch towards the ON or OFF side.

Solar Warning Light

Parameter	Picture
<p>Marine Solar Warning Light</p> <p>Parameter:</p> <ul style="list-style-type: none">◎Light source:Φ5 super brightness LED * 4pcs◎Flash Rate: 110times/min (can adjust as your request)◎Visible Distance:≥500M(In the dark)◎Power: Ni-MH 1.2V 1300mAh 0.2W monocrystalline solar panel◎working time:can work last for 8days in cloudy days.(12h per day)◎Material:PC, aluminium alloy◎Warranty: 3-5years◎Size: Φ90*160mm◎N.W: 360g / pcs◎Working temperature: -20℃ ~ 55℃ <p>Features:</p> <ul style="list-style-type: none">◎ON—OFF power button.◎Light control design,can work automatically according to the environmental brightness.◎PC Shell anti-impact, strong and durable.◎There is a roll of high reflective film on the surface. It can reflective automatically in the night.◎Rain proof, can work normally in the rain. <p>Remark: The above product is subject to the object. If making any changes, we do not issue a separate note.</p>	 <p>Dimension 90mm x 90mm x 160mm</p>

Single & Double Tier Navigation Light

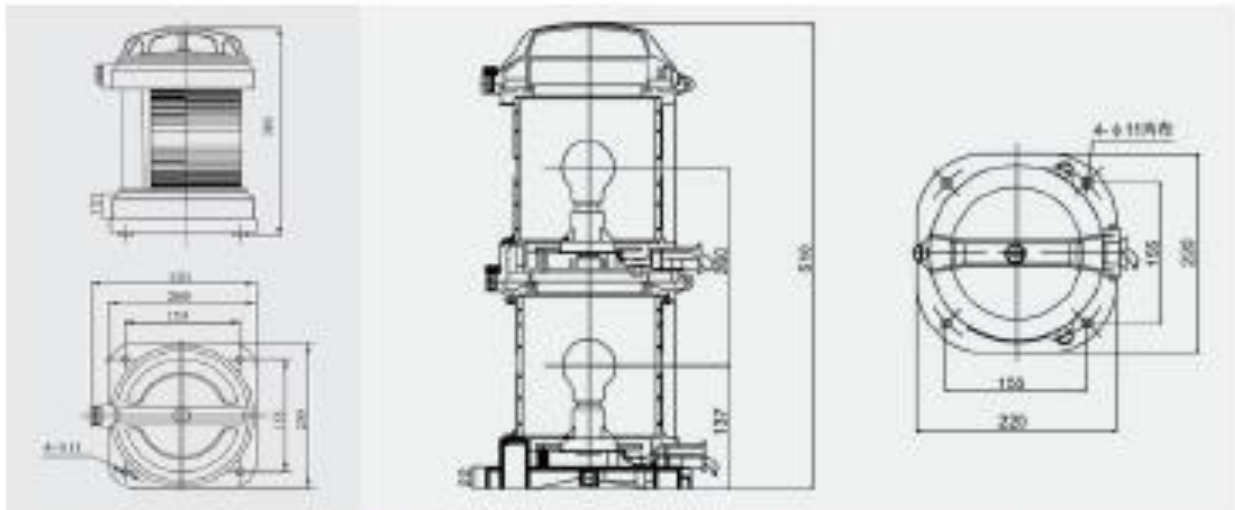

Name	Visible Distance	Level Arc	Colour
Starboard Green	3n.m	112.5°	Green
Port Red	3n.m	112.5°	Red
Masthead	6n.m	225°	Transparent
Stern	3n.m	135°	Transparent
All-Round White	3n.m	360°	Transparent
All-Round Red	3n.m	360°	Red
All-Round Red	3n.m	360°	Green

“Classic 20” Lights

The “Classic N20” series of navigation lights is designed and type-approved for vessels under 20m. Made of a special compound of ABS and polycarbonate with shatterproof acrylic lens, non-magnetic stainless steel electrical contacts and a nitrile water resistant seal to provide reliable long life.



Code	30501	30502	30503	30504	30505
Description	Starboard Green 112,5°	Port Red 112,5°	Stern White 135°	Masthead White 225°	Bi-Color 225°
Housing	Black				



Code	30511	30512	30513	30514	30515
Description	Starboard Green 112,5°	Port Red 112,5°	Stern White 135°	Masthead White 225°	Bi-Color 225°
Housing	White				



Code	30521	30522	30523	30404	30543
Description	Single Green 360°	Single Red 360°	Single White 360°	Tricolor 360°	Single White 360°
Housing	Black				White

Spare Bulbs for 20 meter Navigation Light



12V / 25W & 24V / 25W

“Classic 12” Lights

The “Classic N12” midi series of navigation lights is designed and type-approved for vessels under 12m length. Made of tough UV stabilized ABS plastic with shatter-proof acrylic lens, non magnetic stainless steel electrical contacts and a nitrile water resistant seal to provide reliable long life.



Code	30091	30092	30093	30094	30095
Description	Starboard Green 112,5°	Port Red 112,5°	Stern White 135°	Masthead White 225°	Bi-Color 225°
Housing	Black				



Code	30101	30102	30103	30104	30105
Description	Starboard Green 112,5°	Port Red 112,5°	Stern White 135°	Masthead White 225°	Bi-Color 225°
Housing	White				



Code	30111	30112	30113	30114	30115
Description	Signal White 360°	Signal Green 360°	Signal Red 360°	Tri-color 360°	Signal White 360°
Housing	Black				White

Spare Bulbs for 12 meter Navigation Light



12V / 10W & 24V / 10W

ALDOUX[®]

NEOPRENE RUBBER IMPELLER



 JOHNSON	 JABSCO	 VETUS
 Cummins Onan	 SHERWOOD	 VOLVO
 YAMAHA	 ANCOR	 MERCURY <i>MerCruiser</i>
KOHLER	 Perkins	 CATERPILLAR

Suitable For All Brands

- Heavy duty bilge pump construction for used in boat hulls / bilges Bait tanks Ponds, pools, spas
- Heavy duty motors with stainless steel shafts and tough. thermoplastic bodies
- Small size, high efficiency, low current (low cost switching power supply supporting); to achieve a small size perfect combination of high flow
- Snap lock strainer base for easy installation and removal; Silent and vibrationless operation
- Water/moisture tight seals; Stainless steel shafts; Rustproof and corrosion resistant

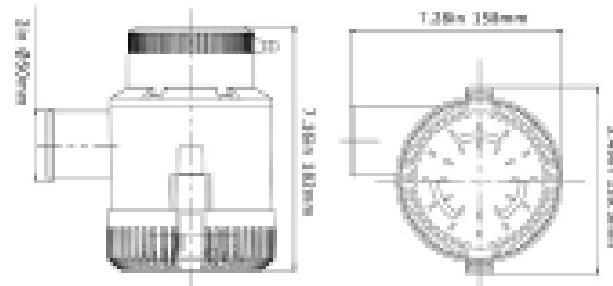
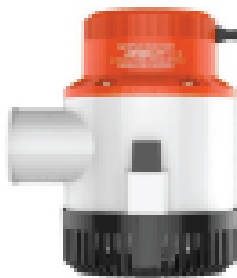

Flow Rate	Voltage	Max Draw	Fuse Amps	Wire Lead	Outlet Dia
4700 GPH	12 V	17.0 A	26.0 A	1 Mtr	50 mm
4700 GPH	24 V	11.0 A	16.0 A	1 Mtr	50 mm

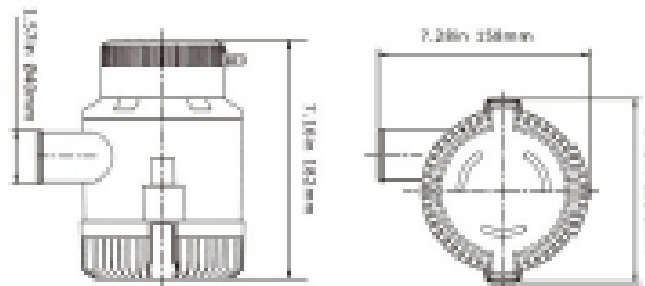

Flow Rate	Voltage	Max Draw	Fuse Amps	Wire Lead	Outlet Dia
3700 GPH	12 V	16.0 A	25.0 A	1 Mtr	40 mm
3700 GPH	24 V	10.0 A	15.0 A	1 Mtr	40 mm

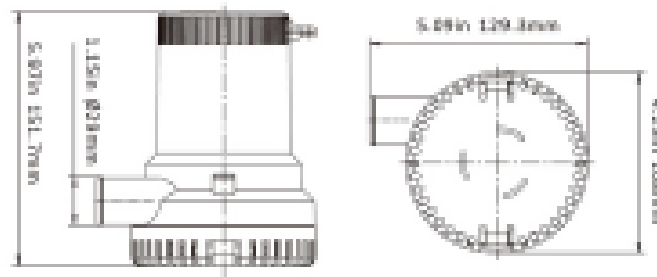

Flow Rate	Voltage	Max Draw	Fuse Amps	Wire Lead	Outlet Dia
2000 GPH	12 V	8.5 A	14.0 A	1 Mtr	29 mm
2000 GPH	24 V	5.0 A	8.0 A	1 Mtr	29 mm

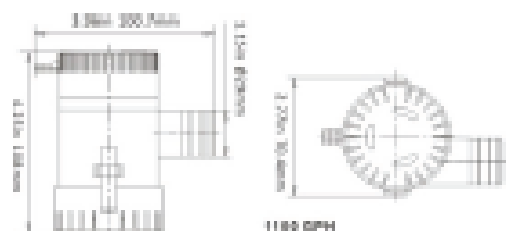

Flow Rate	Voltage	Max Draw	Fuse Amps	Wire Lead	Outlet Dia
1100 GPH	12 V	3.0 A	5.0 A	1 Mtr	29 mm
1100 GPH	24 V	1.8 A	3.0 A	1 Mtr	29 mm

Automatic Bilge is a self contained all-in-one pump and float switch. The pump turns on once the water level raises and turns off once the water has been pumped out and the level has fallen.

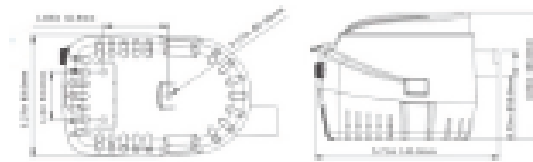

Flow Rate	Voltage	Max Draw	Fuse Amps	Wire Lead	Outlet Dia
750 GPH	12 V	3.0 A	5.0 A	1 Mtr	19 mm
750 GPH	24 V	1.6 A	3.0 A	1 Mtr	19 mm

Shower Sump Pump Drain Kit System

- 12V/24V 750GPH Multi-Port Shower Sump / Grey Water System. Internal Float Switch- Automatically turns ON & OFF system.
- Outlet Port: 3/4" Multiple Inlet Ports: 3/4" Port, 3/4" & 1" Port, 1-1/8" & 1-1/2" Port
- The check valve on the outlet stops water from flowing back into the tank.
- Easy installation. Multiple inlet ports for versatile usage

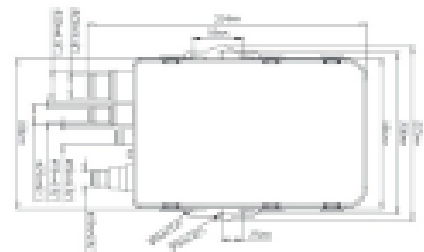
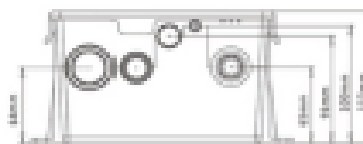

Flow Rate	Voltage	Max Draw	Fuse Amps	Wire Lead	Outlet Dia
750 GPH	12 V	3.0 A	5.0 A	1 Mtr	19 mm
750 GPH	24 V	1.6 A	3.0 A	1 Mtr	19 mm

Float Switch

12-24-32-VDC Bilge Pump Float Switches are the Switch of choice for selective boaters all over the world. Featuring quality design and construction to offer reliable engagement of your bilge pump. For pumps drawing up to 20 amps.

- Turn pump on when water level reaches 2" (51mm) & Turn pump off when water level reaches 3/4" (19mm)
- Ideal flow sensor for bilge pumps. Suitable for use with 12v DC or 24v DC bilge pumps.

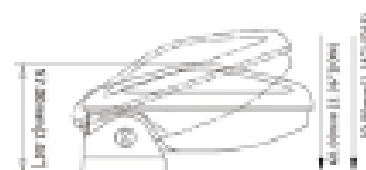
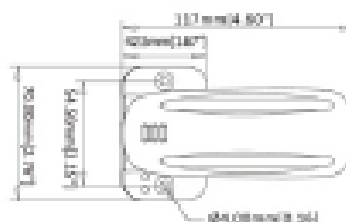

Voltage	Max Amps 12 Volts	Max Amps 24 Volts	Wire Lead	Wire Gauge Size
6-12-24-32V	18.0 A	8.0 A	1Mtr	16AWG

Seaflo Hand Bilge Pump use for mounting on bulkhead or deck. This is a good manual bilge pump for small to medium-sized boats. Lightweight and sturdy, its easy lever action allows fast pumping. Easy to use and maintain, the diaphragm is quickly accessed for removing debris.

- Tough and lightweight polypropylene material is suitable for many applications
- 1.3" ID Hose Outlets designed for high flow
- Pump Body: Glass-filled Polypropylene, Diaphragm: EPDM, Fasteners: Stainless Steel

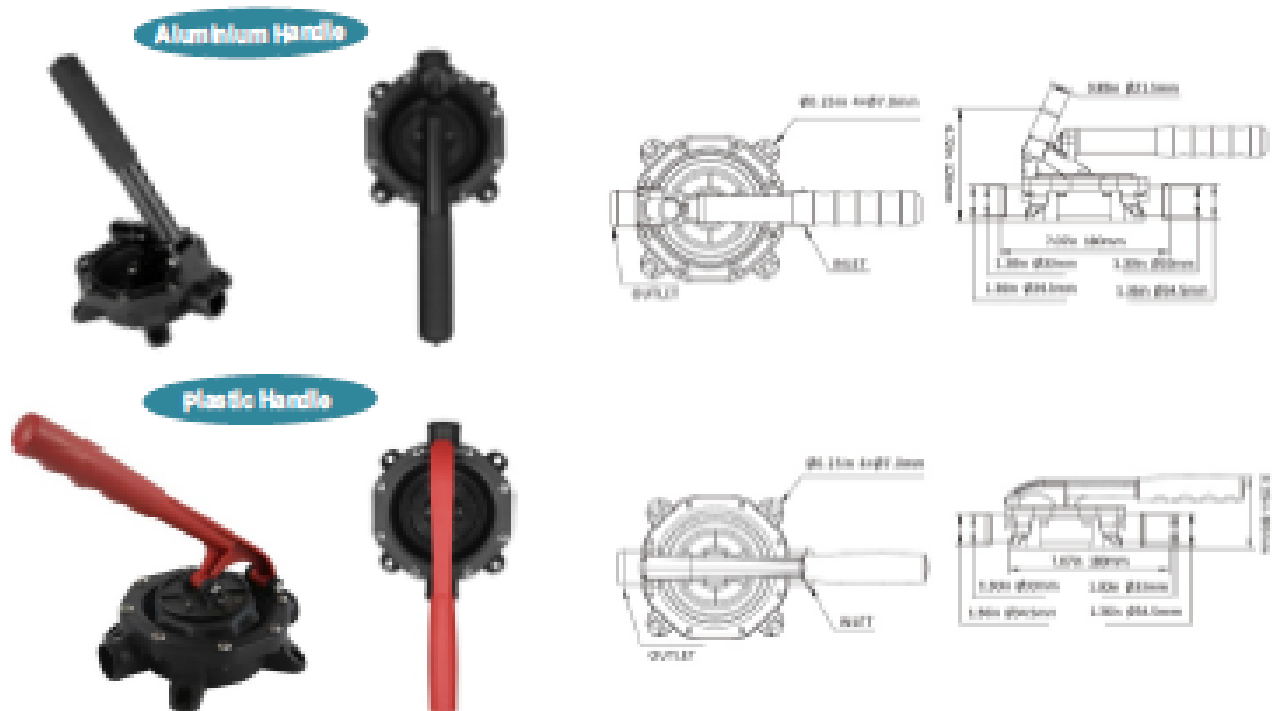

Flow Rate	Handle	Hose Connection
720 GPH	Aluminium / Plastic	1.36" (34.5 mm)

Gusher Hand Pump

Lightweight with light easy action. Self priming up to 1/3-1/2 feet. Spring-assisted outlet valve for easy priming. Easy removable clamp for quick maintenance and easy to install.



FlowRate	Hose Connection
1320 GPH	1-1/2" (38 mm)

Inflatable Foot Operated Pump

Full Throttle Manual Inflation Foot Operated Pump with 4 Different Adaptors

- Compact, lightweight design
- Use foot to inflate
- Universal adaptors to fit various valves
- Includes hose wrap to keep hose and adaptors conveniently attached
- Inflates up to 3 PSI





Diaphragm Fresh Water Pump

This 3-chamber diaphragm pump provides up to 2.9 gallons per minute and is capable of self-priming up to 6 vertical feet. Serves 3 or more 1/2" (13 mm) outlets. This automatic demand water system pump has a built-in pressure switch, which automatically starts and stops when the faucet is opened and closed. They're easy to install, service and winterize.

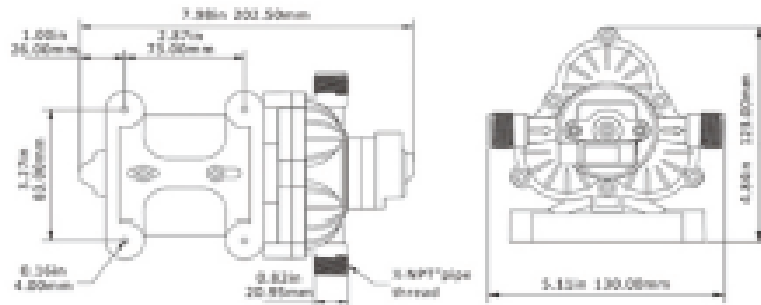

Voltage	Open Flow GPM/LPM	Max Draw	PSI/BAR	Hose Connection
24 V	2.9 / 13	3.5 A	40 / 2.8	0.82" (20.95mm)

Battery Switch / Isolator

Battery Selector Switch will allow the use of one battery for engine starting and one battery for auxiliary electrical equipment. Batteries may be placed in parallel by switching to (BOTH) for emergency usage. Small in size, Fine appearance, Sturdy and durable. Battery Selector Switch – They permit selection between batteries for starting and charging or operation of both batteries in parallel.

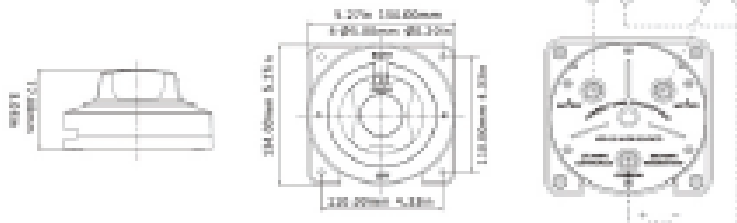
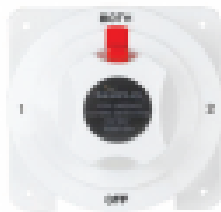

Max. Volt	Amp Draw	Max Amp Draw	Switch Position
6-12-24-32 V	175A	300 A	3



Foot Operated Pump

TMC foot operated galley pumps are designed to be used as freshwater pumps in Sailboats, and Boats. They are rated at 4 GPM (240GPH). The hose connection ends rotate approximately 235° (have the red covering). There are four mounting slots on the bottom and also four holes on the face that can be used for mounting.

- Multi-directional inlet and outlet hose connections make installation easier
- Low cost freshwater system for faucets and showers
- Materials: Pump Body: Acetal, Nylon Diaphragm: Nitrile, Neoprene, Fasteners: Stainless Steel

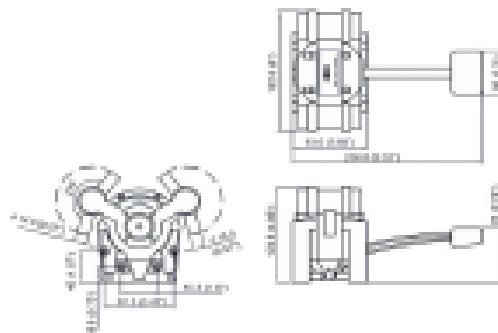

Capacity	Hose Dia.	Dimension (L x W x H)
240 GPH (908 LPM)	1/2" (13 mm)	9.32" x 6" x 4.86"

Navtech 65 & 35 illuminated marine boat compass



- Sea Marine Compass
- Illuminated pivoting compass
- Wired for 12 Volt LED light illumination
- Visible Lubber Line
- With Adjustable Mounting Bracket
- Adjustable Sun Visor
- Individually balanced dials for Precision
- Fast Response and precision Engineering
- Corrosion Resistant
- Waterproof, durable and long lasting
- Built in Accuracy compensators
- Windshield or Dash Mount
- Easy to read precision dial
- With Mounting screw slot
- Suitable for Watercraft, Boat, Caravan and Truck
- This compass is designed for boat or watercrafts.

Model	Color	Dimension (H x L x W)
Navtech 65	Black	102mm x 137mm x 94mm
Navtech 35	Black	64mm x 87mm x 61mm

Fuel / Water Sensor



- Available Size : 7 to 60 inch
- Material : All Sending unit Constructed out of 316 type Stainless Steel & Operate on Vertical Plane
- Model Prefix & Mounting Method : Standard SAE 5 Hole Patterns, 2.125" Bolt Circle
- 40 - 30 OHM Operation
- Anti-vibration, Stronge, Advanced corrosion resistance
- High quality fuel level sensor
- Economical level sensing solution, long service lifespan

Fuel Filter Separator

High-performance fuel injected engines require ultimate water separation, fuel filtration and maximum fuel flow. This filter elements deliver all three of these critical performance factors and are engineered for today's stern drives, inboards, and 2-cycle and 4-cycle outboards.



- 10 Micron Replacement Filter
- Remove 99% of emulsified water from fuel
- Designed to be an exact fit and meet specifications of OEM canister filters
- 90% efficient at removing particulate contamination
- Maintains fuel flow while filtering water and debris
- Replaces : Mercury 35-807172, 35-604994-1, Aqua Power 6001 GLM24940, Sierra 18-7850, SMI 494 and Universal
- Replacement Cartridge for 18-14550

Fuel Line Assembly & Hose

Marine Outboard Boat Universal 3/8" Fuel Gas Hose Line Assembly with Primer Bulb

It includes a premium quality rubber bulb and 3/8" fuel hose, 360° stainless steel hose clamps.

Premium quality rubber bulb with built in check valve offers superior resistance to U/V, ozone and alcohol enhanced fuel.

Upgrade older tanks to the latest low-permeation fuel line standards with this fuel line assembly.

Fully compatible with Ethanol blended fuels.

Meets EPA low permeation mandates.

Engineered low permeation material prevents fuel evaporation.

Bulb engineered to maintain flexibility and prevent collapse in hot and cold temperatures.

Fitment : suitable for boats, RVS, tractors, and caravans.

Note : This is universal fuel line and as such do not come with engine or tank fittings.



Material : Rubber

Size : 1.9 Mtr

Hose Dia : 3/8"



25 & 100 Meter Roll of Flexible Hose Dia 8 x 13
Fuel Resistant, Reinforced PVC

Primer Bulb



- 3/8" Universal Primer Bulb
- Exclusive three-layer construction prevents collapse under vacuum and ballooning/bursting under pressure
- Exclusive high-efficiency check-valves for faster priming and low fuel restriction (less than 1kpa restriction at 50 liters/hour)
- Engineered hose barbs and stainless steel steeples clamps for leak-free performance
- Compatible with Ethanol blended fuels

Motor Flusher



- Effective way to flush engine to remove salt, sand, silt and grime & to reduce corrosion
- Large rectangular 4-4/5" x 3" (123 x 76mm) PVC cups
- Black coated spring steel frame for quick & secure connection
- Easy to connect - Simply slide cups over the top of the water intake slots and connect your garden hose to the quick connect fitting
- Suits most outboards & stern drives (which have side water intakes on the lower unit)

Fuel & Water Gauge

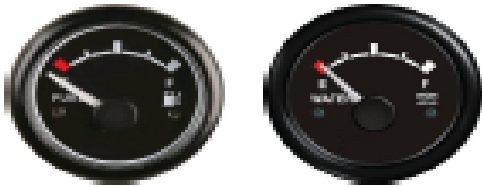

The Fuel and Water Tank Level Gauges allow the user to remotely monitor the liquid level in the tank. These level gauges will work with any level sender with the corresponding resistive output.

Extra Circuit for 24V

Size 52mm

Kill Switch / OBM Key



- Includes seven keys to fit all Johnson, Evinrude, Mercury Yamaha, Suzuki, Tohatsu and Honda kill switches
- Solution to a lost or broken key.
- Swivel snap hook prevents tangles
- Rust resistant stainless steel clips
- Corrosion proof
- Includes red lanyard

Deck Plate



- Round Deck Plate with ABS Plastic is a cover that would not open unexpectedly. Maximum water tightness. Prevent jamming closed or cross-threading that would prevent a cover from being closed.
- It is designed to provide access without the use of tools, with a single start, non-jamming (no cross-thread), extra strong, self-cleaning buttress thread. They incorporate a self-aligning center and an innovative gasket to assure a watertight seal. A unique back-up sealing wall leaves the plate water resistant, even if the gasket is removed.

Retro Reflective Tape



- SOLAS Grade Retro Reflective Tape
- One continuous roll measures 2 inch (50mm) wide x 50 Meter long.
- Aggressive Self Adhesive Tape with peel off backing.
- Reflectorizing SOLAS life support equipment such as life Buoy, Vests, Jackets, Rafts, etc.
- Retro Reflective material used to enhance visibility of life-saving equipment in nighttime, or low-light conditions.
- Reflective Material SOLAS Grade products are silver in color with Honeycomb type, flexible reflective material with an aggressive pressure sensitive adhesive.

Marine Day Vision Binocular 7x50



- Brand Name : COMET
- Magnification : 7X
- Objective Lens Diameter : 50mm
- Material : Metal, all-optical glass, rubber
- Color : Black
- Eyepiece Diameter : 24.5 mm
- Angular field of view : 7 degree
- Field of view : 125 m / 1000 m
- Exit Pupil Diameter : 5 mm
- Eye relief: 15.5 mm
- Close focus: 5 m / 16.4 ft
- Focus system : center focus
- Light Intensity : 23
- Twilight Factor : 22
- Resolution : 11.5
- Prism : bak7
- Middle wheel for adjusting focal length
- Environmental anti-sliding design
- Product Size : 195 x 52 x 187 (mm)

Package Include:

- 1 X Binocular
- 1 X Backpack
- 1 X Lens cleaning cloth
- 1 X User Manual
- 1 X Lanyard

Extra-wide field of view. Classic design with comfortable grip. Endurable metal prism housing & focusing mechanism. Sharp & crispy image.

Glow Stick

Glow stick measuring 6" long, for providing instant 360 degree illumination, that can be seen up to a mile away for more than hours in optimal conditions.



- Ideal for safety and emergency lighting, instant patio lanterns, area markers and personal safety markers.
- All your safety and survival aid products for inshore and offshore use
- It is waterproof, non-toxic, and non-flammable
- Battery-free emergency lighting
- Provides hours of soft, glowing light
- Weatherproof

Instruction for use:

Bend the Glow Stick enough to break the internal capsules. Shake to mix and start the glow reaction! It have pre-attached safety hooks which can be removed to make a lanyard hole.

Single & Double Trumpet Horn

12v/24v Heavy Duty Single & Double Trumpet Air Horn 304 Stainless Steel is made in Waterproof and shockproof design. It has High performance with strong and pleasant sound; Long life and reliable quality. It is given extra protection through the complete over-molding of the internal motor cover housing. This extra process provides the added protection.



Voltage	Current	Frequency	Sound Level	Length	Diameter
12 V	5 A	310/370 +/- 20HZ	>= 130 DB	410mm	101mm
24 V	2.5 A	310/370 +/- 20HZ	>= 130 DB	410mm	101mm
12 V	7.4 A	310/370 +/- 20HZ	>= 150 DB	410mm / 465mm	101mm
24 V	7.4 A	310/370 +/- 20HZ	>= 150 DB	410mm / 465mm	101mm

High Beam LED Torch

High Beam Rechargeable LED Torch - Bright White Color Beam. With Skid proof, Water proof and Shock proof Design. Rubber Grip Anti-Skid Handle & Aluminum Body a and/or Metal Body. LED light can be useful as a torch and search light. High / Low / Off / SOS trigger switch.



Wetsuit



- Neoprene SCUBA diving one piece wetsuit will be perfect for moderate to warm temperature diving.
- Plus, having the full coverage provides valuable protection to your skin from sun and abrasions.
- The neoprene is laminated with pill and abrasion resistant fabric for durability.
- All seams are sealed, meaning glued and blindstitched, to prevent cold water from entering the suit.
- Edges at the cuffs are lycra trimmed for comfort and chafe resistance.
- Freedom Flex knee pads give needed durability without extra bulk around the knees.

Embarkation Ladder



Pilot Ladder



Aluminium Gangway



Denforth Anchor
8, 12 & 15 Kg



Glue and Hardener for
Hypalon (Rubber) &
PCV Boat



Inflatable Boat Repair Kit



Sounding Tape



Hand Lead Line



Marine Books



Snorkel & Fins



Marine Baton



Metal Detector





Rescue Quilt with 30 Mtr Floating Rope



Polypropylene, Polyester, Nylon Braided, Nylon, HDPE, Bungee, Elastic, Coir & Fender Rope.

Coir Fender



12, 18 & 24 Inch

Non Spark



Shovel & Scoop

Rubber Bucket



10 & 20 Liter

Day Signal Shapes



Ball, Diamond, Cylindrical, Conical and Double Conical

Boat Hook



Wooden & Aluminium
3 to 5 Meter Long

Oars



Wooden & Plastic

Ship Chandler

DECK STORES

- Personnel protective equipment
- Hoses, couplings, valves
- Pipes, elbows, tees, flanges, etc.
- Charts, publications, and signages
- Oil spill emergency equipment
- Nautical and GMDSS equipment
- Hatch sealing tapes
- Radio room consumables
- High pressure deck cleaning equipment
- ISPS stores

ENGINE STORES

- Asbestos free packing and jointing
- Lube oils and hydraulic fluids
- Adhesive and lubricants
- Hot and cold welding equipment
- Bearings, seals and V-belts
- Pneumatic and electric pumps
- Cotton waste and rags
- Rubber matting and cords
- Explosion proof hand lamps



CABIN STORES

- Cloth and linen
- Welfare items
- Tableware and galley utensils
- Locks and latches
- Brushes and mats
- Lavatory equipment
- Detergents and cleaning materials

SAFETY STORES

- Liferafts, lifejackets, and lifebuoys
- Breathing sets
- Fire and immersion suits
- Marine distress signals, pyrotechnics
- Transfer and descent equipment
- Gas detectors and spares
- Fire extinguishers
- Foam compound
- Navigational lights and shapes
- Survival craft accessories



HARDWARE & TOOLS

- Pneumatic and electrical tools
- Hand tools
- Cutting tools
- Measuring tools
- Bolts and nuts
- Welding equipments
- Non sparking tools
- Barbed wire

ELECTRICAL STORES

- Bulbs and lamps
- Navigation and search lights
- Cables, switches, and boards
- Plugs, sockets, alarm and horns
- Electrical contactor and contacts
- Lead acid batteries and chargers
- Explosion and waterproof fittings
- Refrigerator, washer, grinder, etc.



ROPES & LIFTING TACKLES

- Manila and nylon ropes
- Mooring ropes and tails
- Galvanized steel wire ropes
- Links, turnbuckles and shackles
- Hooks, chains, rods
- Lifting slings and nets
- Gangway nets
- Fairlead mandal shackle

MARINE CHEMICALS

- Boiler water treatment chemicals
- Fuel oil treatment chemicals
- Tank cleaning chemicals
- Test kits and reagents
- Cooling water treatment chemicals
- Oil spill dispersant
- Electric cleaning chemicals
- Air cooler cleaners



PROVISION STORES

- Fresh vegetables and fruits
- Beverages and instant foods
- Sauces and ketchup
- Frozen meats and fish
- Ice cream and chocolates
- Exotic and frozen vegetables
- Cold cuts and sausages
- Cereals and pulses
- Cheese and dairy products
- Drystores

MARINE PAINTS & ACCESSORIES

- Epoxy and modified epoxy
- Polyurethane and thinners
- Alkyd and modified alkyd
- Heat resistance coats
- Anti skid, finish, speciality coats
- Underwater, anti fouling coats
- Airless spray machine and spares
- Roller and flat brushes



Contact Us

For Sales & Marketing Queries

sales@paramaxinc.biz

Ph: +91-8106347472

For Billing and Accounts

accounts@paramaxinc.biz

Ph: +91-8106347472