

Gaviotas  
Hydraulic  
Sleeve pump

Hand pump  
for deep  
well



CENTRO  
LAS  
GAVIOTAS  
Orinoquia  
Colombiana



Programa de las  
Naciones Unidas  
para el Desarrollo  
P.N.U.D.

# Hydraulic Sleeve Pump

Hand pump  
For deep well

# Hydraulic Sleeve Pump

Installation  
And operation  
Manual



United Nations  
Developing  
Program

Centro Las Gaviotas

Colombian Orinoquia

Avenida Circunvalar # 20 - 90

Bogotá D.C, Colombia

Tel: 571 241 99 67 - 281 15 09

281 17 05 - 281 17 29

281 18 74

[www.centrolasgaviotas.org](http://www.centrolasgaviotas.org)

email:

[centrolasgaviotas@hotmail.com](mailto:centrolasgaviotas@hotmail.com)

Total or partial reproduction is not forbidden on the contrary we encourage it as  
long as the source is quoted

There are a big amount of hand pumps and all of them work well.

But this pump takes advantage in its best way of the limited human force, the water flow and the high of the pumping.

The sleeve pump is adaptable at any height and water demand within a range from 1-40 ms, it is not limited to 7 ms suction since the piston and cylinders are submerged it can work deeper than 10 ms

For 5 years we have testing different designs on the same idea, to get the simple and robust model that is offered now with galvanized and PVC parts you can find in any market. So it is no necessary to use specially made spare parts for the most part of the machine.

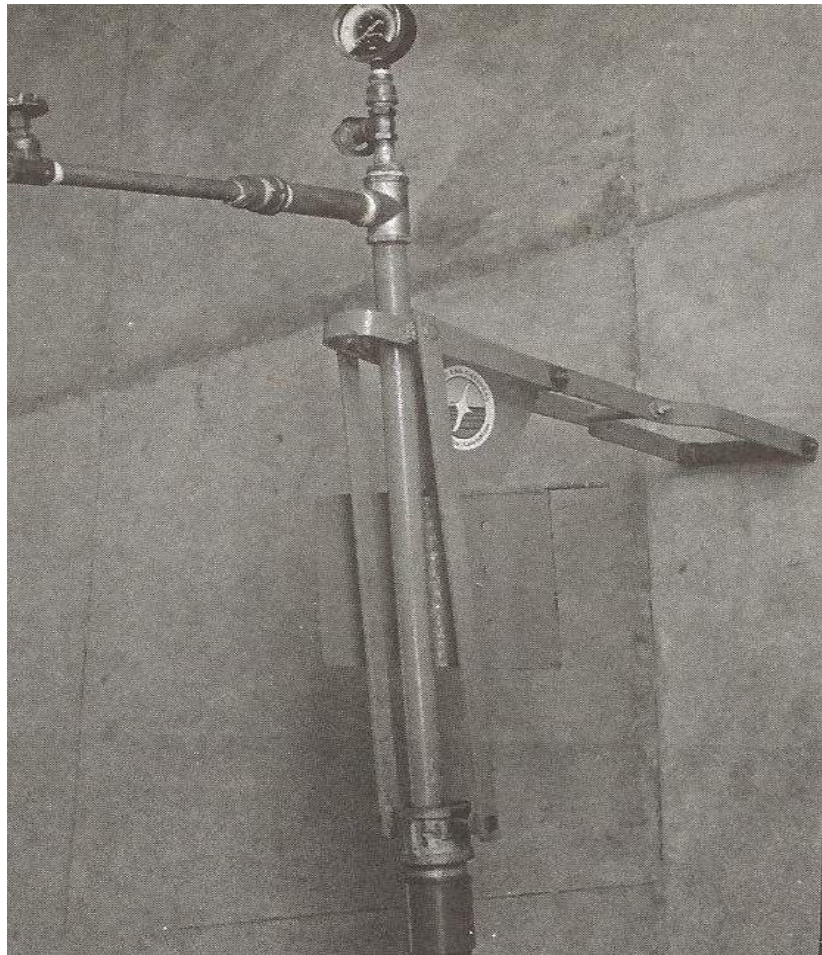

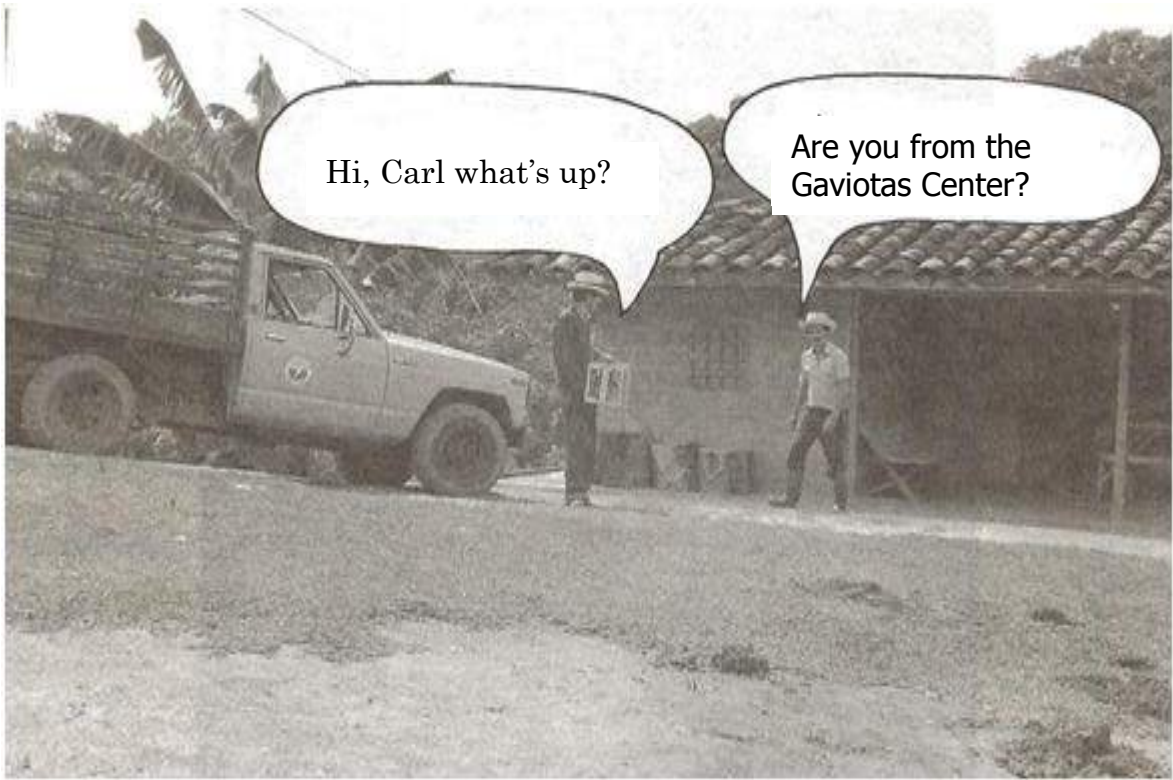



The first step is to carefully read the installation instructions this will help you spare time and work.



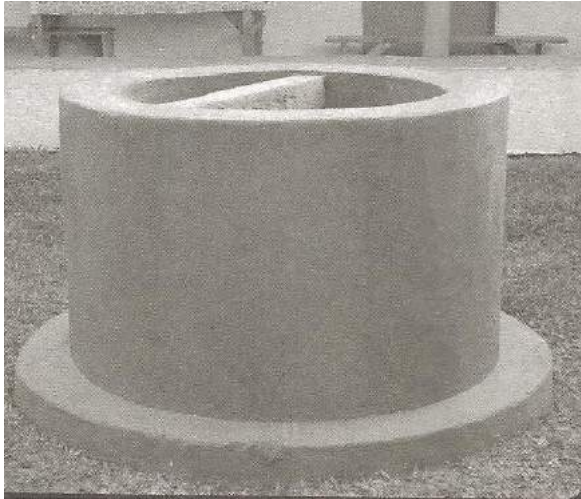

You must have a well. The two most common are dug and drilled well water tank with drill.

90 cm Ø drilled well, 13 ms deep protected with a rim



16 cm diameter drilled hole and depth 11 ms before being coated.

You have to consider the ground conditions for trying an excavated well. We recommend a diameter of about 90 cm. The well must have in the dry time at least 1 m of water.



If you want to drill your well you can ask ourselves Gaviotas Center, about the drilling equipment its use and limitations.

## Two support models

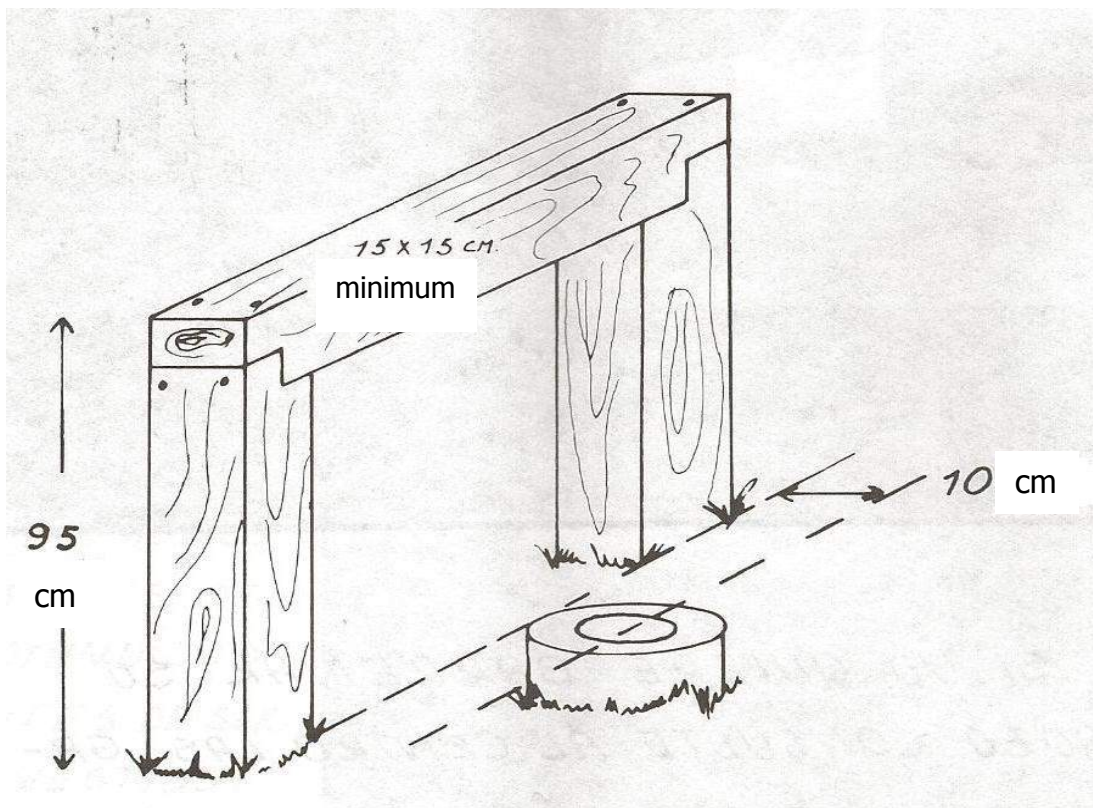
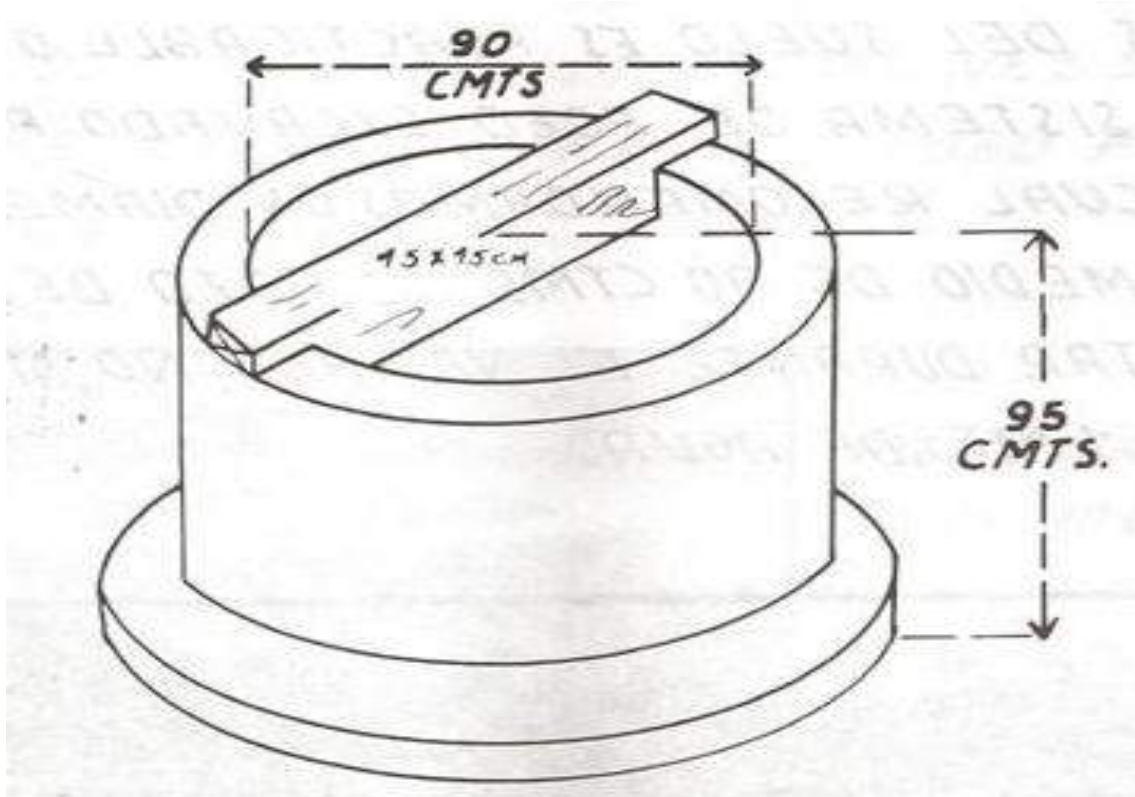



Get used to the parts of the pump, but do not ensemble the head before you have drilled the well, the support for the pump and having all the materials for the pipe, the sleeve and the feeding hose.

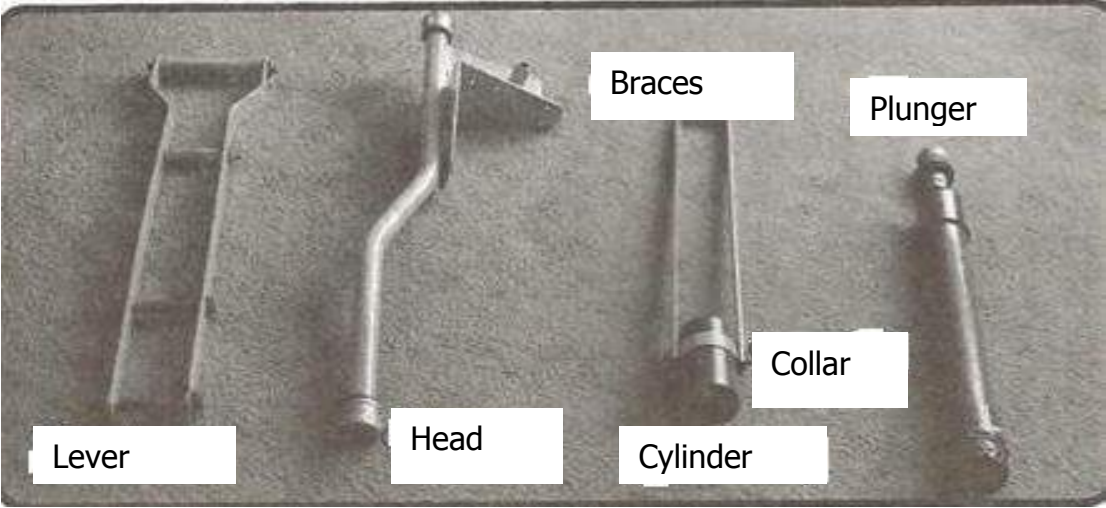

## Calculating the length of the pipe

Measure the depth of the well from the support of the pump

Discounting 1 m 50 cm then you have the length of the 1"Ø galvanized pipe. If the length is more than 6 ms you can add more pipes joining them and covering the threaded unions with Teflon or plastic bags.

## Calculating the sleeve

Take the length of the pipe already determined and discount 10 cm

This is the length for the 2" Ø PVC pipe.

If the length is more than 6 ms you can add more pipes joining them and covering the threaded unions with Teflon or plastic bags.

For welding the parts follow the instructions in the appendix at the end of this manual.

Put the pump cylinder at the end of the 2"Ø PVC pipe and put it into the well, add the other PVC pipes and finally put the collar at the end of the pipe above the well.

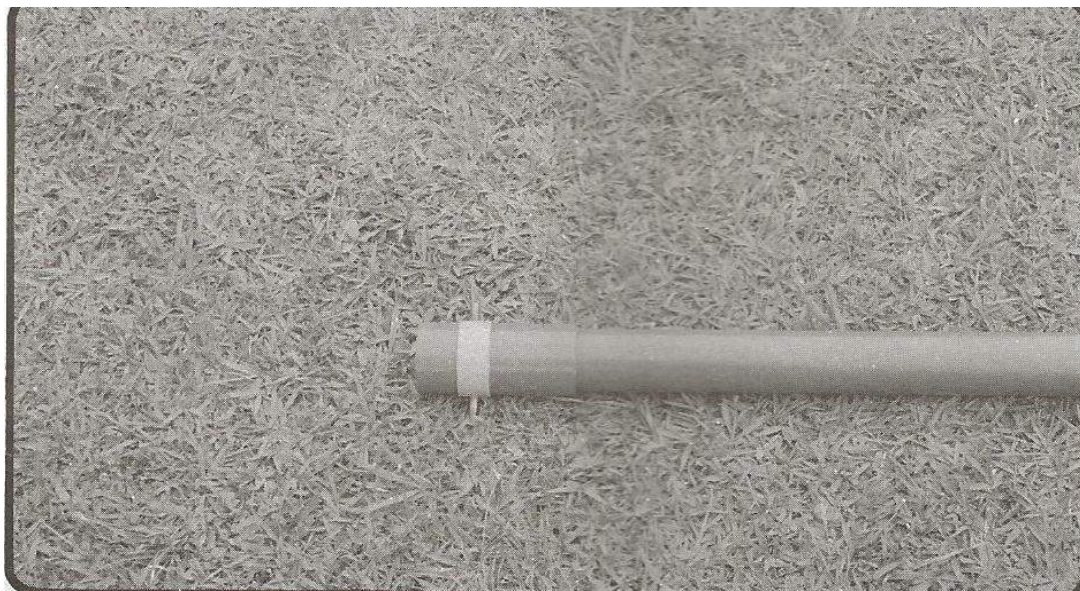

The galvanized pipe is joined with screwing fittings

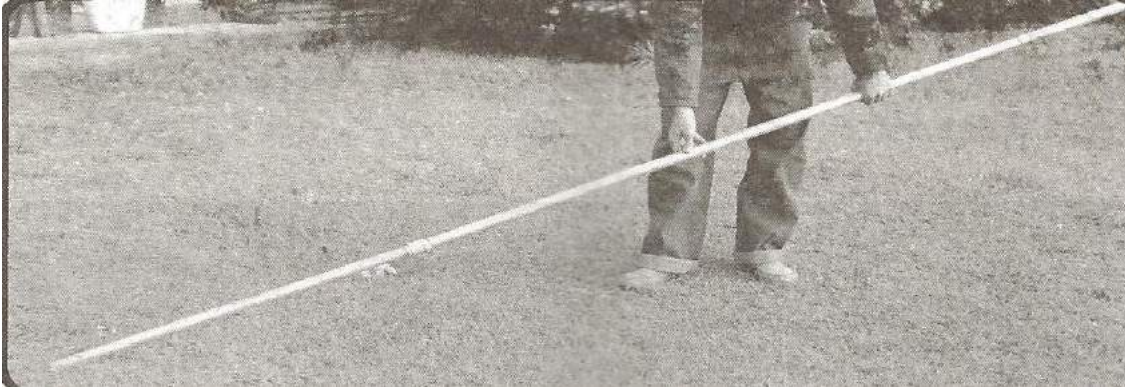

Join the pipes using weld and fittings for PVC

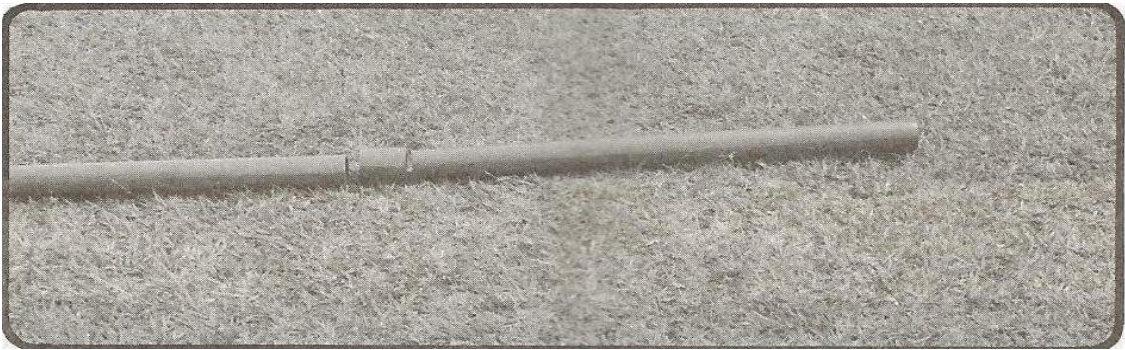

The 2" Ø PVC should be 10 cm shorter

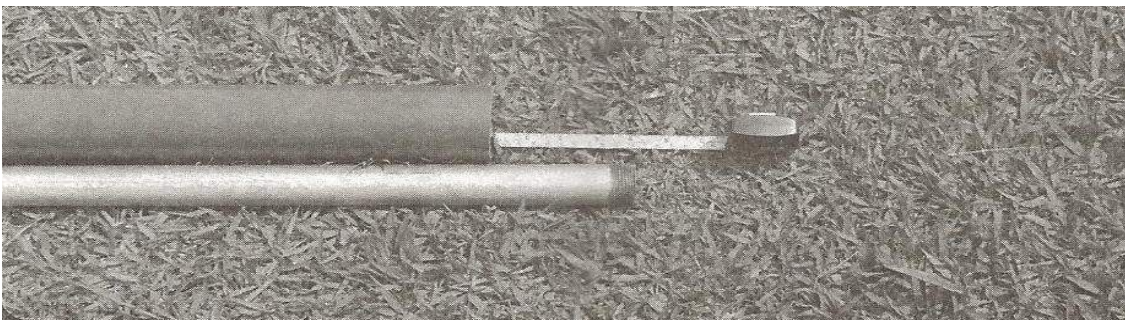

## Joining the pipe

Join the parts of the galvanized pipe for having the calculated length and put a 1" fitting at one end and at the other the plunger and the valve of the pump.





Do not let the leather plunger to become wet before you have introduced the galvanized pipe inside the PVC sleeve.

Introduce the galvanized pipe into the PVC sleeve.

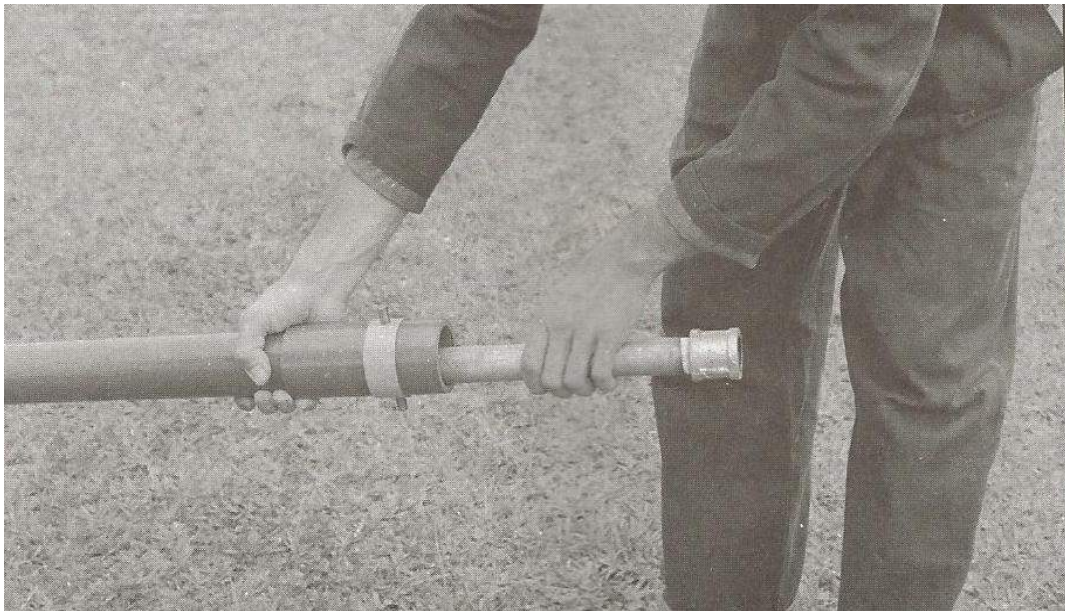
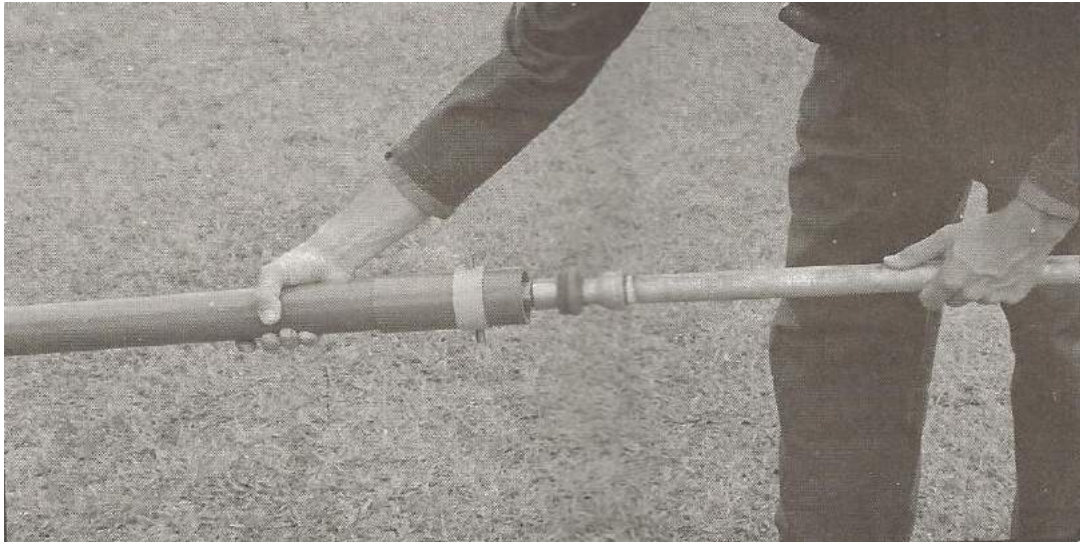

Held tight the sleeve using the braces, tie the galvanized pipe with a rope for avoiding it to fall into the sleeve and screw it in the bottom of the head.

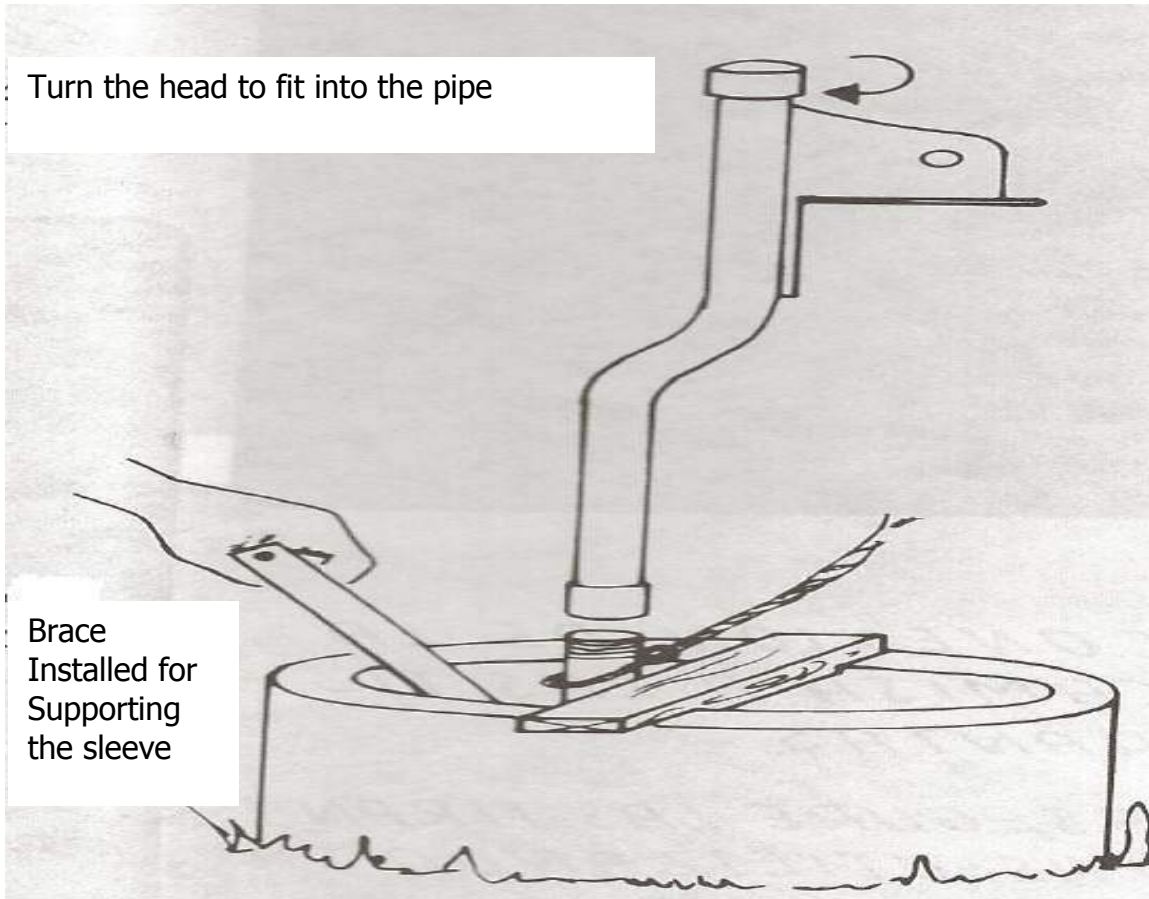

After connecting low down the head and fix it on the support with some screws or nails up to 5" long.

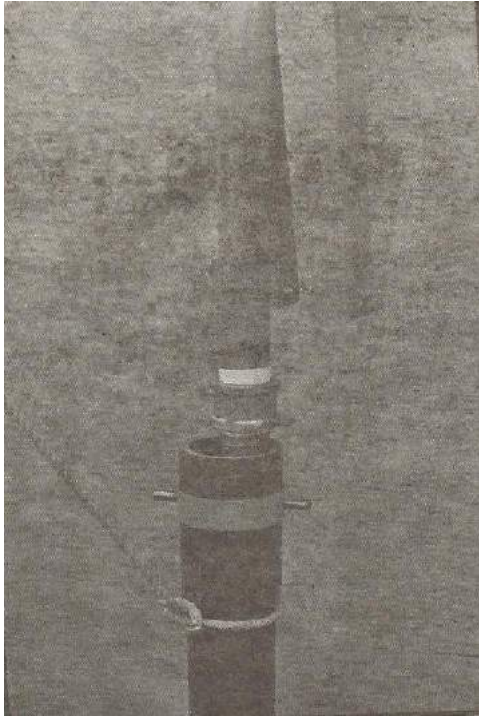

Screw up the pipe in  
the bottom of the  
support of the head.

Connection of the  
galvanized pipe to  
the head

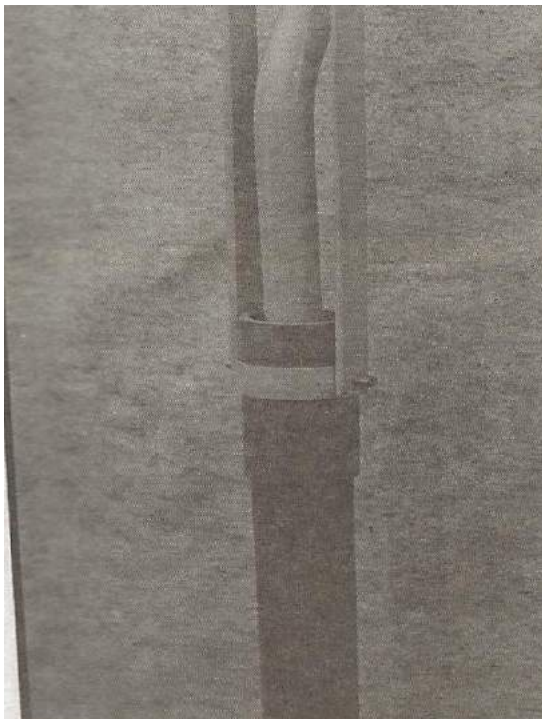

Connecting the  
sleeve to the  
braces

Fix the braces  
using the pins

Fix the head on the support before putting the levers



Clean with sandpaper the shafts and bushings before mounting levers, oil abundantly within the support of these axes.

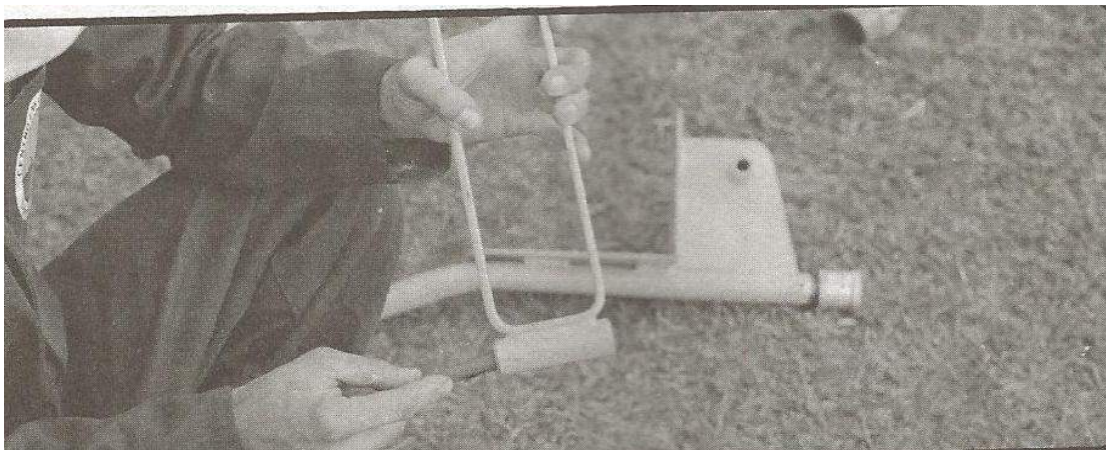
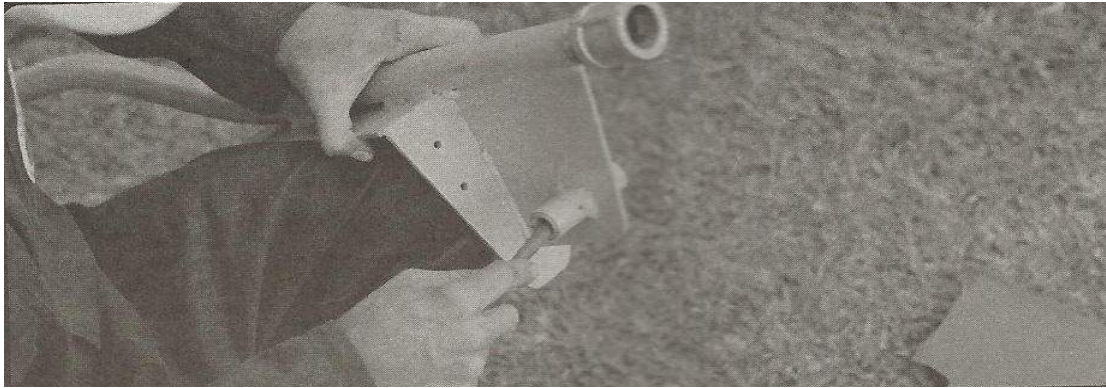

Order of assembly

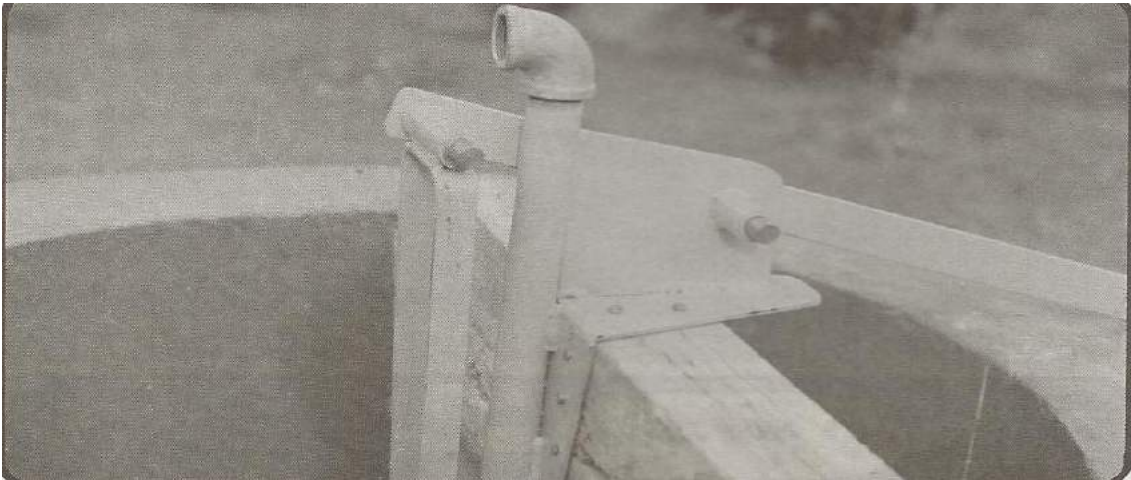

After a few minutes the plunger expands and the pump will have enough pressure



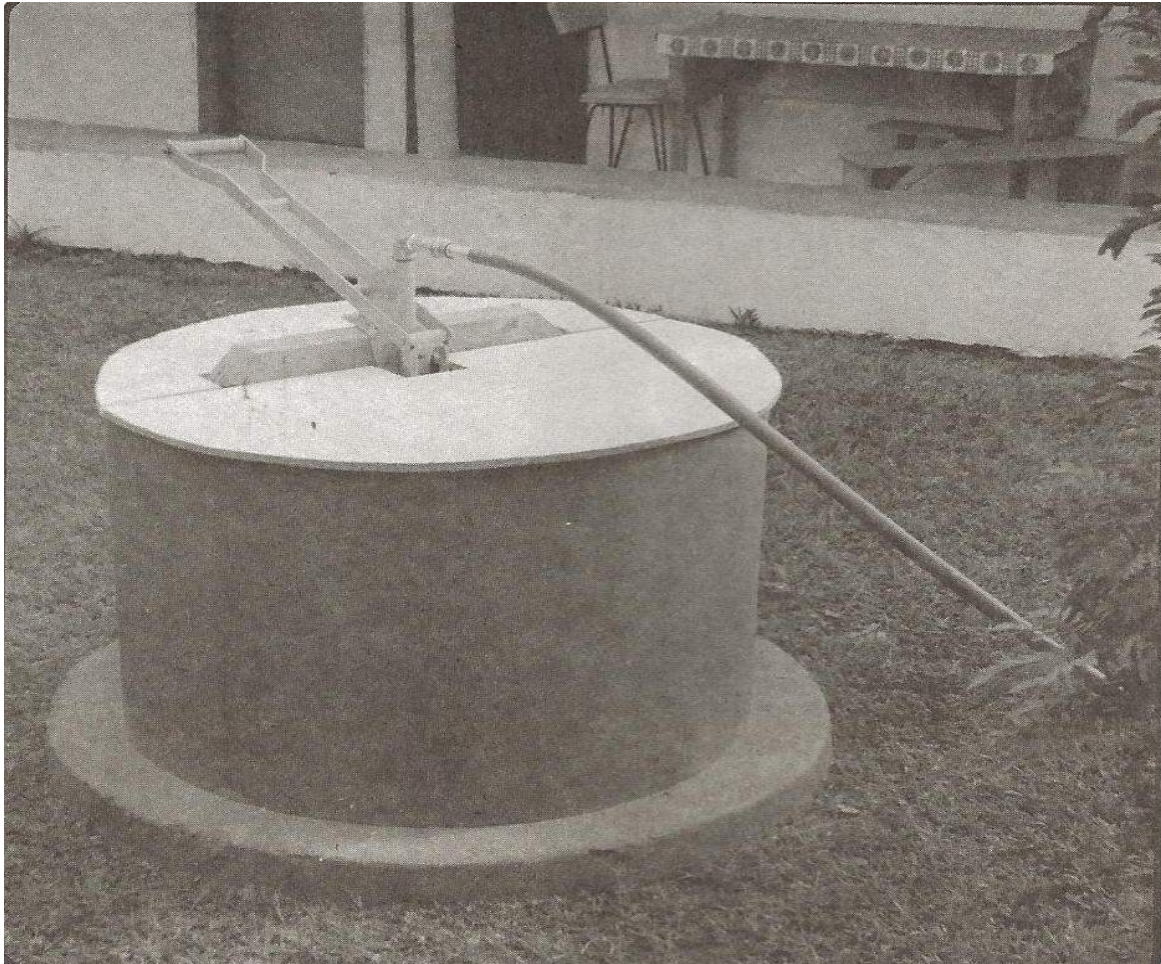

It is necessary to cover the well with a lid so the water could be protected from the solar rays, and to prevent it from dirt and other objects, do not allow animals to sleep on the well.



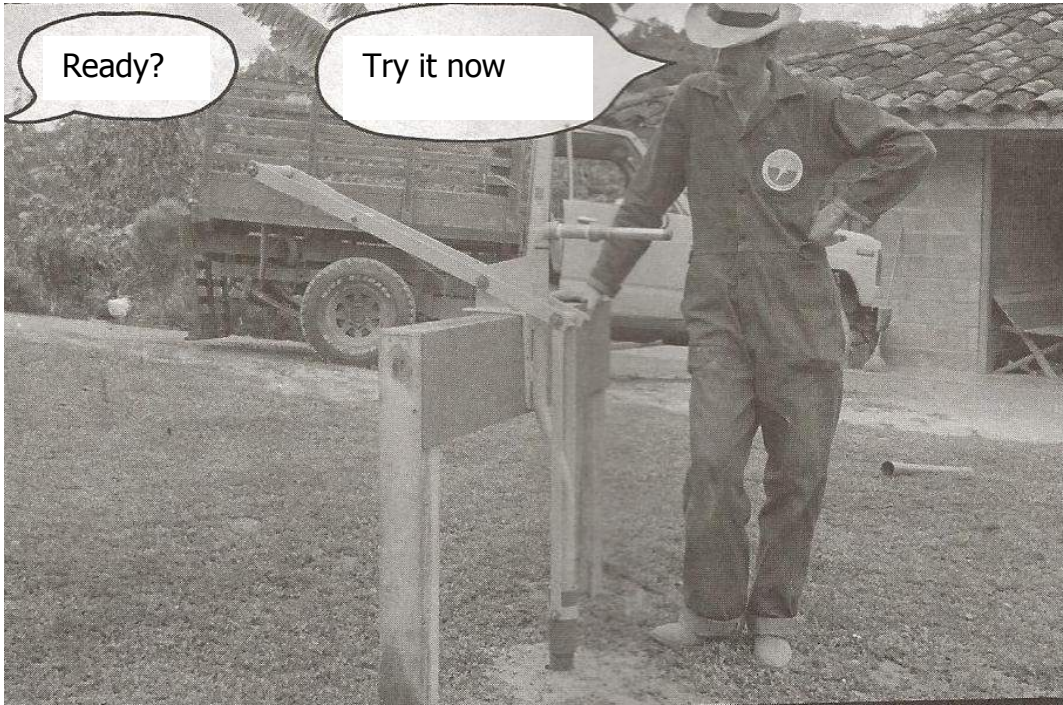

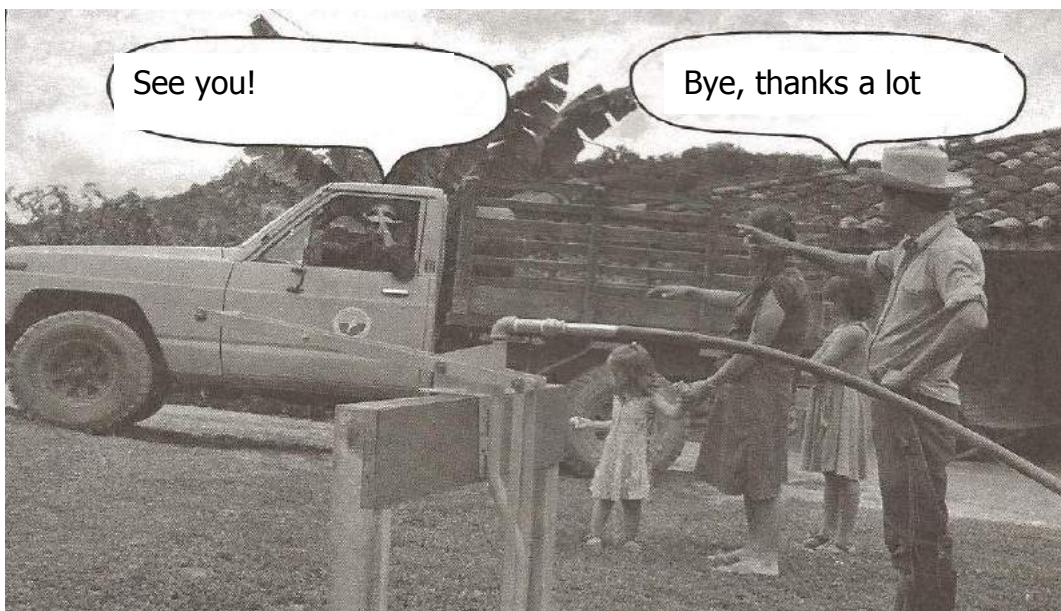

# Appendix

Recommendations from the PVC producers

Cut the pipe with a hacksaw make sure that the cut is square using a box as a guide.

Remove burrs and marks of blade, using a file or sandpaper.

Thoroughly clean the surfaces to be connected to both the pipe and the fitting with a clean cloth moistened with cleaner remover

Join the pipe with the fitting making sure it is well supported and make a quarter turn to distribute the welding, hold firmly the coupling for 30 seconds.

## Range

The pump can bring water until 40 ms high, from the level of the water in the well and the discharge end of the pipelines.

## If the pump does not work

Make sure the valves are clean and open in the right direction regarding the water flow.

Verify the plunger if it is too worn out replace it.

If one of the pipes are broken join them again paying attention to keep the right length



**CENTRO LAS GAVIOTAS**

**Orinoquía Colombia**