



klodea.

UNIQUE SOUL

INDEX

HANDLE

Intro	5
Ile collection	7
Ile push	13
Moreorless collection	17
Oh collection	23
Soie collection	29
Thefin collection	37
Tondoquadro collection	43
Voile	49
Ben	53
Flo	57
SV collection	61

THE LINES OF NATURE THE HAND OF **KLODEA**.

Our vocation is form. Basic, orderly, inspired by the balance of natural elements.
Klodea's handles and finishing accessories are the interpretation of a typically Italian artistic language.

They lend an unprecedented lightness to the gentle, well-defined lines of their components.

Klodea's tradition is, a launching-pad for the achievement of new creative ideas.

We instil in our work the dream of pure and accessible design, the search for a form that implies a meaning.
Vision and action are intimately linked in Klodea's products, the combined expression of beauty and ergonomics.

A constant aspiration to elegant and functional design is the distinguishing mark of our group and its products.

Klodea is the formal expression of quality.



MADE IN ITALY

[WITH LOVE]



ILE

COLLECTION



The Ile Collection extols **sinuous** shapes. A slim laminate shapes these handles with a soft outline, whose design presents a new take on roundness. The mathematical **purity** of the curve meets creative invention. The outcome is a **harmonious** and unusual solid, surprising in its stylistic execution.

Available in three different sizes, this handle is intended for both small and large pieces of furniture and décor items.



ILE COLLECTION

BY SIMONE VIOLA

P.07





Ile. The beauty of perfection.





TECHNICAL INFORMATION



Ile Small | 2241-54mm
c.c. distance: 16mm

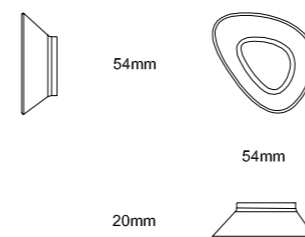

Ile Medium | 2241-60mm
c.c. distance: 16mm

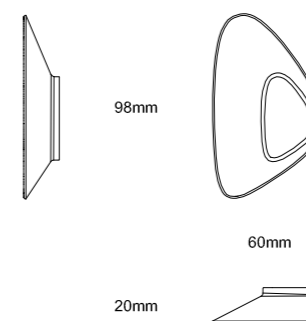

Ile Large | 2241-154mm
c.c. distance: 32mm

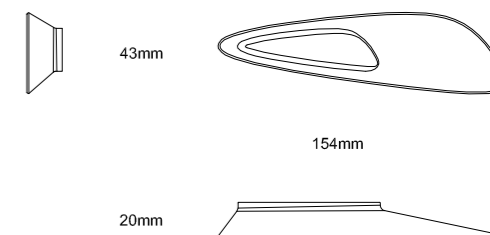

Touch of Class

Ile Push is the detail for those looking for comfort with a touch of class. Designed for use on push panels and dressers, the application provides an **elegant** and striking indication of the point to press. Inspired by gentle, silken curves, Ile Push accommodates your touch in a concave core designed to provide maximum functionality. The clean and distinctive style of this Klodea product gives **new character** to the décor items of your home.



TECHNICAL INFORMATION



Ile Small | 7184-36mm
c.c. distance: 16mm

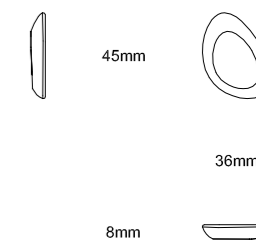

**Remarkable for
its light weight,
memorable for
its stability.**

The flexibility of a natural stem alternates with the steel
and steadies the movement.

This is the concept behind the Moreorless Collection,
in which metal is curved into a perfectly graspable form.



MOREORLESS COLLECTION

BY SIMONE VIOLA

P.017





A product of the less is more philosophy, with only the necessary material and a design that gives the handle its distinctive character.



With Moreorless,
nature takes shape with every touch of the hand.

TECHNICAL INFORMATION



Moreorless Small | 2245-160mm
c.c. distance: 64mm

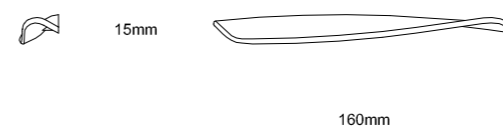

Moreorless Medium | 2245-250mm
c.c. distance: 96mm

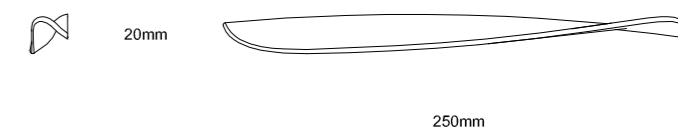



OH!
timeless style ■

OH COLLECTION

BY SIMONE VIOLA

P.023



The classic Italian knob still has all of its traditional charm, but its personality has been given a makeover.

The ellipse is emptied out from the core, making the handle lighter and airier. The knob projects from the surface it is applied on, inviting your grip.



The satisfaction given by a soft and rounded pommel remains unchanged. What has been changed is the design: a modern take that renews one of the most attractive of the classic handles and makes it up to the minute.



TECHNICAL INFORMATION



Oh Small | 2254-64mm
c.c. distance: 32mm

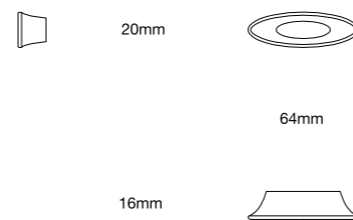

Oh Medium | 2254-108mm
c.c. distance: 64mm

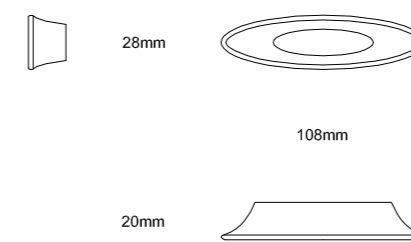

Oh Large | 2254-164mm
c.c. distance: 96mm

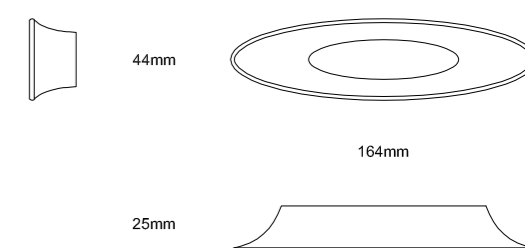



Impalpable, like silk.

SOIE COLLECTION

BY SIMONE VIOLA

P.029



This precious fabric lends its name to the Soie Collection, the elegant, minimalist line of handles by Klodea. A single, slim filament of metal, curved in its central part, was the inspiration for this design, intended for horizontal applications.





Delicacy and visual **lightness** are the result of this stylistic approach, dedicated to those for whom class is synonymous with simplicity. A handle that recalls the fluid sensation of silk sliding through one's hands.



TECHNICAL INFORMATION



Soie Small | 2247-200mm
c.c. distance: 160mm

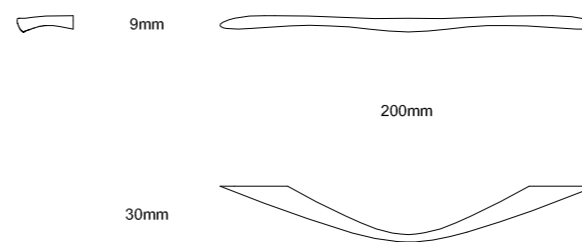

Soie Medium | 2247-300mm
c.c. distance: 256mm

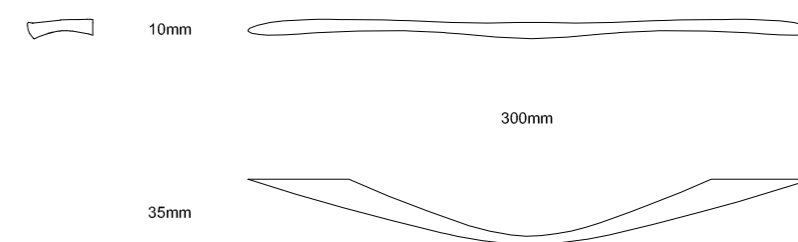

Soie Large | 2247-400mm
c.c. distance: 320mm

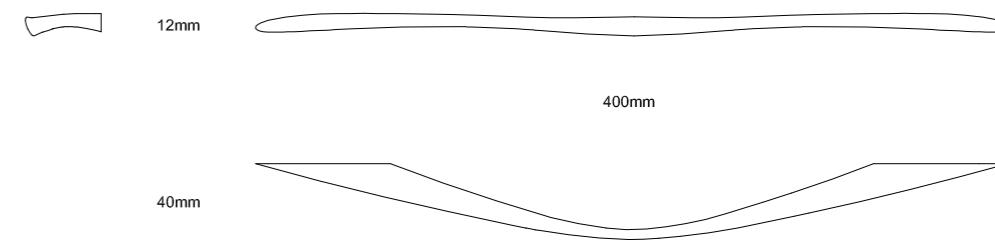

THEFIN COLLECTION

BY SIMONE VIOLA

P.037

Thefin Collection: opposites attract.
Opposites that combine seamlessly, in an optimally balanced product.
A rectangular base with a curved extension, with a flat bottom and a grip
in gentle relief that provide harmony and movement.





Thefin handles are offered in pairs, underscoring the twin concept that lies at their core. Either in mirrored pairs or unidirectional couplings, this collection lends furniture and design objects all the impact that contrast can generate.

TECHNICAL INFORMATION



Thefin Small | 2242-100mm
c.c. distance: 32mm

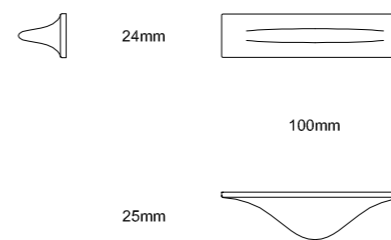

Thefin Medium | 2242-160mm
c.c. distance: 96mm

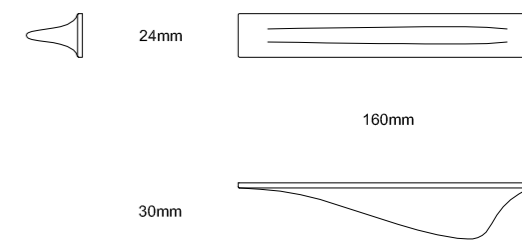

TONDOQUADRO COLLECTION

BY SIMONE VIOLA

P.043

Tondoquadro is a welcoming collection, with an intensely homey feel.



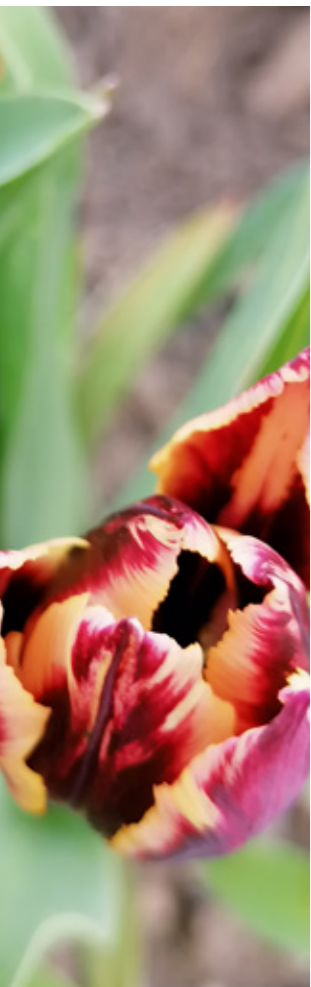

Intended for residential applications, these handles provide ample surface contact, for safe and sure grasping. Rectangles and circles find their ideal balance in this range, which exalts the best qualities of both: the geometric regularity of the former and the fullness and harmony of the latter.

Just like Klodea, which combines know-how and innovation in its design products.



TECHNICAL INFORMATION

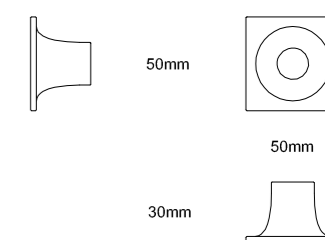

Tondoquadro Medium | 2246-180mm
c.c. distance: 128mm

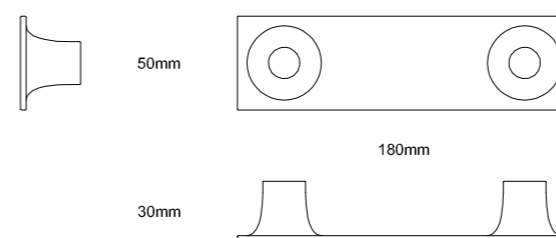

Tondoquadro Large | 2246-275mm
c.c. distance: 224mm

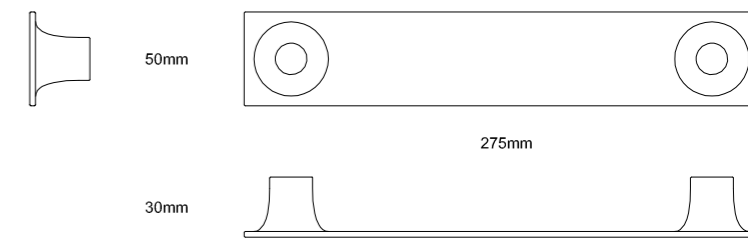



voile



VOILE

BY SIMONE VIOLA

P.049



The Voile line seems to flutter in a breeze, like sails filled by the wind. This inspiration resulted in an extremely stable handle with a fluid design. A new equilibrium, by Klodea.

The grip is well-defined and the base is a silhouetted plaque that lends movement to the overall design.

Traced by expert hands, the sign is the recognizable hallmark of this handle.

TECHNICAL INFORMATION



Elegant and sophisticated, top drawer décor.



Voile Small | 2250-90mm
c.c. distance: 32mm

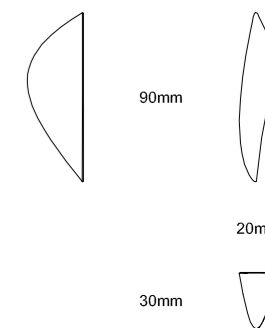



BEN

BY SIMONE VIOLA

P.053

Ben shapes space, inviting your touch. Elegantly shaped, this recessed handle is a natural extension of the items on which it is mounted. A clean and incisive fold of metal, defining precise volumes in an alternating sequence of full and empty spaces.

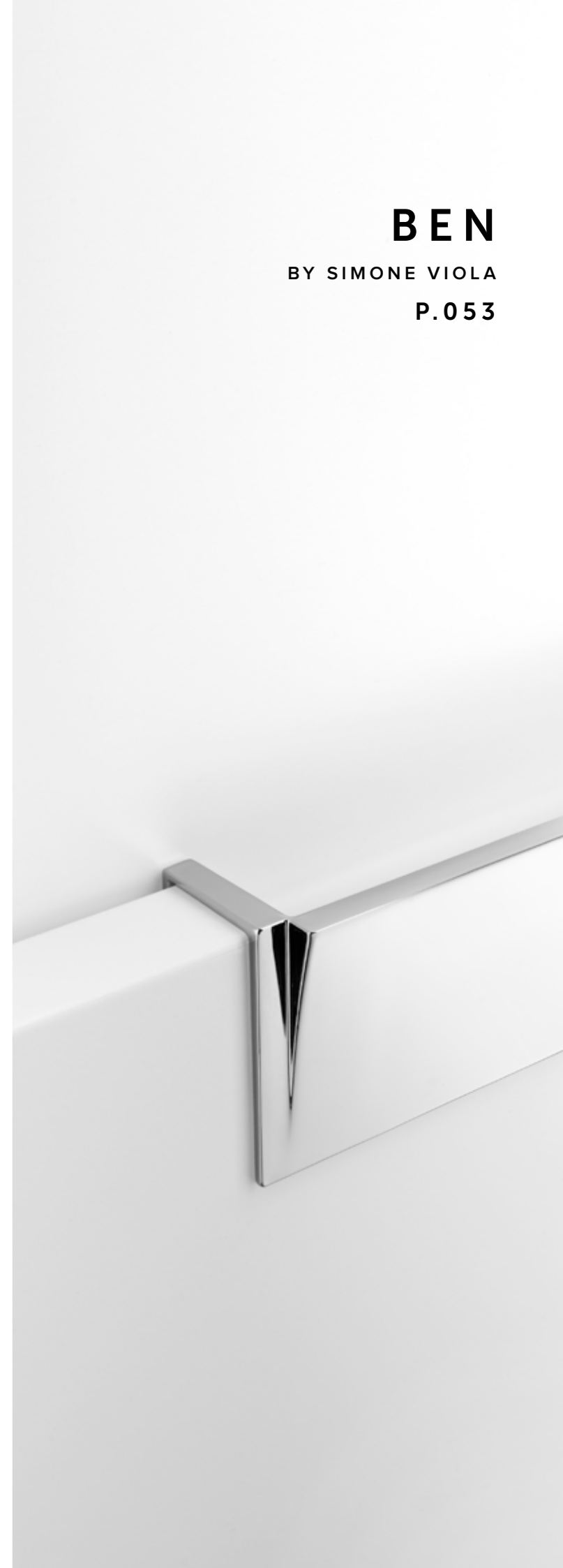

The shape is perfectly intuitive: a handhold that invites your touch, striking the ideal balance between **technical function** and **design style**. Thanks to the range of finishes available, in chrome and in nickel, Ben is the choice of those who want both refinement and innovation.



TECHNICAL INFORMATION



Ben Small | 2240-125mm
c.c. distance: 96mm

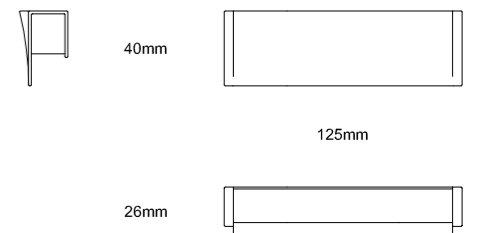



FLO

BY SIMONE VIOLA

P.057

At the interface of delicacy and solidity lie the shape and idea behind Flo. A drop set between inviting walls defines the opening of this recessed handle: the epitome of liquidity encased by solid matter.

The space scooped out provides maximum grasp comfort.

The fluidity of Flo is expressed in its perfect alignment with the elements to which it is applied. The handle projects out from the polished surfaces, giving the final result a distinctively elegant character.

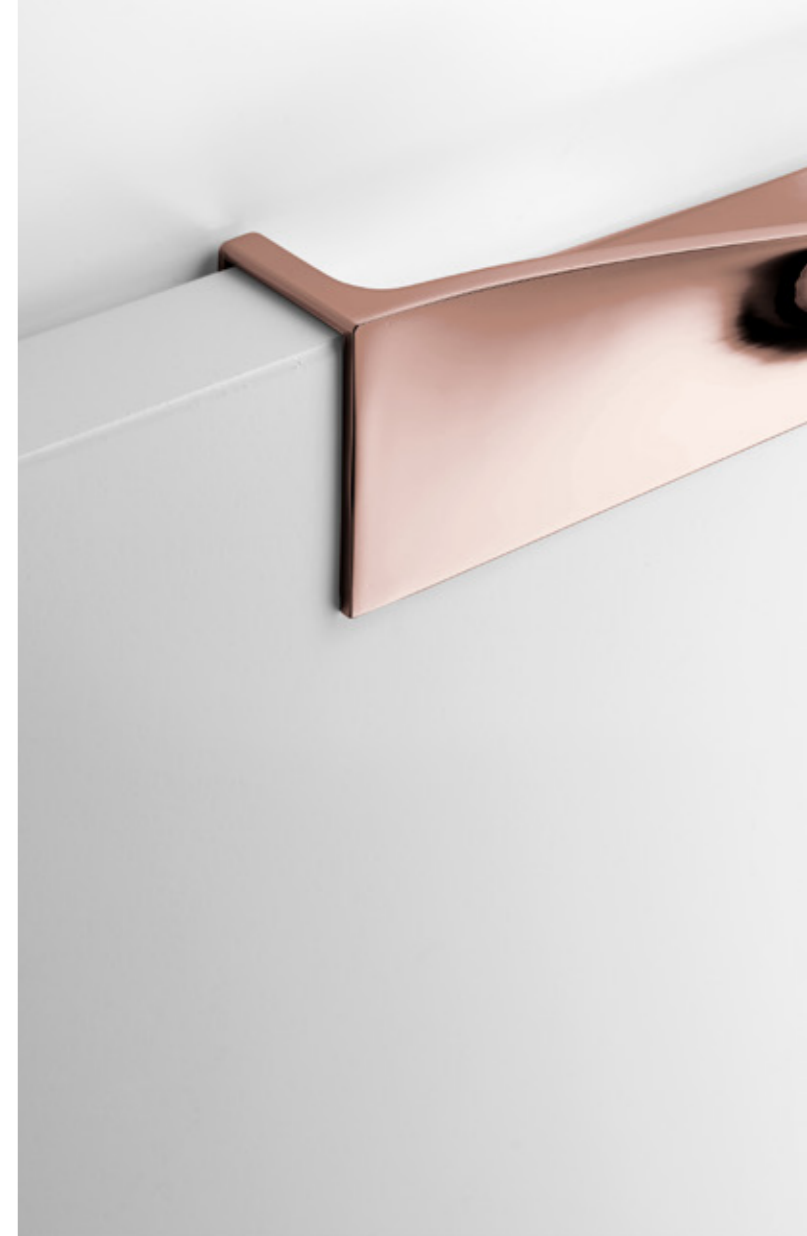



TECHNICAL INFORMATION



Flo Small | 2239-120mm
c.c. distance: 96mm

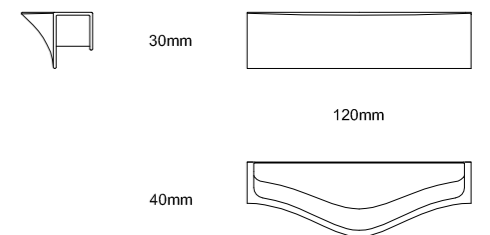

SV COLLECTION

BY SIMONE VIOLA

P.061





Sv is the collection that bears the monogram of its creator. A strong personality is thus the hallmark of this line, featuring a futuristic, streamlined design. A proposal whose every touch of beauty also pays homage to function. Exactly as is the case in nature. Extremely comfortable in version One, compact and minimal in version Two, this handle pleases the eye and the touch, thanks to its absolute purity. Sv Collection: design in the service of technique.

TECHNICAL INFORMATION



c.c. distance: 96mm | 128mm | 160mm | 128/224mm | 192/288mm | 224/320mm | 288/384mm | 384/448mm

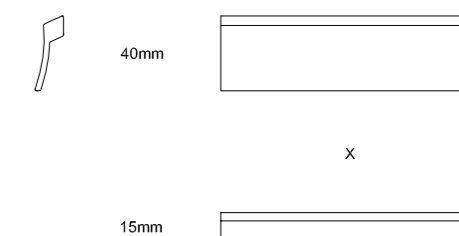

SV two | 7186-X
c.c. distance: 96mm | 128mm | 160mm | 128/224mm | 192/288mm | 224/320mm | 288/384mm | 384/448mm

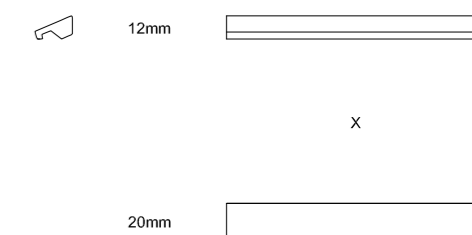

CODES & DIMENSIONS

	Item code	c.c. Distance	Lenght
Ile Small	2241-54	0.63in	2.12in
Ile Medium	2241-60	0.63in	2.36in
Ile Large	2241-154	1.26in	6.06in
Ile Push	7184-36	0.63in	1.42in
Moreorless Small	2245-160	2.52in	6.3in
Moreorless Medium	2245-250	3.78in	9.84in
Oh Small	2254-64	1.26in	2.52in
Oh Medium	2254-108	4.25in	6.3in
Oh Large	2254-164	6.46in	9.84in
Soie Small	2247-200	6.3in	7.87in
Soie Medium	2247-300	10.08in	11.81in
Soie Large	2247-400	12.60in	15.75in
Thefin Small	2242-100	1.26in	3.94in
Thefin Medium	2242-160	3.78in	6.30in
Tondoquadro Small	2246-50	-	-
Tondoquadro Medium	2246-180	5.39in	7.09in
Tondoquadro Large	2246-275	8.82in	10.83in
Voile	2250-90	1.26in	3.54in
Flo	2239-120	3.78in	4.72in
Ben	2240-125	3.78in	4.92in
SV one	7181-124	4.88in	9.84in
	7181-156	5.04in	6.14in
	7181-188	6.3in	7.40in
	7181-252	5.04/8.82in	9.92in
	7181-316	7.56/11.34in	12.44in
	7181-348	8.82/12.60in	13.70in
	7181-412	11.34/15.12in	16.22in
	7181-508	15.12/17.64in	20in
SV two	7186-124	4.88in	9.84in
	7186-156	5.04in	6.14in
	7186-188	6.3in	7.40in
	7186-252	5.04/8.82in	9.92in
	7186-316	7.56/11.34in	12.44in
	7186-348	8.82/12.60in	13.70in
	7186-412	11.34/15.12in	16.22in
	7186-508	15.12/17.64in	20in

TERMS & CONDITIONS

These terms and conditions apply to all products (collectively, the “Products”) sold or otherwise provided by Klodea, Inc., a Florida corporation (“Company”), to customer (“Customer”).

1. PRICES

The most recent prices provided in the most recent price guide for the Products of Company (the “Price Guide”) annul and supersede any previous prices for the Products. Prices are in United States Dollars and the prices can be modified at any time without prior notice to Customer. Company’s prices in effect at the time Customer orders the Product shall supersede any price provided in the Price Guide unless Company has provided Customer with a written firm price quote and Customer has placed an order for the Product causing the goods to be shipped within the time period specified in such written firm price quote. Prices provided in the Price Guide do not include any taxes, shipping, or freight charges.

2. PAYMENT

Payment is due by Customer at the confirmation of Customer’s order. Products will only be shipped once payment is received.

3. ORDERS

All orders must be in writing and indicate the name of the Product and the item code of the Product as provided in the Price Guide.

4. TAXES

Company will charge any applicable sales tax or other applicable tax to Customer unless sufficient proof of purchase for resale or an applicable exemption certificate is provided at the time an order is placed.

5. DELIVERY

Products ordered by Customer will be shipped through a courier of Company’s choice. All Products will be shipped at Customer’s expense and risk, and Company does not insure any shipped Products. If Customer has placed an order for more than one Product, then Company reserves the right to ship the Products together in a single shipment or to ship the Products in separate shipments.

6. RISK

Company will not be liable, and Customer will bear the risk of loss, for any delay, damage, expense, cost, or loss which may occur beginning when the Products are given by Company to the courier for shipment.

7. QUALITY AND QUANTITY CLAIMS

Customer must inspect all Products immediately upon receipt from Company. Any claim by Purchaser regarding the quality or quantity of the Products must be reported to Company within eight (8) calendar days of Customer’s receipt of the Products and prior to the beginning of the installation of the Products. Company shall have the right to verify any claim and, at its sole option, may either replace or complete the order as the case may be.

8. RETURN OF PRODUCT

No return of any Product will be by Company accepted unless the return has been explicitly authorized by Company in writing.

9. CHANGES TO PRODUCT

Company reserves the right to make changes without notice to the design of the Products or the packaging of the Products.

10. NO WARRANTY

The maximum extent permitted by applicable law, the products are provided by company “as is” and “as available” without any condition or warranty whatsoever. All conditions and warranties, whether express or implied, are disclaimed by company, including, without limitation, the implied conditions and/or warranties of merchantability, title, non-infringement, and fitness for a particular purpose.

11. SUCCESSORS AND ASSIGNS

All disclaimers of warranty and liability contained in these terms and conditions shall be binding upon Customer and their successors, assigns, transferees, and ultimate users.

12. FORCE MAJURE

Company shall not be liable for any delay or for any failure to perform any of its obligations if the delay or failure results from events or circumstances beyond the control of Company (a “Force Majure Event”). Such Force Majure Events include, but are not limited to, acts of God, strikes, lock outs, accidents, war, fire, breakdown of plant or machinery, or shortage or unavailability of raw materials from a natural source of supply. Company shall be entitled to a reasonable extension of time to complete its obligations upon the occurrence of a Force Majure Event.

13. GOVERNING LAW AND JURISDICTION

These terms and conditions and the interpretation of the rights and duties of the parties to these terms and conditions shall be governed by the internal laws of the State of Florida (without regard to conflict of laws or similar concepts). Customer and Company hereby irrevocably submits to the exclusive jurisdiction of the Twelfth Judicial Circuit in and for Sarasota County, Florida, or the United States District Court for the Middle District of Florida, in any action or proceeding arising out of, or relating to, these terms and conditions, or the relations between Customer and Company.

14. ENTIRE AGREEMENT

These terms and conditions constitute the entire agreement between Customer and Company and supersede all prior agreements and understandings, whether written or oral, between and among such parties relating or regarding the subject matter of these terms and conditions.

CARE & CLEANING

Klodea’s collections are realized with Zamac and Aluminum materials and can be easily cleaned by following the instruction below:

POLISHED FINISHES

Our polished finishes can be cleaned by simply using a dry soft cloth or a damped with warm water. Always make sure to dry excessive water from the product.

MATT FINISHES

Our matt finishes require a minimum cleaning. Just use a soft dry cloth to dust the product.

We do not recommend using paper towels, paper-based wipes, sponges or brushes that could have an abrasive effect on our collections.

Do not use any chemicals such as harsh cleaners or abrasives that may scratch or dull the surface.

THANK YOU.

klodea.

Klodea International

Via Giusti 31
20833 Giussano (MB)
ITALY

Klodea USA

1990 Main Street, Suite 750
34236 Sarasota (Florida)
UNITED STATES OF AMERICA

Tel. +1 941 323 5635
Fax: +1 941 309 5404

www.klodea.com
info@klodea.com



