



klodea.

HANDLES TWOTHOUSANDEIGHTEEN

# INDEX

---

<b>Intro</b>	four
<b>Ile collection</b>	six
<b>Moreorless collection</b>	eight
<b>Oh collection</b>	ten
<b>Soie collection</b>	twelve
<b>SV collection</b>	fourteen
<b>Thefin collection</b>	sixteen
<b>Tondoquadro collection</b>	eighteen
<b>Ile push</b>	twenty
<b>Voile</b>	twentytwo
<b>Ben</b>	twentyfour
<b>Flo</b>	twentysix

# THE LINES OF NATURE THE HAND OF **KLODEA**.

---

Our vocation is form. Basic, orderly, inspired by the balance of natural elements.  
Klodea's handles and finishing accessories are the interpretation of a typically Italian artistic language.

They lend an unprecedented lightness to the gentle, well-defined lines of their components.

Tradition is, for us, a launching-pad for the achievement of new creative ideas.

We instil in our work the dream of pure and accessible design, the search for a form that implies a meaning.  
Vision and action are intimately linked in Klodea's products, the expression of beauty and ergonomics combined.

A constant aspiration to elegant and functional design is the distinguishing mark of our group and its products.

Klodea is the formal expression of quality.



MADE IN ITALY

[ WITH LOVE ]

# ILE COLLECTION

BY SIMONE VIOLA

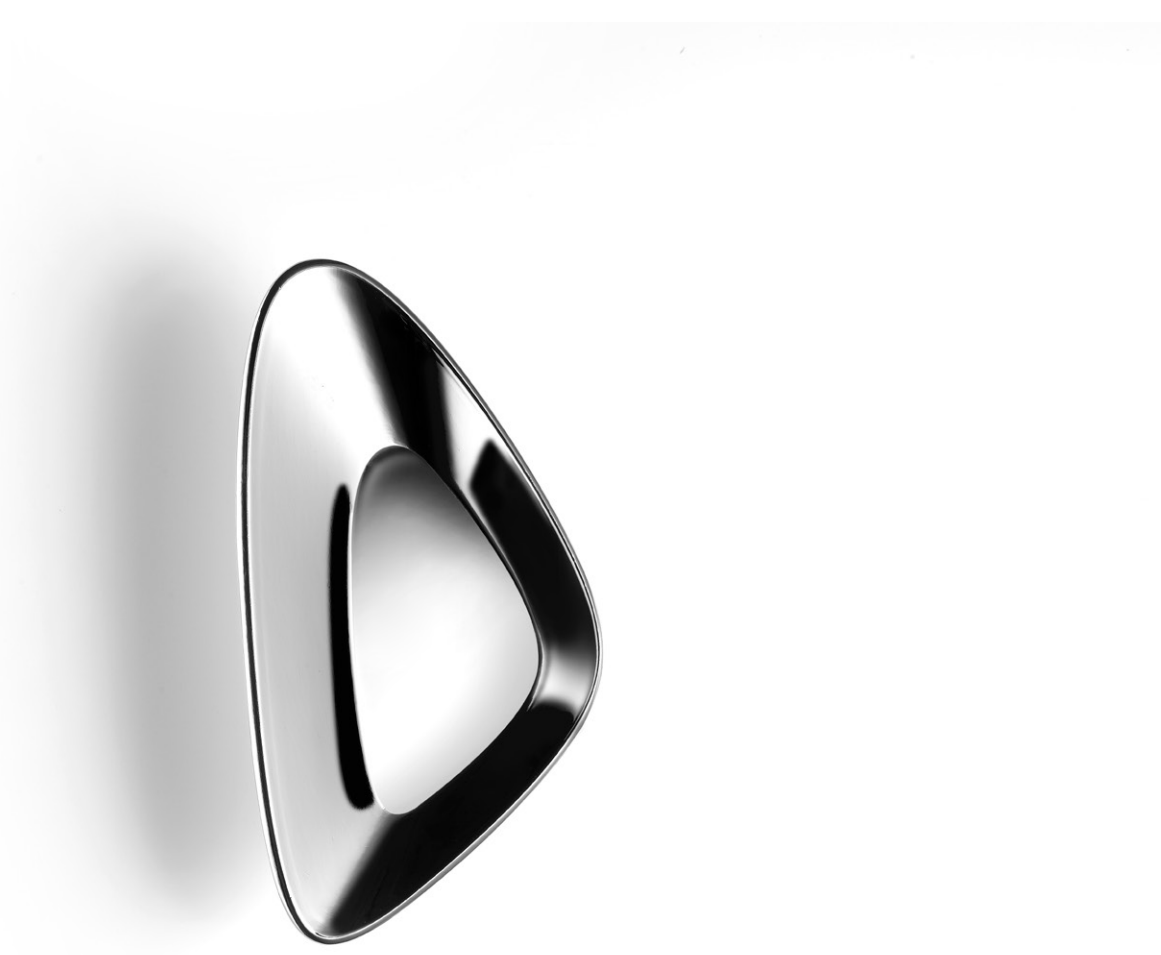

Ile Small | 2241-54mm  
c.c. distance: 16mm

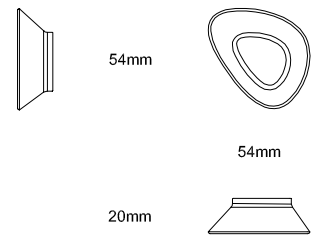

Ile Medium | 2241-60mm  
c.c. distance: 16mm

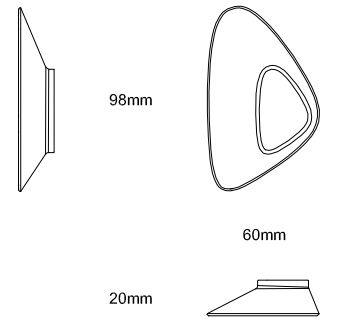

Ile Large | 2241-154mm  
c.c. distance: 32mm

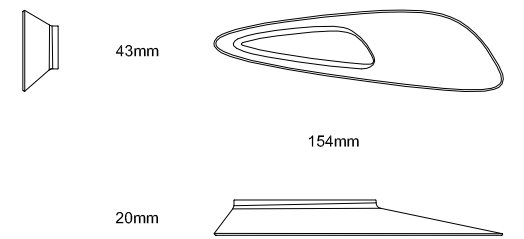

# MOREORLESS COLLECTION

BY SIMONE VIOLA

Moreorless Small | 2245-160mm  
c.c. distance: 64mm

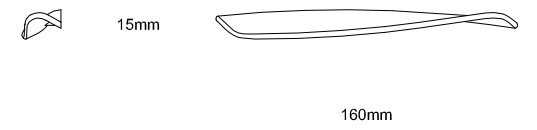

Moreorless Medium | 2245-250mm  
c.c. distance: 96mm

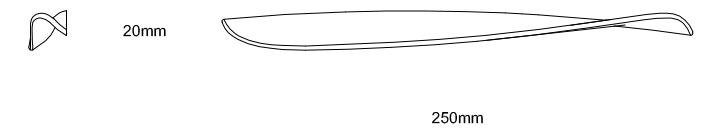

# OH COLLECTION

BY SIMONE VIOLA

Oh Small | 2254-64mm  
c.c. distance: 32mm

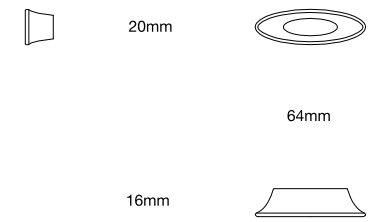

Oh Medium | 2254-108mm  
c.c. distance: 64mm

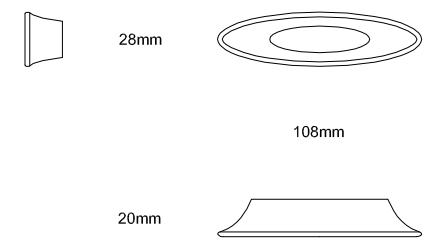

Oh Large | 2254-164mm  
c.c. distance: 96mm

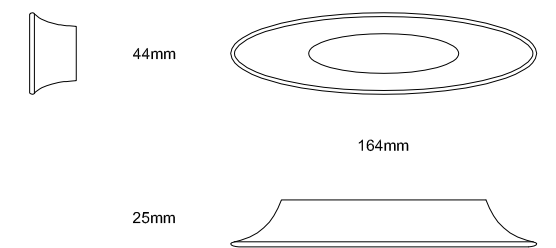

# SOIE COLLECTION

BY SIMONE VIOLA



Soie Small | 2247-200mm  
c.c. distance: 160mm

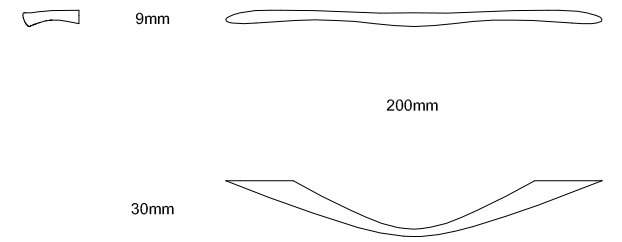

Soie Medium | 2247-300mm  
c.c. distance: 256mm

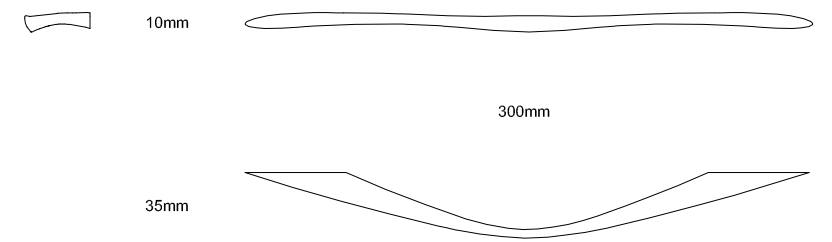

Soie Large | 2247-400mm  
c.c. distance: 320mm

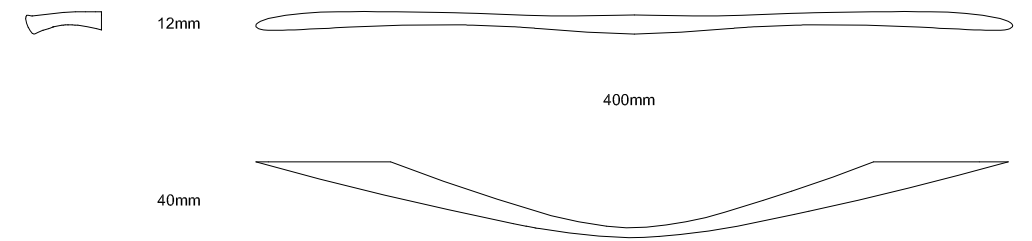

# SV COLLECTION

BY SIMONE VIOLA

SV one | 7181-X

c.c. distance: 96mm | 128mm | 160mm | 128/224mm | 192/288mm | 224/320mm | 288/384mm | 384/448mm

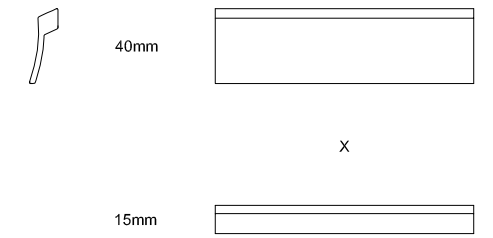

SV two | 7186-X

c.c. distance: 96mm | 128mm | 160mm | 128/224mm | 192/288mm | 224/320mm | 288/384mm | 384/448mm

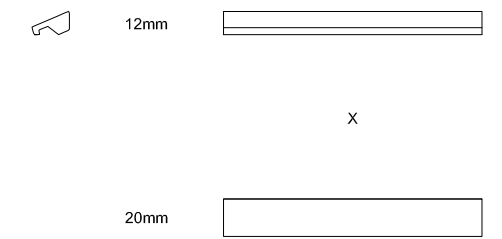



# THEFIN COLLECTION

BY SIMONE VIOLA



Thefin Small | 2242-100mm  
c.c. distance: 32mm

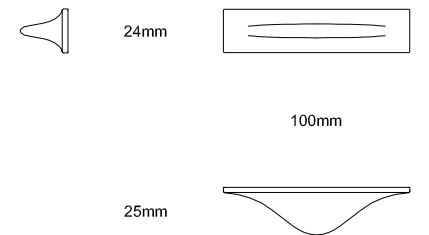

Thefin Medium | 2242-160mm  
c.c. distance: 96mm

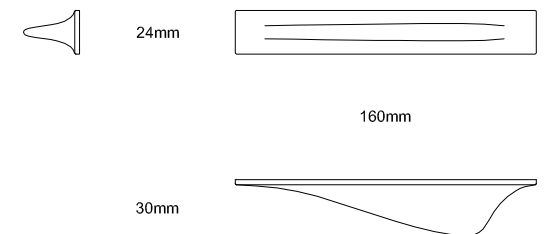

# TONDOQUADRO COLLECTION

BY SIMONE VIOLA



Tondoquadro Small | 2246-50mm  
Knob

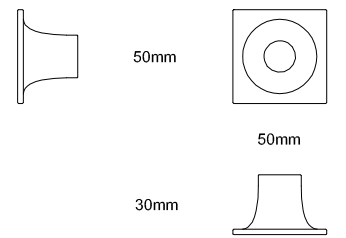

Tondoquadro Medium | 2246-180mm  
c.c. distance: 128mm

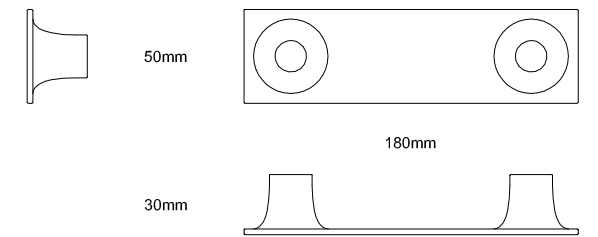

Tondoquadro Large | 2246-275mm  
c.c. distance: 224mm

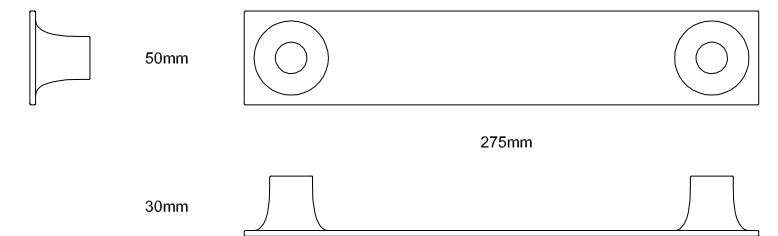

# ILE PUSH

BY SIMONE VIOLA

Ile Small | 7184-36mm  
c.c. distance: 16mm

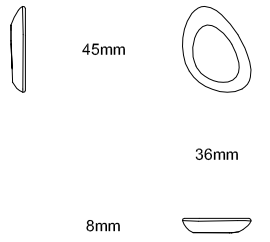

# VOILE

BY SIMONE VIOLA

Voile Small | 2250-90mm  
c.c. distance: 32mm

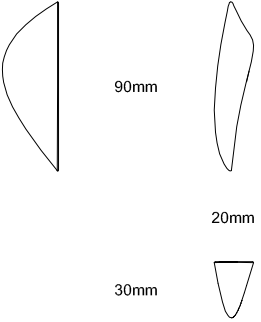

# BEN

BY SIMONE VIOLA

Ben Small | 2240-125mm  
c.c. distance: 96mm

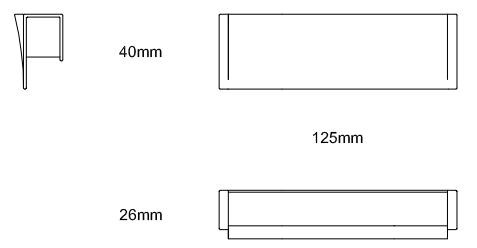

FLO

BY SIMONE VIOLA

Flo Small | 2239-120mm  
c.c. distance: 96mm



30mm



120mm

40mm

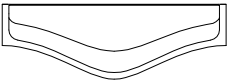

# klodea.

**Klodea International**

Via Giusti 31  
20833 Giussano (MB)  
ITALY

Tel: +39 0362 310328

Fax: +39 0362 335508

**Klodea USA**

1990 Main Street, Suite 750  
34236 Sarasota (Florida)  
UNITED STATES OF AMERICA

Tel. +1 941 309 5256

Fax: +1 941 309 5201

[www.klodea.com](http://www.klodea.com)  
[info@klodea.com](mailto:info@klodea.com)

[www.klodea.com](http://www.klodea.com)