

# POT FEEDER

## GENERAL WATER SYSTEMS

THIS DRAWING IS FOR SPATIAL CONSIDERATION ONLY, AND SUBJECT TO CHANGE W/O PREVIOUS NOTICE, DO NOT PRE-PLUMB TO THESE DIMENSIONS

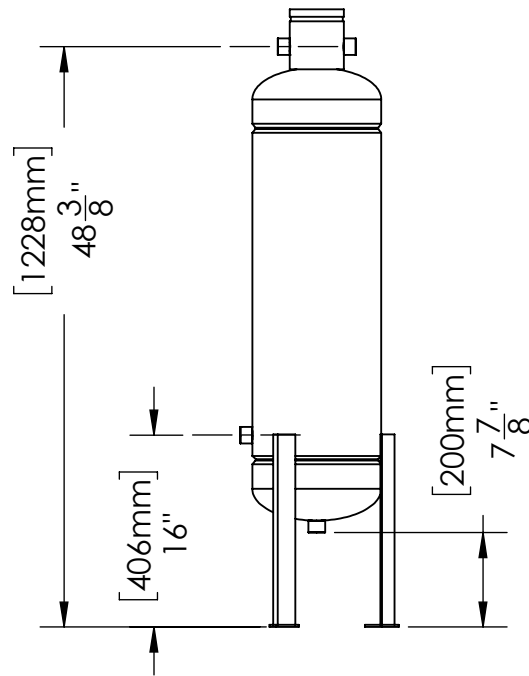
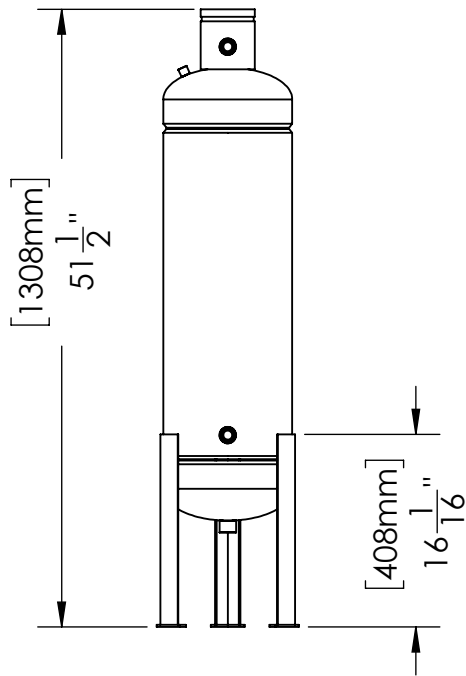
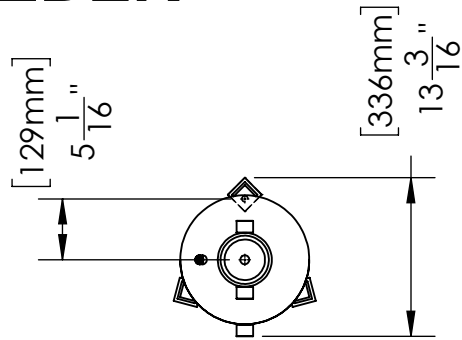

### DB-12-GE-CS-Z

Operating Point	Up to 500 Gallon System Volume		
Pot Feeder - Size & Style	Dome Bottom 12 Gallon Safety Bar		
Construction	Carbon Steel (Welded)		
<b>PROCESS INLET</b>			
Connection - Type & Size	NPT 3/4"		
<b>PROCESS OUTLET</b>			
Connection - Type & Size	NPT 3/4"		
<b>PRESSURE - Maximum Operating</b>			
Vessel	150 psi (10.3 bar)		
<b>TEMPERATURE - Maximum Operating</b>			
System	34°F - 122°F (1°C - 50°C)		
<b>WEIGHTS</b>	<b>DRY</b>	<b>SHIPPING</b>	<b>OPERATING</b>
lbs (kg)	TBD	TBD	TBD

PREPARED BY:  
HECTOR J. GUZMAN

REV  
A

RELEASED BY:  
TIM BOYLEN

DATE:  
10/26/2020



General Water Systems | P.O. Box 444 | Desert Hot Springs | CA | 92204  
www.gwslp.com | info@gwslp.com | 951.213.9506 | 386.255.3909

\*UNLESS OTHERWISE SPECIFIED - ALL DIMENSIONS ARE IN INCHES

**DB-12-GE-CS-Z**