



Founded in 2019, our company is experiencing many difficulties especially facing the ongoing transition period



Quality Comes at Affordable Price!!

Registered office: Plot no. 25 26 ,
803 G Square Business Park, Vashi
Sector-30, Navi Mumbai-400705

Contact: +966.534451695, +919830399151
E-mail: gce@gce.net.in
Website: www.gce.net.in

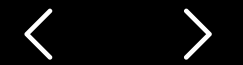



About OUR FIRM.

Diversity and inclusion.
Driving innovation.

With GCE'S perfect execution in Design Engineering & Project Management and working together, we have obtained a competitive edge in the industry.





About OUR TEAM.



ER. GOUTAM CHAKRABORTI
(MD & CEO)





Company Purpose

Our unique combination of consulting, knowledge, assurance and regulatory services makes organizations more resilient, and in turn inspires trust in their products, systems, services, and the world we live in.



Our Purpose:
To inspire trust for a
more resilient Work.

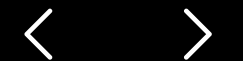



Company Vision

Double business with half the impact.

GCE Consulting Engineers is a multi-disciplinary Engineering & Drafting company registered in India Mumbai and one of the fastest growing leading engineering company which giving technical services to Major Sectors like Petrochemical , Oil & Gas , Energy & Power ,Steel in GCC (middle-east) & India.

Our Engineers are highly competent and have extensive professional experience in the field of Design Engineering & Project Management with 15 to 30 years of work experience serving globally.

Be Kind

Do the right thing.

Be Honest

Keep your word.

Be Smart

Make things better.





Company Mission

Bring inspiration and innovation to the Engineering world
We create a life-changing experience through the quality of our products and services. We provide a common ground for all people throughout the world.



CIVIL & STRUCTURAL

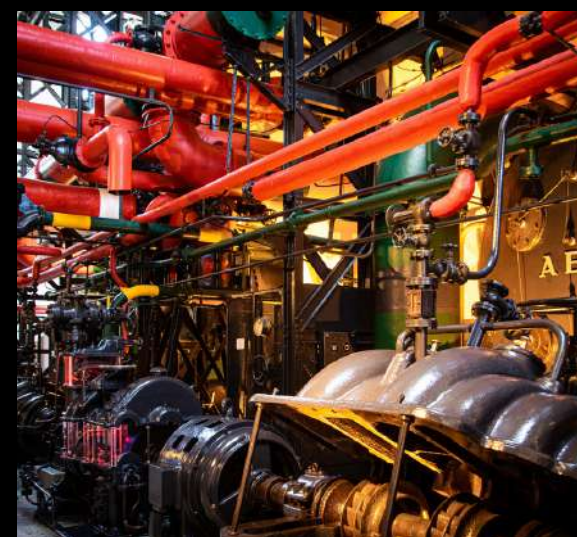

MECHANICAL/PIPING

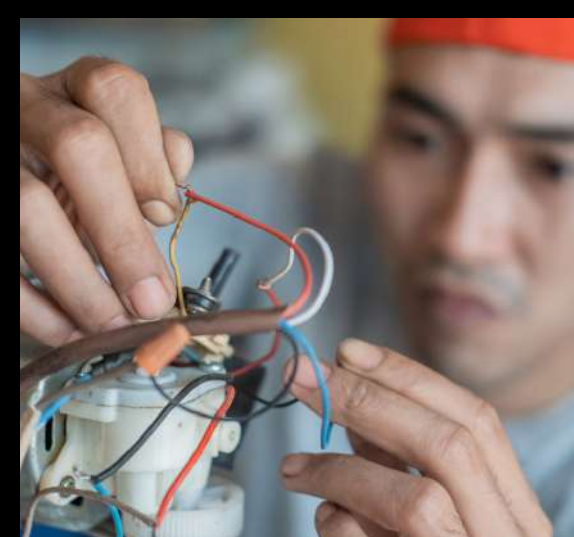

ELECTRICAL



INSTRUMENTATION





Our Services



01.

CIVIL & STRUCTURAL.

GCE is a Civil & structural engineering company, our focus is on the design, detailing, and analysis of structural foundations across manufacturing/massive industrial infrastructure and process facilities.

Steel Structure

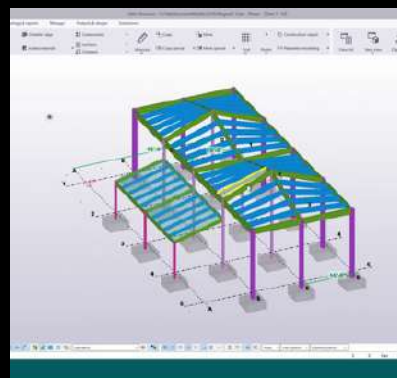

Highrise Building



Warehouse Design



Foundation Drawing

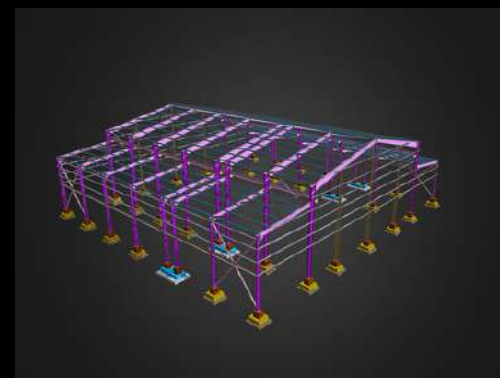

Pipe Rack Design



Fabrication & Erection





Our Services

02. MECHANICAL/PIPING

We are specialized in piping and mechanical works: engineering, prefab, and on-site construction. Our offering includes maintenance of piping and a variety of installations, with CS, stainless steel, aluminum, GRE, monel, and other materials.

Pipe stress analysis by Caesar-II

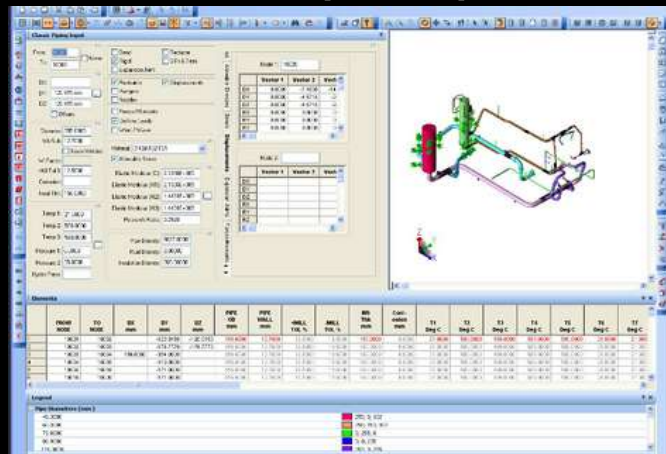

Cooling Tower & HVAC Design



Piping System Design



Firefighting System Design





Our Services

03. INSTRUMENTATION & CONTROL

Basic Technical specification, data sheet for Analyzer Shelter along with inside components, data sheet DCS system, marshaling panel along with its components, data sheet, Scheme for CCTV system.

- Process & Instrumentation diagram
- Interlocks in Control philosophy Flow chart, logic diagram
- Flow chart, logic diagram
- Cause & Effect diagram
- Specification, data sheet of different local gauges, flow element, temperature element, transmitter, analyzer, PLC, DCS Smart P&ID Specification, data sheet for signal, control & power cable Specification, data sheet for Custody Transfer Metering System Conceptual block diagram
- Cable interconnection block diagram
- Cable route drawing via tray or conduit JB writing drawing, JB Inter connection diagram Instrument loop diagram Instrument hook-up diagram with BOQ
- Flow Element, Control Valve, Pressure safety valve sizing calculation by Instru-Cal software
- Wake frequency calculation for Thermowell

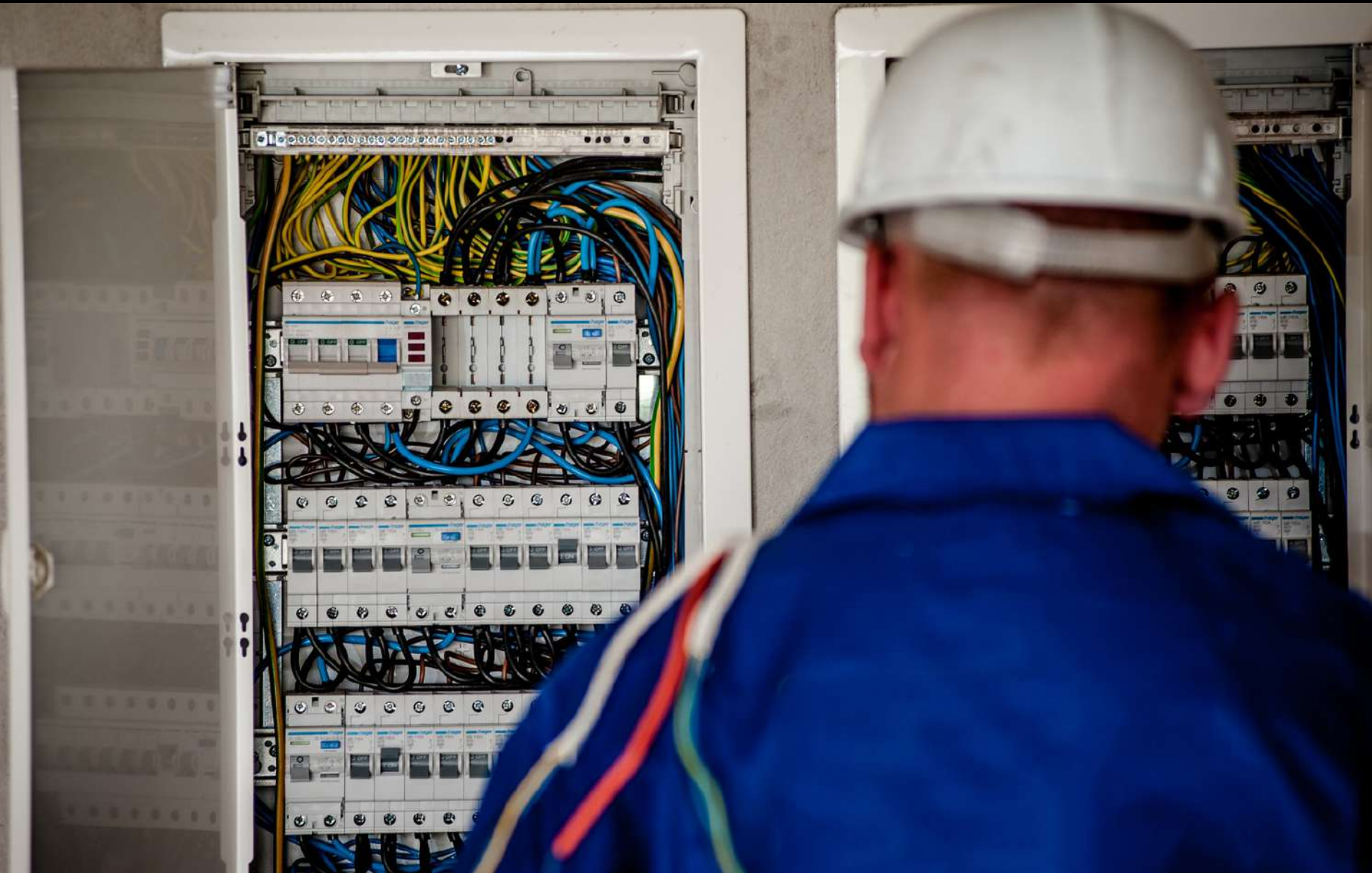

Our Services

04. ELECTRICAL

Experience Excellence in Electrical Services: Discover a wide range of expert electrical engineering services tailored to meet your specific needs.

POWER SYSTEM ANALYSIS

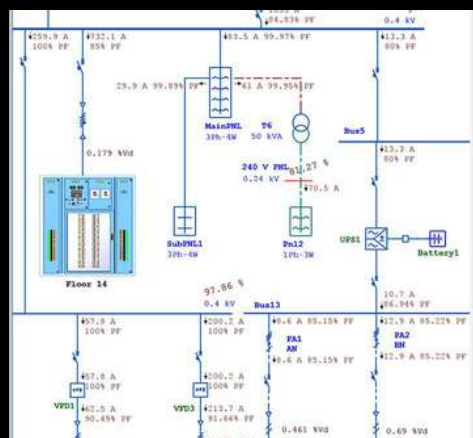

ARC FLASH ANALYSIS

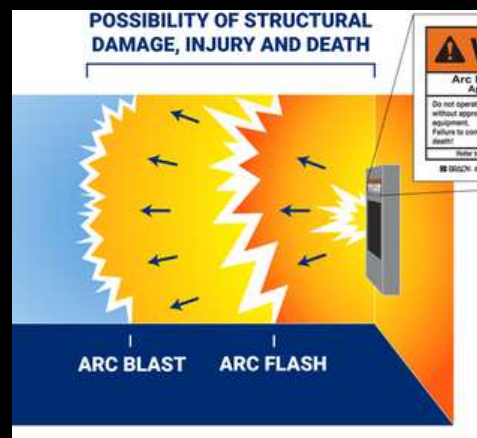

EQUIPMENT SIZING



ANALYSIS TEST REPORT



ASSET MANAGEMENT



MAINTENANCE STRATEGY





Our Resources

In the realm of engineering, our distinguished team showcases an unparalleled 15 to 30 years of extensive multinational design engineering experience, specializing in the intricate domains of Petrochemical, Oil and Gas, Steel, and all major heavy industrial design and engineering services that include Civil, Structural, Architectural, HVAC, Mechanical/Piping, Instrumentation, etc. using the latest state of the art Softwares. Our seasoned engineers bring forth a wealth of expertise, ensuring the highest standards of excellence and innovation in every facet of their work.

MANPOWER AND SOFTWARES

A. ENGINEERS

- 1. Civil Engineer..... 03
- 2. Structural Engineer..... 03
- 3. Architecture..... 02
- 4. HVAC Engineer..... 02
- 5. Mech./Piping Engineer..... 04
- 6. Electrical Engineer..... 05
- 7. Instrumentation Engineer..... 02
- 8. Project Engineer..... 02

B. DRAFTSMAN

- 1. Civil / Structural..... 15
- 2. Architectural..... 02
- 3. HVAC 02
- 4. Mech./Piping..... 04
- 5. Electrical/Instrumentation.... 02

C. SOFTWARES

- 1. STAADPRO Connection Edition
- 2. STAAD Foundation Advance
- 3. Pro-Steel
- 4. Pro-Concrete
- 5. RCDC
- 6. Caesar-II
- 7. TEKLA
- 8. AutoCAD
- 9. ETAP
- 10. SPI/Instrucal

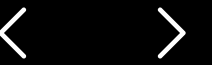

PROJECTS COMPLETED!!!

Sr.No	Engineering Project	Client	Engineering services
1	Structural analysis & design of Underground Concrete pit for installation of MOV's	SABIC-YANSAB	Engineering & Drafting
2	Civil, Piping design for orientation of Motorized Valve and to reduce NRV Arm length- Structural modification	SABIC-YANSAB	Design Engineering & Drafting
3	Civil foundation design for installation of new Heat Exchanger A/B with increased load	SABIC-YANSAB	Design Engineering & Drafting
4	Structure load verification and design to install sky climber	SAFCO	Design Engineering
5	Design for 58 inch lifting flange	SAFCO	Design Engineering & Drafting
6	Fabrication drawing for Stair Tower to Lime Silo platform through Bag Filter	VEOLIA	Fabrication, Erection drawing
7	Tank farm pipe support structure connection design and fabrication drawing	VEOLIA	Fabrication, Erection drawing
8	Auditorium Gallery structure and foundation design & fabrication	ECCL	Engineering & Drafting
9	Pipe Stress Analysis in CEASER-II for Streamer elimination in PHD bypass line-Yanbu Saudi Arabia	SABIC-YANSAB	Pipe Stress Analysis
10	Pipe stress Analysis in CEASER-II for HDPE transfer line- Yanbu Saudi Arabia	SABIC-YANSAB	Pipe stress Analysis
11	Pipe stress analysis in CEASER-II Upgrade EO Lines, CS Piping To SS304L	SABIC YANPET	Pipe stress Analysis
12	Pipe stress analysis in CEASER-II for SABIC YANPET Shutdown JOB 2024	SABIC YANPET	Pipe stress Analysis
13	Structural analysis & design of structure for adequacy check for new valve installation with 3 ton increased load -shutdown job 2024	SABIC YANPET	Structural analysis
14	Structural design & electrical engineering for Steel warehouse with 20 Ton EOT crane shed	YASREF	Design engineering
15	ETAP analysis for flash Arch SABTANK	SABTANK	Electrical engineering



PROJECTS COMPLETED!!!

Sr.No	Engineering Project	Client	Engineering services
16	Capacitor bank support structure Fabrication, foundation drawing	SABIC-SHARQ	Fabrication, Erection, Foundation drawing
17	Preparation of Fabrication drawing for steel structure and roof sheeting	VEOLIA	Fabrication, Erection drawing
18	Preparation of fabrication drawing for hand rail and entry gate of monkey ladder	VEOLIA	Fabrication, Erection drawing
19	Pendulum Shear Drive Gear Box Base Structure Concrete foundation drawing	SABIC-HADEED	Foundation Drawing
20	Design, Fabrication & Erection for 24 and 42 inch lifting flange for gas seal	Sabic Petrokemya & Gulf Farabi	Engineering & Drafting
21	Structural Analysis & Design for 42" Pipe line No#10 Support-Yanbu Saudi Arabia	SABIC-YANSAB	Structural Analysis & Design. Drafting in TEKLA
22	Detail engineering, Fabrication and erection drawing of pipe rack ISBL zone-E steel structure- Yanbu Saudi Arabia	SABIC-YANSAB	Fabrication drawing, erection drawing, Connection design. Drafting in Tekla.
23	Detail engineering Fabrication and erection drawing Pipe support & Steel structure for installation of 2nd C2 cut dryer- Yanbu Saudi Arabia	SABIC-YANSAB	Fabrication drawing, erection drawing, Connection design. Drafting in Tekla.
24	Preparation of Fabrication Drawing	Turaif White Cement	Fabrication, Erection drawing
25	Modification Of Line-2 Circulation Water Lines- Noth region cement co.	Turaif White Cement	Pipe Stress Analysis
26	Salt conveyor belt structure modification (In kind)	Sabic Petrokemya & Sadaf	Engineering & Drafting
2728	Design engineering of structure sway measurement	SABIC-YANSAB	Engineering & Drafting
28	Passive defence system against Drone (barriers)	Arabian Chemical Terminal	Engineering & Drafting
29	Structural detail engineering and fabrication / Erection drawing, for Deaerator 5-DA-3001A ,APPC ,Saudi	Advanced Polypropylene Company	Fabrication, Erection drawing

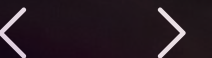

PROJECTS COMPLETED!!!

Sr.No	Engineering Project	Client	Engineering services
30	Roof opening design + GA for replacing existing 3 MV motors- Qurayyah, KSA	ARAMCO	Engineering & Drafting
31	Design and Drafting services for NIC facility PEB Buildings Civil works	NEOM	Engineering & Drafting
32	Design & Drafting services for Erection of Transformer Shed	Petrochemical Conversion Company	Engineering & Drafting
33	Structural design analysis & detail engineering fabrication & erection for Merchant TiCl4 building- Yanbu Saudi Arabia	TRONOX	Structural design analysis & detail engineering fabrication & erection drawing
34	Civil foundation design flooring and detail engineering drawing for Merchant building(via Expertise)- Yanbu Saudi Arabia	TRONOX	Civil foundation design, flooring and detail engineering drawing
35	Structural design and drafting in Tekla–new Plate exchanger-Yanbu Saudi Arabia	SABIC	TEKLA Drafting for Erection and Shop drawing
36	Modification of SABIC LAB in KAUST-Saudi Arabia	SABIC	Engineering services
37	Installation of Electric	MARAFIQ	Engineering services
38	Potable water line to safety bath at emergency isolation valve station in sales gas distribution network	MARAFIQ	Engineering services
39	Replacement of deteriorated bus duct outdoor housing for 4.16kv bus between transformers (sw-11, 12, 13 & 14) and	MARAFIQ	Engineering services
40	Structural design Review for Heat exchanger E2522	SABIC-YANSAB	Structural Design by STAADPRO and Drafting
41	Structural design of EDG structure and review of foundation	SABIC	Structural Design by STAADPRO and Drafting
42	Structural Design & Analysis for Pipe rack	SABIC	Structural Design
43	Merging of fire & gas system of dry end-II control room with wet end-II control room	SABIC-YANPET	Engineering
44	Structural Design and drafting of Car parking shed	SABIC-GAS	Engineering
45	Upgrading PLC, HMI and installation / replacement of analyzer, instruments at IWTP-2 and SWTP-2	MARAFIQ	Engineering

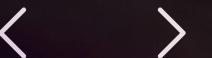



Industry Sectors

We offer global solutions across MEP & Project Management services for industry sectors. Discover the key issues and drivers for your industry sector as well as the services, standards and solutions to address those challenges.

Warehouse

Services in Warehouse for Various Organizations

Pharma

Pharmaceutical and medical companies.

Food and Beverages

Services for Food and Beverages companies as per National & International Standards.





Commercial & Residential Sector

We Administer all the services along with Integrated System solutions across a wide range of Commercial & Residential Sectors. Discover the key issues and drivers for your Commercial/Residential sector as well as the services, standards, and solutions to address those challenges.

Hi-Rise Buildings
Commercial and
Residential Sectors

Hotels & Restaurant
Commercial Sector.

Villa's
Commercial and
Residential Sector





Contact us for More

Questions? Comments? Concerns?

Contact us to discuss anything you'd like, or simply drop a line to say hi. We always welcome the opportunity.



Phone

+966534451695



Email

gce@gce.net.in



WhatsApp

+966534451695