

2023 BC-25 HD SW & DW

BY BCROASTERS.COM

THE 2023 BC-25 CONTINUES TO GROW IN NEW FEATURES EACH YEAR. AND 2023 ADDS SIX NEW FEATURES TO HELP THE ROASTMASTER PRODUCE THE FINEST IN COFFEE ROASTING:

1. **NEW FRONT BEARING SYSTEM THAT ALLOWS ON THE FLY DRUM ALIGNMENTS**
 2. **EASY ACCESS TO BACK DRUM SYSTEM FOR MAINTENANCE**
 3. **A NEW BACK DRUM SHAFT WHEEL FOR QUICK REMOVAL OF BEANS IN THE EVENT OF A POWER OUTAGE WHILE ROASTING**
 4. **TWO WAYS TO CONTROL AIRFLOW VIA THE MANUAL DIAL DAMPER PLUS PRECISE AIR FLOW CONTROL VIA A FAN SPEED CONTROLLER POWERED BY A 3 PHASE MOTOR AND CONVERTER**
 5. **NEW FRONT ENTRY DOOR TO BURNER ROOM ALLOWING QUICK MAINTENANCE WHEN NEEDED**
 6. **NEW DATA LOGGER COMPUTER CHIP TO ALLOW DIRECT BLUETOOTH CONNECTIVITY WHILE USING ARTISAN SOFTWARE.**
- ADD ALL THE ABOVE TO THE MANY PREVIOUS FEATURES WE HAVE ADDED OVER THE LAST SEVERAL YEARS AND YOU HAVE THE MOST ADVANCED BC-8 ROASTER AVAILABLE.**

THE BC-25 HD IS THE WORKHORSE IN THE BC LINE. IT WILL ROAST UP TO 125LB. PER HOUR. IT FEATURES EASY TO USE CONTROL PANEL WITH BUILT IN SAFETY FEATURES SUCH AS PILOT LIGHT, EMERGENCY SHUT OFF CONTROL AND MANY OTHER FEATURES TO ENSURE SAFE OPERATION. COMPLETE AIRFLOW CONTROL VIA THE MDDS AIRFLOW SYSTEM. LED LAMP TO LIGHT THE WAY AND LOCKING CASTERS TO MAKE FOR EASY MOVING AND SETUP. DIRECT CONNECT CHAFF UNIT FOR REDUCED FOOTPRINT AND GREATER EFFICIENCY.

IN 2022 WE ADDED MORE HEAVY DUTY FEATURES SUCH AS A NEW HD CHAFF FAN AND HD GAS GAUGE PLUS NEW CUSTOM MADE 3MM THICK THERMOCOUPLES FOR QUICK RESPONSE. A MAG AIRFLOW GAUGE IS INCLUDED & YOU CAN ALSO ADD AN OPTIONAL COOLING TRAY COVER.

“GET YOUR ROAST ON!”



BC-25 HD	GAS TYPE
Batch Size	6-25lb.
Roasting Time	10-15 minutes
Production	96-125lb.hr
Heat Source	NG/LPG
Voltage	220V
Wattage	1200W
Drum Motor	200W
Chaff Fan Motor	370W
Cooling Fan Motor	370W
MIXING ARM	90W
BTU	120,000
NG PRESSURE	7-14WC
LPG PRESSURE	MAX. 16-20WC
Gas Consumption	1.2kg/hr
Roaster Dim.	66x42x74 (LxWxH)
Roaster Weight	1254lb.
Package Dimensions	71x46x65 1365lb.

FEATURES

DRUM TYPE	Single or Double Wall
DATA LOGGING	2 OMRON CONTROLS w/BT & ET
THERMOCOUPLES	K-TYPE for BT & ET
CONTROL PANEL	BT & ET VIEW ON PANEL
WARRANTY	1 YEAR PARTS & INSTRUCTION
PARTS AVAILABLE	10 Year Parts Available Guarantee
110V CONVERTER	Optional 110V Voltage Converter
TYPE	3000W may be purchased separate.
DATA LOGGING	

NEW FEATURES FOR 2023!

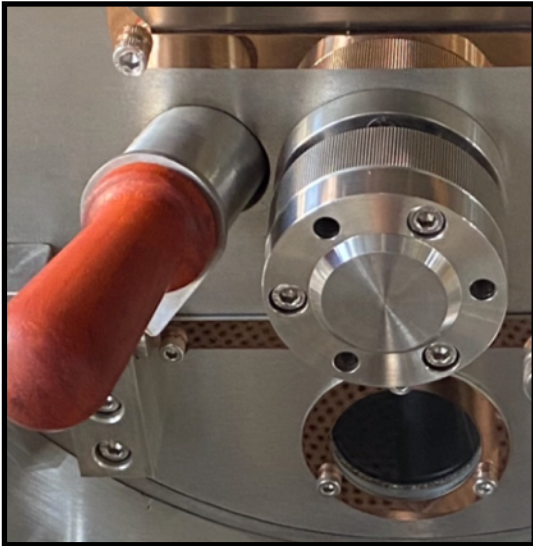

NEW FRONT BEARING SYSTEM



EASY ACCESS BELT COVER



NEW DRUM SHAFT WHEEL



NEW PRECISE ELECTRONIC AIRFLOW CONTROL



FRONT BURNER ROOM DOOR

PLUS NEW BLUETOOTH DIRECT CHIP FOR ARTISAN!

THE BC-25 HD IS A HEAVY DUTY ROASTER BUILT WITH A CARBON STEEL BODY WITH APPROVED POWDER COAT HIGH TEMPERATURE BODY IN BLACK, RED OR WHITE. THE HOUSINGS COME IN A VARIETY OF CHOICES.

TWO EXHAUST PIPE COMES OFF THE BC-25. The CHAFF EXHAUST AT 5" AS SHOWN BELOW AND CAN BE EXHAUSTED SEPARATELY OUT OF BUILDING OR JOINED WITH A BLAST DAMPER OR BACKDRAFT DAMPER ABOVE CHAFF UNIT. (6" HIGH TEMPERATURE VENTING IS RECOMMENDED WHEN VENTING EACH SEPARATELY)

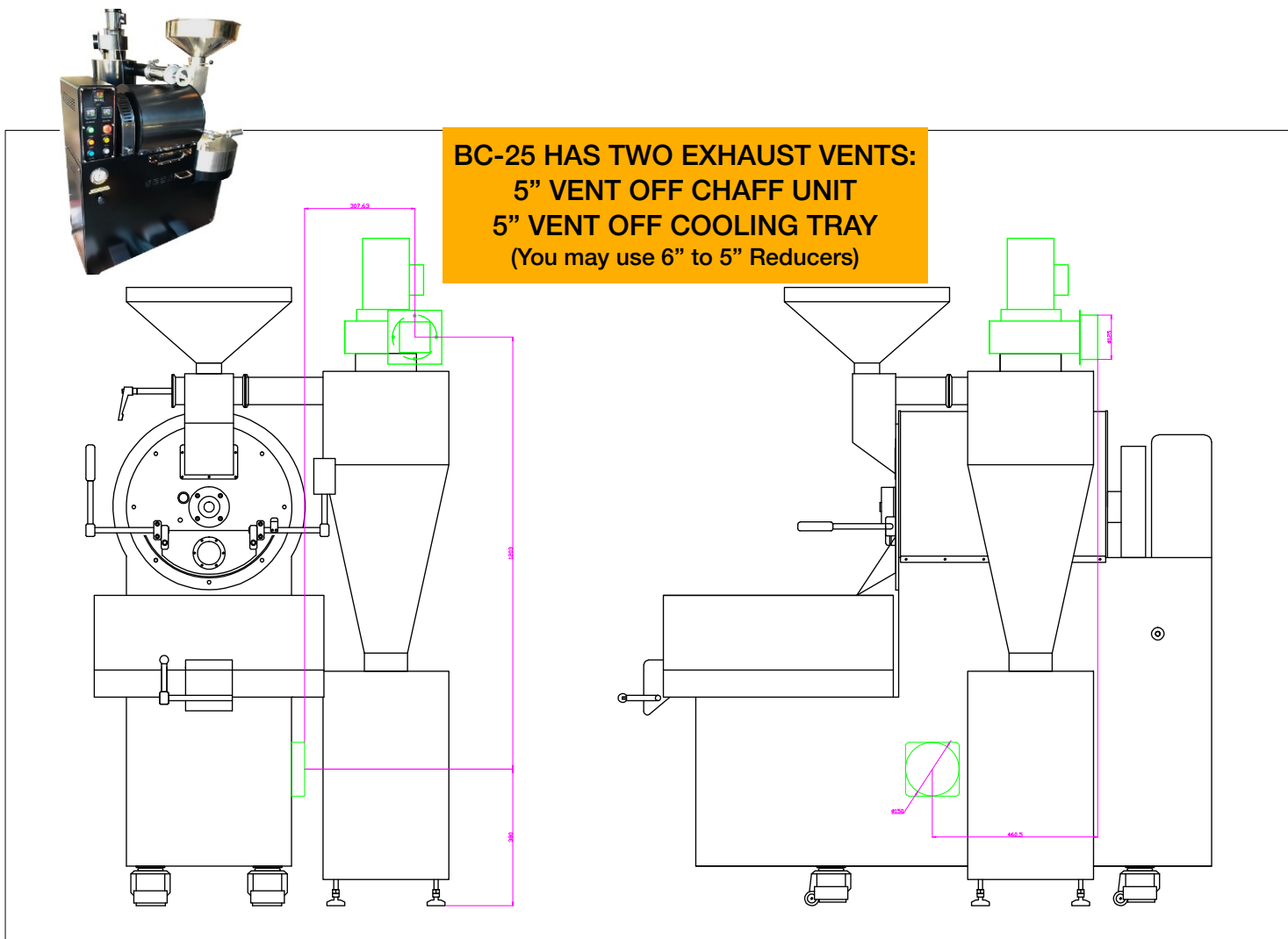

COMPUTER DATA LOGGING VIA ARTISAN SOFTWARE

RECORD ROASTS VIA USB OR BLUETOOTH TO DUPLICATE PROFILES USING ARTISAN SOFTWARE.

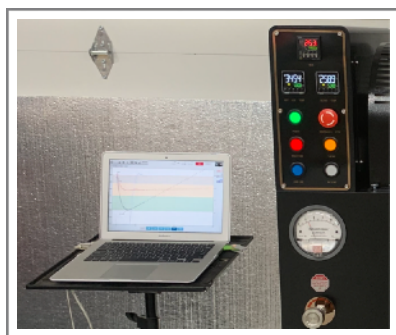

ARTISAN SOFTWARE

Do your part to Keep Artisan Alive and Well.

Donate to Artisan Here:

<https://artisan-scope.org/donate/>

DO YOUR PART!

CONSIDER

ARTISAN PLUS

<https://shop.artisan.plus>



artisan+

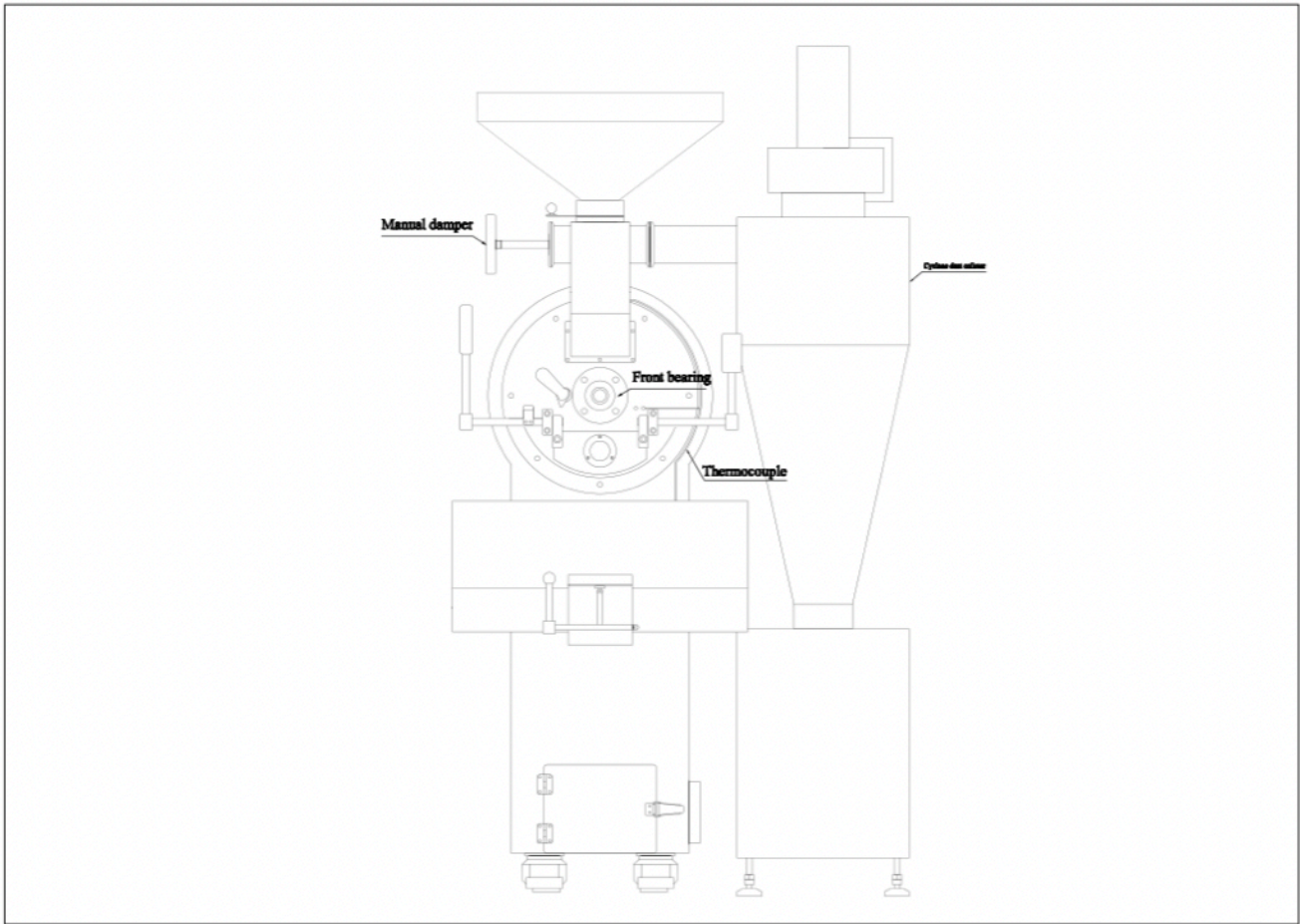
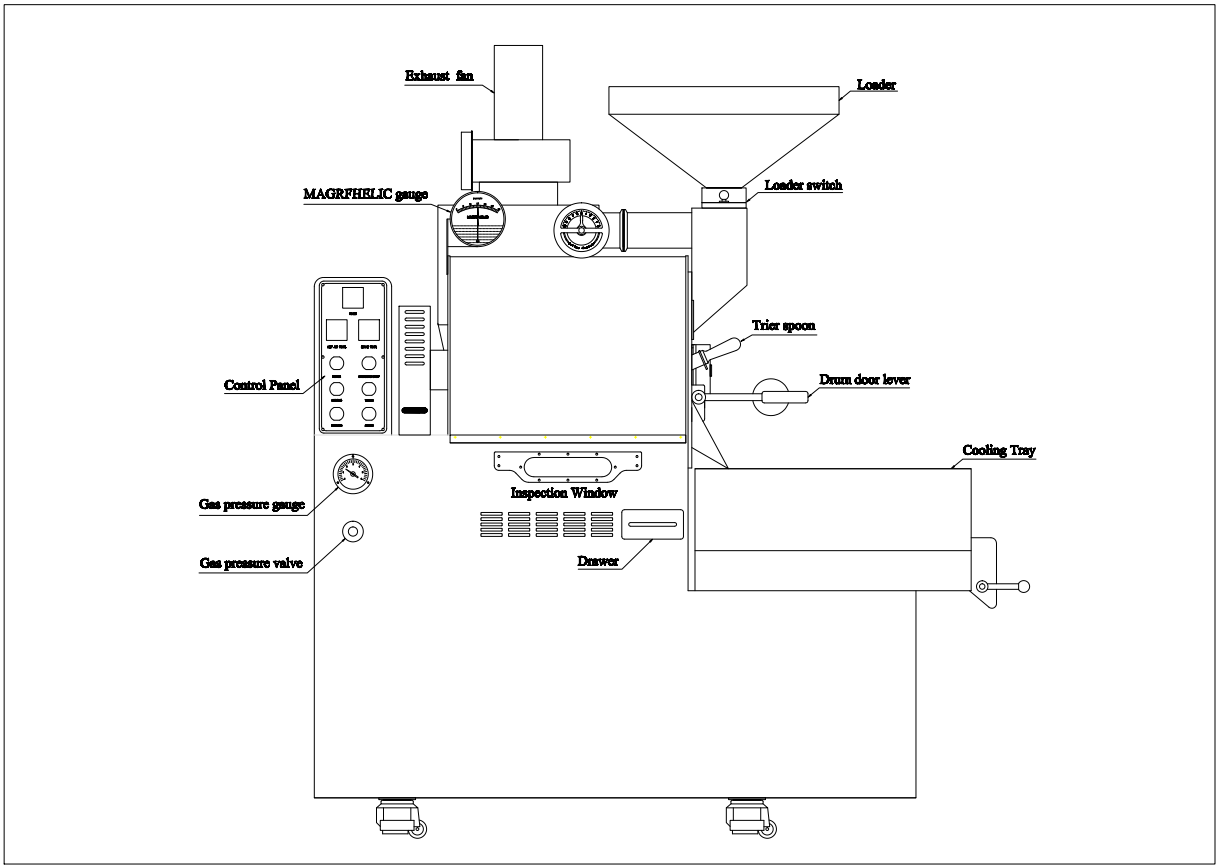

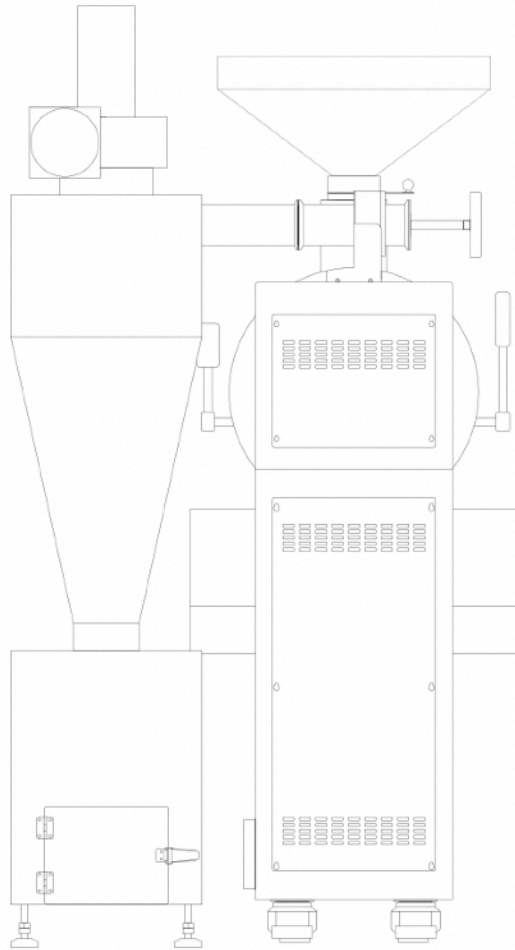

BC ROASTERS NOW COME IN 3 BODY COLORS:
BLACK, RED & WHITE



**BLACK BODY WITH BLACK
CHECKERED HOUSING**



**RED BODY WITH GOLD
CHECKERED HOUSING**



**WHITE BODY WITH
ROSE GOLD HOUSING**

SOLID COLORS



ROSE GOLD



STAINLESS

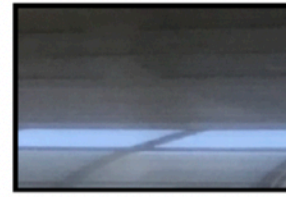

BLACK TITANIUM

TEXTURED HOUSINGS

CHECKERED



**CHECKERED
BLACK**

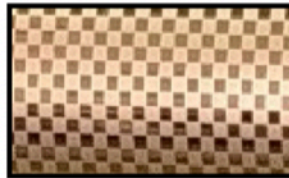

**CHECKERED
GOLD**

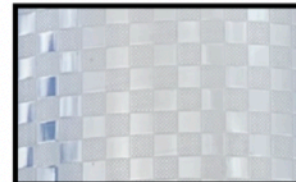

**CHECKERED
SILVER**

NEW FOR 2021

**SILVER
RAINDROP**



**GOLD
MOSAIC**



BODY COLORS:

BLACK, RED OR WHITE

SOLID HOUSING COLORS: ROSE GOLD, BLACK TITANIUM, STAINLESS

TEXTURE HOUSINGS: CHECKERED GOLD, CHECKERED BLACK OR CHECKERED SILVER

NEW!: SILVER RAINDROP & GOLD MOSAIC

FOR MORE INFORMATION SEE:

BCROASTERS.COM

HTTP://WWW.BUCKEYECOFFEE.COM/BC-COFFEE-ROASTERS.HTML

**BC ROASTERS
BUCKEYE, ARIZONA 85326
TONOPAH, ARIZONA 85354**

BC-25 COMMERCIAL COFFEE ROASTER

- *FLOOR MODEL WITH HD CASTER WHEELS
- *DIRECT CONNECT CHAFF UNIT FOR SMALLER FOOTPRINT
- *CHOICE OF ALL ELECTRIC OR GAS MODELS

SIZE (LxWxH)	66x42x74"
WEIGHT	1254LB
MINIMUM CLEARANCE FROM COMBUSTABLE MATERIALS	18-24"
ROASTING CAPACITY	5-25LB SINGLE WALL 2 TO 25LB DOUBLE WALL
ROAST TIME & ROASTS PER HOUR	9-14 MINUTES (5 ROASTS PER HOUR GAS. 3.5 PER HOUR ELECTRIC)
DRUM INFORMATION	SW DRUM: 5MM SUPERIOR 304SS CONTAINS 18% CHROMIUM AND 8% NICKEL DW DRUM: HAS TWO LAYERS: ONE OF 3MM & ONE 2MM 304SS WITH 6MM OF AIR CUSHION. SS WELDING (11MM TOTAL THICKNESS ON DW)
ELECTRIC STATS:	GAS MODEL: SINGLE PHASE 220V 50/60HZ 1200W REQUIRES STANDARD 15A BREAKER
ELECTRICAL PLUG TYPE	GAS MODELS: 20A 250V 3 WIRE NEMA 6-20P
FUEL CHOICES ON GAS MODELS	LPG GAS STANDARD WITH MODELS. NATURAL GAS CONVERSION KITS OFFERED FOR CUSTOMER INSTALLATION ONLY.
BURNER INFORMATION ON GAS MODELS	SW & DW BURNERS: 32
BTU REQUIRMENTS	125,000 BTU MINIMUM REQUIRED FOR NG LINE
GAS PRESSURE	LPG: 12-16WC (3-4KPA) MARSHALL 1912/197 REGULATOR RECOMMENDED NG: 7-14WC

EXHAUST SETUP	
EXHAUST PIPE REQUIREMENTS	POSITIVE PRESSURE EXHAUST VENTING WITH MINIMUM CLEARANCE 18-24' FROM COMBUSTABLE MATERIALS
MAXIMUM VENTING LENGTHS	20-25' FROM CHAFF UNIT. DEDUCT 3-5' FOR 45-90 DEGREE PIPE ELBOWS. IF YOU MUST VENT AT LONGER LENGTHS CONSULT A LOCAL TECHNICIAN ON USE OF POSSIBLE BOOSTER FANS
MAXIMUM EXHAUST TEMPERATURES	425-475F
CHAFF UNIT HIGH TEMP.	300-350F
COOLING TRAY HIGH TEMP.	200F
DATA LOGGING VIA ARTISAN OR CROPSTER	BUILT IN DATA LOGGER ATTACHES TO COMPUTER (PC OR MAC) VIA USB OR BLUETOOTH
K TYPE THERMOCOUPLES	BT & ET WITH TWO ADDITIONAL PREDRILLED CAPPED THREADED HOLES TO ADD OR ADJUST LOCATION OF PROBES
MANUFACTURED IN CHINA FOR BC ROASTERS	CUSTOM BUILT FOR BC SPECS IN USA AND OVER 200 LANDS

FOR MORE INFORMATION SEE:

BCROASTERS.COM

HTTP://WWW.BUCKEYECOFFEE.COM/BC-COFFEE-ROASTERS.HTML

**BC ROASTERS
BUCKEYE, ARIZONA 85326
TONOPAH, ARIZONA 85354**