

2023 BC-5 (HD) SW & DW

BY BCROASTERS.COM

THE 2023 BC LINE CONTINUES TO BUILD WITH YEARLY ADVANCEMENTS TO EACH SIZE ROASTER. FOR 2023 WE ARE EXCITED TO ADD 3 NEW FEATURES TO THE BC-5: (1) NEW BEARING AND DRUM ALIGNMENT SYSTEM (2) NEW QUICK LOAD REMOVAL FEATURE WITH THE DRUM SHAFT HANDLE (3) ADVANCE BLUETOOTH CONNECTIVITY TO A COMPUTER WITH A NEW DATA LOGGER COMPUTER CHIP. THESE FEATURES COMBINED WITH ALL THE FEATURES ADDED DURING THE PAST 9 YEARS ALLOWS THE ROASTMAST TO PERFECT ROASTS WITH GREATER EASE AS WELL AS MAKES MAINTENANCE FASTER AND EASIER.

HERE ARE MORE DETAILS ABOUT THE BC-5:

THE BC-5 IS OUR BEST SELLING BC MODEL FOR MANY REASONS. YOU CHOOSE BETWEEN SINGLE OR DOUBLE WALL OPTIONS TO BEST FIT YOUR WAY OF ROASTING. THE BIGGEST ADVANTAGE OF THE DW MODELS IS ITS ABILITY TO DO SMALLER BATCHES FOR SAMPLES. IT CAN ROAST FROM 8OZ. TO 5LB. PER ROAST ON THE DOUBLE WALL UNIT (16OZ.-5LB. ON SW) AND UP TO 5 ROASTS PER HOUR ON THE GAS MODELS. IT HAS ALL THE FEATURES MOST COMPANIES CHARGE EXTRA FOR BUILT INTO THE BASE PRICE. PRECISE AIRFLOW CONTROL VIA THE MDDS (MANUAL DAMPER) SYSTEM COMBINED WITH THE MAG AIRFLOW GAUGE. SOLID HEAVY-DUTY STAINLESS STEEL DRUM AND BUILT IN PROFILING SYSTEM VIA ARTISAN OR CROPSTER FOR BT & ET. DIRECT-CONNECT CHAFF UNIT FOR GREATER EFFICIENCY & REDUCED FOOTPRINT. COMES IN CHOICE OF GAS OR ALL ELECTRIC. NOW IN BLACK, RED & WHITE BODY COLORS! NOW IS THE TIME TO "GET YOUR ROAST ON!"



FEATURES

- SINGLE & DOUBLE WALL OPTIONS
- COMPUTER PROFILING VIA USB OR BT
- TWO 3mm THICK K TYPE THERMOCOUPLES
- COMPLETE DETAILS ON CONTROL PANEL
- 1 YEAR PARTS AND INSTRUCTION WARRANTY
- MINIMUM 10 YEAR IN STOCK PART SUPPLY
- FREE 110 VOLTAGE CONVERTER FOR USA

BC-5 AIR	GAS TYPE	ELECTRIC
Batch Size	8oz-5lb.	1-4.5lb
Roasting Time	9-14 minutes	15 minutes
Production	20-25lb.hr	15-18lb.hr
Heat Source	NG/LPG	ELECTRIC
Voltage	220V	220V
Wattage	310W	5310W
Drum Motor	90W	60W
Chaff Fan Motor	60W	60W
Cooling Fan Motor	90W	90W
MIXING ARM	15W	15W
BTU	45,000	NA
NG PRESSURE	7WC	NA
LPG PRESSURE	16-20WC	NA
Gas Consumption	0.4kg/hr	NA
Roaster Dim.	42x27x39"	42x27x39"
Roaster Weight	353lb	353lb
Crate Dimensions	48x33x41" (LxWxH)	48x33x41" (LxWxH)
Package weight	430lb	430lb.

**BC ROASTERS NOW COME IN 3 BODY COLORS:
BLACK, RED & WHITE**



**BLACK BODY WITH BLACK
CHECKERED HOUSING**



**RED BODY WITH GOLD
CHECKERED HOUSING**



**WHITE BODY WITH
ROSE GOLD HOUSING**

SOLID COLORS



ROSE GOLD



STAINLESS



BLACK TITANIUM

TEXTURED HOUSINGS

CHECKERED



**CHECKERED
BLACK**

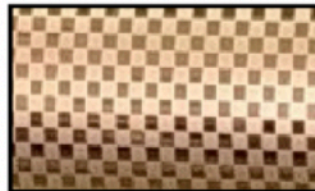

**CHECKERED
GOLD**

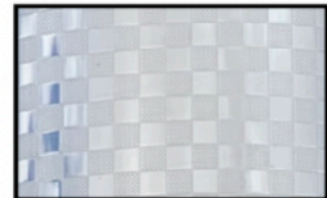

**CHECKERED
SILVER**

**NEW FOR
2021 & 2022**

**SILVER
RAINDROP**



GOLD RAINDROP



**NEW FOR 2022:
HAMMERED GOLD**



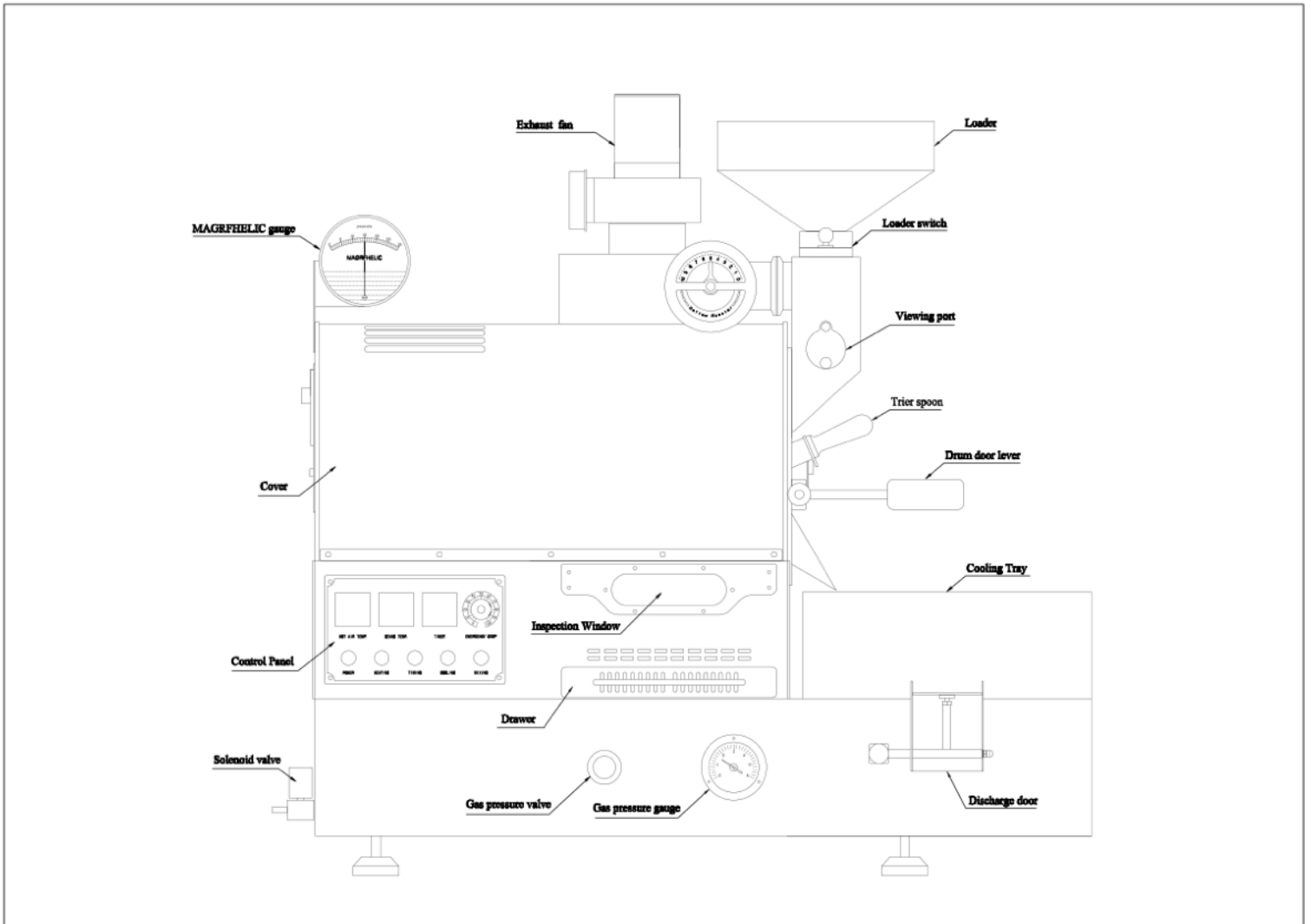
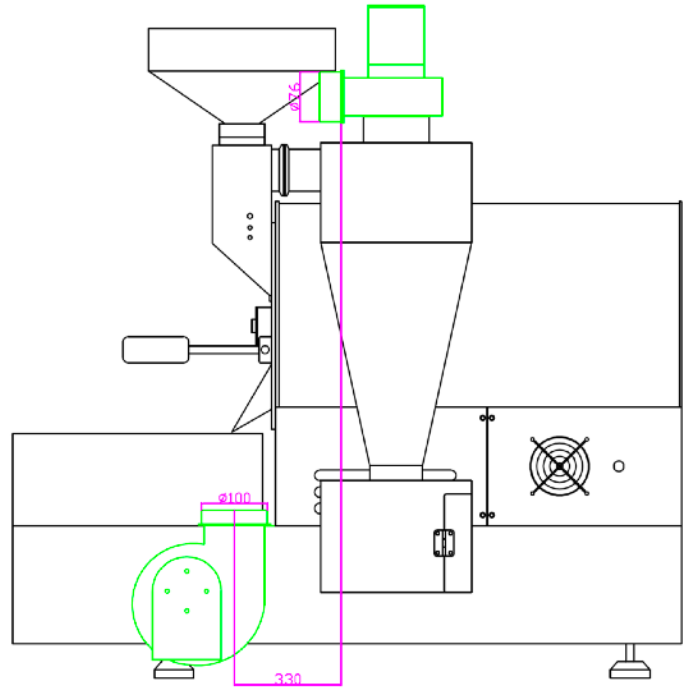
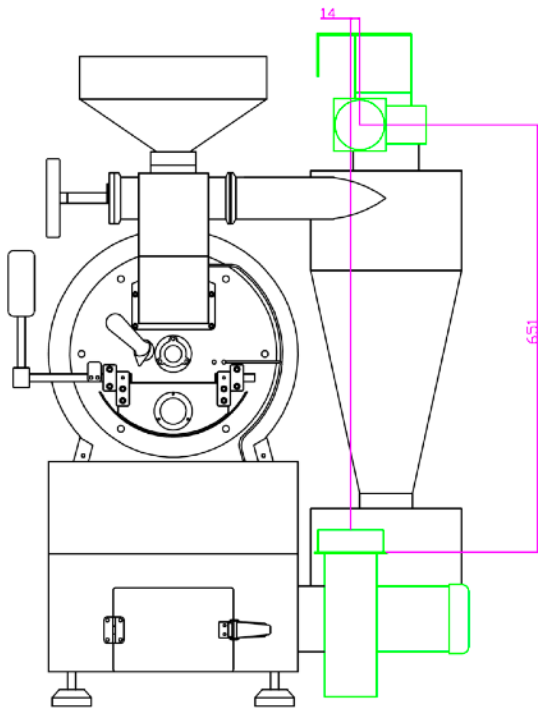

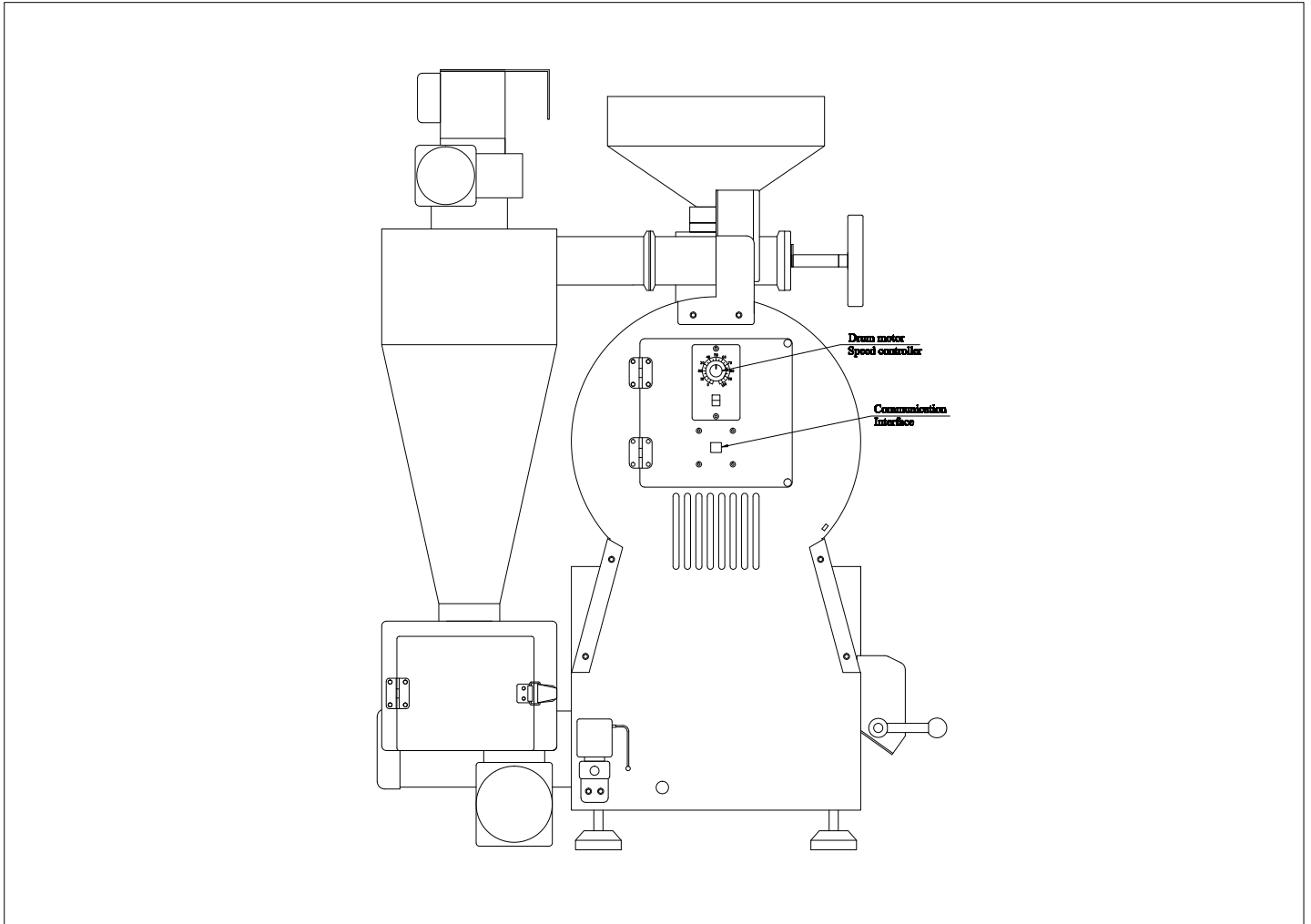

IMPORTANT NOTE ON EXHAUST SETUP OF THE NEW HD LINE OF ROASTERS:
WITH THE NEW 2022 HD LINE OF ROASTERS INTRODUCED IN 2021 COMES A NEW HEAVY DUTY CHAFF FAN. THIS FAN HAS AN EXHAUST PIPE OF 100MM. THEREFORE IT REQUIRES A 4" PIPE TO ATTACH TO THE CHAFF EXHAUST (THE COOLING FAN EXHAUST HAS A 3" OUTLET)

COMPUTER DATA LOGGING VIA ARTISAN SOFTWARE

RECORD ROASTS VIA USB OR BLUETOOTH TO DUPLICATE PROFILES USING ARTISAN SOFTWARE.

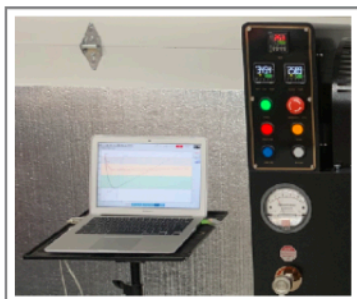

ARTISAN SOFTWARE

Do your part to Keep Artisan Alive and Well.

Donate to Artisan Here:

<https://artisan-scope.org/donate/>

DO YOUR PART!

CONSIDER ARTISAN PLUS

<https://shop.artisan.plus>



artisan+

BUCKEYE COFFEE IS A PROUD MONTHLY SPONSOR OF ARTISAN SOFTWARE

BC-5 COMMERCIAL COFFEE ROASTER

*TABLETOP OR STAND MODEL (18-24" STAND SUGGESTED)
 *DIRECT CONNECT CHAFF UNIT FOR SMALLER FOOTPRINT
 *CHOICE OF ALL ELECTRIC OR GAS MODELS

SIZE SETUP (LxWxH)	42x27x39" (INCLUDES DIRECT CONNECT CHAFF UNIT IN MEASUREMENT)
WEIGHT	353LB
MINIMUM CLEARANCE FROM COMBUSTABLE MATERIALS	18-24"
ROASTING CAPACITY	1-5LB SINGLE WALL 8OZ TO 5LB DOUBLE WALL
ROAST TIME & ROASTS PER HOUR	9-14 MINUTES (5 ROASTS PER HOUR GAS. 3.5 PER HOUR ELECTRIC)
DRUM INFORMATION	SW DRUM: 4MM SUPERIOR 304SS CONTAINS 18% CHROMIUM AND 8% NICKEL DW DRUM: HAS TWO LAYERS OF 2MM 304SS WITH 4MM OF AIR CUSHION. SS WELDING
ELECTRIC STATS:	GAS MODEL: SINGLE PHASE 220V 50/60HZ 295W REQUIRES STANDARD 15A BREAKER ALL ELECTRIC MODELS: SINGLE PHASE 220V 50/60HZ 5295W REQUIRES 30A DEDICATED BREAKER
ELECTRICAL PLUG TYPE	GAS MODELS: 20A 250V 3 WIRE NEMA 6-20P ELECTRIC TYPE: LOCKING PLUG 250V 30A NEMA L6-30P
FUEL CHOICES ON GAS MODELS	LPG GAS STANDARD WITH MODELS. NATURAL GAS CONVERSION KITS OFFERED FOR CUSTOMER INSTALLATION ONLY.
BURNER INFORMATION ON GAS MODELS	SW BURNERS: 8 STANDARD HD BURNERS DW BURNERS: 10 STANDARD HD BURNERS
BTU REQUIRMENTS	40,000 BTU MINIMUM REQUIRED FOR NG LINE
GAS PRESSURE	LPG: 12-16WC (3-4KPA) MARSHALL 1912/197 REGULATOR RECOMMENDED NG: 7-14WC

[FOR MORE INFORMATION SEE: BCROASTERS.COM](http://www.buckeyecoffee.com/bc-coffee-roasters.html)

[HTTP://WWW.BUCKEYECOFFEE.COM/BC-COFFEE-ROASTERS.HTML](http://www.buckeyecoffee.com/bc-coffee-roasters.html)

BC ROASTERS
BUCKEYE, ARIZONA 85326
TONOPAH, ARIZONA 85354
TOLL FREE: 844.522.6333
INFO@BUCKEYECOFFEE.COM
[INFO@BCROASTERS.COM](http://www.bucroasters.com)

EXHAUST SETUP	
EXHAUST PIPE REQUIREMENTS	POSITIVE PRESSURE EXHAUST VENTING WITH MINIMUM CLEARANCE 18-24" FROM COMBUSTABLE MATERIALS
MAXIMUM VENTING LENGTHS	20-25' FROM CHAFF UNIT. DEDUCT 3-5' FOR 45-90 DEGREE PIPE ELBOWS. IF YOU MUST VENT AT LONGER LENGTHS CONSULT A LOCAL TECHNICIAN ON USE OF POSSIBLE BOOSTER FANS
MAXIMUM EXHAUST TEMPERATURES	425-475F
CHAFF UNIT HIGH TEMP.	300-350F
COOLING TRAY HIGH TEMP.	200F
DATA LOGGING VIA ARTISAN OR CROPSTER	BUILT IN DATA LOGGER ATTACHES TO COMPUTER (PC OR MAC) VIA USB OR BLUETOOTH
K TYPE THERMOCOUPLES	BT & ET WITH TWO ADDITIONAL PREDRILLED CAPPED THREADED HOLES TO ADD OR ADJUST LOCATION OF PROBES
MANUFACTURED IN CHINA FOR BC ROASTERS	CUSTOM BUILT FOR BC SPECS IN USA AND OVER 200 LANDS

NEW 2023 FEATURES ON THE BC-5's

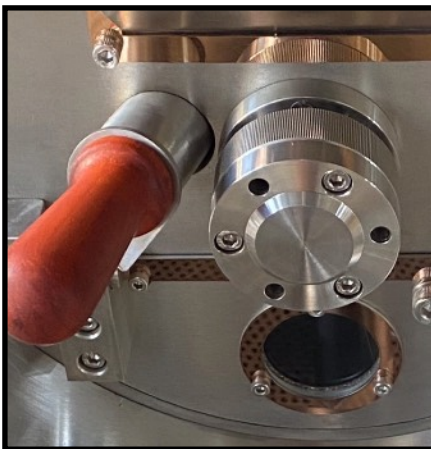

**NEW
BLUETOOTH
DIRECT
CONNECT DATA
LOGGER CHIP!**