

**FORTINET**<sup>®</sup>

# Fortinet Product Quick Guide

# Fortinet Security Fabric

## **BROAD**

visibility of the entire digital attack surface to better manage risk

## **INTEGRATED**

solution that reduces the complexity of supporting multiple point products

## **AUTOMATED**

workflows to increase speed of operations and response

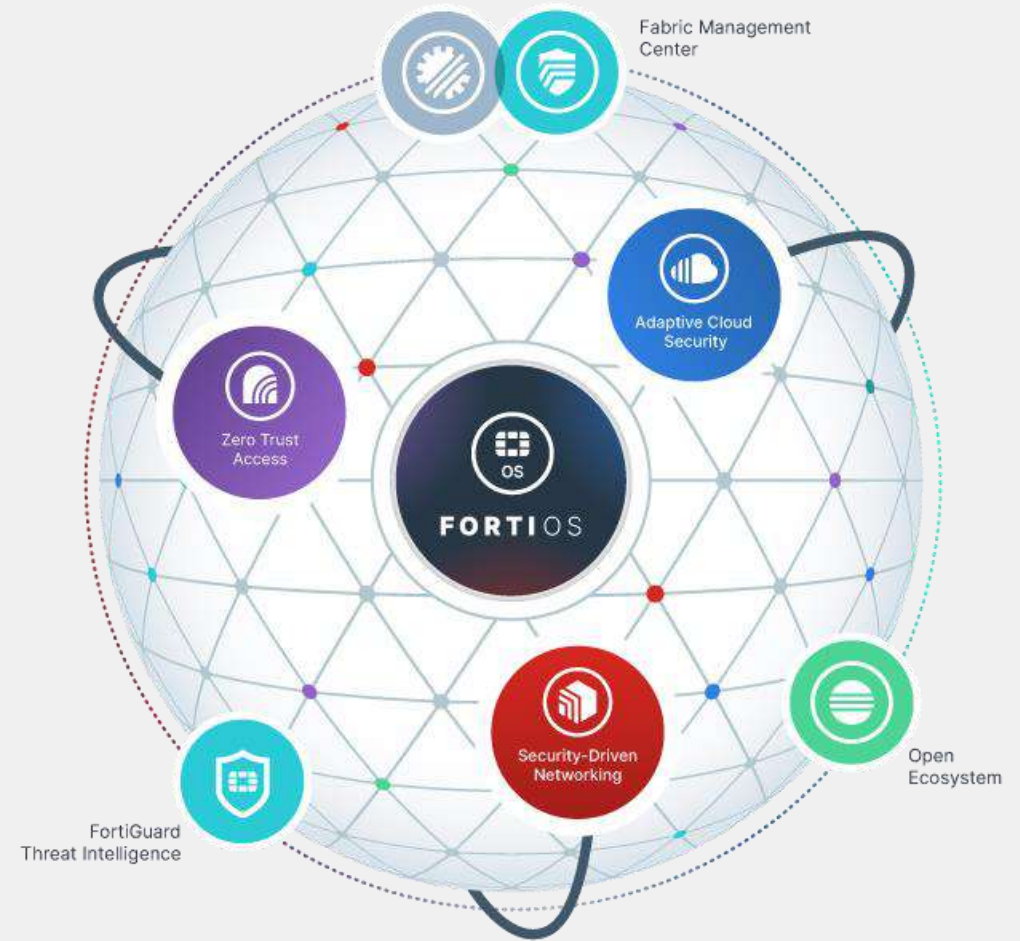

**FortiGate Cloud**

- FortiGate Mgmt., Log Analysis and Retention
- Bulk Provisioning
- IoC Service

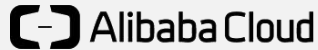

**FortiSandbox Cloud**

**FortiMail Cloud**

**FortiWeb Cloud**

**FortiSwitch Cloud**

**FortiToken Cloud**

**FortiVoice Cloud**

**FortiPresence**

**FortiCASB**

**FortiCWP**



**MOBILE USERS**

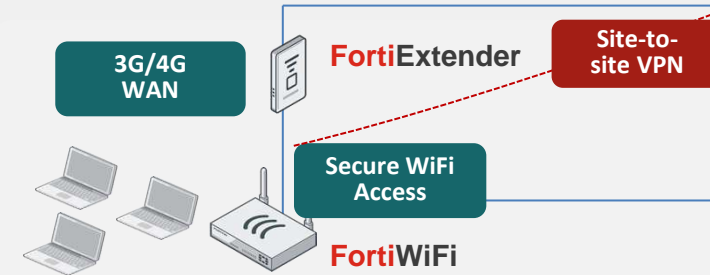

**REMOTE OFFICE**

**SECURITY/NETWORK OPERATING CENTER**

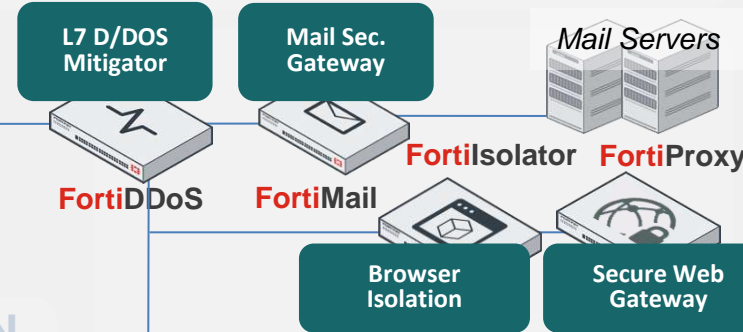
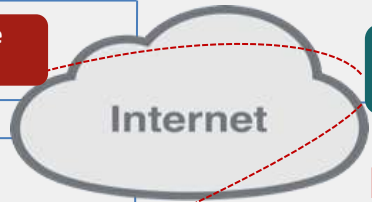
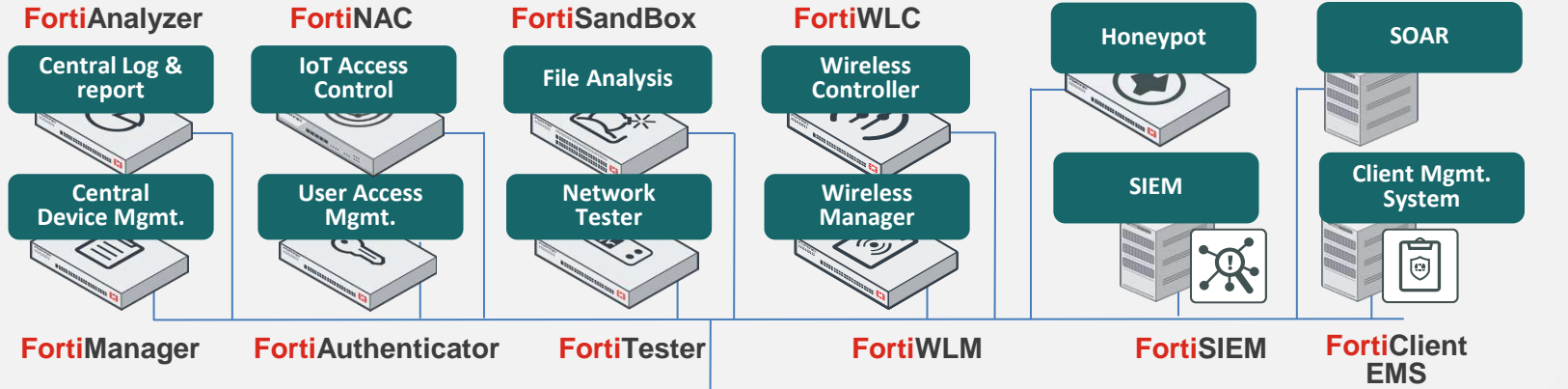

**LAN**

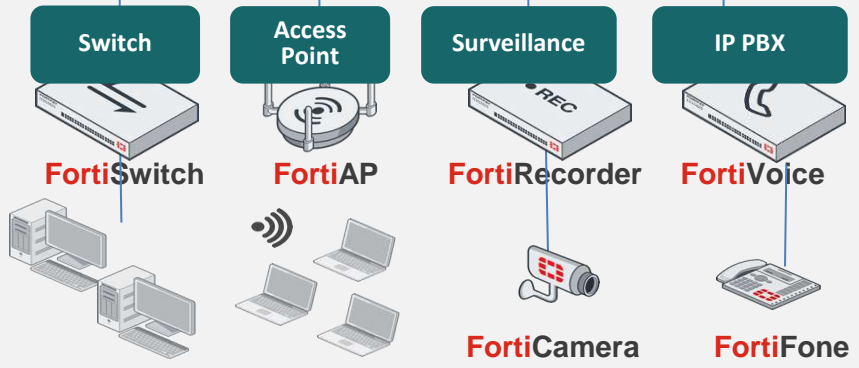

**DATA CENTER**

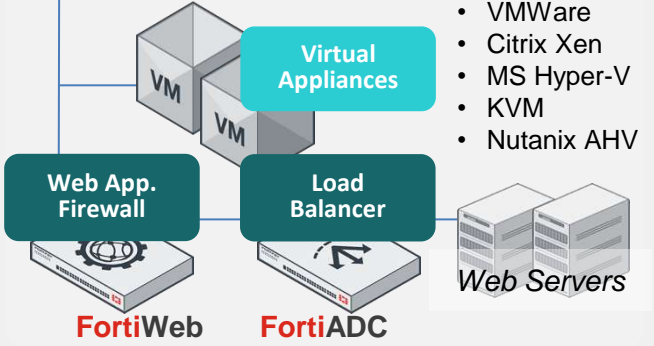

# Content

- [FortiGate/FortiWiFi](#)
- [FortiAnalyzer](#)
- [FortiManager](#)
- [FortiSIEM](#)
- [FortiAuthenticator](#)
- [FortiAP](#)
- [FortiSwitch](#)
- [FortiNAC](#)
- [FortiSandbox](#)
- [FortiClient](#)
- [FortiMail](#)
- [FortiWeb](#)
- [FortiADC](#)
- [FortiCASB](#)
- [FortiDDoS](#)
- [FortiDeceptor](#)
- [FortiEDR](#)
- [FortiIsolator](#)
- [FortiProxy](#)
- [FortiRecorder & FortiCamera](#)
- FortiSOAR (coming soon)
- [FortiTester](#)
- [FortiToken](#)
- [FortiVoice & FortiFone](#)
- [FortiWLC](#)
- [FortiWLM](#)





# FortiGate/FortiWiFi



# Fortinet Security Processor Evolution

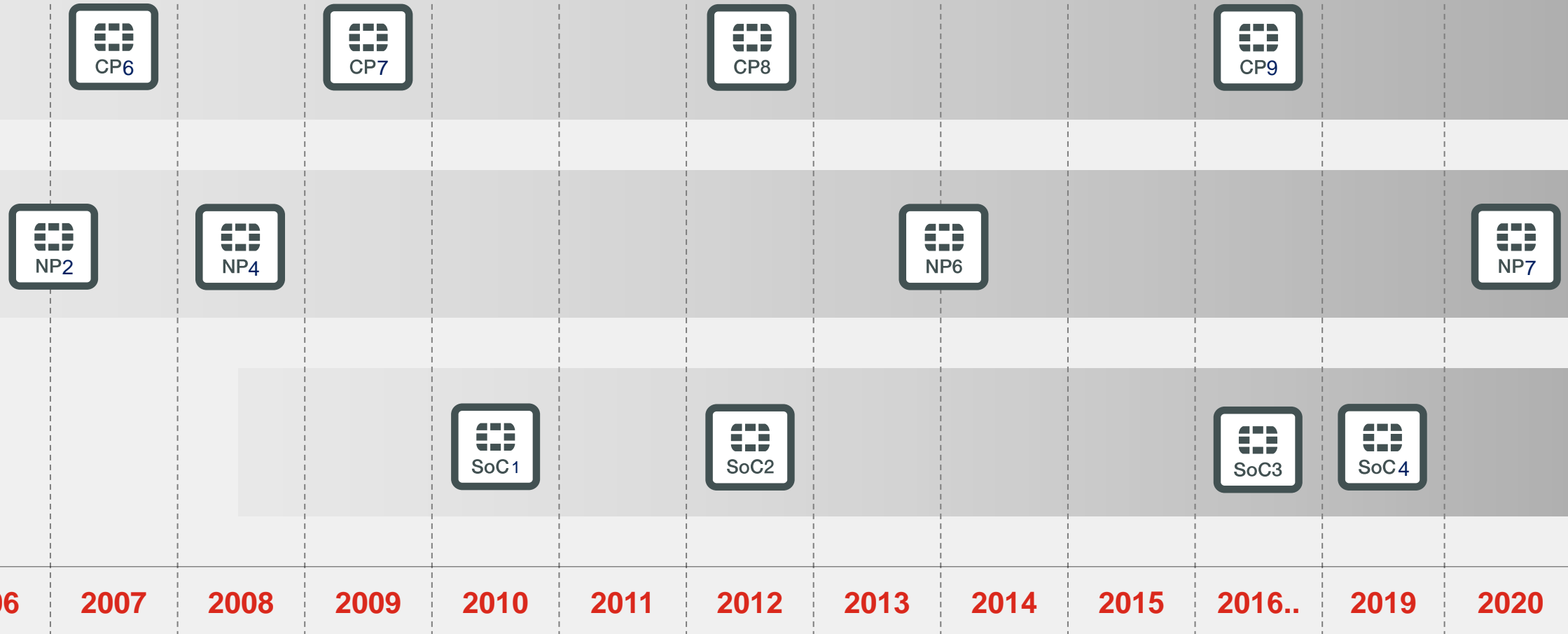

# FortiGate Product Range

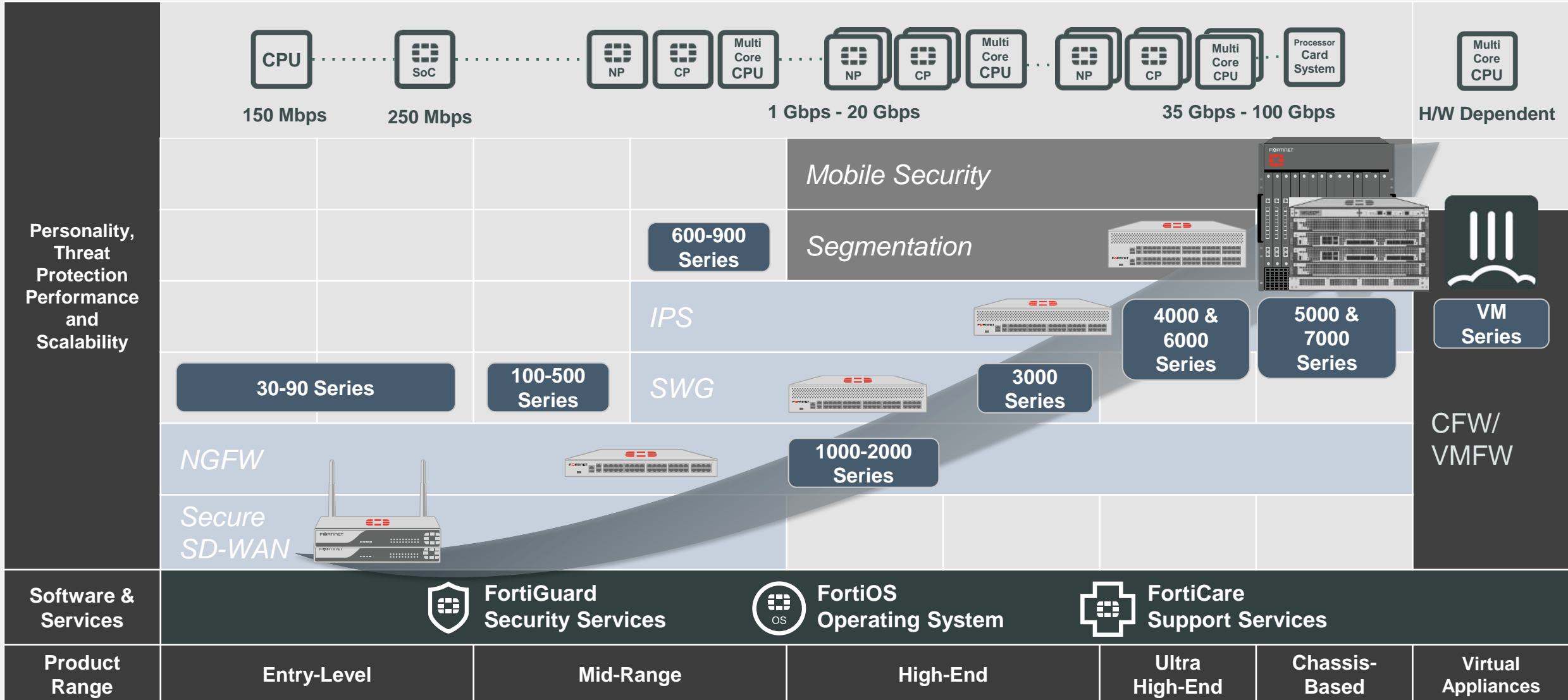

# FortiGate Entry Level Series - Overview



Feature-rich Security Appliances For Small/Home Offices & Small Branch Offices



-  **FG- 80E/80F Series**
-  **FG/FWF- 60E/60F Series**
-  **FG/FWF- 40F Series**
-  **FG/FWF- 30E/50E Series**



NGFW



Secure SD-WAN



**950 Mbps – 10 Gbps**

Firewall throughput



**200 Mbps - 1 Gbps**

NGFW Throughput



**300 Mbps – 1.4 Gbps**

IPS Throughput



**150 Mbps - 900 Mbps**

Threat Protection Throughput



**GE RJ45 | GE RJ45 PoE/+ | GE SFP**

Variants: WiFi | In-built 3G4G | In-built DSL | Ruggedized





# FortiGate Entry Level Series: Comparison

	FG-30E	FG-40F	FG-50E	FG-60E	FG-60F	FG-80E	FG-80F
<b>Firewall (1518/512/64 byte UDP)</b>	950 Mbps	5 / 5 / 5 Gbps	2.5 Gbps	3 / 3 / 3 Gbps	10 / 10 / 6 Gbps	4 / 4 / 4 Gbps	10 / 10 / 7 Gbps
<b>Concurrent Sessions</b>	900,000	700,000	1.8 Mil	1.3 Mil	700,000	1.3 Mil	1.5 Mil
<b>New Sessions/Sec</b>	15,000	35,000	21,000	30,000	35,000	30,000	45,000
<b>IPSec VPN</b>	75 Mbps	4.4 Gbps	90 Mbps	2 Gbps	6.5 Gbps	2.5 Gbps	6.5 Gbps
<b>IPS (Ent. Mix)</b>	300 Mbps	1 Gbps	350 Mbps	400 Mbps	1.4 Gbps	450 Mbps	1.4 Gbps
<b>NGFW (Ent. Mix)</b>	200 Mbps	800 Mbps	220 Mbps	250 Mbps	1 Gbps	360 Mbps	1 Gbps
<b>Threat Protection (Ent. Mix)</b>	150Mbps	600 Mbps	160 Mbps	180 Mbps	700 Mbps	250 Mbps	900 Mbps
<b>Interfaces</b>	5 x GE RJ45	5 x GE RJ45	7 x GE RJ45	10 x GE RJ45	10 x GE RJ45	14 x GE RJ45 2x Shared Media Pairs	10 x GE RJ45
<b>Storage</b>	-	-	32 GB (51E)	128 GB (61E)	128 GB (61F)	128 GB (81E)	128 GB (81F)
<b>Variants</b>	WiFi, 3G4G	WiFi, 3G4G	WiFi	WiFi, PoE	WiFi	PoE	Bypass



# FortiGate Entry Level Series: Comparison

	FWF30E	FWF40F	FWF50E	FWF60/61E	FWF60/61F
Thick AP	•	•	•	•	•
Wireless Controller	•	•	•	•	•
# of WiFi radios	1	1	1	1	1
Supported Std	a/b/g/n	a/b/g/n/ac W2	a/b/g/n	a/b/g/n/ac	a/b/g/n/ac W2
802.11n	2x2 MIMO	3x3 MIMO	2x2 MIMO	2x2 MIMO	3x3 MIMO
Max wireless association rate total	300 Mbps	1,300 Mbps	300 Mbps	867 Mbps	1,300 Mbps
SSID's (incl. reserved)	8	8	8	8	8
Max AP (Total/Tunnel)	2 / 2	16 / 8	10 / 5	30 / 10	64 / 32



# FortiGate/FortiWiFi 30E

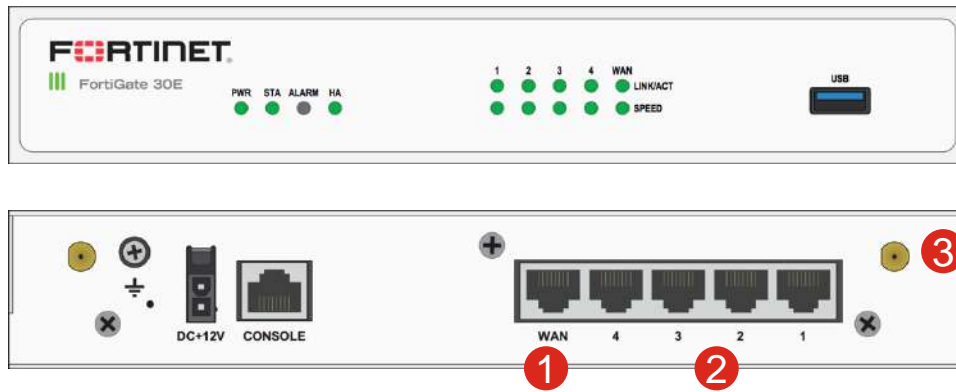

- ① 1 x GE RJ45 WAN Port
- ② 4 x GE RJ45 Ports
- ③ WiFi Variant: 802.11a/b/g/n



**950 Mbps**  
Firewall throughput



**300 Mbps**  
IPS Throughput

**15,000**  
New Sessions/Sec

**0.9 Million**  
Concurrent Sessions



**200 Mbps**  
NGFW Throughput



**125 Mbps**  
SSL Inspection Throughput



**150 Mbps**  
Threat Protection Throughput

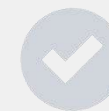

**Small Business / Remote Office**  
NGFW / Secure SD-WAN



# FortiGate 30E-3G4G

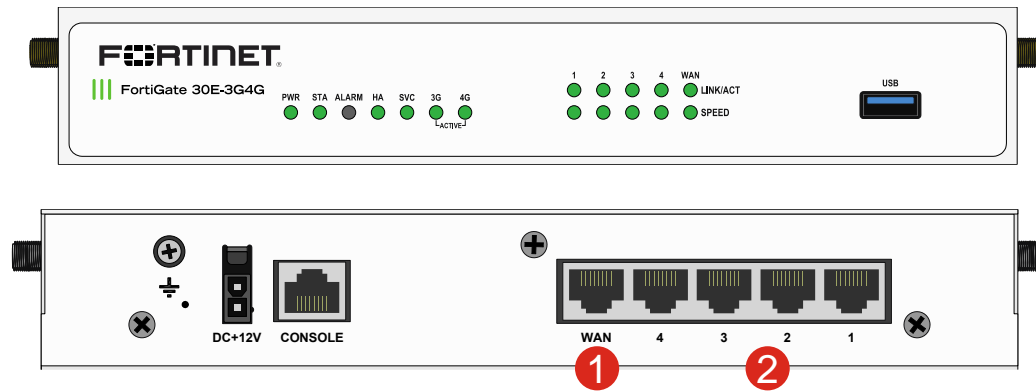

- ① 1 x GE RJ45 WAN Port
- ② 4 x GE RJ45 Ports

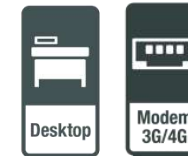

**950 Mbps**  
Firewall throughput



**300 Mbps**  
IPS Throughput

**15,000**  
New Sessions/Sec

**0.9 Million**  
Concurrent Sessions



**200 Mbps**  
NGFW Throughput



**125 Mbps**  
SSL Inspection Throughput



**150 Mbps**  
Threat Protection Throughput

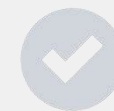

**Small Business / Remote Office**  
NGFW / Secure SD-WAN



# FortiGate/FortiWiFi 40F

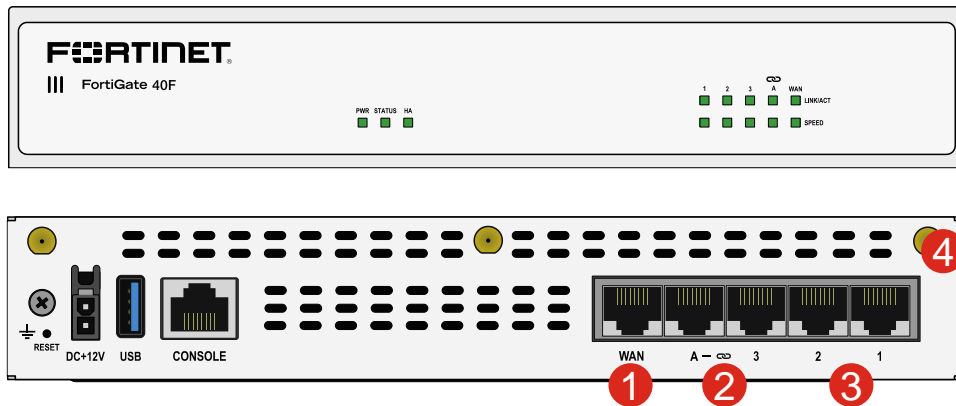

- ① 1 x GE RJ45 WAN Port
- ② 1 x GE RJ45 FortiLink Port
- ③ 3 x GE RJ45 Ports
- ④ WiFi Variant: 802.11a/b/g/n/ac W2



**5 Gbps**  
Firewall throughput



**1 Gbps**  
IPS Throughput

**35,000**  
New Sessions/Sec

**700,000**  
Concurrent Sessions



**800 Mbps**  
NGFW Throughput



**310 Mbps**  
SSL Inspection Throughput



**600 Mbps**  
Threat Protection Throughput

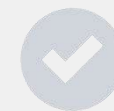

**Small Business / Remote Office**  
NGFW / Secure SD-WAN



# FortiGate/FortiWiFi 40F-3G4G

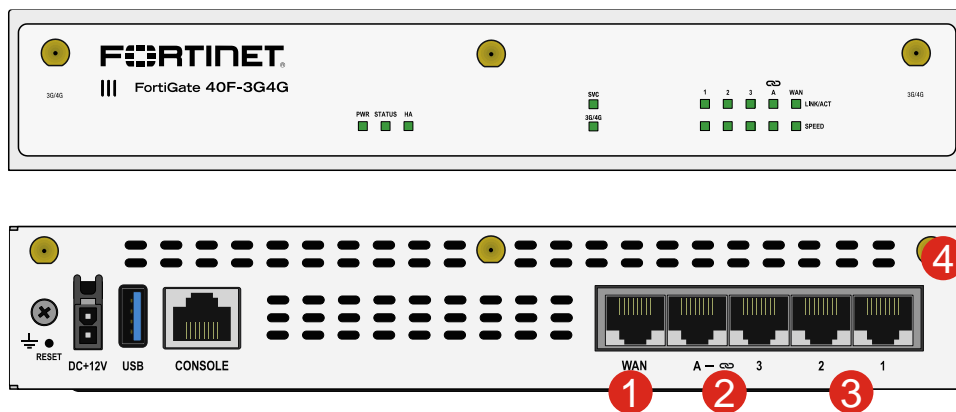

- ① 1 x GE RJ45 WAN Port
- ② 1 x GE RJ45 FortiLink Port
- ③ 3 x GE RJ45 Ports
- ④ WiFi Variant: 802.11a/b/g/n/ac W2

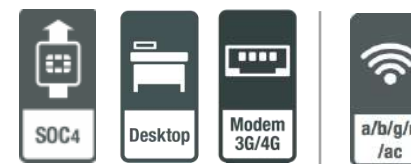

**5 Gbps**  
Firewall throughput



**1 Gbps**  
IPS Throughput

**35,000**

New Sessions/Sec

**700,000**

Concurrent Sessions



**800 Mbps**

NGFW Throughput



**310 Mbps**

SSL Inspection Throughput



**600 Mbps**

Threat Protection Throughput

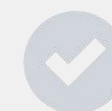

**Small Business / Remote Office**  
NGFW / Secure SD-WAN



# FortiGate/FortiWiFi 50E

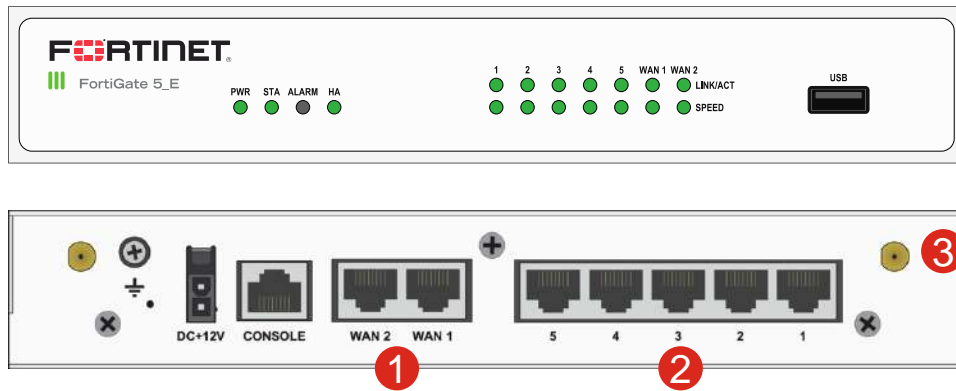

- ① 2 x GE RJ45 WAN Ports
- ② 5 x GE RJ45 Ports
- ③ WiFi Variant: 802.11a/b/g/n



**2.5 Gbps**  
Firewall throughput



**350 Mbps**  
IPS Throughput

**21,000**  
New Sessions/Sec

**1.8 Million**  
Concurrent Sessions



**220 Mbps**  
NGFW Throughput



**150 Mbps**  
SSL Inspection Throughput



**160 Mbps**  
Threat Protection Throughput

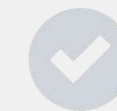

**Small Business / Remote Office**  
NGFW / Secure SD-WAN



# FortiGate/FortiWiFi 51E

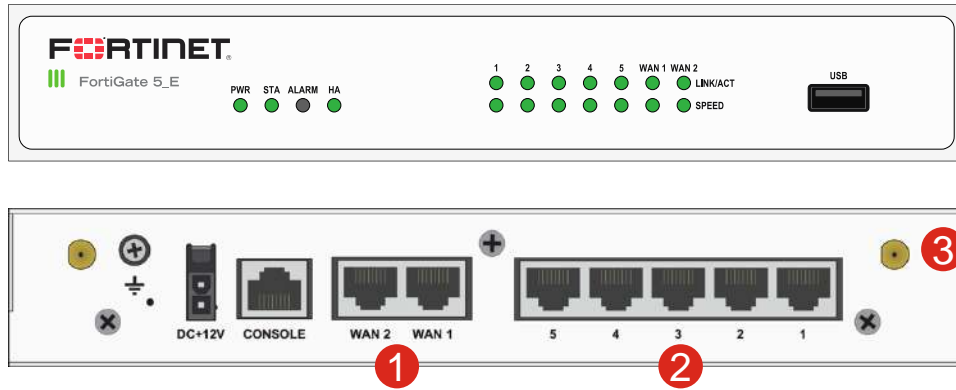

- ① 2 x GE RJ45 WAN Ports
- ② 5 x GE RJ45 Ports
- ③ WiFi Variant: 802.11a/b/g/n



**2.5 Gbps**  
Firewall throughput



**350 Mbps**  
IPS Throughput

**21,000**  
New Sessions/Sec

**1.8 Million**  
Concurrent Sessions



**220 Mbps**  
NGFW Throughput



**150 Mbps**  
SSL Inspection Throughput



**160 Mbps**  
Threat Protection Throughput

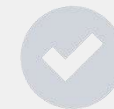

**Small Business / Remote Office**  
NGFW / Secure SD-WAN





# FortiGate/FortiWiFi 60E

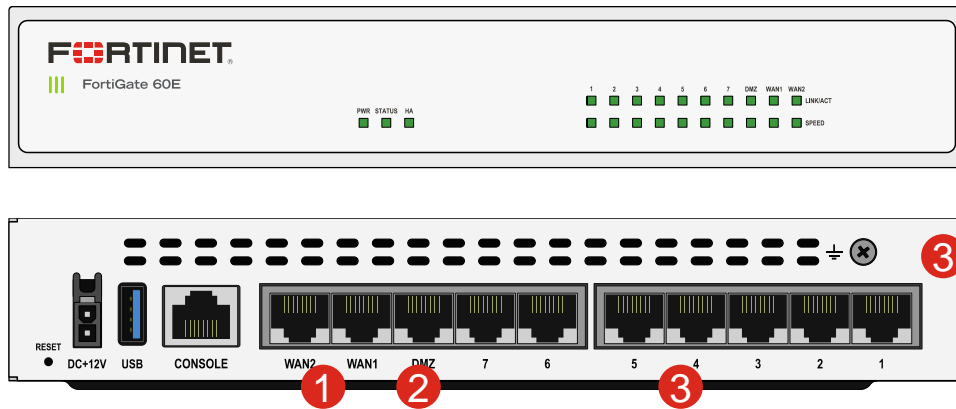

- ① 2 x GE RJ45 WAN Ports
- ② 1 x GE RJ45 DMZ Port
- ③ 7 x GE RJ45 Ports
- ④ WiFi Variant: 802.11a/b/g/n/ac



**3 Gbps**  
Firewall throughput



**400 Mbps**  
IPS Throughput

**30,000**

New Sessions/Sec

**1.3 Million**

Concurrent Sessions



**250 Mbps**

NGFW Throughput



**135 Mbps**

SSL Inspection Throughput



**200 Mbps**

Threat Protection Throughput



**Small Business / Remote Office**  
NGFW / Secure SD-WAN



# FortiGate/FortiWiFi 61E

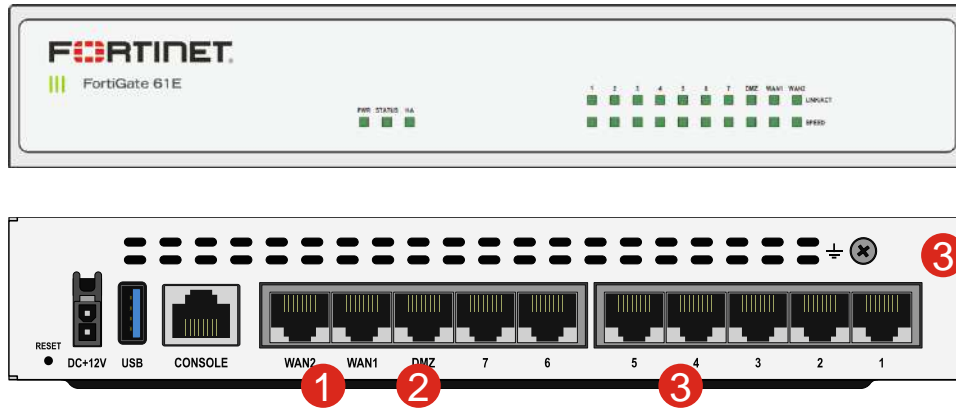

- ① 2 x GE RJ45 WAN Ports
- ② 1 x GE RJ45 DMZ Port
- ③ 7 x GE RJ45 Ports
- ④ WiFi Variant: 802.11a/b/g/n/ac



**3 Gbps**  
Firewall throughput



**400 Mbps**  
IPS Throughput

**30,000**  
New Sessions/Sec

**1.3 Million**  
Concurrent Sessions



**250 Mbps**  
NGFW Throughput



**135 Mbps**  
SSL Inspection Throughput



**200 Mbps**  
Threat Protection Throughput

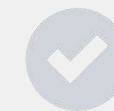

**Small Business / Remote Office**  
NGFW / Secure SD-WAN



# FortiGate 60E-POE

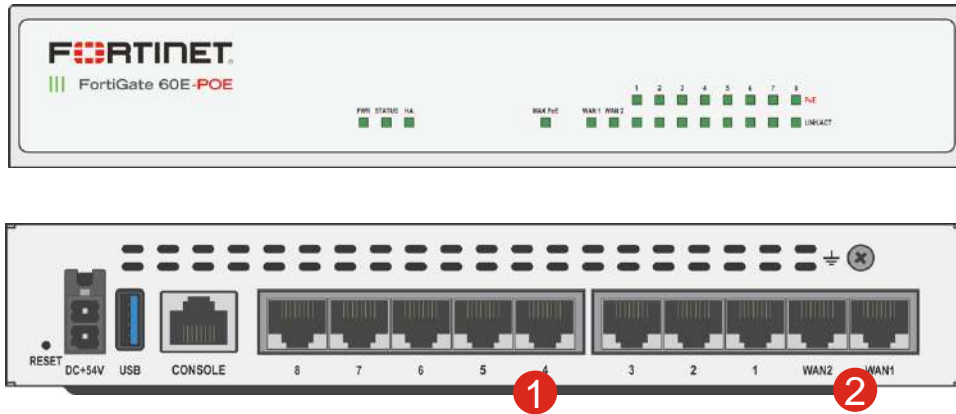

- ① 8 x GE RJ45 PoE/+ Ports
- ② 2 x GE RJ45 WAN Ports



**3 Gbps**  
Firewall throughput



**400 Mbps**  
IPS Throughput

**30,000**  
New Sessions/Sec

**1.3 Million**  
Concurrent Sessions



**250 Mbps**  
NGFW Throughput



**135 Mbps**  
SSL Inspection Throughput



**200 Mbps**  
Threat Protection Throughput

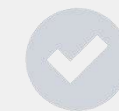

**Small Business / Remote Office**  
NGFW / Secure SD-WAN



# FortiGate/FortiWiFi 60E-DSL/J

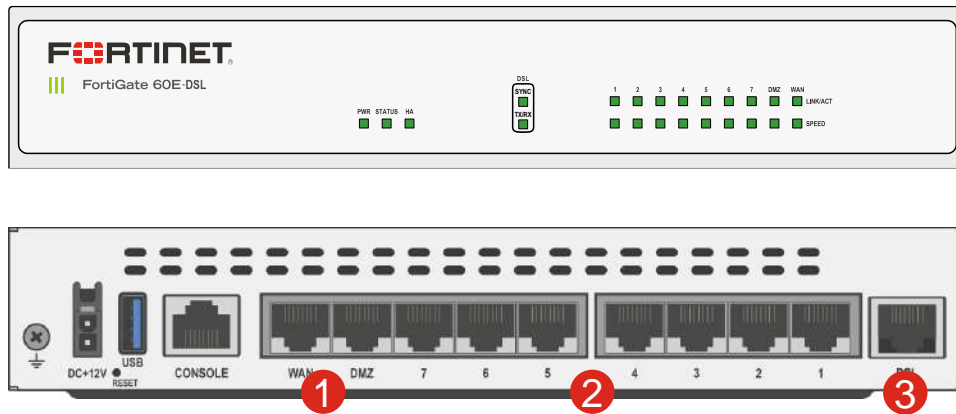

- ① 2 x GE RJ45 WAN/DMZ Ports
- ② 7 x GE RJ45 Ports
- ③ 1 x GE RJ11 DSL Ports



**3 Gbps**  
Firewall throughput



**400 Mbps**  
IPS Throughput

**30,000**  
New Sessions/Sec

**1.3 Million**  
Concurrent Sessions



**250 Mbps**  
NGFW Throughput



**135 Mbps**  
SSL Inspection Throughput



**200 Mbps**  
Threat Protection Throughput



**Small Business / Remote Office**  
NGFW / Secure SD-WAN



# FortiGate/FortiWiFi 60/61F

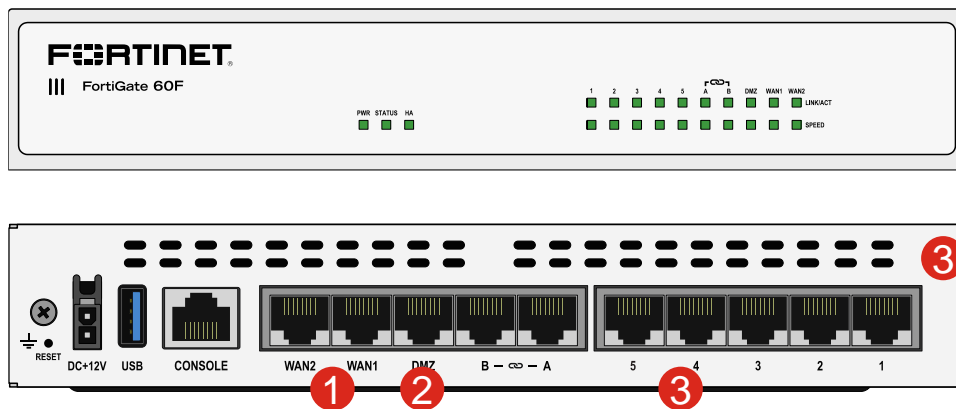

- ① 2 x GE RJ45 WAN Ports
- ② 1 x GE RJ45 DMZ Port
- ③ 7 x GE RJ45 Ports



**10 Gbps**  
Firewall throughput



**1.4 Gbps**  
IPS Throughput

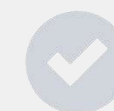

**Small Business / Remote Office**  
NGFW / Secure SD-WAN

**35,000**

New Sessions/Sec

**700,000**

Concurrent Sessions



**1. Gbps**

NGFW Throughput



**630 Mbps**

SSL Inspection Throughput



**700 Mbps**

Threat Protection Throughput



# FortiGate 80E/81E

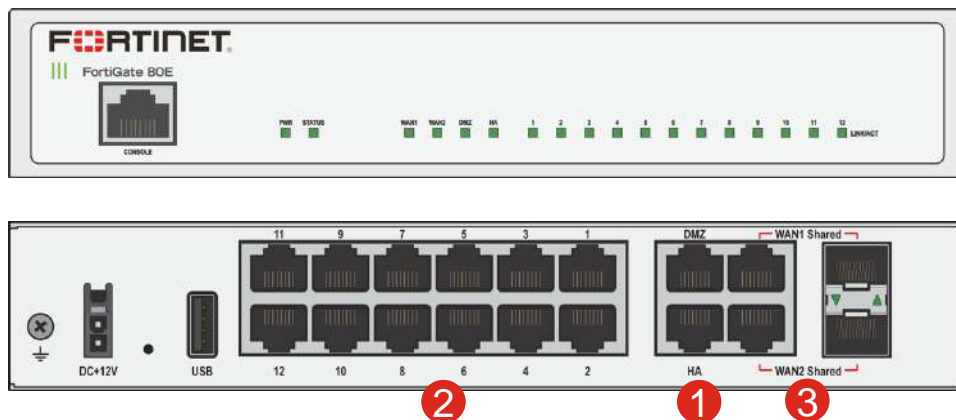

- ① 2 x GE RJ45 DMZ/HA Port
- ② 12 x GE RJ45 Ports
- ③ 2x Shared Media interface Pairs



**4 Gbps**  
Firewall throughput



**450 Mbps**  
IPS Throughput

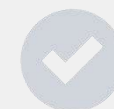

**Small Business / Remote Office**  
NGFW / Secure SD-WAN

**30,000**

New Sessions/Sec

**1.3 Million**

Concurrent Sessions



**360 Mbps**

NGFW Throughput



**135 Mbps**

SSL Inspection Throughput



**250 Mbps**

Threat Protection Throughput



# FortiGate 80E/81E-POE

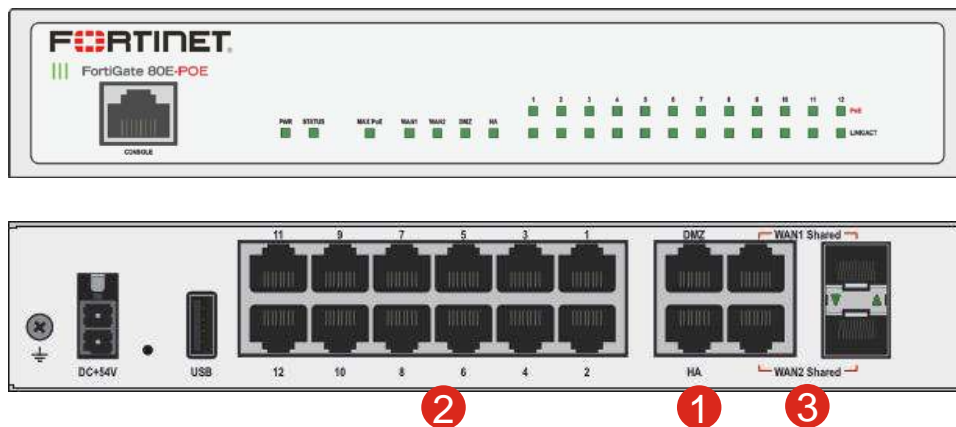

- ① 2 x GE RJ45 DMZ/HA Port
- ② 12 x GE RJ45 PoE/+ Ports
- ③ 2x Shared Media interface Pairs



**4 Gbps**  
Firewall throughput



**450 Mbps**  
IPS Throughput

**30,000**

New Sessions/Sec

**1.3 Million**

Concurrent Sessions



**360 Mbps**

NGFW Throughput



**135 Mbps**

SSL Inspection Throughput



**250 Mbps**

Threat Protection Throughput

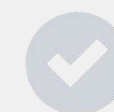

**Small Business / Remote Office**  
NGFW / Secure SD-WAN



# FortiGate 80/81F

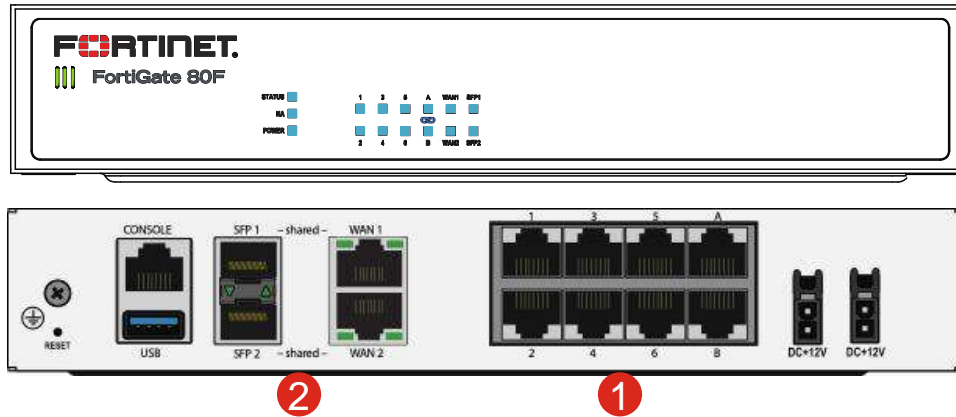

- ① 8 x GE RJ45 Ports
- ② 2x Shared Media interface Pairs



**10 Gbps**  
Firewall throughput



**1.4 Gbps**  
IPS Throughput

**45,000**  
New Sessions/Sec

**1.5 Million**  
Concurrent Sessions



**1 Gbps**  
NGFW Throughput



**715 Mbps**  
SSL Inspection Throughput



**900 Mbps**  
Threat Protection Throughput

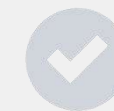

**Small Business / Remote Office**  
NGFW / Secure SD-WAN





# FortiGate 80F-Bypass

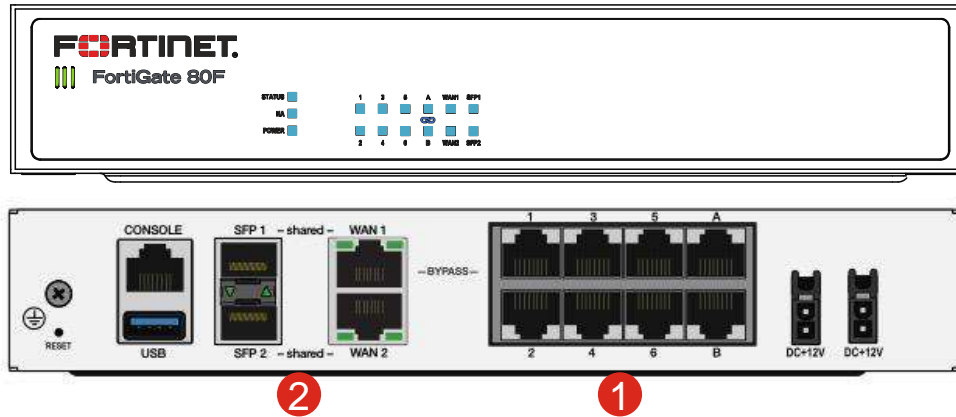

- ① 8 x GE RJ45 Ports
- ② 2x Shared Media interface Pairs

\* WAN1 and Port1 are default configured as 1x bypass GE RJ45 port pair



**10 Gbps**  
Firewall throughput



**1.4 Gbps**  
IPS Throughput



**Small Business / Remote Office**  
NGFW / Secure SD-WAN

**45,000**

New Sessions/Sec

**1.5 Million**

Concurrent Sessions



**1 Gbps**

NGFW Throughput



**715 Mbps**

SSL Inspection Throughput



**900 Mbps**

Threat Protection Throughput



# FortiGate Rugged Series: Comparison

	FGR-30D	FG-35D	FGR-60D	FGR-60F	FGR-90D
<b>Firewall (1518 UDP)</b>	900 Mbps	550 Mbps	1.5 Gbps	6 Gbps	2 Gbps
<b>Concurrent Sessions</b>	750,000	750,000	500,000	600,000	2.5 Million
<b>New Sessions/Sec</b>	5,000	5,000	4,000	19,000	20,000
<b>IPSec VPN</b>	45 Mbps	45 Mbps	1 Gbps	3.5 Gbps	84 Mbps
<b>IPS (Ent. Mix)</b>	230 Mbps	230 Mbps	95 Mbps	950 Mbps	350 Mbps
<b>NGFW (Ent. Mix)</b>	45 Mbps	65 Mbps	40 Mbps	550 Mbps	370 Mbps
<b>Threat Protection (Ent. Mix)</b>	16 Mbps	16 Mbps	23 Mbps	500 Mbps	280 Mbps
<b>Interfaces</b>	4x GE RJ45 ports, 2x GE SFP slots	3x GE RJ45 Switch ports	4 x GE RJ45 Switch ports, 2 x Shared Media pairs	4 x GE RJ45 Switch ports, 2 x Shared Media pairs (can be configured with 1 RJ45 Bypass pair)	3x GE RJ45 ports, 1x GE RJ45 bypass pair, 2x SFP slots
<b>Storage</b>	-	-	-	-	-
<b>Others</b>	-	IP67	-	-	-



# FortiGate Rugged-30D

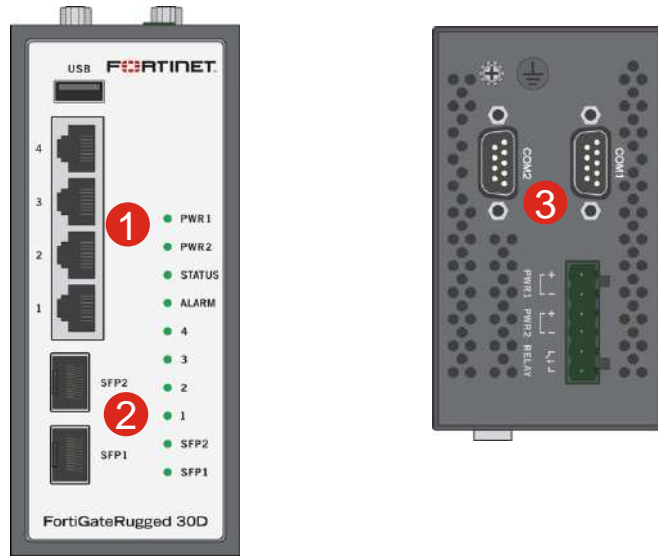

- ① 4x GE RJ45 Ports
- ② 2x GE SFP Slots
- ③ 2x DB9 Serial Port



**900 Mbps**

Firewall throughput

**750,000**

Concurrent Sessions

**5,000**

New Sessions/Sec



**180 Mbps**

IPS Throughput



**45 Mbps**

NGFW Throughput



**16 Mbps**

Threat Protection Throughput

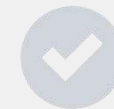

**Small Business / Remote Office**

NGFW / Secure SD-WAN



# FortiGate Rugged-35D

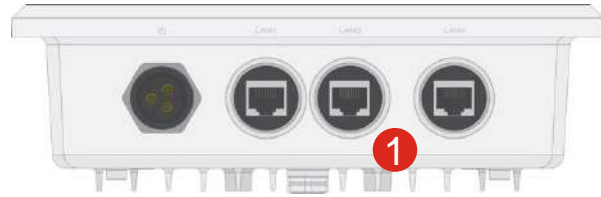

① 3x GE RJ45 Ports



**550 Mbps**

Firewall throughput

**750,000**

Concurrent Sessions

**5,000**

New Sessions/Sec



**210 Mbps**

IPS Throughput



**65 Mbps**

NGFW Throughput



**16 Mbps**

Threat Protection Throughput

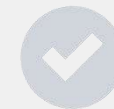

**Small Business / Remote Office**

NGFW / Secure SD-WAN



# FortiGate Rugged-60D

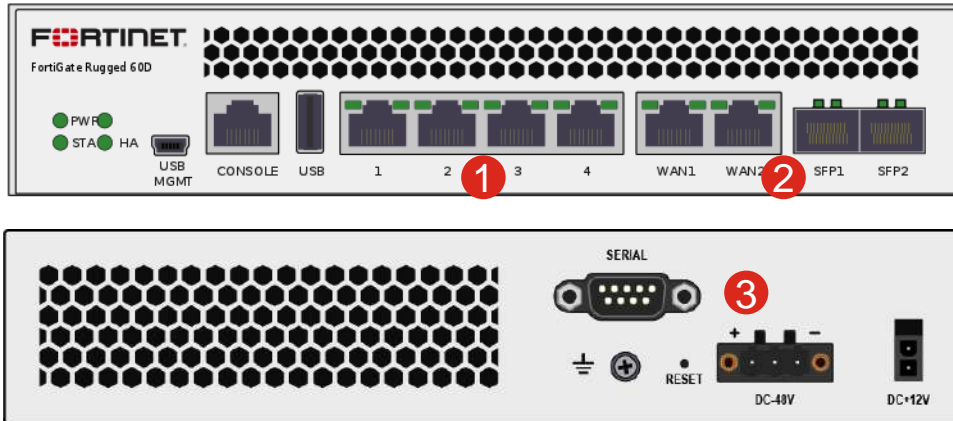

- ① 4x GE RJ45 Ports
- ② 2x Shared Media Pairs
- ③ 1x DB9 Serial Port



**1.5 Gbps**

Firewall throughput

**500,000**

Concurrent Sessions

**4,000**

New Sessions/Sec



**95 Mbps**

IPS Throughput



**40 Mbps**

NGFW Throughput



**23 Mbps**

Threat Protection Throughput



**Small Business / Remote Office**

NGFW / Secure SD-WAN



# FortiGate Rugged-60F

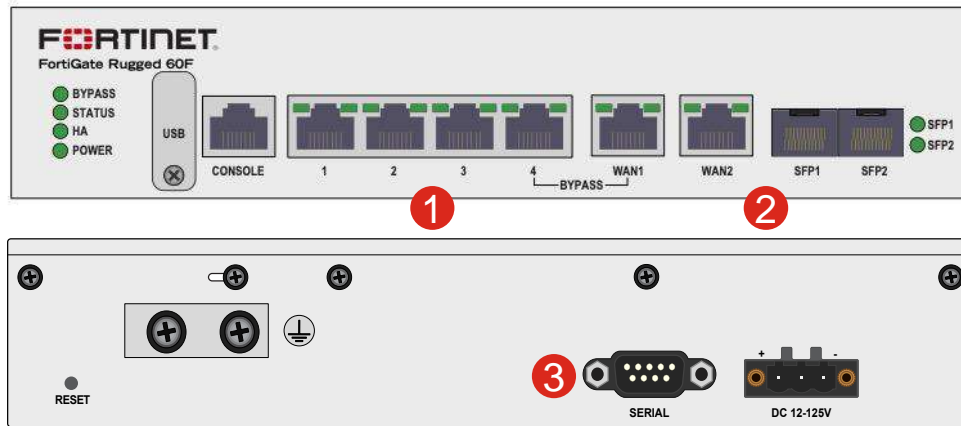

- ① 4x GE RJ45 Ports
- ② 2x Shared Media Pairs
- ③ 1x DB9 Serial Port

\* WAN1 and Port4 are default configured as 1x bypass GE RJ45 port pair



**6 Gbps**  
Firewall throughput



**950 Mbps**  
IPS Throughput

**19,000**  
New Sessions/Sec

**600,000**  
Concurrent Sessions



**550 Mbps**  
NGFW Throughput



**460 Mbps**  
SSL Inspection Throughput



**500 Mbps**  
Threat Protection Throughput

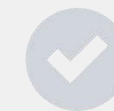

**Small Business / Remote Office**  
NGFW / Secure SD-WAN



# FortiGate Rugged-60F-3G4G

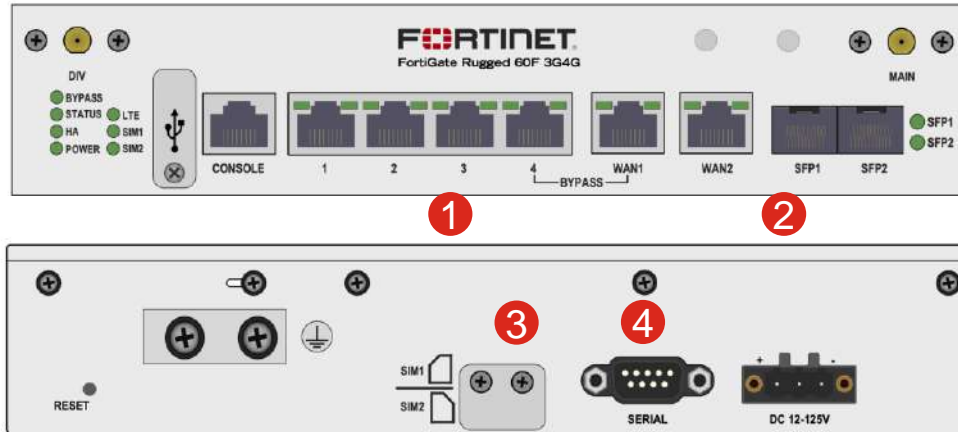

- ① 4x GE RJ45 Ports
- ② 2x Shared Media Pairs
- ③ 2x SIM Slots
- ④ 1x DB9 Serial Port

\* WAN1 and Port4 are default configured as 1x bypass GE RJ45 port pair



**6 Gbps**  
Firewall throughput



**950 Mbps**  
IPS Throughput

**19,000**  
New Sessions/Sec

**600,000**  
Concurrent Sessions



**550 Mbps**  
NGFW Throughput



**460 Mbps**  
SSL Inspection Throughput



**500 Mbps**  
Threat Protection Throughput



**Small Business / Remote Office**  
NGFW / Secure SD-WAN



# FortiGate Rugged-90D

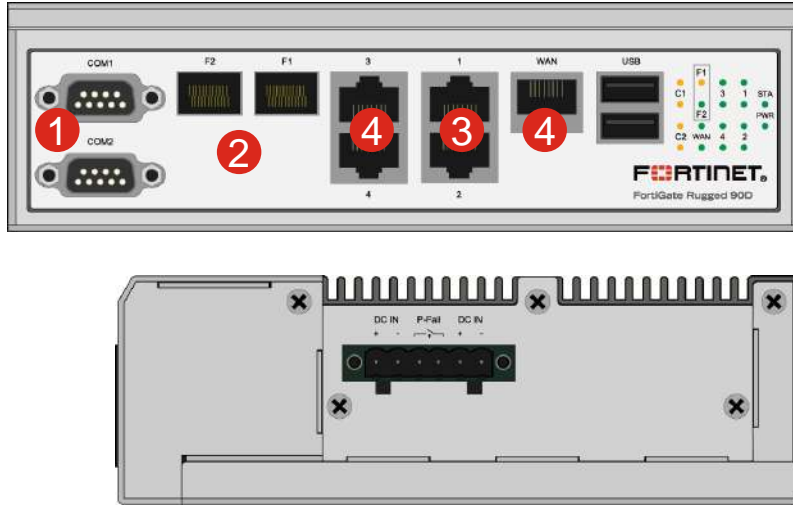

- ① 2x DB9 Serial Interface/Console
- ② 2x GE SFP Slots
- ③ 1x GE RJ45 Bypass Pair
- ④ 3x GE RJ45 ports



**2 Gbps**

Firewall throughput

**2.5 Million**

Concurrent Sessions

**20,000**

New Sessions/Sec



**350 Mbps**

IPS Throughput



**370 Mbps**

NGFW Throughput



**280 Mbps**

Threat Protection Throughput



**Small Business / Remote Office**

NGFW / Secure SD-WAN





# FortiGate Mid-Range Series - Overview



High Performance, Top Rated Network Security for Mid-Sized Enterprises



 **FG-900D**

 **FG-400E**

 **FG-800D**

 **FG-300E**

 **FG-600E**

 **FG-200E Series**

 **FG-500E**

 **FG-100F Series**



**NGFW**



**Secure SD-WAN**



**SWG** (600 series+)



**IPS** (600 series+)



**7.4 Gbps – 50 Gbps**

Firewall throughput



**360 Mbps – 9.5 Gbps**

NGFW Throughput



**500 Mbps – 10 Gbps**

IPS Throughput



**250 Mbps – 7 Gbps**

Threat Protection Throughput



**GE RJ45 | GE SFP |  
10GE SFP+**



# FortiGate Mid Range Devices: Comparison

	FGT-100E Series	FGT-140E-POE	FGT-100F Series	FGT-200E Series	FGT-200F Series
<b>Firewall (1518/512/64 byte UDP)</b>	7.4 / 7.4 / 4.4 Gbps	7.4 / 7.4 / 4.4 Gbps	20 / 18 / 10 Gbps	20 / 20 / 9 Gbps	27 / 27 / 11 Gbps
<b>Concurrent Sessions</b>	2 Mil	2 Mil	1.5 Mil	2 Mil	3 Mil
<b>New Sessions/Sec</b>	30,000	30,000	56,000	135,000	280,000
<b>IPSec VPN</b>	4 Gbps	4 Gbps	11.5 Gbps	9 Gbps	13 Gbps
<b>IPS (Ent. Mix)</b>	500 Mbps	500 Mbps	2.6 Gbps	2.2 Gbps	5 Gbps
<b>NGFW (Ent. Mix)</b>	360 Mbps	360 Mbps	1.6 Gbps	1.8 Gbps	3.5 Gbps
<b>Threat Protection (Ent. Mix)</b>	250 Mbps	250 Mbps	1 Gbps	1.2 Gbps	3 Gbps
<b>Interfaces</b>	20 x GE RJ45, 2x Shared Media Pairs	18 x GE RJ45, 24 x GE RJ45 POE, 2 x GE SFP	2 x 10GE SFP+, 18 x GE RJ45, 8x GE SFP, 4x Shared Media Pairs	18x GE RJ45, 4x GE SFP	4x 10 GE SFP+, 18x GE RJ45, 8x GE SFP
<b>Storage</b>	480 GB (101E)	-	480 GB (101F)	480 GB (201E)	480 GB (201F)
<b>Variants</b>	Fiber	-	-	-	-



# FortiGate Mid Range Devices: Comparison

	FGT-300E Series	FGT-400E Series	FGT-500E Series	FGT-600E Series	FG-800D	FG-900D
<b>Firewall (1518/512/64 byte UDP)</b>	32 / 32 / 20 Gbps	32 / 32 / 24 Gbps	36 / 36 / 22 Gbps	32 / 32 / 27 Gbps	36 / 36 / 22 Gbps	52 / 52 / 33 Gbps
<b>Concurrent Sessions</b>	4 Mil	4 Mil	8 Mil	8 Mil	5 Mil	11 Mil
<b>New Sessions/Sec</b>	300,000	450,000	300,000	450,000	280,000	280,000
<b>IPSec VPN</b>	20 Gbps	20 Gbps	20 Gbps	20 Gbps	20 Gbps	25 Gbps
<b>IPS (Ent. Mix)</b>	5 Gbps	7.8 Gbps	5.2 Gbps	10 Gbps	4.2 Gbps	4.2 Gbps
<b>NGFW (Ent. Mix)</b>	3.5 Gbps	6 Gbps	5 Gbps	9.5 Gbps	4 Gbps	4 Gbps
<b>Threat Protection (Ent. Mix)</b>	3 Gbps	5 Gbps	4.7 Gbps	7 Gbps	3 Gbps	3 Gbps
<b>Interfaces</b>	18 x GE RJ45, 16 x GE SFP	18 x GE RJ45, 16 x GE SFP	2x 10 GE SFP+, 10x GE RJ45, 8x GE SFP	2x 10 GE SFP+, 10x GE RJ45, 8x GE SFP	2x 10 GE SFP+, 8x GE SFP, 4x GE RJ45 Bypass, 22x GE RJ45	2x 10GE SPF+ , 16x GE SFP, 18x GE RJ45
<b>Storage</b>	480 GB (301E)	480 GB (401E)	480 GB (501E)	480 GB (601E)	240 GB	256 GB
<b>Variants</b>	-	-	-	-	-	-



# FortiGate 100/101E

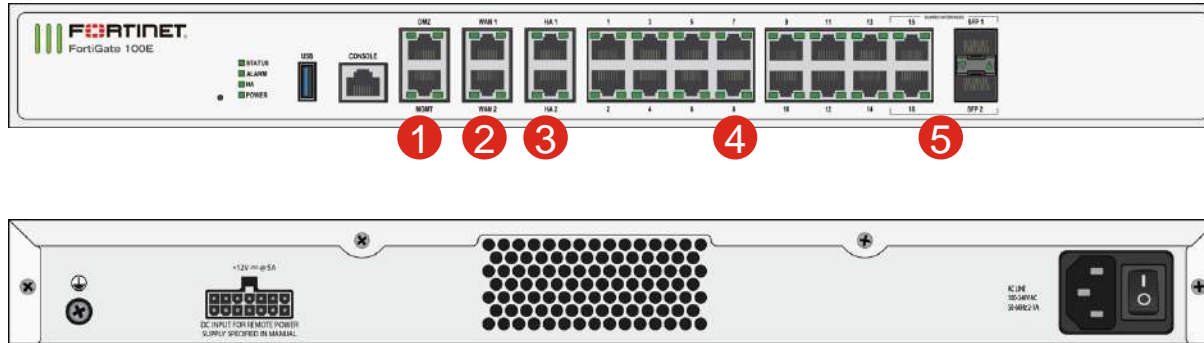

- ① 2 x GE RJ45 MGMT/DMZ Ports
- ② 2 x GE RJ45 HA Ports
- ③ 2 x GE RJ45 WAN Port
- ④ 14 x GE RJ45 Ports
- ⑤ 2 x GE RJ45/SFP Shared Media Pairs

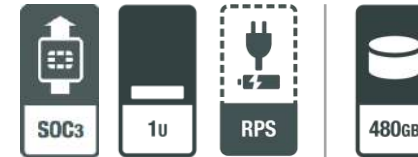

**7.4 Gbps**  
Firewall throughput



**500 Mbps**  
IPS Throughput

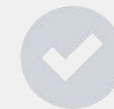

**Enterprise Branch / Mid Enterprise**  
NGFW / Secure SD-WAN

**30,000**

New Sessions/Sec

**2 Million**

Concurrent Sessions



**360 Mbps**

NGFW Throughput



**130 Mbps**

SSL Inspection Throughput



**250 Mbps**

Threat Protection Throughput



# FortiGate 100EF

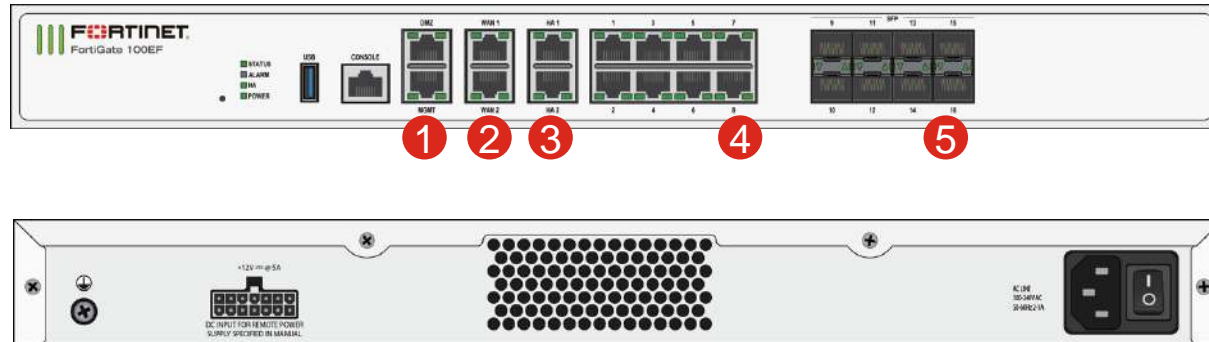

- ① 2 x GE RJ45 MGMT/DMZ Ports
- ② 2 x GE RJ45 WAN Ports
- ③ 2 x GE RJ45 HA Port
- ④ 8 x GE RJ45 Ports
- ⑤ 8 x GE SFP Slots



**7.4 Gbps**

Firewall throughput

**30,000**

New Sessions/Sec

**2 Million**

Concurrent Sessions



**130 Mbps**

SSL Inspection Throughput



**500 Mbps**

IPS Throughput



**360 Mbps**

NGFW Throughput



**250 Mbps**

Threat Protection Throughput



**Enterprise Branch / Mid Enterprise**

NGFW / Secure SD-WAN



# FortiGate 140E-POE

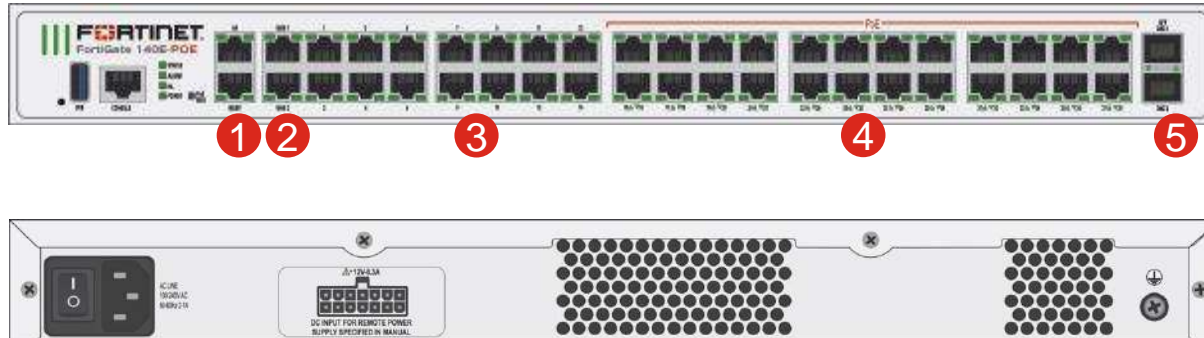

- ① 2 x GE RJ45 MGMT/HA Ports
- ② 2 x GE RJ45 WAN Ports
- ③ 14x GE RJ45 Ports
- ④ 24x GE PoE/+ Ports
- ⑤ 2 x GE SFP DMZ Slots

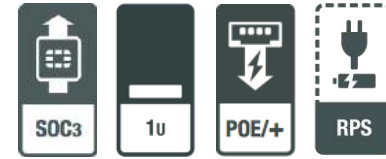

**7.4 Gbps**  
Firewall throughput



**500 Mbps**  
IPS Throughput

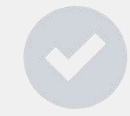

**Enterprise Branch / Mid Enterprise**  
NGFW / Secure SD-WAN

**30,000**  
New Sessions/Sec

**2 Million**  
Concurrent Sessions



**360 Mbps**  
NGFW Throughput

**5,000**

**64**

**32**



**130 Mbps**  
SSL Inspection Throughput



**250 Mbps**  
Threat Protection Throughput



# FortiGate 100/101F

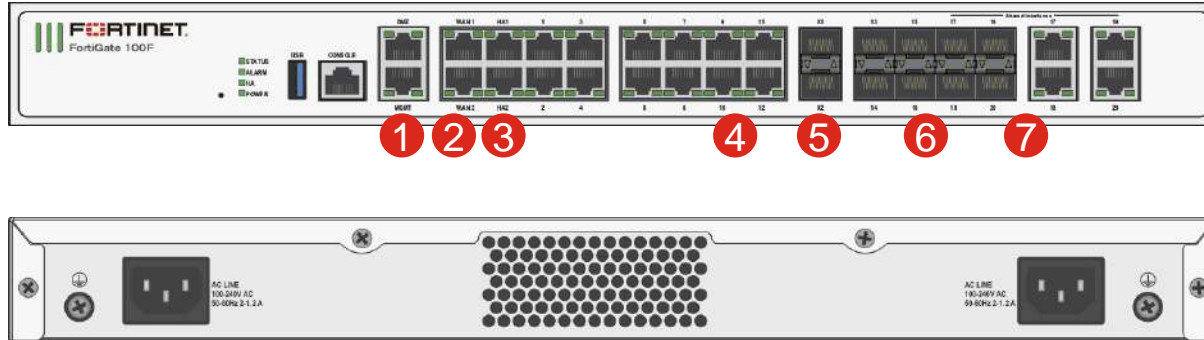

- ① 2 x GE RJ45 MGMT/DMZ Ports
- ② 2 x GE RJ45 HA Ports
- ③ 2 x GE RJ45 WAN Ports
- ④ 12 x GE RJ45 Ports
- ⑤ 2 x 10GE SFP+ FortiLink Slots
- ⑥ 8 x GE SFP Slots
- ⑦ 4 x GE RJ45/SFP Shared Media Pairs

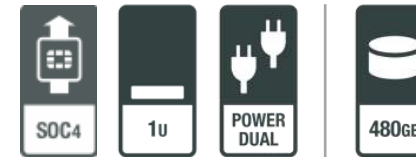

**20 Gbps**  
Firewall throughput



**2.6 Gbps**  
IPS Throughput



**Enterprise Branch / Mid Enterprise**  
NGFW / Secure SD-WAN

**56,000**  
New Sessions/Sec

**1.5 Million**  
Concurrent Sessions



**1.6 Gbps**  
NGFW Throughput



**1 Gbps**  
SSL Inspection Throughput



**1 Gbps**  
Threat Protection Throughput



# FortiGate 240D

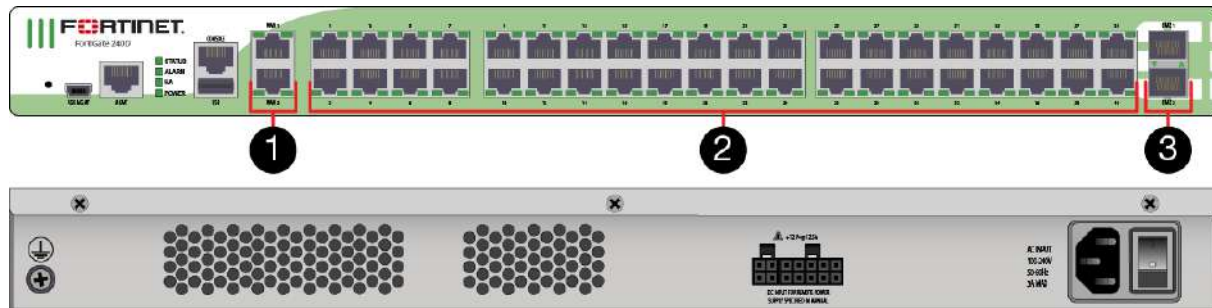

- ① 2x GE RJ45 WAN Ports
- ② 40x GE RJ45 Switch Ports
- ③ 2x GE SFP Slots



**4 Gbps**

Firewall throughput

**2 Million**

Concurrent Sessions

**77,000**

New Sessions/Sec



**420 Mbps**

IPS Throughput



**330 Mbps**

NGFW Throughput



**310 Mbps**

Threat Protection Throughput

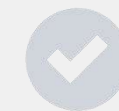

**Enterprise Branch / Mid Enterprise**

NGFW / Secure SD-WAN





# FortiGate 200/201E

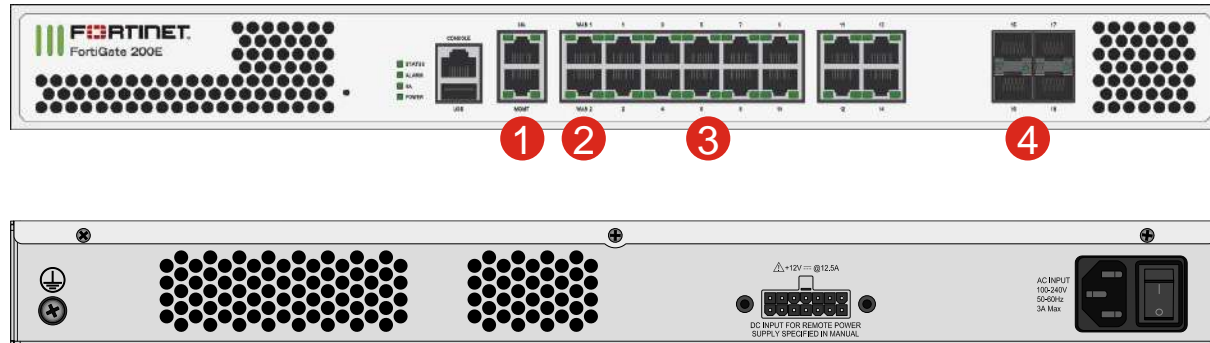

- ① 2 x GE RJ45 MGMT/HA Ports
- ② 2 x GE RJ45 WAN Ports
- ③ 14 x GE RJ45 DMZ Port
- ④ 4 x GE SFP Slots

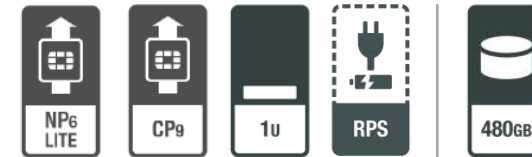

**20 Gbps**  
Firewall throughput

**135,000**  
New Sessions/Sec

**2 Million**  
Concurrent Sessions



**820 Mbps**  
SSL Inspection Throughput



**2.2 Gbps**  
IPS Throughput



**1.8 Gbps**  
NGFW Throughput



**1.2 Gbps**  
Threat Protection Throughput

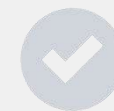

**Enterprise Branch / Mid Enterprise**  
NGFW / Secure SD-WAN



# FortiGate 200/201F

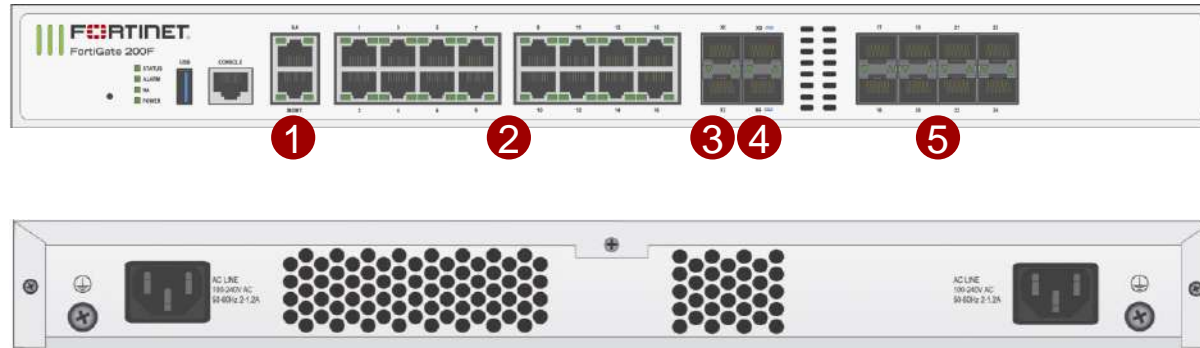

- ① 2 x GE RJ45 MGMT/HA Ports
- ② 16 x GE RJ45 Ports
- ③ 2 x 10GE SFP+ Slots
- ④ 2 x 10GE SFP+ FortiLink Slots
- ⑤ 8 x GE SFP Slots



**27 Gbps**  
Firewall throughput



**5 Gbps**  
IPS Throughput

**280,000**  
New Sessions/Sec

**3 Million**  
Concurrent Sessions



**3.5 Gbps**  
NGFW Throughput



**4 Gbps**  
SSL Inspection Throughput



**3 Gbps**  
Threat Protection Throughput

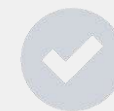

**Enterprise Branch / Mid Enterprise**  
NGFW / Secure SD-WAN



# FortiGate 300/301E

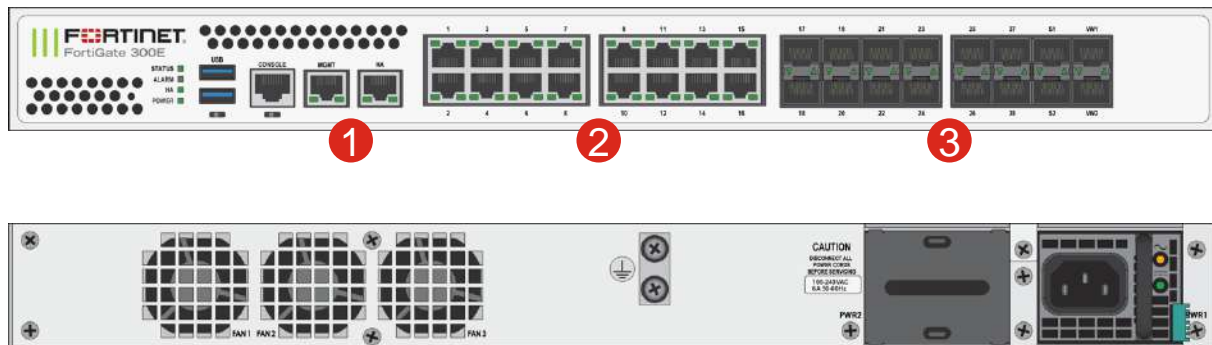

- ① 2 x GE RJ45 MGMT/HA Ports
- ② 16 x GE RJ45 Ports
- ③ 16 x GE SFP Slots



**32 Gbps**

Firewall throughput



**5 Gbps**

IPS Throughput

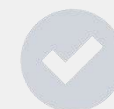

**Enterprise Branch / Mid Enterprise**

NGFW / Secure SD-WAN

**300,000**

New Sessions/Sec

**4 Million**

Concurrent Sessions



**3.5 Gbps**

NGFW Throughput



**3.9 Gbps**

SSL Inspection Throughput



**3 Gbps**

Threat Protection Throughput



# FortiGate 400E and 401E/-DC

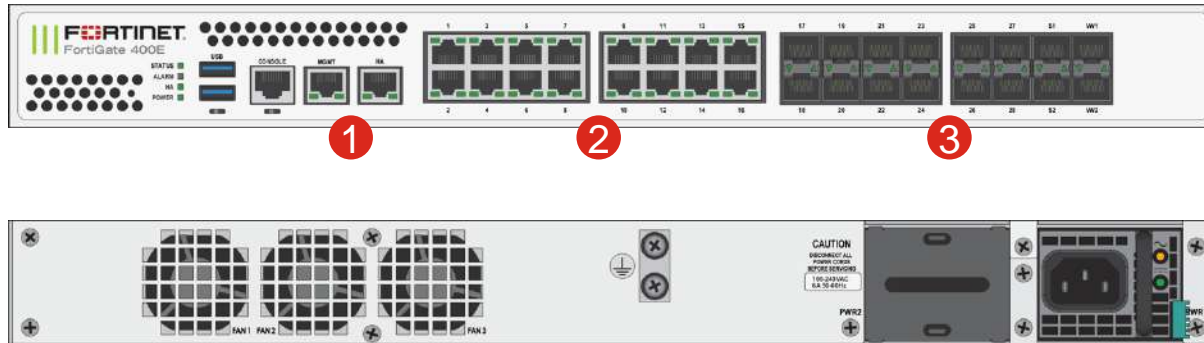

- ① 2 x GE RJ45 MGMT/HA Ports
- ② 16 x GE RJ45 Ports
- ③ 16 x GE SFP Slots

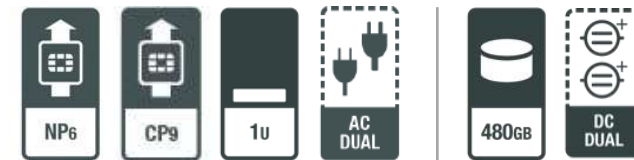

**32 Gbps**  
Firewall throughput



**7.8 Gbps**  
IPS Throughput

**450,000**  
New Sessions/Sec

**4 Million**  
Concurrent Sessions



**6 Gbps**  
NGFW Throughput



**4.8 Gbps**  
SSL Inspection Throughput



**5 Gbps**  
Threat Protection Throughput

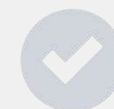

**Enterprise Branch / Mid Enterprise**  
NGFW / Secure SD-WAN



# FortiGate 500/501E

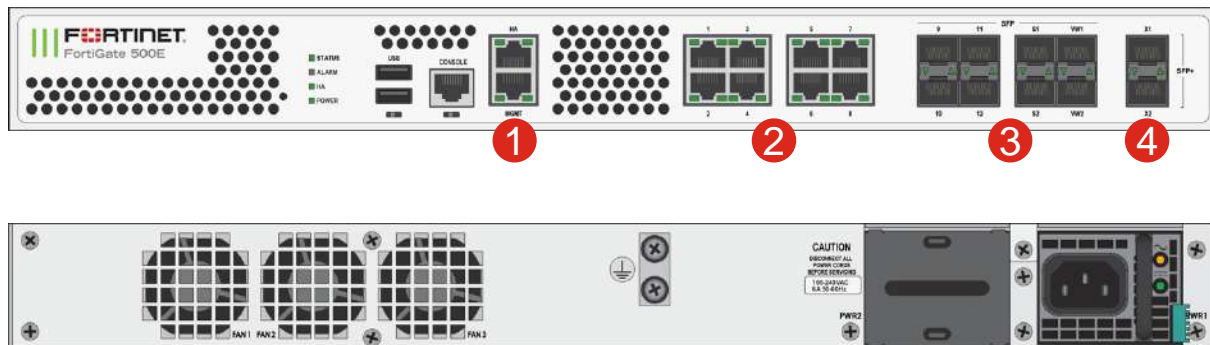

- ① 2 x GE RJ45 MGMT/HA Ports
- ② 8 x GE RJ45 Ports
- ③ 8 x GE SFP Slots
- ④ 2x 10GE SFP+ Slots

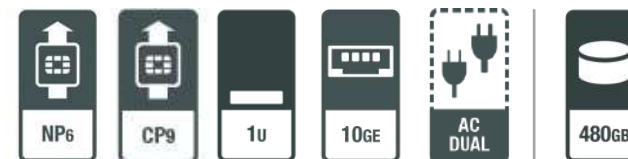

**36 Gbps**  
Firewall throughput



**5.2 Gbps**  
IPS Throughput

**300,000**  
New Sessions/Sec

**8 Million**  
Concurrent Sessions



**5 Gbps**  
NGFW Throughput



**5.7 Gbps**  
SSL Inspection Throughput



**4.7 Gbps**  
Threat Protection Throughput

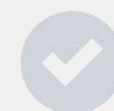

**Enterprise Branch / Mid Enterprise**  
NGFW / Secure SD-WAN



# FortiGate 600/601E

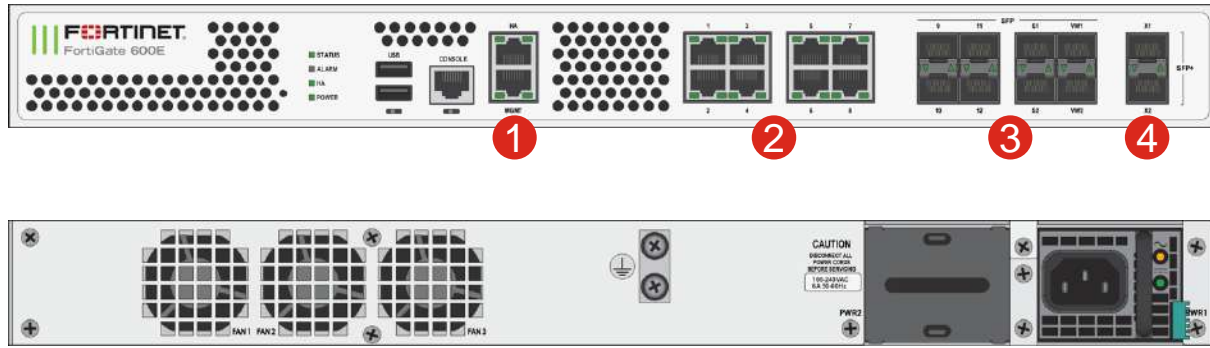

- ① 2 x GE RJ45 MGMT/HA Ports
- ② 8 x GE RJ45 Ports
- ③ 8 x GE SFP Slots
- ④ 2x 10GE SFP+ Slots

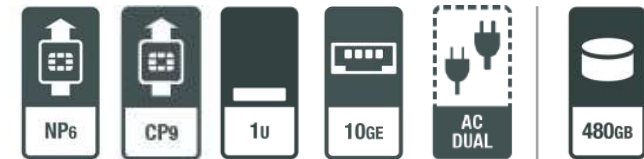

**36 Gbps**  
Firewall throughput



**10 Gbps**  
IPS Throughput

**450,000**  
New Sessions/Sec

**8 Million**  
Concurrent Sessions



**9.5 Gbps**  
NGFW Throughput



**8.0 Gbps**  
SSL Inspection Throughput



**7 Gbps**  
Threat Protection Throughput

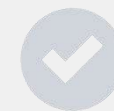

**Enterprise Branch / Mid Enterprise**  
NGFW / Secure SD-WAN / IPS / SWG





# FortiGate 800D

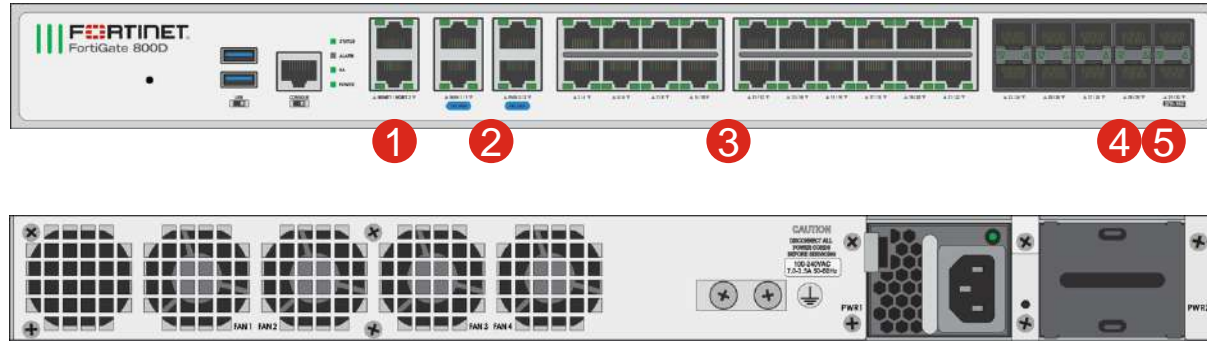

- ① 2x GE RJ45 Management Ports
- ② 2x Bypass GE RJ45 Pairs
- ③ 20x GE RJ45 Ports
- ④ 8x GE SPF Slots
- ⑤ 2x 10GE SPF+ Slots

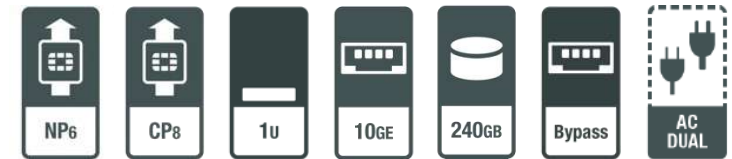

**36 Gbps**  
Firewall throughput



**4.2 Gbps**  
IPS Throughput



**Enterprise Branch / Mid Enterprise**  
NGFW / Secure SD-WAN / IPS / SWG

**280,000**  
New Sessions/Sec

**5 Million**  
Concurrent Sessions



**4 Gbps**  
NGFW Throughput



**3.9 Gbps**  
SSL Inspection Throughput



**3 Gbps**  
Threat Protection Throughput



# FortiGate 900D

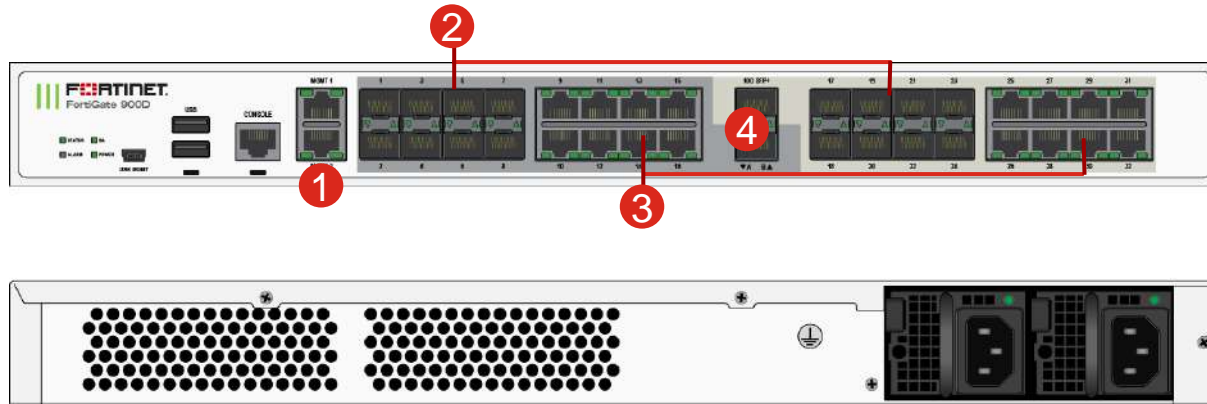

- ① 2x GE RJ45 Management Ports
- ② 16x GE SFP Slots
- ③ 16x GE RJ45 Ports
- ④ 2x 10GE SPF+ Slots

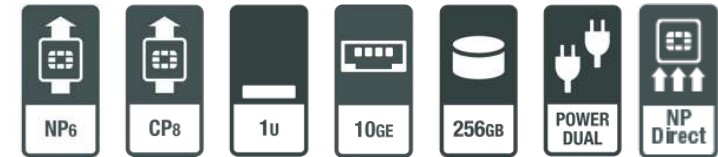

**52 Gbps**  
Firewall throughput



**4.2 Gbps**  
IPS Throughput

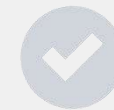

**Enterprise Branch / Mid Enterprise**  
NGFW / Secure SD-WAN / IPS / SWG

**280,000**  
New Sessions/Sec

**11 Million**  
Concurrent Sessions



**4 Gbps**  
NGFW Throughput



**3.9 Gbps**  
SSL Inspection Throughput



**3 Gbps**  
Threat Protection Throughput





# FortiGate High End Series - Overview



Data Center Firewall / Large Enterprise NGFW with High Speed Interfaces

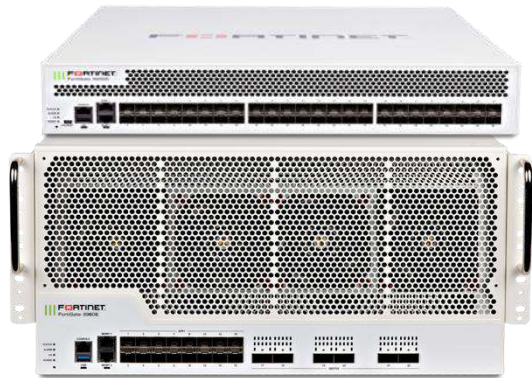

 **FG-3000D/E Series**

 **FG-2000E Series**

 **FG-1000D/E/F Series**



NGFW, IPS



Segmentation



SWG



Mobile Security



**52 Gbps – 320 Gbps**

Firewall throughput



**5 Gbps – 40 Gbps**

NGFW Throughput



**6 Gbps – 55 Gbps**

IPS Throughput



**3 Gbps – 30 Gbps**

Threat Protection Throughput



GE RJ45 | GE SFP  
10GE SFP+  
25GE SFP28  
40GE QSFP+  
100GE QSFP28



# FortiGate High End Series: Comparison

	FG-1000D	FG-1100E	FG-1200D	FG-1500D	FG-1800F	FG-2000E
<b>Firewall (1518/512/64 byte UDP)</b>	52 / 52 / 33 Gbps	80 / 80 / 45 Gbps	72 / 72 / 55 Gbps	80 / 80 / 55 Gbps	198 / 197 / 140Gbps	90 / 90 / 60 Gbps
<b>Concurrent Sessions</b>	11 Mil	8 Mil	11 Mil	12 Mil	12 Mil	20 Mil
<b>New Sessions/Sec</b>	280,000	500,000	290,000	300,000	750,000	500,000
<b>IPSec VPN</b>	25 Gbps	48 Gbps	48 Gbps	50 Gbps	55 Gbps	65 Gbps
<b>IPS (Ent. Mix)</b>	6 Gbps	12.5 Gbps	6.8 Gbps	13 Gbps	13 Gbps	11.5 Gbps
<b>NGFW (Ent. Mix)</b>	5 Gbps	9.8 Gbps	6 Gbps	7 Gbps	11 Gbps	9 Gbps
<b>Threat Protection (Ent. Mix)</b>	3 Gbps	7.1 Gbps	4 Gbps	5 Gbps	9.1 Gbps	5.4 Gbps
<b>Interfaces</b>	2x 10GE SPF+ , 16x GE SFP, 18x GE RJ45,	2x 40GE QSFP+, 4x 25 GE SFP28, 4x 10 GE SFP+, 8x GE SFP, 18x GE RJ45	4x 10GE SPF/+, 16x GE SFP, 18x GE RJ45	8x 10GE SPF/+, 16x GE SFP, 18x GE RJ45	4x 40GE QSFP+, 12x 25 GE SFP28, 2x 10GE SFP+, 8x GE SFP, 18x GE RJ45	6x 10GE SPF+, 34x GE RJ45
<b>Storage</b>	256 GB	2x 480 GB (1101E)	240 GB	480 GB		480 GB
<b>Variants</b>	-	-	-	10 GE RJ45	DC	-



# FortiGate High End Series II: Comparison

	FG-2200E	FG-2500E	FG-2600F	FG-3000D/3100D	FG-3200D	FG-3300E
<b>Firewall (1518/512/64 byte UDP)</b>	158 / 155 / 100 Gbps	150 / 150 / 95 Gbps	198 / 196 / 120 Gbps	80 / 80 / 50 Gbps	80 / 80 / 50 Gbps	160 / 158 / 100 Gbps
<b>Concurrent Sessions</b>	24 Mil	20 Mil	24 Mil	50 Mil	50 Mil	50 Million
<b>New Sessions/Sec</b>	500,000	500,000	1 Mil	400,000	400,000	700,000
<b>IPSec VPN</b>	98 Gbps	65 Gbps	55 Gbps	50 Gbps	50 Gbps	98 Gbps
<b>IPS (Ent. Mix)</b>	16.5 Gbps	11.5 Gbps	24 Gbps	22 Gbps	26 Gbps	27 Gbps
<b>NGFW (Ent. Mix)</b>	13.5 Gbps	9 Gbps	19 Gbps	18 Gbps	24 Gbps	23 Gbps
<b>Threat Protection (Ent. Mix)</b>	11 Gbps	5.4 Gbps	17 Gbps	13 Gbps	15 Gbps	17 Gbps
<b>Interfaces</b>	4x 40GE QSFP+, 20x 25 GE SFP28, 14x GE RJ45	2x 10GE Bypass SFP+, 10x 10GE SPF+, 34x GE RJ45	4x 100GE QSFP28, 16x 25GE SFP28, 16x 10GE RJ45, 2x 10GE SFP+, 2x GE RJ45	16/32x 10GE SFP+, 2x GE RJ45	48x 10GE SFP+, 2x GE RJ45	4x 40GE QSFP+, 16x 25 GE SFP28, 4x 10GE RJ45, 14x GE RJ45
<b>Storage</b>	2x 1TB (2201E)	480 GB	2x 1TB (2601F)	480 GB	960 GB	2x 1TB (3301E)
<b>Variants</b>	-	-	-	-	-	-



# FortiGate High End Series III: Comparison

	FG-3400E	FG-3600E	FG-3960E	FG-3980E	FG-4200F	FG-4400F
<b>Firewall (1518/512/64 byte UDP)</b>	240 / 238 / 150 Gbps	240 / 240 / 150 Gbps	620 / 610 / 370 Gbps	1.05 Tbps / 1.05 Tbps / 680 Gbps	800 / 788 / 400 Gbps	1,1500 / 1,140 / 500 Gbps
<b>Concurrent Sessions</b>	50 Mil	50 Mil	160 Million	160 Million	210 Million 450 Million*	210 Million 700 Million*
<b>New Sessions/Sec</b>	850,000	950,000	720,000	800,000	1 Million 7 Million*	1 Million 10 Million*
<b>IPSec VPN</b>	140 Gbps	140 Gbps	280 Gbps	400 Gbps	210 Gbps	310 Gbps
<b>IPS (Ent. Mix)</b>	44 Gbps	55 Gbps	30 Gbps	32 Gbps	52 Gbps	94 Gbps
<b>NGFW (Ent. Mix)</b>	34 Gbps	40 Gbps	22 Gbps	28 Gbps	47 Gbps	82 Gbps
<b>Threat Protection (Ent. Mix)</b>	25 Gbps	30 Gbps	13.5 Gbps	20 Gbps	45 Gbps	75 Gbps
<b>Interfaces</b>	4x 100GE QSFP28 , 24x 25GE SFP28, 2x GE RJ45	6x 100GE QSFP28 , 32x 25GE SFP28, 2x GE RJ45	6x 100GE QSFP28, 16x 10GE SFP+ , 2x GE RJ45	10x 100GE QSFP28, 16x 10GE SFP+ , 2x GE RJ45	8x 100GE QSFP28 , 18x 25GE SFP28, 2x GE RJ45	12x 100GE QSFP28 , 18x 25GE SFP28, 2x GE RJ45
<b>Storage</b>	2x 2TB (3401E)	2x 2TB (3601E)	-	-	2x 2TB (4201F)	2x 2TB (4401F)
<b>Variants</b>	DC	-	DC	DC	DC	-

\* req. HyperScale License



# FortiGate 1000D

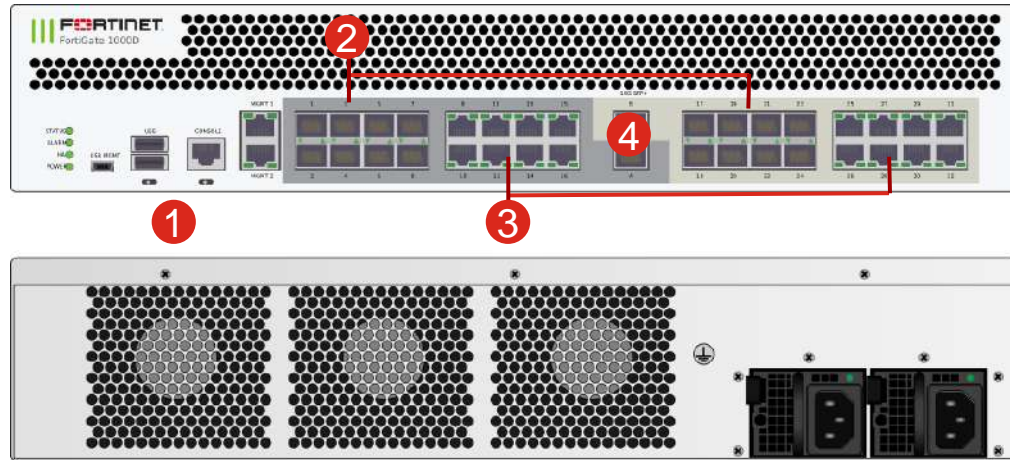

- ① 2x GE RJ45 Management Ports
- ② 16x GE SFP Slots
- ③ 16x GE RJ45 Ports
- ④ 2x 10GE SFP+ Slots

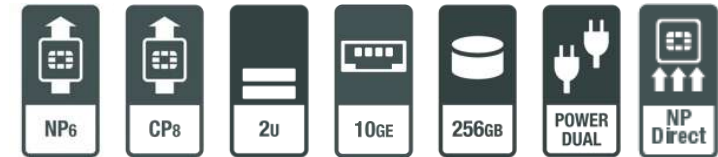

**55 Gbps**  
Firewall throughput



**6 Gbps**  
IPS Throughput

**280,000**  
New Sessions/Sec

**11 Million**  
Concurrent Sessions



**5 Gbps**  
NGFW Throughput



**5.0 Gbps**  
SSL Inspection Throughput



**3 Gbps**  
Threat Protection Throughput

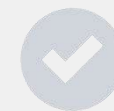

**Large Enterprise / Data Center / SP**  
NGFW / ISFW / IPS / SWG / Mobile Security



# FortiGate 1100E/-DC and 1101E

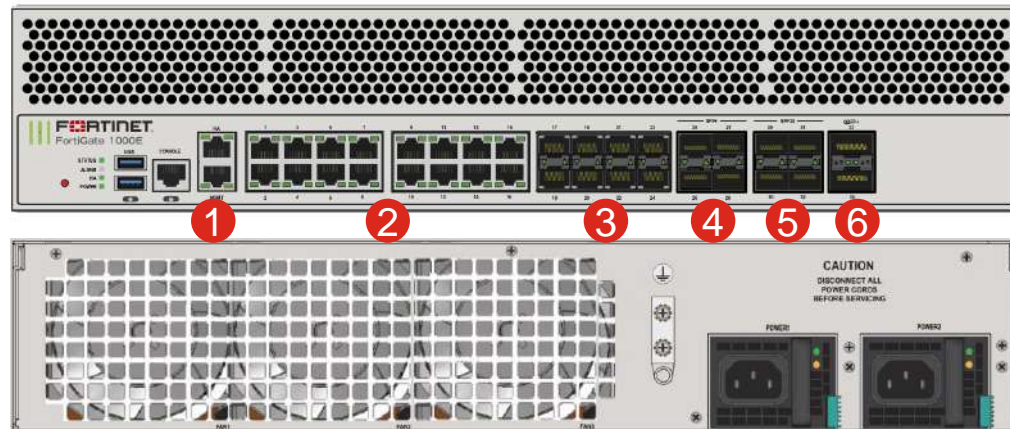

- ① 2 x GE RJ45 MGMT/HA Ports
- ② 16 x GE RJ45 Ports
- ③ 8 x GE SFP Slots
- ④ 4 x 10GE SFP+ Slots
- ⑤ 4 x 25GE SFP28/10GE SFP+ Slots
- ⑥ 2 x 40GE QSFP+ Slots

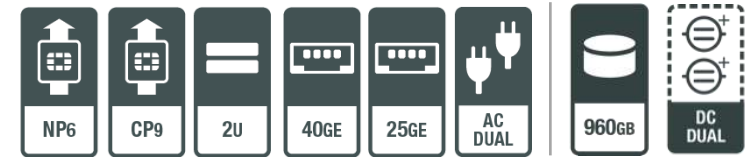

**80 Gbps**  
Firewall throughput



**12.5 Gbps**  
IPS Throughput

**500,000**  
New Sessions/Sec

**8 Million**  
Concurrent Sessions



**9.8 Gbps**  
NGFW Throughput



**10 Gbps**  
SSL Inspection Throughput



**7.1 Gbps**  
Threat Protection Throughput

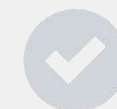

**Large Enterprise / Data Center / SP**  
NGFW / ISFW / IPS / SWG / Mobile Security

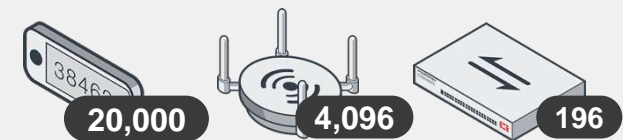



# FortiGate 1200D

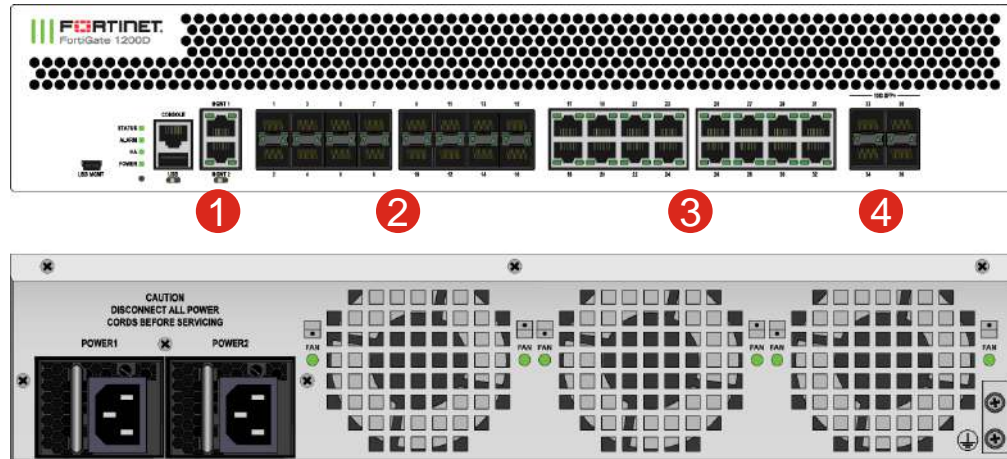

- ① 2x GE RJ45 Management Ports
- ② 16x GE SFP Slots
- ③ 16x GE RJ45 Ports
- ④ 4x 10GE SPF/+ Slots

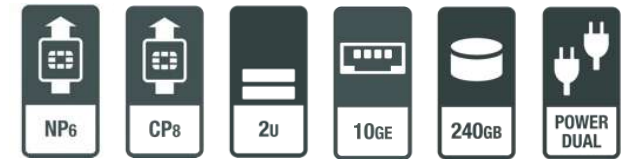

**72 Gbps**  
Firewall throughput



**6.8 Gbps**  
IPS Throughput

**290,000**  
New Sessions/Sec

**11 Million**  
Concurrent Sessions



**6 Gbps**  
NGFW Throughput



**5.0 Gbps**  
SSL Inspection Throughput



**4 Gbps**  
Threat Protection Throughput

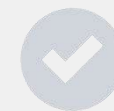

**Large Enterprise / Data Center / SP**  
NGFW / ISFW / IPS / SWG / Mobile Security

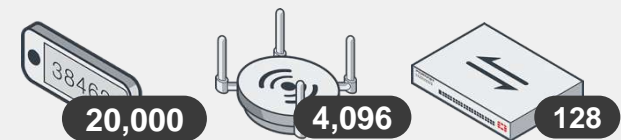

# FortiGate 1500D

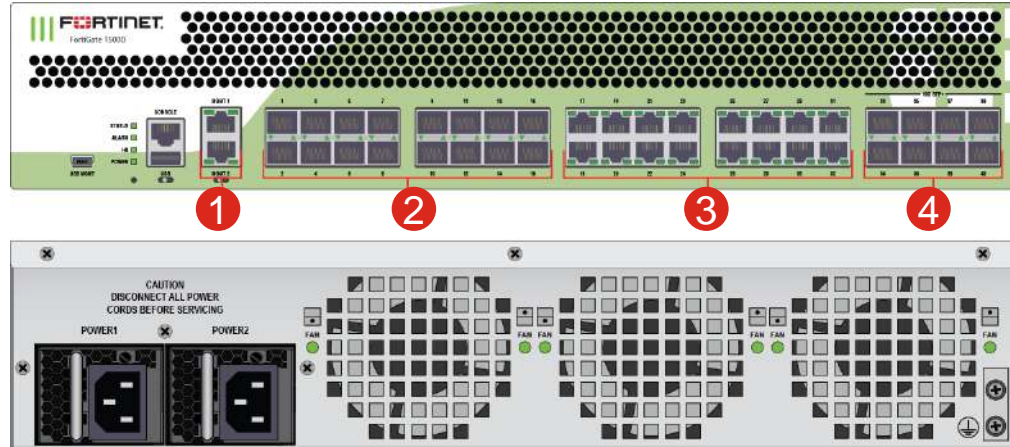

- ① 2x GE RJ45 Management Ports
- ② 16x GE SFP Slots
- ③ 16x GE RJ45 Ports
- ④ 8x 10GE SPF/+ Slots



**80 Gbps**  
Firewall throughput



**13 Gbps**  
IPS Throughput

**300,000**  
New Sessions/Sec

**12 Million**  
Concurrent Sessions



**7 Gbps**  
NGFW Throughput



**5.7 Gbps**  
SSL Inspection Throughput



**5 Gbps**  
Threat Protection Throughput

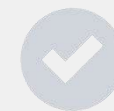

**Large Enterprise / Data Center / SP**  
NGFW / ISFW / IPS / SWG / Mobile Security





# FortiGate 1500DT

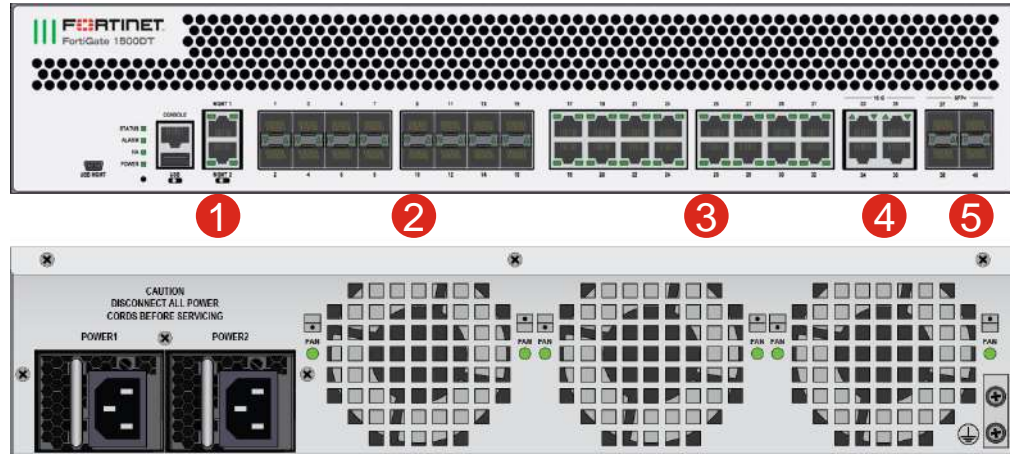

- ① 2x GE RJ45 Management Ports
- ② 16x GE SFP Slots
- ③ 16x GE RJ45 Ports
- ④ 4x 10GE RJ45 Ports
- ⑤ 4x 10GE SPF/+ Slots



**80 Gbps**  
Firewall throughput



**13 Gbps**  
IPS Throughput

**300,000**  
New Sessions/Sec

**12 Million**  
Concurrent Sessions



**7 Gbps**  
NGFW Throughput



**5.7 Gbps**  
SSL Inspection Throughput



**5 Gbps**  
Threat Protection Throughput

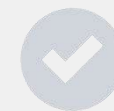

**Large Enterprise / Data Center / SP**  
NGFW / ISFW / IPS / SWG / Mobile Security

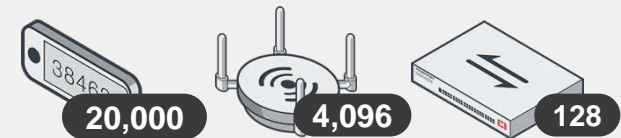

# FortiGate 1800/1801F/-DC

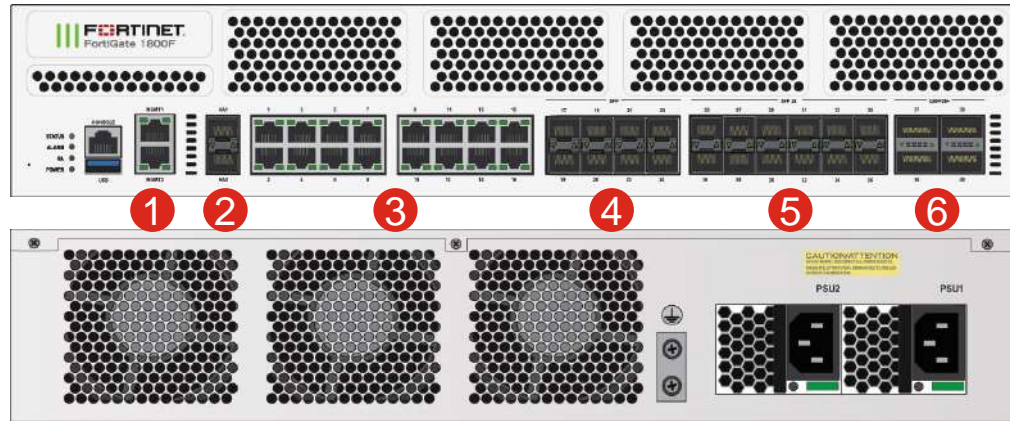

- ① 2 x GE RJ45 MGMT Ports
- ② 2 x 10GE RJ45 HA SFP+ Slots
- ③ 16 x GE RJ45 Ports
- ④ 8 x GE SFP Slots
- ⑤ 12 x 25GE SFP28/10GE SFP+ Slots
- ⑥ 4 x 40GE QSFP+ Slots

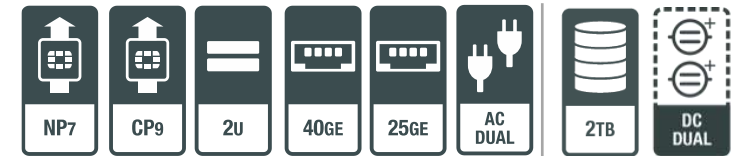

**198 Gbps**  
Firewall throughput



**13 Gbps**  
IPS Throughput

**750,000**  
New Sessions/Sec

**12 Million**  
Concurrent Sessions



**11 Gbps**  
NGFW Throughput



**17 Gbps**  
SSL Inspection Throughput



**9.1 Gbps**  
Threat Protection Throughput

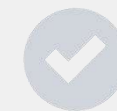

**Large Enterprise / Data Center / SP**  
NGFW / ISFW / IPS / SWG / Mobile Security



# FortiGate 2000E

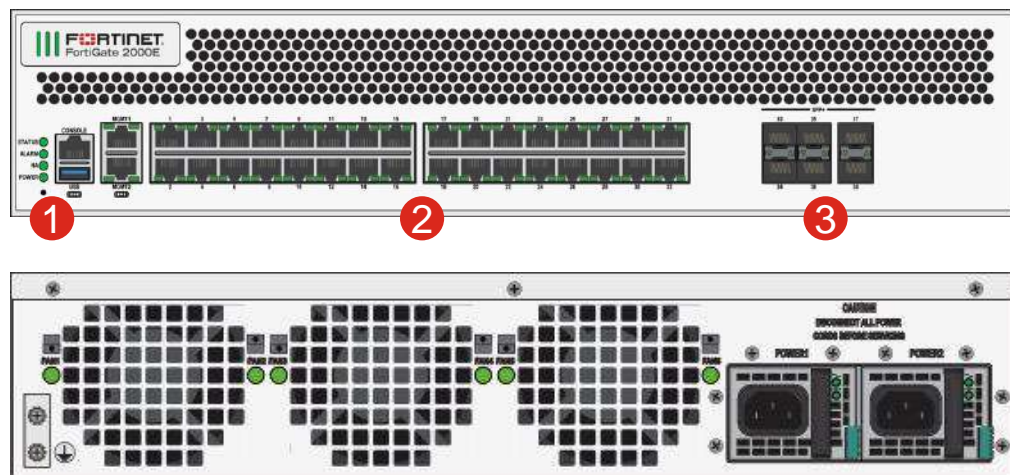

- ① 2x GE RJ45 Management Ports
- ② 32x GE RJ45 Ports
- ③ 6x 10GE SFP+ Slots

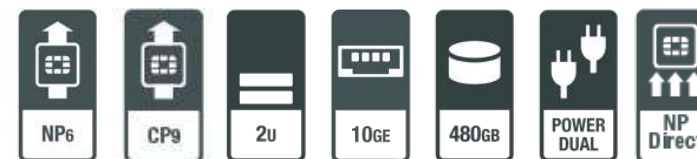

**90 Gbps**

Firewall throughput



**11.5 Gbps**

IPS Throughput



**9 Gbps**

NGFW Throughput



**5.4 Gbps**

Threat Protection Throughput

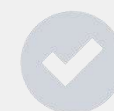

**Large Enterprise / Data Center / SP**

NGFW / ISFW / IPS / SWG / Mobile Security

**500,000**

New Sessions/Sec

**20 Million**

Concurrent Sessions



**9.4 Gbps**

SSL Inspection Throughput

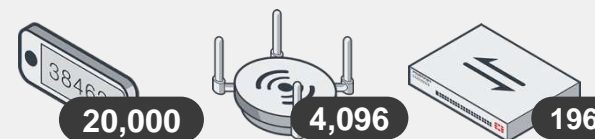

# FortiGate 2200/2201E

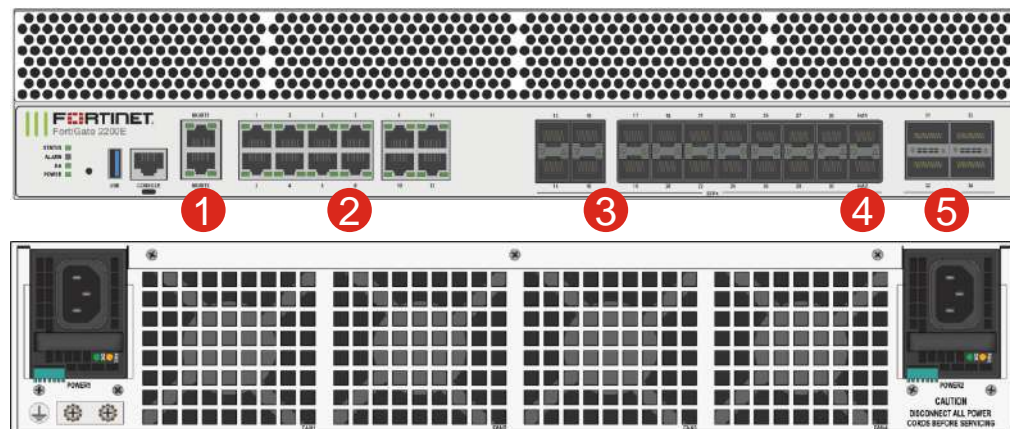

- ① 2 x GE RJ45 MGMT Ports
- ② 12 x GE RJ45 Ports
- ③ 18 x 25GE SFP28/10GE SFP+ Slots
- ④ 2 x 25GE SFP28/10GE SFP+ HA Slots
- ⑤ 4 x 40GE QSFP+ Slots

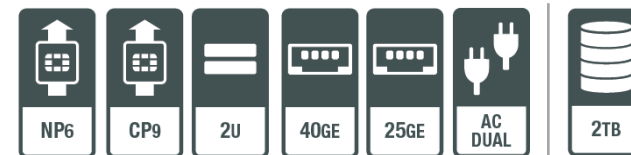

**158 Gbps**

Firewall throughput



**16.5 Gbps**

IPS Throughput



**13.5 Gbps**

NGFW Throughput



**11 Gbps**

Threat Protection Throughput

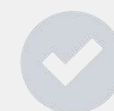

**Large Enterprise / Data Center / SP**

NGFW / ISFW / IPS / SWG / Mobile Security

**500,000**

New Sessions/Sec

**24 Million**

Concurrent Sessions



**17 Gbps**

SSL Inspection Throughput





# FortiGate 2500E

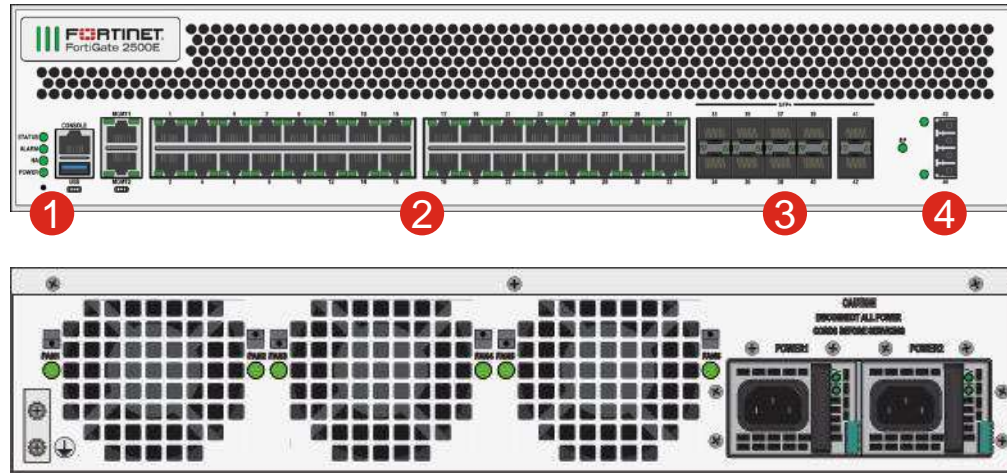

- ① 2x GE RJ45 Management Ports
- ② 32x GE RJ45 Ports
- ③ 10x 10GE SFP+ Slots
- ④ 2x 10GE SFP+ SR Bypass (LC Connector)

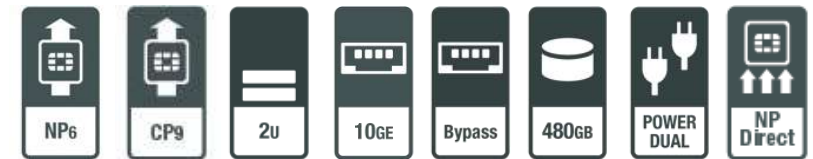

**150 Gbps**  
Firewall throughput



**11.5 Gbps**  
IPS Throughput

**500,000**  
New Sessions/Sec

**20 Million**  
Concurrent Sessions



**9 Gbps**  
NGFW Throughput



**9.4 Gbps**  
SSL Inspection Throughput



**5.4 Gbps**  
Threat Protection Throughput

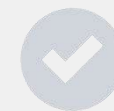

**Large Enterprise / Data Center / SP**  
NGFW / ISFW / IPS / SWG / Mobile Security

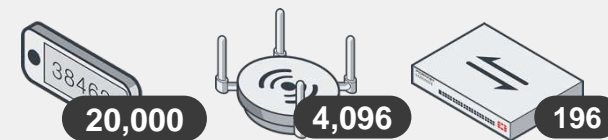

# FortiGate 2600/2601F

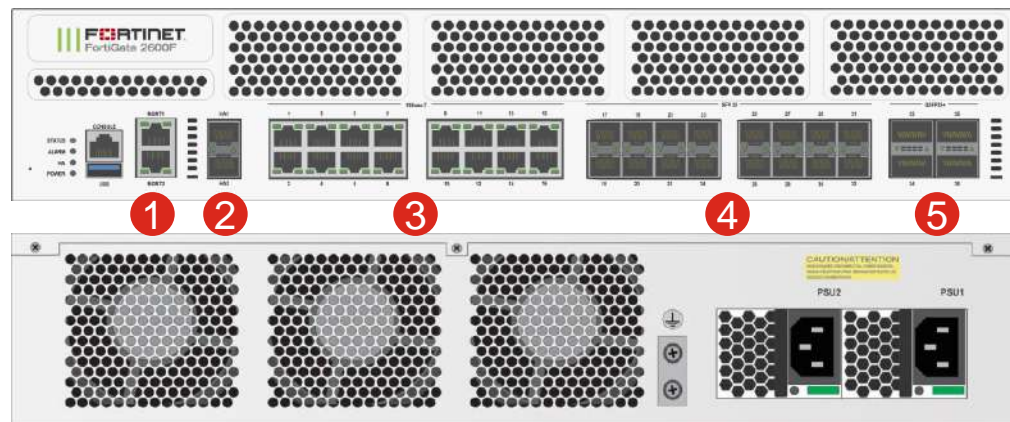

- ① 2 x GE RJ45 MGMT Ports
- ② 2 x 10GE SFP+/GE SFP Slots
- ③ 16 x 10GE RJ45 Ports
- ④ 16 x 25GE SFP28/10GE SFP+/GE SFP Slots
- ⑤ 4 x 100GE QSFP28 / 40GE QSFP+ Slots

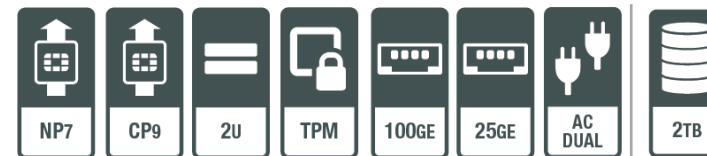

**198 Gbps**  
Firewall throughput



**24 Gbps**  
IPS Throughput

**1 Million**  
New Sessions/Sec

**24 Million**  
Concurrent Sessions



**19 Gbps**  
NGFW Throughput



**20 Gbps**  
SSL Inspection Throughput



**17 Gbps**  
Threat Protection Throughput

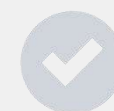

**Large Enterprise / Data Center / SP**  
NGFW / ISFW / IPS / SWG / Mobile Security

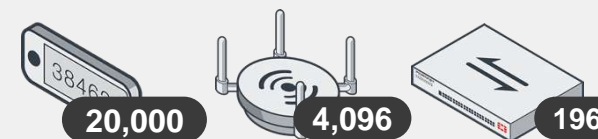

# FortiGate 3000D

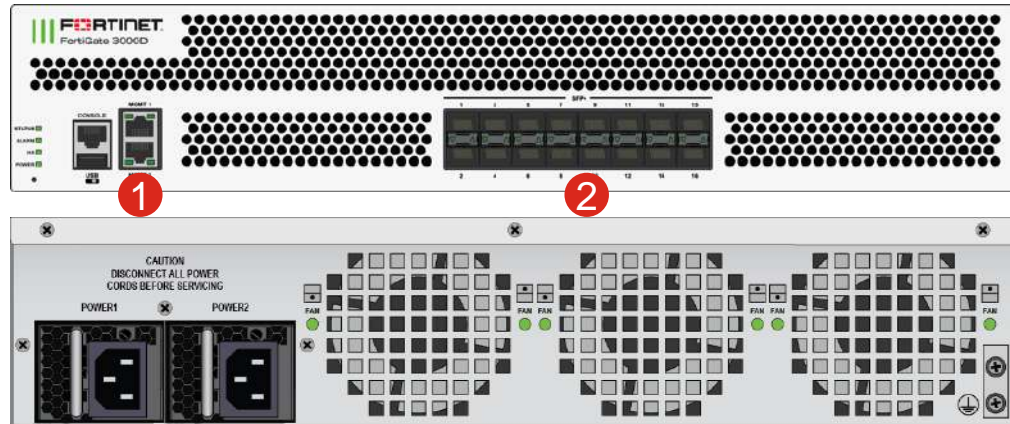

- ① 2x GE RJ45 Management Ports
- ② 16x 10G SFP+/GE SFP Slots

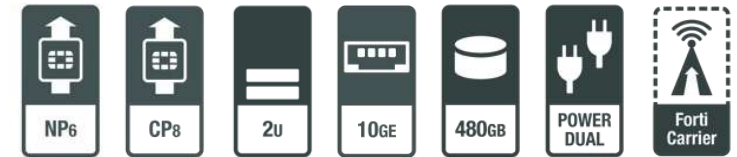

**80 Gbps**  
Firewall throughput



**23 Gbps**  
IPS Throughput

**400,000**  
New Sessions/Sec

**50 Million**  
Concurrent Sessions



**22 Gbps**  
NGFW Throughput



**15 Gbps**  
SSL Inspection Throughput



**13 Gbps**  
Threat Protection Throughput

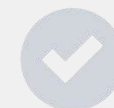

**Large Enterprise / Data Center / SP**  
NGFW / ISFW / IPS / SWG / Mobile Security

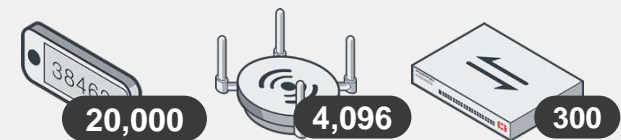

# FortiGate 3100D

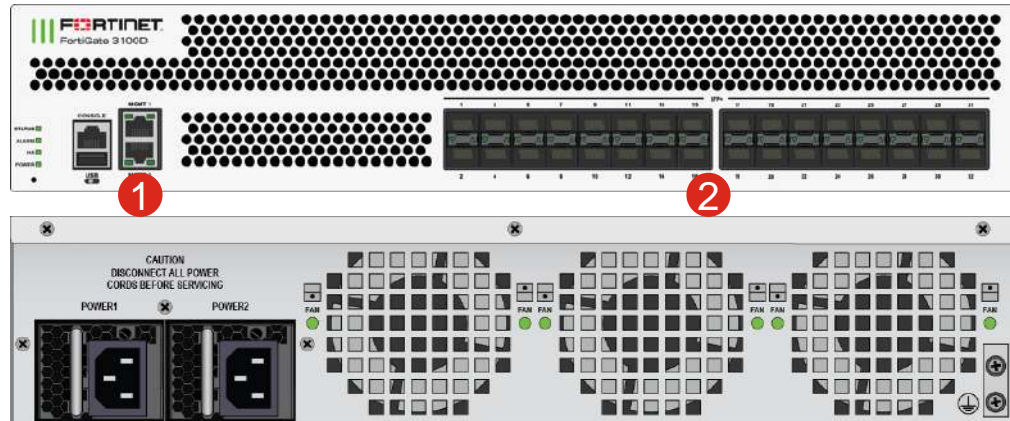

- ① 2x GE RJ45 Management Ports
- ② 32x 10G SFP+/GE SFP Slots

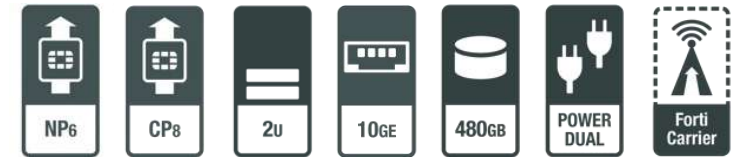

**80 Gbps**  
Firewall throughput



**22 Gbps**  
IPS Throughput

**400,000**  
New Sessions/Sec

**50 Million**  
Concurrent Sessions



**18 Gbps**  
NGFW Throughput



**16 Gbps**  
SSL Inspection Throughput



**13 Gbps**  
Threat Protection Throughput

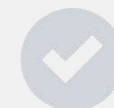

**Large Enterprise / Data Center / SP**  
NGFW / ISFW / IPS / SWG / Mobile Security





# FortiGate 3200D

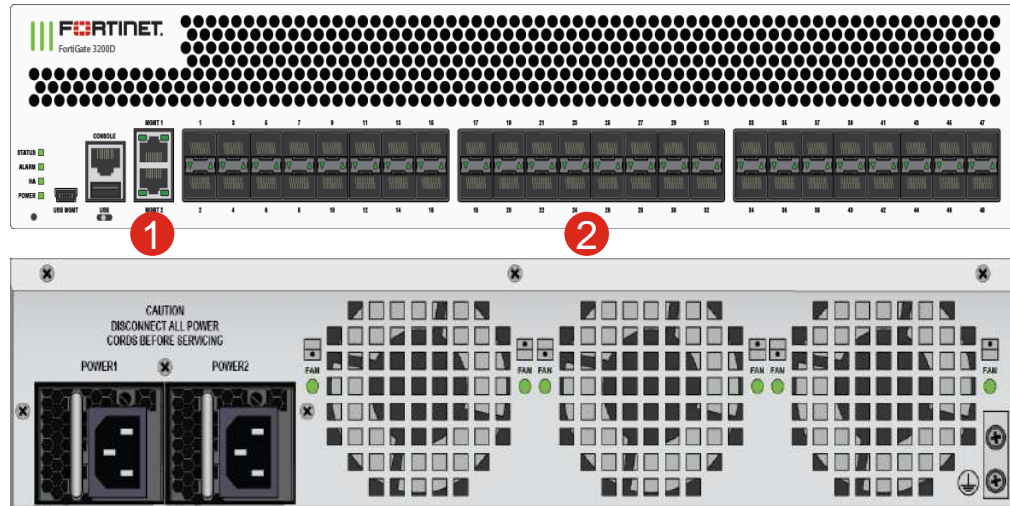

- ① 2x GE RJ45 Management Ports
- ② 48x 10G SFP+/GE SFP Slots

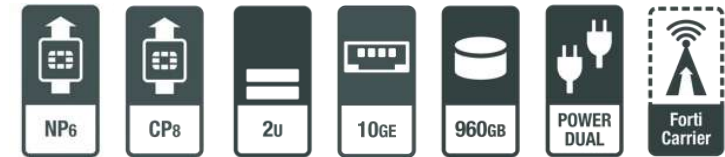

**80 Gbps**  
Firewall throughput



**26 Gbps**  
IPS Throughput

**400,000**  
New Sessions/Sec

**50 Million**  
Concurrent Sessions



**24 Gbps**  
NGFW Throughput



**17 Gbps**  
SSL Inspection Throughput



**15 Gbps**  
Threat Protection Throughput

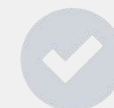

**Large Enterprise / Data Center / SP**  
NGFW / ISFW / IPS / SWG / Mobile Security



# FortiGate 3300/3301E

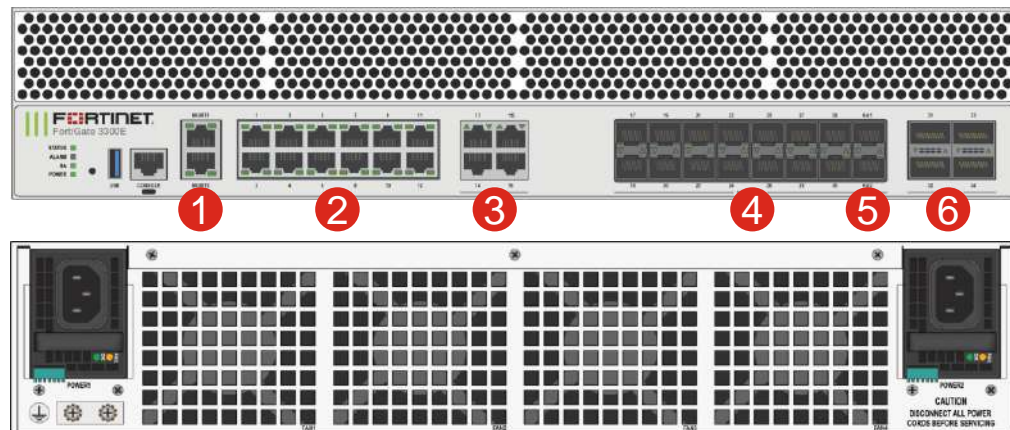

- ① 2 x GE RJ45 MGMT/HA Ports
- ② 12 x GE RJ45 Ports
- ③ 4 x 10GE RJ45 Ports
- ④ 14 x 25GE SFP28/10GE SFP+ Slots
- ⑤ 2 x 25GE SFP28/10GE SFP+ HA Slots
- ⑥ 4x 40GE QSFP+ Slots

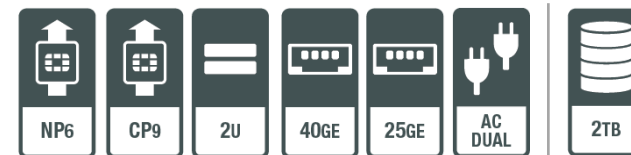

**160 Gbps**  
Firewall throughput



**27 Gbps**  
IPS Throughput

**700,000**  
New Sessions/Sec

**50 Million**  
Concurrent Sessions



**23 Gbps**  
NGFW Throughput



**21 Gbps**  
SSL Inspection Throughput



**17 Gbps**  
Threat Protection Throughput

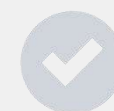

**Large Enterprise / Data Center / SP**  
NGFW / ISFW / IPS / SWG / Mobile Security



# FortiGate 3400/3401E/-DC

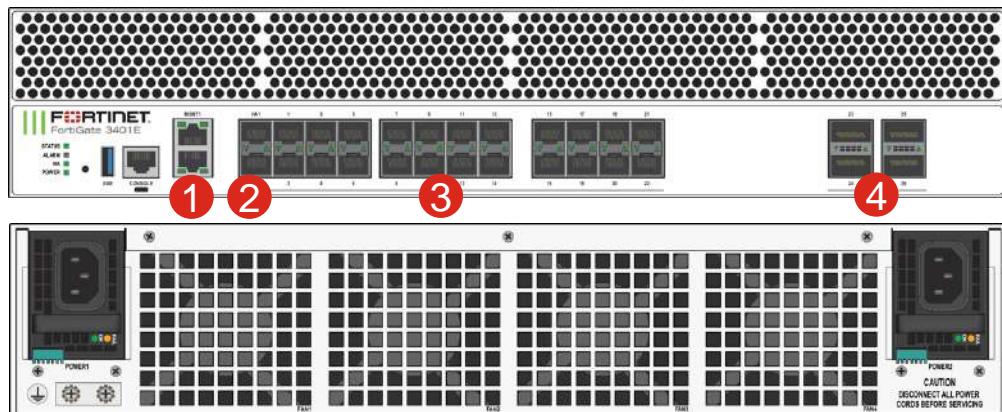

- ① 2x GE RJ45 Management Ports
- ② 2x 10EG SFP+/GE HA SFP Slots
- ③ 22x 25EG SFP28/10GE SFP+/GE SFP Slots
- ④ 4x 100GE QSFP28 / 40GE QSFP+ Slots

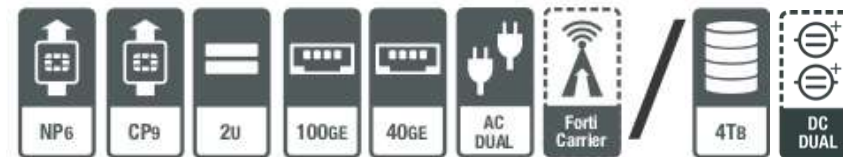

**240 Gbps**  
Firewall throughput



**44 Gbps**  
IPS Throughput

**850,000**  
New Sessions/Sec

**50 Million**  
Concurrent Sessions



**34 Gbps**  
NGFW Throughput



**30 Gbps**  
SSL Inspection Throughput



**25 Gbps**  
Threat Protection Throughput

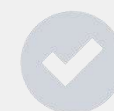

**Large Enterprise / Data Center / SP**  
NGFW / ISFW / IPS / SWG / Mobile Security



# FortiGate 3600E/-DC and 3601E

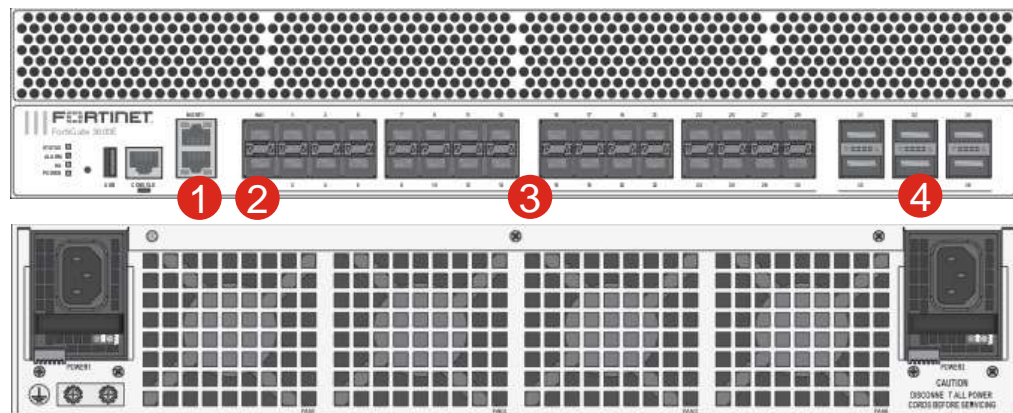

- ① 2x GE RJ45 Management Ports
- ② 2x 10GE SFP+/GE HA SFP Slots
- ③ 30x 25GE SFP28/10GE SFP+/GE SFP Slots
- ④ 6x 100GE QSFP28 / 40GE QSFP+ Slots



**240 Gbps**  
Firewall throughput



**55 Gbps**  
IPS Throughput

**950,000**  
New Sessions/Sec

**50 Million**  
Concurrent Sessions



**40 Gbps**  
NGFW Throughput



**34 Gbps**  
SSL Inspection Throughput



**30 Gbps**  
Threat Protection Throughput

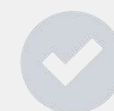

**Large Enterprise / Data Center / SP**  
NGFW / ISFW / IPS / SWG / Mobile Security





# FortiGate 3700D/-DC

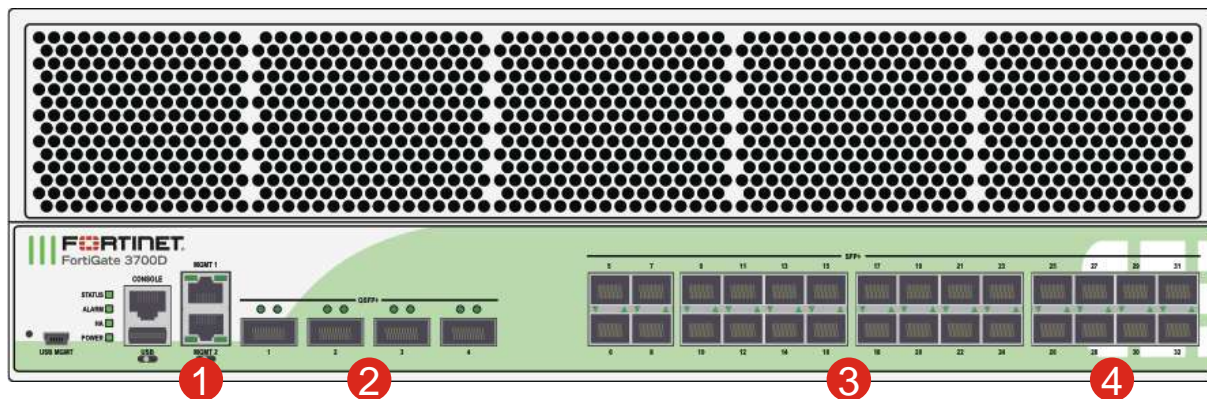

- ① 2 x GE RJ45 Management Ports
- ② 4 x 40GE QSFP Slots
- ③ 20 x 10GE SFP/+ Slots
- ④ 8 ultra-low latency 10GE SFP+ Slots



**160 Gbps**

Firewall throughput



**28 Gbps**

IPS Throughput

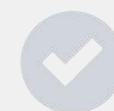

**Large Enterprise / Data Center / SP**

NGFW / ISFW / IPS / SWG / Mobile Security

**480,000**

New Sessions/Sec

**50 Million**

Concurrent Sessions



**20 Gbps**

NGFW Throughput



**15.5 Gbps**

SSL Inspection Throughput



**13 Gbps**

Threat Protection Throughput

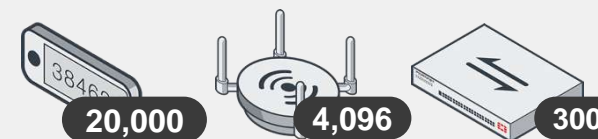

# FortiGate 3800D/-DC

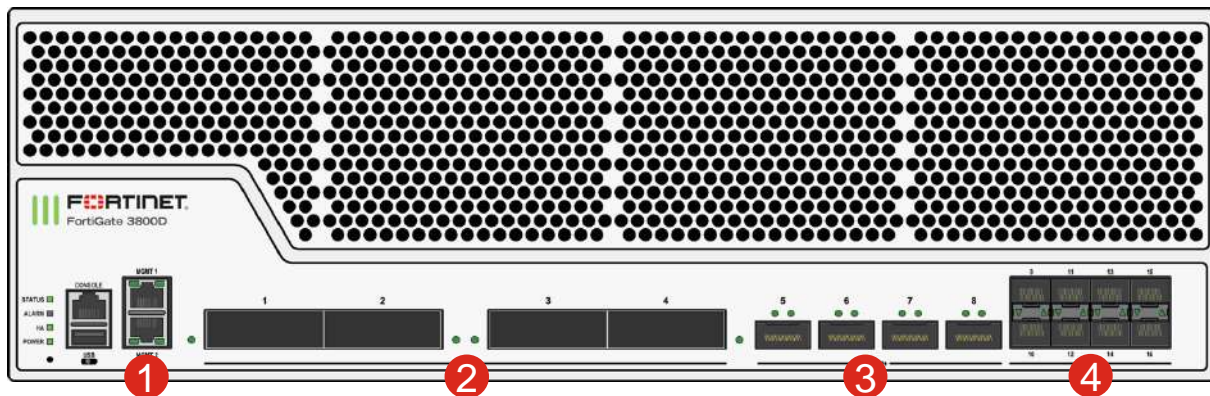

- ① 2 x GE RJ45 Management Ports
- ② 4 x 100GE CFP2 Slots
- ③ 4 x 40GE QSFP+ Slots
- ④ 8 x 10GE SFP+ Slots



**320 Gbps**  
Firewall throughput



**30 Gbps**  
IPS Throughput

**480,000**  
New Sessions/Sec

**95 Million**  
Concurrent Sessions



**20 Gbps**  
NGFW Throughput



**14.4 Gbps**  
SSL Inspection Throughput



**13 Gbps**  
Threat Protection Throughput

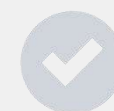

**Large Enterprise / Data Center / SP**  
NGFW / ISFW / IPS / SWG / Mobile Security



# FortiGate 3960E/-DC

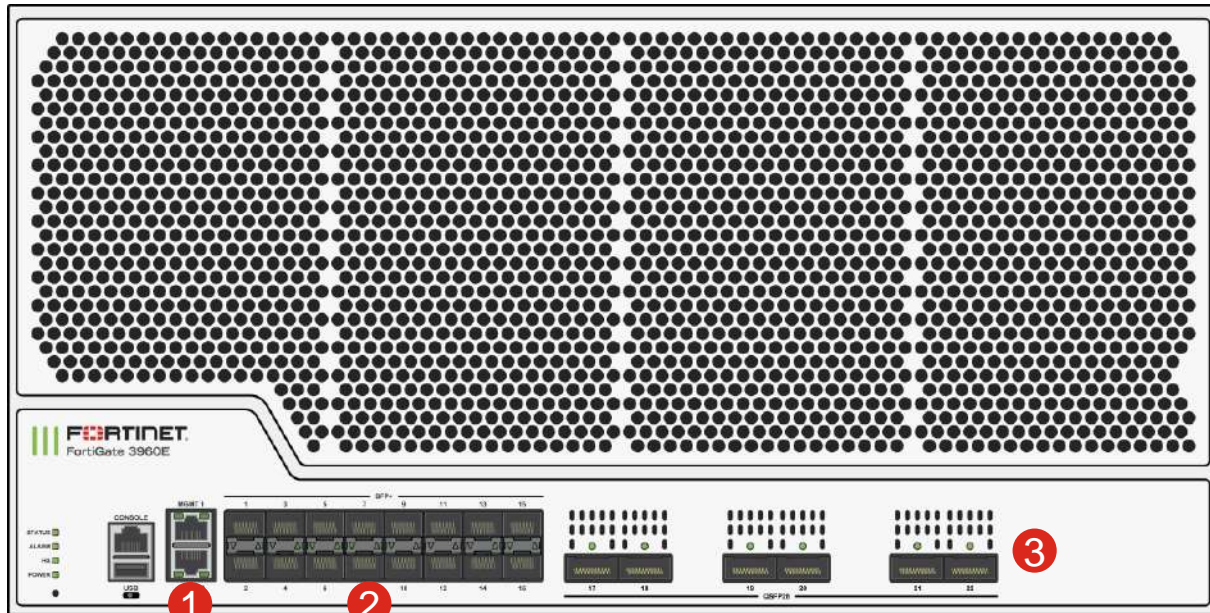

- ① 2 x GE RJ45 Management Ports
- ② 16 x GE/10GE SFP/SFP+ Slots
- ③ 6x 100GE QSFP28 Slots

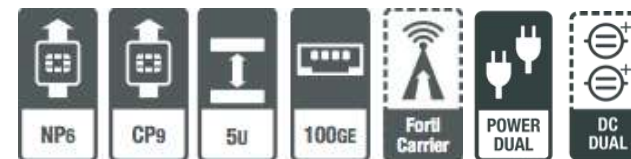

**620 Gbps**

Firewall throughput



**30 Gbps**

IPS Throughput

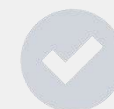

**Large Enterprise / Data Center / SP**

NGFW / ISFW / IPS / SWG / Mobile Security

**720,000**

New Sessions/Sec

**160 Million**

Concurrent Sessions



**22 Gbps**

NGFW Throughput



**23 Gbps**

SSL Inspection Throughput



**13.5 Gbps**

Threat Protection Throughput





# FortiGate 3980E/-DC

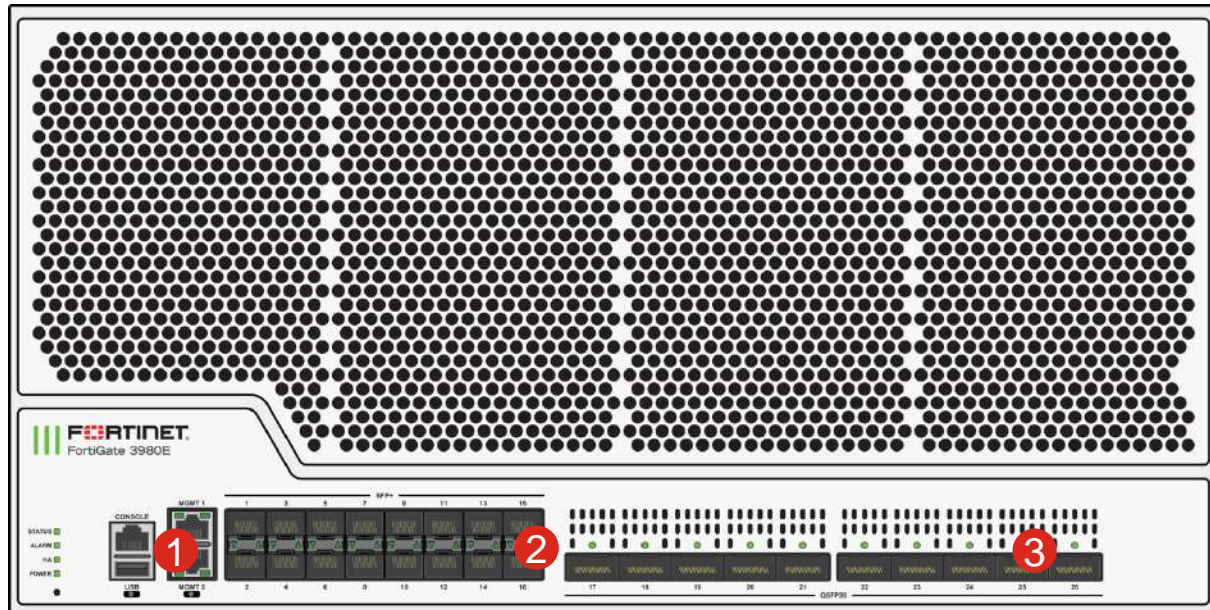

- ① 2 x GE RJ45 Management Ports
- ② 16 x GE/10GE SFP/SFP+ Slots
- ③ 10x 100GE QSFP28 Slots



**1.06 Tbps**

Firewall throughput



**32 Gbps**

IPS Throughput

**800,000**

New Sessions/Sec

**160 Million**

Concurrent Sessions



**28 Gbps**

NGFW Throughput



**26 Gbps**

SSL Inspection Throughput



**20 Gbps**

Threat Protection Throughput

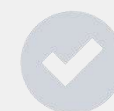

**Large Enterprise / Data Center / SP**

NGFW / ISFW / IPS / SWG / Mobile Security





# FortiGate 4200/4201F-DC

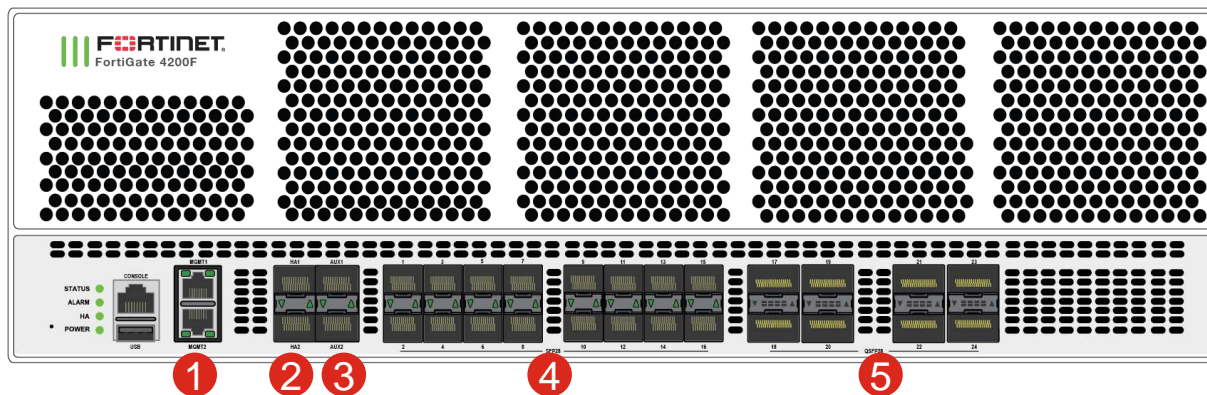

- ① 2 x GE RJ45 Management Ports
- ② 2 x 25GE SFP28/10GE SFP+/GE SFP HA Slots
- ③ 2 x 25GE SFP28/10GE SFP+/GE SFP AUX Slots
- ④ 16x 25GE SFP28/10GE SFP+/GE SFP Slots
- ⑤ 8x 100GE QSFP28 / 40GE QSFP+ Slots

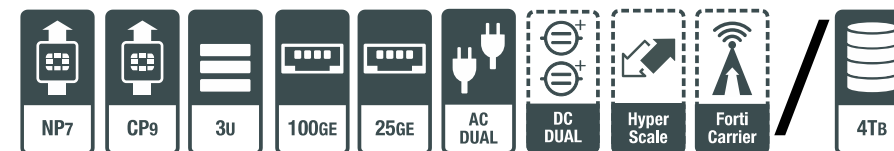

**800 Gbps**  
Firewall throughput



**52 Gbps**  
IPS Throughput

**1/7\* Mil**  
New Sessions/Sec

**210/450\* Mil**  
Concurrent Sessions



**47 Gbps**  
NGFW Throughput



**50 Gbps**  
SSL Inspection Throughput



**45 Gbps**  
Threat Protection Throughput

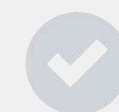

**Large Enterprise / Data Center / SP**  
NGFW / ISFW / IPS / CGN / Mobile Security



# FortiGate 4400/4401F

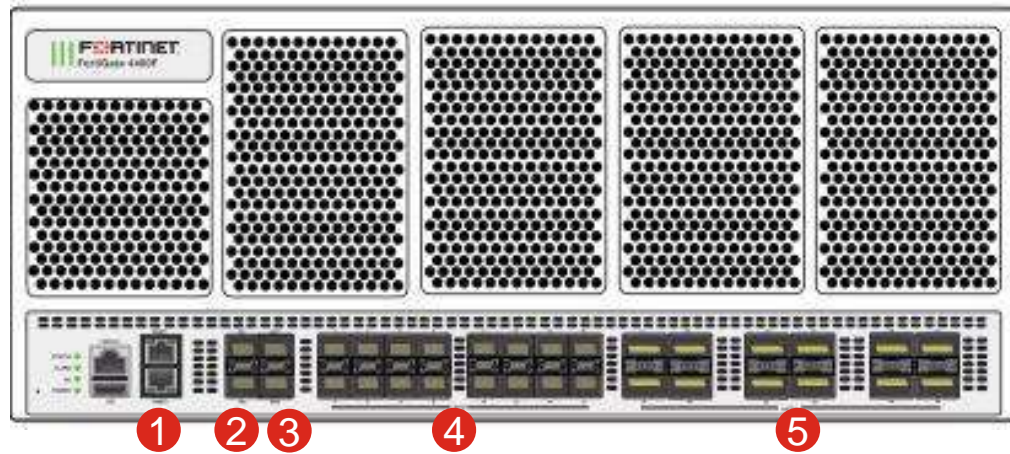

- ① 2 x GE RJ45 MGMT Ports
- ② 2 x 25GE SFP28/10GE SFP+/GE HA Slots
- ③ 2 x 25GE SFP28/10GE SFP+/GE AUX Slots
- ④ 16 x 25GE SFP28/10GE SFP+/GE Slots
- ⑤ 12 x 100 GE QSFP28 / 40 GE QSFP+ Slots

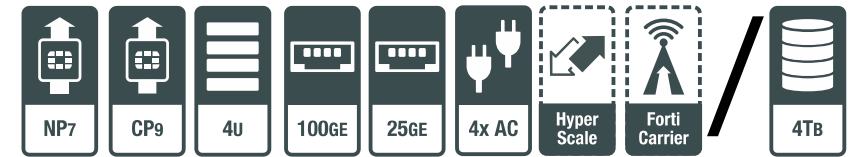

**1.15 Tbps**  
Firewall throughput



**94 Gbps**  
IPS Throughput

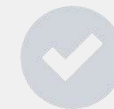

**Large Enterprise / Data Center / SP**  
NGFW / ISFW / IPS / SWG / Mobile Security

**1/10\* Mil**  
New Sessions/Sec

**210/700\* Mil**  
Concurrent Sessions



**82 Gbps**  
NGFW Throughput



**86 Gbps**  
SSL Inspection Throughput



**75 Gbps**  
Threat Protection Throughput

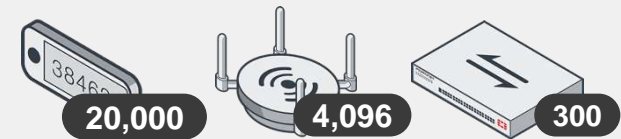

# FortiGate 5000 Series



## Security Appliances For Very Large Enterprises & Service Providers



 **FG-5144C with FG-5001E  
& FCTL-5903C**

- **Chassis-based platforms offer maximum performance, reliability, and scalability for high-speed service provider, large enterprise or telecommunications carrier networks.**
- **Flexibility enables protection of complex, multi-tenant cloud-based security-as-a-service and infrastructure-as-a-service environments.**

### Primary Benefits:

- ✓ Native 10GE support for high speed requirements
- ✓ ATCA-compliant architecture delivers carrier-grade performance, reliability, availability and serviceability
- ✓ Chassis support two, six, or fourteen FortiGate-5000 series blades, allowing customization and scaling



# Load Distribution & Virtualization

## Most flexible chassis based solution in the market

- ✓ Ease of Maintenance – hot swappable components
- ✓ Supports full hardware redundancy
- ✓ Supports various Inter and Intra HA configurations

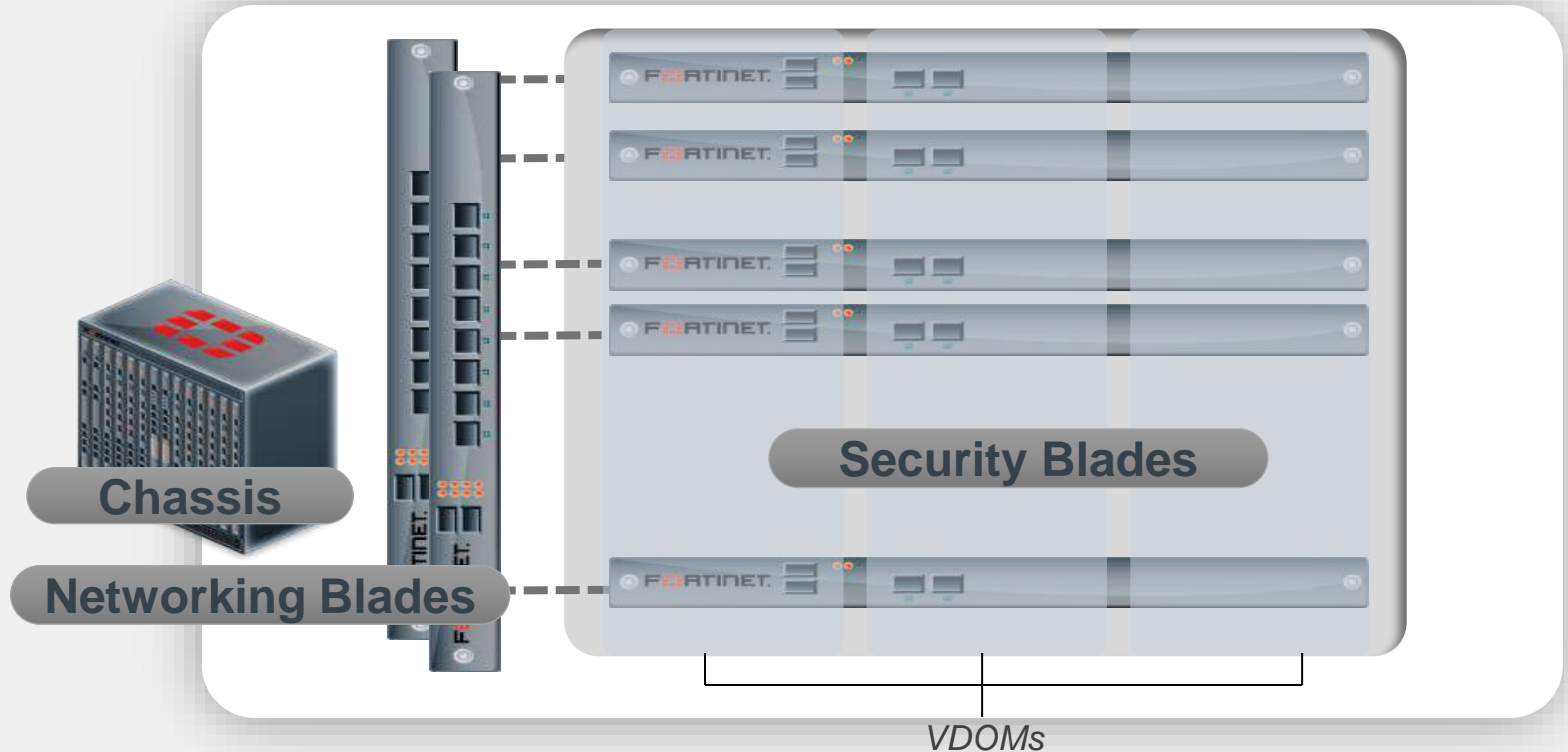

## Clustering

Scales Traffic processing capacity linearly. Interoperates with external devices

## Virtualization

Facilitates virtualized security components on FortiGate blades



# FortiGate 5001E/5001E1

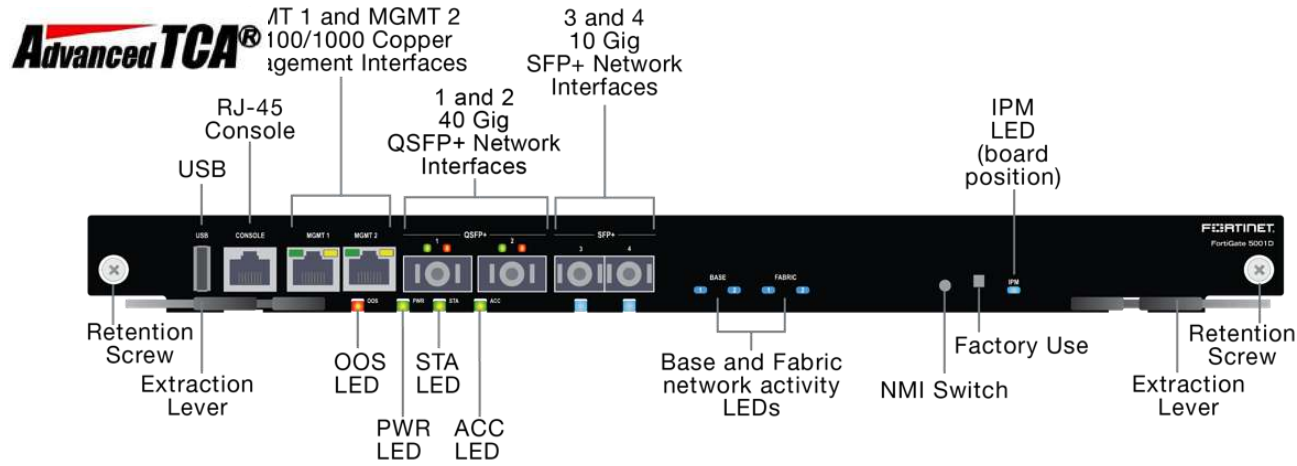

- ① 2x 40GE slots
- ② 2x 10GE slots
- ③ 2x GE RJ45 MGMT ports
- ④ Back plane connectivity : 2x base backplane 1Gbps, 4x fabric backplane 10/40Gbps

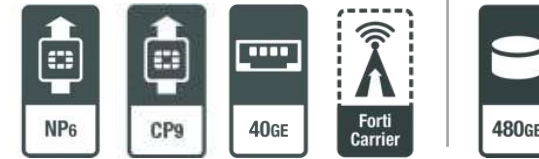

**80 Gbps**

Firewall throughput

**40 Million**

Concurrent Sessions

**640,000**

New Sessions/Sec



**18 Gbps**

IPS Throughput



**15 Gbps**

NGFW Throughput



**13.5 Gbps**

Threat Protection Throughput

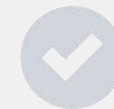

**Data Center / Service Provider**

NGFW / ISFW / IPS / Mobile Security

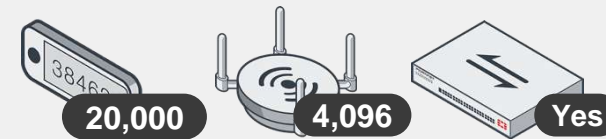



# FortiController 5902D

Advanced TCA®

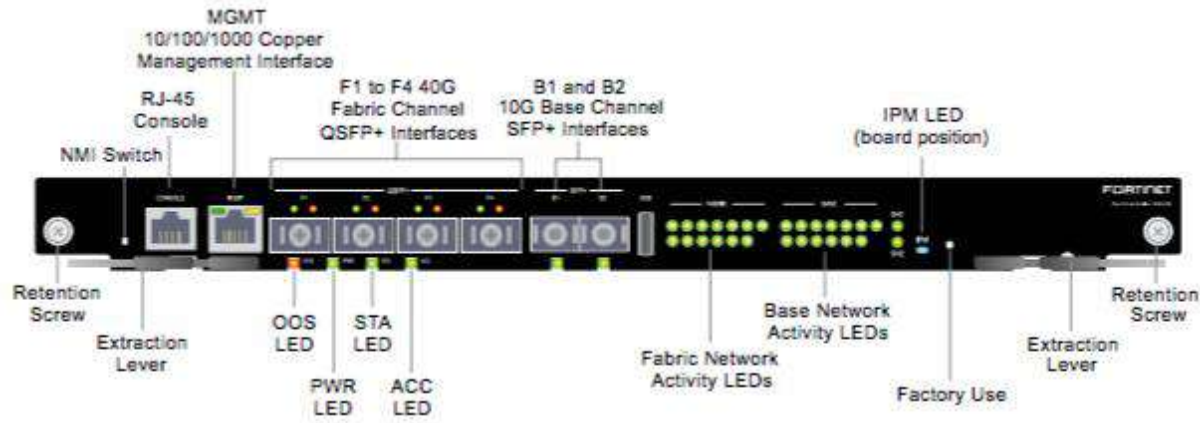

- ① 4 x 40 GE QSFP+
- ② 2 x 10GE SFP+
- ③ 1 x GE RJ45 Ports



**80 Gbps**

Firewall throughput

**50 Million**

Concurrent Sessions

**155,000**

New Sessions/Sec



**11 Gbps**

IPS Throughput



**10 Gbps**

NGFW Throughput



**6.1 Gbps**

Threat Protection Throughput

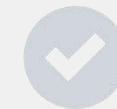

**Data Center / Service Provider**

NGFW / ISFW / IPS / Mobile Security

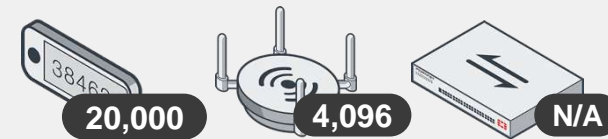

# FortiController 5903C/5913C

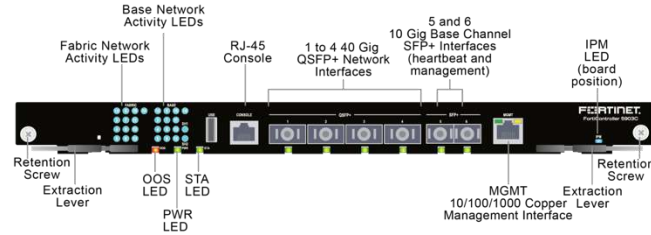

- ① 4x 40 GE QSFP+
- ② 2x 10 GE SFP+
- ③ 1x GE RJ45

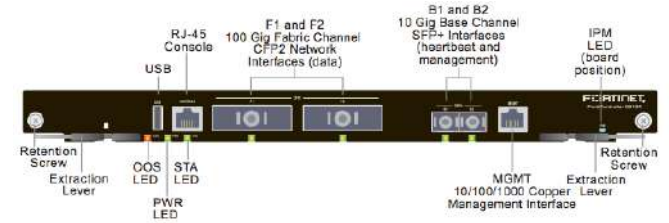

- ① 2x 100 GE CFP2
- ② 2x 10 GE SFP+
- ③ 1x GE RJ45

## FCTRL-5903C

## FCTRL-5913C

**Maximum Traffic Throughput**  
**Concurrent Sessions**  
**New Sessions/Second (TCP)**

120 Gbps

200 Gbps

135 Million

135 Million

3.2 Million

3.6 Million



# FortiGate 6300/6301F

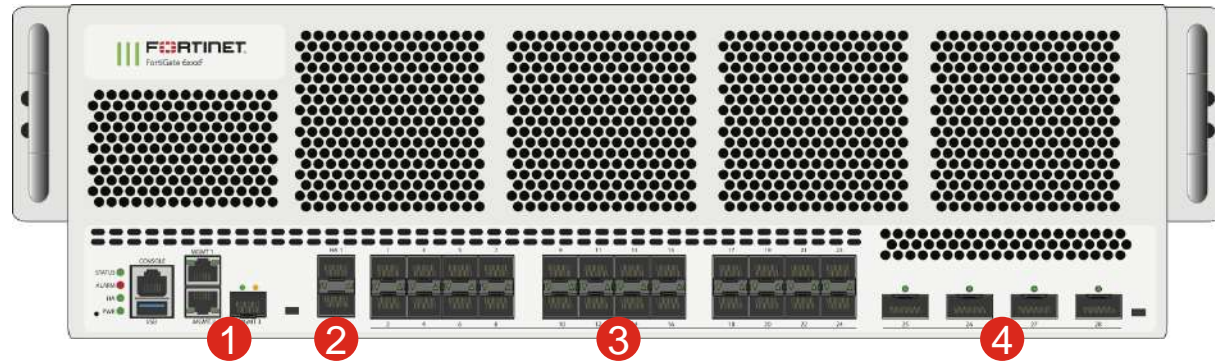

- ① 2 x GE RJ45, 1x 10 GE SFP+ Management Ports
- ② 2 x 10 GE SFP+ HA Slots
- ③ 24x 1/10/25 GE SFP/SFP+/SFP28 Slots
- ④ 4x 40/100 GE QSFP+/QSFP28 Slots

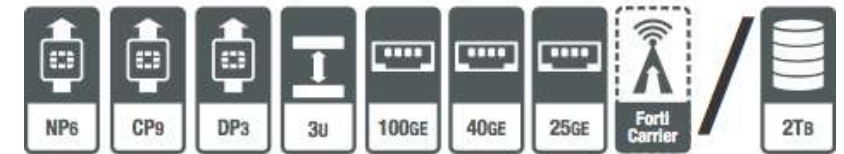

**239 Gbps**  
Firewall throughput



**110 Gbps**  
IPS Throughput

**2 Million**  
New Sessions/Sec

**120 Million**  
Concurrent Sessions



**90 Gbps**  
NGFW Throughput



**66 Gbps**  
SSL Inspection Throughput



**60 Gbps**  
Threat Protection Throughput

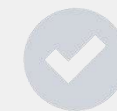

**Data Center / Service Provider**  
NGFW / ISFW / IPS / Mobile Security





# FortiGate 6500/6501F

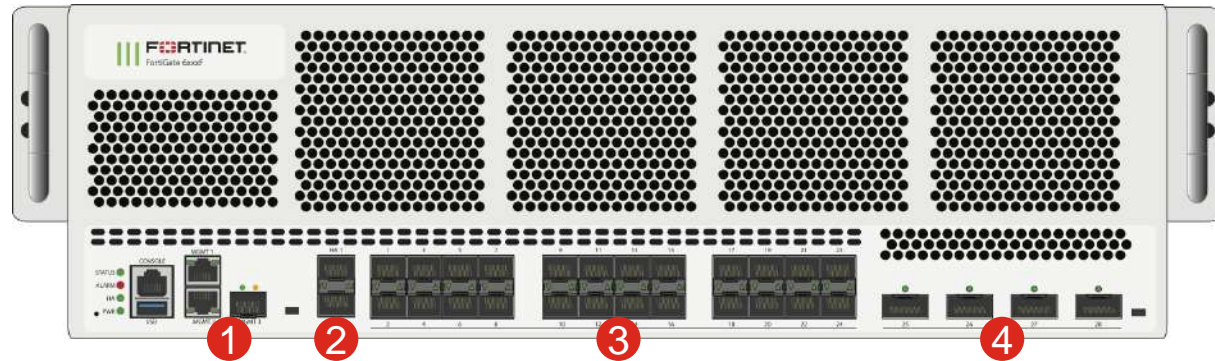

- ① 2 x GE RJ45, 1x 10 GE SFP+ Management Ports
- ② 2 x 10 GE SFP+ HA Slots
- ③ 24x 1/10/25 GE SFP/SFP+/SFP28 Slots
- ④ 4x 40/100 GE QSFP+/QSFP28 Slots

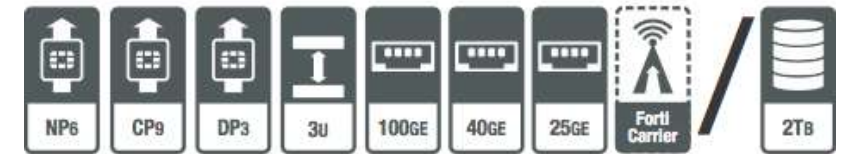

**239 Gbps**  
Firewall throughput



**170 Gbps**  
IPS Throughput

**3 Million**  
New Sessions/Sec

**200 Million**  
Concurrent Sessions



**150 Gbps**  
NGFW Throughput



**110 Gbps**  
SSL Inspection Throughput



**100 Gbps**  
Threat Protection Throughput

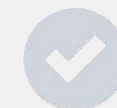

**Data Center / Service Provider**  
NGFW / ISFW / IPS / Mobile Security



# FortiGate 7030E

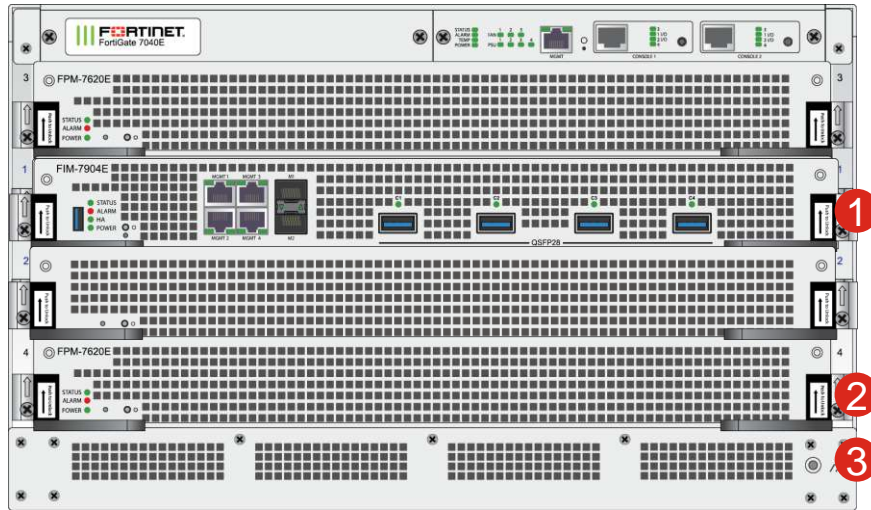

- ① 1 x FIM
- ② 2 x Processing Module Slots
- ③ 3 (+1 optional) Hot Swappable Redundant PS

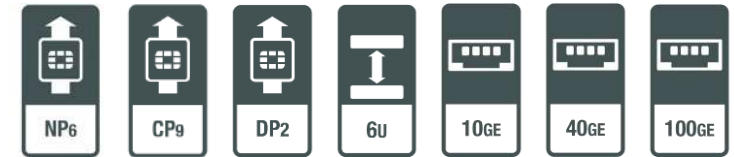

**115 Gbps**  
Firewall throughput



**60 Gbps**  
IPS Throughput

**900,000**  
New Sessions/Sec

**160 Million**  
Concurrent Sessions



**50 Gbps**  
NGFW Throughput



**39.9 Gbps**  
SSL Inspection Throughput



**35 Gbps**  
Threat Protection Throughput

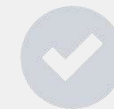

**Data Center / Service Provider**  
NGFW / ISFW / IPS / Mobile Security



# FortiGate 7040E-8/-9

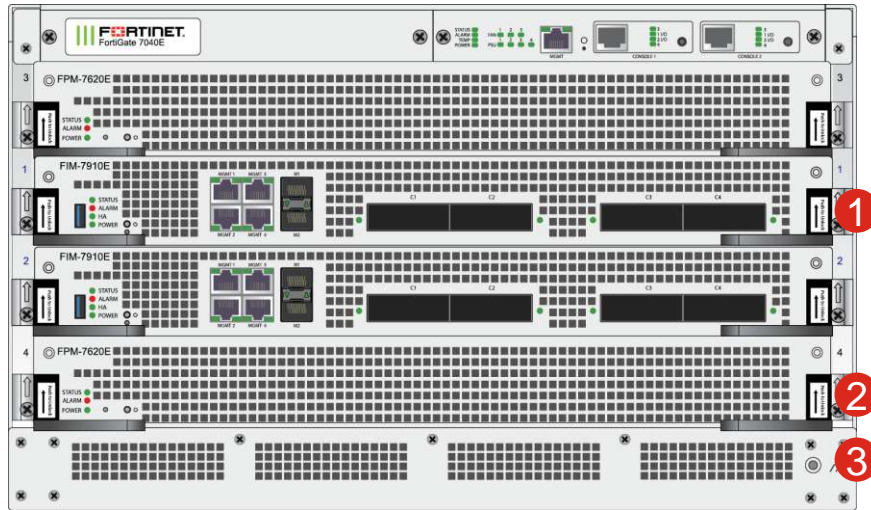

- ① 2 x I/O Module Slots
- ② 2 x Processing Module Slots
- ③ 3 (+1 optional) Hot Swappable Redundant PS

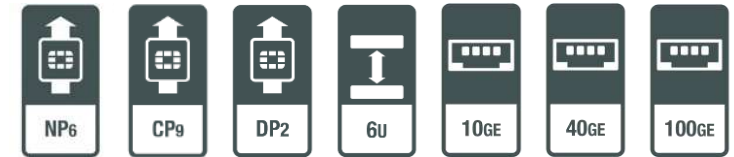

**315 Gbps**  
Firewall throughput



**60 / 100 Gbps**  
IPS Throughput

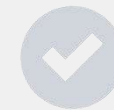

**Data Center / Service Provider**  
NGFW / ISFW / IPS / Mobile Security

**0.95/ 1 Mil**  
New Sessions/Sec

**160 Million**  
Concurrent Sessions



**50 / 60 Gbps**  
NGFW Throughput



**39.9 / 60 Gbps**  
SSL Inspection Throughput



**40 / 48 Gbps**  
Threat Protection Throughput



# FortiGate 7060E-8/-9\*

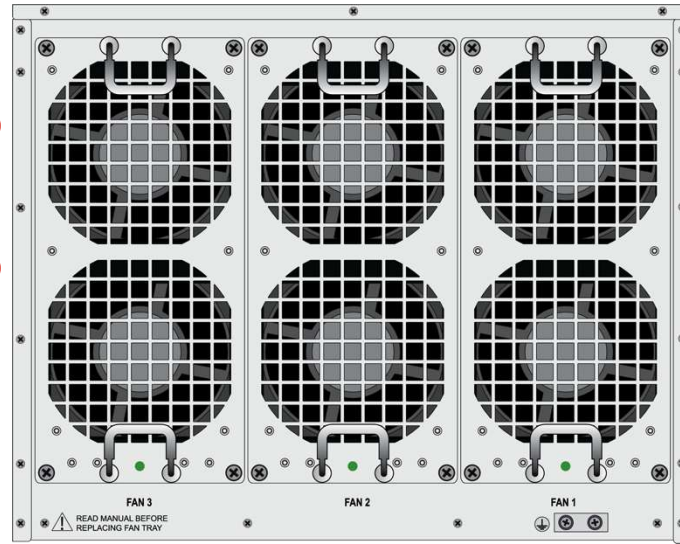
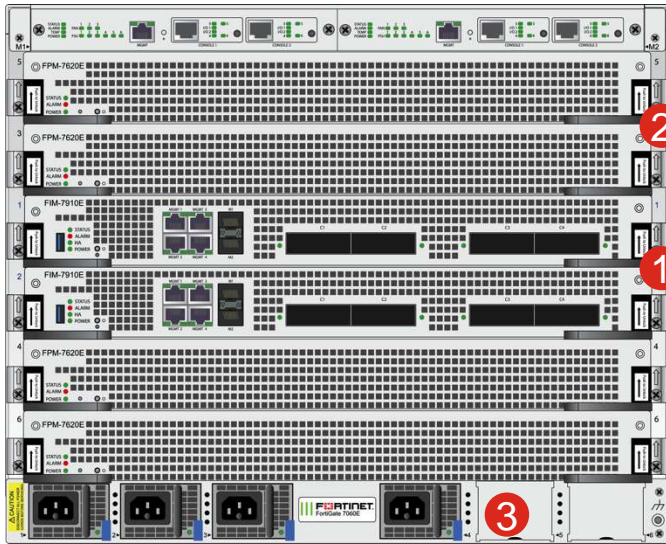

- ① 2 x I/O Module Slots
- ② 2 +2 optional Processing Module Slots
- ③ 4 +2 optional) Hot Swappable Redundant PS

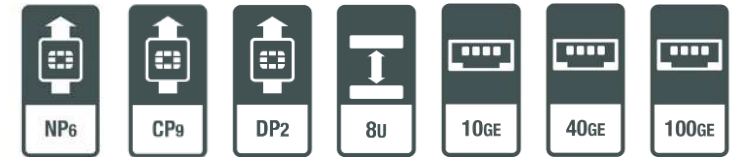

**630 Gbps**  
Firewall throughput



**120 / 200 Gbps**  
IPS Throughput

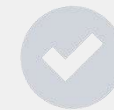

**Data Center / Service Provider**  
NGFW / ISFW / IPS / Mobile Security

**1.8 / 2 Mil**  
New Sessions/Sec

**320 Million**  
Concurrent Sessions



**100 / 120 Gbps**  
NGFW Throughput



**79.9 / 120 Gbps**  
SSL Inspection Throughput



**80 / 96 Gbps**  
Threat Protection Throughput



# FortiGate 7040E & 7060E Bundle

FG-7040E	FPM-7620E	FPM-7630E	FIM-7901E	FIM-7904E	FIM-7910E	FIM-7920E
<b>Network Interfaces</b>	-	-	32x GE/10 GE SFP/+	8x 40 GE QSFP+	4x 100 GE CFP2	4x 100 GE QSFP28
<b>Base Channel Interfaces</b>	-	-	2x 10 GE SFP+	2x 10 GE SFP+	2x 10 GE SFP+	2x 10 GE SFP+
<b>Management Interfaces</b>	-	-	4x GE RJ45	4x GE RJ45	4x GE RJ45	4x GE RJ45
<b>FG-7040E-8</b>	2				Any 2 FIMs	
<b>FG-7040E-9</b>		2			Any 2 FIMs	
<b>FG-7060E-8</b>	2 (+2)*				Any 2 FIMs	
<b>FG-7060E-9</b>		2 (+2)*			Any 2 FIMs	

\* Optional 2 more FPMs, order separately.





# FortiGate Virtual Appliance Series



## Agile Security for Virtual Environments



### FG-VM for Public Cloud



### FG-VM for Private Cloud

### Primary Benefits:

- ✓ Increased visibility and security within virtualized infrastructure better protect critical resources
- ✓ Ability to manage virtual appliances and physical appliances from a single pane of glass management platform reduces TCO
- ✓ Comprehensive Hypervisor support
- ✓ Feature-rich security and virtual networking support facilitate wide deployment and requirement options



# FortiGate-VM

	FG-VM00	FG-VM01	FG-VM02	FG-VM04	FG-VM08	FG-VM16	FG-VM32	FG-VMUL
<b>Private Cloud Platforms</b>								
VMware	✓	✓	✓	✓	✓	✓	✓	✓
Citrix	✓	✓	✓	✓	✓	✓	✓	✓
Microsoft Hyper-V	✓	✓	✓	✓	✓	✓	✓	✓
KVM	✓	✓	✓	✓	✓	✓	✓	✓
Open Source Xen	✓	✓	✓	✓	✓	✓	✓	✓
Nutanix AHV	✓	✓	✓	✓	✓	✓	✓	✓
<b>Public Cloud Platforms (BYOL)</b>								
Amazon AWS	✓	✓	✓	✓	✓	✓	✓	✓
Microsoft Azure	✓	✓	✓	✓	✓	✓	✓	
Google Cloud Platform	✓	✓	✓	✓	✓	✓	✓	✓
Oracle Cloud Infrastructure			✓	✓	✓	✓	✓	✓
AliCloud	✓	✓	✓	✓	✓	✓	✓	✓



# Transceivers & Breakout Cables

Max Dist.	SFP (GE)	XFP (10GE)	SFP+ (10GE)	QSFP+ (40GE)	CFP2 (100GE)	QSFP28 (100GE)
10 M			SP-CABLE-ADASFP+			
100 M	FN-TRAN-GC		FN-TRAN-SFP+GC	FN-TRAN-QSFP+SR FG-TRAN-QSFP+SR-BIDI (on OM3 MMF)	FG-TRAN-CFP2-SR10	FN-TRAN-QSFP28-SR4
150 M				FN-TRAN-QSFP+SR FG-TRAN-QSFP+SR-BIDI (on OM4 MMF)		
220 M	FN-TRAN-SX FR-TRAN-SX (62.5/125 micron MMF)		]			
300 M		FG-TRAN-XFPSR (OM3MMF)	FN-TRAN-SFP+SR			
500 M	FN-TRAN-SX FR-TRAN-SX (50/125 micron MMF)					
10 KM	FN-TRAN-LX FR-TRAN-LX	FG-TRAN-XFPLR	FN-TRAN-SFP+LR		FG-TRAN-CFP2-LR4	FN-TRAN-QSFP28-LR4
40 KM			FN-TRAN-SFP+ER			
90 KM	FR-TRAN-ZX					





# Transceivers & Breakout Cables

Max Dist.	SFP (GE)	XFP (10GE)	SFP+ (10GE)	QSFP+ (40GE)	CFP2 (100GE)
1 Meter Length				FG-TRAN-QSFP-4XSFP	FG-CABLE-SR10-SFP+
5 meter Length				FG-TRAN-QSFP-4SFP-5	FG-CABLE-SR10-SFP+5



# Transceivers

Models	Slot Type(s)	Transceivers Shipped
<b>FG-80E Series</b>	SFP	NIL
<b>FG-100EF</b>	SFP	NIL
<b>FG-140E/140E-POE</b>	SFP	NIL
<b>FG-200E/201E</b>	SFP	NIL
<b>FG-300E/301E, 400E/401E</b>	SFP	2x Fiber SX SFP modules (1000BaseSX)
<b>FG-500E/501E, FG-600E/601E</b>	SFP/+ SFP	2x Fiber SX SFP modules (1000BaseSX)
<b>FG-600D</b>	SFP/+ SFP	2x Fiber SX SFP modules (1000BaseSX)
<b>FG-800D</b>	SFP/+ SFP	2x Fiber SX SFP modules (1000BaseSX)

Models	Slot Type(s)	Transceivers Shipped
<b>FG-900D/1000D</b>	SFP/+ SFP	NIL
<b>FG-1100E</b>	QSFP+ SFP28 SFP/+ SFP	2x Fiber SX SFP modules (1000BaseSX)
<b>FG-1200D</b>	SFP/+ SFP	NIL
<b>FG1500D</b>	SFP/+ SFP	2x SFP+ (SR 10GE)
<b>FG-2000E</b>	SFP/+	2x SFP+ (SR 10GE)
<b>FG-2200E</b>	QSFP+ SFP28 SFP/+	
<b>FG-2500E</b>	SFP/+ SFP+ bypass	2x SFP+ (SR 10GE)



# Transceivers

Models	Slot Type(s)	Transceivers Shipped
<b>FG-3000D</b>	SFP/+	2x SFP+ (SR 10GE)
<b>FG-3100D</b>	SFP/+	2x SFP+ (SR 10GE)
<b>FG-3200D</b>	SFP/+	2x SFP+ (SR 10GE)
<b>FG-3300E</b>	QSFP+ SFP28 SFP/+	2x SFP+ (SR 10GE)
<b>FG-3400E</b>	QSFP28 SFP/+	2x SFP+ (SR 10GE)
<b>FG-3600E</b>	QSFP28 SFP/+	2x SFP+ (SR 10GE)
<b>FG-3700D/DX</b>	QSFP+ SFP/+ SFP+	2x SFP+ (SR 10GE)
<b>FG-3800D</b>	CFP2 QSFP+ SFP+	2x SFP+ (SR 10GE) FG-CABLE-SR10-SFP+

Models	Slot Type(s)	Transceivers Shipped
<b>FG-3960E</b>	QSFP28 SFP/+	2x SFP+ (SR 10GE)
<b>FG-3980E</b>	QSFP28 SFP/+	2x SFP+ (SR 10GE)
<b>FG-5001D/5001E</b>	QSFP+ SFP/+	2x SFP+ (SR 10GE)
<b>FCTL-5903C</b>	QSFP+ SFP/+	2x SFP+ (SR 10GE)



# Power Adapters & Redundant Power Supplies

Models	Spare/Redundant Power Supplies Option
FG/FWF-20C, 30D	SP-FG20C-PA-XX
FG/FWF-30D-POE	SP-FG30D-POE-PDC
FG/FWF-30E, FG/FWF-50E, FG/FWF-51E	SP-FG30E-PA-XX
FG-52E, FG-50E-2R, FG-30E-3G4G	SP-FG52E-PA-XX
FG/FWF-40C, 60C, 60D,60D-3G4G, 60E, 61E, 90D, FG-70D	SP-FG60C-PDC
FG/FWF-60D-POE	SP-FG60D-POE-PDC
FG-80D	SP-FG80D-PDC
FG-60E-POE, FG-80- POE, 81E-POE	SP-FG80E-POE-PDC
FG/FWF-90D-POE, FG-70D-POE	SP-FG90D-POE-PDC
FG/FWF-92D, FG- 90/91E	SP-FG92D-PDC

Models	Spare/Redundant Power Supplies Option
FG-100E, 100EF, 140E	FRPS-100 (max 2 units)
FG-140E-POE	FRPS-740-FG (max 2 units)
FG-200D, 240D, 200E	FRPS-100 (max 2 units)
FG-200D/240D/280- POE	FRPS-740-FG (max 2 units)
FG-300C	SP-FG310B-RPS FRPS-100 (max 4 units)
FG-300D	FRPS-100 (max 2 units)
FG-300/301E, FG- 400/401E, FG500/501E & FG- 600/601E	SP-FG300E-PS (additional as option)
FG-400D, 500D	FRPS-100 (max 2 units)
FG-600C, 800C	SP-FG600C-PS (additional as option)
FG-600C-DC, FG- 800C-DC	SP-FG600C-DC-PS (additional as option)









# Power Adapters & Redundant Power Supplies

Models	Spare/Redundant Power Supplies Option
<b>FG600D</b>	FRPS-100 (max 2 units)
<b>FG-620B, 621B</b>	SP-FG620B-RPS
<b>FG-800D</b>	SP-FG600C-PS (additional as option)
<b>FG-1000C, FG-1000C-DC</b>	SP-FG600C-PS, SP-FG600C-DC-PS (spare)
<b>FG-900D/1000D</b>	SP-FXX1000D
<b>FG-1200D, FG-1500D, FG-1500DT</b>	SP-FG1200D-PS
<b>FG-1240B, FG-3040B, FG-3140B</b>	SP-FG1240B-PS (spare)
<b>FG-3000D, FG-3100D, FG-3240C, 3200D</b>	SP-FG3000D-PS
<b>FG-3600C</b>	SP-FG3600C-PS (spare)

Models	Spare/Redundant Power Supplies Option
<b>FG-3400/3401E, FG-3600/3601E</b>	SP-FG3800D-PS (Spare)
<b>FG-3700D, FG-3700D-DC</b>	SP-FG3800D-PS, SP-FG3800D-DC-PS (spare)
<b>FG-3800D,3810D,3815D</b>	SP-FG3800D-PS (spare)
<b>FG-3810A, FG-3810A-DC</b>	SP-FG3810A-PS, SP-FG3810A-DC-PS (spare)
<b>FG-3950B, FG-3951B</b>	SP-FG3950B-PS (spare)
<b>FG-3960E</b>	FG-7040E-PS-AC (spare)
<b>FG-3980E</b>	FG-7040E-PS-DC (spare)
<b>FG-7030E</b>	FG-7040E-PS-AC
<b>FG-7040E</b>	FG-7040E-PS-DC
<b>FG-7060E</b>	FG-7060E-PS-AC



# Power Cords

<b>C14 Inlet</b>		SP-FGPCOR-US	SP-FGPCOR-UK	SP-FGPCOR-EU	SP-FGPCOR-AU
<b>C15 Inlet</b>		SP-FGPCORC15-US SP-FGPCORC15-JP	SP-FGPCORC15-UK	SP-FGPCORC15-EU	SP-FGPCORC15-AU
<b>*C6 Inlet</b>		SP-FG60CPCOR-US	SP-FG60CPCOR-UK	SP-FG60CPCOR-EU	SP-FG60CPCOR-AU
		<b>NEMA 5-15</b>	<b>BS 1363</b>	<b>CEE7 VII</b>	<b>AS/NZS 3112</b>
		<b>Type B</b>	<b>Type G</b>	<b>Type C, E, F, K</b>	<b>Type I</b>
					

[http://en.wikipedia.org/wiki/AC\\_power\\_plugs\\_and\\_sockets](http://en.wikipedia.org/wiki/AC_power_plugs_and_sockets)

<https://www.worldstandards.eu/electricity/plug-voltage-by-country/>

\* For FG-60C and FG/FWF-40C, FG/FWF-60D, 60E, 60F , 80F & FG/FWF-90D



# Hard Disks

	SP-D1000	SP-D1TB	SP-D1TC	SP-D2TC	SP-D2TE	SP-D3TC	SP-D2000	SP-D2000A	SP-DFWB2T	SP-D960
FortiManager			1000C, 3000C	3000C gen2, 4000D		300E, 400E, 2000E, 3000F	1000D			3900E
FortiAnalyzer		4000B	1000C, 2000B	1000C Gen2 2000B Gen2, 3000D		400E, 1000E, 2000E, 3000E, 3500F	1000D	3500D		3900E
FortiMail			2000B, 3000C	2000B Gen2, 3000D	2000E, 3000E, 3200E		1000D			
FortiWeb	1000D		1000C, 3000C	3000D, 4000C, 4000D			1000D		3000E 4000E	
FortiDB			1000C, 2000B	3000D			1000D			
FortiAuthenticator			1000C, 3000B	3000D	2000E, 3000E		1000D			
FortiCache			1000C, 3000C	1000C Gen2, 3000D	3000E		1000D			
FortiSandbox				3000D	3000E		1000D			







# FortiOS 7.0



# FortiOS Software Evolution

	2005	2007	2009/Q1	2009/Q3	2010/Q1	2011/Q3	2012/Q4
New Key functionalities	<b>V 2.8</b>	<b>V 3.0</b>	<b>V 4.0</b>	<b>V4.1</b>	<b>V 4.2</b>	<b>V 4.3</b>	<b>V 5.0</b>
	<ul style="list-style-type: none"> <li>• Antispam</li> <li>• NGFW</li> </ul>	<ul style="list-style-type: none"> <li>• SSL VPN</li> <li>• IM/P2P mgmt</li> </ul>	<ul style="list-style-type: none"> <li>• DLP</li> <li>• WAN Opt.</li> <li>• SSL Proxy</li> <li>• App Control</li> </ul>	<ul style="list-style-type: none"> <li>• Wireless ctrl</li> <li>• IPv6 UTM</li> <li>• SQL Logging</li> </ul>	<ul style="list-style-type: none"> <li>• New GUI</li> <li>• Network VM</li> </ul>	<ul style="list-style-type: none"> <li>• Token Server</li> <li>• ICAP</li> </ul>	<ul style="list-style-type: none"> <li>• Client reputation</li> <li>• Sandbox integration</li> <li>• Endpoint control</li> <li>• Device based policy</li> </ul>
	2014/Q2	2016/Q3	2017/Q1	2018/Q1	2019/Q2	2020/Q1	
New Key functionalities	<b>V 5.2</b>	<b>V 5.4</b>	<b>V 5.6</b>	<b>V 6.0</b>	<b>V 6.2</b>	<b>V 6.4</b>	
	<ul style="list-style-type: none"> <li>• FortiView</li> <li>• Deep Flow AV</li> <li>• Software performance optimization</li> </ul>	<ul style="list-style-type: none"> <li>• ATP Integration</li> <li>• SDN support</li> <li>• DNS Server</li> </ul>	<ul style="list-style-type: none"> <li>• Security Fabric Integration and Features</li> </ul>	<ul style="list-style-type: none"> <li>• Security Fabric Enhancements</li> <li>• Automation</li> <li>• Secure SD-WAN</li> </ul>	<ul style="list-style-type: none"> <li>• Fabric Connectors Enhancements</li> <li>• Additional Trigger and Actions for Automation</li> </ul>	<ul style="list-style-type: none"> <li>• SD-WAN Enhancements</li> <li>• Additional Fabric Integration</li> <li>• IoT and IPAM Services</li> </ul>	



# FortiOS V7.0

Configuration	Log & Report	Diagnostics	Monitoring	<b>Operation</b>	Systems Integration	Central Mgmt. and Provisioning	Cloud & SDN Integration
					Visibility	Automation	
Policy Modes	Device Identification		SSL inspection	<b>Policy and Control</b>	NAC	Compliance & Security Rating	
Firewall	Application Control		Anti-Malware	<b>Security</b>	Advanced Threat Protection (ATP)		
VPN	IPS & DoS	Web Filtering	Email Filtering				
SD WAN	Explicit Proxy	IPv6	High Availability	<b>Networking</b>	Wireless Controller	Switch Controller	WAN Interface Manager
Routing/NAT	L2/Switching	Offline Inspection	Essential Network Services				
Physical Appliance (+SPU)	Virtual System	Hypervisor	Cloud	<b>Platform Support</b>	<b>Security Fabric</b>		

\* Features availability may varied by models

\* Features availability may varied by models



FortiManager Cloud				•
FortiAnalyzer Cloud				•
Fortinet SOCaaS <b>NEW</b>				•
SD-WAN Overlay Controller VPN Service				•
SD-WAN Cloud Assisted Monitoring				•
SD-WAN Orchestrator Entitlement				•
FortiConverter Service			•	•
FortiGuard IoT Detection Service			•	•
FortiGuard Industrial Service			•	•
FortiGuard Security Rating Service			•	•
FortiGuard Anti-Spam Service		•	•	•
FortiGuard Web & Video <sup>2</sup> <b>NEW</b> Filtering Service		•	•	•
FortiGuard Advanced Malware Protection (AMP) - Antivirus, Mobile Malware, Botnet, CDR, Virus Outbreak Protection and FortiSandbox Cloud Service	•	•	•	•
FortiGuard IPS Service	•	•	•	•
FortiGuard App Control Service	•	•	•	•
FortiCare (incl. Internet Service DB, Client ID DB, IP Geography DB, Malicious URL DB, URL Whitelist DB)	24x7	24x7	24x7	ASE <sup>1</sup>
<b>Bundles</b>	<b>Threat Protection</b>	<b>Unified Threat Protection</b>	<b>Enterprise Protection</b>	<b>360</b>



The FortiAnalyzer logo, which consists of a black circle with a light blue quarter-circle segment inside.

# FortiAnalyzer



# Introducing FortiAnalyzer



Appliance



Virtual Machine



Hosted



Cloud



## Logging, reporting and analysis from multiple Fortinet devices



Centralized Search and Reports



Real-time and Historical Views into Network Activity



Scans security logs using FortiGuard IOC Intelligence for APT detection



Light-weight Event Management



Seamless Integration with the Fortinet Security Fabric

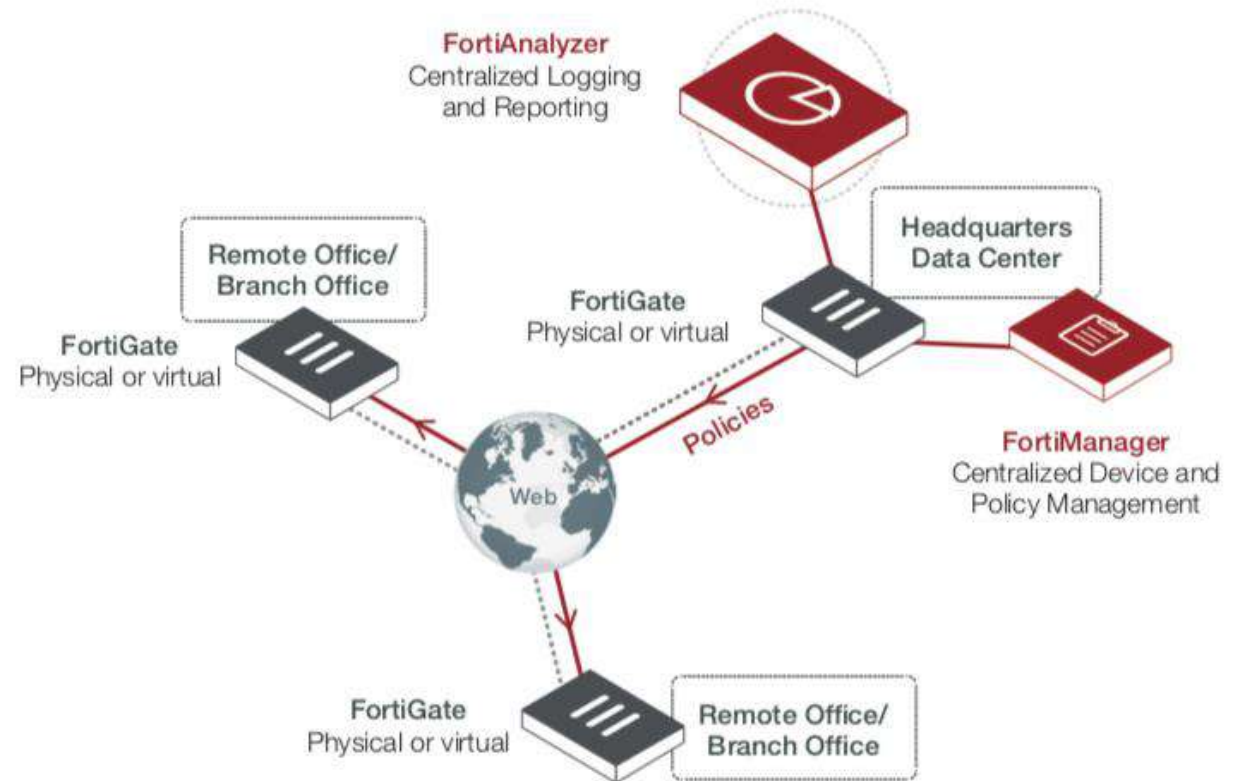

# FortiAnalyzer Series

	FAZ-150G	FAZ-300F	FAZ-800F	FAZ-1000F	FAZ-3000G	FAZ-3500G	FAZ-3700F
<b>GB/Day</b>	50	150	300	660	3,000	5,000	8,300
<b>Analytic Sustained Rate (logs/sec)</b>	1,500	4,500	8,250	20,000	42,000	60,000	100,000
<b>Collector Sustained Rate (logs/sec)</b>	3,000	6,750	12,000	30,000	60,000	90,000	150,000
<b>Max. Devices/ADOMs</b>	50	180	800	2,000	4,000	10,000	10,000
<b>Max Number of Days Analytics</b>	38	28	30	34	30	38	60
<b>Total Interfaces</b>	2x GE RJ45	2x GE RJ45, 2x GE SFP	4x GE RJ45, 2x GE SFP	2x GE RJ45, 2x 10GE SFP+	2x GE RJ45, 2x 25GE SFP28	2x GE RJ45, 2x 25GE SFP28	2x GE RJ45, 2x 10GE SFP+
<b>Storage capacity</b>	2x 2 TB	2x 4 TB	4x 4 TB	8x 4TB	16x 4TB	24x 4TB	60x 4TB
<b>RAID support</b>	Yes (0,1)	Yes (0,1)	Yes (0,1,5,10)	Yes, (RAID 0, 1, 5, 6, 10, 50, 60)	Yes, (RAID 0, 1, 5, 6, 10, 50, 60)	Yes, (RAID 0, 1, 5, 6, 10, 50, 60)	Yes, (RAID 0, 1, 5, 6, 10, 50, 60)





# FortiAnalyzer VM-Series

	FAZ-VM-BASE	FAZ-VM-GB1	FAZ-VM-GB5	FAZ-VM-GB25	FAZ-VM-GB100	FAZ-VM-GB500	FAZ-VM-GB2000
<b>GB/Day</b>	1	+1	+5	+25	+100	+500	+2,000
<b>Max. Devices/ADOMs</b>	10,000	10,000	10,000	10,000	10,000	10,000	10,000
<b>Storage Capacity</b>	500 GB	+500 GB	+3 TB	+10 TB	+24 TB	+48 TB	+100 TB
<b>Network Interface (Min/Max)</b>	1 / 4						
<b>vCPU (Min/Max)</b>	4 / Unlimited						
<b>Memory Support (Min/Max)</b>	8 GB / Unlimited						





# FortiManager



# Introducing FortiManager



Appliance



Virtual Machine



Hosted



Cloud



Tools that effectively manage any size Fortinet security infrastructure, from a few to thousands of appliances



Easy centralized configuration, policy-based provisioning, update management, and end-to-end network monitoring



Segregate management of large deployments with ADOMs



Single-pane-of-glass manages more than firewalls



Script and automation support with JSON/XML APIs with external systems

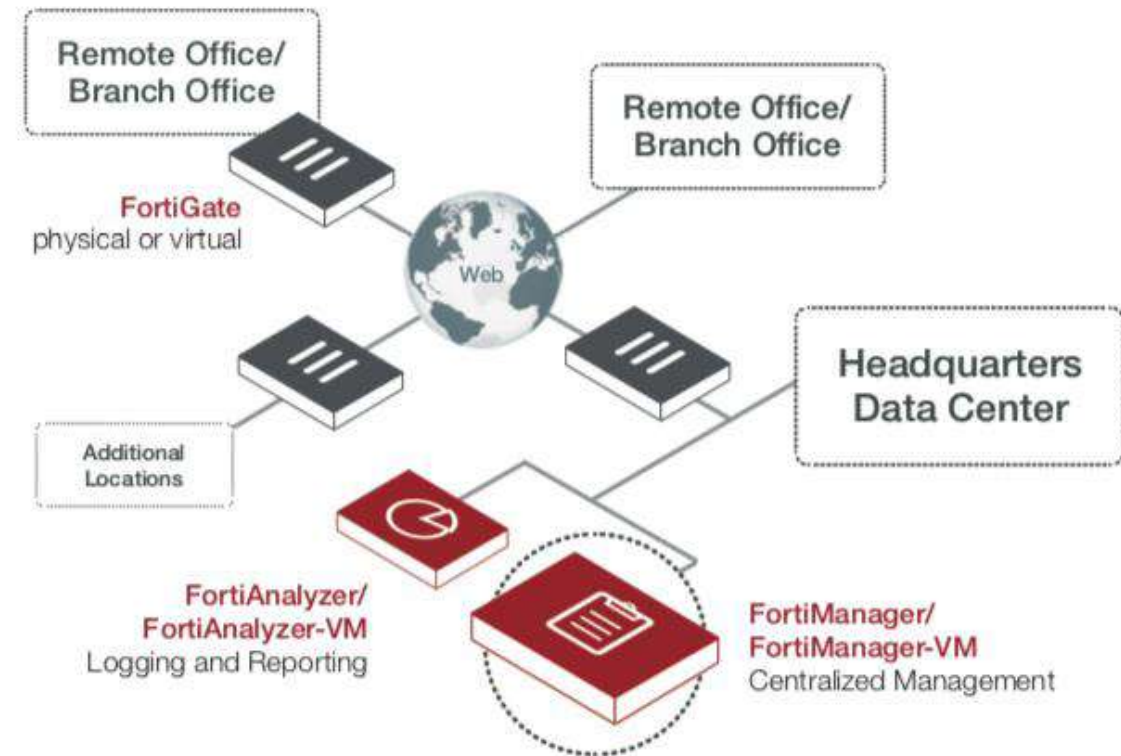

# FortiManager Series

	FMG-200G	FMG-300F	FMG-1000F	FMG-2000E	FMG-3000G	FMG-3700F
<b>Max. Devices/VDOMs<sup>1</sup></b>	30	100	1,000	1,200	4,000+	10,000+
<b>Sustained Log Rates</b>	50	50	50	50	150	150
<b>GB/Day</b>	2	2	2	2	10	10
<b>Interfaces</b>	4x GE RJ45	4x GE RJ45, 2x GE SFP	4x GE RJ45, 2x SFP+	4x GE RJ45, 2x SFP+	2x GE RJ45, 2x 25GE SFP28	2x GE RJ45, 2x 10 GE SFP+
<b>Storage capacity</b>	2x 4TB	4x 4TB	8x 4TB	12x 3TB	16x 4TB	60x 4TB

1 Each Virtual Domain (VDOM) operating on a physical or virtual device counts as one (1) licensed network device



# FortiManager-VM Series

	FMG-VM-BASE	FMG-VM-10-UG	FMG-VM-100-UG	FMG-VM-1000-UG	FMG-VM-5000-UG
Max. Devices/VDOMs <sup>1</sup>	10	+10	+100	+1,000	+5,000
Storage Capacity	100 GB	200 GB	1 TB	4 TB	8 TB
GB Logs/day	1	2	5	10	25
Max. Virtual NICs (Min/Max)			1 / 4		
vCPU Support (Min/Max)			4 / Unlimited		
Storage capacity (Min/Max)			100 GB / 16 TB		
Memory Support (Min/Max)			8 GB / Unlimited for 64-bit		

<sup>1</sup> Each Virtual Domain (VDOM) operating on a physical or virtual device counts as one (1) licensed network device





# FortiSIEM





# Introducing FortiSIEM



Appliance



Virtual Machine



Cloud



## Unified event correlation and risk management for modern networks



Asset Self-Discovery



Rapid Integrations and Scalability



Automated Workflow with Remediation Library



Single Pane of Glass to quickly remediate service issues



Multi-tenancy for role-based access to a unified platform





# FortiAuthenticator



# Introducing FortiAuthenticator



Appliance



Virtual Machine



Cloud



## Identity Management, User Access Control and multi-factor identification



Transparently identify network users and enforce identity-driven policy on a Fortinet-enabled enterprise network



Seamless secure two-factor/OTP authentication across the organization in conjunction with FortiToken



Certificate management for enterprise wireless and VPN deployment



Guest management for wired and wireless network security



Single Sign On capabilities for both internal and cloud networks

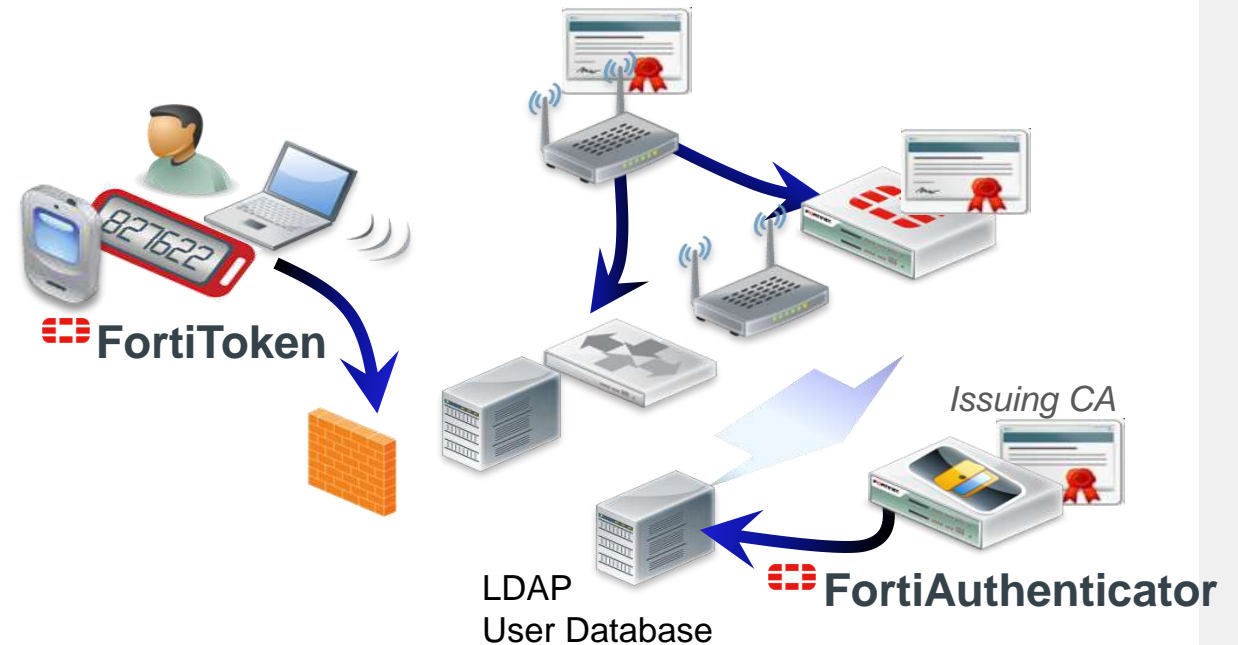

# FortiAuthenticator Series

	FAC-200E	FAC-300F	FAC-400E	FAC-800F	FAC-2000E	FAC-3000E
<b>Max. Local + Remote Users</b>	500	1,500	2,000	8,000	20,000	40,000
<b>Max. FortiTokens</b>	1,000	3,000	4,000	16,000	40,000	80,000
<b>Max. NAS Devices</b>	166	500	666	2,666	6,666	26,666
<b>Max. User Groups</b>	50	150	200	800	2,000	4,000
<b>Max. CA Certificates</b>	10	10	10	50	50	50
<b>Max. User Certificates</b>	2,500	7,500	10,000	40,000	50,000	50,000
<b>Interfaces</b>	4x GE RJ45	4x GE RJ45	4x GE RJ45	4x GE RJ45 2x GE SFP	4x GE RJ45 2x GE SFP	4x GE RJ45 2x GE SFP
<b>Storage Capacity</b>	1 x 1 TB	2 x 1 TB	2 x 1 TB	2 x 2 TB	2 x 2 TB	2 x 2 TB



# FortiAuthenticator-VM Series

	FAC-VM Base	FAC-VM-100-UG	FAC-VM-1000-UG	FAC-VM-10000-UG
Max. Local and/or Users	100	+100	+1,000	+10,000
Max. FortiTokens	200	+200	+2,000	+20,000
Max. NAS Devices	33	+33	+333	+3,333
Max. User Groups	10	+10	+100	+1,000
Max. CA Certificates	5	+5	+50	+500
Max. User Certificates	100	+100	+1,000	+10,000
Interfaces (Min/Max)			1 / 4	
Virtual CPUs (Max)			64	
Storage Capacity (Min Max)			60 GB / 16 TB	













# FortiAP



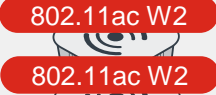

# FortiAP Family

4x4:4	3 Radio		 <b>FAP-432F</b>	 <b>FAP-431/433F</b>
	2 Radio			 <b>FAP-421/423E</b>
3x3:3				 <b>FAP-321E</b>
	2x2:2	3 Radio	 <b>FAP-23JF</b>	 <b>FAP-234F</b>
2 Radio		 <b>FAP-C24JE</b>	 <b>FAP-224E</b>  <b>FAP-222E</b>	 <b>FAP-221/223E</b>
		Wall Plate	Outdoor	Indoor



# FortiAP 431/433F

Indoor | 802.11ax | Triple Radio | 4x4



- ① 1 x 2.5GE RJ45 Interface
- ② 1 x GE RJ45 Interface
- ③ 1x RS-232 RJ45 Serial Port



- ① 1 x 2.5GE RJ45 Interface
- ② 1 x GE RJ45 Interface
- ③ 1x RS-232 RJ45 Serial Port



## FAP-431F

## FAP-433F

Target Environment	High density, high performance indoor	High density, high performance indoor
Number of Antenna	5 Internal + 1 BLE Internal	5 External (RP-SMA) + 1 BLE Internal
Rx / Tx	4x4	4x4
Radio 1	2.4 GHz b/g/n/ax (1,147 Mbps)	2.4 GHz b/g/n/ax (1,147 Mbps)
Radio 2	5GHz a/b/g/n/ac/ax (2,402 Mbps)	5GHz a/b/g/n/ac/ax (2,402 Mbps)
Radio 3	2.4/5.0 GHz (scan only)	2.4/5.0 GHz (scan only)
PoE	802.3at	802.3at



# FortiAP 432F

Outdoor | 802.11ax | Tri-Radio | 4x4



- ① 1x 2.5GE RJ45
- ② 1 x GE RJ45 (802.3af PoE PSE)
- ③ 1x RS-232 RJ45 Serial Port



Target Environment	High density indoor
Number of Antenna	4 x dual band, 1 x dual band scanning, 1 x single band 2.4 GHz BLE/ZigBee
Rx / Tx	4 x 4
Radio 1	2.4 GHz b/g/n/ax (1,147 Mbps)
Radio 2	5GHz a/b/g/n/ac/ax (2,402 Mbps)
Radio 3	2.4/5.0 GHz (scan only)
PoE	802.3af/at

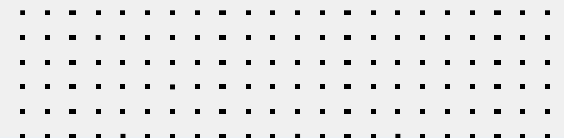

# FortiAP 421/423E

Indoor | 802.11ac W2 | Dual Radio | 4x4



- ① 2 x GE RJ45 Interface
- ② 1x RS-232 RJ45 Serial Port



- ① 2 x GE RJ45 Interface
- ② 1x RS-232 RJ45 Serial Port



## FAP-421E

## FAP-423E

Target Environment	High density, high performance indoor	High density, high performance indoor
Number of Antenna	8 internal	8 External
Rx / Tx	4x4	4x4
Radio 1	2.4 GHz b/g/n (600 Mbps)	2.4 GHz b/g/n (600 Mbps)
Radio 2	5GHz a/b/g/n/ac (1733 Mbps)	5GHz a/b/g/n/ac (1733 Mbps)
PoE	802.3at	802.3at



# FortiAP 321E

Indoor | 802.11ac W2 | Dual Radio | 3x3



- ① 1x GE RJ45
- ② 1x RS-232 RJ45 Serial Port



Target Environment	Medium density indoor
Number of Antenna	6 Internal (RP-SMA) + 1 BLE internal
Rx / Tx	3 x 3 (Radio 1), 2 x 2 (Radio 2)
Radio 1	2.4 GHz b/g/n (450 Mbps)
Radio 2	5GHz a/n/ac (1,300 Mbps)
PoE	802.3af/at

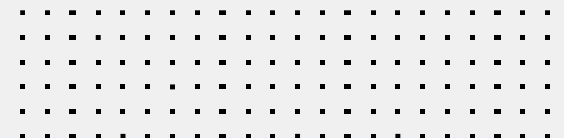

# FortiAP 231E

Indoor | 802.11ac W2 | Triple Radio | 2x2



- ① 2x GE RJ45
- ② 1x RS-232 RJ45 Serial Port



Target Environment	Medium density indoor
Number of Antenna	6 Internal + 1 BLE internal
Rx / Tx	2 x 2
Radio 1	2.4/5.0 GHz (high band) a/b/g/n/ac (867 Mbps)
Radio 2	5GHz a/n/ac (867 Mbps)
Radio 3	2.4/5.0 GHz b/g/n (400 Mbps)
PoE	802.3af/at

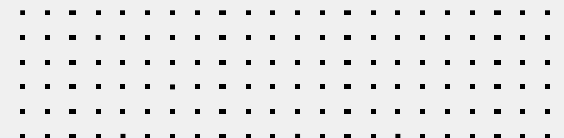

# FortiAP 231F

Indoor | 802.11ax | Triple Radio | 2x2



- ① 2x GE RJ45
- ② 1x RS-232 RJ45 Serial Port



Target Environment	Medium density indoor
Number of Antenna	3 Dual band Internal + 1 BLE/ZigBee
Rx / Tx	2 x 2
Radio 1	2.4 GHz b/g/n/ax (574 Mbps)
Radio 2	5GHz a/n/ac/ax (1201 Mbps)
Radio 3	2.4/5.0 GHz (scan only)
PoE	802.3af/at

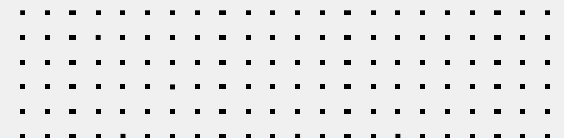



# FortiAP 234F

Outdoor | 802.11ax | Triple Radio | 2x2



- ① 2x GE RJ45
- ② 1x RS-232 RJ45 Serial Port



Target Environment	Medium density Outdoor
Number of Antenna	2 x dual band, 1 x dual band scanning, 1 x single band 2.4 GHz BLE/ZigBee
Rx / Tx	2 x 2
Radio 1	2.4 GHz b/g/n/ax (574 Mbps)
Radio 2	5GHz a/n/ac/ax (1200 Mbps)
Radio 3	2.4/5.0 GHz (scan only)
PoE	802.3af/at

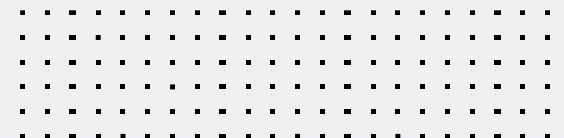

# FortiAP 221/223E

Indoor | 802.11ac W2 | Dual Radio | 2x2



① 1 x GE RJ45 Interface



① 1 x GE RJ45 Interface



## FAP-221E

## FAP-223E

Target Environment

Medium density indoor

Medium density indoor

Number of Antenna

4 internal

4 External

Rx / Tx

2x2

2x2

Radio 1

2.4 GHz b/g/n  
(300 Mbps)

2.4 GHz b/g/n  
(300 Mbps)

Radio 2

5GHz a/b/g/n/ac  
(867 Mbps)

5GHz a/b/g/n/ac  
(867 Mbps)

PoE

802.3af

802.3af



# FortiAP 222/224E

Outdoor | 802.11ac W2 | Dual Radio | 2x2



① 1 x GE RJ45 Interface



① 1 x GE RJ45 Interface



## FAP-222E

## FAP-224E

Target Environment

High density Outdoor, IP67 rated

High density Outdoor, IP67 rated

Number of Antenna

4 External (N-Type) + 1 BT/BLE External

4 Internal+ 1 BT/BLE Internal

Rx / Tx

2 x 2

2 x 2

Radio 1

2.4 GHz b/g/n  
(400 Mbps)

2.4 GHz b/g/n  
(400 Mbps)

Radio 2

5GHz a/n/ac  
(867 Mbps)

5GHz a/n/ac  
(867 Mbps)

PoE

802.3af/at

802.3af/at



# FortiAP C24JE

Wall Plate | 802.11n/ac W2 | 2x2



- ① 1x GE RJ45 802.3at PoE (PD)
- ② 1x GE RJ45 802.3af PoE (PSE)
- ③ 2x GE RJ45
- ④ 2x GE RJ45 Pass-through (in and out)
- ⑤ 1x RS-232 RJ45 Serial Port



<b>Target Environment</b>	Indoor Wall Plate AP for hotel and dorm rooms
<b>Number of Antenna</b>	4 Internal
<b>Rx / Tx</b>	2 x 2
<b>Radio 1</b>	2.4 GHz b/g/n (300 Mbps)
<b>Radio 2</b>	5GHz a/n/ac (867 Mbps)
<b>PoE</b>	802.3af

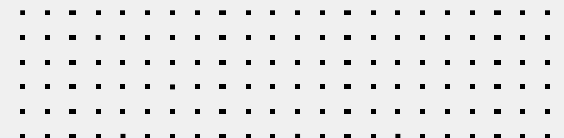

# FortiAP C24JF

Wall Plate | 802.11ax | 2x2



- ① 1x GE RJ45 802.3at PoE (PD)
- ② 1x GE RJ45 802.3af PoE (PSE)
- ③ 2x GE RJ45
- ④ 2x GE RJ45 Pass-through (In and out)
- ⑤ 1x RS-232 RJ45 Serial Port





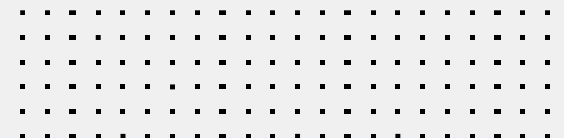



<b>Target Environment</b>	Indoor Wall Plate AP for hotel and dorm rooms
<b>Number of Antenna</b>	4 x single band WiFi, 1 x dual band scanning, 1 x single band 2.4 GHz BLE/ZigBee
<b>Rx / Tx</b>	2 x 2
<b>Radio 1</b>	2.4 GHz b/g/n/ax (574 Mbps)
<b>Radio 2</b>	5GHz a/n/ac/ax (1201 Mbps)
<b>Radio 3</b>	2.4/5.0 GHz (scan only)
<b>PoE</b>	802.3af/at



# FortiAP Family Overview

U-Series

Configuration	Radio	Resiliency	Wall Plate	Outdoor	Indoor
4x4:4	3	Resiliency			 802.11ax <b>FAP-U431/433F</b>
			 802.11ac W2 <b>FAP-U422EV</b>	 802.11ac W2 <b>FAP-U421/423EV</b>	
3x3:3	2				 802.11ac W2 <b>FAP-U321/323EV</b>
2x2:2			 802.11ac <b>FAP-U24JEV</b>	 802.11ac W2 <b>FAP-U221/223EV</b>	



# FortiAP U221/223EV

Indoor | 802.11ac W2 | Dual Radio | 2x2



① 1 x GE RJ45 Interface



① 1 x GE RJ45 Interface



## FAP-U221E

## FAP-U223E

Target Environment	Medium density indoor with Security	Medium density indoor with Security
Number of Antenna	4 Internal + Bluetooth	4 External + Bluetooth
Rx / Tx	2x2	2x2
Radio 1	2.4 GHz b/g/n (300 Mbps)	2.4 GHz b/g/n (300 Mbps)
Radio 2	5 GHz a/n/ac (867 Mbps)	5 GHz a/n/ac (867 Mbps)
PoE	802.3af/at	802.3af/at



# FortiAP U321/323EV

Indoor | 802.11ac W2 | Dual Radio | 3x3

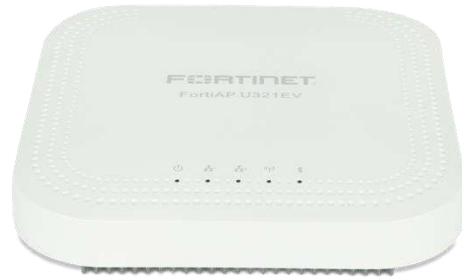

① 2 x GE RJ45 Interface



① 2 x GE RJ45 Interface



## FAP-U321EV

## FAP-U323EV

Target Environment	High density and performance Indoor AP	High density and performance Indoor AP
Number of Antenna	6 Internal + 1 Bluetooth	6 External+ 1 Bluetooth
Rx / Tx	3x3	3x3
Radio 1	2.4 GHz b/g/n (450 Mbps)	2.4 GHz b/g/n (450 Mbps)
Radio 2	5GHz a/n/ac (2340 Mbps)	5GHz a/n/ac (2340 Mbps)
PoE	802.3at/af	802.3at/af





# FortiAP U421/423EV

Indoor | 802.11ac W2 | Dual Radio | 4x4



① 2 x GE RJ45 Interface



① 2 x GE RJ45 Interface



## FAP-U321EV

## FAP-U323EV

Target Environment	High density, high performance indoor	High density, high performance indoor
Number of Antenna	8 internal + 1 Bluetooth	8 External + 1 Bluetooth
Rx / Tx	4x4	4x4
Radio 1	2.4 GHz b/g/n (800 Mbps)	2.4 GHz b/g/n (800 Mbps)
Radio 2	5GHz a/b/g/n/ac (3460 Mbps)	5GHz a/b/g/n/ac (3460 Mbps)
PoE	802.3at	802.3at



# FortiAP U431/433F

Indoor | 802.11ax | Triple Radio | 4x4



- ① 1 x 2.5GE RJ45 Interface
- ② 1 x GE RJ45 Interface



- ① 1 x 2.5GE RJ45 Interface
- ② 1 x GE RJ45 Interface



## FAP-U431F

## FAP-U433F

<b>Target Environment</b>	High density, high performance indoor	High density, high performance indoor
<b>Number of Antenna</b>	10 internal + 1 BT/BLE Internal	10 External (RP-SMA) + 1 BT/BLE Internal
<b>Rx / Tx</b>	4x4	4x4
<b>Radio 1</b>	5 GHz a/n/ac/ax (4,804 Mbps)	5 GHz a/n/ac/ax (4,804 Mbps)
<b>Radio 2</b>	2.4/5 GHz a/b/g/n/ac/ax (4,804 Mbps)	2.4/5 GHz a/b/g/n/ac/ax (4,804 Mbps)
<b>Radio 3</b>	2.4/5 GHz b/g/n/ac (300 Mbps)	2.4/5 GHz b/g/n/ac (300 Mbps)
<b>PoE</b>	802.3af/at	802.3af/at



# FortiAP U422EV

Outdoor | 802.11n/ac W2 | 4x4



- ① 2x GE RJ45
- ② 1x RS-232 RJ45 Serial Port



Target Environment	High Performance Outdoor
Number of Antenna	8 External (Type N) + 1 BT/BLE Internal
Rx / Tx	4 x 4
Radio 1	2.4 GHz b/g/n (600 Mbps)
Radio 2	5GHz a/n/ac (3,466 Mbps)
PoE	802.3at/Proprietary

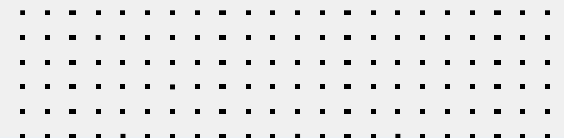

# FortiAP U24JEV

Wall Plate | 802.11n/ac | 2x2



- ① 4x GE RJ45 (inc. (1x 802.3at PoE PD)
- ② 1x RJ45 GE 802.3af PoE PSE
- ③ 1x RJ45 pass-thru



Target Environment	Indoor Wall Plate AP for hotel and dorm rooms
Number of Antenna	2 Internal + 1 BLE Internal
Rx / Tx	2 x 2
Radio 1	2.4/5 GHz a/b/g/n/ac (867 Mbps)
Radio 2	-
PoE	802.3af/at

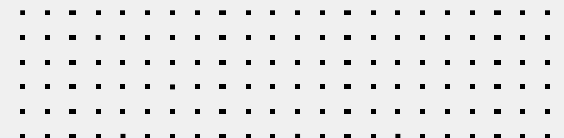

# Hardware Overview – FortiAP U-Series

Indoor

	FAP-U321/323EV	FAP-U321/323EV	FAP-U421/423EV
<b>Form Factor</b>	Indoor, rectangular	Indoor, rectangular	Indoor, rectangular
<b>Rx / Tx</b>	2x2	3x3	4x4
<b>Radio 1</b>	5GHz a/n/ac (867 Mbps)	5GHz a/n/ac (2340Mbps)	5GHz a/n/ac (3460 Mbps)
<b>Radio 2</b>	2.4 GHz b/g/n (300 Mbps)	2.4 GHz b/g/n (450 Mbps)	2.4 GHz b/g/n (800 Mbps)
<b>PoE</b>	802.3af/at	802.3af/at	802.3af/at
<b>Antennas</b>	4 internal / external + BT	6 internal / external + BT	8 internal / external + BT
<b>Ethernet Interfaces</b>	1 x GE RJ45	2 x GE RJ45	2 x GE RJ45



# FortiAP Power Adaptors

	Power Supply Type	Power supply shipped with unit	(Spare) Power supply order SKU	GPI-115 Support	GPI-130 Support
FAP-11C	AC	✓ (Integrated power supply)	N/A	-	-
FAP-14C	AC	✓	SP-FAP14C-PA-XX	-	-
FAP-21D	AC	✓ (USB powered)	N/A	-	-
FAP-24D	PoE 802.3af	-	SP-FG20C-PA-XX	✓	-
FAP-25D	AC	✓ (Integrated power supply)	N/A	-	-
FAP-28C	AC	✓	SP-FG20C-PA-XX	-	-
FAP-112B	PoE Proprietary	✓	SP-FAP112B-PA (includes PoE injector) + SP-ADAPTORPLUG-01-XX	-	-
FAP-112D	PoE Proprietary	✓	SP-FAP222B-PA (includes PoE injector) + SP-ADAPTORPLUG-01-XX	-	-
FAP-210B	PoE 802.3af	✓	SP-FAP220B-PA-XX	✓	-
FAP-220B	PoE 802.3af	✓	SP-FAP220B-PA-XX	✓	-



# FortiAP Power Adaptors

	Power Supply Type	Power supply shipped with unit	(Spare) Power supply order SKU	GPI-115 Support	GPI-130 Support
FAP-221B/223B	PoE 802.3af	-	SP-FAP221B-PA + SP-ADAPTORPLUG-01-XX	✓	-
FAP-221C/223C	PoE 802.3af	-	SP-FG20C-PA-XX	✓	-
FAP-221E/223E	PoE 802.3af	-	SP-FAP200-PA-XX	✓	-
FAP-222B/222C	PoE 802.3at/POE Proprietary	✓	SP-FAP222B-PA (includes PoE injector) + SP-ADAPTORPLUG-01-XX	-	-
FAP-222E	PoE 802.3at	✓	TBC	-	✓
FAP-224D	PoE 802.3af	✓	SP-FAP221B-PA + SP-ADAPTORPLUG-01-XX	✓	-
FAP-224E	PoE 802.3at	-	N/A	-	✓
FAP-320B	PoE 802.3af	-	SP-FG20C-PA-XX	✓	-
FAP-320C	PoE 802.3af	-	SP-FG20C-PA-XX	✓	-
FAP-321C	PoE 802.3af	-	SP-FG20C-PA-XX	✓	-
FAP-421E/423E	PoE 802.3at	-	SP-FAP400-PA-XX	-	✓







# FortiAP S-Series Power Adaptors

	Power Supply Type	Power supply shipped with unit	(Spare) Power supply order SKU	GPI-115 Support	GPI-130 Support
FAP-S221E/223E	PoE 802.3af	-	SP-FAP200-PA-XX	✓	-
FAP-S311C/313C	PoE 802.3at	-	SP-FG20C-PA-XX	✓	✓ (to use USB port)
FAP-S321C/323C FAP-S321CR/323C	PoE 802.3at	-	SP-FG20C-PA-XX	-	✓
FAP-S322C/S322CR	PoE 802.3at	✓ (PoE injector + Power Adapter)	TBC	-	✓
FAP-S421E/423E	PoE 802.3at	-	SP-FAP400-PA-XX	-	✓
FAP-S422E	PoE 802.3at	✓ (PoE injector + Power Adapter)	TBC	-	✓



# FortiAP U-Series Power Adaptors

	Power Supply Type	Power supply shipped with unit	(Spare) Power supply order SKU	GPI-115 Support	GPI-130 Support
FAP-U221EV/223EV	PoE 802.3af	-	SP-FAP200-PA-XX	✓	-
FAP-U321EV/323EV	PoE 802.3af PoE 802.3at	-	SP-FAP200-PA-XX	-	✓
FAP-U431F/433F	PoE 802.3at	-	SP-FAP400-PA-XX	-	✓
FAP-U421EV/423EV	PoE 802.3af PoE 802.3at	-	SP-FAP400-PA-XX	-	✓
FAP-U422EV	Proprietary 802.3at	✓ (Proprietary PoE injector)	-	-	✓



# FortiAP C-Series Power Adaptors

	Power Supply Type	Power supply shipped with unit	(Spare) Power supply order SKU	GPI-115 Support	GPI-130 Support
FAP-C220C/225C	PoE 802.3af	-	-	✓	-
FAP-C23JD	PoE 802.3af (wall Plate)	-	-	-	-
FAP-C24JE	PoE 802.3af (wall Plate)	-	-	-	-



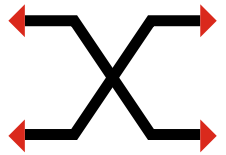

# FortiSwitch



# Introducing FortiSwitch



Appliance



Access level Gigabit Switches with ease of use and low cost of ownership

 FSW-1xxD/E Series



 FSW-2xxD/E Series



 FSW-4xxD Series



 FSW-5xxD Series































Outstanding price, performance, and scalability to organizations with diverse operational needs.

## Primary Benefits:

- ✓ High Port Density
- ✓ Integrated Power Over Ethernet
- ✓ Connect Access Points, Peripherals, Cameras, Phones
- ✓ Create an integrated, secure network



# FortiSwitch Family

48 ports	 FSW-148F-POE	 FSW-248E-FPOE	 FSW-448D/E-FPOE	 FSW-548D-FPOE					
	 FSW-148E/F-POE	 FSW-248E-POE	 FSW-448D/E-POE						
	 FSW-148E/F	 FSW-248D	 FSW-448D/E	 FSW-548D	 FSW-1048E				
26 / 32 ports			 FSW-M426E-FPOE		 FSW-3032E FSW-3032D				
	24 ports	 FSW-124E/F-FPOE	 FSW-224D-FPOE	 FSW-424E-FPOE	 FSW-524D-FPOE				
 FSW-124E/F-POE		 FSW-224E-POE	 FSW-424E-POE						
 FSW-124E/F		 FSW-224E	 FSW-424E FSW-424E-Fiber	 FSW-524D	 FSW-1024D				
8 ports	 FSW-108E-FPOE								
	 FSW-108E-POE								
	 FSW-108E								
<b>100 Series</b>		<b>200 Series</b>		<b>400 Series</b>		<b>500 Series</b>		<b>1000/3000 Series</b>	
+ 4x 10GE SFP+ uplinks (148F Series) + 2 or 4x GE SFP uplinks (rest)		+ 4x GE SFP uplinks		+ 2 or 4 x10GE SFP+ uplinks		+ 4x 10GE SFP+ and 2x 40GE stacking		Data Center Switches	

# FortiSwitch 108E Series



- ① 7x GE RJ45 Ports
- ② 1x GE POE-PD RJ45 Ports
- ③ 2x GE SFP slots



- ① 4x GE RJ45 Ports
- ② 4x GE RJ45 POE+ Ports
- ③ 2x GE SFP slots



- ① 8x GE RJ45 POE+ Ports
- ② 2x GE SFP slots



	FS-108E	FS-108E-POE	FS-108E-FPOE
Switch Capacity	20 Gbps	20 Gbps	20 Gbps
MAC Address Storage	8K	8K	8K
Network Latency (64b)	4 ms	4 ms	4 ms
VLANs Supported	4K	4K	4K
Max LAG Size	up to 8 ports	up to 8 ports	up to 8 ports
PoE Power Budget	-	65 W	130 W
Power Supply	Single PS/PoE-PD	Single PS	Single PS

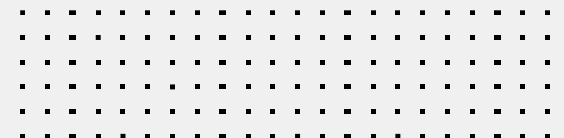

# FortiSwitch 124E Series



- ① 24 x GE RJ45 Ports
- ② 4x GE SFP slots



- ① 12x GE RJ45 Ports
- ② 12x GE RJ45 POE+ Ports
- ③ 4x GE SFP slots



- ① 24x GE RJ45 POE+ Ports
- ② 4x GE SFP slots

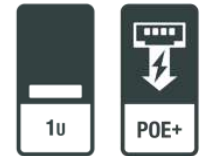

	FS-124E	FS-124E-POE	FS-124E-FPOE
Switch Capacity	56 Gbps	56 Gbps	56 Gbps
MAC Address Storage	8K	8K	8K
Network Latency (64b)	4 ms	4 ms	4 ms
VLANs Supported	4K	4K	4K
Max LAG Size	up to 8 ports	up to 8 ports	up to 8 ports
PoE Power Budget	-	185 W	370 W
Power Supply	Single PS	Single PS	Single PS

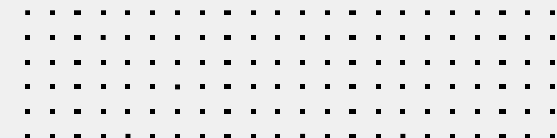



# FortiSwitch 124F Series



- ① 24 x GE RJ45 Ports
- ② 4x 10GE SFP+ slots



- ① 12x GE RJ45 Ports
- ② 12x GE RJ45 POE+ Ports
- ③ 4x 10GE SFP+ slots



- ① 24x GE RJ45 POE+ Ports
- ② 4x 10GE SFP+ slots



	FS-124F	FS-124F-POE	FS-124F-FPOE
Switch Capacity	128 Gbps	128 Gbps	128 Gbps
MAC Address Storage	32K	32K	32K
Network Latency (64b)	<1 μs	<1 μs	<1 μs
VLANs Supported	4K	4K	4K
Max LAG Size	up to 8 ports	up to 8 ports	up to 8 ports
PoE Power Budget	-	185 W	370 W
Power Supply	Single PS	Single PS	Single PS

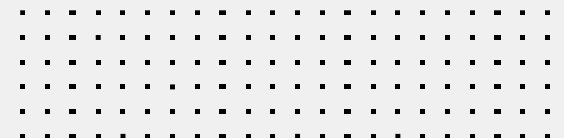

# FortiSwitch 148E Series



- ① 48 x GE RJ45 Ports
- ② 4x GE SFP slots



- ① 24 x GE RJ45 Ports
- ② 24 x GE RJ45 POE Ports
- ③ 4x GE SFP slots



	FS-148E	FS-148E-POE
Switch Capacity	104 Gbps	104 Gbps
MAC Address Storage	16K	16K
Network Latency (64b)	<1 $\mu$ s	<1 $\mu$ s
VLANs Supported	4K	4K
Max LAG Size	up to 8 ports	up to 8 ports
PoE Power Budget	-	370 W
Power Supply	Single PS	Single PS

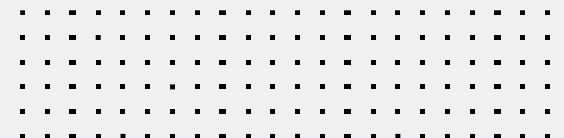

# FortiSwitch 148F Series



- ① 48x GE RJ45 Ports
- ② 4x 10GE SFP+ Slots



- ① 24 x GE RJ45 Ports
- ② 24 x GE RJ45 POE+ Ports
- ③ 4x 10GE SFP+ Slots



- ① 48 x GE RJ45 POE/POE+ Ports
- ② 4x 10GE SFP+ Slots



	FS-148F	FS-148F-POE	FS-148F-FPOE
Switch Capacity	176 Gbps	176 Gbps	176 Gbps
MAC Address Storage	32K	32K	32K
Network Latency (64b)	<1 μs	<1 μs	<1 μs
VLANs Supported	4K	4K	4K
Max LAG Size	up to 8 ports	up to 8 ports	up to 8 ports
PoE Power Budget	N/A	370 W	740 W
Power Supply	Single PS	Single PS	Single PS

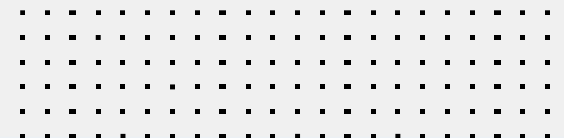

# FortiSwitch 224D/E Series



- ① 24x GE RJ45 Ports
- ② 4x GE SFP Slots



- ① 12 x GE RJ45 Ports
- ② 12 x GE RJ45 POE+ Ports
- ③ 4x GE SFP slots



- ① 24 x GE RJ45 POE/POE+ Ports
- ② 4x GE SFP slots



	FS-224E	FS-224E-POE	FS-224D-FPOE
Switch Capacity	56 Gbps	56 Gbps	56 Gbps
MAC Address Storage	16K	16K	16K
Network Latency (64b)	<1 μs	<1 μs	<1 μs
VLANs Supported	4K	4K	4K
Max LAG Size	up to 8 ports	up to 8 ports	up to 8 ports
PoE Power Budget	N/A	180 W	370 W
Power Supply	Dual Redundant PS	Single PS, Optional FRPS-740	Single PS, Optional FRPS-740



# FortiSwitch 248D Series

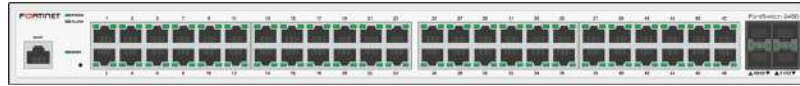

- ① 48 x GE RJ45 Ports
- ② 4x GE SFP slots



- ① 24 x GE RJ45 Ports
- ② 24 x GE RJ45 POE Ports
- ③ 2x GE SFP slots



	FS-248D	FS-248D-POE
Switch Capacity	104 Gbps	104 Gbps
MAC Address Storage	16K	16K
Network Latency (64b)	<1 $\mu$ s	<1 $\mu$ s
VLANs Supported	4K	4K
Max LAG Size	up to 8 ports	up to 8 ports
PoE Power Budget	-	370 W
Power Supply	Single PS	Single PS

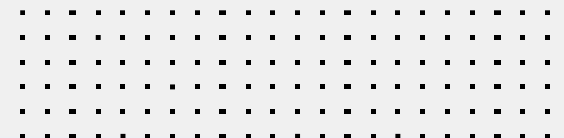

# FortiSwitch 248E Series



- ① 24x GE RJ45 Ports
- ② 24x GE PoE/PoE+ Ports
- ③ 4x GE SFP Slots



- ① 48 x GE PoE/PoE+ RJ45 Ports
- ② 4x GE SFP slots

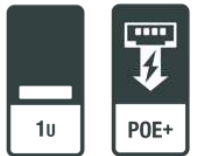

	FS-248E-POE	FS-248E-FPOE
Switch Capacity	104 Gbps	104 Gbps
MAC Address Storage	16K	16K
Network Latency (64b)	<1 μs	<1 μs
VLANs Supported	4K	4K
Max LAG Size	up to 8 ports	up to 8 ports
PoE Power Budget	370 W	740 W
Power Supply	Single PS, Optional FRPS-740	Single PS, Optional FRPS-740

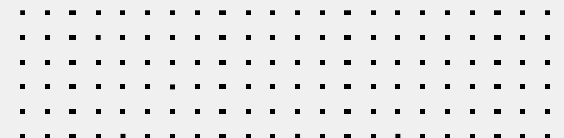

# FortiSwitch 424E Series



- ① 24x GE RJ45 Ports
- ② 4x 10GE SFP+ slots



- ① 24x GE RJ45 POE/POE+ Ports
- ② 4x 10GE SFP slots

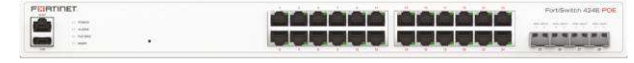

- ① 24x GE RJ45 POE/POE+ Ports
- ② 4x 10GE SFP slots



	FS-424E	FS-424E-POE	FS-424E-FPOE
Switch Capacity	128 Gbps	128 Gbps	128 Gbps
MAC Address Storage	16K	16K	16K
Network Latency (64b)	<1 μs	<1 μs	<1 μs
VLANs Supported	4K	4K	4K
Max LAG Size	up to 8 ports	up to 8 ports	up to 8 ports
PoE Power Budget	-	250 W	421 W
Power Supply	Dual Redundant PS	Dual Redundant PS	Dual Redundant PS

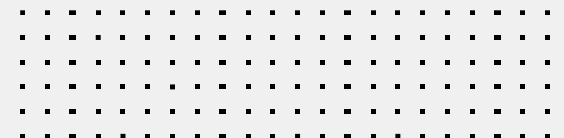

# FortiSwitch 424E-Fiber



- ① 4x GE/10GE SFP/SFP+ slots
- ② 24x GE SFP ports

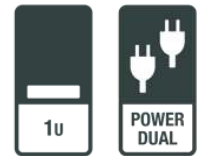

Switch Capacity	128 Gbps
MAC Address Storage	32 K
Network Latency (64b)	<1 $\mu$ s
VLANs Supported	4096
Max LAG Size	up to 8 ports
PoE Power Budget	-
Power Supply	Dual Redundant PS

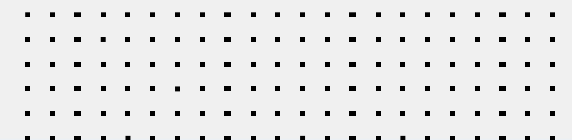



# FortiSwitch M426E-FPOE

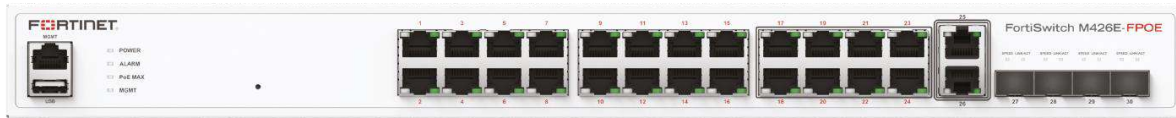

- ① 4x GE/10GE SFP/SFP+ slots
- ② 2x 5GE RJ45 ports
- ③ 8x 2.5GE RJ45 ports
- ④ 16x GE RJ45 ports

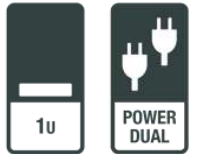

Switch Capacity	172 Gbps
MAC Address Storage	16 K
Network Latency (64b)	<1 $\mu$ s
VLANs Supported	4096
Max LAG Size	up to 8 ports
PoE Power Budget	420 W
Power Supply	Dual Redundant PS



# FortiSwitch 448D Series

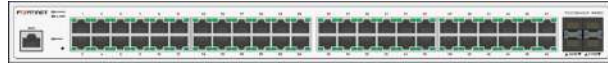

- ① 48x GE RJ45 Ports
- ② 4x 10GE SFP+ slots



- ① 48x GE RJ45 POE/POE+ Ports
- ② 4x 10GE SFP slots



- ① 48x GE RJ45 POE/POE+ Ports
- ② 4x 10GE SFP slots



	FS-448D	FS-448D-POE	FS-448D-FPOE
Switch Capacity	176 Gbps	176 Gbps	176 Gbps
MAC Address Storage	16K	16K	16K
Network Latency (64b)	<1 μs	<1 μs	<1 μs
VLANs Supported	4K	4K	4K
Max LAG Size	up to 8 ports	up to 8 ports	up to 8 ports
PoE Power Budget	-	185 W	370 W
Power Supply	Dual Redundant PS	Single PS, Optional FRPS-740	Dual Redundant PS

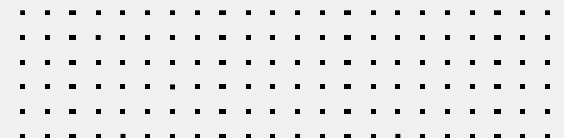

# FortiSwitch 448E Series



- ① 48x GE RJ45 Ports
- ② 4x 10GE SFP+ slots



- ① 48x GE RJ45 POE/POE+ Ports
- ② 4x 10GE SFP slots



- ① 48x GE RJ45 POE/POE+ Ports
- ② 4x 10GE SFP slots



	FS-448E	FS-448E-POE	FS-448E-FPOE
Switch Capacity	128 Gbps	128 Gbps	128 Gbps
MAC Address Storage	16K	16K	16K
Network Latency (64b)	<1 μs	<1 μs	<1 μs
VLANs Supported	4K	4K	4K
Max LAG Size	up to 8 ports	up to 8 ports	up to 8 ports
PoE Power Budget	-	421 W	772 W
Power Supply	Dual Redundant PS	Dual Redundant PS	Dual Redundant PS

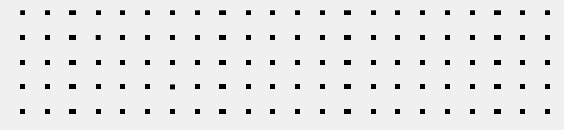

# FortiSwitch 524D Series



- ① 24x GE RJ45 Ports
- ② 4x 10GE SFP+ slots
- ③ 2x 40GE stacking interface

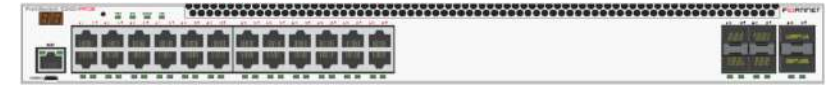

- ① 24x GE RJ45 POE/POE+ Ports
- ② 4x 10GE SFP+ slots
- ③ 2x 40GE stacking interface

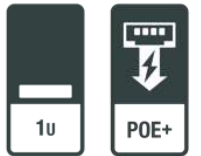

	FS-524D	FS-524D-FPOE
Switch Capacity	288 Gbps	288 Gbps
MAC Address Storage	96K	96K
Network Latency (64b)	<2 μs	<2 μs
VLANs Supported	4K	4K
Max LAG Size	up to 24 ports	up to 24 ports
PoE Power Budget	-	400 W
Power Supply	Single PS, Optional FS-PSU-150	Single PS, Optional FS-PSU-600

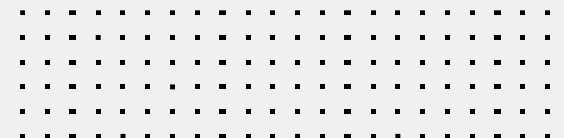

# FortiSwitch 548D Series

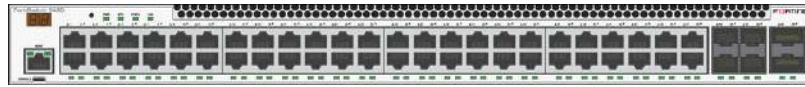

- ① 48x GE RJ45 Ports
- ② 4x 10GE SFP+ slots
- ③ 2x 40GE stacking interface



- ① 48x GE RJ45 POE/POE+ Ports
- ② 4x 10GE SFP+ slots
- ③ 2x 40GE stacking interface



	FS-548D	FS-548D-FPOE
Switch Capacity	336 Gbps	336 Gbps
MAC Address Storage	96K	96K
Network Latency (64b)	<2 μs	<2 μs
VLANs Supported	4K	4K
Max LAG Size	up to 24 ports	up to 24 ports
PoE Power Budget	-	750 W
Power Supply	Single PS, Optional FS-PSU-150	Single PS, Optional FS-PSU-900

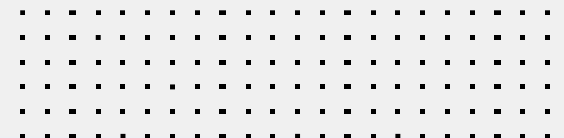

# FortiSwitch 1048E

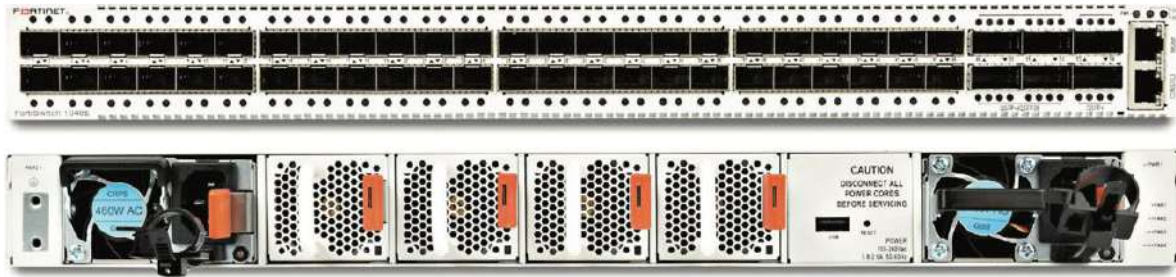

- ① 4x 40/100GE QSFP28 slots
- ② 6x 40GE QSFP+ slots
- ③ 48x GE/10GE SFP/SFP+ slots
- ④ 1x GE RJ45 Mgmt port

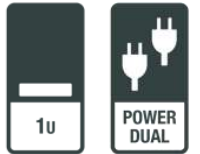

Switch Capacity (Duplex)	1760 Gbps
MAC Address Storage	144,000
Network Latency (64b)	<800 ns
VLANs Supported	4096
Max LAG Size	up to 48 ports
PoE Power Budget	-
Power Supply	Dual Redundant PS

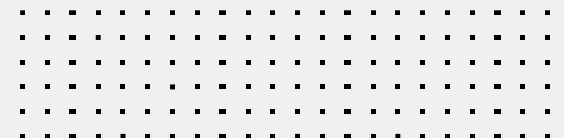

# FortiSwitch 3032D

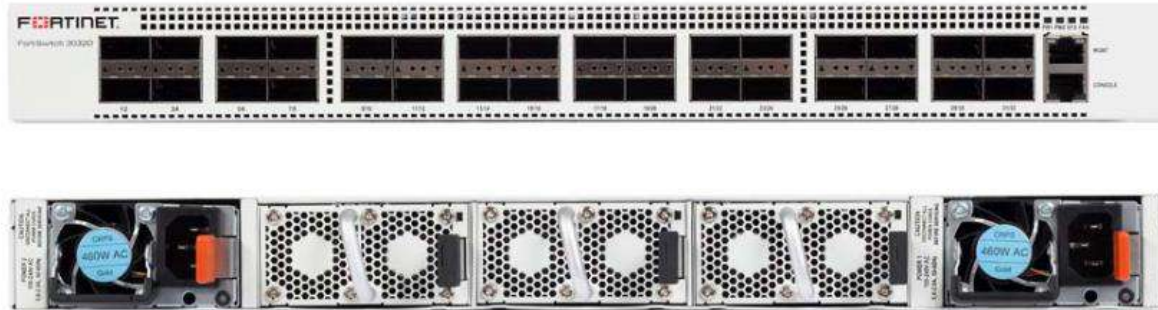

- ① 32x 40GE QSFP+ slots
- ② 1x GE RJ45 Mgmt port

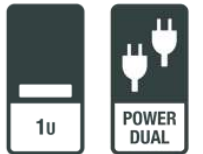

Switch Capacity (Duplex)	2560 Gbps
MAC Address Storage	128,000
Network Latency (64b)	<1 $\mu$ s
VLANs Supported	4096
Max LAG Size	up to 24 ports
PoE Power Budget	-
Power Supply	Dual Redundant PS



# FortiSwitch 3032E

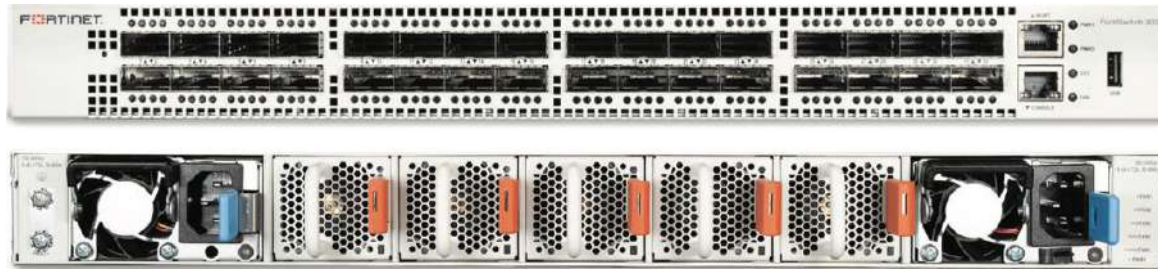

- ① 32x 40/100GE QSFP28 slots
- ② 1x GE RJ45 Mgmt port

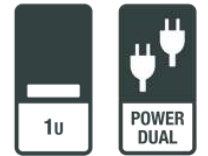

Switch Capacity (Duplex)	6400 Gbps
MAC Address Storage	40,000
Network Latency (64b)	<1 $\mu$ s
VLANs Supported	4096
Max LAG Size	up to 48 ports
PoE Power Budget	-
Power Supply	Dual Redundant PS

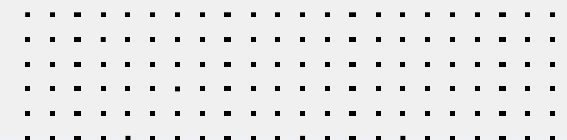



# FortiSwitch Series – Secure Access Switches (I)

	FS-108E	FS-108E-POE	FS-108E-FPOE
<b>GE Ports</b>	7x RJ45, 1x RJ45 PoE-PD 2x SFP	4x RJ45 2x SFP	2x SFP
<b>PoE GE Ports</b>	-	-	-
<b>PoE/+ GE Ports</b>	-	4	8
<b>10GE SFP+ slots</b>	-	-	-
<b>Shared Ports (pair)</b>	-	-	-
<b>Power Budget</b>	-	65 W	130 W
<b>Power Supply</b>	Single AC/PoE-PD	Single AC	Single AC



# FortiSwitch Series – Secure Access Switches (II)

	FS-124E	FS-124E-POE	FS-124E-FPOE
<b>GE Ports</b>	24x RJ45, 4 x SFP	12x RJ45, 4 x SFP	4 x SFP
<b>PoE GE Ports</b>	-	-	-
<b>PoE/+ GE Ports</b>	-	12	24
<b>Power Budget</b>	-	185 W	370 W
<b>Power Supply</b>	Single AC	Single AC	Single AC



# FortiSwitch Series – Secure Access Switches (III)

	FS-224E	FS-224E-POE	FS-224D-FPOE
<b>GE Ports</b>	24x RJ45, 4x SFP	12x RJ45, 4x SFP	4x SFP
<b>PoE GE Ports</b>	-	-	-
<b>PoE/+ GE Ports*</b>	-	12	24
<b>Shared Ports (pair)</b>	-	-	-
<b>Power Budget</b>	-	180 W	370 W
<b>Power Supply</b>	Dual Redundant PS	Single AC, Optional FRPS-740	Single AC, Optional FRPS-740



# FortiSwitch Series – Secure Access Switches (IV)

	FS-248D	FS-248D-POE	FS-248E-POE	FS-248E-FPOE
<b>GE Ports</b>	48x RJ45 4x SFP	24x RJ45 2x SFP	24x RJ45 4x SFP	4x SFP
<b>PoE GE Ports</b>	-	24	-	-
<b>PoE/+ GE Ports</b>	-	-	24	48
<b>Power Budget</b>	-	370 W	370 W	740 W
<b>Power Supply</b>	Single PS	Single PS	Single AC, Optional FRPS-740	Single AC, Optional FRPS-740



# FortiSwitch Series – Secure Access Switches (V)

	FS-424D	FS-424D-POE	FS-424D-FPOE	FS-448D	FS-448D-POE	FS-448D-FPOE
<b>GE Ports</b>	24	-	-	48	-	-
<b>PoE/+ GE Ports</b>	-	24	24	-	48	48
<b>10GE SFP+ slots</b>	2	2	2	4	4	
<b>Power Budget</b>	-	185 W	370 W	-	370 W	740 W
<b>Power Supply</b>	Dual Redundant AC	Single AC, Optional FRPS-740	Single AC, Optional FRPS-740	Dual Redundant AC	Single AC, Optional FRPS-740	Dual Redundant AC



# FortiSwitch Series – Secure Access Switches (VI)

	FS-524D	FS-524D-FPOE	FS-548D	FS-548D-FPOE
GE Ports	24	-	48	-
PoE/+ GE Ports	-	24	-	48
10GE SFP+ slots	4	4	4	4
40GE QSFP+ slots	2	2	2	2
Power Budget	-	500 W	-	750 W
Power Supply	Single PS, Optional FS-PSU-150	Single PS, Optional FS-PSU-600	Single PS, Optional FS-PSU-150	Single PS, Optional FS-PSU-900



# FortiSwitch Series – Data Center Switches

	FSW-1024D	FSW-1048D	FSW-1048E	FSW-3032D	FSW-3032E
<b>GE Ports</b>	1x mgmt	1x mgmt	1x mgmt	1x mgmt	1x mgmt
<b>PoE GE Ports</b>	-	-	-	-	-
<b>10GE Ports</b>	24 (1G/10G)	48 (1G/10G)	48 (1G/10G)	-	-
<b>40GE Ports</b>	-	4	2	32	-
<b>100GE Ports</b>	-	-	4 (40G/100G)	-	32 (40G/100G)
<b>Power Budget</b>	-	-	-	-	-



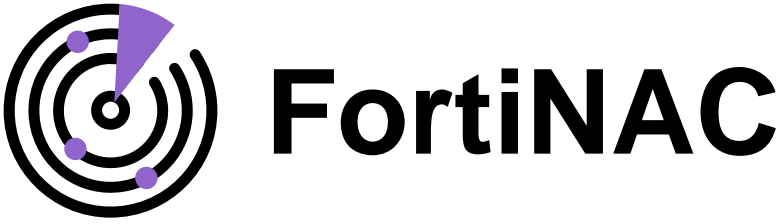



# Introducing FortiNAC



Appliance



Virtual Machine



## Provides Visibility of Users and End points for Enterprise Networks and Automates Threat Response



Device identification and profiling



Simplified guest access with self-registration



Continuous risk assessment



Micro-segmentation of endpoints



Automated response to identified risks



Orchestration of 3rd party devices

### Continuous device profiling

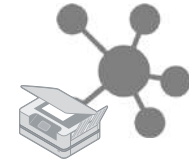

### Containment of lateral threats at Edge



# FortiNAC Series

	FNC-CA-500C	FNC-CA-600C	FNC-CA-700C	FNC-R-650C	FNC-M-550C
<b>Type</b>	Mid-range Control and Application Server	High Performance Control and Application Server	Ultra High Performance Control and Application Server	Reporting and Analytics Server	Centralized Management Appliance
<b>Target Environment</b>	Small Environments	Medium Environments	Large Environments with few Persistent Agents	Multi-site environments with multiple appliances	Multi-site environments with multiple appliances
<b>Capacity</b>	Manages up to 1,000 ports in the network*	Manages up to 7,500 ports in the network*	Manages up to 15,000 ports in the network*	Unlimited	Unlimited

Virtual appliances are also available, please refer to [www.fortinet.com](http://www.fortinet.com) for more information





# FortiSandbox



# Introducing FortiSandbox



Appliance



Virtual Machine



Hosted



Cloud



Advanced Threat Protection solution designed to identify and thwart the highly targeted and tailored attacks



Independently top-rated



Broad integration



Intelligent automation



All-in-one



Flexible deployment



Open extensibility

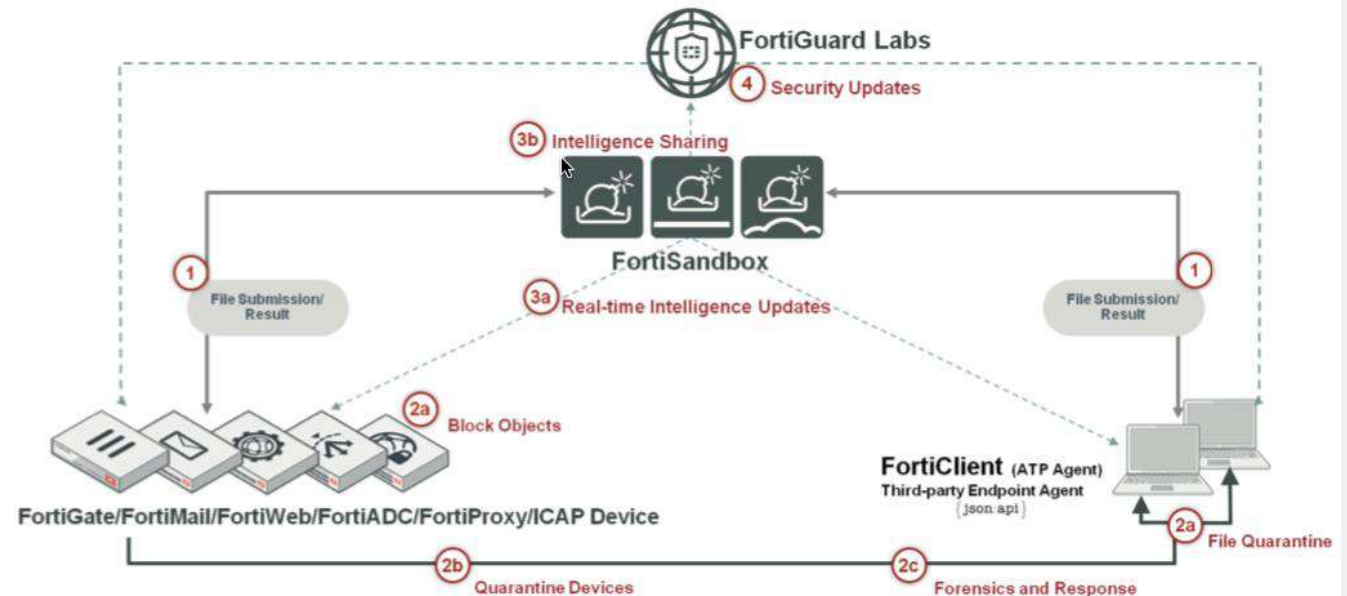

# FortiSandbox Series

FortiSandbox	FSA-500F	FSA-1000F/-DC	FSA-2000E	FSA-3000E	FSA-VM
VM Sandboxing (Files/Hour)	120	280	480	1,120	Hardware Dependent
Sandbox Pre-Filter (Files/Hour)	4,500	7,500	12,000	15,000	Hardware Dependent
Number of VMs	2+4 optional	2+12 optional	4+20 optional	8 + 48 optional	Total: 1 to 54
Interfaces	4x GE RJ45 ports	4x GE RJ45 ports, 4x 10GE SFP+ slots	4x GE RJ45 ports, 2x 10GE SFP+ slots	4x GE RJ45 ports, 2x 10GE SFP+ slots	Hardware Dependent





# FortiClient



# Introducing FortiClient



## Comprehensive end-point protection & security enforcement



Broad endpoint visibility



Endpoint compliance and vulnerability management



Proactive endpoint defense



Automated threat containment



Secure remote access



Easy to deploy and manage

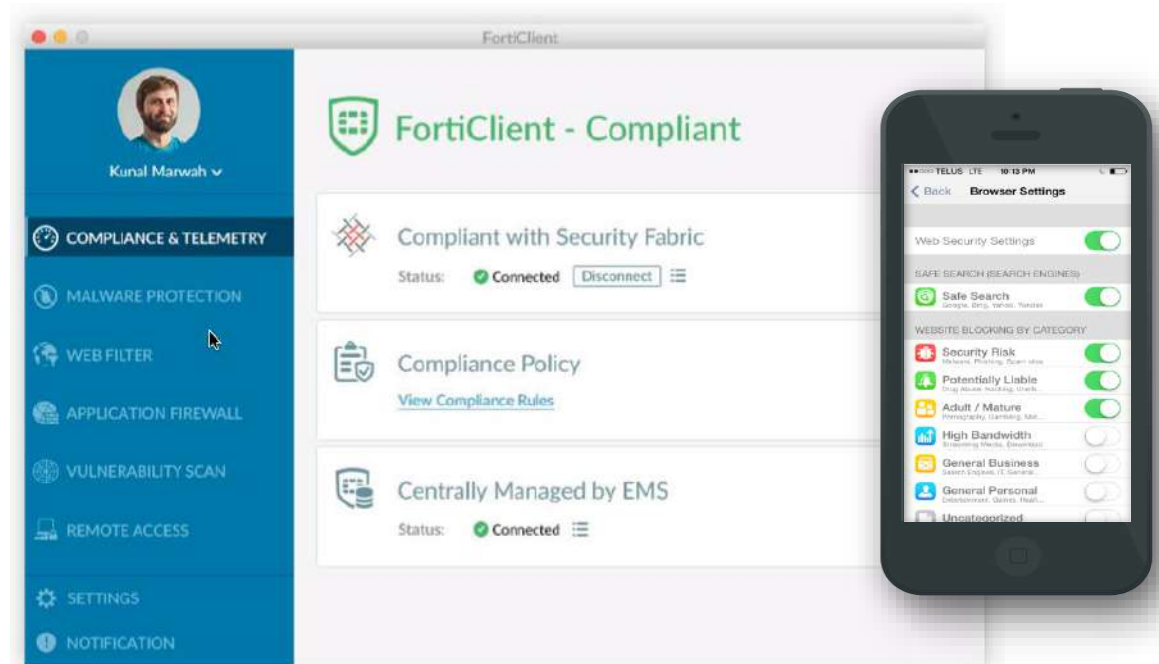

# FortiClient V6.2

1 Requires FortiClient to be managed by EMS

	Windows	Mac OSX	Android	iOS	Chromebook	Linux
<b>Security Fabric Components</b>						
Endpoint Telemetry <sup>1</sup>	✓	✓	✓	✓	✓	✓
Compliance Enforcement using Dynamic Access Control <sup>1</sup>	✓	✓	✓	✓		✓
Endpoint Audit and Remediation with Vulnerability Scanning <sup>1</sup>	✓	✓				✓
Automated Endpoint Quarantine	✓	✓				





# FortiClient V6.2

	Windows	Mac OSX	Android	iOS	Chromebook	Linux
<b>Host Security and VPN Components</b>						
Antivirus	✓	✓				✓
Cloud-based Threat Detection	✓					
Anti-Exploit	✓					
Sandbox Detection (On-prem)	✓	✓				✓ (limited)
Sandbox Detection (Cloud)	✓					
Web Filtering	✓	✓	✓	✓	✓	
Application Firewall	✓	✓				
IPSec VPN	✓	✓	✓			
SSL VPN	✓	✓	✓	✓		✓



# FortiClient V6.2

	Windows	Mac OSX	Android	iOS	Chromebook	Linux
<b>Others</b>						
<b>Remote Logging &amp; Reporting</b>	✓	✓		✓	✓	✓
<b>Windows AD SSO Agent</b>	✓	✓				
<b>USB Device Control</b>	✓	✓				✓



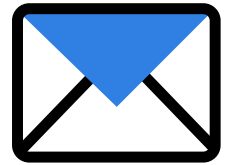

# FortiMail



# Introducing FortiMail



Appliance



Virtual Machine



Hosted



Cloud



**Advanced anti-spam and antivirus filtering solution, with extensive quarantine and archiving capabilities.**



Top-rated Antispam and Antiphishing



Independently certified advanced threat defense



Integrated data protection



Enterprise-class management



High-performance mail handling

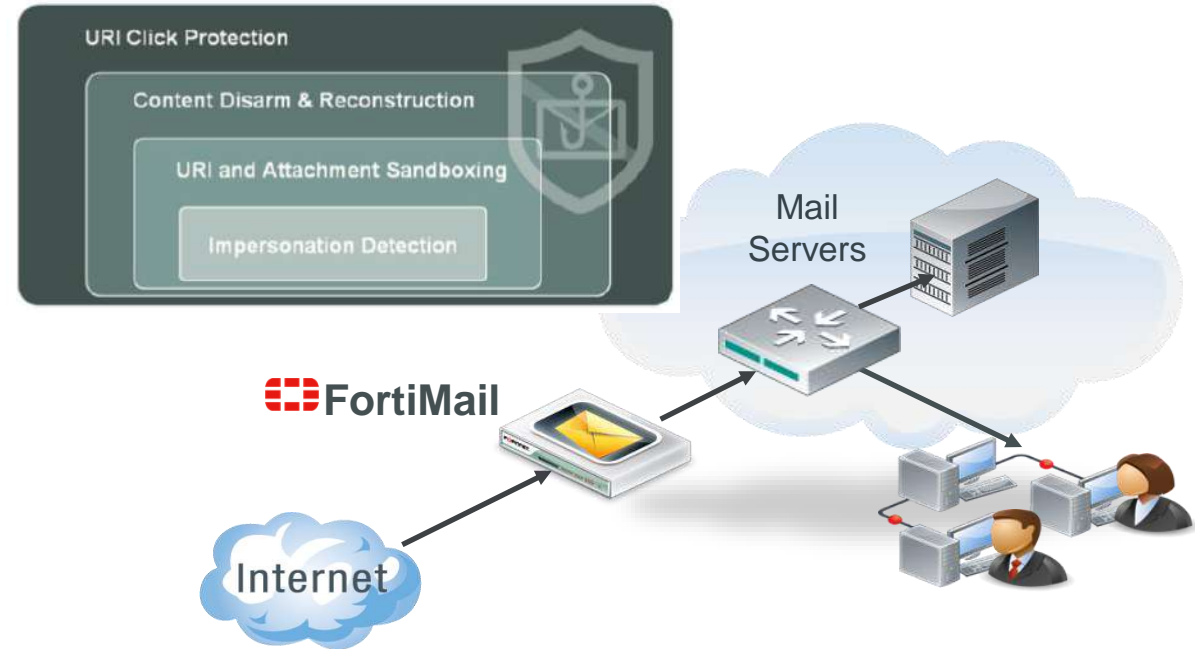

# FortiMail Series

FortiMail	FML-60D	FML-200F	FML-400F	FML-900F	FML-2000E	FML-3000E	FML-3200E
Email Domains	2	20	100	800	800	2,000	2,000
Server Mode Mailboxes	50	150	400	1,500	1,500	3,000	3,000
Email Routing* (Msg/hr)	3.6 K	50 K	250 K	800 K	1.5 Mil	2.5 Million	3.4 Million
FortiGuard Enterprise ATP* (Msg/hr)	2.7 K	30 K	150 K	400 K	700 K	1.5 Million	2.0 Million
GE RJ45 ports	4	4	4	4	4	4	4
GE SFP Slots	-	-	-	2	2	2	2
10 GE SFP+ Slots	-	-	-	-	-	-	2
Storage capacity	1x 500GB	1x 1TB	2x 1TB	2x 2 TB (2x 2 TB Optional)	2x 2 TB (6x 2 TB Optional)	2x 2TB (10 x 2 TB Optional)	2x 2 TB (10x 2 TB Optional)
Form Factor	Desktop	Rack Mount, 1RU	Rack Mount, 1RU	Rack Mount, 2RU	Rack Mount, 2RU	Rack Mount, 2RU	Rack Mount, 2RU

\* Based on 100KB message size, no queuing



# FortiMail-VM Series

FortiMail	FML-VM00	FML-VM01	FML-VM02	FML-VM04	FMG-VM08	FMG-VM016	FMG-VM32
Email Domains	2	20	100	800	2,000	2,000	2,000
Server Mode Mailboxes	50	150	400	1,500	3,000	3,000	3,000
Email Routing* (Msg/hr)	3,600	34,000	67,000	306,000	675,000	875,000	1,200,000
FortiGuard Antispam+AV* (Msg/hr)	2,700	30,000	52,000	225,000	585,000	817,000	1,100,000
Max vCPU supported	1	1	2	4	8	16	32
Max vNICs	4	4	4	4	4	6	6
Storage capacity (Min/Max)	50 GB / 1 TB	50 GB / 1 TB	50 GB / 2 TB	50 GB / 4 TB	50 GB / 8 TB	50 GB / 12 TB	50 GB / 24 TB
Memory required (Min/Max)	1 GB / 2 GB	1 GB / 2 GB	1 GB / 4 GB	1 GB / 8 GB	1 GB / 16 GB	1 GB / 128 GB	1 GB / 128 GB

\* Based on 100KB message size, no queuing





# Introducing FortiWeb



Appliance



Virtual Machine



Hosted



Cloud



Container



## Web application firewall to protect, balance, and accelerate web applications



Feature-rich product that consolidates NGFW and SWG services



Powerful hardware that can perform SSL deep inspection



Anti-malware techniques updated with the latest threat intelligence



single pane of glass management



Effectively remove blind spots in encrypted traffic



Stay protected against the latest known and unknown attacks

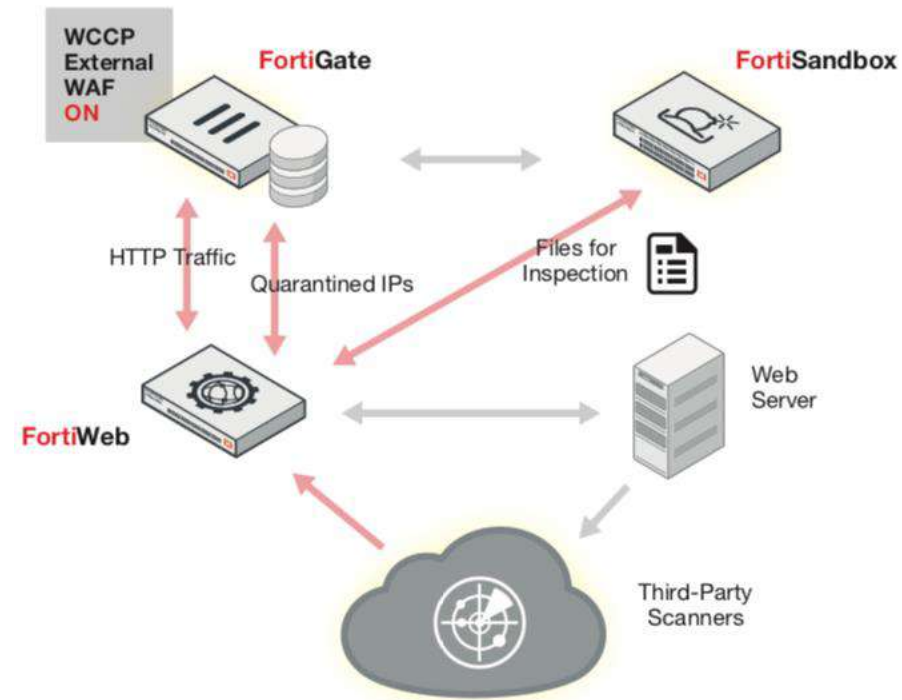



# FortiWeb Series

FortiWeb	FWB-100E	FWB-400E	FWB-600E	FWB-1000D	FWB-1000E
Throughput	50 Mbps	250 Mbps	750 Mbps	1 Gbps	1.3 Gbps
GE RJ45 ports	4	4	2 + 2 Bypass	2 + 4 Bypass	2 + 4 Bypass
GE SFP slots	-	4	4	2	4
10GE SFP+	-	-	-	-	2
Storage capacity	32 GB	480 GB	480 GB	2x 2 TB	2x 1 TB
Form Factor	Desktop	1RU	1RU	2RU	2RU

FortiWeb	FWB-2000E	FWB-3000E	FWB-3010E	FWB-4000E
Throughput	2.5 Gbps	5 Gbps	5 Gbps	20 Gbps
GE RJ45 ports	4 Bypass	4 + 4 Bypass	4+ 4 Bypass	4+ 4 Bypass
GE SFP slots	4	4	4	4
10GE SFP+	2	4	2+ 2 Bypass	2+ 2 Bypass
Storage capacity	2x 1 TB	2x 2 TB	2x 2 TB	2x 2 TB
Form Factor	2RU	2RU	2RU	2RU



# FortiWeb-VM and Container Series

FortiWeb-VM	FWB-VM01	FWB-VM02	FWB-VM04	FWB-VM08
HTTP Throughput	25 Mbps	100 Mbps	500 Mbps	2 Gbps
Max vCPU Supported	1	2	4	8
Memory required (Min/Max)	1 GB / Unlimited			
Storage capacity (Min/Max)	40 GB / 2 TB			

FortiWeb Container	FWB-VMC01	FWB-VMC02	FWB-VMC04	FWB-VMC08
HTTP Throughput	25 Mbps	100 Mbps	500 Mbps	2 Gbps
Memory required (Min)	4 GB			
Storage capacity (Min/Max)	30 GB / 500 GB			





# FortiADC



# Introducing FortiADC



Appliance



Virtual Machine



Cloud



Optimize the availability, performance and scalability of mobile, cloud and enterprise application delivery



Layer 7 Load Balancing



Secure Traffic Management



Application Optimization



Security Fabric Integration



Global Server Load Balancing



Value-added Security Features

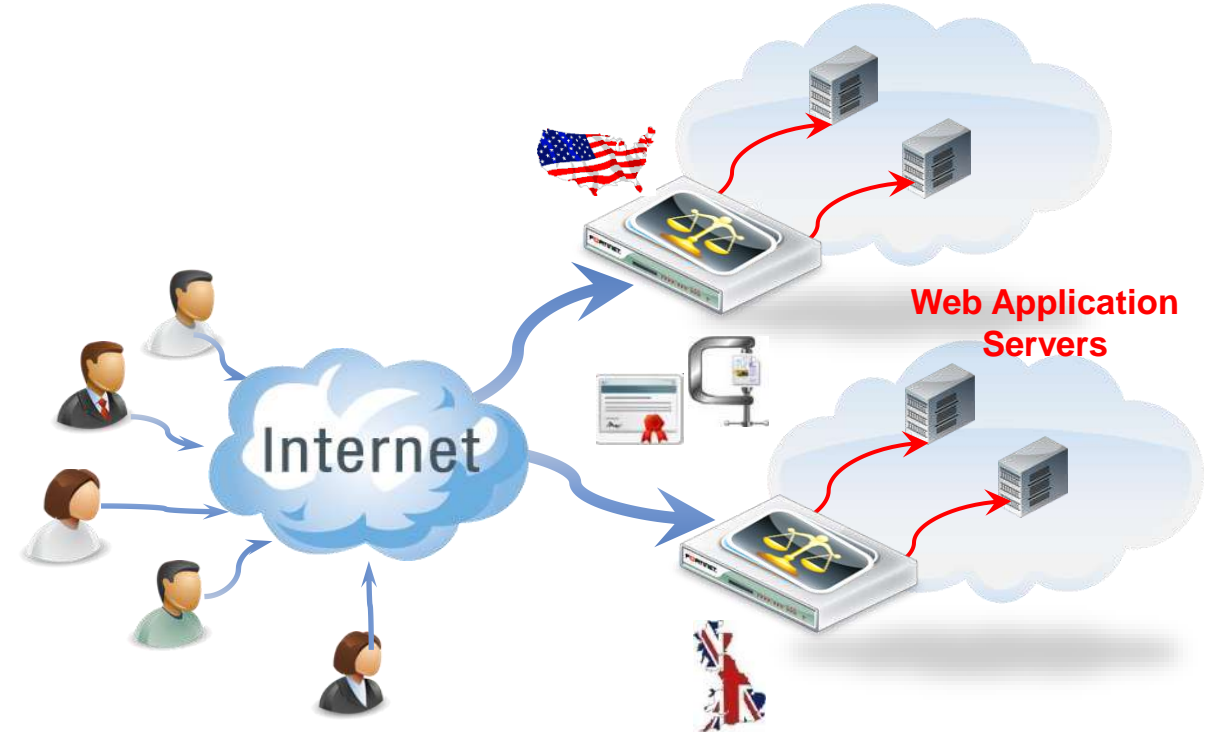

# FortiADC Series

FortiADC	FAD 100F	FAD 200F	FAD 300F	FAD 400F	FAD 1200F	FAD 2200F	FAD 4200F	FAD 5000F
<b>L4 Throughput</b>	1.5 Gbps	3 Gbps	8 Gbps	15 Gbps	40 Gbps	60 Gbps	100 Gbps	200 Gbps
<b>L7 Throughput</b>	1.3 Gbps	2.2 Gbps	? Gbps	12 Gbps	30 Gbps	35 Gbps	80 Gbps	12\50 Gbps
<b>L4 CPS</b>	50,000	100,000	300,000	400,000	1 Million	1.2 Million	1.8 Million	2.5 Million
<b>L4 HTTP RPS</b>	150,000	300,000	1 Million	1.5 Million	3 Million	4 Million	5 Million	7.5 Million
<b>L4 Concurrent Connection</b>	3 Million	5 Million	12 Million	12 Million	36 Million	72 Million	144 Million	160 Million
<b>SSL Bulk Encryption Throughput</b>	400 Mbps	1 Gbps	3 Gbps	6 Gbps	20 Gbps	25 Gbps	50 Gbps	50 Gbps
<b>Total Interfaces</b>	6x GE RJ45	4x GE RJ45 2x GE SFP	4x GE RJ45 4x GE SFP	2x 10 GE SFP+, 4x GE SFP, 4x GE RJ45	8x 10 GE SFP+, 8x GE SFP, 8x GE RJ45	12x 10 GE SFP+, 8x GE SFP	4x 40 GE QSFP+, 8x 10GE SFP+	4x 100 GE QSFP28, 8x 40 GE QSFP
<b>Power Supply</b>	Single	Single	Single	Single (optional Dual)	Dual	Dual	Dual	Dual



# FortiADC-VM Series

FortiADC	FAD-VM01	FAD-VM02	FAD-VM04	FAD-VM08	FAD-VM16	FAD-VM32
L4 Throughput	1 Gbps	2 Gbps	4 Gbps	10 Gbps	16 Gbps	24 Gbps
VDOM	0	0	5	10	15	20
vCPU support (Max)	1	2	4	8	16	32
Memory support (Max)	4 GB	4 GB	8 GB	16 GB	32 GB	64 GB





# FortiCASB



# Introducing FortiCASB



Hosted



## Hosted Service Designed to Provide Visibility, Insight, and Control for SaaS Applications



API-Based



Compliance and DLP



User Insights and Policies



Security Fabric Integration



Shadow IT Discovery



Advanced Analytics

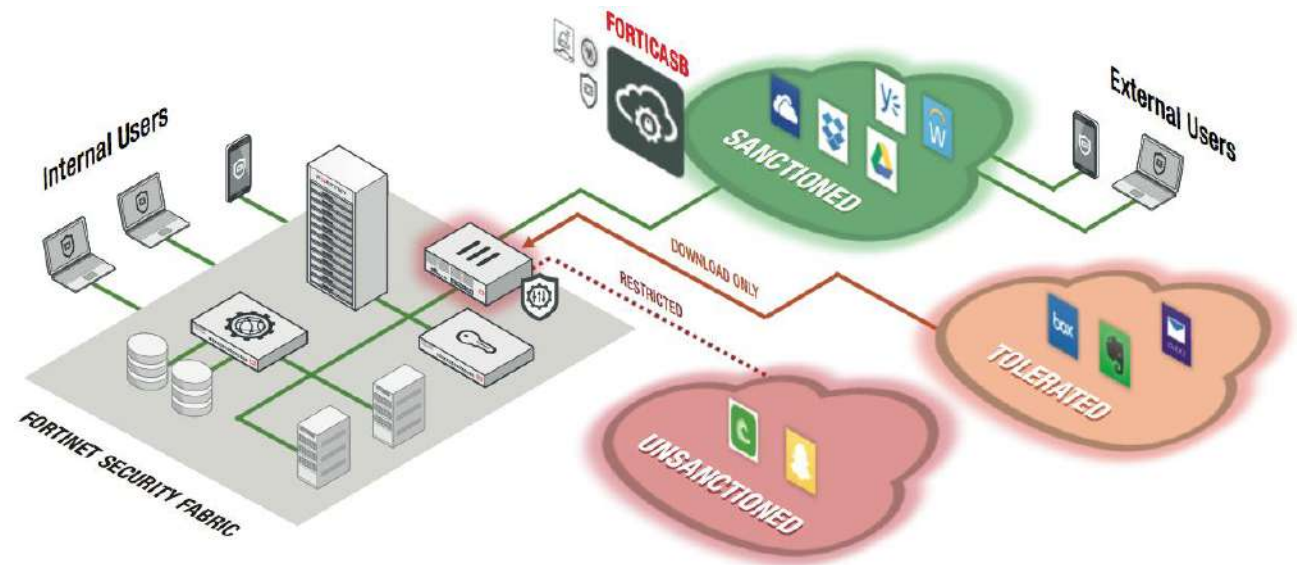



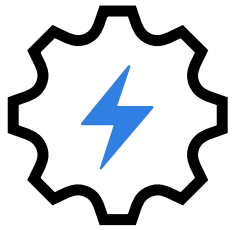

# FortiCWP



# Introducing FortiCWP



Hosted



## Cloud Security Analytics and Posture Management



API-Based



DevOps Integration



Customizable Threat Discovery



Comprehensive Analytics



Compliance Reporting and Policies



Cloud Blind Spot Elimination

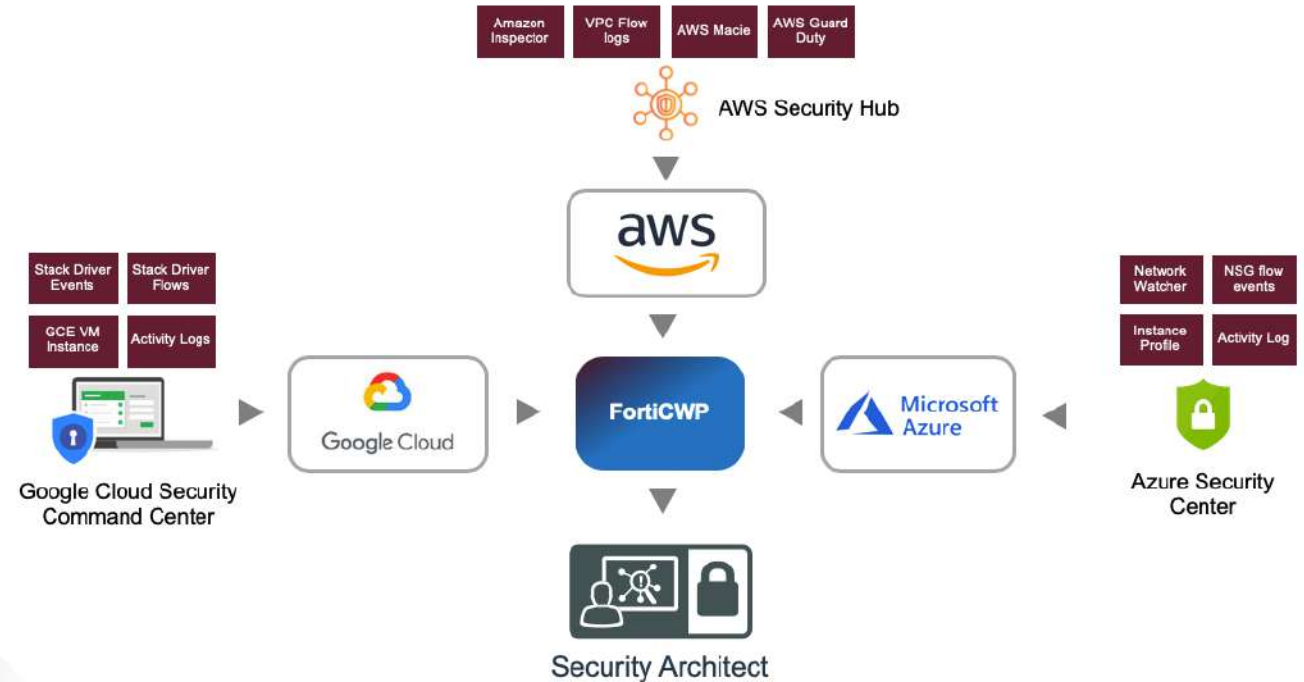



# FortiDDoS



# Introducing FortiDDoS



Appliance



## Hardware Accelerated DDoS Intent Based Defense



(SPU)-based layer 3, 4, and 7 DDoS protection



Behavior-based DDoS protection to eliminate need for signature files



Minimal false-positive detections through continuous threat evaluation



Ability to monitor enormous parameters simultaneously



Advanced defense against bulk volumetric, layer 7 applications



Attack protection for DNS services via specialized tools

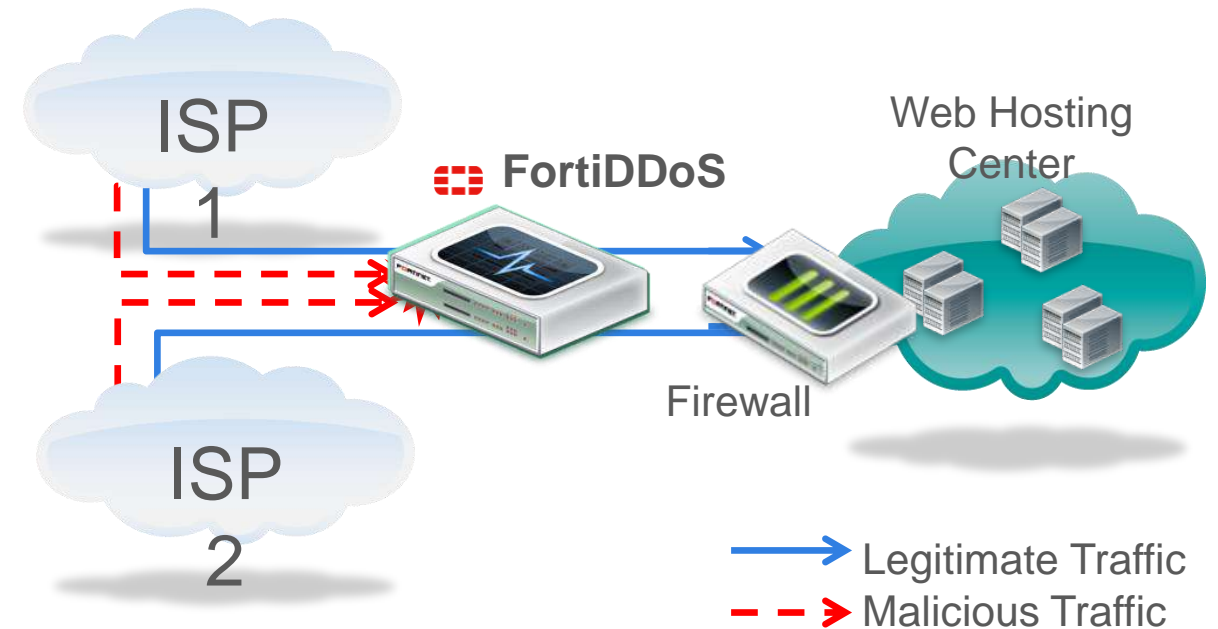

# FortiDDoS Series

	FDD-200F	FDD-400B	FDD-1200B	FDD-1500E	FDD-1500F	FDD-2000E
<b>Throughput (Full Duplex)</b>	8 Gbps	6 Gbps	36 Gbps	35 Gbps	30 Gbps	70 Gbps
<b>Simultaneous Connections</b>	4.2 Mil	1 Mil	6 Mil	12 Mil	16.7 Mil	25 Mil
<b>Session Setup/ Teardown</b>	375,000 / Second	100,000 / Second	600,000 / Second	>1.5M /Second	700,000/Second	>3M /Second
<b>Latency</b>	< 50 $\mu$ s	< 50 $\mu$ s	< 50 $\mu$ s	< 50 $\mu$ s	< 50 $\mu$ s	< 50 $\mu$ s
<b>Interfaces</b>	8 LAN/WAN Interfaces (Copper/SFP), 4 LAN & WAN bypass 10GE SFP/+	8 LAN Interfaces (Copper/SFP), 8 WAN Interfaces (Copper/SFP)	16x LAN & WAN 10GE SFP/+, 4 LAN & WAN bypass 10GE SFP/+	16x LAN & WAN 10GE SFP/+, 4 LAN & WAN bypass 100GE QSFP28	4x LAN & WAN 10GE SFP/+, 4 LAN & WAN bypass 10GE SFP/+	16x LAN & WAN 10GE SFP/+, 4 LAN & WAN bypass 100GE QSFP28
<b>Advanced DNS Mitigation</b>	Yes	Yes	Yes	Yes	Yes	Yes





# FortiDeceptor



# Introducing FortiDeceptor



Appliance



Virtual Machine



## Automated Detection and Response to External and Internal Threats



GUI driven threat map quickly uncovers threat campaigns targeting your organization



Security infrastructure integration provides real-time blocking of attackers before real damage occurs



Centrally manage and automate the deployment of deception VMs and decoys

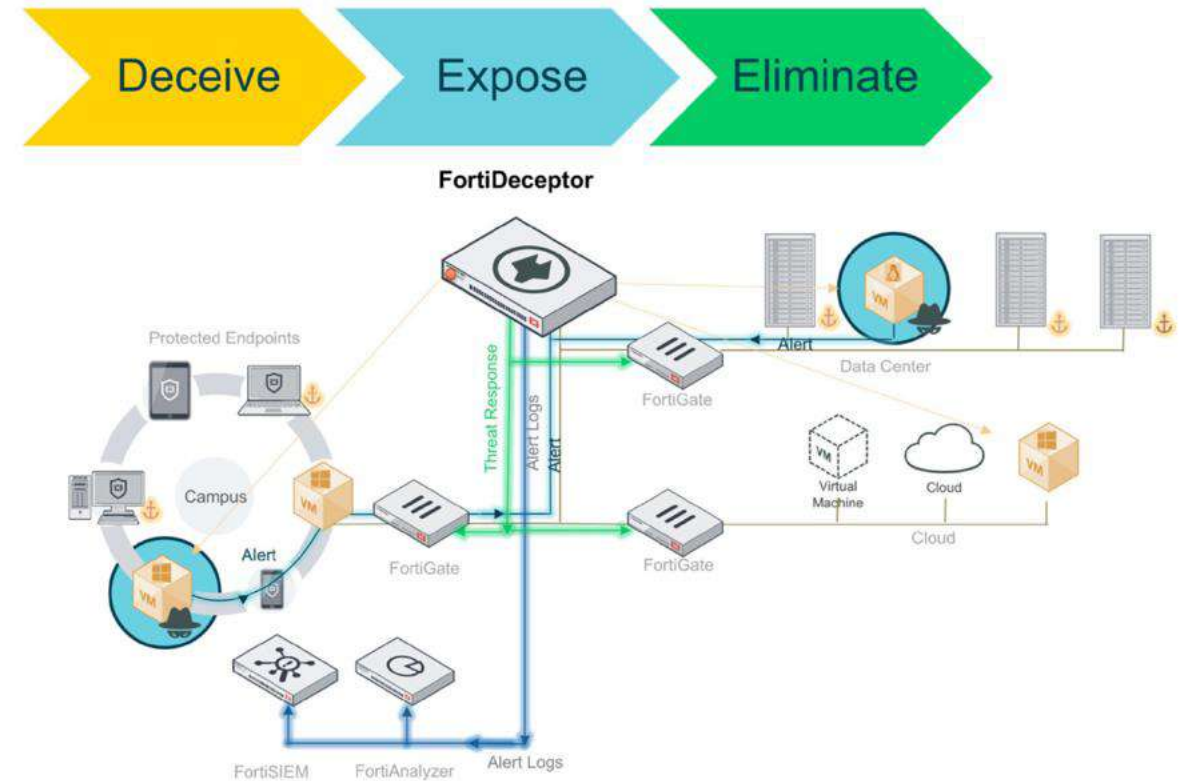

# FortiDeceptor Series

	FDC-1000F	FDC-VM
<b>VM Instance support (Maximum) *</b>	16 Win / 16 Linux / Mix	16 Win / 16 Linux / Mix
<b>VLANs support (Maximum)</b>	32	32
<b>Deception VMs Shipped *</b>	2 Win (1 x Win7 & 1 x Win10) and 8 Linux	0
<b>Interfaces</b>	4 x GE RJ45, 4 x GE SFP	6 Virtual
<b>Storage Capacity</b>	2TB (2 x 1TB HDD)	200GB to 16TB





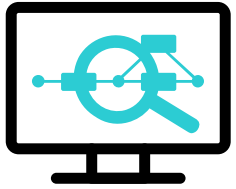

# FortiEDR



# Introducing FortiEDR



## Advanced, automated endpoint protection, detection, and response



Discover, Predict, Prevent



Detect and Defuse in Real Time



Playbook-based Incident Response



Real Time and Automatic



Efficient Security Operations



Minimize Business Impact

The screenshot displays the FortiEDR console interface. At the top, there are navigation tabs: DASHBOARD, EVENT VIEWER (active), FORENSICS, COMMUNICATION CONTROL, SECURITY SETTINGS, INVENTORY, and ADMINISTRATION. Below the tabs, there are utility icons for Archive, Mark As, Export, Handle Event, Delete, Forensics, and Exception Manager. The main area is divided into two sections: 'EVENTS' and 'CLASSIFICATION DETAILS'.

**EVENTS**

ID	DEVICE	PROCESS	CLASSIFICATION	DESTINATIONS	RECEIVED	LAST UPDATED
05262db186c97bbe523f0a674b08ecdafa2799ea7...			Malicious		29-Jan-2020, 23:18:24	
NO-AV.exe (7 events)						
2142851	DESKTOP-P0K01MU	NO-AV.exe	Malicious	File Delete Act...	13-Dec-2019, 14:56:24	13-Dec-2019, 14:56:24
User: DESKTOP-P0K01MU\user Certificate: Unsigned Process path: %DeviceHarddiskVolume2\Users\User\Desktop\NO-AV.exe Raw data items: 1						
2142773	DESKTOP-P0K01MU	NO-AV.exe	Malicious	File Write Access	13-Dec-2019, 14:55:50	13-Dec-2019, 14:56:23
2142755	DESKTOP-P0K01MU	NO-AV.exe	Malicious	Modify OS Setin...	13-Dec-2019, 14:55:50	13-Dec-2019, 14:55:50
2142734	DESKTOP-P0K01MU	NO-AV.exe	Malicious	File Creation	13-Dec-2019, 14:55:50	13-Dec-2019, 14:55:50
2142714	DESKTOP-P0K01MU	NO-AV.exe	Malicious	File Service Acc...	13-Dec-2019, 14:55:44	13-Dec-2019, 14:55:44
2142696	DESKTOP-P0K01MU	NO-AV.exe	Malicious	12 destinations	13-Dec-2019, 14:55:42	13-Dec-2019, 14:56:24
2142682	DESKTOP-P0K01MU	NO-AV.exe	Malicious	File Write Access	13-Dec-2019, 14:55:42	13-Dec-2019, 14:55:42
Pre-AV.exe (1 event)						
7682b842ed75b69a23c5d9ecf05a45ee79c723098c...			Malicious		13-Dec-2019, 14:50:28	
7682b842ed75b69a23c5d9ecf05a45ee79c723098c...			Malicious		12-Nov-2019, 20:08:03	

**CLASSIFICATION DETAILS**

Malicious **Powercat**  
By **ReversingLabs**  
Threat name: Win32.Trojan.Gandcrab  
Threat family: Gandcrab  
Threat type: Trojan

**History**

- Malicious, by enSilo, on 13-Dec-2019, 14:56:26

**Triggered Rules**

Retrieve the executable file from the targeted device, based on its path. Use the Forensics tab to perform deeper analysis. Verify the origin of the file and its intended use in the organization.

**ADVANCED DATA**

The advanced data section shows a network diagram with several nodes representing endpoints and servers. The nodes are connected by lines, indicating the flow of data or communication. The nodes are labeled with IP addresses and hostnames, such as 10.10.10.10, 10.10.10.11, 10.10.10.12, 10.10.10.13, 10.10.10.14, 10.10.10.15, 10.10.10.16, 10.10.10.17, 10.10.10.18, 10.10.10.19, 10.10.10.20, 10.10.10.21, 10.10.10.22, 10.10.10.23, 10.10.10.24, 10.10.10.25, 10.10.10.26, 10.10.10.27, 10.10.10.28, 10.10.10.29, 10.10.10.30, 10.10.10.31, 10.10.10.32, 10.10.10.33, 10.10.10.34, 10.10.10.35, 10.10.10.36, 10.10.10.37, 10.10.10.38, 10.10.10.39, 10.10.10.40, 10.10.10.41, 10.10.10.42, 10.10.10.43, 10.10.10.44, 10.10.10.45, 10.10.10.46, 10.10.10.47, 10.10.10.48, 10.10.10.49, 10.10.10.50, 10.10.10.51, 10.10.10.52, 10.10.10.53, 10.10.10.54, 10.10.10.55, 10.10.10.56, 10.10.10.57, 10.10.10.58, 10.10.10.59, 10.10.10.60, 10.10.10.61, 10.10.10.62, 10.10.10.63, 10.10.10.64, 10.10.10.65, 10.10.10.66, 10.10.10.67, 10.10.10.68, 10.10.10.69, 10.10.10.70, 10.10.10.71, 10.10.10.72, 10.10.10.73, 10.10.10.74, 10.10.10.75, 10.10.10.76, 10.10.10.77, 10.10.10.78, 10.10.10.79, 10.10.10.80, 10.10.10.81, 10.10.10.82, 10.10.10.83, 10.10.10.84, 10.10.10.85, 10.10.10.86, 10.10.10.87, 10.10.10.88, 10.10.10.89, 10.10.10.90, 10.10.10.91, 10.10.10.92, 10.10.10.93, 10.10.10.94, 10.10.10.95, 10.10.10.96, 10.10.10.97, 10.10.10.98, 10.10.10.99, 10.10.10.100.



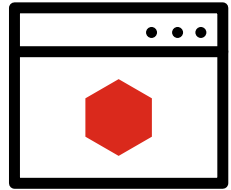

# Fortisolator



# Introducing Fortisolator



Appliance



Virtual Machine



## Secure Web Access by Browser Isolation



Safely access internet content



Clientless browser access, removing dependencies on specific devices or applications



Security Fabric integration with FortiGate and FortiMail



Boost Productivity by quickly renders safe web content for the end users



Secure Valuable Data by adding layer of advanced protection

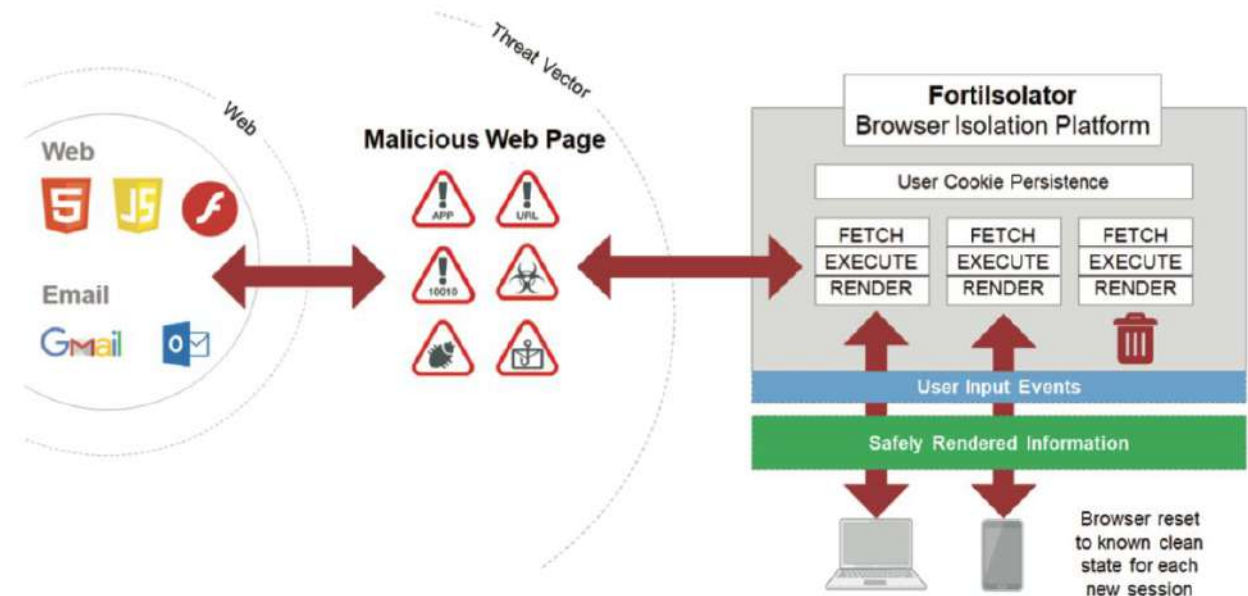

# Fortisolator Series

	FIS-1000F	FIS-VM
<b>Concurrent Browser Sessions</b>	250*	Base VM license includes 2 concurrent sessions annual subscription basis in blocks of 50 sessions
<b>Supported Browsers</b>	Chrome, Firefox, Microsoft Edge, Microsoft Internet Explorer, Safari, Opera	
<b>Integration Methods</b>	Proxy, URL Rewrite, Transparent Inline	

\* 20% of the sessions are video sessions





# FortiProxy



# Introducing FortiProxy



Appliance



Virtual Machine



Cloud



Reduce the cost and impact of downloaded content, while increasing performance by improving the speed of access



Accelerated SSL deep inspection



Protection against sophisticated web attacks



Authenticated web application control



WAN Optimization and Advanced Caching

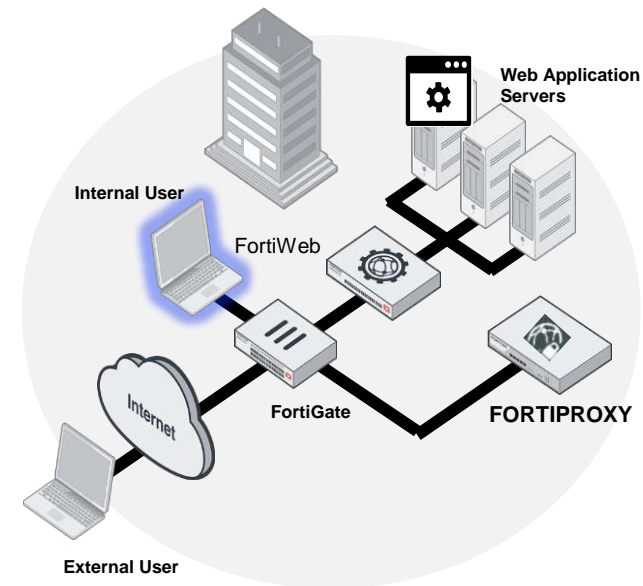

# FortiProxy Series

	FPX-400E	FPX-2000E	FPX-4000E
<b>User License</b>	500 – 4,000	2,500 – 15,000	10,000 - 50,000
<b>Total Interfaces</b>	4x GE RJ45	2 x GE RJ45 2 x GE RJ45 bypass 2 x GE SFP 2 x 10GE SFP+	4 x GE RJ45 2 x GE RJ45 bypass 2 x GE SFP 4 x 10GE SFP+
<b>Storage Capacity</b>	2x 2 TB	4x 2 TB (16 TB Max)	4x 2 TB (24 TB Max)

	FPX-VM01	FPX-VM02	FPX-VM04	FPX-VM08	FPX-VM16	FPX-UL
<b>License Capacity</b>	100 users	100 – 500 users	100 – 2,500 users	100 – 10,000 users	100 – 25,000 users	100 – 50,000 users
<b>Total Interfaces (Max)</b>	10	10	10	10	10	10
<b>CPU, memory, storage</b>	2 CPU, 2 GB RAM, 1 Disk	4 CPU, 4 GB RAM, 2 Disk	8 CPU, 8 GB RAM, 2 Disk	16 CPU, 32 GB RAM, 4 Disk	32 CPU, 64 GB RAM, 8 Disk	Unlimited CPU, Unlimited GB RAM, 16 Disk





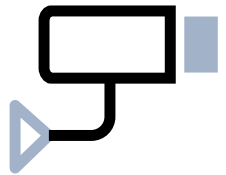

# FortiRecorder & FortiCamera



# Introducing FortiRecorder and FortiCam



Appliance



Virtual Machine



## AI-enabled video surveillance for secure and safer workplaces



Multiple recording options: continuous, event-based, scheduled, manual



Access to live and recorded video from mobile apps and browsers



Recorder available as hardware or VM deployment



Large range of cameras to fit any environment, all powered with PoE



Free professional-grade video management system (VMS)



RADIUS, LDAP, SNMP, and remote data storage support



# FortiRecorder Network Video Recorders

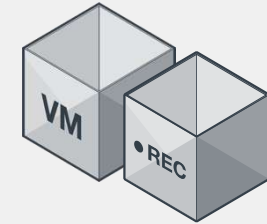

	FRC-100D	FRC-400F	FRC-VM
<b>Camera Capacity</b>	16	64	1024
<b>Form Factor</b>	Desktop	1 RU	VM
<b>Total Interface</b>	3x GE RJ45	3x GE RJ45	1 to 4 network cards supported
<b>Storage</b>	1 TB	1x 4 TB (4x 8 TB max.)	Unrestricted
<b>Features</b>	<ul style="list-style-type: none"> <li>• Web-based interface simplifies configuration and management</li> <li>• Comprehensive video management system</li> <li>• Intelligent video analysis with AI-enabled detection</li> <li>• Camera live view and video playback</li> <li>• Event monitor with timeline</li> <li>• Email notifications with snapshot preview</li> <li>• Integrated with Fortinet Security Fabric products</li> <li>• Secure proxy for 3<sup>rd</sup> party cameras</li> </ul>		
<b>Management Tools</b>	FortiCentral (Windows) FortiRecorder Mobile Apps (iOS, Android)		

# FortiCam Surveillance Cameras



**FCM-MB40**

**FCM-MD50B**

**FCM-FD50**

**FCM-PD50**

	<b>FCM-MB40</b>	<b>FCM-MD50B</b>	<b>FCM-FD50</b>	<b>FCM-PD50</b>
<b>Description</b>	Day/Night Mini Box IP Camera for Indoor	Day/Night Mini Dome IP Camera for Indoor/Outdoor	Ultra-WDR Day/Night Fixed Dome IP Camera for Indoor/Outdoor	Day/Night Mini PTZ Dome IP Camera for Indoor/Outdoor
<b>Encoder</b>	4 megapixel; H.264	4 megapixel; H.265	5 megapixel; H.265	5 megapixel; H.265
<b>Additional Features</b>	<ul style="list-style-type: none"> <li>• Compact &amp; lightweight</li> <li>• Shutter ultra-WDR</li> <li>• Wide angle 100° lens</li> <li>• Two-way audio, built-in mic and speaker</li> <li>• IR capture 15 ft / 5 m</li> <li>• 3D noise reduction</li> </ul>	<ul style="list-style-type: none"> <li>• Low-light sensor with wide 101° viewing range</li> <li>• IR capture 60 ft / 20 m</li> <li>• 3D noise reduction</li> </ul>	<ul style="list-style-type: none"> <li>• Motorized 4x autofocus zoom lens</li> <li>• Shutter ultra-WDR</li> <li>• Low-light progressive sensor</li> <li>• IR capture 100 ft / 30 m</li> <li>• Two-way audio with built-in mic</li> <li>• 3D noise reduction</li> </ul>	<ul style="list-style-type: none"> <li>• Motorized pan/tilt operation</li> <li>• Autofocus 3x zoom lens</li> <li>• 3D noise reduction</li> <li>• Low-light progressive sensor</li> <li>• IR capture 65 ft / 20 m</li> <li>• One-way audio with built-in mic</li> </ul>
<b>Total Interface</b>	1x FE RJ45, 802.3af PoE	1x FE RJ45, 802.3af PoE	1x FE RJ45, 802.3af PoE	1x FE RJ45, 802.3af POE



# FortiCam Surveillance Cameras



**FCM-SD20B**

**FCM-CB50**

**FCM-FB50**

	<b>FCM-SD20B</b>	<b>FCM-CB50</b>	<b>FCM-FB50</b>
<b>Description</b>	Ultra-WDR PTZ Speed Dome IP Camera for Indoor/Outdoor	Day/Night Compact Bullet IP Camera for Indoor/Outdoor	Ultra-WDR Day/Night Full Bullet IP Camera for Indoor/Outdoor
<b>Encoder</b>	2 megapixel; H.265	5 megapixel; H.265	5 megapixel; H.265
<b>Additional Features</b>	<ul style="list-style-type: none"> <li>• 360° continuous pan/tilt operation</li> <li>• Superior optical 30x zoom range</li> <li>• Electronic image stabilization</li> <li>• Shutter ultra-WDR with 0.005 Lux night sensitivity</li> <li>• Line in/out audio</li> <li>• 3D noise reduction</li> </ul>	<ul style="list-style-type: none"> <li>• Wide angle 4x varifocal lens</li> <li>• Low-light sensor with advanced infrared LED technology</li> <li>• IR capture 100 ft / 30 m</li> <li>• One-way audio with built-in mic</li> <li>• 3D noise reduction</li> </ul>	<ul style="list-style-type: none"> <li>• Motorized 4x autofocus zoom lens</li> <li>• Shutter ultra-WDR</li> <li>• Low-light progressive sensor</li> <li>• IR capture 100 ft / 30 m</li> <li>• Two-way audio; line in/out</li> <li>• 3D noise reduction</li> </ul>
<b>Total Interface</b>	1x FE RJ45, 802.3at PoE+ (class 4)	1x FE RJ45, 802.3af PoE	1x FE RJ45, 802.3af PoE



# Free Video Management Apps

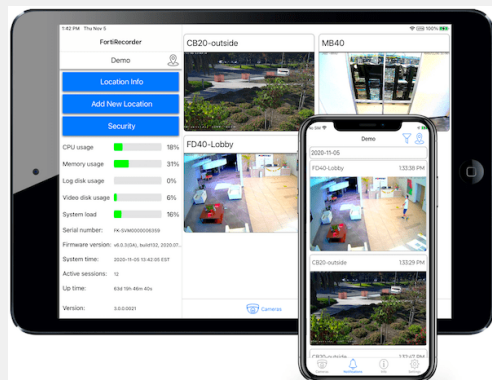

## FortiRecorder for Mobile

Easily access live videos, playback recordings, get smart notifications, or track locations within your fingertips

- Intuitive interface for viewing camera live stream, 24/7
- Receive and play back video events
- Smart event notifications
- Track multiple locations simultaneously
- Available for iOS devices (iPhone and iPad) and Android smart phones

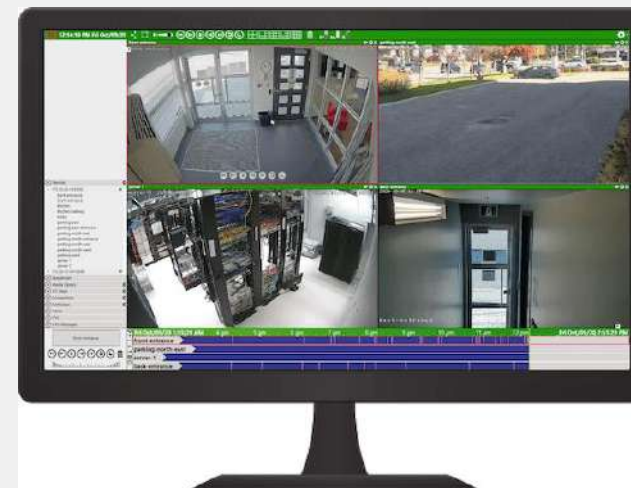

## FortiCentral for Windows

AI-enabled Video Management Software for centralized control and visibility across all surveillance cameras

- Simplified management across multiple FortiRecorder and FortiCam devices
- Flexible tiled windows with easy drag and drop
- Instant replay and simultaneous playback
- 3D maps for easy navigation
- Intelligent machine-learning analyzes and recognizes faces, objects, facemasks, and occupancy, as well as privacy protection.





# FortiTester



# Introducing FortiTester



Appliance



Virtual Machine



Network performance tester that aids in infrastructure optimization and configuration validation



Attack replay test



HTTP/HTTPS connections per second test



HTTP/HTTPS requests per second test



TCP throughput test



TCP concurrent connections test



Mixed traffic test

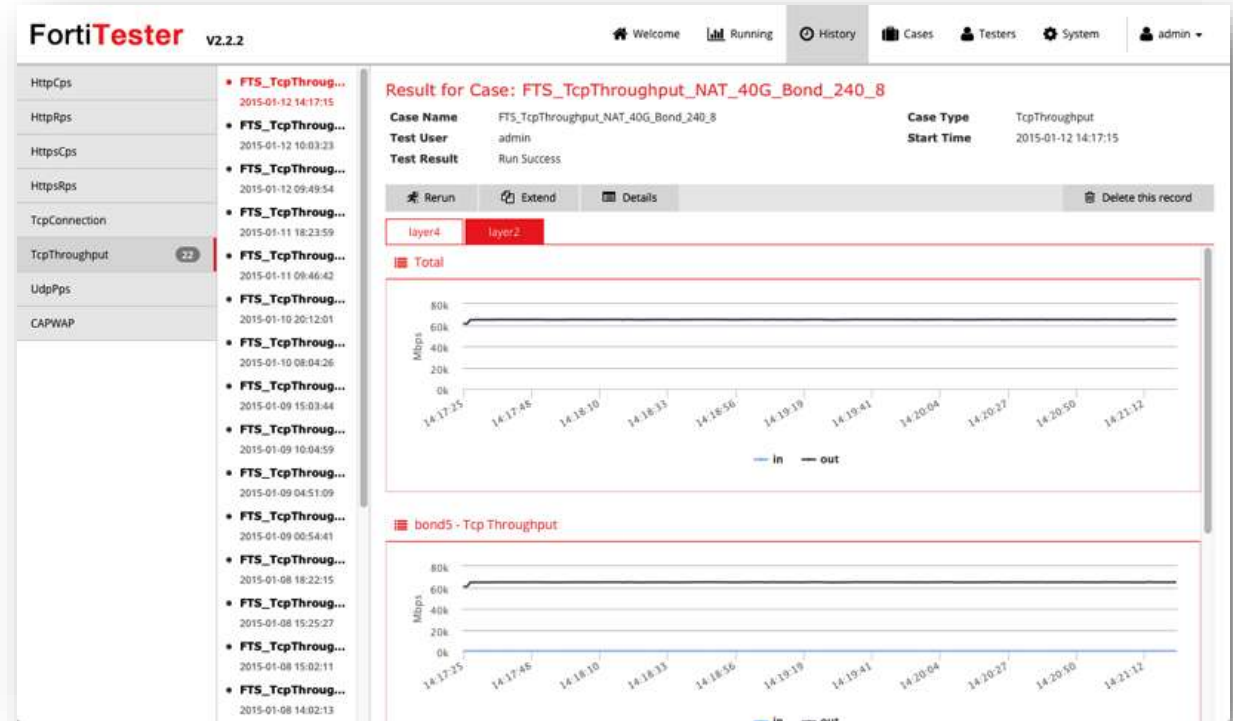



# FortiTester Series

	FTS-2000D	FTS-2000E	FTS-2500E	FTS-3000E	FTS-4000E (2 devices mode)	FTS-VM04 (vSwitch)
<b>HTTP Throughput</b>	19.9 Gbps	20 Gbps	20 Gbps	38.9 Gbps	94 Gbps	14 Gbps
<b>HTTP CPS</b>	819,000	975,000	979,000	1,570,000	1,500,000	353,000
<b>HTTP Connection</b>	9,000,000	9,000,000	9,000,000	18,000,000	76,000,000	2,000,000
<b>SSL Throughput</b>	8 Gbps	11.8 Gbps	10 Gbps	18 Gbps	28.8 Gbps	1.1 Gbps
<b>SSL CPS</b>	1,700	3,000	17,400	25,000	32,000	2,600
<b>SSL Connection</b>	15,000	60,000	15,000	20,000	30,000	15,000
<b>Total Interfaces</b>	4x 10GE SFP+, 1x MGMT GE RJ45	4x 10GE SFP+, 1x MGMT GE RJ45	4x 10GE SFP+, 1x MGMT GE RJ45	2x 40GE QSFP+, 1x MGMT GE RJ45	1x 100GE QSFP28, 1x MGMT GE RJ45	-
<b>Form Factor</b>	1U	1U	1U	1U	1U	-
<b>Storage</b>	120 GB SSD	1 TB HDD	120 GB SSD	2 TB HDD	2 TB HDD	-





# FortiToken



# Introducing FortiToken

384629

## Oath Compliant Time Based Hardware One Time Password Token



Scalable strong authentication solution for low entry cost and low total cost of ownership (TCO)



Unique online activation option reducing complexity



Reduced operations costs through leveraging existing FortiGate as the authentication server



Large, easy-to-read LCD display



# Introducing FortiToken Mobile

384629

## Oath Compliant Time Based One Time Password Soft Token



Reduced costs by leveraging existing FortiGate as the authentication server



Minimized overhead with unique online activation option



A scalable solution for low entry cost and low total cost of ownership





# FortiVoice & FortiFone



# Introducing FortiVoice & FortiFone



Appliance



Virtual Machine



Hosted



**Secure, all-inclusive business communications solution enables organizations to collaborate efficiently across offices**



Secure communications safeguard conversations



Centralized management across locations



Rich features with integrated voice, conferencing and fax



Comprehensive system monitoring and reporting



Local survivability support for business continuity



Versatile IP phone selection with HD audio clarity

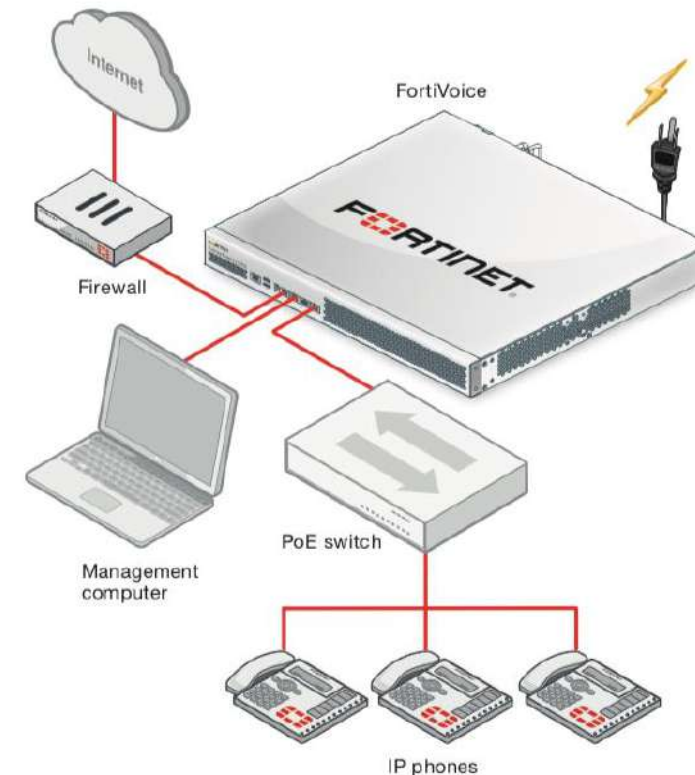

# FortiVoice Appliances



	FVE-20E2/4	FVE-50E6	FVE-100E	FVE-200F8
<b>Form Factor</b>	Desktop	Desktop	Desktop	Rack Mount (1U)
<b>VoIP trunks</b>	4	8	16	24
<b>Extensions</b>	20	50	100	200
<b>Concurrent calls</b>	8	15	30	32
<b>Auto attendants</b>	5	5	10	15
<b>Conference bridges</b>	2	2	8	10
<b>PRI (T1/E1)</b>	0	0	0	0
<b>Traditional telephone lines (FXO)</b>	2 / 4	2	4	2
<b>Analog extensions (FXS)</b>	2 / 0	2	4	2
<b>Network interfaces (RJ45)</b>	2	2	4	2
<b>Add-ons</b>	Unified Communications   Call Center   Hotel Management   FortiFone Softclient (iOS, Android, Mac, Windows)			



# FortiVoice Appliances



	FVE-300E-T	FVE-500F	FVE-2000F	FVE-5000F
<b>Form Factor</b>	Rack Mount (1U)	Rack Mount (1U)	Rack Mount (1U)	Rack Mount (1U)
<b>VoIP trunks</b>	30	50	200	500
<b>Extensions</b>	300	500	2,000	5,000
<b>Concurrent calls</b>	60	75	300	800
<b>Auto attendants</b>	20	20	100	100
<b>Conference bridges</b>	12	12	50	50
<b>PRI (T1/E1)</b>	1	0	0	0
<b>Traditional telephone lines (FXO)</b>	0	0	0	0
<b>Analog extensions (FXS)</b>	0	0	0	0
<b>Network interfaces (RJ45)</b>	5	4	4	4 + 2x SFP
<b>Add-ons</b>	Unified Communications   Call Center   Hotel Management   FortiFone Softclient (iOS, Android, Mac, Windows)			





# FortiVoice Virtual Machines

	FVE-VM-50	FVE-VM-100	FVE-VM-200	FVE-VM-500	FVE-VM-2000
<b>Form Factor</b>	VM	VM	VM	VM	VM
<b>VoIP trunks</b>	8	16	24	50	200
<b>Extensions</b>	50	100	200	500	2,000
<b>Concurrent calls</b>	15	30	32	75	300
<b>Auto attendants</b>	5	10	15	20	100
<b>Conference bridges</b>	2	8	10	12	50
<b>Add-ons</b>	Unified Communications   Call Center   Hotel Management   FortiFone Softclient (iOS, Android, Mac, Windows)				

	FVE-VM-5000	FVE-VM-10000	FVE-VM-20000	FVE-VM-50000
<b>Form Factor</b>	VM	VM	VM	VM
<b>VoIP trunks</b>	500	1,000	2,000	3,000
<b>Extensions</b>	5,000	10,000	20,000	50,000
<b>Concurrent calls</b>	800	1,500	1,500	2,000
<b>Auto attendants</b>	100	100	150	200
<b>Conference bridges</b>	50	50	50	100
<b>Add-ons</b>	Unified Communications   Call Center   Hotel Management   FortiFone Softclient (iOS, Android, Mac, Windows)			



# FortiVoice Add-on Services



## Unified Communications

Extends capability beyond calls to optimize communication efficiency

- Microsoft Teams integrations: make calls within Teams, share contact or launch FortiFone Softclient for more options
- Start a video call from FortiFone Softclient
- View colleagues' presences in real time from FortiFone Softclient
- Instant messaging with colleagues from FortiFone Softclient



## Call Center

Turn FortiVoice to an efficient call center solution for better customer satisfaction

- Web-based console
- Dynamic call center agents
- Flexible call distribution
- Skill based routing
- Granular statistic on agent and call queue performance
- Highly detailed custom call reporting
- Licenses required only for Call Center and for agents



## Hotel Management

Provides better guest services and communications with hospitality functionality

- Enriched features with check-in/check-out control, wake-up calls, room conditions codes, etc.
- Compatible with industry-leading property management systems
- Licenses required for Hotel and for rooms
- Supports FortiVoice protocol (compatible with Mitel SX 2000 protocol). MICROS FIAS protocol and Control UHLL protocol



# FortiFone Desk Phones



**FON-175**

A two-line IP telephone with 11 feature keys and color screen

- HD audio quality
- 2.4" color screen
- 5 dedicated feature keys
- Full duplex speakerphone
- 2 x 10/100 Ethernet ports
- Integrated Power over Ethernet (PoE) support



**FON-380**

A mid-range phone with easy-to-use design for efficient communications

- HD audio quality
- 3.5" color screen
- 10 dedicated feature keys
- 28 programmable phone keys
- Full duplex speakerphone
- 2 x 10/100/1000 Ethernet ports
- Integrated Power over Ethernet (PoE) support



**FON-480**

Features a color-rich screen with dedicated feature keys and programmable keys

- HD audio quality
- 4.3" color screen
- 10 dedicated feature keys
- 45 programmable phone keys
- Full duplex speakerphone
- 2 x 10/100/1000 Ethernet ports
- Integrated Power over Ethernet (PoE) support
- Built-in Bluetooth headset support

*\*Availability of FortiFone models might vary by country, please check with your local Fortinet sales or partners for details.*



# FortiFone Desk Phones



**FON-570**

Comes with a touchscreen, dedicated feature keys and programmable keys

- HD audio quality
- 7" color screen
- 7 dedicated feature keys
- 109 programable phone keys
- Full duplex speakerphone
- 2 x 10/100/1000 Ethernet ports
- Integrated Power over Ethernet (PoE) support



**FON-675i**

An executive phone with vivid touchscreen and programmable appearance keys

- HD audio quality
- 7" TFT color screen
- 5 dedicated feature keys
- 112 programable phone keys
- Camera with adjustable position
- Full duplex speakerphone
- 2 x 10/100/1000 Ethernet ports
- Integrated Power over Ethernet (PoE) support



**FON-575**

A high-performance phone with color screens and up to 106 programmable keys

- HD audio quality
- Color screens: 4.3" + 2 built-in 3.5" side displays
- 11 dedicated feature keys
- 106 programable phone keys
- Full duplex speakerphone
- 2 x 10/100/1000 Ethernet ports
- Integrated Power over Ethernet (PoE) support

*\*Availability of FortiFone models might vary by country, please check with your local Fortinet sales or partners for details.*



# FortiFone Conference & Lobby/Hotel Phones



**FON-C71**

Offers premium HD audio, full-duplex technology and acoustic echo cancelling on the three microphone array

- HD audio quality
- 3.1" pixel graphic display
- Full duplex speakerphone
- Three microphone array
- 10/100 Ethernet port
- Integrated Power over Ethernet (PoE) support
- Wi-Fi/Bluetooth support to connect your mobile and PCs



**FON-H25**

A customizable IP phone with high quality audio and dedicated feature keys

- 6 dedicated feature keys
- Full duplex speakerphone
- 2 x 10/100 Ethernet ports
- Integrated Power over Ethernet (PoE) support



**FON-H35**

A customizable IP phone with high quality audio, dedicated feature keys and color screen

- 3.5" color display
- Dedicated feature keys
- 6 programable keys
- Full duplex speakerphone
- 2 x 10/100 Ethernet ports
- Integrated Power over Ethernet (PoE) support

*\*Availability of FortiFone models might vary by country, please check with your local Fortinet sales or partners for details.*



# FortiFone Cordless Phones

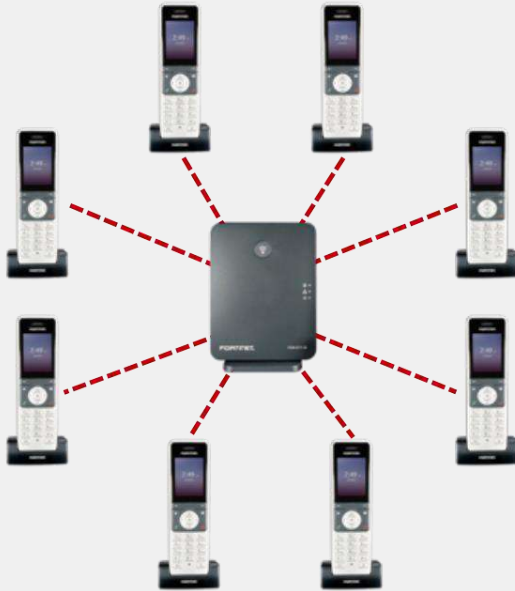

## Single-base Cordless Solution

Ideal for offices with smaller areas, the solution is designed to manage the registration and calls for up to 8 handsets with FortiVoice

Minimum requirements:

- One (1) FON-D71-B single-base station
- One (1) FON-D71-H cordless handset

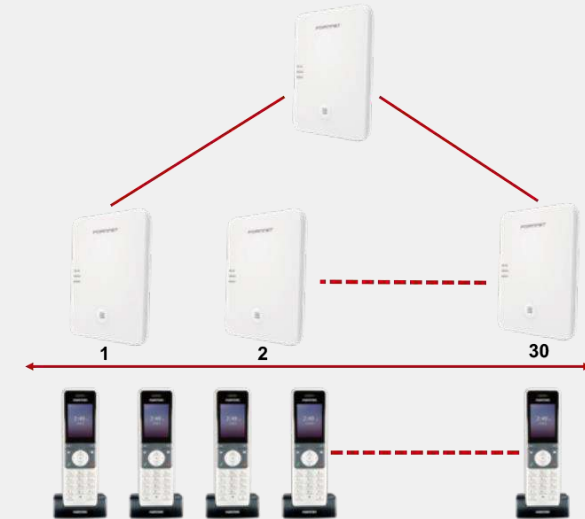

## Multi-cell Cordless Solution

Ideal for offices with a large footprint or in a multiple-floor building, the solution supports up to 100 handsets.

Minimum requirements:

- One (1) FON-D72-B multi-cell base station
- One (1) FON-D72-M station manager
- One (1) FON-D71-H cordless handset



# FortiFone Cordless Phones



**FON-D71-H**



**FON-D71-B**



**FON-D72-B**

High-quality DECT handset delivering HD sound quality and DECT encryption

- HD audio quality
- 2.4" pixel graphic display
- Full duplex speakerphone
- Up to 30 hours of talk time on a single charge
- Range: 150 feet indoors
- Supports up to 8 handsets
- 10/100 Ethernet port

A single-base DECT station for businesses with a smaller footprint

- Single-base station supports up to 8 handsets
- Able to handle up to 8 concurrent calls
- Indoor range up to 50 meters
- Outdoor range up to 300 meters

A multi-cell DECT base station for businesses with a large footprint

- Supports up to 8 handsets per base station, up to a maximum of 100 handsets per FON-D72 solution (w/ multiple bases)
- Handles up to 100 concurrent calls (w/ multiple bases)
- Indoor/Outdoor ranges: up to 50 / 300 meters per base station
- Seamless handover and roaming between bases

*\*Availability of FortiFone models might vary by country, please check with your local Fortinet sales or partners for details.*





# FortiFone Softclient

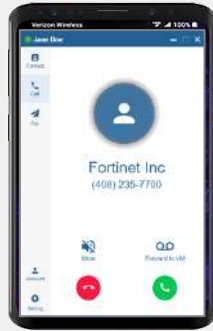

## FortiFone Softclient for Mobile

A customizable IP phone with high quality audio and dedicated feature keys (Android and iOS support)

- Integrated UI for calling, conferencing, fax, and more, directly from a smartphone
- Easy call control: hold/unhold, mute/unmute, transfer, swap and merge calls, and more.
- Access company directory and favorites; call your colleague or customers with a single tap
- Visual voicemail
- Hands-free speaker phone option
- Support headset use



## FortiFone Softclient for Desktop

A customizable IP phone with high quality audio, dedicated feature keys and color screen (Mac and Windows support)

- Integrated UI for calling, conferencing, fax, and more, directly from a computer or a notebook.
- Easy call control: hold/unhold, mute/unmute, transfer, swap and merge calls, and more.
- Access company directory and favorites; call your colleague or customers with a single tap
- Visual voicemail
- Quick access to History, Contact, and Voicemail
- Supports headset use





The FortiWLC logo icon, featuring two vertical lines with red dots inside a black circle, is on the left side of the header.

# FortiWLC



# Introducing FortiWLC



Appliance



Virtual Machine



**Wi-Fi Controller that manages authentication, encryption and virtual private network connections for the wireless network.**



Superior density, scalability, and mobility



Protection for sensitive data and help to meet compliance



Option for Single Channel or Multi-Channel deployment



Simplified deployment and capacity expansion



Scalability from 1 to 10,000 APs



Wireless device location tools included with no additional license

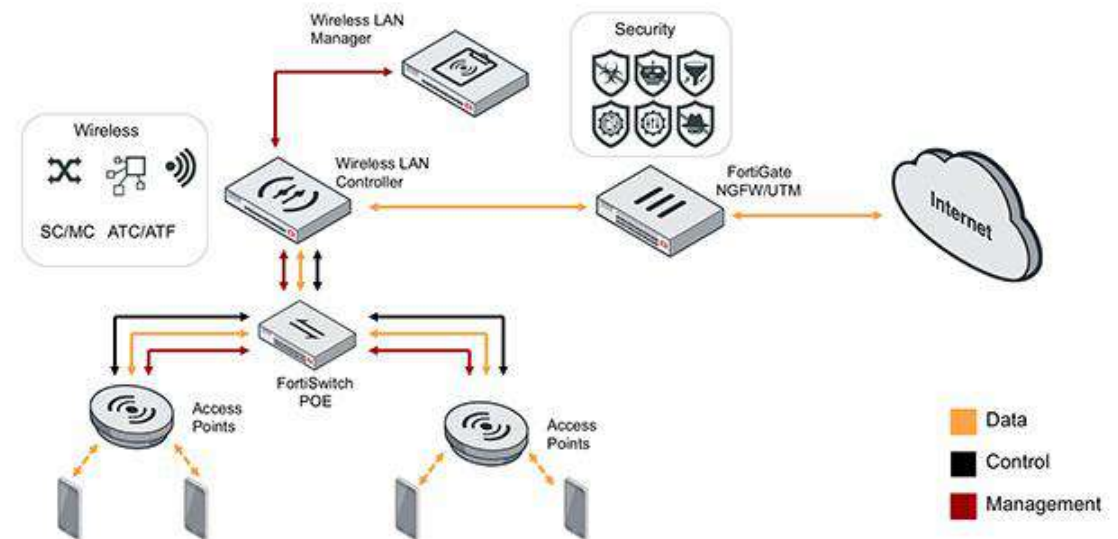

# FortiWLC Series

	FWC-50D	FWC-200D	FWC-500D	FWD-1000D	FWD-3000D
<b>Max. Access Points</b>	50	200	500	1,000	3,000
<b>Max Clients</b>	1,500	2,500	7,500	20,000	45,000
<b>Total Interface</b>	4x GE RJ45	4x GE RJ45	4x GE RJ45 4x GE SFP 2x 10GE SFP+	2x GE RJ45 4x 10GE SFP+	2x GE RJ45 8x 10GE SFP+
<b>Form Factor</b>	1 RU	1 RU	1 RU	2 RU	2 RU

	FWC-50D-VM	FWC-200D-VM	FWC-500D-VM	FWD-1000D-VM	FWD-3000D-VM
<b>Max. Access Points</b>	50	200	500	1,000	3,000
<b>Max Clients</b>	1,500	2,500	7,500	20,000	45,000
<b>Max vCPU</b>	4	4	8	24	48
<b>Max RAM</b>	4 GB	8 GB	16 GB	32 GB	64 GB





# FortiWLM



# Introducing FortiWLM



Appliance



Virtual Machine



Platform for secure access applications focused on WLAN management, interference detection and security.



Network management that supports monitoring, configuring and reporting of wireless network health



RF interference detection and mitigation



A choice of appliances sized to fit your business scale

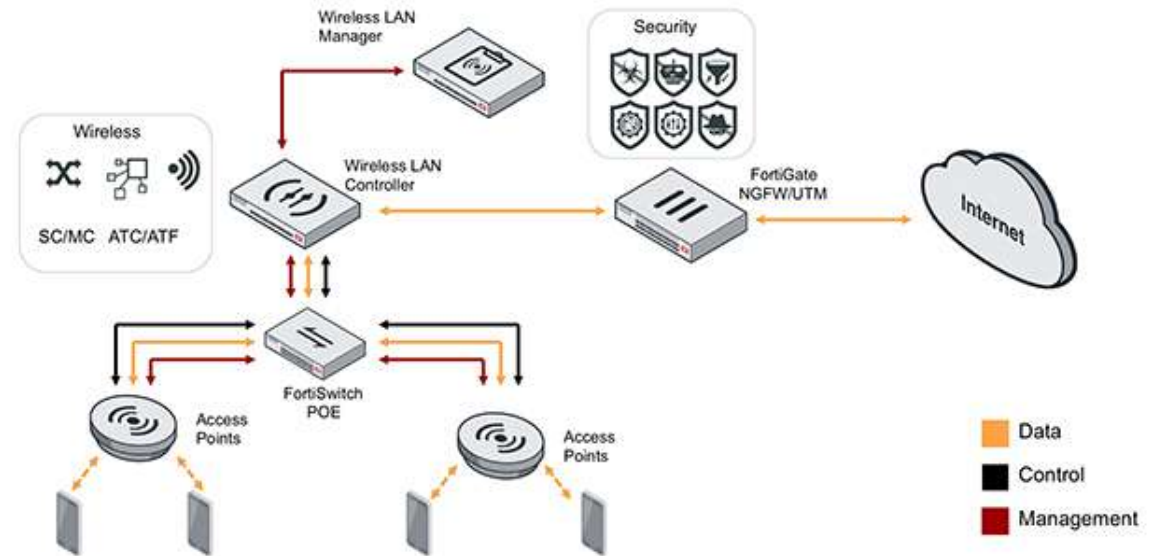

# FortiWLM Series

	FWM-100D	FWM-1000D	FWM-VM
Number of Infrastructure APs	1,000	15,000	15,000
Number of Stations	5,000	75,000	75,000
Total Interface	4x GE RJ45	4x GE RJ45 4x GE SFP	-
Form Factor	1 RU	1 RU	-





# Other Information



# Virtual Appliance Platforms

**B** BYOL **P** PAYG

	VMWare vSphere	Citrix Xen Server	Xen	KVM	Microsoft Hyper-V	Nutanix AHV	Amazon AWS	Microsoft Azure	Oracle OPC	Google GCP	AliCloud
FortiGate-VM*	✓	✓	✓	✓	✓	✓	B P	B P	B P	B P	B P
FortiManager-VM	✓	✓	✓	✓	✓	✓	B P	B	B	B	B
FortiAnalyzer-VM	✓	✓	✓	✓	✓	✓	B P	B	B	B	B
FortiWeb-VM	✓	✓	✓	✓	✓	✓	B P	B P	B	B	B
FortiWeb Manager-VM	✓						B				
FortiMail-VM	✓	✓		✓	✓	✓	B P	B P		B	
FortiAuthenticator-VM	✓		✓	✓	✓		B	B	B		
FortiADC-VM	✓	✓	✓	✓	✓	✓	B P	B P	B P	B P	
FortiVoice-VM	✓	✓		✓	✓		B	B			
FortiRecorder-VM	✓	✓		✓	✓		P				
FortiSandbox-VM	✓			✓	✓	✓	B P	P			
FortiSIEM	✓			✓	✓	✓	B	B			B
FortiProxy-VM	✓			✓			B	B			

\* Also support AzureStack and RackSpace (PAYG)





**FORTINET®**

