

BARR

MARINE BY EDM

www.barrmarine.net

P.O. Box 190
100 Douglas Way
Natural Bridge Station, VA. 24579

Toll Free: (866) 255-9265
Phone: (540) 291-4180
Fax: (540) 291-4185

E-Mail: sales@barrmarine.net

MADE IN THE U.S.A.
QUALITY SINCE 1933

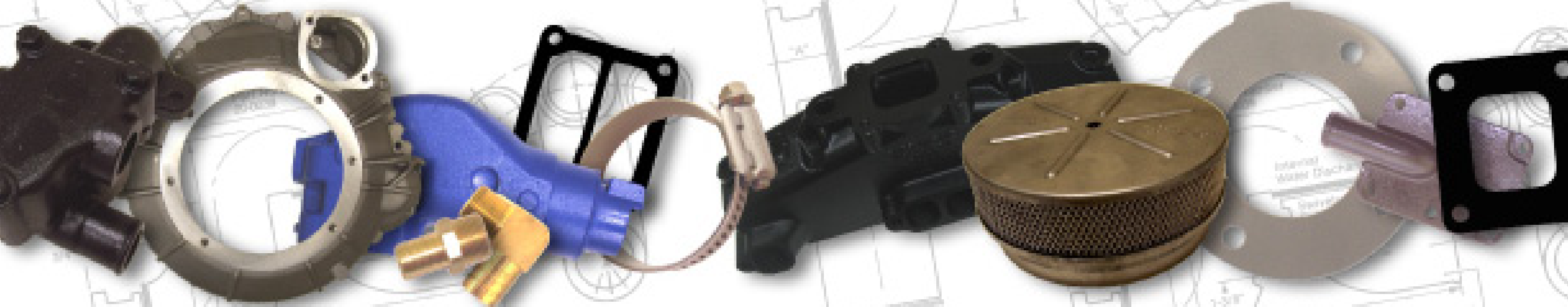

BARRMARINE.NET

THERE ARE NONE BETTER

Notes

TABLE OF CONTENTS

Barr Marine By EDM

100 Douglas Way

P.O. Box 190

Natural Bridge Station, VA 24579

Toll Free: (866) 255-9265 Phone: (540) 291-4180

Fax: (540) 291-4185

BARR

Introduction	1
Engine Exhaust Systems	2
Conversion List	3
Identification List.....	4

Manifolds and Risers Section

Barr Marine Diesel Riser	5
Chevrolet Aluminum Exhaust System	6-7
Chris Craft	8-11
Chrysler	12-15
Crusader	16-21
Detroit Diesel	22
Flagship	23-24
Graymarine	25-26
Indmar	27-29
Interceptor	30-33
MerCruiser	34-54
OMC	55-66
Perkins	67
Pleasurecraft	68
Universal Atomic 4	69
Volvo	70-76
Waukesha	77

Miscellaneous Items

Center Discharge Exhaust Riser	78
Center Discharge Manifold and Riser System Dimensions	79-80
Exhaust Risers and Connectors	81-83
Thermostats and Thermostat Housing Assemblies	84
Adaptor Bell Housings	85
Rubber Engine Mounts	86
Torsional Dampers	87
Flame Arrestors	88
Cross Over Reference Guide	89-92

It's the Law Know Your Rights	93
Warranties	94-95

INTRODUCTION

Business Philosophy

Barr Marine by EDM, a pioneer in the marine engine component replacement field, was founded in 1933 by Horatio W. Barraclough, Sr. under the name Marine Salvage. Today, Barr Marine by EDM is the last and only U.S. Manufacturer of inboard parts in the World and offers the largest selection of inboard parts available for immediate shipment. The foundation of this growth began in 1933 with Barr Marine's customer-centered philosophy. Simply stated, we know the products and since 1933 our staff has made it a point to answer questions promptly while providing diagrams and dimensions for added technical support.

Redefining the Industry

There are several distinctive factors that separate Barr Marine by EDM from the competition:

- More variety. More available configurations. More hard to find parts. Barr Marine offers in stock availability of the largest selection of inboard marine parts
- Barr Marine is the only manufacturer that paints replacement components to match original manufactures colors
- Superior Quality and a 3 Year Limited Warranty on exhaust manifolds, risers and exhaust connectors
- Manifolds and Risers include all mounting gaskets and hardware
- All castings have a thicker interior wall and are packed in foam for added protection prior to shipping and storage
- Same-Day Shipment on orders entered by 3:00pm Eastern Standard Time USA (UPS Shipments)
- On-Time delivery
- Toll-free technical support 866-255-9265
- World-Wide distribution

When you're ready to take the performance of your parts distribution company to a whole new level, contact Barr Marine by EDM.

BARR
MARINE BY EDM

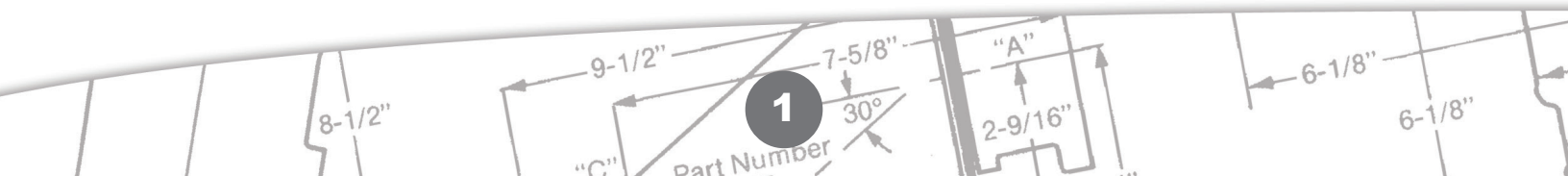



ENGINE EXHAUST SYSTEMS

During the operation of any marine engine-gas or diesel-exhaust gases are produced and must be removed from the engine and conducted outside the boat. While there are two basic exhaust systems, wet and dry, the wet system is the one most often found in pleasure boats as well as many work boats. This system mixes the exhaust gases with engine-cooling water and then discharges them through the transom of the boat via an exhaust line.

Exhaust Manifold

Attached to the engine is an exhaust manifold with its exhaust inlets matching the exhaust outlet ports of the engine. Circulating cooling water through the water jacket surrounding the exhaust gas chamber cools this manifold.

Exhaust Connector

At the exhaust end of the manifold is an exhaust connector. This connector is an intermediary between the manifold and an exhaust hose or pipe. This connector also mixes the exhaust gases with water to further cool the gases, and it operates as a means for directing the gas and water outflows so that a connection can be made between the manifold and the exhaust tubing.

Particular attention must be paid to the relative height difference between the center line of the exhaust end of the center line of the transom overboard exhaust fitting, the exhaust connector can be exhaust dump or drop of a convenient angle.

In those instances where the manifold is not appreciably above or is below the overboard fitting, an exhaust riser is used. By design, the riser acts as a dam to keep both exhaust-cooling water and seawater from back flooding into the engine and destroying it.

Back Pressure

From an engineering viewpoint, the most critical design requirement for exhaust systems is to limit the backpressure on the engine to a minimum. Backpressure is the pressure that builds up in the exhaust manifold engine exhaust outlets. The lower the pressure in the exhaust, the more efficient the operation of the engine. Low backpressure is achieved by designing exhaust passages to minimize resistance to the flow of gases and to prove for a uniform gas flow away from all cylinders.

Barr manifolds and exhaust connectors are designed to minimize backpressure. In many cases, after replacing an OEM manifold with Barr replacement parts, more r.p.m.'s are achieved.

Replacement Exhaust Systems

When the need arises to replace an OEM-installed manifold and/or exhaust connector, one of the three situations will exist: replacement of both manifold and connector, replacement of the manifold only, or replacement of the exhaust connector only.

When replacing both manifold and connector, normally there are no problems in matching, and connection to existing exhaust lines is usually very easy. When replacing just the manifold or just the exhaust connector, problems can arise in matching the replacement part to the existing part. Barr recognizes these problems and, wherever possible, has provided the necessary adaptors for connecting a Barr replacement manifold or exhaust connector to original exhaust parts.

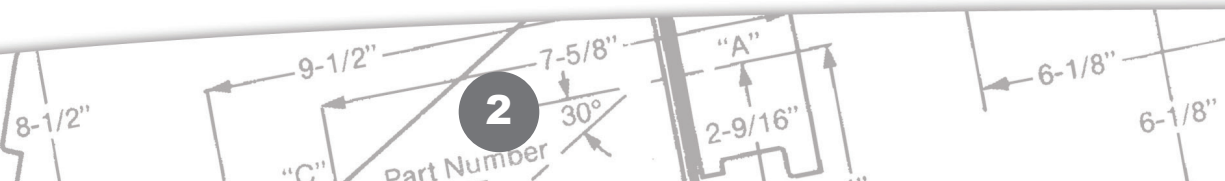

COMPLETE LIST OF BARR CONVERSION MANIFOLDS

ENGINE APPLICATION

Buick V8: 364, 401 & 425 C.I.D.; 1957-66
Buick V8: 400, 435 & 455 C.I.D.; 1967-76
Buick V6: 198, 225 & 231 C.I.D.; All Models
Caterpillar V8 Diesel: 636 C.I.D.; Naturally Aspirated
Chevrolet 4 Cylinder: 153 & 181 C.I.D.
Chevrolet 6 Cylinder: 194, 230, 250 & 292 C.I.D.; 1962-75
Chevrolet V8 OHV: 235 & 283 C.I.D.; 1955-57
Chevrolet V8 OHV: 305, 307, 327, 350 & 400 C.I.D.; 1962 Up
Chevrolet V8 OHV: 348 & 409 C.I.D. 1958-65
Chevrolet V8 OHV: 396, 427 & 454 C.I.D.; 1966 Up
Chevrolet V8 OHV: 396, 427 & 454 C.I.D.; 1966 Up
Chevrolet V8 OHV: 396, 427 & 454 C.I.D.; 1966 Up
Chevrolet V8 : Fits All Small Block Chevy 283-400 C.I.D.
Chevrolet V8 : Fits All Small Block Chevy 283-400 C.I.D.
Detroit Diesel V8: 6.2 Liter
Detroit Diesel V8: 8.2 Liter
Detroit Diesel: 3/71 & 6V/71
Detroit Diesel: 4/71 & 8V/71 (Will Fit Early 92 Series/Call Barr)
Detroit Diesel: 6/71 & 12V/71 (Will Fit Early 92 Series/Call Barr)
Ford Falcon, Comet 6 Cylinder 144 & 177 C.I.D.; 1960-64
Ford V8: Fits 260, 289, 302 & 351 C.I.D. (Windsor Models Only)
Ford, Lincoln, Mercury: 460 C.I.D.; All Years
Ford & Mercury V8 OHV: 239, 292 & 312 C.I.D.
Ford & Mercury V8: 221, 260 & 289 C.I.D.; 1962 Up
Ford & Mercury V8: 302 & 351 C.I.D. Windsor 2 Barrel Carburetor
Ford & Mercury V8 OHV: 332, 352, 390 and 427 C.I.D. ;1958-67
Oldsmobile V8 Diesel: 260 & 350 C.I.D.; 1978 Up
Oldsmobile Rocket V8: 330, 350, 400, 425 & 455 C.I.D.

PART NUMBER

BV-1-57
BV-1-67
BV6-1-75
CAT-1-3208
MC-1-0120
C-1-6364
CHV-1-5557
CHV-1-63
CHVA-1-58
CHVA-1-65
CHVA-1-84**
CHVA-1-92#
CHV-1-83**
CHV-1-92#
CHD-1-82
DD-1-501
DD-1-3710
DD-1-4710
DD-1-6710
FC-1-60
FM-1-83***#
FM 1 7275
FM-1-5457
FM-1-6268
FM-1-6970##
FE-1-58
OR-1-73
OR-1-73

**CENTER RISER MANIFOLD

#ALUMINUM MANIFOLD

##WILL NOT FIT CLEVELAND ENGINES

BARR
MARINE BY EDM

MANIFOLD END PLATE & GASKET IDENTIFICATION LISTING

Manifold Part #	Front End Plate	Gasket	Exhaust End Plate	Gasket	Header Adaptor
BV-1-57	1-0032	1-0019	1-0025	1-0019	1-0001
BV-1-67	1-0032	1-0019	1-0025	1-0019	1-0001
BV6-1-75	1-0092	1-0022	1-0024##	1-0022	1-0000
C-1-6364	1-0032	1-0019	1-0025	1-0019	1-0001
C6-1-M7M27	1-0056	1-0062	1-0067*	1-0068	1-0007
C6-1-M47	1-0057	1-0062	1-0067*	1-0068	1-0007
CAT-1-3208	DA-1-6371L2/R2	1-0019	1-0025	1-0019	1-0001
CHD-1-82	1-0036	1-0019	1-0025	1-0019	1-0001
CHV-1-5557	1-0042	1-0022	1-0024	1-0022	1-0000
CHV-1-63	1-0032	1-0019	1-0025	1-0019	1-0001
CHVA-1-58	1-0032	1-0019	1-0025	1-0019	1-0001
CHVA-1-65	1-0032	1-0019	1-0025	1-0019	1-0001
CM-1-5665	1-0092	1-0022	1-0024##	1-0022	1-0000
D-1-M6M26	1-0056	1-0062	1-0067*	1-0068	1-0007
D-1-M46SP	1-0057	1-0062	1-0067*	1-0068	1-0007
D1-M46ST	1-0057	1-0062	1-0067*	1-0068	1-0007
DD-1-501	1-0036	1-0019	1-0025	1-0019	1-0001
FC-1-60	1-0042	1-0022	1-0024	1-0022	1-0000
FE-1-58	1-0032	1-0019	1-0025	1-0019	1-0001
FM-1-5457	1-0031	1-0022	1-0024	1-0022	1-0000
FM-1-6970	1-0032	1-0019	1-0025	1-0019	1-0001
FM-1-7275	1-0032	1-0019	1-0025	1-0019	1-0001
GR-1-162**	1-0059	1-0060	GR-1-0001**	N/A	N/A
GR-1-175**	1-0059	1-0060	GR-1-0001**	N/A	N/A
GR-1-226	1-0009	1-0011	GR-1-0001**	N/A	N/A
GR-1-3273L	GR-1-0005L	GR-1-0006	GR-1-0003L	GR-1-0006	1-0069
GR-1-3273R	GR-1-0005R	GR-1-0006	GR-1-0003R	GR-1-0006	1-0069
GR-1-3274L	GR-1-0005L	GR-1-0006	GR-1-0002L	GR-1-0006	1-0002
GR-1-3274R	GR-1-0005R	GR-1-0002R	GR-1-0002R	GR-1-0006	1-0002
GR-1-6470	GR-1-6470A	1-0019	1-0036##	1-0019	1-0001
INT-1-5457L	1-0072	1-0022	1-0024##	1-0022	1-0000
INT-1-5457R	1-0074	1-0022	1-0024##	1-0022	1-0000
INT-1-58L	1-0077	1-0019	1-0025##	1-0019	1-0001
INT-1-58R	1-0076	1-0019	1-0025##	1-0019	1-0001
INT-1-6268L	1-0072	1-0022	1-0024##	1-0022	1-0000
INT-1-6268R	1-0074	1-0022	1-0024##	1-0022	1-0000
MC-1-0120	1-0075	1-0022	1-0092	1-0022	NOT REQ'D
MC-1-6364	C-1-6365B	1-0019	1-0036	1-0019	NOT REQ'D
OF-1-60	1-0036	1-0019	1-0025	1-0019	1-0001
OR-1-73	NOT REQ'D	NOT REQ'D	1-0080	1-0082	1-0081
V6D-1-478	V8D-1-0002	V8D-1-0003	V8D-1-0001##	V8D-1-0003	V8D-1-0004
V8D-1-637	V8D-1-0002	V8D-1-0003	V8D-1-0001##	V8D-1-0003	V8D-1-0004

*NOTE: MANIFOLDS WITH FOUR BOLT STYLE AND FLANGES REQUIRE ADAPTOR # 1-0061 AND GASKET 1-0062 BETWEEN MANIFOLD AND END PLATE.

NOTE: PART # GR-1-0001 IS A REPLACEMENT FOR THE ORIGINAL GRAY THREADED FLANGE AND IS NOT SUPPLIED WITH THE MANIFOLD. MANIFOLDS MARKED () THUS CAN BE USED WITH THE ORIGINAL GRAY EXHAUST FITTING.

HEADER ADAPTOR FURNISHED INSTEAD OF EXHAUST END PLATE.

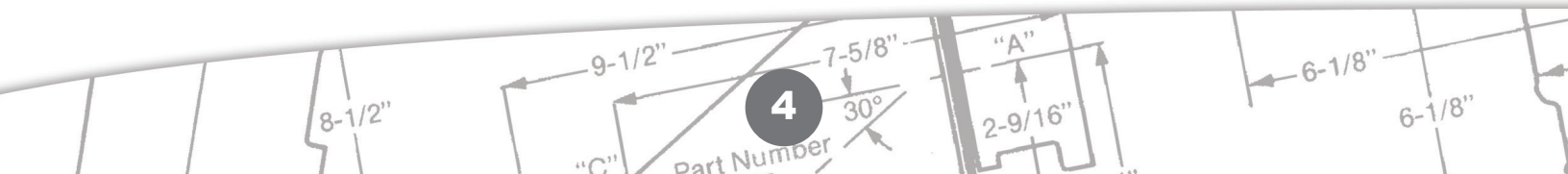

Barr Marine Diesel Engine Riser



20 0094



20 0101



20-0094	Versatile 1 1/2" N.P.T. exhaust riser. Approx. 10 lbs in weight; Gray Iron.
20-0101	Versatile 1 1/2" N.P.T. exhaust riser. Approx. 2 1/2 lbs. in weight; Aluminum.
50-090-150	1 1/2" N.P.T. Pipe Plug

BARR
MARINE BY EDM

Chevrolet V8-283, 302, 305, 307, 327 and 350 C.I.D.

Discharge
"C"
Part Number
20-0000

ALL MODELS CENTER RISER GENERIC

"A"
2"
Internal
Water
Discharge

Aluminum



CHV 1 92

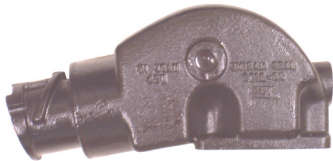

20 0107



20 0108



20 0087P



20 0093P



20 0089P



CHV 1 92P



20 0107P



1 0105



1 0107



CHV 47 0000

CHV-1-92	Water cooled center discharge manifold to fit the small block GM engine (3/4" N.P.T. cooling hose connections). All years.
20-0108	Water cooled center discharge riser (3/4" N.P.T. cooling hose connection). Standard for use with 3" I.D. exhaust hose.
20-0107	Water cooled center discharge riser (3/4" N.P.T. cooling hose connection). Standard for use with 4" I.D. exhaust hose.
1-0105	Center riser manifold-to-riser gasket for fresh water cooling.
1-0107	Center riser manifold-to-riser gasket (raw water cooling).
20-0107P	Riser mounting package for both 20-0107 and 20-0108.
20-0087P	90 degree exhaust elbow adaptor (includes adaptor, hose and clamps). For use with 3" I.D. exhaust hose.
20-0089P	30 degree exhaust elbow adaptor (includes adaptor, hose and clamps). For use with 3" I.D. exhaust hose.
20-0093P	90 degree exhaust elbow adaptor (includes adaptor, hose and clamps). For use with 3 1/2" or 4" I.D. exhaust hose.
CHV-1-92P	Manifold mounting package (includes bolts and pipe plugs).
CHV-47-0000	Manifold to cylinder head gasket.

Note:
Manifold includes CHV 1 92P (mounting package to head) and risers include 20 0107P (mounting package to manifold).

The center riser is a two-piece aluminum manifold/riser ideally suited for replacement use where riser protection is required. The Barr Center Riser aluminum manifold/riser uses flexible exhaust hose which facilitates connection to existing exhaust lines. All elbows (cast iron) can swivel inboard or outboard for perfect fit. The Barr Center Riser aluminum manifold/riser is designed to limit back pressure on the engine, resulting in more efficient engine performance. The manifold and riser can be reversed and will fit either side of the engine.

The Barr Center Riser aluminum manifold/riser is cast of 356 T6 aluminum, well suited for fresh water marine applications. Barr Marine's Center Riser aluminum manifold/riser come with a one year warranty. However, Barr Marine By EDM does not recommend use of this product in salt water applications and does not warrant this product in salt water due to extreme corrosion.

BARR
MARINE BY EDM



Chevrolet Big Block 427 and 454 C.I.D.

ALL MODELS CENTER RISER GENERIC

Aluminum



CHVA 1 92

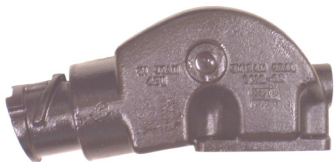

20 0107



20 0108



20 0087P



20 0093P



20 0089P

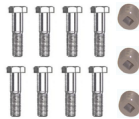

CHVA 1 92P



20 0107P



1 0105



1 0107



CHVA 47 0000

CHVA-1-92	Water cooled center discharge manifold to fit the big block GM engine (3/4" N.P.T. cooling hose connections). All years.
20-0108	Water cooled center discharge riser (3/4" N.P.T. cooling hose connection). Standard for use with 3" I.D. exhaust hose.
20-0107	Water cooled center discharge riser (3/4" N.P.T. cooling hose connection). Standard for use with 4" I.D. exhaust hose.
1-0105	Center riser manifold-to-riser gasket for fresh water cooling.
1-0107	Center riser manifold-to-riser gasket (raw water cooling).
20-0107P	Riser mounting package for both 20-0107 and 20-0108.
20-0087P	90 degree exhaust elbow adaptor (includes adaptor, hose and clamps). For use with 3" I.D. exhaust hose.
20-0089P	30 degree exhaust elbow adaptor (includes adaptor, hose and clamps). For use with 3" I.D. exhaust hose.
20-0093P	90 degree exhaust elbow adaptor (includes adaptor, hose and clamps). For use with 3 1/2" or 4" I.D. exhaust hose.
CHVA-1-92P	Manifold mounting package (includes bolts and pipe plugs).
CHVA-47-0000	Manifold to cylinder head gasket.

Note:
 Manifold includes CHV 1 92P (mounting package to head) and risers include 20 0107P (mounting package to manifold).

The center riser is a two-piece aluminum manifold/riser ideally suited for replacement use where riser protection is required. The Barr Center Riser aluminum manifold/riser uses flexible exhaust hose which facilitates connection to existing exhaust lines. All elbows (cast iron) can swivel inboard or outboard for perfect fit. The Barr Center Riser aluminum manifold/riser is designed to limit back pressure on the engine, resulting in more efficient engine performance. The manifold and riser can be reversed and will fit either side of the engine.

The Barr Center Riser aluminum manifold/riser is cast of 356 T6 aluminum, well suited for fresh water marine applications. Barr Marine's Center Riser aluminum manifold/riser come with a one year warranty. However, Barr Marine By EDM does not recommend use of this product in salt water applications and does not warrant this product in salt water due to extreme corrosion.

BARR
 MARINE BY EDM

Chris Craft V8-283, 302, 305, 307, 327 and 350 C.I.D.

Discharge
"C"
Part Number
20-0000

ALL MODELS LOG STYLE DIRECT REPLACEMENT

"A"
2"
Internal
Water
Discharge

The CC-1-07686 must not be used in 3 pass plumbing systems!

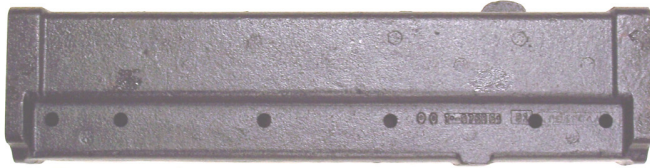

CC 1 07686



CC 20 08288



CC 20 08289



CC 20 07605



CC 20 07593

CC-1-07686	Direct replacement water cooled manifold. Replaces Chris Craft part # 16.20-07686.
CC-20-08288	Direct replacement port side riser.
CC-20-08289	Direct replacement starboard side riser.
CC-1-07686P	Manifold mounting package.
CC-6-80	Pressure relief valve adaptor package for use with Chris Craft direct replacement risers as needed.
CC-20-07593	Riser/deflector plate. Replaces Chris Craft part # 16.20-07593 (Order (2) of the appropriate gaskets according to your requirements).
CC-20-07605	Direct replacement exhaust elbow.
CC-20-0828P	Exhaust riser mounting package.
CC47-1650-05944	End cap gasket for all models except 283 C.I.D. with flywheel forward (Order (2) of the appropriate gaskets according to your requirements).
CC47-1650-06022	End cap gasket for 283 C.I.D. with flywheel forward (Order (2) of the appropriate gaskets according to your requirements).
CC47-1650-07290	Pressure relief valve housing gasket.
CC47-1650-07596	Riser/deflector plate gasket. Also requires gasket CC47-1650-07597 (Order (2) of the appropriate gaskets according to your requirements).
CC47-1650-07597	Riser/tail pipe gasket. Also requires gasket CC47-1650-07596 (Order (2) of the appropriate gaskets according to your requirements).
CC47-1650-07681	Adaptor/tail pipe gasket for 283 C.I.D. with flywheel forward (Order (2) of the appropriate gaskets according to your requirements).
CHV-47-0000	Manifold to cylinder head gasket.

Note:
Manifold includes all mounting hardware to head, gaskets and plugs. Risers include mounting gaskets and plugs only. Order CC 20 0828P to mount riser to manifold ((2) required per engine).

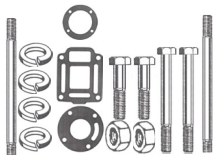

CC 20 0828P

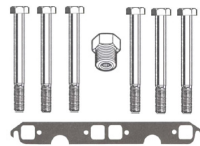

CC 1 07686P



CC 6 80



CHV 47 0000



CC47 1650 05944



CC47 1650 06022



CC47 1650 07290



CC47 1650 07596



CC47 1650 07597



CC47 1650 07681

BARR
MARINE BY EDM

8-1/2"

9-1/2"

7-5/8"

8

"C"

Part Number

"A"

2-9/16"

6-1/8"

6-1/8"

Chris Craft V8-283, 302, 305, 307, 327 and 350 C.I.D.

ALL MODELS GENERIC



20 0000

20 0031

20 0055



20 0039



20 0035



20 0034



1 0283R



1 0283L



1 0012R



1 0012L



CC47 1650
05944



CC47 1650
06022

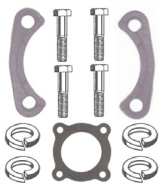

20 0002P



CC 6 80

1-0012L	Adaptor for Chris Craft V8 283 C.I.D. Manifolds prior to Models F, G, K and Q (three pass manifold system) left side. Requires Chris Craft adaptor part #16.20-07602 (port side).
1-0012R	Adaptor for Chris Craft V8 283 C.I.D. Manifolds prior to Models F, G, K and Q (three pass manifold system) right side. Requires Chris Craft adaptor part #16.20-07064 (starboard side).
1-0283A	Adaptor for Chris Craft V8 283, 302, 305, 307, 327 and 350 C.I.D. Manifolds, Models F, G, and K (two pass manifold system). Not pictured.
1-0283L	Adaptor for Chris Craft V8 283, 302, 305, 307, 327 and 350 C.I.D. Manifolds, Model Q (single pass manifold system) left side.
1-0283R	Adaptor for Chris Craft V8 283, 302, 305, 307, 327 and 350 C.I.D. Manifolds, Model Q (single pass manifold system) right side.
20-0000	Swivel-type high discharge exhaust riser; 8 1/2" riser protection. Requires (1) mounting hardware kit #20-0002P per riser. Use only with 2 7/8" to 3" I.D. exhaust hose.
20-0002P	Mounting hardware kit.
20-0031	Swivel-type 90 degree exhaust elbow connector with internal water discharge. Accepts 2 1/2" to 3" I.D. exhaust hose. Requires (1) mounting hardware kit #20-0002P per elbow.
20-0034 or 20-0035	Exhaust connector #20-0035 (for 2 1/2" I.D. exhaust hose) or exhaust connector #20-0034 (for 3" I.D. exhaust hose). Connects to #20-0039 using (1) #20-0002P per connector.
20-0039	Fully jacketed swivel-type exhaust riser; 7" riser protection. Requires (2) mounting hardware kits #20-0002P ((1) kit to mount riser to manifold and (1) kit to mount elbows #20-0034 or #20-0035 to riser). Use for Models F, G, K, and Q; requires (1) CC-6-80 package.
20-0055	Swivel-type 30 degree exhaust elbow connector; fully jacketed. Accepts 2 1/2" or 3" I.D. exhaust hose. Requires (1) mounting hardware kit #20-0002P per elbow.
CC-6-80	Pressure relief valve adaptor package for Chris Craft V8 Models F, G, K, and Q. Use with #20-0039 riser.
CC47-1650-05944	End cap gasket for all models except 283 C.I.D. with flywheel forward (Order (2) of the appropriate gaskets according to your requirements).
CC47-1650-06022	End gasket for 283 C.I.D. with flywheel forward (Order (2) of the appropriate gaskets according to your requirements).

BARR
MARINE BY EDM

Chris Craft V8-283, 302, 305, 307, 327 and 350 C.I.D.

ALL MODELS CENTER RISER GENERIC



CHV 1 83

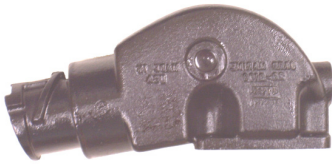

20 0100



20 0082

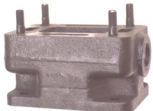

20 0097



20 0088P



20 0086P

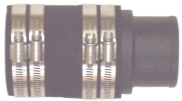

20 0085P



20 0089P



CC 27 79



CHV 1 83P



20 0082P

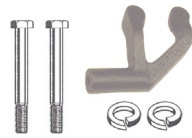

CHV 27 0083

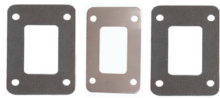

1 0104P

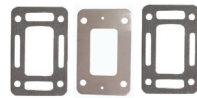

1 0106P



1 0105



1 0107



CHV 47 0000

CHV-1-83	Water cooled center discharge manifold to fit the small block GM engine (3/4" N.P.T. cooling hose connections). All years.
20-0082	Water cooled center discharge riser (3/4" N.P.T. cooling hose connection). Standard for use with 3" I.D. exhaust hose.
20-0100	Water cooled center discharge riser (3/4" N.P.T. cooling hose connection). Standard for use with 4" I.D. exhaust hose.
1-0104P	Adaptor package for fresh water cooled manifold (includes gaskets and block off plate).
1-0105	Center riser manifold-to-riser gasket for fresh water cooling.
1-0106P	Adaptor package for raw water cooling. Used in pre-heating applications (includes gaskets and block off plate with vent hole).
1-0107	Center riser manifold-to-riser gasket (raw water cooling).
20-0082P	Riser mounting package for both 20-0082 and 20-0100.
20-0082SS-P	Stainless steel mounting package (with brass plugs) for both 20-0082 and 20-0100. Not pictured.
20-0085P	Straight exhaust adaptor (includes adaptor, hose and clamps). For use with 2 1/2" I.D. exhaust hose.
20-0086P	90 degree exhaust elbow adaptor (includes adaptor, hose and clamps). For use with 2 1/2" I.D. exhaust hose.
20-0088P	30 degree exhaust elbow adaptor (includes adaptor, hose and clamps). For use with 2 1/2" I.D. exhaust hose.
20-0089P	30 degree exhaust elbow adaptor (includes adaptor, hose and clamps). For use with 3" I.D. exhaust hose.
20-0097	3" spacer block (complete with mounting hardware, gasket and 3/4" pipe plug). Capable of stacking.
CC-27-79	Alternator bracket. Use where engine water pump is mounted on the starboard side of the engine.
CHV-1-83P	Manifold mounting package (includes bolts and pipe plugs).
CHV-1-83SS-P	Stainless steel manifold mounting package (includes stainless bolts and brass plugs). Not pictured.
CHV-27-0083	Alternator bracket. Use where engine water pump is mounted on port side of engine below alternator.
CHV-47-0000	Manifold to cylinder head gasket.

Note:

Manifold includes all plugs, gaskets and mounting hardware to head. Risers include plugs, gasket and mounting hardware to mount to manifold.

Chris Craft V8-454 C.I.D.

ALL MODELS CENTER RISER GENERIC



CHVA 1 84

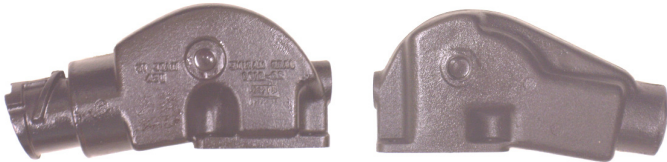

20 0100

20 0082



20 0097

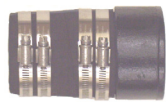

20 0084P

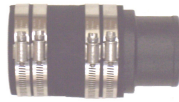

20 0085P



20 0086P



20 0087P



20 0088P



20 0089P



20 0092P



20 0093P

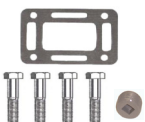

20 0082P



CHVA 1 84P



1 0105



1 0107

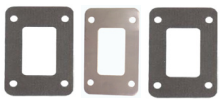

1 0104P

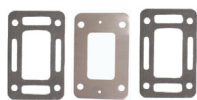

1 0106P



CHVA 47 0000

Note:
Manifold includes all plugs, gaskets and mounting hardware to head. Risers include plugs, gasket and mounting hardware to mount to manifold.

CHVA-1-84	Water cooled center discharge manifold to fit the big block GM engine (3/4" N.P.T. cooling hose connections). All years.
20-0082	Water cooled center discharge riser (3/4" N.P.T. cooling hose connection). Standard for use with 3" I.D. exhaust hose.
20-0100	Water cooled center discharge riser (3/4" N.P.T. cooling hose connection). Standard for use with 4" I.D. exhaust hose.
1-0104P	Adaptor package for fresh water cooled manifold (includes gaskets and block off plate).
1-0105	Center riser manifold-to-riser gasket for fresh water cooling.
1-0106P	Adaptor package for raw water cooling. Used in pre-heating applications (includes gaskets and block off plate with vent hole).
1-0107	Center riser manifold-to-riser gasket (raw water cooling).
20-0082P	Riser mounting package for both 20-0082 and 20-0100.
20-0082SS-P	Stainless steel mounting package (with brass plugs) for both 20-0082 and 20-0100. Not pictured.
20-0084P	Straight exhaust adaptor (includes adaptor, hose and clamps). For use with 3 1/2" I.D. exhaust hose.
20-0085P	Straight exhaust adaptor (includes adaptor, hose and clamps). For use with 2 1/2" I.D. exhaust hose.
20-0086P	90 degree exhaust elbow adaptor (includes adaptor, hose and clamps). For use with 2 1/2" I.D. exhaust hose.
20-0087P	90 degree exhaust elbow adaptor (includes adaptor, hose and clamps). For use with 3" I.D. exhaust hose.
20-0088P	30 degree exhaust elbow adaptor (includes adaptor, hose and clamps). For use with 2 1/2" I.D. exhaust hose.
20-0089P	30 degree exhaust elbow adaptor (includes adaptor, hose and clamps). For use with 3" I.D. exhaust hose.
20-0092P	45 degree exhaust elbow adaptor (includes adaptor, hose and clamps). For use with 3" I.D. exhaust hose.
20-0093P	90 degree exhaust elbow adaptor (includes adaptor, hose and clamps). For use with 3 1/2" or 4" I.D. exhaust hose.
20-0097	3" spacer block (complete with mounting hardware, gasket and 3/4" pipe plug). Capable of stacking.
CHVA-1-84P	Manifold mounting package (includes bolts and pipe plugs).
CHVA-1-84SS-P	Stainless steel manifold mounting package (includes stainless bolts and brass plugs). Not pictured.
CHVA-47-0000	Manifold to cylinder head gasket.

Chrysler V8-273, 318, 340, and 360 C.I.D.

ALL MODELS. 1986 AND UP CENTER RISER DIRECT REPLACEMENT



CM 1 4417063

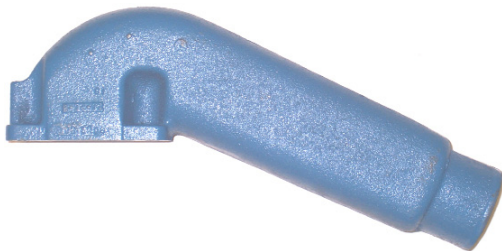

534005

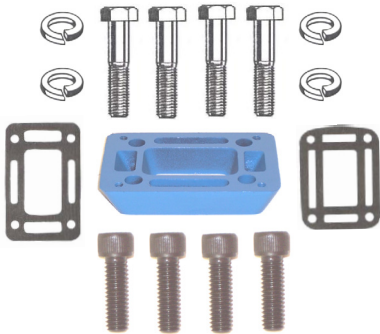

534002



CM47 4417232



534004



CM47 4417127



50 525 018



50 512 018



50 512 019



50 525 019

CM-1-4417063	Water cooled center discharge exhaust manifold to fit the small block Chrysler (1/2" N.P.T. cooling hose connections). Used during years 1986 and later.
534005	Generic riser designed to be mounted to the original Chrysler center riser exhaust manifold (for use with 3" I.D. exhaust hose/3/4" N.P.T. cooling hose connection).
534002	Adaptor kit (sold as shown) to fit the original Chrysler center riser exhaust manifold to the Barr style riser (part #534005). Adaptor must be used for Barr style riser.
534004	Riser gasket for raw water cooled manifolds (installed between manifold and adaptor plate).
50-512-018	1/2" N.P.T. X 3/4" hose (straight barb) brass fitting.
50-512-019	3/4" N.P.T. X 3/4" hose (straight barb) brass fitting.
50-525-018	1/2" N.P.T. X 3/4" hose (90 degree) brass fitting
50-525-019	3/4" N.P.T. X 3/4" hose (90 degree) brass fitting.
CM47-4417127	Riser gasket for raw water cooled manifolds (installed between adaptor plate and riser).
CM47-4417232	Riser gasket for fresh water cooled manifolds (installed between manifold and adaptor plate).

Note: Manifold includes all mounting hardware, gaskets and plugs.

BARR
MARINE BY EDM

8-1/2"

9-1/2"

7-5/8"

"A"

6-1/8"

6-1/8"

12

Part Number

2-9/16"

"C"

30°

Chrysler V8-273, 318, 340, and 360 C.I.D.

ALL MODELS. 1966 AND UP LOG STYLE DIRECT REPLACEMENT



CM 1 6677A

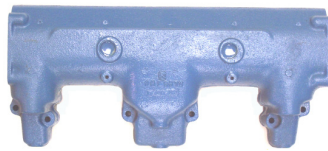

CM 1 6672A



CM 20 6672



CM 20 6674



CM 20 2847405



CM 20 4142411



CM 20 9232



CM 20 2600402



CM 1 6672C



CM 1 6672B



CM 1 6672H

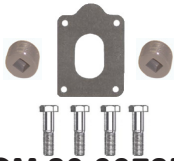

CM 20 6672P



CM 1 6677P



CM 1 6672E

Note:
 CM-1-6672A, CM-1-6677A, CM-20-6672,
 CM-20-6674 and CM-20-2847405 include all mount-
 ing hardware, gaskets and plugs. Swivel-style con-
 nector packages must be purchased separate for the
 corresponding riser/elbows. See next page for part
 part numbers.

CM-1-6672A	Direct replacement water cooled manifold for model years 1966 to 1972.
CM-1-6677A	Direct replacement water cooled manifold for model years 1973 to 1986.
CM-20-2600402	Exhaust riser lower elbow. Direct replacement for Chrysler part # 2600402.
CM-20-2847405	90 degree exhaust elbow. Direct replacement for Chrysler part #'s 2847405 and 2469639.
CM-20-4142411	Exhaust riser/upper elbow. Direct replacement for Chrysler part #'s 3745639, 2847623, 2487404 and E9233M.
CM-20-6672	Fully jacketed 20 degree exhaust elbow. Accepts 3" I.D. exhaust hose. Direct replacement for Chrysler part # 3527794. Will mount directly to manifold or can be used with riser # CM-20-6674.
CM-20-6674	Fully jacketed exhaust riser. 6" riser protection. Direct replacement for Chrysler part # 2846689.
CM-20-9232	6" exhaust elbow high riser extension. Direct replacement for Chrysler part # E9232M.
CM-1-6672B	Front end plate without the water connector, (1) required per manifold (Chrysler part # 2846106). May require mounting kit # CM-1-6672B-P (shown on next page). Order the appropriate end flanges and fittings according to your requirements.
CM-1-6672C	Adaptor for rear end of manifold. Use with Barr style exhaust risers or elbows, (1) required per manifold.
CM-1-6672E	Copper water distribution tube, (1) required per manifold. Replaces original tube (Chrysler part # 3527781) where used. Will fit both manifold styles.
CM-1-6672H	Front end plate with 1/2" N.P.T. water connection. For use where water connection is made from the front of the manifold. Will replace Chrysler part # 3527869, (1) required per manifold. May require mounting kit # CM-1-6672B-P (shown on next page). Will fit both manifold styles.
CM-1-6677P	Manifold to cylinder head mounting kit (Order (1) of the appropriate mounting kits according to your requirements).
CM-1-6677SS-P	Stainless steel manifold to cylinder head mounting kit (includes stainless studs, nuts, manifold to head gaskets and brass drain plugs). Not pictured.
CM-20-6672P	Mounting kit for exhaust elbow connector for raw water cooled manifold (includes bolts, gasket and pipe plug).

BARR
 MARINE BY EDM

Chrysler V8-273, 318, 340, and 360 C.I.D.

ALL MODELS. 1966 AND UP LOG STYLE DIRECT REPLACEMENT

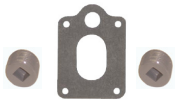

CM 20 2847405P

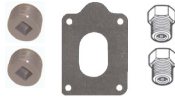

CM 20 6674J P

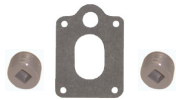

CM 20 2600402P

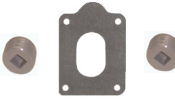

CM 20 6672J P

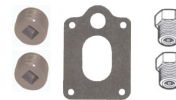

CM 20 6674P



CM 20 6674B P



CM 1 6672J



CM 1 6672D



CM 20 9224



CM 20 1947617



CM 50 115729



CM 20 9225



CM 50 6025923

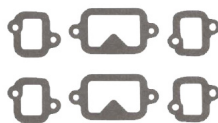

CM 1 6672P



CM 20 9226

CM-1-6672D	End flange gasket for raw water cooled manifolds, (2) required per manifold. Replaces Chrysler part # 2847480. Will fit both manifold styles.
CM-1-6672J	End flange gasket for fresh water cooled manifolds, (1) required per exhaust end. Will fit both manifold styles.
CM-1-6672P	Manifold to cylinder head gasket set, (1) required per engine. Replaces Chrysler part # 3745220. Will fit both manifold styles.
CM-20-1947617	Exhaust elbow extension retainer.
CM-20-2600402P	Mounting kit for lower elbow riser (includes bolts, gasket and pipe plugs).
CM-20-2847405P	Mounting kit for exhaust elbow (includes bolts, gasket and pipe plugs).
CM-20-4142411P	Mounting kit for upper riser/elbow (includes sleeve, O-rings, retainers, bolts and pipe plugs).
CM-20-6672J-P	Mounting kit for exhaust elbow connector for fresh water cooled manifold (includes bolts, gasket, and pipe plugs).
CM-20-6674J-P	Mounting kit for exhaust riser for fresh water cooled manifold (includes bolts, gasket and pipe plug).
CM-20-6674P	Mounting kit for raw water cooled manifold (includes bolts, gasket and pipe plugs).
CM-20-9232P	Mounting kit for 6" extension (includes sleeve, O-rings, retainers and bolts).
CM-20-9224	Exhaust to elbow extension retainer sleeve.
CM-20-9225	Exhaust to elbow extension inner seal.
CM-20-9226	Exhaust to elbow extension outer seal.
CM-50-115729	Stainless steel exhaust manifold stud nut.
CM-50-602593	Stainless steel exhaust manifold stud.

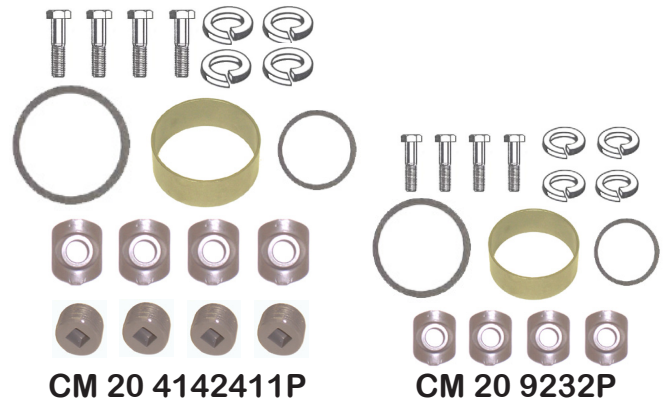

CM 20 4142411P

CM 20 9232P

BARR
MARINE BY EDM

Chrysler V8-361, 383, 400, 413, 426 and 440 C.I.D.

ALL MODELS. 1959 AND UP LOG STYLE DIRECT REPLACEMENT

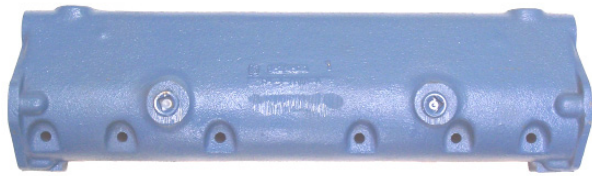

CM 1 5972A



CM 20 4142411



CM 20 9232



CM 20 9234



CM 1 5972B



1 0067



1 0007

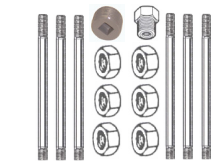

CM 1 5972SS P

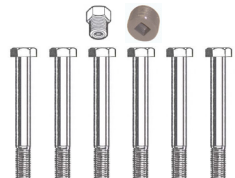

CM 1 5972G P

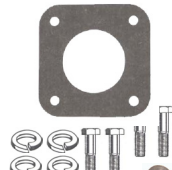

CM 20 9234P

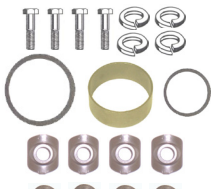

CM 20 4142411P

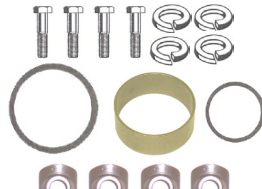

CM 20 9232P



CM 1 5972D



CM 50 6023040



CM 1 5972P



CM 20 9224



CM 1 5972C



CM 20 9226



CM 50 114942



CM 20 9225



CM 20 1947617

CM-1-5972A	Direct replacement water cooled manifold for big block Chrysler.
CM-20-4142411	Exhaust riser/upper elbow. Direct replacement for Chrysler part #'s 3745639, 2847623, 2847404 and E9233M.
CM-20-9232	6" exhaust elbow high riser extension. Direct replacement for Chrysler part # E9232M.
CM-20-9234	Exhaust riser lower elbow. Direct replacement for Chrysler part # E9234M.
I-0007	Adaptor for rear end of manifold. Use with Barr style exhaust risers or elbow connectors.
I-0067	2 1/2" N.P.T. threaded exhaust end plate.
CM-1-5972B	Direct replacement front end plate.
CM-1-5972C	End plate gasket, (2) required per manifold.
CM-1-5972D	Copper water distribution tube. Replaces original tube where used.
CM-1-5972G-P	Manifold to cylinder head mounting kit (includes bolts, manifold to head gaskets and brass drain plug).
CM-1-5972P	Manifold to cylinder head mounting gasket set.
CM-1-5972SS-P	Manifold to cylinder head mounting kit (includes stainless steel studs and nuts, manifold to head gaskets and brass drain plugs).
CM-20-1947617	Exhaust elbow extension retainer.
CM-20-4142411P	Mounting kit for upper riser/elbow (includes sleeve, O-rings, retainers, bolts and pipe plugs).
CM-20-9224	Exhaust elbow to extension seal retainer sleeve.
CM-20-9225	Exhaust elbow to extension inner seal.
CM-20-9226	Exhaust elbow to extension outer seal.
CM-20-9232P	Mounting kit for 6" extension (includes sleeve, O-rings, clamps and bolts).
CM-20-9234P	Mounting kit for lower elbow riser (includes bolts, gasket and pipe plugs).
CM-50-114942	Stainless steel exhaust manifold stud nut.
CM-50-5023040	Stainless steel exhaust manifold stud.

Note:
 Manifold includes gaskets and plugs. Swivel-style connector packages must be purchased separate for the corresponding riser/elbows. Manifold mounting hardware must be purchased separately.

BARR
 MARINE BY EDM

Crusader V8-283, 302, 305, 307, 327 and 350 C.I.D.

ALL MODELS CENTER RISER GENERIC



CHV 1 83

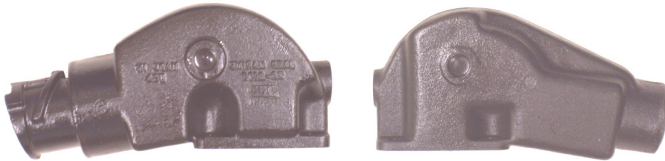

20 0100

20 0082



20 0097



20 0088P



20 0086P



20 0085P



20 0089P



CHV 27 0083



CHV 1 83P

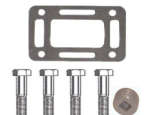

20 0082P

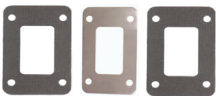

1 0104P

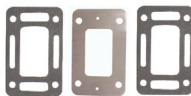

1 0106P



1 0105



1 0107



CHV 47 0000

CHV-1-83	Water cooled center discharge manifold to fit the small block GM engine (3/4" N.P.T. cooling hose connections). All years.
20-0082	Water cooled center discharge riser (3/4" N.P.T. cooling hose connection). Standard for use with 3" I.D. exhaust hose.
20-0100	Water cooled center discharge riser (3/4" N.P.T. cooling hose connection). Standard for use with 4" I.D. exhaust hose.
1-0104P	Adaptor package for fresh water cooled manifold (includes gaskets and block off plate).
1-0105	Center riser manifold-to-riser gasket for fresh water cooling.
1-0106P	Adaptor package for raw water cooling. Used in pre-heating applications (includes gaskets and block off plate with vent hole).
1-0107	Center riser manifold-to-riser gasket (raw water cooling).
20-0082P	Riser mounting package for both 20-0082 and 20-0100.
20-0082SS-P	Stainless steel mounting package (with brass plugs) for both 20-0082 and 20-0100. Not pictured.
20-0085P	Straight exhaust adaptor (includes adaptor, hose and clamps). For use with 2 1/2" I.D. exhaust hose.
20-0086P	90 degree exhaust elbow adaptor (includes adaptor, hose and clamps). For use with 2 1/2" I.D. exhaust hose.
20-0088P	30 degree exhaust elbow adaptor (includes adaptor, hose and clamps). For use with 2 1/2" I.D. exhaust hose.
20-0089P	30 degree exhaust elbow adaptor (includes adaptor, hose and clamps). For use with 3" I.D. exhaust hose.
20-0097	3" spacer block (complete with mounting hardware, gasket and 3/4" pipe plug). Capable of stacking.
CHV-1-83P	Manifold mounting package (includes bolts and pipe plugs).
CHV-1-83SS-P	Stainless steel manifold mounting package (includes stainless bolts and brass plugs). Not pictured.
CHV-27-0083	Alternator bracket. Use where engine water pump is mounted on port side of engine below alternator.
CHV-47-0000	Manifold to cylinder head gasket.

Note:
 Manifold includes all plugs, gaskets and mounting hardware to head. Risers include plugs, gasket and mounting hardware to mount to manifold.

Crusader V8-283, 302, 305, 307, 327 and 350 C.I.D.

ALL MODELS DIRECT REPLACEMENT

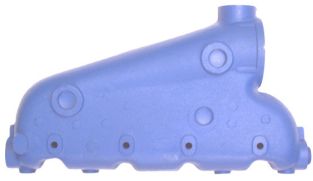

CR 1 97753

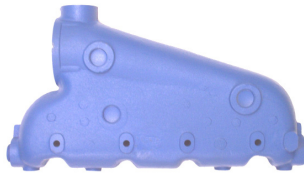

CR 1 97752



CR 20 96560

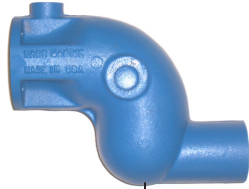

CR 20 98068

15/16" Longer



CR 20 97924



CR 20 97386



CR 20 97772



CR 20 97169



CR 20 97387



CR 20 97624

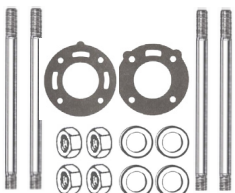

CR 20 97169P

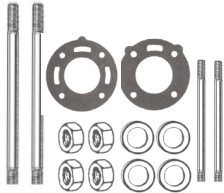

CR 20 97772P



CR 20 97296



CR47 C 96108

CR 50 96369

CR 50 20471

CR 50 22033

CR 50 22032

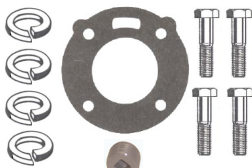

CR 20 96560P

BARR
MARINE BY EDM



CR47 C 96562



CHV 47 0000

CR-1-97752	Direct replacement starboard side manifold. Replaces Crusader part # 97752.
CR-1-97753	Direct replacement port side manifold. Replaces Crusader part # 97753.
CR-20-96560	Direct replacement exhaust elbow assembly, 3" I.D. exhaust hose. Replaces Crusader part # 96560.
CR-20-97169	6" riser extension. Replaces Crusader part # 97169.
CR-20-97386	90 degree swivel elbow. Replaces Crusader part # 97386.
CR-20-97387	Elbow, lower swivel with 3" outlet. Replaces Crusader part # 97387.
CR-20-97624	Elbow, lower swivel with 4" outlet. Replaces Crusader part # 97624.
CR-20-97772	4" riser extension. Replaces Crusader part # 97772.
CR-20-97924	Direct replacement exhaust elbow assembly, 4" I.D. exhaust hose. Replaces Crusader part # 97924.
CR-20-98068	Direct replacement exhaust elbow assembly, 3" I.D. exhaust hose. For use without Crusader spacer part # 97295. Replaces Crusader part # 98068.
CHV-47-0000	Manifold to cylinder head gasket.
CR-1-97752P	Manifold mounting package. Not pictured.
CR 1 97753P	Manifold mounting package (alternator side of engine). Not pictured.
CR-20-96560P	Mounting package for CR-20-96560, CR-20-97386, CR-20-97924, and CR-20-98068.
CR-20-97169P	Mounting package for CR-20-97169.
CR-20-97296	Stainless steel block off plate for fresh water applications.
CR-20-97772P	Mounting package for CR-20-97772.
CR-20-96319	143 degree thermostat for Crusader. Not pictured.
CR47-C-96108	Replacement exhaust elbow gasket (3 hole).
CR47-C-96562	Replacement exhaust elbow gasket (1 hole).
CR-50-20471	Replaces Crusader part # 20471 (3/8" X 5 3/4" stainless steel stud).
CR-50-22032	Replaces Crusader part # 22032 (3/8" X 9 3/8" stainless steel stud). For use with OEM adaptor # 97295.
CR-50-22033	Replaces Crusader part # 22033 (3/8" X 7 3/4" stainless steel stud).
CR-50-96369	Replaces Crusader part # 96369 (3/8" X 4" stainless steel stud). For use with OEM adaptor # 97295.

Note:

Manifolds and elbows include all mounting hardware, gaskets and plugs. CR-20-96169P and CR-20-97772P must be purchased separate for the corresponding risers.

Crusader V8-283, 305, 307, 327 and 350 C.I.D.

CENTER RISER DIRECT REPLACEMENT



CR 1 98243

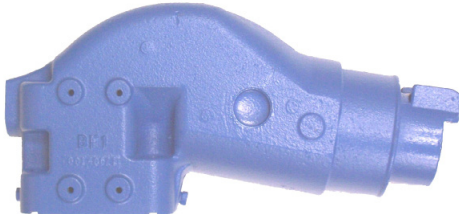

CR 20 98126

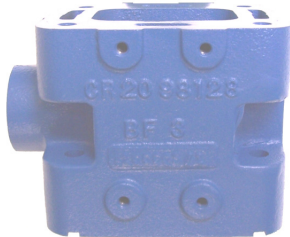

CR 20 98128

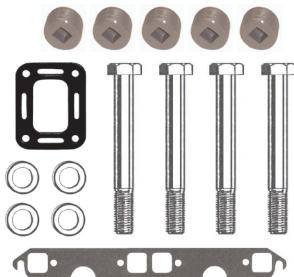

CR 1 98243P



CR47 C 98127



CR 20 98124



CHV 47 0000



CR 20 98126P



CR 20 98128P

CR-1-98243	Direct replacement water cooled exhaust manifold. Replaces Crusader part # 98243.
CR-20-98216	Direct replacement water cooled center discharge riser. Replaces Crusader part # 98126. Accepts 4" I.D. exhaust hose.
CR-20-98128	Manifold to riser 3" spacer block (single). Replaces Crusader part # 98128.
CHV-47-0000	Manifold to cylinder head gasket.
CR-1-98243P	Mounting package for CR-1-98243.
CR-20-98124	Stainless steel block off plate for closed cooling applications.
CR-20-98126P	Mounting package for CR-20-98126 riser.
CR-20-98128P	Mounting package for CR-20-98128 spacer.
CR47-C-98127	Direct replacement manifold to riser gasket.

Note:
 Manifold, riser and spacer block include all mounting hardware, gaskets and plugs.

BARR
 MARINE BY EDM

8-1/2"

9-1/2"

7-5/8"

18

Part Number

30°

"A"

2-9/16"

6-1/8"

6-1/8"

Internal Water Discharge

Discharge
 "C"
 Part Number
 20-0000

"A"

2"

Crusader V8-427 and 454 C.I.D.

ALL MODELS CENTER RISER GENERIC



CHVA 1 84

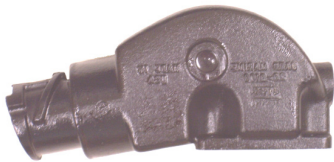

20 0100



20 0082

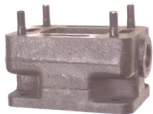

20 0097



20 0084P

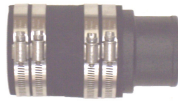

20 0085P



20 0086P



20 0087P



20 0088P



20 0089P



20 0092P



20 0093P



20 0082P



CHVA 1 84P



CHVA 47 0000

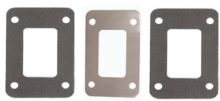

1 0104P

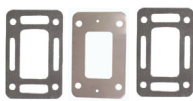

1 0106P



1 0105



1 0107

Note:

Manifold includes all plugs, gaskets and mounting hardware to head. Risers include plugs, gasket and mounting hardware to mount to manifold.

CHVA-1-84	Water cooled center discharge manifold to fit the big block GM engine (3/4" N.P.T. cooling hose connections). All years.
20-0082	Water cooled center discharge riser (3/4" N.P.T. cooling hose connection). Standard for use with 3" I.D. exhaust hose.
20-0100	Water cooled center discharge riser (3/4" N.P.T. cooling hose connection). Standard for use with 4" I.D. exhaust hose.
1-0104P	Adaptor package for fresh water cooled manifold (includes gaskets and block off plate).
1-0105	Center riser manifold-to-riser gasket for fresh water cooling.
1-0106P	Adaptor package for raw water cooling. Used in pre-heating applications (includes gaskets and block off plate with vent hole).
1-0107	Center riser manifold-to-riser gasket (raw water cooling).
20-0082P	Riser mounting package for both 20-0082 and 20-0100.
20-0082SS-P	Stainless steel mounting package (with brass plugs) for both 20-0082 and 20-0100. Not pictured.
20-0084P	Straight exhaust adaptor (includes adaptor, hose and clamps). For use with 3 1/2" I.D. exhaust hose.
20-0085P	Straight exhaust adaptor (includes adaptor, hose and clamps). For use with 2 1/2" I.D. exhaust hose.
20-0086P	90 degree exhaust elbow adaptor (includes adaptor, hose and clamps). For use with 2 1/2" I.D. exhaust hose.
20-0087P	90 degree exhaust elbow adaptor (includes adaptor, hose and clamps). For use with 3" I.D. exhaust hose.
20-0088P	30 degree exhaust elbow adaptor (includes adaptor, hose and clamps). For use with 2 1/2" I.D. exhaust hose.
20-0089P	30 degree exhaust elbow adaptor (includes adaptor, hose and clamps). For use with 3" I.D. exhaust hose.
20-0092P	45 degree exhaust elbow adaptor (includes adaptor, hose and clamps). For use with 3" I.D. exhaust hose.
20-0093P	90 degree exhaust elbow adaptor (includes adaptor, hose and clamps). For use with 3 1/2" or 4" I.D. exhaust hose.
20-0097	3" spacer block (complete with mounting hardware, gasket and 3/4" pipe plug). Capable of stacking.
CHVA-1-84P	Manifold mounting package (includes bolts and pipe plugs).
CHVA-1-84SS-P	Stainless steel manifold mounting package (includes stainless bolts and brass plugs). Not pictured.
CHVA-47-0000	Manifold to cylinder head gasket.

BARR
MARINE BY EDM

Crusader V8-454 and 502 C.I.D.

ALL MODELS DIRECT REPLACEMENT

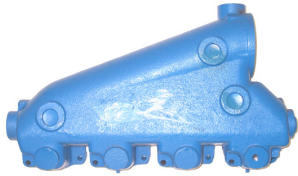

CR 1 97993

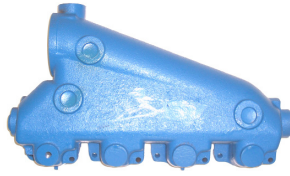

CR 1 97992

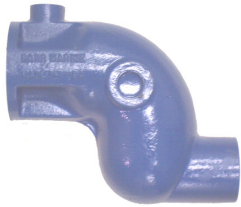

CR 20 96560



CR 20 98068

15/16" Longer



CR 20 97924



CR 20 97386



CR 20 97772



CR 20 97169



CR 20 97387



CR 20 97624

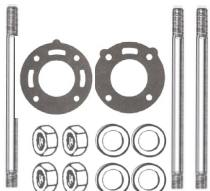

CR 20 97169P

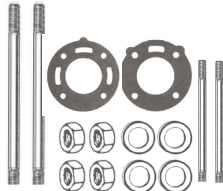

CR 20 97772P



CR47 C 96108



CR 20 97296

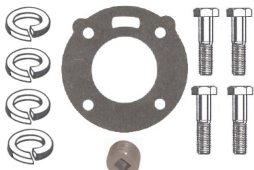

CR 20 96560P

CR 50 96369

CR 50 20471

CR 50 22033

CR 50 22032

CR-1-97992	Direct replacement starboard side manifold. Replaces Crusader part # 97992.
CR-1-97993	Direct replacement port side manifold. Replaces Crusader part # 97993.
CR-20-96560	Direct replacement exhaust elbow assembly, 3" I.D. exhaust hose. Replaces Crusader part # 96560.
CR-20-97169	8" riser extension. Replaces Crusader part # 97169.
CR-20-97386	90 degree swivel elbow. Replaces Crusader part # 97386.
CR-20-97387	Elbow, lower swivel with 3" outlet. Replaces Crusader part # 97387.
CR-20-97624	Elbow, lower swivel with 4" outlet. Replaces Crusader part # 97624.
CR-20-97772	4" riser extension. Replaces Crusader part # 97772.
CR-20-97924	Direct replacement exhaust elbow assembly, 4" I.D. exhaust hose. Replaces Crusader part # 97924.
CR-20-98068	Direct replacement exhaust elbow assembly, 3" I.D. exhaust hose. For use without Crusader spacer part # 97295. Replaces Crusader part # 98068.
CHVA-47-0000	Manifold to cylinder head gasket.
CR-1-9799P	Manifold mounting package. Not pictured.
CR-20-96560P	Mounting package for CR-20-96560, CR-20-97386, CR-20-97924, and CR-20-98068.
CR-20-97169P	Mounting package for CR-20-97169.
CR-20-97296	Stainless steel block off plate for fresh water applications.
CR-20-97772P	Mounting package for CR-20-97772.
CR-20-96319	143 degree thermostat for Crusader (not pictured).
CR47-C-96108	Replacement exhaust elbow gasket (3 hole).
CR47-C-96562	Replacement exhaust elbow gasket (1 hole).
CR-50-20471	Replaces Crusader part # 20471 (3/8" X 5 3/4" stainless steel stud).
CR-50-22032	Replaces Crusader part # 22032 (3/8" X 9 3/8" stainless steel stud). For use with OEM adaptor # 97295.
CR-50-22033	Replaces Crusader part # 22033 (3/8" X 7 3/4" stainless steel stud).
CR-50-96369	Replaces Crusader part # 96369 (3/8" X 4" stainless steel stud). For use with OEM adaptor # 97295.

Note: Manifolds and elbows include all mounting hardware, gaskets and plugs. CR-20-96169P and CR-20-97772P must be purchased separate for the corresponding risers.

BARR
MARINE BY EDM



CR47 C 96562



CHVA 47 0000

8-1/2"

9-1/2"

7-5/8"

20

Part Number

"A"

2-9/16"

6-1/8"

6-1/8"

Internal Water Discharge

Part Number 20-0000

Discharge

"C"

"A"

2"

Crusader V8-302 and 351 C.I.D.

ALL MODELS CENTER RISER GENERIC

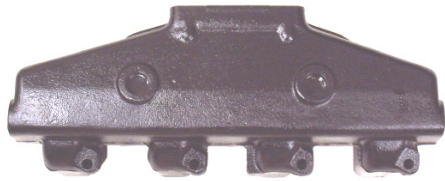

FM 1 83

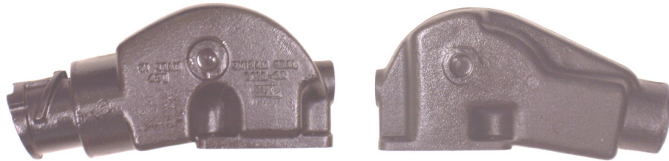

20 0100

20 0082



20 0097

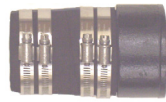

20 0084P

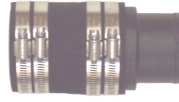

20 0085P



20 0086P



20 0087P



20 0088P



20 0089P



20 0092P



20 0093P



20 0082P



FM 1 83P



FM 47 0000

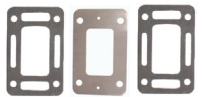

1 0106P



1 0105



1 0107



1 0104P

Note:
Manifold includes all plugs, gaskets and mounting hardware to head. Risers include plugs, gasket and mounting hardware to mount to manifold.

FM-1-83	Water cooled center discharge manifold to fit the small block Ford engine (3/4" N.P.T. cooling hose connections). All years.
20-0082	Water cooled center discharge riser (3/4" N.P.T. cooling hose connection). Standard for use with 3" I.D. exhaust hose.
20-0100	Water cooled center discharge riser (3/4" N.P.T. cooling hose connection). Standard for use with 4" I.D. exhaust hose.
1-0104P	Adaptor package for fresh water cooled manifold (includes gaskets and block off plate).
1-0105	Center riser manifold-to-riser gasket for fresh water cooling.
1-0106P	Adaptor package for raw water cooling. Used in pre-heating applications (includes gaskets and block off plate with vent hole).
1-0107	Center riser manifold-to-riser gasket (raw water cooling).
20-0082P	Riser mounting package for both 20-0082 and 20-0100.
20-0082SS-P	Stainless steel mounting package (with brass plugs) for both 20-0082 and 20-0100. Not pictured.
20-0084P	Straight exhaust adaptor (includes adaptor, hose and clamps). For use with 3 1/2" I.D. exhaust hose.
20-0085P	Straight exhaust adaptor (includes adaptor, hose and clamps). For use with 2 1/2" I.D. exhaust hose.
20-0086P	90 degree exhaust elbow adaptor (includes adaptor, hose and clamps). For use with 2 1/2" I.D. exhaust hose.
20-0087P	90 degree exhaust elbow adaptor (includes adaptor, hose and clamps). For use with 3" I.D. exhaust hose.
20-0088P	30 degree exhaust elbow adaptor (includes adaptor, hose and clamps). For use with 2 1/2" I.D. exhaust hose.
20-0089P	30 degree exhaust elbow adaptor (includes adaptor, hose and clamps). For use with 3" I.D. exhaust hose.
20-0092P	45 degree exhaust elbow adaptor (includes adaptor, hose and clamps). For use with 3" I.D. exhaust hose.
20-0093P	90 degree exhaust elbow adaptor (includes adaptor, hose and clamps). For use with 3 1/2" or 4" I.D. exhaust hose.
20-0097	3" spacer block (complete with mounting hardware, gasket and 3/4" pipe plug). Capable of stacking.
FM-1-83P	Manifold mounting package (includes bolts and pipe plugs).
FM-1-83SS-P	Stainless steel manifold mounting package (includes stainless bolts and brass plugs). Not pictured.
FM-47-0000	Manifold to cylinder head gasket.

BARR
MARINE BY EDM

Detroit Diesel 3-71, 6V-71, 4-71, 8V-71, 6-71 and 12V-71

Discharge
Part Number
20-0000

ALL MODELS DIRECT REPLACEMENT

Internal
Water
Discharge



DD 1 6710



DD 1 4710



DD 1 3710



DD 7 5119921



DD 7 5119924



DD 7 5119925



DD 7 5119926



1 0064



DD 47 5150195



DD 47 5150196

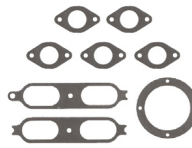

DD47 4710

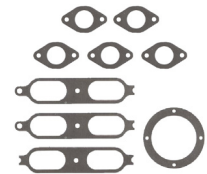

DD47 6710



DD 47 5163811



DD 47 5156319

DD-1-3710	Direct replacement water cooled exhaust manifold to fit the 3 and 6V cylinder 71 Series Detroit Diesel.
DD-1-4710	Direct replacement water cooled exhaust manifold to fit the 4 and 8V cylinder 71 and early style 92 Series Detroit Diesel.
DD-1-6710	Direct replacement water cooled exhaust manifold to fit the 6 and 12V cylinder 71 and early style 92 Series Detroit Diesel.
I-0064	4" N.P.T. exhaust end plate. Replaces Detroit Diesel part # 5164146.
DD-7-5119921	Blank water cover plate and gasket.
DD-7-5119924	3/8" water cover plate and gasket.
DD-7-5119925	1/2" water cover plate and gasket.
DD-7-5119926	3/4" water cover plate and gasket.
DD47-4710	Exhaust manifold gasket set for 4 cylinder manifold (order (1) of the appropriate gasket set per manifold).
DD47-5150195	Exhaust manifold to head gasket for 4 and 6 cylinder manifolds (order (2) of the appropriate gaskets per manifold).
DD47-5150196	Exhaust manifold to head gasket for 6 cylinder manifold (order (1) of the appropriate gasket per manifold).
DD47-5156319	Exhaust manifold cover plate gasket for 4 and 6 cylinder manifolds (order (5) gaskets per manifold).
DD47-5163811	4" exhaust outlet gasket (order (1) gasket per manifold).
DD47-6710	Exhaust manifold gasket set for 6 cylinder manifold (order (1) gasket set per manifold).

Note:
Detroit 71 series exhaust will fit some of the earlier 92 series engines. Please call for assistance.

Barr Marine extends a 1 year warranty on these exhaust manifolds.

BARR

MARINE BY EDM

8-1/2"

9-1/2"

7-5/8"

22

Part Number

30°

"A"

2-9/16"

6-1/8"

6-1/8"

Flagship V8-283, 327 and 350 C.I.D.

ALL MODELS CENTER RISER GENERIC



CHV 1 83

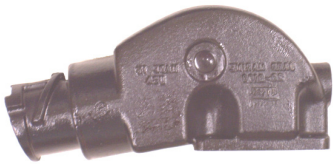

20 0100



20 0082



20 0097



20 0088P



20 0086P

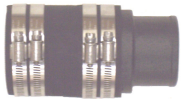

20 0085P



20 0089P

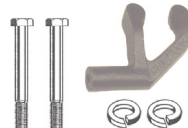

CHV 27 0083



CHV 1 83P



20 0082P

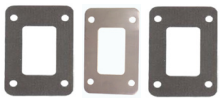

1 0104P

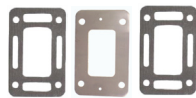

1 0106P



1 0105



1 0107



CHV 47 0000

CHV-1-83	Water cooled center discharge manifold to fit the small block GM engine (3/4" N.P.T. cooling hose connections). All years.
20-0082	Water cooled center discharge riser (3/4" N.P.T. cooling hose connection). Standard for use with 3" I.D. exhaust hose.
20-0100	Water cooled center discharge riser (3/4" N.P.T. cooling hose connection). Standard for use with 4" I.D. exhaust hose.
1-0104P	Adaptor package for fresh water cooled manifold (includes gaskets and block off plate).
1-0105	Center riser manifold-to-riser gasket for fresh water cooling.
1-0106P	Adaptor package for raw water cooling. Used in pre-heating applications (includes gaskets and block off plate with vent hole).
1-0107	Center riser manifold-to-riser gasket (raw water cooling).
20-0082P	Riser mounting package for both 20-0082 and 20-0100.
20-0082SS-P	Stainless steel mounting package (with brass plugs) for both 20-0082 and 20-0100. Not pictured.
20-0085P	Straight exhaust adaptor (includes adaptor, hose and clamps). For use with 2 1/2" I.D. exhaust hose.
20-0086P	90 degree exhaust elbow adaptor (includes adaptor, hose and clamps). For use with 2 1/2" I.D. exhaust hose.
20-0088P	30 degree exhaust elbow adaptor (includes adaptor, hose and clamps). For use with 2 1/2" I.D. exhaust hose.
20-0089P	30 degree exhaust elbow adaptor (includes adaptor, hose and clamps). For use with 3" I.D. exhaust hose.
20-0097	3" spacer block (complete with mounting hardware, gasket and 3/4" pipe plug). Capable of stacking.
CHV-1-83P	Manifold mounting package (includes bolts and pipe plugs).
CHV-1-83SS-P	Stainless steel manifold mounting package (includes stainless bolts and brass plugs). Not pictured.
CHV-27-0083	Alternator bracket. Use where engine water pump is mounted on port side of engine below alternator.
CHV-47-0000	Manifold to cylinder head gasket.

Note:

Manifold includes all plugs, gaskets and mounting hardware to head. Risers include plugs, gasket and mounting hardware to mount to manifold.

Flagship V8-283, 327 and 350 C.I.D.

LOG STYLE GENERIC

Starboard side part # OF 1 60R



OF 1 60L



20 0000



20 0031



20 0055



20 0039



20 0035



20 0034

OF-1-60L	Water cooled end discharge port manifold to fit the small block Chevrolet (1/2" N.P.T. cooling hose connections). All years
OF-1-60R	Water cooled end discharge starboard manifold to fit the small block Chevrolet (1/2" N.P.T. cooling hose connections). All years
1-0019	End plate gasket (will fit both ends).
20-0000	Swivel-type high discharge exhaust riser; 8 1/2" riser protection. Requires (1) mounting hardware kit #20-0002P per riser. Use only with 2 7/8" to 3" I.D. exhaust hose.
20-0002P	Mounting hardware kit.
20-0031	Swivel-type 90 degree exhaust elbow connector with internal water discharge. Accepts 2 1/2" to 3" I.D. exhaust hose. Requires (1) mounting hardware kit #20-0002P per elbow.
20-0034 or 20-0035	Exhaust connector #20-0035 (for 2 1/2" I.D. exhaust hose) or exhaust connector #20-0034 (for 3" I.D. exhaust hose). Connects to #20-0039 using (1) #20-0002P per connector.
20-0039	Fully jacketed swivel-type exhaust riser; 7" riser protection. Requires (2) mounting hardware kits #20-0002P ((1) kit to mount riser to manifold and (1) kit to mount elbows 20-0034 or 20-0035 to riser).
20-0055	Swivel-type 30 degree exhaust elbow connector; fully jacketed. Accepts 2 1/2" or 3" I.D. exhaust hose. Requires (1) mounting hardware kit #20-0002P per elbow.
CHV-47-0000	Manifold to cylinder head gasket.
OF-1-60F-P	Manifold to cylinder head mounting package.



1 0019



CHV 47 0000



20 0002P

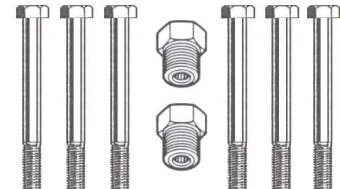

OF 1 60F P

BARR
MARINE BY EDM

Gray Marine 4 and 6 Cylinder In-Line Models



GR 1 162



GR 1 175



GR 1 226



GR 1 0001

GR-1-162	Water cooled exhaust manifold to fit the 4-cylinder models 620, 4-60 and 70. Use with OEM risers, elbow connectors or replace with Barr products.
GR-1-175	Water cooled exhaust manifold to fit the 4-cylinder models 4-75, 4-85 and 80. Use with OEM risers, elbow connectors or replace with Barr products.
GR-1-226	Water cooled exhaust manifold to fit the 6-cylinder 226 C.I.D. models. Use with OEM riser, elbow connectors or replace with Barr products.
GR-1-0001	Exhaust end plate flange (threaded for 2" female N.P.T.).

BARR
MARINE BY EDM

Gray Marine V8-401 C.I.D. 280 H.P.

ALL MODELS DIRECT REPLACEMENT

Port side part # GR-1-6470L



GR 1 6470R



20 0000

20 0031

20 0055

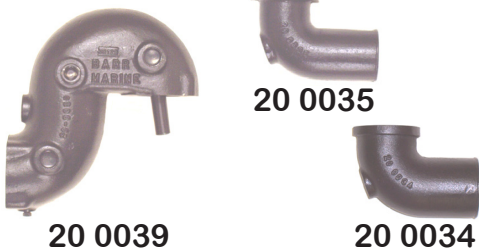

20 0039

20 0034



20 0035

GR-1-6470L	Water cooled exhaust manifold (port side) to fit the 401 Buick. Includes all fittings, hose adaptors and primary water pump mounting provision. Accepts Barr replacement risers and connectors only.
GR-1-6470R	Water cooled exhaust manifold (starboard side) to fit the 401 Buick. Includes all fittings, hose adaptors and primary water pump mounting provision. Accepts Barr replacement risers and connectors only.
1-0019	End plate gasket (will fit both ends).
GR-1-6470P	Manifold to cylinder head mounting kit.
20-0000	Swivel-type high discharge exhaust riser; 8 1/2" riser protection. Requires (1) mounting hardware kit #20-0002P per riser. Use only with 2 7/8" to 3" I.D. exhaust hose.
20-0002P	Mounting hardware kit (Barr style riser/elbows only).
20-0031	Swivel-type 90 degree exhaust elbow connector with internal water discharge. Accepts 2 1/2" to 3" I.D. exhaust hose. Requires (1) mounting hardware kit #20-0002P per elbow.
20-0034 or 20-0035	Exhaust connector #20-0035 (for 2 1/2" I.D. exhaust hose) or exhaust connector #20-0034 (for 3" I.D. exhaust hose). Connects to #20-0039 using (1) #20-0002P per connector.
20-0039	Fully jacketed swivel-type exhaust riser; 7" riser protection. Requires (2) mounting hardware kits #20-0002P ((1) kit to mount riser to manifold and (1) kit to mount elbows 20-0034 or 20-0035 to riser).
20-0055	Swivel-type 30 degree exhaust elbow connector; fully jacketed. Accepts 2 1/2" or 3" I.D. exhaust hose. Requires (1) mounting hardware kit #20-0002P per elbow.

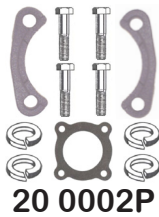

20 0002P



GR 1 6470P



1 0019

BARR
MARINE BY EDM

Indmar V8-283, 305², 307, 327³ and 350 C.I.D.

ALL MODELS INBOARD. CENTER RISER GENERIC



CHV 1 83

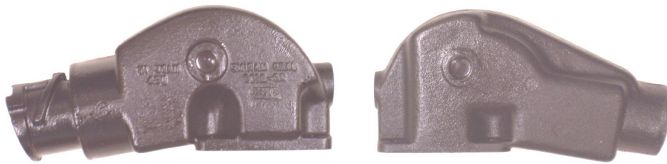

20 0100

20 0082



20 0102



20 0097



20 0088P



20 0086P



20 0085P



20 0089P



CHV 27 0083



CHV 1 83P



20 0082P

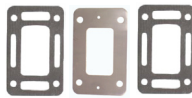

1 0106P

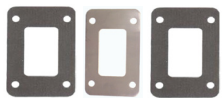

1 0104P



1 0105



1 0107



CHV 47 0000

CHV-1-83	Water cooled center discharge manifold to fit the small block GM engine (3/4" N.P.T. cooling hose connections). All years.
20-0082	Water cooled center discharge riser (3/4" N.P.T. cooling hose connection). Standard for use with 3" I.D. exhaust hose.
20-0100	Water cooled center discharge riser (3/4" N.P.T. cooling hose connection). Standard for use with 4" I.D. exhaust hose.
20-0102	Water cooled center discharge riser (3/4" N.P.T. cooling hose connection). Replaces Indmar # 532009.
1-0104P	Adaptor package for fresh water cooled manifold (includes gaskets and block off plate).
1-0105	Center riser manifold-to-riser gasket for fresh water cooling.
1-0106P	Adaptor package for raw water cooling. Used in pre-heating applications (includes gaskets and block off plate with vent hole).
1-0107	Center riser manifold-to-riser gasket (raw water cooling).
20-0082P	Riser mounting package for both 20-0082 and 20-0100.
20-0082SS-P	Stainless steel mounting package (with brass plugs) for both 20-0082 and 20-0100. Not pictured.
20-0085P	Straight exhaust adaptor (includes adaptor, hose and clamps). For use with 2 1/2" I.D. exhaust hose.
20-0086P	90 degree exhaust elbow adaptor (includes adaptor, hose and clamps). For use with 2 1/2" I.D. exhaust hose.
20-0088P	30 degree exhaust elbow adaptor (includes adaptor, hose and clamps). For use with 2 1/2" I.D. exhaust hose.
20-0089P	30 degree exhaust elbow adaptor (includes adaptor, hose and clamps). For use with 3" I.D. exhaust hose.
20-0097	3" spacer block (complete with mounting hardware, gasket and 3/4" pipe plug). Capable of stacking.
CHV-1-83P	Manifold mounting package (includes bolts and pipe plugs).
CHV-1-83SS-P	Stainless steel manifold mounting package (includes stainless bolts and brass plugs). Not pictured.
CHV-27-0083	Alternator bracket. Use where engine water pump is mounted on port side of engine below alternator.
CHV-47-0000	Manifold to cylinder head gasket.

Note:

Manifold includes all plugs, gaskets and mounting hardware to head. Risers include plugs, gasket and mounting hardware to mount to manifold.

BARR
MARINE BY EDM

Indmar V8-427 and 454 C.I.D. All Models Inboard

Part Number
20-0000

CENTER RISER GENERIC

Internal
Water
Discharge



CHVA 1 84

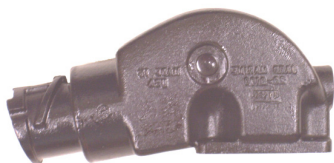

20 0100



20 0082



20 0085P



20 0097



20 0084P



20 0086P



20 0087P



20 0088P



20 0089P



20 0092P



20 0093P



20 0082P



CHVA 1 84P



1 0105



1 0107

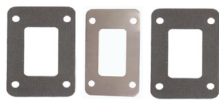

1 0104P

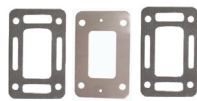

1 0106P



CHVA 47 0000

Note:
Manifold includes all plugs, gaskets and mounting hardware to head. Risers include plugs, gasket and mounting hardware to mount to manifold.

CHVA-1-84	Water cooled center discharge manifold to fit the big block GM engine (3/4" N.P.T. cooling hose connections). All years.
20-0082	Water cooled center discharge riser (3/4" N.P.T. cooling hose connection). Standard for use with 3" I.D. exhaust hose.
20-0100	Water cooled center discharge riser (3/4" N.P.T. cooling hose connection). Standard for use with 4" I.D. exhaust hose.
1-0104P	Adaptor package for fresh water cooled manifold (includes gaskets and block off plate).
1-0105	Center riser manifold-to-riser gasket for fresh water cooling.
1-0106P	Adaptor package for raw water cooling. Used in pre-heating applications (includes gaskets and block off plate with vent hole).
1-0107	Center riser manifold-to-riser gasket (raw water cooling).
20-0082P	Riser mounting package for both 20-0082 and 20-0100.
20-0082SS-P	Stainless steel mounting package (with brass plugs) for both 20-0082 and 20-0100. Not pictured.
20-0084P	Straight exhaust adaptor (includes adaptor, hose and clamps). For use with 3 1/2" I.D. exhaust hose.
20-0085P	Straight exhaust adaptor (includes adaptor, hose and clamps). For use with 2 1/2" I.D. exhaust hose.
20-0086P	90 degree exhaust elbow adaptor (includes adaptor, hose and clamps). For use with 2 1/2" I.D. exhaust hose.
20-0087P	90 degree exhaust elbow adaptor (includes adaptor, hose and clamps). For use with 3" I.D. exhaust hose.
20-0088P	30 degree exhaust elbow adaptor (includes adaptor, hose and clamps). For use with 2 1/2" I.D. exhaust hose.
20-0089P	30 degree exhaust elbow adaptor (includes adaptor, hose and clamps). For use with 3" I.D. exhaust hose.
20-0092P	45 degree exhaust elbow adaptor (includes adaptor, hose and clamps). For use with 3" I.D. exhaust hose.
20-0093P	90 degree exhaust elbow adaptor (includes adaptor, hose and clamps). For use with 3 1/2" or 4" I.D. exhaust hose.
20-0097	3" spacer block (complete with mounting hardware, gasket and 3/4" pipe plug). Capable of stacking.
CHVA-1-84P	Manifold mounting package (includes bolts and pipe plugs).
CHVA-1-84SS-P	Stainless steel manifold mounting package (includes stainless bolts and brass plugs). Not pictured.
CHVA-47-0000	Manifold to cylinder head gasket.

BARR
MARINE BY EDM

8-1/2"

9-1/2"

28

Part Number

7-5/8"

30°

"A"

2-9/16"

6-1/8"

6-1/8"

Indmar V8-302 and 351 C.I.D. All Models Inboard

CENTER RISER GENERIC

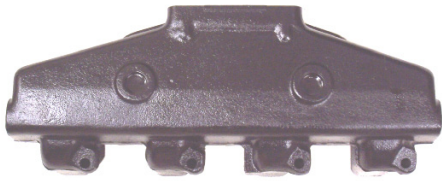

FM 1 83

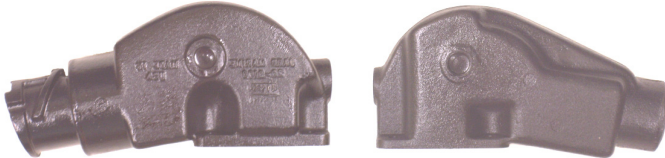

20 0100

20 0082

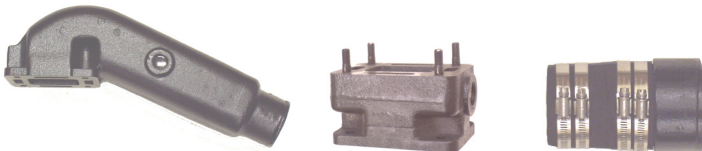

20 0102

20 0097

20 0084P



20 0085P

20 0086P

20 0087P

20 0088P



20 0089P

20 0092P

20 0093P



20 0082P

FM 1 83P

1 0105

1 0107



1 0104P

1 0106P

FM 47 0000

Note:
Manifold includes all plugs, gaskets and mounting hardware to head. Risers include plugs, gasket and mounting hardware to mount to manifold.

FM-1-83	Water cooled center discharge manifold to fit the small block Ford engine (3/4" N.P.T. cooling hose connections). All years.
20-0082	Water cooled center discharge riser (3/4" N.P.T. cooling hose connection). Standard for use with 3" I.D. exhaust hose.
20-0100	Water cooled center discharge riser (3/4" N.P.T. cooling hose connection). Standard for use with 4" I.D. exhaust hose.
20-0102	Water cooled center discharge riser (3/4" N.P.T. cooling hose connection). Replaces Indmar # 532009.
1-0104P	Adaptor package for fresh water cooled manifold (includes gaskets and block off plate).
1-0105	Center riser manifold-to-riser gasket for fresh water cooling.
1-0106P	Adaptor package for raw water cooling. Used in pre-heating applications (includes gaskets and block off plate with vent hole).
1-0107	Center riser manifold-to-riser gasket (raw water cooling).
20-0082P	Riser mounting package for both 20-0082 and 20-0100.
20-0082SS-P	Stainless steel mounting package (with brass plugs) for both 20-0082 and 20-0100. Not pictured.
20-0084P	Straight exhaust adaptor (includes adaptor, hose and clamps). For use with 3 1/2" I.D. exhaust hose.
20-0085P	Straight exhaust adaptor (includes adaptor, hose and clamps). For use with 2 1/2" I.D. exhaust hose.
20-0086P	90 degree exhaust elbow adaptor (includes adaptor, hose and clamps). For use with 2 1/2" I.D. exhaust hose.
20-0087P	90 degree exhaust elbow adaptor (includes adaptor, hose and clamps). For use with 3" I.D. exhaust hose.
20-0088P	30 degree exhaust elbow adaptor (includes adaptor, hose and clamps). For use with 2 1/2" I.D. exhaust hose.
20-0089P	30 degree exhaust elbow adaptor (includes adaptor, hose and clamps). For use with 3" I.D. exhaust hose.
20-0092P	45 degree exhaust elbow adaptor (includes adaptor, hose and clamps). For use with 3" I.D. exhaust hose.
20-0093P	90 degree exhaust elbow adaptor (includes adaptor, hose and clamps). For use with 3 1/2" or 4" I.D. exhaust hose.
20-0097	3" spacer block (complete with mounting hardware, gasket and 3/4" pipe plug). Capable of stacking.
FM-1-83P	Manifold mounting package (includes bolts and pipe plugs).
FM-1-83SS-P	Stainless steel manifold mounting package (includes stainless bolts and brass plugs). Not pictured.
FM-47-0000	Manifold to cylinder head gasket.



Interceptor V8-239, 256, 272, 292, and 312 C.I.D.

Models 125, 135, 150, 170, 185 and 215 H.P. LOG STYLE GENERIC

Port side part # INT 1 5457L

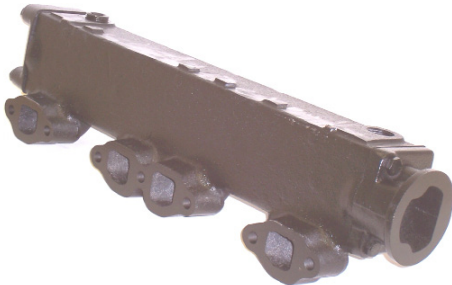

INT 1 5457R



20 0000



20 0031



20 0055



20 0039



20 0035



20 0034



20 0002P



INT 1 5457P



1 0022

INT-1-5457L	Water cooled exhaust manifold (port side) for the Ford engine. Use with Barr risers and exhaust connectors. The original Interceptor exhaust connectors are not applicable to the Barr manifolds.
INT-1-5457R	Water cooled exhaust manifold (starboard) for the Ford engine. Use with Barr risers and exhaust connectors. The original Interceptor exhaust connectors are not applicable to the Barr manifolds.
1-0022	End plate gasket (will fit both ends).
INT-1-5457P	Manifold to cylinder head mounting kit.
20-0000	Swivel-type high discharge exhaust riser; 8 1/2" riser protection. Requires (1) mounting hardware kit #20-0002P per riser. Use only with 2 7/8" to 3" I.D. exhaust hose.
20-0002P	Mounting hardware kit (Barr style riser/elbows only).
20-0031	Swivel-type 90 degree exhaust elbow connector with internal water discharge. Accepts 2 1/2" to 3" I.D. exhaust hose. Requires (1) mounting hardware kit #20-0002P per elbow.
20-0034 or 20-0035	Exhaust connector #20-0035 (for 2 1/2" I.D. exhaust hose) or exhaust connector #20-0034 (for 3" I.D. exhaust hose). Connects to #20-0039 using (1) #20-0002P per connector.
20-0039	Fully jacketed swivel-type exhaust riser; 7" riser protection. Requires (2) mounting hardware kits #20-0002P ((1) kit to mount riser to manifold and (1) kit to mount elbows 20-0034 or 20-0035 to riser).
20-0055	Swivel-type 30 degree exhaust elbow connector; fully jacketed. Accepts 2 1/2" or 3" I.D. exhaust hose. Requires (1) mounting hardware kit #20-0002P per elbow.

BARR
MARINE BY EDM

Interceptor V8-221, 260 and 289 C.I.D.

Models 120, 140, 165, 190, 200 and 210 H.P. **LOG STYLE GENERIC**

Port side part # INT 1 6268L



INT 1 6268R



20 0000

20 0031

20 0055

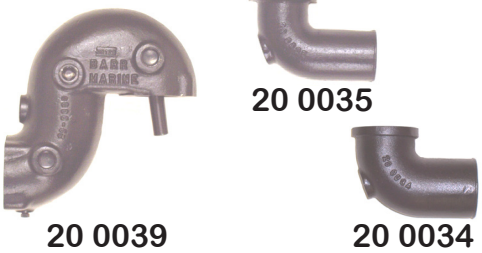

20 0039

20 0035

20 0034

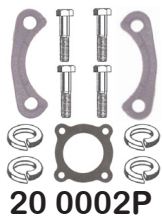

20 0002P



INT 1 6268P



FM 47 0000



1 0022

INT-1-6268L	Water cooled exhaust manifold (port) for the Ford engine. Use with Barr risers and connectors. The original Interceptor exhaust connectors are not applicable to the Barr manifolds.
INT-1-6268R	Water cooled exhaust manifold (starboard for the Ford engine. Use with the Barr risers and connectors. The original Interceptor exhaust connectors are not applicable to the Barr manifolds.
1-0022	End plate gasket (will fit both ends).
INT-1-6268P	Manifold to cylinder head mounting kit.
20-0000	Swivel-type high discharge exhaust riser; 8 1/2" riser protection. Requires (1) mounting hardware kit #20-0002P per riser. Use only with 2 7/8" to 3" I.D. exhaust hose.
20-0002P	Mounting hardware kit (Barr style riser/elbows only).
20-0031	Swivel-type 90 degree exhaust elbow connector with internal water discharge. Accepts 2 1/2" to 3" I.D. exhaust hose. Requires (1) mounting hardware kit #20-0002P per elbow.
20-0034 or 20-0035	Exhaust connector #20-0035 (for 2 1/2" I.D. exhaust hose) or exhaust connector #20-0034 (for 3" I.D. exhaust hose). Connects to #20-0039 using (1) #20-0002P per connector.
20-0039	Fully jacketed swivel-type exhaust riser; 7" riser protection. Requires (2) mounting hardware kits #20-0002P ((1) kit to mount riser to manifold and (1) kit to mount elbows 20-0034 or 20-0035 to riser).
20-0055	Swivel-type 30 degree exhaust elbow connector; fully jacketed. Accepts 2 1/2" or 3" I.D. exhaust hose. Requires (1) mounting hardware kit #20-0002P per elbow.

BARR
MARINE BY EDM

Interceptor V8-352, 390 and 427 C.I.D.

Models 240, 250, 260, 285, and 300 H.P. LOG STYLE GENERIC

Port side part # INT 1 58L

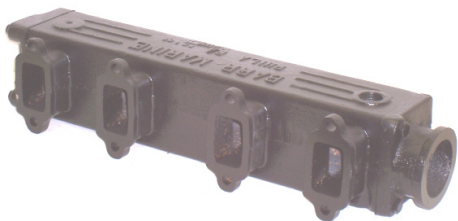

INT 1 58R



20 0000



20 0031



20 0055



20 0039



20 0035



20 0034

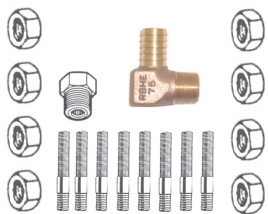

INT 1 58P

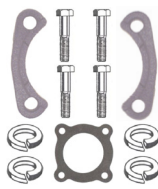

20 0002P

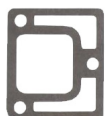

1 0019

INT-1-58L	Water cooled exhaust manifold (port) for the Ford engine. Use with Barr risers and connectors. The original Interceptor exhaust connectors are not applicable to the Barr manifolds.
INT-1-58R	Water cooled exhaust manifold (starboard) for the Ford engine. Use with Barr risers and connectors. The original Interceptor exhaust connectors are not applicable to the Barr manifolds.
1-0019	End plate gasket (will fit both ends).
INT-1-58P	Manifold to cylinder head mounting kit.
20-0000	Swivel-type high discharge exhaust riser; 8 1/2" riser protection. Requires (1) mounting hardware kit #20-0002P per riser. Use only with 2 7/8" to 3" I.D. exhaust hose.
20-0002P	Mounting hardware kit (Barr style riser/elbows only).
20-0031	Swivel-type 90 degree exhaust elbow connector with internal water discharge. Accepts 2 1/2" to 3" I.D. exhaust hose. Requires (1) mounting hardware kit #20-0002P per elbow.
20-0034 or 20-0035	Exhaust connector #20-0035 (for 2 1/2" I.D. exhaust hose) or exhaust connector #20-0034 (for 3" I.D. exhaust hose). Connects to #20-0039 using (1) #20-0002P per connector.
20-0039	Fully jacketed swivel-type exhaust riser; 7" riser protection. Requires (2) mounting hardware kits #20-0002P ((1) kit to mount riser to manifold and (1) kit to mount elbows 20-0034 or 20-0035 to riser).
20-0055	Swivel-type 30 degree exhaust elbow connector; fully jacketed. Accepts 2 1/2" or 3" I.D. exhaust hose. Requires (1) mounting hardware kit #20-0002P per elbow.

BARR
MARINE BY EDM

Interceptor V8-221, 260, 289, 302 and 351 C.I.D.

ALL MODELS CENTER RISER GENERIC

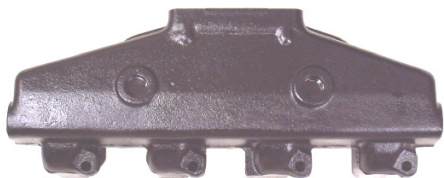

FM 1 83

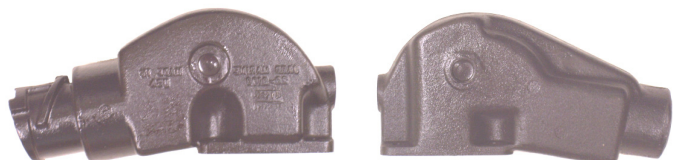

20 0100

20 0082



20 0097



20 0084P



20 0085P



20 0086P



20 0087P



20 0088P



20 0089P



20 0092P



20 0093P



20 0082P



FM 1 83P

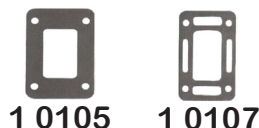

1 0105 1 0107

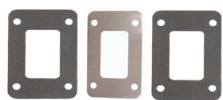

1 0104P

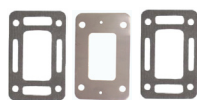

1 0106P



FM 47 0000

Note:
Manifold includes all plugs, gaskets and mounting hardware to head. Risers include plugs, gasket and mounting hardware to mount to manifold.

FM-1-83	Water cooled center discharge manifold to fit the small block Ford engine (3/4" N.P.T. cooling hose connections). All years.
20-0082	Water cooled center discharge riser (3/4" N.P.T. cooling hose connection). Standard for use with 3" I.D. exhaust hose.
20-0100	Water cooled center discharge riser (3/4" N.P.T. cooling hose connection). Standard for use with 4" I.D. exhaust hose.
1-0104P	Adaptor package for fresh water cooled manifold (includes gaskets and block off plate).
1-0105	Center riser manifold-to-riser gasket for fresh water cooling.
1-0106P	Adaptor package for raw water cooling. Used in pre-heating applications (includes gaskets and block off plate with vent hole).
1-0107	Center riser manifold-to-riser gasket (raw water cooling).
20-0082P	Riser mounting package for both 20-0082 and 20-0100.
20-0082SS-P	Stainless steel mounting package (with brass plugs) for both 20-0082 and 20-0100. Not pictured.
20-0084P	Straight exhaust adaptor (includes adaptor, hose and clamps). For use with 3 1/2" I.D. exhaust hose.
20-0085P	Straight exhaust adaptor (includes adaptor, hose and clamps). For use with 2 1/2" I.D. exhaust hose.
20-0086P	90 degree exhaust elbow adaptor (includes adaptor, hose and clamps). For use with 2 1/2" I.D. exhaust hose.
20-0087P	90 degree exhaust elbow adaptor (includes adaptor, hose and clamps). For use with 3" I.D. exhaust hose.
20-0088P	30 degree exhaust elbow adaptor (includes adaptor, hose and clamps). For use with 2 1/2" I.D. exhaust hose.
20-0089P	30 degree exhaust elbow adaptor (includes adaptor, hose and clamps). For use with 3" I.D. exhaust hose.
20-0092P	45 degree exhaust elbow adaptor (includes adaptor, hose and clamps). For use with 3" I.D. exhaust hose.
20-0093P	90 degree exhaust elbow adaptor (includes adaptor, hose and clamps). For use with 3 1/2" or 4" I.D. exhaust hose.
20-0097	3" spacer block (complete with mounting hardware, gasket and 3/4" pipe plug). Capable of stacking.
FM-1-83P	Manifold mounting package (includes bolts and pipe plugs).
FM-1-83SS-P	Stainless steel manifold mounting package (includes stainless bolts and brass plugs). Not pictured.
FM-47-0000	Manifold to cylinder head gasket.

BARR
MARINE BY EDM

MerCruiser 4 Cylinder 153 C.I.D. 120 H.P.

Model 120 Engine LOG STYLE DIRECT REPLACEMENT

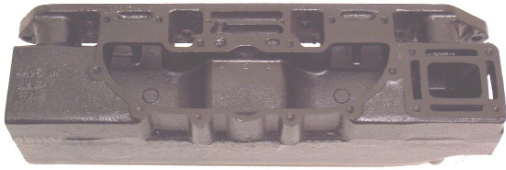

MC 1 63122



MC 20 55538



MC 29 60372



MC 29 47587



1 73811



1 47638



MC47 475KIT



MC47 27 35898



MC47 27 39915



1 73811P

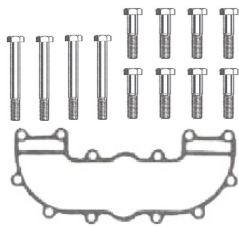

MC 1 35898P

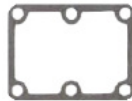

1 47638P

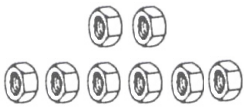

MC 1 63122P



MC 20 55538P



MC47 27 39923

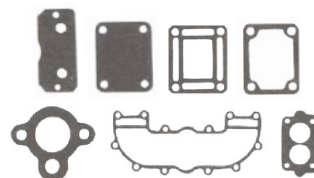

MC47 27 35898A4



MC47 27 52546



MC47 27 39917

MC-1-63122	Direct replacement water cooled exhaust manifold. Replaces MerCruiser part # B-63122A1.
MC-20-55538	Direct replacement exhaust elbow/riser. Replaces MerCruiser part # B-39920 and # B-55538A2.
MC-20-55538P	Riser to exhaust manifold mounting package.
1-39949P	Choke oven cover assembly. Not pictured.
1-47638	Direct replacement exhaust manifold end cap/connector (front). Replaces MerCruiser part # B-47638.
1-47638P	Exhaust manifold end cap/connector (front) mounting package.
1-73811	Direct replacement exhaust manifold end cap (rear).
1-73811P	Exhaust manifold end cap (rear) mounting package.
MC-1-35898P	Intake manifold mounting package.
MC-1-63122P	Exhaust manifold mounting package.
MC-29-47587	Direct replacement lower thermostat housing.
MC-29-60372	Direct replacement upper thermostat housing.
MC47-475KIT	Thermostat kit (includes gasket and thermostat).
MC47-27-35898	Direct replacement intake manifold gasket.
MC47-27-35898A4	Exhaust manifold gasket set.
MC47-27-39915	Direct replacement exhaust manifold to exhaust elbow gasket.
MC47-27-39917	Direct replacement exhaust manifold end cap/connector gasket.
MC47-27-39923	Direct replacement exhaust manifold end cap gasket.
MC47-27-52546	Direct replacement exhaust manifold to cylinder head gasket.

Note:
 Manifold includes all plugs, gaskets and mounting hardware to head. Riser includes plugs, gasket and mounting hardware to mount to manifold.

BARR
 MARINE BY EDM

MerCruiser 4 Cylinder 181 C.I.D. 140 H.P.

Model 140 Engine LOG STYLE DIRECT REPLACEMENT



MC 1 52390

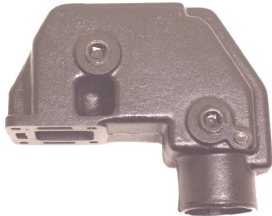

MC 20 60426



MC 20 61851A3



MC 29 47587



MC 29 60372



MC47 475KIT



MC 20 60426P



1 54870/73813



1 60252



1 60252P



1 54870P

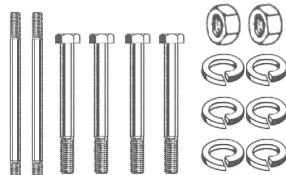

MC 1 52390P



MC 20 60207



MC 20 55730

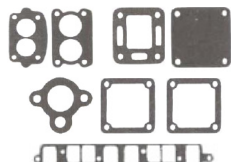

MC47 27 53354A1



MC47 27 73814



MC47 27 52076



MC47 27 48043



MC47 27 53354

MC-1-52390	Direct replacement water cooled exhaust manifold. Replaces MerCruiser part # B-52390A1. For serial # 3332138 and up.
MC-20-60426	Direct replacement exhaust elbow riser (utilizes a stainless steel sleeve at the water/air mixing area). Replaces MerCruiser part #B-60426A1.
MC-20-76351	Direct replacement exhaust elbow riser. Replaces MerCruiser part # B-76351A1. Not pictured.
1-54870	Direct replacement exhaust manifold rear end cap. Serial # 4481625 and below.
1-54870P	Rear end cap mounting package.
1-60252	Direct replacement exhaust manifold end cap/connector. Replaces MerCruiser part # B-60252.
1-60252P	Front end plate mounting package.
1-73813	Direct replacement exhaust manifold rear end cap. Serial # 4481625 and up.
MC-1-52390P	Exhaust manifold mounting package.
MC-20-55730	Stainless steel fresh water cooling block off plate for use with MerCruiser riser #'s 60426, 76351 and 76771. Requires (2) gaskets part # MC47-27-52076.
MC-20-60207	Stainless steel block off plate (with vent hole) for use with MerCruiser riser #'s 60426, 76351 and 76771. Requires (2) gaskets part # MC47-27-52076. Used in pre-heating plumbing systems.
MC-20-60426P	Exhaust riser elbow mounting package. For use with both MC-20-60426 and MC-20-76351 risers.
MC-20-61851A3	Manifold to riser 3" spacer (single block). Includes all mounting hardware, gaskets and drain plug.
MC-29-47587	Lower thermostat housing.
MC-29-60372	Upper thermostat housing.
MC47-475KIT	Thermostat kit (includes gasket and thermostat).
MC47-27-48043	Direct replacement exhaust manifold end cap/connector gasket (will fit both ends).
MC47-27-52076	Direct replacement exhaust elbow to exhaust manifold gasket.
MC47-27-53354	Direct replacement exhaust manifold to cylinder head gasket.
MC47-27-53354A1	Exhaust manifold gasket set.
MC47-27-73814	Direct replacement exhaust manifold end cap gasket. Utilized with 1-73813 rear end cap.

Note:

Manifold includes all plugs, gaskets and mounting hardware to head. Riser includes plugs, gasket and mounting hardware to mount to manifold.

BARR
MARINE BY EDM

MerCruiser 4 Cyl. 153 & 181 C.I.D. 120 H.P. (2.5L), 140 H.P. (3.0L)

Models 120 R and 140R-MR/Alpha 1 Engine

LOG STYLE DIRECT REPLACEMENT



MC 1 99798



MC 20 12076



MC 20 76325



MC 20 61851A3



MC 29 47587



MC 29 60372



MC47 475KIT



MC 20 12076P



1 99179



1 60252



MC 20 76325P



MC 1 99798P

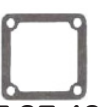

MC47 27 48043

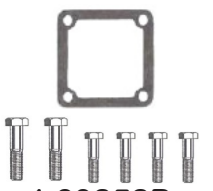

1 60252P

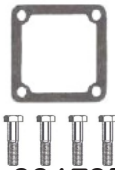

1 99179P



MC47 27 73814



MC47 27 99777A1



MC47 27 96429



MC47 27 99777

MC-1-95862	Direct replacement water cooled manifold (Rochester (3 1/4" X 1 7/8") bolt pattern). 6 bolt mounting. Replaces MerCruiser part # 95862A9 (no choke stove).
MC-1-96705	Direct replacement water cooled manifold (Rochester (3 1/4" X 1 7/8") bolt pattern). 6 bolt mounting. Replaces MerCruiser part # 96705A1.
MC-1-99798	Direct replacement water cooled manifold (MerCarb (3 11/16" X 2") bolt pattern). 6 bolt mounting. Replaces MerCruiser part # 99798A9.
MC-20-12076	Direct replacement exhaust riser. Replaces MerCruiser part # 12076A2.
MC-20-76325	Direct replacement exhaust riser. Replaces MerCruiser part # 76325A2.
I-60252	Direct replacement exhaust manifold end cap/connector. Replaces MerCruiser part # B-60252.
I-60252P	Front end plate mounting package.
I-99197	Direct replacement exhaust manifold rear end cap/lifting eye.
I-99179P	Rear end cap mounting package.
MC-1-99798P	Exhaust manifold to cylinder head mounting package.
MC-20-12076	P/Riser mounting package
MC-20-61851A3	Manifold to riser 3" spacer (single block). Includes all mounting hardware, gaskets and drain plug.
MC-29-47587	Lower thermostat housing.
MC-29-60372	Upper thermostat housing.
MC47-475KIT	Thermostat kit (includes gasket and thermostat).
MC47-27-48043	Direct replacement exhaust manifold end cap/connector gasket (will fit both ends).
MC47-27-73814	Direct replacement exhaust manifold end cap gasket. Utilized with I-73813 rear end cap.
MC47-27-96429	Direct replacement exhaust manifold to cylinder head gasket.
MC47-27-99777	Direct replacement exhaust elbow to manifold gasket. Supersedes MerCruiser part # 27-52076.
MC47-27-99777A1	Exhaust manifold gasket set.

Note:
 Manifold includes all plugs, gaskets and mounting hardware to head. Risers include plugs, gasket and mounting hardware to mount to manifold.

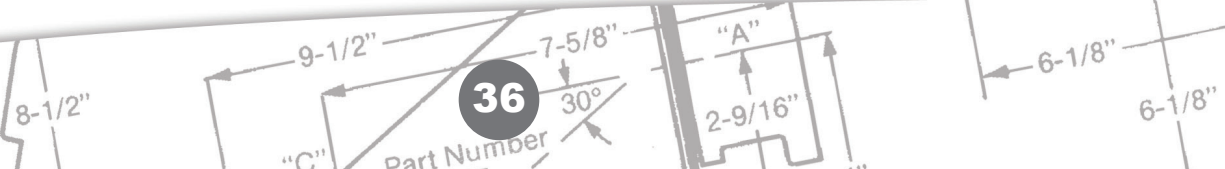

MerCruiser 4 Cylinder 181 C.I.D. 140 H.P. 3.0L & 3.0LX Models

All Models 1990 and Up (Vortec Style Head)

LOG STYLE DIRECT REPLACEMENT



MC 1 860235



MC 20 12076

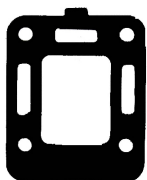

MC47 27 99777-2

MC 1 860235	Direct replacement exhaust manifold. Replaces MerCruiser part # 860235A04.
MC 20 12076	Direct replacement exhaust riser. Replaces MerCruiser part # 12076A2.
MC 20 12076P	Exhaust riser mounting kit.
50 170 207	3/8"-16 X 3/4" Hex Head Cap Screw (for mounting lifting eye).
50 512 020	Fitting, 3/4" N.P.T. X 1" hose.
MC47 27 99777-2	Replacement exhaust riser to manifold gasket. Supersedes MerCruiser part # 27-52076 and 27-99777.
MC47 27 807982	Replacement carburetor to intake/exhaust manifold gasket.
MC47 27 815528	Replacement cylinder head to exhaust manifold gasket.
MC 50 865549	Lifting eye.
MC 50 10 53728	Replacement 3/8"-16 X 4 5/8" screw.
MC 50 10 806300	Replacement 3/8" X 5 3/8" stud.
MC 50 11 24883	Replacement nut.
MC 50 11 862902	Replacement nut.
MC 50 12 20553	Replacement washer.
MC 50 22 806608	Drain plug.
MC 50 22 845175	Replacement reducer bushing, 3/4" to 3/8".
MC 50 22 862557	Replacement bushing, 3/8 X 1/2 NPT.
MC 50 22 862065	Replacement 90 degree adaptor assembly.
MC 50 25 32506	Replacement O-Ring.
MC 50 32 14797	Replacement fuel line.
MC 50 23 861634	Replacement cooling water hose, formed.

Note:
 Manifold includes all plugs, gaskets and mounting hardware to head. Risers include plugs, gasket and mounting hardware to mount to manifold.

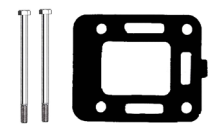

MC 20 12076P



50 170 207



MC 50 22 845175



MC 50 22 862557



MC47 27 807982



MC 50 11 24883



MC 50 22 862065



MC 50 22 806608



MC 50 11 862902



MC 50 10 806300



MC47 27 815528



MC 50 10 53728

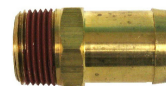

50 512 020



MC 50 865549



MC 50 32 14797



MC 50 25 32506



MC 50 12 20553



MC 50 23 861634

BARR
 MARINE BY EDM

MerCruiser Straight 6 Cylinder Model 165

LOG STYLE DIRECT REPLACEMENT



MC 1 58759

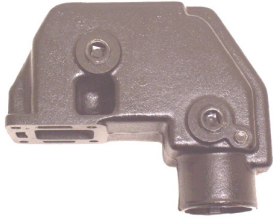

MC 20 60426



MC 20 61851A3



MC47 475KIT

MC-1-58759	Direct replacement water cooled manifold to fit the 6 cyl. GM (Model 165) engine. Replaces MerCruiser part # B-58759A1.
MC-20-60426	Direct replacement exhaust elbow riser (utilizes a stainless steel sleeve at the water/air mixing area). Replaces MerCruiser part #B-60426A1.
MC-20-76351	Direct replacement exhaust elbow riser. Replaces MerCruiser part # B-76351A1. Not pictured.
1-54870	Direct replacement exhaust manifold end cap (rear). Superseded by part # 1-73813.
1-54870P	Exhaust manifold end cap (rear) mounting package.
1-60252	Direct replacement exhaust manifold end cap/connector (front). Replaces MerCruiser part # B-60252.
1-60252P	Exhaust manifold end cap/connector mounting package.
1-73813	Direct replacement manifold end cap (rear). Supercedes part # 1-54870.
1-71813P	Exhaust manifold end cap mounting package.
MC-1-58759P	Exhaust manifold mounting package.
MC-1-58764P	Manifold to carburetor adaptor mounting package.
MC-20-55730	Stainless steel fresh water cooling block off plate for use with MerCruiser riser #'s 60426, 76351 and 76771. Requires (2) gaskets part # MC47-27-99777.
MC-20-60207	Stainless steel block off plate (with vent hole) for use with MerCruiser riser #'s 60426, 76351 and 76771. Requires (2) gaskets part # MC47-27-99777. Used in pre-heating plumbing systems.
MC-20-60426P	Exhaust riser elbow mounting package. For use with both MC-20-60426 and MC-20-76351 risers.
MC-20-61851A3	Manifold to riser 3" spacer (single block). Includes all mounting hardware, gaskets and drain plug.
MC-29-47587	Lower thermostat housing.
MC-29-60372	Upper thermostat housing.
MC47-475KIT	Thermostat kit (includes gasket and thermostat).
MC47-27-46401	Direct replacement manifold to head gasket.
MC47-27-46401A1	Exhaust manifold gasket set.
MC47-27-48043	Direct replacement exhaust manifold end cap/connector gasket (will fit both ends).
MC47-27-58764	Direct replacement manifold to carburetor adaptor gasket.
MC47-27-73814	Direct replacement exhaust manifold end cap gasket. Utilized with 1-73814 rear end cap.
MC47-27-99777	Direct replacement exhaust elbow to manifold gasket. Supersedes MerCruiser part # 27-52076.



MC 29 47587



MC 29 60372



MC 20 60426P



1 54870/73813

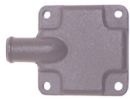

1 60252

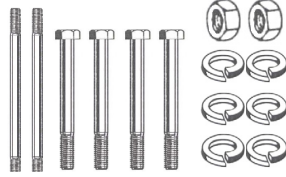

MC 1 58759P



1 60252P



1 54870P

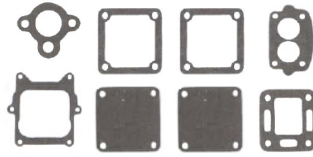

MC47 27 46401A1



MC 20 60207



MC 20 55730



MC47 27 46401



MC 1 58764P



MC47 27 99777



MC47 27 73814



MC47 27 58764



MC47 27 48043

Note:
Manifold includes all plugs, gaskets and mounting hardware to head. Risers include plugs, gasket and mounting hardware to mount to manifold.

BARR
MARINE BY EDM

8-1/2"

9-1/2"

38

Part Number

7-5/8"

30°

"A"

2-9/16"

6-1/8"

6-1/8"

Internal Water Discharge

Discharge
Part Number
20-0000

"C"

"A"

2"

MerCruiser V6-229 C.I.D. and 262 C.I.D.

Models 185R, 185MR, 205R and 205MR

CENTER RISER DIRECT REPLACEMENT



MC 1 99746

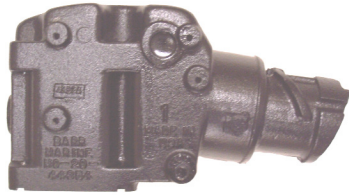

MC 20 44354

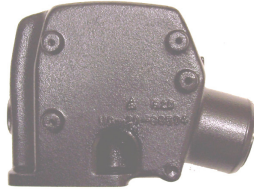

MC 20 98504

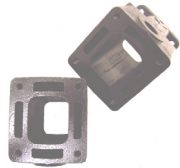

MC 20 93322A3



MC 20 93320A3



MC 27 93175



MC 20 87918



MC 20 99208



MC 50 806926



MC 50 87238



MC 20 44354P

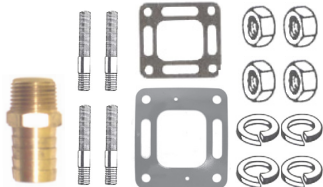

MC 20 98504P



MC47 27 41811



MC47 27 87105



MC47 27 41813



MC47 27 99757

MC-1-99746	Direct replacement water cooled exhaust manifold. Replaces MerCruiser part # 99746A3 or part # 99746A8.
MC-20-44354	Direct replacement water cooled center discharge riser. Replaces MerCruiser part # B-44354A3. Accepts 4" I.D. exhaust hose (8 degree angle).
MC-20-98504	Direct replacement water cooled center discharge riser. Replaces MerCruiser part #98504A3. Accepts 3" I.D. exhaust hose (15 degree angle).
MC-20-44354P	Mounting package for MC-20-44354 riser.
MC-20-87918	Direct replacement stainless steel block off plate for use with MerCruiser riser #'s 98502, 98504 and 44354. Requires (2) gaskets part # MC47-27-41813.
MC-20-93320A3	Manifold to riser 3" spacer blocks (pair) with fastener and gasket package.
MC-20-93322A3	Manifold to riser 6" spacer blocks (pair) with fastener and gasket package.
MC-20-98504P	Mounting package for MC-20-98504 riser (includes gaskets, drain plug, pipe plug, stainless steel restrictor plate and fasteners).
MC-20-99208	Direct replacement stainless steel restrictor plate for use with MerCruiser riser #'s 98502, 98504 and 44354. Requires (2) gaskets part # MC47-27-41813.
MC-27-93175	Alternator bracket.
MC47-27-41811	Direct replacement restrictor gasket. Replaces MerCruiser part # 27-41811. To be used with MC-20-87918 ((2) required per plate used).
MC47-27-41813	Direct replacement restrictor gasket. Replaces MerCruiser part # 41813.
MC47-27-87105	Direct replacement exhaust elbow gasket. Replaces MerCruiser part # 27-87105.
MC47-27-99757	Direct replacement manifold to head gasket.
MC-50-87238	Exhaust manifold drain cock.
MC-50-806926	Replacement 3/4" N.P.T. X 1" hose fitting (90 degree)/brass drain cock.

Note:

Manifold includes all plugs, gaskets and mounting hardware to head. Risers include plugs, gasket and mounting hardware to mount to manifold.



MerCruiser V8-283, 302, 305, 307, 327 and 350 C.I.D.

ALL MODELS CENTER RISER GENERIC



CHV 1 83

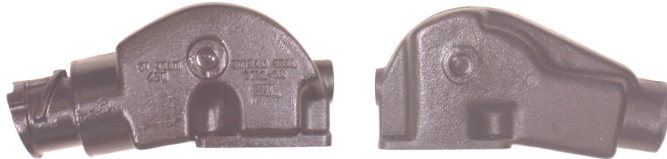

20 0100

20 0082



20 0097

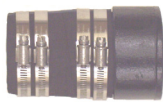

20 0084P

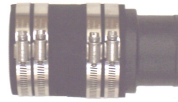

20 0085P



20 0086P



20 0087P



20 0088P



20 0089P



20 0092P



20 0093P

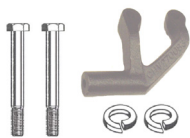

CHV 27 0083

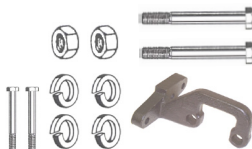

MC 45 0002



CHV 1 83P



20 0082P



1 0104P



1 0106P



CHV 47 0000



1 0105



1 0107

Note:
Manifold includes all plugs, gaskets and mounting hardware to head. Risers include plugs, gasket and mounting hardware to mount to manifold.

BARR
MARINE BY EDM

CHV-1-83	Water cooled center discharge manifold to fit the small block GM engine (3/4" N.P.T. cooling hose connections). All years.
20-0082	Water cooled center discharge riser (3/4" N.P.T. cooling hose connection). Standard for use with 3" I.D. exhaust hose.
20-0100	Water cooled center discharge riser (3/4" N.P.T. cooling hose connection). Standard for use with 4" I.D. exhaust hose.
1-0104P	Adaptor package for fresh water cooled manifold (includes gaskets and block off plate).
1-0105	Center riser manifold-to-riser gasket for fresh water cooling.
1-0106P	Adaptor package for raw water cooling. Used in pre-heating applications (includes gaskets and block off plate with vent hole).
1-0107	Center riser manifold-to-riser gasket (raw water cooling).
20-0082P	Riser mounting package for both 20-0082 and 20-0100.
20-0082SS-P	Stainless steel mounting package (with brass plugs) for both 20-0082 and 20-0100. Not pictured.
20-0084P	Straight exhaust adaptor (includes adaptor, hose and clamps). For use with 3 1/2" I.D. exhaust hose.
20-0085P	Straight exhaust adaptor (includes adaptor, hose and clamps). For use with 2 1/2" I.D. exhaust hose.
20-0086P	90 degree exhaust elbow adaptor for I/O applications (includes adaptor, hose and clamps). For use with 2 1/2" I.D. exhaust hose.
20-0087P	90 degree exhaust elbow adaptor (includes adaptor, hose and clamps). For use with 3" I.D. exhaust hose.
20-0088P	30 degree exhaust elbow adaptor (includes adaptor, hose and clamps). For use with 2 1/2" I.D. exhaust hose.
20-0089P	30 degree exhaust elbow adaptor (includes adaptor, hose and clamps). For use with 3" I.D. exhaust hose.
20-0092P	45 degree exhaust elbow adaptor (includes adaptor, hose and clamps). For use with 3" I.D. exhaust hose.
20-0093P	90 degree exhaust elbow adaptor (includes adaptor, hose and clamps). For use with 3 1/2" or 4" I.D. exhaust hose.
20-0097	3" spacer block (complete with mounting hardware, gasket and 3/4" pipe plug). Capable of stacking.
CHV-1-83P	Manifold mounting package (includes bolts and pipe plugs).
CHV-1-83SS-P	Stainless steel manifold mounting package (includes stainless bolts and brass plugs). Not pictured.
CHV-27-0083	Alternator bracket. Use where engine water pump is mounted on port side of engine below alternator.
MC-45-0002	Fuel filter/solenoid bracket.
CHV-47-0000	Manifold to cylinder head gasket.

8-1/2"

9-1/2"

40

Part Number

7-5/8"

30°

"A"

2-9/16"

6-1/8"

6-1/8"

Internal Water Discharge

Discharge
"C"
Part Number
20-0000

"A"

2"

MerCruiser V8-198, 228, 255, 260 and 898

Inboard and Stern-Drive Units

LOG STYLE DIRECT REPLACEMENT



MC 1 77234



MC 1 77235

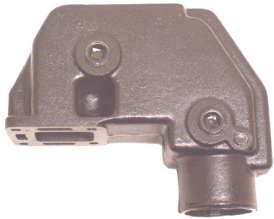

MC 20 60426

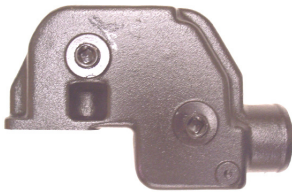

MC 20 76771

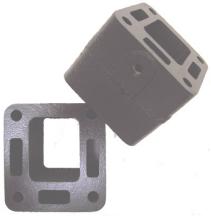

MC 20 61851A2



MC 29 78984



MC 29 47441

MC 27 48104



1 73813

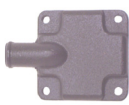

1 60252



MC 20 60426P



MC 20 60207



MC 20 55730

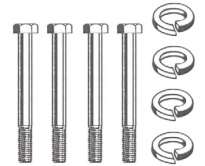

MC 1 77234P



1 60252P



1 73813P

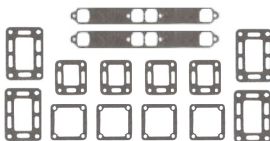

MC47 27 33395A2

MC-1-77234	Direct replacement water cooled exhaust manifold (port side). Replaces MerCruiser part # B-77234A2.
MC-1-77235	Direct replacement water cooled exhaust manifold (starboard side). Replaces MerCruiser part # B-77235A2.
MC-20-60426	Direct replacement exhaust elbow riser (utilizes a stainless steel sleeve at the water/air mixing area). Replaces MerCruiser part #B-60426A1 (I/O applications).
MC-20-76351	Direct replacement exhaust elbow riser. Replaces MerCruiser part # B-76351A1(I/O applications). Not pictured.
MC-20-76771	Direct replacement exhaust elbow riser. Replaces MerCruiser part # B-76771A3 (inboard applications).
1-60252	Direct replacement exhaust manifold end cap/connector. Replaces MerCruiser part # B-60252.
1-60252P	Front end plate mounting package.
1-73813	Direct replacement manifold end cap (rear). Supersedes part # 1-54870.
1-73813P	Rear end cap mounting package.
MC-1-7723P	Riser mounting stud package.
MC-1-77234P	Manifold mounting package.
MC-1-7723D	Riser mounting package.
MC-20-55730	Stainless steel fresh water cooling block off plate for use with MerCruiser riser #'s 60426, 76351 and 76771. Requires (2) gaskets part # MC47-27-99777.
MC-20-60207	Stainless steel block off plate (with vent hole) for use with MerCruiser riser #'s 60426, 76351 and 76771. Requires (2) gaskets part # MC47-27-99777. Used in pre-heating plumbing systems.
MC-20-60426P	Exhaust riser elbow mounting package. For use with both MC-20-60426 and MC-20-76351 risers.
MC-20-61851A2	Manifold to riser 3" spacers (sold in pairs). Includes all mounting hardware, gaskets and drain plugs.
MC-27-48104	Alternator mounting bracket.
MC-29-47441	Upper thermostat housing.
MC-29-78984	Lower thermostat housing.
MC47-488KIT	Thermostat kit (includes gasket and thermostat).
MC47-27-33395	Direct replacement exhaust manifold to head gasket.
MC47-27-33395A2	Exhaust manifold gasket set.
MC47-27-48043	Direct replacement exhaust manifold end cap/connector gasket (will fit both ends).
MC47-27-99777	Direct replacement exhaust elbow to manifold gasket. Supersedes MerCruiser part # 27-52076.

Note:
Manifold includes all plugs, gaskets and mounting hardware to head. Riser includes plugs, gasket and mounting hardware to mount to manifold.

BARR
MARINE BY EDM



MC47 27 48043



MC47 27 99777



MC47 27 33395



MC47 488KIT

MerCruiser V8-5.0L, 5.7L and 6.2L "Dry Joint" Exhaust

All Models Carbureted, MPI, Inboard, Alpha and Bravo Stern Drives

CENTER RISER DIRECT REPLACEMENT



MC 1 865735

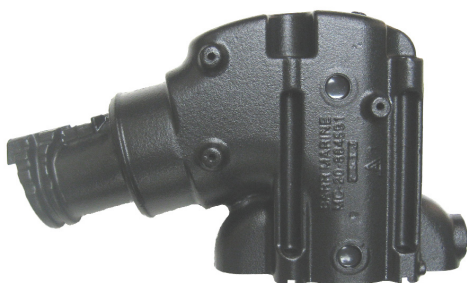

MC 20 864591

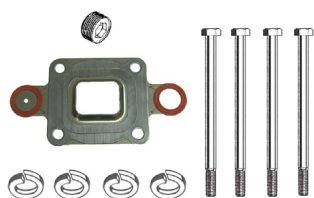

MC 20 864591P

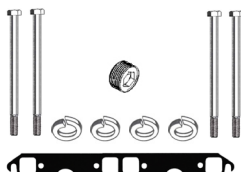

MC 1 865735P



50 170 275



50 170 248



CHV 47 0000



MC47 27 864850



MC47 27 864547



MC47 27 864549

MC-1-865735	Direct replacement exhaust manifold. Replaces MerCruiser part# 865735A02.
MC-20-864591	Direct replacement exhaust riser/ elbow. Replaces MerCruiser part # 864591T02. Riser will replace the equivalent part number used on 4.3L Models as well.
MC-1-865735P	Exhaust manifold mounting package. Riser gasket sold separately. Purchase correct gasket as needed. Not shown.
MC-20-864591P	Exhaust riser mounting package. Includes restrictor gasket for raw water cooled applications.
MC47-27-864850	Direct replacement restrictor gasket. Replaces MerCruiser part # 864850A02 Please refer to supplied directions or OEM information for proper installation procedures.
MC47-27-864547	Direct replacement full flow gasket. Replaces MerCruiser part # 864547A02 Please refer to supplied directions or OEM information for proper installation procedures.
MC47-27-864549	Direct replacement block off gasket. Replaces MerCruiser part # 864549A02 Please refer to supplied directions or OEM information for proper installation procedures.
CHV-47-0000	Exhaust manifold to cylinder head gasket.
50-170-248	Replacement manifold mounting bolts. Replaces MerCruiser part # 8M2000229 (to be used with 3/8" lockwasher). Dimensions of bolt is 3/8"-16 X 4.75".
50-170-275	Replacement riser mounting and 6 inch spacer block mounting bolt. Replaces MerCruiser part # 865982057 (to be used with 3/8" lockwasher). Dimensions of bolt is 3/8"-16 X 7.50".

Note:
Manifold includes all applicable plugs, mounting hardware and manifold to cylinder head gasket. Riser includes all applicable plugs and mounting hardware only.

Note: Always use correct riser gasket for your application. Please refer to the correct guide to install gaskets correctly.

Note: Improperly installed gasket, leaks or damage caused by either are not covered by your Barr Marine warranty! Gaskets are not subject to exchange or refund under any circumstances.

BARR
MARINE BY EDM

8-1/2"

9-1/2"

42
Part Number

7-5/8"

30°

"A"

2-9/16"

6-1/8"

6-1/8"

MerCruiser V8-4.3L, 5.0L, 5.7L and 6.2L "Dry Joint" Spacers

All Models Carbureted, MPI, Inboard, Alpha and Bravo Stern Drives
CENTER RISER DIRECT REPLACEMENT

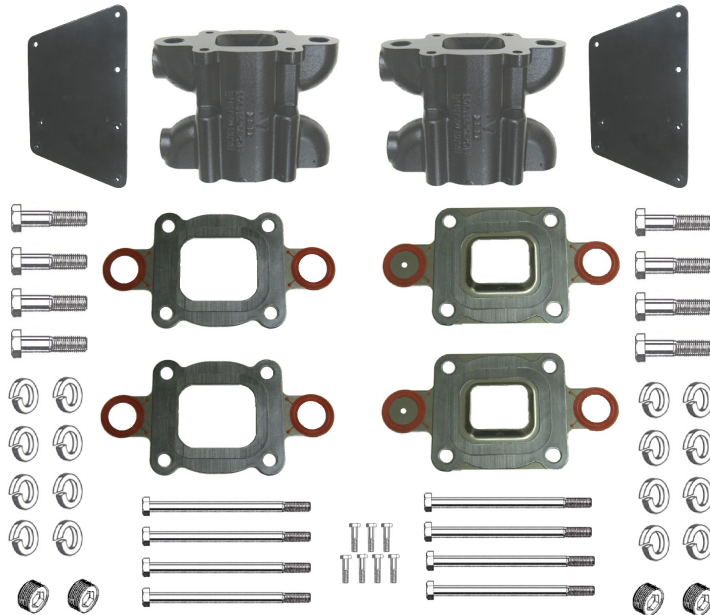

MC 20 864908A1

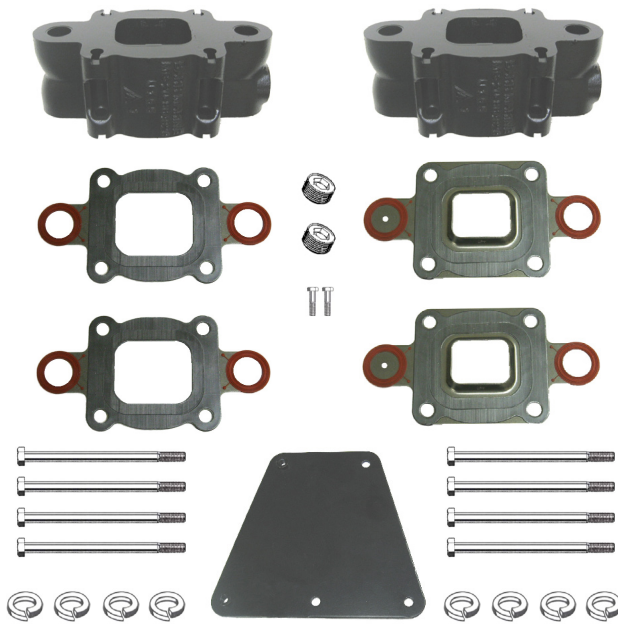

MC 20 864929A3

MC-20-864908A1	Direct replacement 6 inch spacer kit. Replaces MerCruiser part # 864908A1. Kit includes a pair of spacers, mounting hardware and gaskets for raw water cooled applications. Need to purchase additional block off gaskets for closed cooled applications. Sold as shown.
MC-20-864929A3	Direct replacement 3 inch spacer kit. Replaces MerCruiser part # 864929A 3. Kit includes a pair of spacers, mounting hardware and gaskets for raw water cooled applications. Need to purchase additional block off gaskets for closed cooled applications. Sold as shown.
MC-20-864908A1P	Six inch spacer mounting package. Includes all items less the spacers and brackets. Not shown separate.
MC-20-864908A1P	Three inch spacer mounting package. Includes all items less the spacers and brackets. Not shown separate.
MC47-27-864850	Direct replacement restrictor gasket. Replaces MerCruiser part # 864850A02 Please refer to supplied directions or OEM information for proper installation procedures.
MC47-27-864547	Direct replacement full flow gasket. Replaces MerCruiser part # 864547A02 Please refer to supplied directions or OEM information for proper installation procedures.
MC47-27-864549	Direct replacement block off gasket. Replaces MerCruiser part # 864549A02 Please refer to supplied directions or OEM information for proper installation procedures.
50-170-210	Replacement spacer mounting bolts. Replaces MerCruiser part # 865982005 (to be used with 3/8" lockwasher). Dimensions of bolt is 3/8"-16 X 1.00".
50-170-275	Replacement riser mounting and 6 inch spacer block mounting bolt. Replaces MerCruiser part # 865982057 (to be used with 3/8" lockwasher). Dimensions of bolt is 3/8"-16 X 7.50".
50-170-295	Replacement riser mounting and 3 inch spacer block mounting bolt. Replaces MerCruiser part # 865982077 (to be used with 3/8" lockwasher). Dimensions of bolt is 3/8"-16 X 10.50".

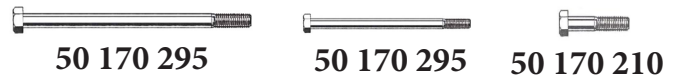

Note: Always use correct riser gasket for your application. Please refer to the correct guide to install gaskets correctly.

Note: Improperly installed gasket, leaks or damage caused by either are not covered by your Barr Marine warranty! Gaskets are not subject to exchange or refund under any circumstances.

BARR
 MARINE BY EDM

MerCruiser V8 Models 898R, 228R and 260R

CENTER RISER DIRECT REPLACEMENT



MC 1 87114

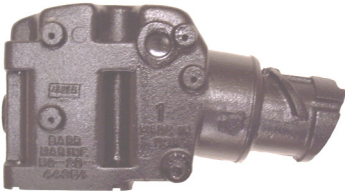

MC 20 44354

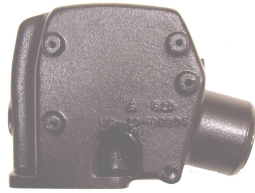

MC 20 98504

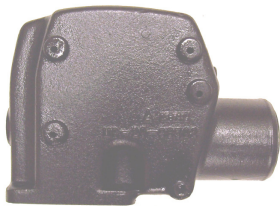

MC 20 98502

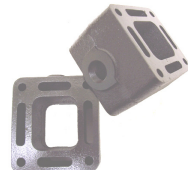

MC 20 93320A3

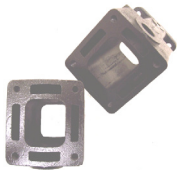

MC 20 93322A3



MC 29 47441



MC 29 87290



MC 27 93175



MC 20 87918



MC 20 99208



MC 50 806926



MC 50 87238

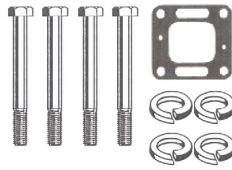

MC 20 44354P

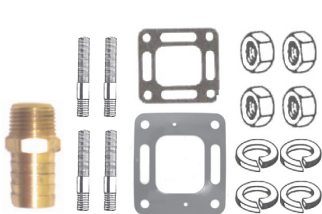

MC 20 98504P



MC47 27 41811



MC47 27 87105

BARR
MARINE BY EDM



MC47 27 41813



MC47 27 33395

MC-1-87114	Direct replacement water cooled exhaust manifold. Replaces MerCruiser part # 87114A8, 87114A19 and #860246A10.
MC-20-44354	Direct replacement water cooled center discharge riser. Replaces MerCruiser part # B-44354A3. Accepts 4" I.D. exhaust hose (8 degree angle).
MC-20-98502	Direct replacement water cooled center discharge riser. Replaces MerCruiser part #98502A2. Accepts 3" I.D. exhaust hose (0 degree angle).
MC-20-98504	Direct replacement water cooled center discharge riser. Replaces MerCruiser part #98504A3. Accepts 3" I.D. exhaust hose (15 degree angle).
MC-20-44354P	Mounting package for MC-20-44354 riser.
MC-20-87918	Direct replacement stainless steel block off plate for use with MerCruiser riser #'s 98502, 98504 and 44354. Requires (2) gaskets part # MC47-27-41813.
MC-20-93320A3	Manifold to riser 3" spacer blocks (pair) with fastener and gasket package.
MC-20-93322A3	Manifold to riser 6" spacer blocks (pair) with fastener and gasket package.
MC-20-98504P	Mounting package for MC-20-98504 riser (includes gaskets, drain plug, pipe plug, stainless steel restrictor plate and fasteners).
MC-20-99208	Direct replacement stainless steel restrictor plate for use with MerCruiser riser #'s 98502, 98504 and 44354. Requires (2) gaskets part # MC47-27-41813.
MC-27-93175	Alternator bracket.
MC-29-47441	Upper thermostat housing.
MC-29-87290	Lower thermostat housing.
MC47-27-33395	Direct replacement exhaust manifold to head gasket.
MC47-27-41811	Direct replacement restrictor gasket. Replaces MerCruiser part # 27-41811. To be used with MC-20-87918 ((2) required per plate used).
MC47-27-41813	Direct replacement restrictor gasket. Replaces MerCruiser part # 27-41813.
MC47-27-87105	Direct replacement exhaust elbow gasket. Replaces MerCruiser part # 27-87105.
MC-50-87238	Exhaust manifold drain cock.
MC-50-806926	Replacement 3/4" N.P.T. X 1" hose fitting (90 degree)/brass drain cock.

Note:

Manifold includes all plugs, gaskets and mounting hardware to head. Risers include plugs, gasket and mounting hardware to mount to manifold.

8-1/2"

9-1/2"

44

7-5/8"

"A"

2-9/16"

6-1/8"

6-1/8"

Discharge
Part Number
20-0000

"C"

"A"

Internal
Water
Discharge

2"

Part Number

MerCruiser V8-225, 250, 255, 270 and 280

Inboard and Stern-Drive Units

LOG STYLE DIRECT REPLACEMENT



MC 1 47737



MC 1 47738

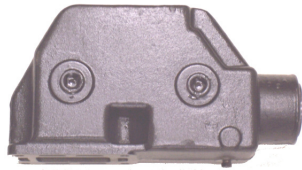

MC 20 72963

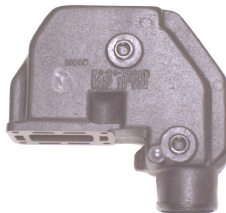

MC 20 76668



MC 20 61811A4



MC 29 78984



MC 29 47441



1 73813



1 60252



MC47 488KIT



MC 20 76668P



MC 20 72963P



1 60252P



1 73813P



MC 1 77234P



MC47 27 33395A2



MC47 27 48042



MC47 27 48043



MC47 27 33395

MC-1-47737	Direct replacement water cooled exhaust manifold (port side). Replaces MerCruiser part # B-47737A1.
MC-1-47738	Direct replacement water cooled exhaust manifold (starboard side). Replaces MerCruiser part # B-47738A1.
MC-20-72963	Direct replacement exhaust elbow riser. Replaces MerCruiser part # B-72963A1 (inboard applications).
MC-20-76668	Direct replacement exhaust elbow riser. Replaces MerCruiser part # B-76668A3, B-72964A1 and B-47877A4 (I/O applications).
1-60252	Direct replacement exhaust manifold end cap/connector. Replaces MerCruiser part # B-60252.
1-60252P	Front end plate mounting package.
1-73813	Direct replacement manifold end cap (rear). Supercedes part # 1-54870.
1-73813P	Rear end cap mounting package.
MC-1-77234P	Manifold mounting package. Use this package for the MC-1-47737 and MC-1-47738 manifolds.
MC-20-72963P	Exhaust riser elbow mounting package.
MC-20-76668P	Exhaust riser elbow mounting package.
MC-20-61811A4	Manifold to riser 3" spacers (sold in pairs). Includes all mounting hardware, gaskets and drain plugs.
MC-29-47441	Upper thermostat housing.
MC-29-78984	Lower thermostat housing.
MC47-488KIT	Thermostat kit (includes gasket and thermostat).
MC47-27-33395	Direct replacement exhaust manifold to head gasket.
MC47-27-33395A2	Exhaust manifold gasket set.
MC47-27-48042	Direct replacement exhaust elbow to manifold gasket.
MC47-27-48043	Direct replacement exhaust manifold end cap/connector gasket (will fit both ends).

Note:

Manifold includes all plugs, gaskets and mounting hardware to head. Riser includes plugs, gasket and mounting hardware to mount to manifold.

MerCruiser V8-454 and 502 C.I.D.

ALL MODELS CENTER RISER GENERIC



CHVA 1 84

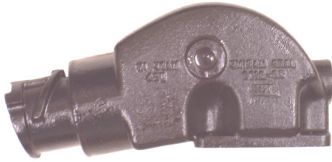

20 0100



20 0082



20 0097

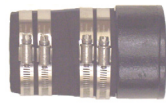

20 0084P

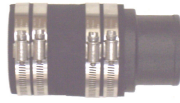

20 0085P



20 0086P



20 0087P



20 0088P



20 0089P



20 0092P



20 0093P



MC 27 47487

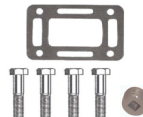

20 0082P



CHVA 1 84P



1 0104P

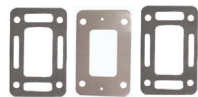

1 0106P

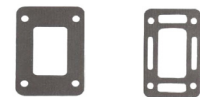

1 0105 1 0107



CHVA 47 0000

CHVA-1-84	Water cooled center discharge manifold to fit the big block GM engine (3/4" N.P.T. cooling hose connections). All years.
20-0082	Water cooled center discharge riser (3/4" N.P.T. cooling hose connection). Standard for use with 3" I.D. exhaust hose.
20-0100	Water cooled center discharge riser (3/4" N.P.T. cooling hose connection). Standard for use with 4" I.D. exhaust hose.
1-0104P	Adaptor package for fresh water cooled manifold (includes gaskets and block off plate).
1-0105	Center riser manifold-to-riser gasket for fresh water cooling.
1-0106P	Adaptor package for raw water cooling. Used in pre-heating applications (includes gaskets and block off plate with vent hole).
1-0107	Center riser manifold-to-riser gasket (raw water cooling).
20-0082P	Riser mounting package for both 20-0082 and 20-0100.
20-0082SS-P	Stainless steel mounting package (with brass plugs) for both 20-0082 and 20-0100. Not pictured.
20-0084P	Straight exhaust adaptor (includes adaptor, hose and clamps). For use with 3 1/2" I.D. exhaust hose.
20-0085P	Straight exhaust adaptor (includes adaptor, hose and clamps). For use with 2 1/2" I.D. exhaust hose.
20-0086P	90 degree exhaust elbow adaptor for I/O applications (includes adaptor, hose and clamps). For use with 2 1/2" I.D. exhaust hose.
20-0087P	90 degree exhaust elbow adaptor (includes adaptor, hose and clamps). For use with 3" I.D. exhaust hose.
20-0088P	30 degree exhaust elbow adaptor (includes adaptor, hose and clamps). For use with 2 1/2" I.D. exhaust hose.
20-0089P	30 degree exhaust elbow adaptor (includes adaptor, hose and clamps). For use with 3" I.D. exhaust hose.
20-0092P	45 degree exhaust elbow adaptor (includes adaptor, hose and clamps). For use with 3" I.D. exhaust hose.
20-0093P	90 degree exhaust elbow adaptor (includes adaptor, hose and clamps). For use with 3 1/2" or 4" I.D. exhaust hose.
20-0097	3" spacer block (complete with mounting hardware, gasket and 3/4" pipe plug). Capable of stacking.
CHVA-1-84P	Manifold mounting package (includes bolts and pipe plugs).
CHVA-1-84SS-P	Stainless steel manifold mounting package (includes stainless bolts and brass plugs). Not pictured.
CHVA-47-0000	Manifold to cylinder head gasket.
MC-27-47487	Alternator bracket.

Note:

Manifold includes all plugs, gaskets and mounting hardware to head. Risers include plugs, gasket and mounting hardware to mount to manifold.

BARR
MARINE BY EDM

8-1/2"

9-1/2"

46

7-5/8"

"A"

2-9/16"

6-1/8"

6-1/8"

"C"

Part Number

30°

MerCruiser V8-325, 330, 350, 370 and 400

Inboard and Stern-Drive Units

LOG STYLE DIRECT REPLACEMENT



MC 1 47735



MC 1 47736

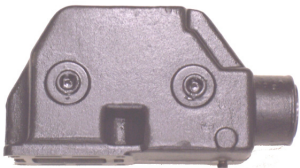

MC 20 72963

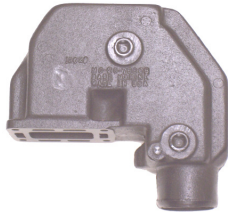

MC 20 76668



MC 20 61811A4



MC 29 78985



MC 29 47441



MC 27 47487



MC47 488KIT



MC 20 76668P



MC 20 72963P

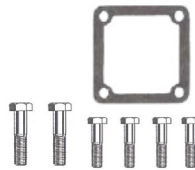

1 60252P

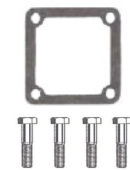

1 73813P



1 73813

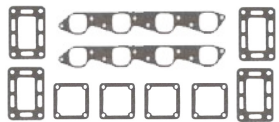

MC47 27 46820A1



MC47 27 48042



MC47 27 48043



MC47 27 46820

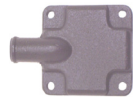

1 60252

MC-1-47735	Direct replacement water cooled exhaust manifold (port side). Replaces MerCruiser part # B-47735A1.
MC-1-47736	Direct replacement water cooled exhaust manifold (starboard side). Replaces MerCruiser part # B-47736A1.
MC-20-72963	Direct replacement exhaust elbow riser. Replaces MerCruiser part # B-72963A1 (inboard applications).
MC-20-76668	Direct replacement exhaust elbow riser. Replaces MerCruiser part # B-76668A3, B-72964A1 and B-47877A4 (I/O applications).
1-60252	Direct replacement exhaust manifold end cap/connector. Replaces MerCruiser part # B-60252.
1-60252P	Front end plate mounting package.
1-73813	Direct replacement manifold end cap (rear). Supercedes part # 1-54870.
1-73813P	Rear end cap mounting package.
MC-20-72963P	Exhaust riser elbow mounting package.
MC-20-76668P	Exhaust riser elbow mounting package.
MC-20-61811A4	Manifold to riser 3" spacers (sold in pairs). Includes all mounting hardware, gaskets and drain plugs.
MC-27-47487	Alternator bracket.
MC-29-47441	Upper thermostat housing.
MC-29-78985	Lower thermostat housing.
MC47-488KIT	Thermostat kit (includes gasket and thermostat).
MC47-27-46820	Direct replacement exhaust manifold to head gasket.
MC47-27-46820A1	Exhaust manifold gasket set.
MC47-27-48042	Direct replacement exhaust elbow to manifold gasket.
MC47-27-48043	Direct replacement exhaust manifold end cap/connector gasket (will fit both ends).

Note:

Manifold includes all plugs, gaskets and mounting hardware to head. Riser includes plugs, gasket and mounting hardware to mount to manifold.

BARR
MARINE BY EDM

MerCruiser V8 Models 330, 340 and 454 Magnum

Inboard and Stern-Drive Units CENTER RISER DIRECT REPLACEMENT



MC 1 89011

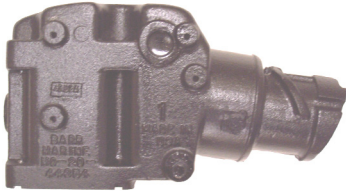

MC 20 44354

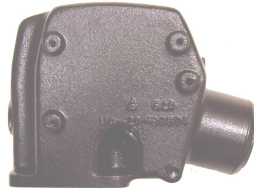

MC 20 98504

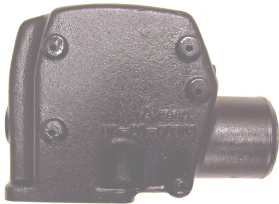

MC 20 98502



MC 20 93320A3



MC 20 93322A3



MC 29 47442



MC 29 90736



MC 27 47487



MC 20 87918



MC 20 99208



MC 50 806926



MC 50 87238

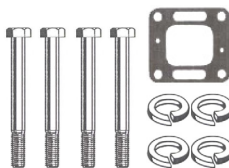

MC 20 44354P

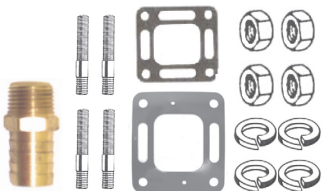

MC 20 98504P



MC 47 27 41811



MC 47 27 87105



MC 47 27 41813



MC 47 27 46820

MC-1-89011	Direct replacement water cooled exhaust manifold. Replaces MerCruiser part # 89011A8.
MC-20-44354	Direct replacement water cooled center discharge riser. Replaces MerCruiser part # B-44354A3. Accepts 4" I.D. exhaust hose (8 degree angle).
MC-20-98502	Direct replacement water cooled center discharge riser. Replaces MerCruiser part #98502A2. Accepts 3" I.D. exhaust hose (0 degree angle).
MC-20-98504	Direct replacement water cooled center discharge riser. Replaces MerCruiser part #98504A3. Accepts 3" I.D. exhaust hose (15 degree angle).
MC-20-44354P	Mounting package for MC-20-44354 riser.
MC-20-87918	Direct replacement stainless steel block off plate for use with MerCruiser riser #'s 98502, 98504 and 44354. Requires (2) gaskets part # MC47-27-41813.
MC-20-93320A3	Manifold to riser 3" spacer blocks (pair) with fastener and gasket package.
MC-20-93322A3	Manifold to riser 6" spacer blocks (pair) with fastener and gasket package.
MC-20-98504P	Mounting package for MC-20-98504 riser (includes gaskets, drain plug, pipe plug, stainless steel restrictor plate and fasteners).
MC-20-99208	Direct replacement stainless steel restrictor plate for use with MerCruiser riser #'s 98502, 98504 and 44354. Requires (2) gaskets part # MC47-27-41813.
MC-27-47487	Alternator bracket.
MC-29-47442	Upper thermostat housing.
MC-29-90736	Lower thermostat housing.
MC47-27-41811	Direct replacement restrictor gasket. Replaces MerCruiser part # 27-41811. To be used with MC-20-87918 ((2) required per plate used).
MC47-27-41813	Direct replacement restrictor gasket. Replaces MerCruiser part # 27-41813.
MC47-27-46820	Direct replacement exhaust manifold to head gasket.
MC47-27-87105	Direct replacement exhaust elbow gasket. Replaces MerCruiser part # 27-87105.
MC-50-87238	Exhaust manifold drain cock.
MC-50-806926	Replacement 3/4" N.P.T. X 1" hose fitting (90 degree)/brass drain cock.

Note:
 Manifold includes all plugs, gaskets and mounting hardware to head. Risers include plugs, gasket and mounting hardware to mount to manifold.

8-1/2"

9-1/2"

48

7-5/8"

"A"

2-9/16"

6-1/8"

6-1/8"

"C"

Part Number

30°

MerCruiser V8 (Ford)-302 and 351 C.I.D.

ALL MODELS CENTER RISER GENERIC

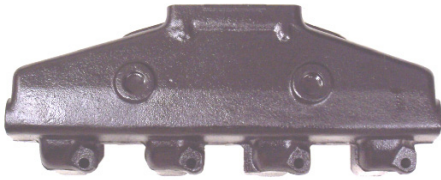

FM 1 83

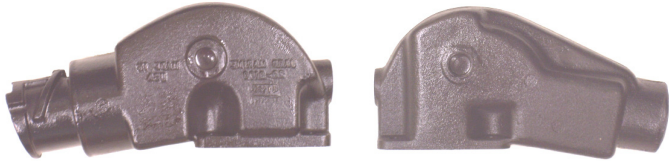

20 0100

20 0082



20 0097

20 0087P

20 0089P



20 0092P

20 0093P

MC 45 0000



MC 6 0001P

MC 6 0000P



20 0082P

FM 1 83P

1 0105

1 0107

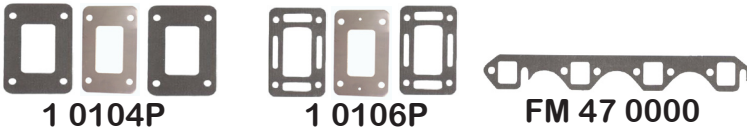

1 0104P

1 0106P

FM 47 0000

Note:

Manifold includes all plugs, gaskets and mounting hardware to head. Risers include plugs, gasket and mounting hardware to mount to manifold.

FM-1-83	Water cooled center discharge manifold to fit the small block Ford engine (3/4" N.P.T. cooling hose connections). All years.
20-0082	Water cooled center discharge riser (3/4" N.P.T. cooling hose connection). Standard for use with 3" I.D. exhaust hose.
20-0100	Water cooled center discharge riser (3/4" N.P.T. cooling hose connection). Standard for use with 4" I.D. exhaust hose.
1-0104P	Adaptor package for fresh water cooled manifold (includes gaskets and block off plate).
1-0105	Center riser manifold-to-riser gasket for fresh water cooling.
1-0106P	Adaptor package for raw water cooling. Used in pre-heating applications (includes gaskets and block off plate with vent hole).
1-0107	Center riser manifold-to-riser gasket (raw water cooling).
20-0082P	Riser mounting package for both 20-0082 and 20-0100.
20-0082SS-P	Stainless steel mounting package (with brass plugs) for both 20-0082 and 20-0100. Not pictured.
20-0087P	90 degree exhaust elbow adaptor (includes adaptor, hose and clamps). For use with 3" I.D. exhaust hose.
20-0088P	30 degree exhaust elbow adaptor (includes adaptor, hose and clamps). For use with 2 1/2" I.D. exhaust hose.
20-0089P	30 degree exhaust elbow adaptor (includes adaptor, hose and clamps). For use with 3" I.D. exhaust hose.
20-0092P	45 degree exhaust elbow adaptor (includes adaptor, hose and clamps). For use with 3" I.D. exhaust hose.
20-0093P	90 degree exhaust elbow adaptor (includes adaptor, hose and clamps). For use with 3 1/2" or 4" I.D. exhaust hose.
20-0097	3" spacer block (complete with mounting hardware, gasket and 3/4" pipe plug). Capable of stacking.
FM-1-83P	Manifold mounting package (includes bolts and pipe plugs).
FM-1-83SS-P	Stainless steel manifold mounting package (includes stainless bolts and brass plugs). Not pictured.
FM-47-0000	Manifold to cylinder head gasket.
MC-6-0000P	Exhaust manifold plumbing fittings package for models 188, 255, 233, 255, 302, 351 and 888.
MC-6-0001P	Exhaust manifold plumbing fittings package for model 215.
MC-45 0000	Fuel filter and solenoid universal mounting bracket.

MerCruiser V8 (Ford)-302 and 351 C.I.D.

Models 188, 215, 225, 233, 255 and 888 Inboard and I/O Units

LOG STYLE DIRECT REPLACEMENT

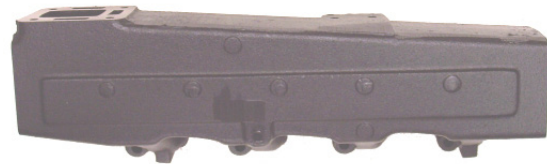

MC 1 65603



MC 1 65604

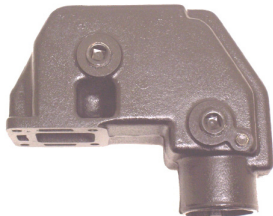

MC 20 60426

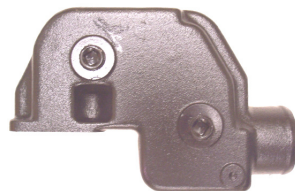

MC 20 76771

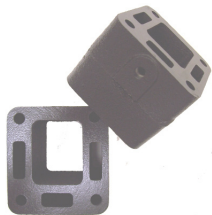

MC 20 61851A2

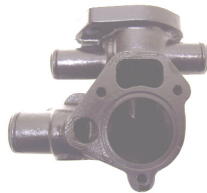

MC 29 63588



MC 29 62898



MC 20 60207



MC 20 55730



1 73813



1 60252



1 60252P



1 73813P

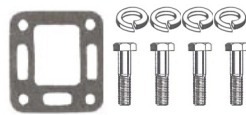

MC 20 60426P



MC47 27 48043



MC 1 6560P



MC47 27 99777

BARR
MARINE BY EDM



MC47 27 73866

MC-1-65603	Direct replacement water cooled exhaust manifold (starboard side). Replaces MerCruiser part # B-65603A4 and B-54099A5.
MC-1-65604	Direct replacement water cooled exhaust manifold (port side). Replaces MerCruiser part # B-65604A4 and B-54100A5.
MC-20-60426	Direct replacement exhaust elbow riser (utilizes a stainless steel sleeve at the water/air mixing area). Replaces MerCruiser part #B-60426A1 (I/O applications).
MC-20-76351	Direct replacement exhaust elbow riser. Replaces MerCruiser part # B-76351A1(I/O applications). Not pictured.
MC-20-76771	Direct replacement exhaust elbow riser. Replaces MerCruiser part # B-76771A3 (inboard applications).
I-60252	Direct replacement exhaust manifold end cap/connector. Replaces MerCruiser part # B-60252.
I-60252P	Front end plate mounting package.
I-73813	Direct replacement manifold end cap (rear). Supersedes part # 1-54870.
I-73813P	Rear end cap mounting package.
MC-1-6560P	Manifold mounting package.
MC-20-55730	Stainless steel fresh water cooling block off plate for use with MerCruiser riser #'s 60426, 76351 and 76771. Requires (2) gaskets part # MC47-27-99777.
MC-20-60207	Stainless steel block off plate (with vent hole) for use with MerCruiser riser #'s 60426, 76351 and 76771. Requires (2) gaskets part # MC47-27-99777. Used in pre-heating plumbing systems.
MC-20-60426P	Exhaust riser elbow mounting package. For use with both MC-20-60426 and MC-20-76351 risers.
MC-20-61851A2	Manifold to riser 3" spacers (sold in pairs). Includes all mounting hardware, gaskets and drain plugs.
MC-29-62898	Upper thermostat housing.
MC-29-63588	Lower thermostat housing.
MC47-27-54566A1	Manifold gasket set.
MC47-27-48043	Direct replacement exhaust manifold end cap/connector gasket (will fit both ends).
MC47-27-73866	Direct replacement exhaust manifold to head gasket.
MC47-27-99777	Direct replacement exhaust elbow to manifold gasket. Supersedes MerCruiser part # 27-52076.

Note:
Manifold includes all plugs, gaskets and mounting hardware to head. Riser includes plugs, gasket and mounting hardware to mount to manifold.

8-1/2"

9-1/2"

50

7-5/8"

"A"

2-9/16"

6-1/8"

6-1/8"

Discharge
Part Number
20-0000

Internal
Water
Discharge

"C"

Part Number

MerCruiser Exhaust Risers and Accessories

DIRECT REPLACEMENT



MC 20 12076

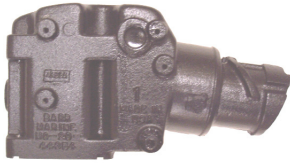

MC 20 44354



MC 20 55538



MC 20 60426



MC 20 864591

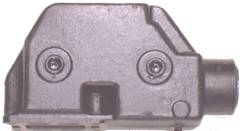

MC 20 72963



MC 20 76325



MC 20 87918

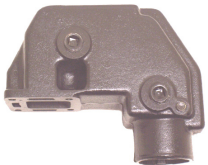

MC 20 76351



MC 20 76668



MC 20 99208

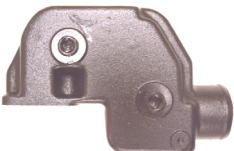

MC 20 76771



MC 20 90880



MC 20 60207



MC 20 98502

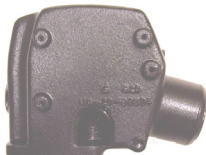

MC 20 98504



MC 20 55730

Note:
Risers include plugs, gasket and mounting hardware to mount to manifold.

MC-20-12076	Direct replacement exhaust riser. Replaces MerCruiser part # 12076A2.
MC-20-44354	Direct replacement water cooled center discharge riser. Replaces MerCruiser part # B-44354A3. Accepts 4" I.D. exhaust hose (8 degree angle).
MC-20-55538	Direct replacement exhaust elbow/riser. Replaces MerCruiser part # B-39920 and # B-55538A2.
MC-20-60426	Direct replacement exhaust elbow riser (utilizes a stainless steel sleeve at the water/air mixing area). Replaces MerCruiser part #B-60426A1.
MC-20-72963	Direct replacement exhaust elbow riser. Replaces MerCruiser part # B-72963A1 (inboard applications).
MC-20-76325	Direct replacement exhaust riser. Replaces MerCruiser part # 76325A2.
MC-20-76351	Direct replacement exhaust elbow riser. Replaces MerCruiser part # B-76351A1.
MC-20-76668	Direct replacement exhaust elbow riser. Replaces MerCruiser part # B-76668A3, B-72964A1 and B-47877A4 (I/O applications).
MC-20-76771	Direct replacement exhaust elbow riser. Replaces MerCruiser part # B-76771A3 (inboard applications).
MC-20-864591	Direct replacement exhaust riser/elbow. Replaces MerCruiser part # 864591T02. Riser will replace the equivalent part number used on 4.3L Models as well.
MC-20-90880	Direct replacement (cast iron) exhaust riser/expansion tank. Replaces MerCruiser part # 90880A2.
MC-20-98502	Direct replacement water cooled center discharge riser. Replaces MerCruiser part #98502A2. Accepts 3" I.D. exhaust hose (0 degree angle).
MC-20-98504	Direct replacement water cooled center discharge riser. Replaces MerCruiser part #98504A3. Accepts 3" I.D. exhaust hose (15 degree angle).
MC-20-55730	Stainless steel fresh water cooling block off plate for use with MerCruiser riser #'s 60426, 76351 and 76771. Requires (2) gaskets part # MC47-27-99777.
MC-20-60207	Stainless steel block off plate (with vent hole) for use with MerCruiser riser #'s 60426, 76351 and 76771. Requires (2) gaskets part # MC47-27-99777. Used in pre-heating plumbing systems.
MC-20-87918	Direct replacement stainless steel block off plate for use with MerCruiser riser #'s 98502, 98504 and 44354.
MC-20-99208	Direct replacement stainless steel restrictor plate for use with MerCruiser riser #'s 98502, 98504 and 44354.

BARR
MARINE BY EDM

MerCruiser 3" and 6" Riser Kits

DIRECT REPLACEMENT



MC 20 61811A4

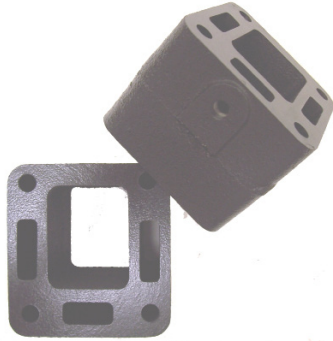

MC 20 61851A2



MC 20 61851A3

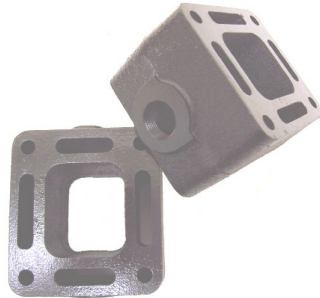

MC 20 93320A3

MC-20-61811A4	Manifold to riser 3" spacers (sold in pairs). Includes all mounting hardware, gaskets and drain plugs.
MC-20-61851A2	Manifold to riser 3" spacers (sold in pairs). Includes all mounting hardware, gaskets and drain plugs.
MC-20-61851A3	Manifold to riser 3" spacer (single block). Includes all mounting hardware, gaskets and drain plug.
MC-20-93320A3	Manifold to riser 3" spacer blocks (pair) with fastener and gasket package.
MC-20-93322A3	Manifold to riser 6" spacer blocks (pair) with fastener and gasket package.
MC-20-61811A4P	Mounting package for MC-20-61811A4 spacer block kit.
MC-20-61852A2P	Mounting package for MC-20-61851A2 spacer block kit.
MC-20-61811A3P	Mounting package for MC-20-61811A3 spacer block kit.
MC-20-93320A3P	Mounting package for MC-20-93320A3 spacer block kit.
MC-20-93322A3P	Mounting package for MC-20-93322A3 spacer block kit.

Note:
Each spacer block kit includes the spacer block (s) and the corresponding package to mount.

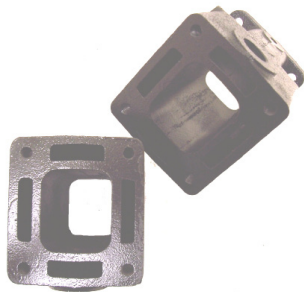

MC 20 93322A3

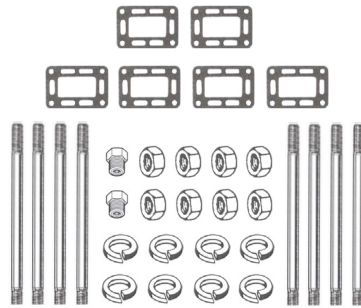

MC 20 61811A4P

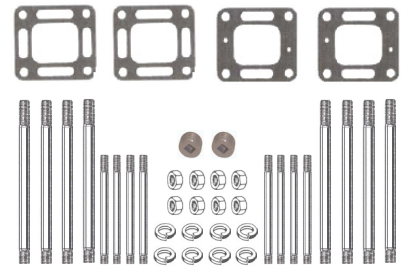

MC 20 93320A3P

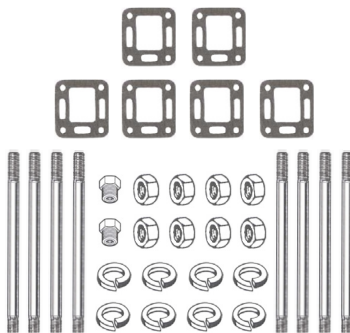

MC 20 61851A2P

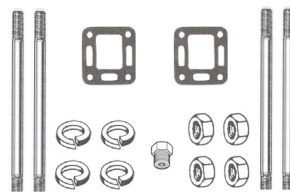

MC 20 61851A3P

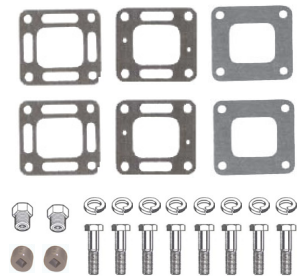

MC 20 93320A3P

BARR
MARINE BY EDM

8-1/2"

9-1/2"

7-5/8"

52

Part Number

30°

"A"

2-9/16"

6-1/8"

6-1/8"

Internal Water Discharge

Part Number 20-0000

Discharge

"C"

"A"

2"

MerCruiser Thermostat Housing Assemblies

Part#

MC-29-60372
 MC47-27-47590
 MC-29-47587
 MC47-27-33680
 MC-29-59078
 MC-29-47441
 MC47-27-48818
 MC-29-78984
 MC47-27-53045
 MC-29-59137
 MC-29-59498
 MC-29-62898
 MC47-27-60208
 MC-29-60783
 MC-29-63588
 MC47-27-54506
 MC-29-59137
 MC-29-47441
 MC47-27-41812
 MC-29-87290
 MC47-27-53045
 MC-29-59137
 MC-29-97429
 MC47-27-90556
 MC-29-87290
 MC47-27-53045
 MC-29-59137
 MC-29-47442
 MC47-27-48818
 MC-29-78985
 MC-29-79468
 MC47-27-53045
 MC-29-59137
 MC-29-47442
 MC-29-97428
 MC47-27-90556
 MC-29-90736
 MC47-27-53405
 MC-29-59137
 MC-29-47442
 MC47-27-48818
 MC-29-47479
 MC-29-49966
 MC-29-52852
 MC-29-78985
 MC47-27-53045
 MC-29-59137

Detailed Description

Upper Thermostat Housing - Models 120, 140, 120R/140R, 160, 165 and 200
 Upper Thermostat Housing Gasket - Models 120, 140, 120R/140R, 160, 165 and 200
 Lower Thermostat Housing - Models 120, 140, 120R/140R, 160, 165 and 200
 Lower Thermostat Housing Gasket - Models 120, 140, 120R/140R, 160, 165 and 200
 Thermostat - Models 120, 140, 120R/140R, 160, 165 and 200
 Upper Thermostat Housing - Models 225 (GM), 260, 228, 898/198
 Upper Thermostat Housing Gasket - Models 225 (GM), 260, 228, 898/198
 Lower Thermostat Housing Gasket - Models 225 (GM), 260, 228, 898/198
 Lower Thermostat Housing Gasket - Models 225 (GM), 260, 228, 898/198
 Thermostat - Models 225 (GM), 260, 228, 898/198
 Upper Thermostat Housing - Models 888, 225 (Ford), 233 (Ford) and 255 (Ford)
 Upper Thermostat Housing - Models 888, 225 (Ford), 233 (Ford) and 255 (Ford)
 Upper Thermostat Housing Gasket - Models 888, 225 (Ford), 233 (Ford) and 255 (Ford)
 Lower Thermostat Housing - Models 888, 225 (Ford), 233 (Ford) and 255 (Ford)
 Lower Thermostat Housing - Models 888, 225 (Ford), 233 (Ford) and 255 (Ford)
 Lower Thermostat Housing Gasket - Models 888, 225 (Ford), 233 (Ford) and 255 (Ford)
 Lower Thermostat Housing Gasket - Models 888, 225 (Ford), 233 (Ford) and 255 (Ford)
 Thermostat - Models 888, 225 (Ford), 233 (Ford) and 255 (Ford)
 Upper Thermostat Housing - Models 185R and 898R/228R/260R
 Upper Thermostat Housing Gasket - Models 185R and 898R/228R/260R
 Lower Thermostat Housing - Models 185R and 898R/228R/260R
 Lower Thermostat Housing Gasket - Models 185R and 898R/228R/260R
 Lower Thermostat Housing Gasket - Models 185R and 898R/228R/260R
 Thermostat - Models 185R and 898R/228R/260R
 Upper Thermostat Housing - Models 230 (Inboard) and 260 (Inboard)
 Upper Thermostat Housing Gasket - Models 230 (Inboard) and 260 (Inboard)
 Lower Thermostat Housing - Models 230 (Inboard) and 260 (Inboard)
 Lower Thermostat Housing Gasket - Models 230 (Inboard) and 260 (Inboard)
 Thermostat - Models 230 (Inboard) and 260 (Inboard)
 Upper Thermostat Housing - Models 330 (GM)
 Upper Thermostat Housing Gasket - Models 330 (GM)
 Lower Thermostat Housing - Models 330 (GM)
 Lower Thermostat Housing - Models 330 (GM)
 Lower Thermostat Housing Gasket - Models 330 (GM)
 Lower Thermostat Housing Gasket - Models 330 (GM)
 Thermostat - Models 330 (GM)
 Upper Thermostat Housing - Models 330 (Inboard) and 340 (Inboard)
 Upper Thermostat Housing - Models 330 (Inboard) and 340 (Inboard)
 Upper Thermostat Housing Gasket- Models 330 (Inboard) and 340 (Inboard)
 Lower Thermostat Housing - Models 330 (Inboard) and 340 (Inboard)
 Lower Thermostat Housing Gasket- Models 330 (Inboard) and 340 (Inboard)
 Lower Thermostat - Models 330 (Inboard) and 340 (Inboard)
 Upper Thermostat Housing - Models 325, 350
 Upper Thermostat Housing Gasket - Models 325, 350
 Lower Thermostat Housing - Models 325, 350
 Lower Thermostat Housing - Models 325, 350
 Lower Thermostat Housing - Models 325, 350
 Lower Thermostat Housing - Models 325, 350
 Lower Thermostat Housing Gasket - Models 325, 350
 Lower Thermostat Housing Gasket - Models 325, 350
 Thermostat - Models 325, 350



MC 29 47441



MC 29 47587



MC 29 60372



MC 29 62898



MC 29 63588



MC 29 78984



MC 29 78985



MC 29 87290

BARR
MARINE BY EDM

MerCruiser Thermostat Kits



MC47 475KIT

Contents:
 MC47-27-47590 Gasket
 MC-29-59078 Thermostat



MC47 488KIT

Contents:
 MC47-27-48818 Gasket
 MC-29-59137 Thermostat



MC47 602KIT

Contents:
 MC47-27-60208 Gasket
 MC-29-59137 Thermostat

Part #	Detailed Description
MC47-475KIT	Thermostat Kit 475 - Engine model 120 Beginning S/N 2324347 - Ending S/N 337734. Note MC47 475 Kit Contents: MC47-27-47590 Gasket and MC-29-59078 Thermostat
MC47-475KIT	Thermostat Kit 475 - Engine model 120 Beginning S/N 3377341 - Ending S/N Up. Note MC47 475 Kit Contents: MC47-27-47590 Gasket and MC-29-59078 Thermostat
MC47-475KIT	Thermostat Kit 475 - Engine model 140 Beginning S/N 2508261 - Ending S/N Up. Note MC47 475 Kit Contents: MC47-27-47590 Gasket and MC-29-59078 Thermostat
MC47-475KIT	Thermostat Kit 475 - Engine model 165 Beginning S/N 3377341 - Ending S/N Up. Note MC47 475 Kit Contents: MC47-27-47590 Gasket and MC-29-59078 Thermostat
MC47-488KIT	Thermostat Kit 488 - Engine model 198 Beginning S/N 4776402 - Ending S/N 6218461. Note MC47 488 Kit Contents: MC47-27-48818 Gasket and MC-29-59137 Thermostat
MC47-602KIT	Thermostat Kit 602 - Engine model 215 Beginning S/N 3040411 - Ending S/N Up. Note MC47 602 Kit Contents: MC47-27-60208 Gasket and MC-29-59137 Thermostat
MC47-488KIT	Thermostat Kit 488 - Engine model 225 Beginning S/N 2278647 - Ending S/N 2694014. Note MC47 488 Kit Contents: MC47-27-48818 Gasket and MC-29-59137 Thermostat
MC47-602KIT	Thermostat Kit 602 - Engine model 225 Beginning S/N 3385721 - Ending S/N Up. Note MC47 602 Kit Contents: MC47-27-60208 Gasket and MC-29-59137 Thermostat
MC47-488KIT	Thermostat Kit 488 - Engine model 228 Beginning S/N 4765100 - Ending S/N 2618461. Note MC47 488 Kit Contents: MC47-27-48818 Gasket and MC-29-59137 Thermostat
MC47-488KIT	Thermostat Kit 488 - Engine model 230 Beginning S/N 6040716 - Ending S/N Up. Note MC47 488 Kit Contents: MC47-27-48818 Gasket and MC-29-59137 Thermostat
MC47-602KIT	Thermostat Kit 602 - Engine model 233 Beginning S/N 4173000 - Ending S/N Up. Note MC47 602 Kit Contents: MC47-27-60208 Gasket and MC-29-59137 Thermostat
MC47-488KIT	Thermostat Kit 488 - Engine model 250 Beginning S/N 2314301 - Ending S/N 2639854. Note MC47 488 Kit Contents: MC47-27-48818 Gasket and MC-29-59137 Thermostat
MC47-488KIT	Thermostat Kit 488 - Engine model 250 Beginning S/N 4768000 - Ending S/N 4908849. Note MC47 488 Kit Contents: MC47-27-48818 Gasket and MC-29-59137 Thermostat
MC47-602KIT	Thermostat Kit 602 - Engine model 255 Beginning S/N 3258728 - Ending S/N Up. Note MC47 602 Kit Contents: MC47-27-60208 Gasket and MC-29-59137 Thermostat
MC47-488KIT	Thermostat Kit 488 - Engine model 255 Beginning S/N 4175500 - Ending S/N Up. Note MC47 488 Kit Contents: MC47-27-48818 Gasket and MC-29-59137 Thermostat
MC47-488KIT	Thermostat Kit 488 - Engine model 260 Beginning S/N 5907058 - Ending S/N Up. Note MC47 488 Kit Contents: MC47-27-48818 Gasket and MC-29-59137 Thermostat
MC47-488KIT	Thermostat Kit 488 - Engine model 270 Beginning S/N 2851074 - Ending S/N 3077735. Note MC47 488 Kit Contents: MC47-27-48818 Gasket and MC-29-59137 Thermostat
MC47-488KIT	Thermostat Kit 488 - Engine model 280 Beginning S/N 4176250 - Ending S/N Up. Note MC47 488 Kit Contents: MC47-27-48818 Gasket and MC-29-59137 Thermostat
MC47-488KIT	Thermostat Kit 488 - Engine model 325 Beginning S/N 2288747 - Ending S/N Up. Note MC47 488 Kit Contents: MC47-27-48818 Gasket and MC-29-59137 Thermostat
MC47-488KIT	Thermostat Kit 488 - Engine model 330 Beginning S/N 4623115 - Ending S/N Up. Note MC47 488 Kit Contents: MC47-27-48818 Gasket and MC-29-59137 Thermostat
MC47-488KIT	Thermostat Kit 488 - Engine model 340 Beginning S/N 5889914 - Ending S/N Up. Note MC47 488 Kit Contents: MC47-27-48818 Gasket and MC-29-59137 Thermostat
MC47-488KIT	Thermostat Kit 488 - Engine model 350 Beginning S/N 3780450 - Ending S/N Up. Note MC47 488 Kit Contents: MC47-27-48818 Gasket and MC-29-59137 Thermostat
MC47-488KIT	Thermostat Kit 488 - Engine model 370 Beginning S/N 4179554 - Ending S/N Up. Note MC47 488 Kit Contents: MC47-27-48818 Gasket and MC-29-59137 Thermostat
MC47-488KIT	Thermostat Kit 488 - Engine model 390 Beginning S/N 2781129 - Ending S/N 2825059. Note MC47 488 Kit Contents: MC47-27-48818 Gasket and MC-29-59137 Thermostat
MC47-602KIT	Thermostat Kit 602 - Engine model 888 Beginning S/N 3108723 - Ending S/N Up. Note MC47 602 Kit Contents: MC47-27-60208 Gasket and MC-29-59137 Thermostat
MC47-488KIT	Thermostat Kit 488 - Engine model 898 Beginning S/N 4762210 - Ending S/N 6218461. Note MC47 488 Kit Contents: MC47-27-48818 Gasket and MC-29-59137 Thermostat

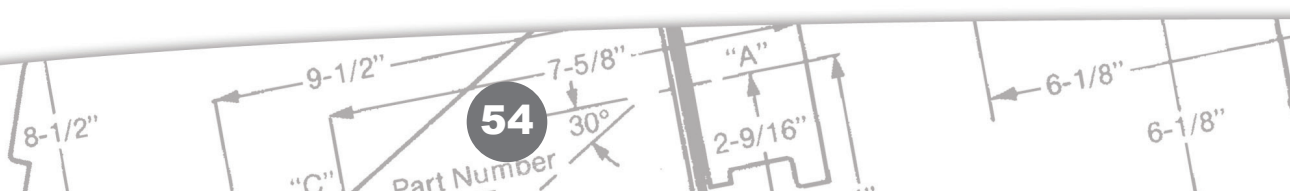

OMC 4-Cylinder 153 C.I.D. 120 H.P. 2.5 Liter

Model 120 Engine

LOG STYLE DIRECT REPLACEMENT



OMC 1 981462



OMC 1 982657



OMC 20 980536



OMC 20 910380



OMC 20 909368



OMC 20 907765



OMC 20 908014



1-907885



1-910280

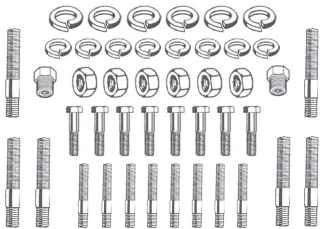

OMC 1 98146/982



OMC 20 910380P

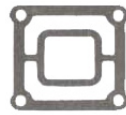

OMC47 311121



OMC47 908013

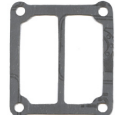

OMC47 907761



OMC47 907764

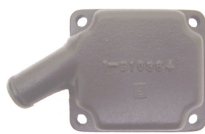

1-910384



OMC47 311068



1-380446

OMC-1-981462	Direct replacement water cooled exhaust manifold. Replaces OMC part #'s 979729 and 980459.
OMC-1-982657	Direct replacement water cooled exhaust manifold. Manifold has the heat source in the exhaust port for automatic choke.
OMC-20-909368	Direct replacement high rise to adaptor elbow for use with OMC-20-980536.
OMC-20-910380	Direct replacement exhaust elbow. Replaces OMC riser part #'s 980188 and 910380.
OMC-20-980536	Direct replacement exhaust riser. Replaces OMC riser part #'s 979730 and 980536.
1-380446	Heat exchanger assembly.
1-907885	Direct replacement rear end cap. Replaces OMC part # 907885.
1-910280	Direct replacement front end cap. Replaces OMC part # 910280 and 311550 (choke).
1-910384	Direct replacement front end cap. Replaces OMC part # 910384.
OMC-1-98146/982	Manifold mounting package.
OMC-20-907765	Direct replacement exhaust elbow to hose adaptor.
OMC-20-908014	Exhaust manifold to riser adaptor for use with OMC riser part #'s 980188 and 910380.
OMC-20-910380P	Exhaust riser mounting package.
OMC47-311068	Exhaust manifold to cylinder head gasket.
OMC47-311121	Exhaust manifold to elbow and end cap gasket.
OMC47-907761	Manifold end cap gasket.
OMC47-907764	Exhaust elbow to hose adaptor gasket.
OMC47-908013	Adaptor plate (OMC-20-908014) to riser (OMC-20-910380) gasket.

Note:
 Manifold includes all plugs, gaskets and mounting hardware to head. Risers include plugs, gasket and mounting hardware to mount to manifold.

BARR
 MARINE BY EDM

OMC 4-Cylinder 181 C.I.D. 140 H.P. 3.0 Liter

Part Number
20-0000

Model 140 Engine

LOG STYLE DIRECT REPLACEMENT

Internal
Water
Discharge

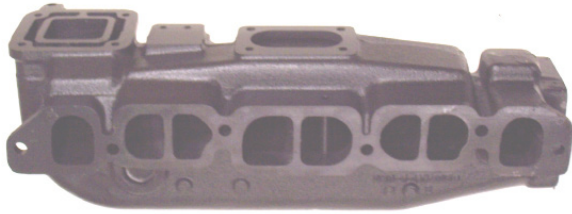

OMC 1 984054



OMC 20 910380



1-910384

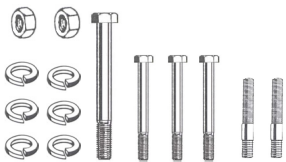

OMC 1 984054P



OMC 20 910380P



OMC47 311121



OMC47 908013



OMC47 908079

OMC-1-984054	Direct replacement exhaust manifold. Replaces OMC part #'s 998083, 980460, 980957 and 982490.
OMC-20-910380	Direct replacement exhaust elbow. Replaces OMC riser part #'s 980188 and 910380.
1-910384	Direct replacement front end cap. Replaces OMC part # 910384.
OMC-1-984054P	Exhaust manifold mounting package.
OMC-20-910380P	Exhaust riser mounting package.
OMC47-311121	Exhaust manifold to elbow and end cap gasket.
OMC47-908013	Adaptor plate (OMC-20-908014) to riser (OMC-20-910380) gasket.
OMC47-908079	Exhaust manifold to cylinder head gasket.

Note:

Manifold includes all plugs, gaskets and mounting hardware to head. Risers include plugs, gasket and mounting hardware to mount to manifold.

BARR
MARINE BY EDM

OMC V6-155 H.P. All Years

LOG STYLE GENERIC

Port side part # BV6 1 75L.



BV6 1 75R



20 0031

BV6-1-75L	Water cooled end discharge port manifold to fit the Buick V6 engine (1/2" N.P.T. cooling connections). All years.
BV6-1-75R	Water cooled end discharge starboard manifold to fit the Buick V6 engine (1/2" N.P.T. cooling connections). All years.
20-0031	Swivel-type 90 degree exhaust elbow connector with internal water discharge. Accepts 2 1/2" to 3" I.D. exhaust hose. Requires (1) mounting hardware kit #20-0002P per elbow.
OMC-1-0092	Front end plate with choke stove heat exchanger (starboard side only).
OMC-6-0000P	Plumbing fittings package (3/4" I.D. hose only).
OMC-29-0000	Upper thermostat housing. Replaces either OMC # 314810 or # 982201 (may also order under part #'s OMC-29-314810 or OMC-29-982201).
OMC-29-383307	160 degree thermostat.
OMC47-314809	Thermostat housing gasket.



OMC 1 0092

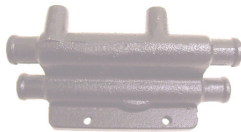

OMC 29 0000



OMC47 314809



OMC 29 383307

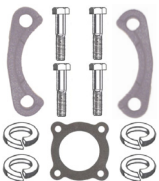

20 0002P



OMC 6 0000P

BARR
MARINE BY EDM

OMC V6-4.3L Cobra

All Models

CENTER RISER DIRECT REPLACEMENT



OMC 1 3857656

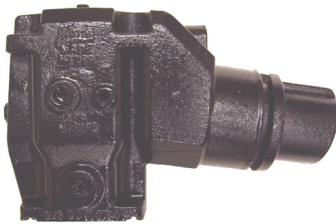

OMC 20 913784

OMC-1-3857656	Direct replacement exhaust manifold. Replaces Volvo part # 3857656.
OMC-20-913784	Direct replacement exhaust riser/elbow. Replaces OMC # 913784 and Volvo part # 3863061 (New Style).
OMC-20-913784P	Exhaust riser/elbow mounting package.
MC47-27 99757	Exhaust manifold to cylinder head gasket.
OMC47-913783	Direct replacement exhaust riser/elbow to manifold gasket.
50-512-017	Replacement 1/2" N.P.T. to 1" hose (straight)/brass hose fitting.

Note:

Manifold includes all plugs, gaskets and mounting hardware to head. Risers include plugs, gasket and mounting hardware to mount to manifold.

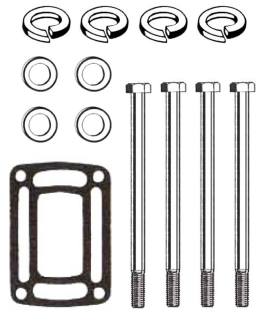

OMC 20 913784P

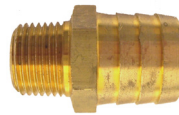

50 512 017
Sold Separately



MC47 27 99757



OMC47 913783

BARR
MARINE BY EDM

8-1/2"

9-1/2"

7-5/8"

58

Part Number

30°

"A"

2-9/16"

6-1/8"

6-1/8"

Internal Water Discharge

Part Number 20-0000

"C"

"A"

2"

OMC V8-283, 305, 307, and 350 C.I.D.

Models 210, 215, 225, 235 and 245 H.P. **LOG STYLE GENERIC**

Port side part # OF 1 60L.



OF 1 60R



20 0031



20 0055

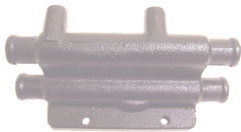

OMC 29 0000



OMC 29 383307



OMC 6 0000P



OMC47 909314

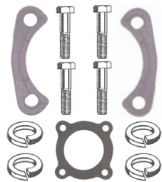

20 0002P

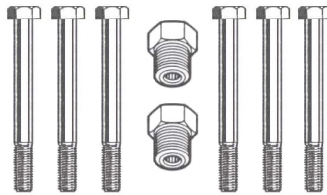

OF 1 60F P



OMC47 314809



OMC47 909515

OF-1-60L	Water cooled end discharge port manifold to fit the Small Block GM engine (1/2" N.P.T. cooling hose connections).
OF-1-60R	Water cooled end discharge starboard manifold to fit the Small Block GM engine (1/2" N.P.T. cooling hose connections).
20-0031	Swivel-type 90 degree exhaust elbow connector with internal water discharge. Accepts 2 1/2" to 3" I.D. exhaust hose. Requires (1) mounting hardware kit #20-0002P per elbow.
20-0055	Swivel-type 30 degree exhaust elbow connector; fully jacketed. Accepts 2 1/2" or 3" I.D. exhaust hose. Requires (1) mounting hardware kit #20-0002P per elbow.
20-0002P	Mounting hardware kit.
OF-1-60F-P	Manifold to cylinder head mounting package.
OMC-6-0000P	Plumbing fittings package (3/4" I.D. hose only).
OMC-29-0000	Upper thermostat housing. Replaces either OMC # 314810 or # 982201 (may also order under part #'s OMC-29-314810 or OMC-29-982201).
OMC-29-383307	160 degree thermostat.
OMC47-314809	Thermostat housing gasket.
OMC47-909314	Exhaust manifold to cylinder head gasket.
OMC47-909515	Adaptor housing gasket.

BARR
MARINE BY EDM

OMC V8-283, 305, 307 and 350 C.I.D.

Models 225 and 245 H.P.

LOG STYLE DIRECT REPLACEMENT

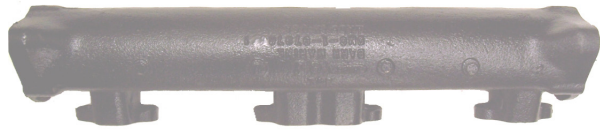

OMC 1 979760

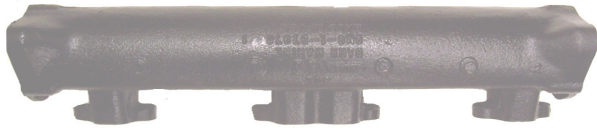

OMC 1 979761



OMC 20 981281



OMC 29 383307



OMC 29 0000



OMC47 909314



1 312148



1 312149



1 380985



1 31214P



OMC 20 981281P

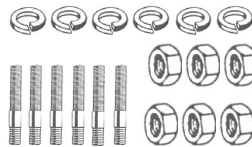

OMC 1 97975P



OMC47 907775



OMC47 311130



OMC 1 9797P



OMC47 314809

OMC-1-979760	Direct replacement exhaust manifold (port side). Replaces OMC part # 979760.
OMC-1-979761	Direct replacement exhaust manifold (starboard side). Replaces OMC part #979761.
OMC-20-981281	Direct replacement exhaust elbow. Replaces OMC part #'s 907776 and # 907777.
1-31214P	Exhaust manifold end cap/connector mounting package.
1-312148	Direct replacement exhaust manifold front end cap/connector (port side).
1-312149	Direct replacement exhaust manifold front end cap/connector (starboard side). End cap has extra hole drilled for choke stove.
1-380985	Choke stove heat exchanger (starboard side only). Uses 1-312149 end cap.
OMC-1-9797P	End cap and exhaust elbow stud package.
OMC-1-97975P	Exhaust manifold mounting package.
OMC-20-981281P	Exhaust elbow mounting package.
OMC-29-383307	160 degree thermostat.
OMC-29-0000	Upper thermostat housing. Replaces either OMC # 314810 or # 982201 (may also order under part #'s OMC-29-314810 or OMC-29-982201).
OMC47-311130	Direct replacement exhaust manifold end cap/connector gasket (not to be used between elbow and manifold).
OMC47-314809	Thermostat housing gasket.
OMC47-907775	Direct replacement exhaust elbow gasket.
OMC47-909314	Manifold to cylinder head gasket.

Note:

Manifold includes all plugs, gaskets and mounting hardware to head. Risers include plugs, gasket and mounting hardware to manifold.

BARR
MARINE BY EDM

OMC V8-283, 305, 307, and 350 C.I.D.

Models 185, 200, 225, 230, and 260 H.P.

LOG STYLE DIRECT REPLACEMENT



OMC 1 912441



OMC 1 912442



OMC 20 982680



OMC 29 0000



OMC 29 383307

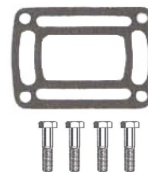

OMC 20 982680P



OMC47 909314



OMC47 909786



OMC47 314809

OMC-1-912441	Direct replacement exhaust manifold (starboard side). Replaces OMC part #'s 912441 and 909280.
OMC-1-912442	Direct replacement exhaust manifold (port side). Replaces OMC part #'s 912442 and 910144.
OMC-20-982680	Direct replacement exhaust riser/elbow. Replaces OMC part # 982680.
OMC-20-982680P	Exhaust riser/elbow mounting package.
OMC-29-0000	Upper thermostat housing. Replaces either OMC # 314810 or # 982201 (may also order under part #'s OMC-29-314810 or OMC-29-982201).
OMC-29-383307	160 degree thermostat.
OMC47-314809	Thermostat housing gasket.
OMC47-909314	Exhaust manifold to cylinder head gasket.
OMC47-909786	Direct replacement exhaust riser to manifold gasket.

Note:
 Manifold includes all plugs, gaskets and mounting hardware to head. Risers include plugs, gasket and mounting hardware to manifold.

OMC V8-283, 302, 305, 307, and 350 C.I.D.

ALL MODELS CENTER RISER GENERIC



CHV 1 83

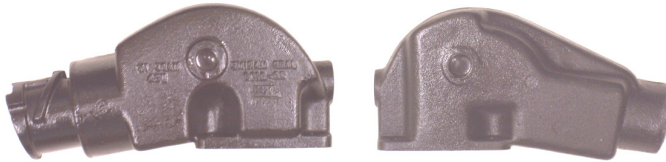

20 0100

20 0082



20 0097

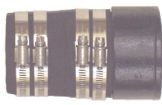

20 0084P

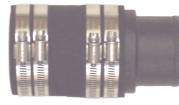

20 0085P



20 0086P



20 0087P



20 0088P



20 0092P



20 0093P



20 0089P



MC 6 0001P



OMC 20 0003

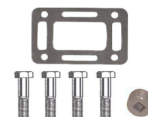

20 0082P



CHV 1 83P



1 0104P



1 0106P



CHV 47 0000

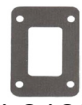

1 0105



1 0107

Note:
Manifold includes all plugs, gaskets and mounting hardware to head. Risers include plugs, gasket and mounting hardware to mount to manifold.

CHV-1-83	Water cooled center discharge manifold to fit the small block GM engine (3/4" N.P.T. cooling hose connections). All years.
20-0082	Water cooled center discharge riser (3/4" N.P.T. cooling hose connection). Standard for use with 3" I.D. exhaust hose.
20-0100	Water cooled center discharge riser (3/4" N.P.T. cooling hose connection). Standard for use with 4" I.D. exhaust hose.
1-0104P	Adaptor package for fresh water cooled manifold (includes gaskets and block off plate).
1-0105	Center riser manifold-to-riser gasket for fresh water cooling.
1-0106P	Adaptor package for raw water cooling. Used in pre-heating applications (includes gaskets and block off plate with vent hole).
1-0107	Center riser manifold-to-riser gasket (raw water cooling).
20-0082P	Riser mounting package for both 20-0082 and 20-0100.
20-0082SS-P	Stainless steel mounting package (with brass plugs) for both 20-0082 and 20-0100. Not pictured.
20-0084P	Straight exhaust adaptor (includes adaptor, hose and clamps). For use with 3 1/2" I.D. exhaust hose.
20-0085P	Straight exhaust adaptor (includes adaptor, hose and clamps). For use with 2 1/2" I.D. exhaust hose.
20-0086P	90 degree exhaust elbow adaptor for I/O applications (includes adaptor, hose and clamps). For use with 2 1/2" I.D. exhaust hose.
20-0087P	90 degree exhaust elbow adaptor (includes adaptor, hose and clamps). For use with 3" I.D. exhaust hose.
20-0088P	30 degree exhaust elbow adaptor (includes adaptor, hose and clamps). For use with 2 1/2" I.D. exhaust hose.
20-0089P	30 degree exhaust elbow adaptor (includes adaptor, hose and clamps). For use with 3" I.D. exhaust hose.
20-0092P	45 degree exhaust elbow adaptor (includes adaptor, hose and clamps). For use with 3" I.D. exhaust hose.
20-0093P	90 degree exhaust elbow adaptor (includes adaptor, hose and clamps). For use with 3 1/2" or 4" I.D. exhaust hose.
20-0097	3" spacer block (complete with mounting hardware, gasket and 3/4" pipe plug). Capable of stacking.
CHV-1-83P	Manifold mounting package (includes bolts and pipe plugs).
CHV-1-83SS-P	Stainless steel manifold mounting package (includes stainless bolts and brass plugs). Not pictured.
CHV-47-0000	Manifold to cylinder head gasket.
MC-6-0001P	Exhaust manifold plumbing fittings package for model 215.
OMC-20-0003	Hose bushing 3" to 3 1/2" (where applicable).

BARR
MARINE BY EDM

OMC V8-5.7L Cobra

All Models

CENTER RISER DIRECT REPLACEMENT



OMC 1 914035

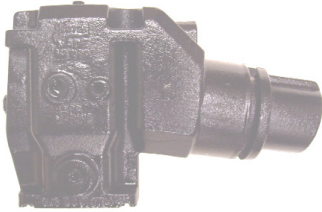

OMC 20 913784

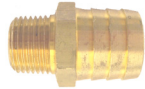

50 512 017
Sold Separately

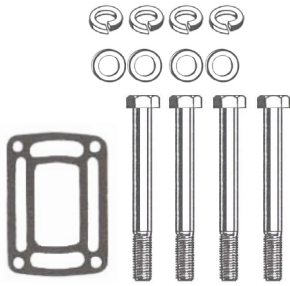

OMC 20 913784P



OMC 1 914035P



OMC47 909314

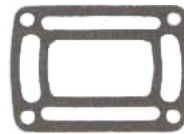

OMC47 913783

OMC-1-914035	Direct replacement exhaust manifold. Replaces OMC part # 914035 and Volvo part # 3857723 (New Style).
OMC-20-913784	Direct replacement exhaust riser/elbow. Replaces OMC # 913784 and Volvo part # 3863061 (New Style).
OMC-1-914035P	Exhaust manifold mounting package.
OMC-20-913784P	Exhaust riser/elbow mounting package.
OMC47-909314	Exhaust manifold to cylinder head gasket.
OMC47-913783	Direct replacement exhaust riser/elbow to manifold gasket.
50-512-017	Replacement 1/2" N.P.T. to 1" hose (straight)/brass hose fitting.

Note:

Manifold includes all plugs, gaskets and mounting hardware to head. Risers include plugs, gasket and mounting hardware to mount to manifold.

OMC (Ford) V8-302 and 351 C.I.D.

Models 170, 175, 190, and 235 H.P.

DIRECT REPLACEMENT



OMC 1 980959



OMC 20 980617

OMC-1-980959	Direct replacement exhaust manifold. Replaces OMC part # 980572 and # 980959.
OMC-20-980617	Direct replacement exhaust elbow. Replaces OMC part # 980617.
1-908719	Direct replacement exhaust manifold end cap/connector (front). Replaces OMC part # 908719.
OMC-1-980959P	Manifold to cylinder head mounting package.
OMC-20-980617P	Exhaust elbow mounting package.
OMC47-908717	Exhaust manifold to cylinder head gasket.
OMC47-908935	Direct replacement exhaust manifold end cap/connector gasket.

Note:
 Manifold includes all plugs, gaskets and mounting hardware to head. Risers include plugs, gasket and mounting hardware to mount to manifold.



1 908719

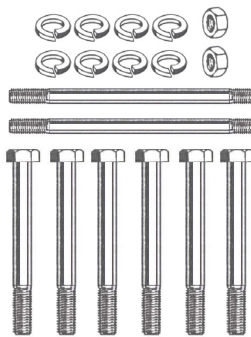

OMC 1 980959P



OMC 20 980617P



OMC47 908935



OMC47 908717

BARR
 MARINE BY EDM

8-1/2"

9-1/2"

64

Part Number

7-5/8"

30°

"A"

2-9/16"

6-1/8"

6-1/8"

Internal Water Discharge

Discharge

Part Number 20-0000

"C"

"A"

2"

OMC (Ford) V8-302 and 351 C.I.D.

ALL MODELS CENTER RISER GENERIC

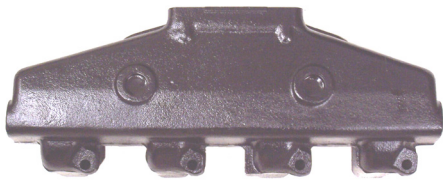

FM 1 83

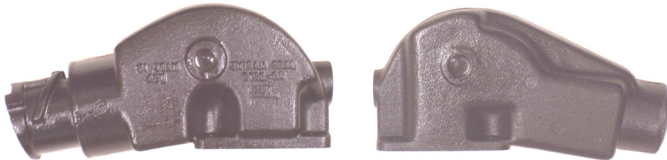

20 0100

20 0082

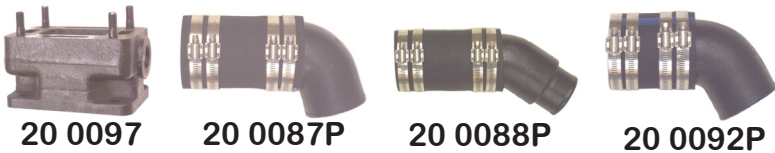

20 0097

20 0087P

20 0088P

20 0092P



20 0089P

20 0093P

OMC 6 0000P



MC 6 0001P

OMC 20 0003

OMC 20 0000P

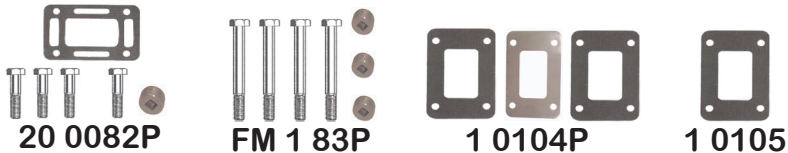

20 0082P

FM 1 83P

1 0104P

1 0105



FM 47 0000



1 0106P

1 0107

Note:
Manifold includes all plugs, gaskets and mounting hardware to head. Risers include plugs, gasket and mounting hardware to mount to manifold.

FM-1-83	Water cooled center discharge manifold to fit the small block Ford engine (3/4" N.P.T. cooling hose connections). All years.
20-0082	Water cooled center discharge riser (3/4" N.P.T. cooling hose connection). Standard for use with 3" I.D. exhaust hose.
20-0100	Water cooled center discharge riser (3/4" N.P.T. cooling hose connection). Standard for use with 4" I.D. exhaust hose.
1-0104P	Adaptor package for fresh water cooled manifold (includes gaskets and block off plate).
1-0105	Center riser manifold-to-riser gasket for fresh water cooling.
1-0106P	Adaptor package for raw water cooling. Used in pre-heating applications (includes gaskets and block off plate with vent hole).
1-0107	Center riser manifold-to-riser gasket (raw water cooling).
20-0082P	Riser mounting package for both 20-0082 and 20-0100.
20-0082SS-P	Stainless steel mounting package (with brass plugs) for both 20-0082 and 20-0100. Not pictured.
20-0087P	90 degree exhaust elbow adaptor (includes adaptor, hose and clamps). For use with 3" I.D. exhaust hose.
20-0088P	30 degree exhaust elbow adaptor (includes adaptor, hose and clamps). For use with 2 1/2" I.D. exhaust hose.
20-0089P	30 degree exhaust elbow adaptor (includes adaptor, hose and clamps). For use with 3" I.D. exhaust hose.
20-0092P	45 degree exhaust elbow adaptor (includes adaptor, hose and clamps). For use with 3" I.D. exhaust hose.
20-0093P	90 degree exhaust elbow adaptor (includes adaptor, hose and clamps). For use with 3 1/2" or 4" I.D. exhaust hose.
20-0097	3" spacer block (complete with mounting hardware, gasket and 3/4" pipe plug). Capable of stacking.
FM-1-83P	Manifold mounting package (includes bolts and pipe plugs).
FM-1-83SS-P	Stainless steel manifold mounting package (includes stainless bolts and brass plugs). Not pictured.
FM-47-0000	Manifold to cylinder head gasket.
MC-6-0001P	Exhaust manifold plumbing fittings package (1" I.D. hose only).
OMC-6-0000P	Exhaust manifold plumbing fittings package (3/4" hose only).
OMC-20-0000P	Hook up package; may be required for connection to stern drive units (exhaust hose and clamps not included).
OMC-20-0003	Hose bushing 3" to 3 1/2" (where applicable).

BARR
MARINE BY EDM

OMC V8-5.0L and 5.8L Cobra

All Models Carbureted

CENTER RISER DIRECT REPLACEMENT

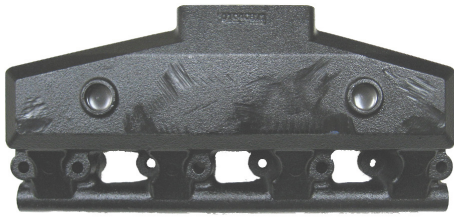

OMC 1 3852347

OMC-1-3852347	Direct replacement exhaust manifold. Replaces Volvo part # 3852347.
OMC-20-913784	Direct replacement exhaust riser/elbow. Replaces OMC # 913784 and Volvo part # 3863061 (New Style).
OMC-20-913784P	Exhaust riser/elbow mounting package.
FM 47 0000	Exhaust manifold to cylinder head gasket.
OMC47-913783	Direct replacement exhaust riser/elbow to manifold gasket.
50-512-017	Replacement 1/2" N.P.T. to 1" hose (straight)/brass hose fitting.

Note:
 Manifold includes all plugs, gaskets, hose fitting and mounting hardware to head. Risers include plugs, gasket and mouniting hardware to mount to manifold.

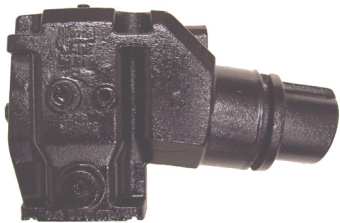

OMC 20 913784

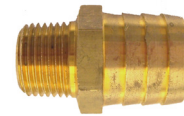

50 512 017

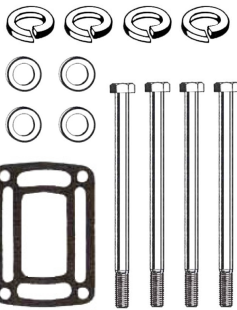

OMC 20 913784P



FM 47 0000

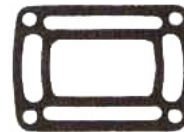

OMC47 913783

**Warning: Barr Riser Shown Only Fits Carbureted Ford Engines!
 Will Not Directly Replace Volvo Part #'s 3855271 (port) Or
 3855269 (stbd) Risers for EFI Models**

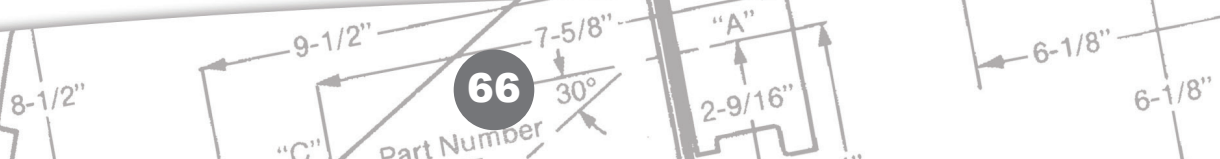

PERKINS 160 H.P. 354 C.I.D.

Model T6.354M



PE 1 6354



PE 1 6354B

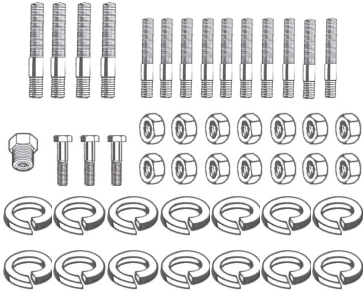

PE 1 6354P

PE-1-6354	Water cooled exhaust manifold (includes mounting hardware to head). Replaces Perkins part number 89058.
PE-1-6354B	Cover plate. Replaces Perkins part # 35732861.
PE-1-6354P	Manifold mounting kit.

Note:

The manifold will fit vertical or inclined models and will accept all of the original end plates, fittings, gaskets and hardware. It will not fit engines equipped with a combined exhaust manifold heat exchanger, nor is it applicable to naturally aspirated models.

PCM V8-302 and 351 C.I.D. All Years

CENTER RISER GENERIC

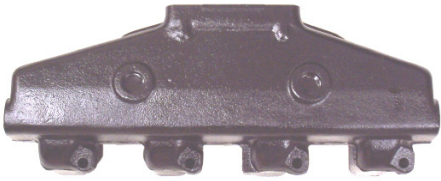

FM 1 83

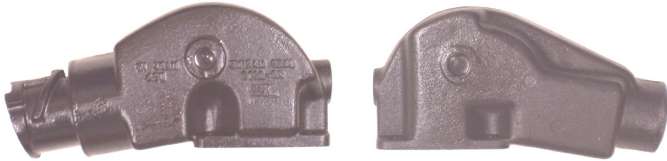

20 0100

20 0082



20 0102



20 0097

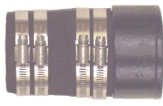

20 0084P

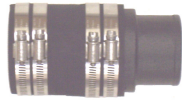

20 0085P



20 0086P



20 0087P



20 0088P



20 0089P



20 0092P



20 0093P



20 0082P



FM 1 83P



1 0104P



FM 47 0000



1 0105



1 0107

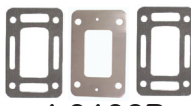

1 0106P

Note:
Manifold includes all plugs, gaskets and mounting hardware to head. Risers include plugs, gasket and mounting hardware to mount to manifold.

FM-1-83	Water cooled center discharge manifold to fit the small block Ford engine (3/4" N.P.T. cooling hose connections). All years.
20-0082	Water cooled center discharge riser (3/4" N.P.T. cooling hose connection). Standard for use with 3" I.D. exhaust hose.
20-0100	Water cooled center discharge riser (3/4" N.P.T. cooling hose connection). Standard for use with 4" I.D. exhaust hose.
20-0102	Water cooled center discharge riser (3/4" N.P.T. cooling hose connection).
1-0104P	Adaptor package for fresh water cooled manifold (includes gaskets and block off plate).
1-0105	Center riser manifold-to-riser gasket for fresh water cooling.
1-0106P	Adaptor package for raw water cooling. Used in pre-heating applications (includes gaskets and block off plate with vent hole).
1-0107	Center riser manifold-to-riser gasket (raw water cooling).
20-0082P	Riser mounting package for both 20-0082 and 20-0100.
20-0082SS-P	Stainless steel mounting package (with brass plugs) for both 20-0082 and 20-0100. Not pictured.
20-0084P	Straight exhaust adaptor (includes adaptor, hose and clamps). For use with 3 1/2" I.D. exhaust hose.
20-0085P	Straight exhaust adaptor (includes adaptor, hose and clamps). For use with 2 1/2" I.D. exhaust hose.
20-0086P	90 degree exhaust elbow adaptor (includes adaptor, hose and clamps). For use with 2 1/2" I.D. exhaust hose.
20-0087P	90 degree exhaust elbow adaptor (includes adaptor, hose and clamps). For use with 3" I.D. exhaust hose.
20-0088P	30 degree exhaust elbow adaptor (includes adaptor, hose and clamps). For use with 2 1/2" I.D. exhaust hose.
20-0089P	30 degree exhaust elbow adaptor (includes adaptor, hose and clamps). For use with 3" I.D. exhaust hose.
20-0092P	45 degree exhaust elbow adaptor (includes adaptor, hose and clamps). For use with 3" I.D. exhaust hose.
20-0093P	90 degree exhaust elbow adaptor (includes adaptor, hose and clamps). For use with 3 1/2" or 4" I.D. exhaust hose.
20-0097	3" spacer block (complete with mounting hardware, gasket and 3/4" pipe plug). Capable of stacking.
FM-1-83P	Manifold mounting package (includes bolts and pipe plugs).
FM-1-83SS-P	Stainless steel manifold mounting package (includes stainless bolts and brass plugs). Not pictured.
FM-47-0000	Manifold to cylinder head gasket.

BARR
MARINE BY EDM

8-1/2"

9-1/2"

68

Part Number

7-5/8"

30°

"A"

2-9/16"

6-1/8"

6-1/8"

Universal Atomic 4

LOG STYLE DIRECT REPLACEMENT



UV 1 259624

UV-1-259624	Water cooled manifold.
UV47-261050	Manifold to cylinder head gasket. Direct replacement for Universal gasket part # 261050.



UV47 261050

Volvo 4 Cylinder Models AQ 115 and AQ 130

LOG STYLE DIRECT REPLACEMENT



VO 1 824532

VO-1-824532	Direct replacement water cooled exhaust manifold. Replaces Volvo part # 824532-6.
VO-20-825599	Direct replacement exhaust elbow. Replaces Volvo part # 825599-4.
VO47-856028	Direct replacement exhaust elbow to manifold gasket. Replaces Volvo part # 856028.



VO 20 825599

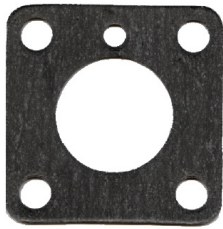

VO47 856028

Barr Marine extends a 1 year warranty on this exhaust manifold.

BARR
MARINE BY EDM

Volvo 4 Cylinder

Models AQ 120B, 125A, 140A, 145A BB, 140A and 145A

LOG STYLE DIRECT REPLACEMENT



VO 1 855387

VO-1-855387	Direct replacement water cooled exhaust manifold. Replaces Volvo part # 855387-7 and 834438-4.
VO47-855383	Exhaust manifold to cylinder head gasket (requires four gasket per engine).

Note:

Manifold includes all plugs, gaskets and mounting hardware to head.



VO47 855383

Barr Marine extends a 1 year warranty on this exhaust manifold.

BARR
MARINE BY EDM

Volvo V6-4.3L Cobra

Discharge
Part Number
20-0000

All Models

CENTER RISER DIRECT REPLACEMENT

Internal
Water
Discharge



OMC 1 3857656

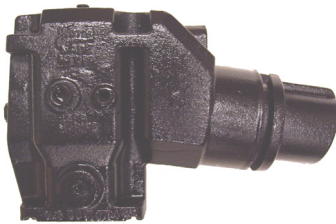

OMC 20 913784

OMC-1-3857656	Direct replacement exhaust manifold. Replaces Volvo part # 3857656.
OMC-20-913784	Direct replacement exhaust riser/elbow. Replaces OMC # 913784 and Volvo part # 3863061 (New Style).
OMC-20-913784P	Exhaust riser/elbow mounting package.
MC47-27 99757	Exhaust manifold to cylinder head gasket.
OMC47-913783	Direct replacement exhaust riser/elbow to manifold gasket.
50-512-017	Replacement 1/2" N.P.T. to 1" hose (straight)/brass hose fitting.

Note:

Manifold includes all plugs, gaskets and mounting hardware to head. Risers include plugs, gasket and mounting hardware to mount to manifold.

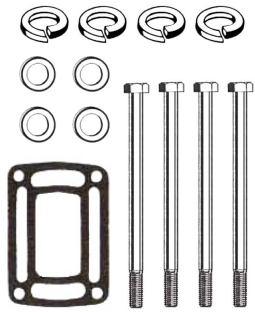

OMC 20 913784P

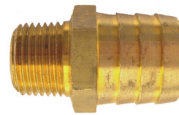

50 512 017
Sold Separately



MC47 27 99757

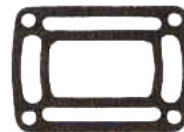

OMC47 913783

BARR
MARINE BY EDM

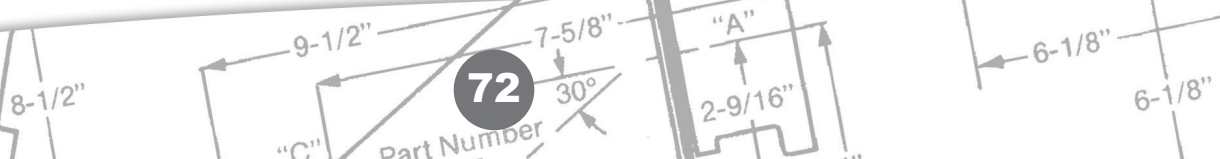

Volvo V8-307 and 350 C.I.D.

ALL MODELS CENTER RISER GENERIC



CHV 1 83

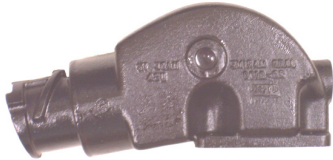

20 0100



20 0082



20 0097

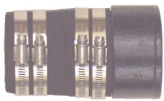

20 0084P

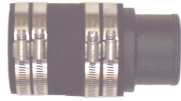

20 0085P



20 0086P



20 0087P



20 0088P



20 0092P



20 0093P



20 0089P



CHV 27 0083



OMC 20 0003



20 0082P



CHV 1 83P

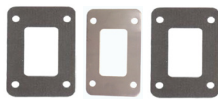

1 0104P

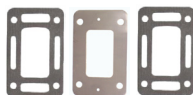

1 0106P



CHV 47 0000



1 0105



1 0107

Note:
Manifold includes all plugs, gaskets and mounting hardware to head. Risers include plugs, gasket and mounting hardware to mount to manifold.

CHV-1-83	Water cooled center discharge manifold to fit the small block GM engine (3/4" N.P.T. cooling hose connections). All years.
20-0082	Water cooled center discharge riser (3/4" N.P.T. cooling hose connection). Standard for use with 3" I.D. exhaust hose.
20-0100	Water cooled center discharge riser (3/4" N.P.T. cooling hose connection). Standard for use with 4" I.D. exhaust hose.
1-0104P	Adaptor package for fresh water cooled manifold (includes gaskets and block off plate).
1-0105	Center riser manifold-to-riser gasket for fresh water cooling.
1-0106P	Adaptor package for raw water cooling. Used in pre-heating applications (includes gaskets and block off plate with vent hole).
1-0107	Center riser manifold-to-riser gasket (raw water cooling).
20-0082P	Riser mounting package for both 20-0082 and 20-0100.
20-0082SS-P	Stainless steel mounting package (with brass plugs) for both 20-0082 and 20-0100. Not pictured.
20-0084P	Straight exhaust adaptor (includes adaptor, hose and clamps). For use with 3 1/2" I.D. exhaust hose.
20-0085P	Straight exhaust adaptor (includes adaptor, hose and clamps). For use with 2 1/2" I.D. exhaust hose.
20-0086P	90 degree exhaust elbow adaptor for I/O applications (includes adaptor, hose and clamps). For use with 2 1/2" I.D. exhaust hose.
20-0087P	90 degree exhaust elbow adaptor (includes adaptor, hose and clamps). For use with 3" I.D. exhaust hose.
20-0088P	30 degree exhaust elbow adaptor (includes adaptor, hose and clamps). For use with 2 1/2" I.D. exhaust hose.
20-0089P	30 degree exhaust elbow adaptor (includes adaptor, hose and clamps). For use with 3" I.D. exhaust hose.
20-0092P	45 degree exhaust elbow adaptor (includes adaptor, hose and clamps). For use with 3" I.D. exhaust hose.
20-0093P	90 degree exhaust elbow adaptor (includes adaptor, hose and clamps). For use with 3 1/2" or 4" I.D. exhaust hose.
20-0097	3" spacer block (complete with mounting hardware, gasket and 3/4" pipe plug). Capable of stacking.
CHV-1-83P	Manifold mounting package (includes bolts and pipe plugs).
CHV-1-83SS-P	Stainless steel manifold mounting package (includes stainless bolts and brass plugs). Not pictured.
CHV-27-0083	Alternator bracket. Use where engine water pump is mounted on port side of engine below alternator.
CHV-47-0000	Manifold to cylinder head gasket.
OMC-20-0003	Hose bushing 3" to 3 1/2".

BARR
MARINE BY EDM

Volvo V8-307 and 350 C.I.D.

Models AQ 200D, 200F, 225D, 225E, 225F, 255B, 260A, 271A, 280A, 290A, 311A BB, 225A, 225 AV, 225B, 260A, 260B and 260C

CENTER RISER DIRECT REPLACEMENT

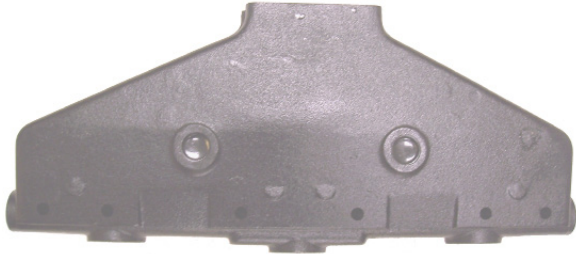

VO 1 835804



VO 20 855384



VO 20 855384P



VO47 835908



VO47 841601

VO-1-835804	Direct replacement water cooled exhaust manifold. Replaces Volvo part # 835804-6.
VO-20-855384	Direct replacement exhaust riser/elbow. Replaces Volvo part # 855384-4.
VO-20-855384P	Exhaust riser/elbow mounting package.
VO47-835908	Exhaust riser/elbow to manifold gasket.
VO47-841601	Exhaust manifold to cylinder head gasket

Note:

Manifold includes all plugs, gaskets and mounting hardware to head. Risers include plugs, gasket and mounting hardware to mount to manifold.

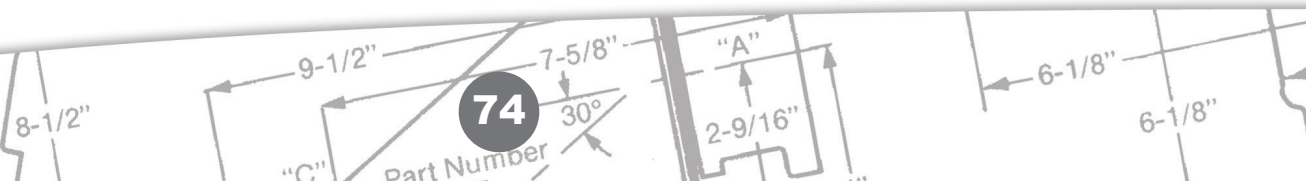

Volvo V8-5.7L Cobra

CENTER RISER DIRECT REPLACEMENT



OMC 1 914035

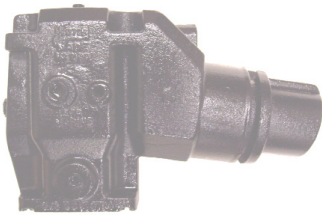

OMC 20 913784

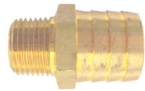

50 512 017



OMC 1 914035P

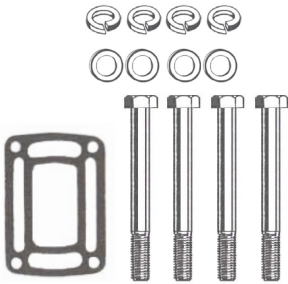

OMC 20 913784P

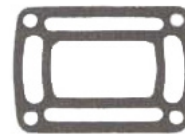

OMC47 913783



OMC47 909314

OMC-1-914035	Direct replacement exhaust manifold. Replaces OMC part # 914035 and Volvo part # 3857723 and # 3857579 (New Style).
OMC-20-913784	Direct replacement exhaust riser/elbow. Replaces OMC # 913784 and Volvo part # 3863061 and # 3857944 and # 3861842 (New Style).
OMC-1-914035P	Exhaust manifold mounting package.
OMC-20-913784P	Exhaust riser/elbow mounting package.
OMC47-909314	Exhaust manifold to cylinder head gasket.
OMC47-913783	Direct replacement exhaust riser/elbow to manifold gasket.
50-512-017	Replacement 1/2" N.P.T. to 1" hose (straight)/brass hose fitting.

Note:

Manifold includes all plugs, gaskets and mounting hardware to head. Risers include plugs, gasket and mounting hardware to mount to manifold.

Volvo V8-5.0L and 5.8L Cobra

All Models Carbureted

CENTER RISER DIRECT REPLACEMENT

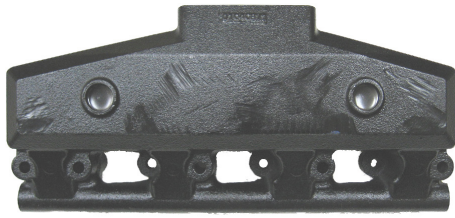

OMC 1 3852347

OMC-1-3852347	Direct replacement exhaust manifold. Replaces Volvo part # 3852347.
OMC-20-913784	Direct replacement exhaust riser/elbow. Replaces OMC # 913784 and Volvo part # 3863061 (New Style).
OMC-20-913784P	Exhaust riser/elbow mounting package.
FM 47 0000	Exhaust manifold to cylinder head gasket.
OMC47-913783	Direct replacement exhaust riser/elbow to manifold gasket.
50-512-017	Replacement 1/2" N.P.T. to 1" hose (straight)/brass hose fitting.

Note:

Manifold includes all plugs, gaskets, hose fitting and mounting hardware to head. Risers include plugs, gasket and mounting hardware to mount to manifold.

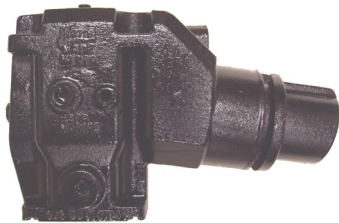

OMC 20 913784

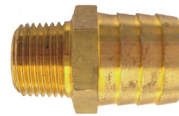

50 512 017



FM 47 0000

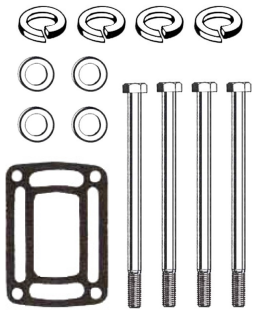

OMC 20 913784P

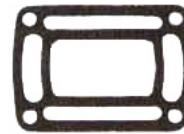

OMC47 913783

Warning: Barr Riser Shown Only Fits Carbureted Ford Engines! Will Not Directly Replace Volvo Part #'s 3855271 (port) Or 3855269 (stbd) Risers for EFI Models



8-1/2"



6-1/8"

6-1/8"

Waukesha V8-302 and 351 C.I.D. All Years

CENTER RISER GENERIC

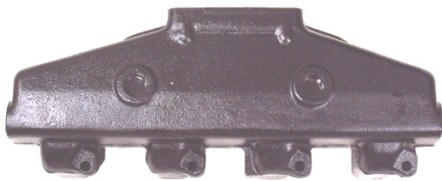

FM 1 83

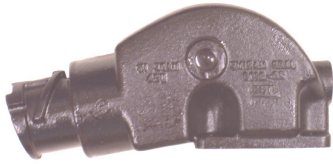

20 0100



20 0082



20 0097

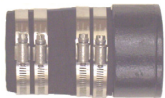

20 0084P

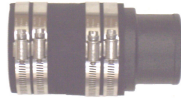

20 0085P



20 0086P



20 0087P



20 0088P



20 0092P



20 0093P



20 0089P



20 0082P



FM 1 83P



1 0105



1 0107



1 0104P



1 0106P



FM 47 0000

Note:
Manifold includes all plugs, gaskets and mounting hardware to head. Risers include plugs, gasket and mounting hardware to mount to manifold.

FM-1-83	Water cooled center discharge manifold to fit the small block Ford engine (3/4" N.P.T. cooling hose connections). All years.
20-0082	Water cooled center discharge riser (3/4" N.P.T. cooling hose connection). Standard for use with 3" I.D. exhaust hose.
20-0100	Water cooled center discharge riser (3/4" N.P.T. cooling hose connection). Standard for use with 4" I.D. exhaust hose.
1-0104P	Adaptor package for fresh water cooled manifold (includes gaskets and block off plate).
1-0105	Center riser manifold-to-riser gasket for fresh water cooling.
1-0106P	Adaptor package for raw water cooling. Used in pre-heating applications (includes gaskets and block off plate with vent hole).
1-0107	Center riser manifold-to-riser gasket (raw water cooling).
20-0082P	Riser mounting package for both 20-0082 and 20-0100.
20-0082SS-P	Stainless steel mounting package (with brass plugs) for both 20-0082 and 20-0100. Not pictured.
20-0084P	Straight exhaust adaptor (includes adaptor, hose and clamps). For use with 3 1/2" I.D. exhaust hose.
20-0085P	Straight exhaust adaptor (includes adaptor, hose and clamps). For use with 2 1/2" I.D. exhaust hose.
20-0086P	90 degree exhaust elbow adaptor (includes adaptor, hose and clamps). For use with 2 1/2" I.D. exhaust hose.
20-0087P	90 degree exhaust elbow adaptor (includes adaptor, hose and clamps). For use with 3" I.D. exhaust hose.
20-0088P	30 degree exhaust elbow adaptor (includes adaptor, hose and clamps). For use with 2 1/2" I.D. exhaust hose.
20-0089P	30 degree exhaust elbow adaptor (includes adaptor, hose and clamps). For use with 3" I.D. exhaust hose.
20-0092P	45 degree exhaust elbow adaptor (includes adaptor, hose and clamps). For use with 3" I.D. exhaust hose.
20-0093P	90 degree exhaust elbow adaptor (includes adaptor, hose and clamps). For use with 3 1/2" or 4" I.D. exhaust hose.
20-0097	3" spacer block (complete with mounting hardware, gasket and 3/4" pipe plug). Capable of stacking.
FM-1-83P	Manifold mounting package (includes bolts and pipe plugs).
FM-1-83SS-P	Stainless steel manifold mounting package (includes stainless bolts and brass plugs). Not pictured.
FM-47-0000	Manifold to cylinder head gasket.

BARR
MARINE BY EDM

Center Discharge Exhaust Riser 4"

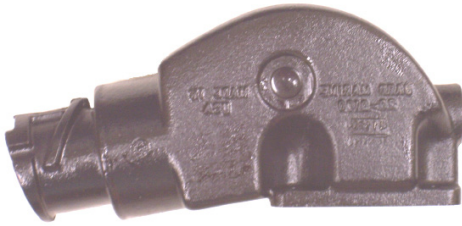

20 0100

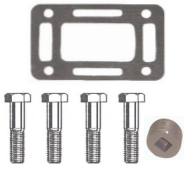

20 0082P



20 0082SS P

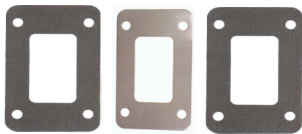

1 0104P

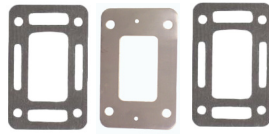

1 0106P

20-0100	Water cooled center discharge riser (3/4" N.P.T. cooling hose connection). Standard for use with 4" I.D. exhaust hose.
1-0104P	Adaptor package for fresh water cooled manifold (includes gaskets and block off plate).
1-0105	Center riser manifold-to-riser gasket for fresh water cooling.
1-0106P	Adaptor package for raw water cooling. Used in pre-heating applications (includes gaskets and block off plate with vent hole).
1-0107	Center riser manifold-to-riser gasket (raw water cooling).
20-0082P	Riser mounting package for both 20-0082 and 20-0100.
20-0082SS-P	Stainless steel mounting package (with brass plugs) for both 20-0082 and 20-0100.

The Barr Center Riser is designed to limit back pressure on the engine. This riser is to be utilized with the Barr CHV-1-83, FM-1-83 and CHVA-1-84 manifolds!

Note:
Riser includes plug, gasket and mounting hardware to mount to manifold.

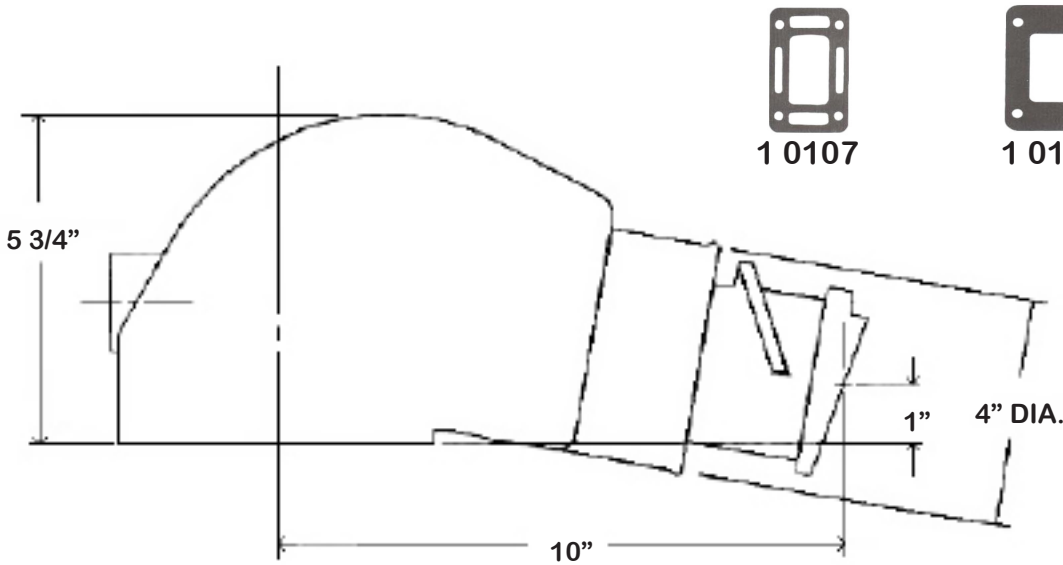

BARR
MARINE BY EDM

Center Discharge Manifold and Riser System Dimensions

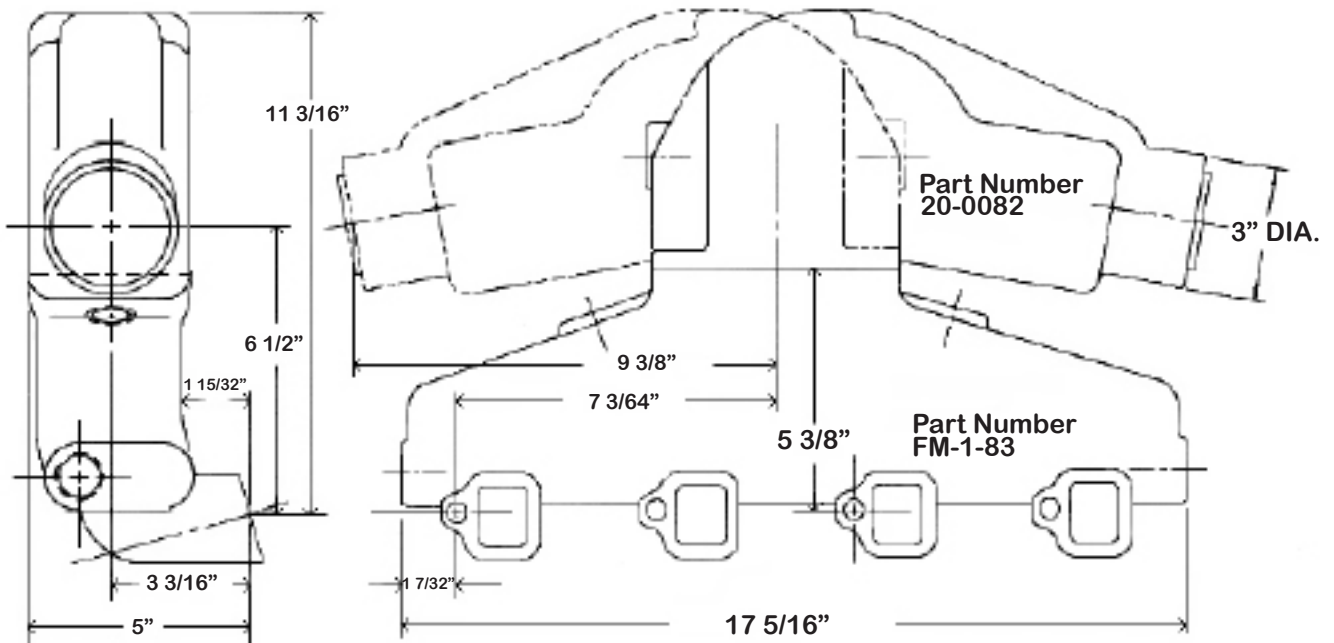
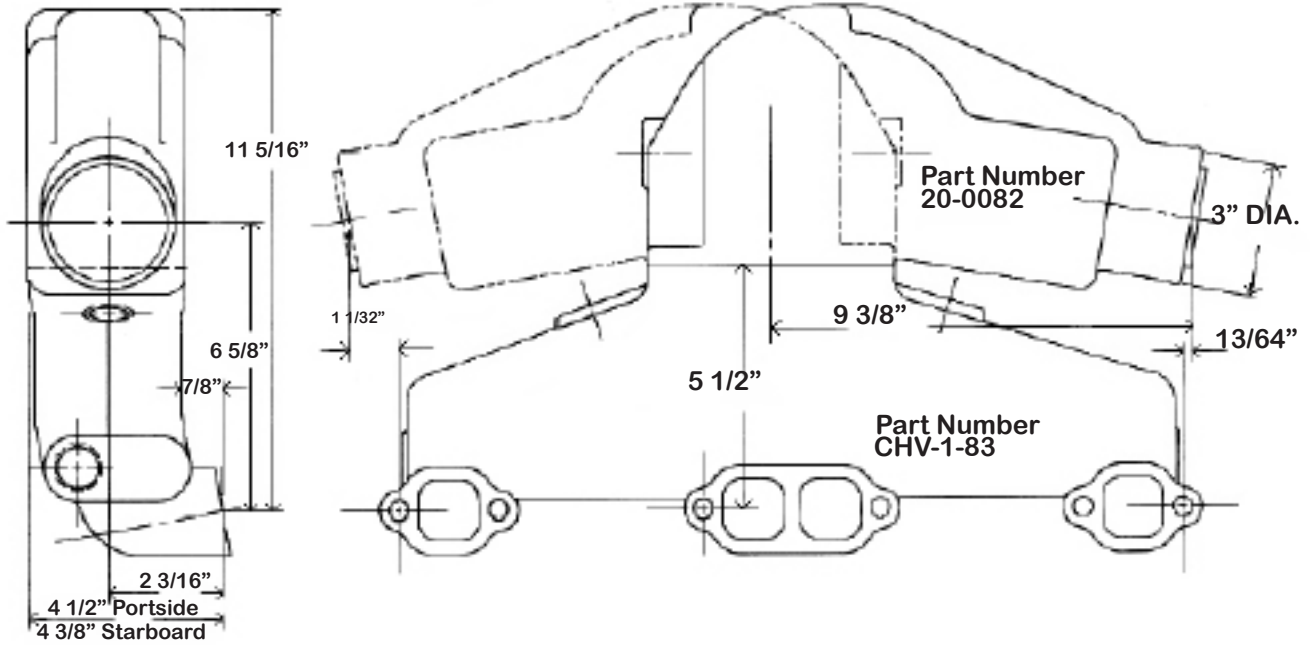

BARR
MARINE BY EDM

Center Discharge Manifold and Riser System Dimensions

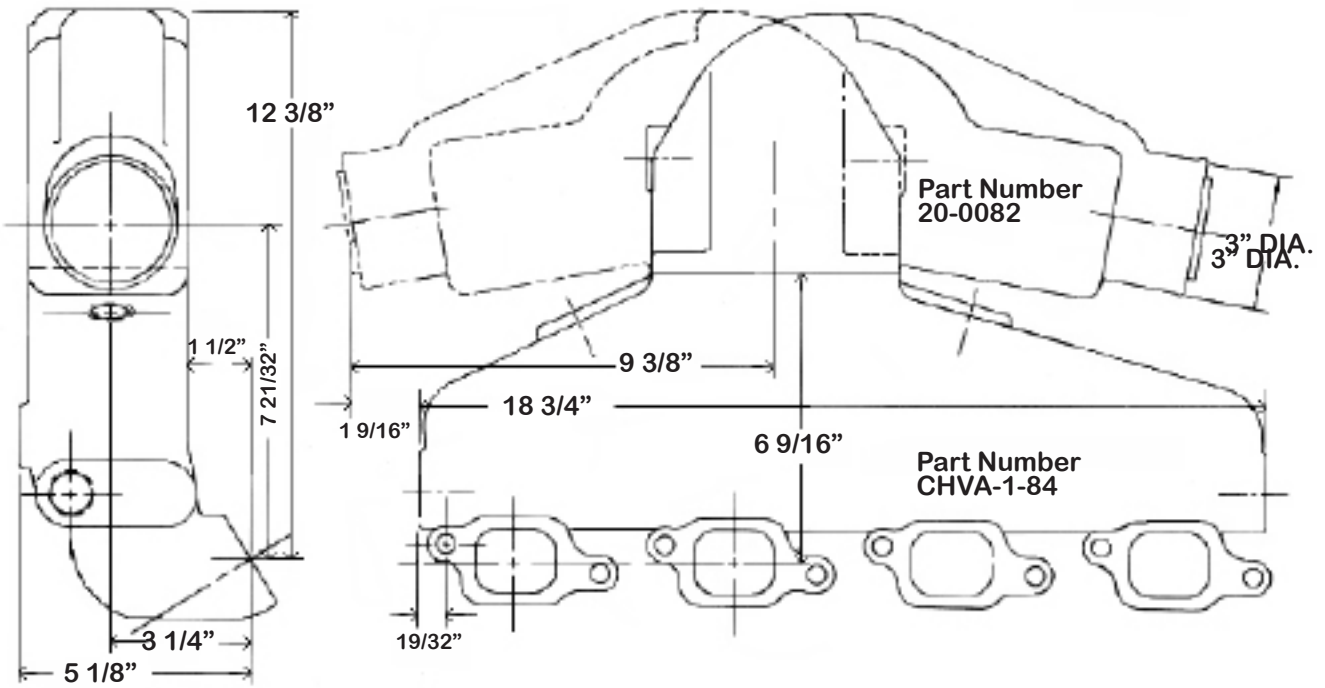

BARR
MARINE BY EDM

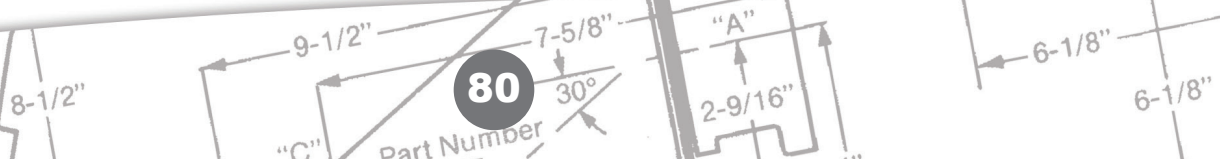

Exhaust Risers and Connectors

Part#	Detailed Description
1-0001	Adaptor for Barr manifold replacing size "A" end plate (2" pipe). Order (1) for 4 or 6 cylinder engines or (2) for V8 cylinder engines.
1-0081	Adaptor for Barr round-type Oldsmobile conversion manifold (OR-1-73). Order (2) for Oldsmobile V8 cylinder engines.
1-0012L	Adaptor for Chris Craft V8 283 C.I.D. manifolds prior to Models F, G, K and Q (three pass system), "L" for left side. Order (1) for Chris Craft V8 cylinder engines (port/left side).
1-0012R	Adaptor for Chris Craft V8 283 C.I.D. manifolds prior to Models F, G, K and Q (three pass system), "R" for right side. Order (1) for Chris Craft V8 cylinder engines (starboard/right side).
1-0283A	Adaptor for Chris Craft V8 283, 302, 305, 307, 327 and 350 C.I.D. manifolds; models F, G and K (two pass system). Order 2 for Chris Craft V8 cylinder engines.
1-0283L	Adaptor for Chris Craft V8 283, 302, 305, 307, 327 and 350 C.I.D. manifolds; model Q (single pass system), "L" for left side. Order (1) for Chris Craft V8 cylinder engines (port/left side).
1-0283R	Adaptor for Chris Craft V8 283, 302, 305, 307, 327 and 350 C.I.D. manifolds; model Q (single pass system), "R" for right side. Order (1) for Chris Craft V8 cylinder engines (starboard/right side).
1-0007	Adaptor for Chrysler V8 383, 413 and 440 C.I.D. manifolds (4 bolt), Chrysler Ace and Crown Engines. Order (1) for Ace and Crown 6 cylinder engines and (2) for Chrysler V8 engines.
1-0013L	Adaptor for Chrysler V8 318 C.I.D. (prior to 1966); "L" for left side. Order (1) for Chrysler V8 engines (port/left side).
1-0013R	Adaptor for Chrysler V8 318 C.I.D. (prior to 1966); "R" for right side. Order (1) for Chrysler V8 engines (port/left side).
1-0071	Adaptor for Chrysler V8, Model M 81 (225 H.P.). Order (2) for Chrysler M 81 V8 engines.
CM-1-6672C	Adaptor for Chrysler V8 318 C.I.D. (after 1966). Order (2) for Chrysler V8 engines.
1-0002	Adaptor for Graymarine V8 327 C.I.D. (4 bolt flange). Order (2) for Graymarine V8 (4 bolt) engines.
1-0069	Adaptor for Graymarine V8 327 C.I.D. (3 bolt flange). Order (2) for Graymarine V8 (3 bolt) engines.
1-0070	Adaptor for Palmer V8, Model 14-345
1-0014	Universal adaptor to fit any engine with 3 1/4" or smaller manifold end (drill to suit manifold). Order (1) for 4 or 6 cylinder engines or (2) for V8 cylinder engines.
20-0008	Adaptor for 2" standard N.P.T. pipe thread. Order (1) for 4 or 6 cylinder engines or (2) for V8 cylinder engines.
20-0004	Adaptor for 2 1/2" standard N.P.T. pipe thread. Order (1) for 4 or 6 cylinder engines or (2) for V8 cylinder engines.

Exhaust Risers and Connectors



20 0000



20 0031

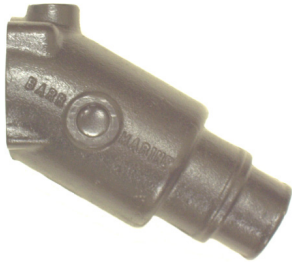

20 0055



20 0039



20 0035



20 0034

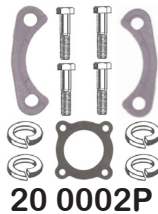

20 0002P

20-0000	Swivel-type high discharge exhaust riser; 8 1/2" riser protection. Requires (1) mounting hardware kit #20-0002P per riser. Use only with 2 7/8" to 3" I.D. exhaust hose.
20-0002P	Mounting hardware kit.
20-0031	Swivel-type 90 degree exhaust elbow connector with internal water discharge. Accepts 2 1/2" to 3" I.D. exhaust hose. Requires (1) mounting hardware kit #20-0002P per elbow.
20-0034 or 20-0035	Exhaust connector #20-0035 (for 2 1/2" I.D. exhaust hose) or exhaust connector #20-0034 (for 3" I.D. exhaust hose). Connects to #20-0039 using (1) #20-0002P per connector.
20-0039	Fully jacketed swivel-type exhaust riser; 7" riser protection. Requires (2) mounting hardware kits #20-0002P ((1) kit to mount riser to manifold and (1) kit to mount elbows #20-0034 or #20-0035 to riser).
20-0055	Swivel-type 30 degree exhaust elbow connector; fully jacketed. Accepts 2 1/2" or 3" I.D. exhaust hose. Requires (1) mounting hardware kit #20-0002P per elbow.

Note:
A header adaptor style end cap must be installed on the exhaust end of the log manifold in order to mount these risers or elbows. See the "Manifold End Plate and Gasket Identification Listing" page at the beginning of this catalog for the proper end plates specific to your application.

BARR
 MARINE BY EDM

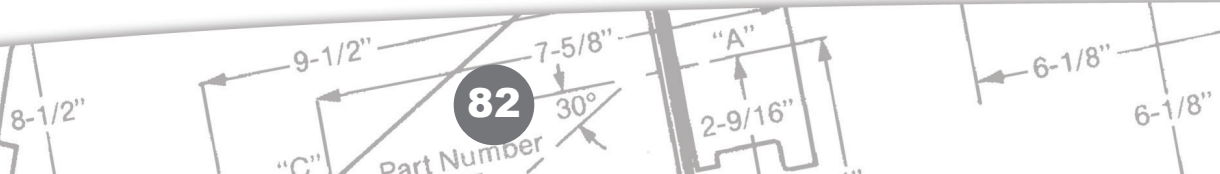

Exhaust Risers and Connectors

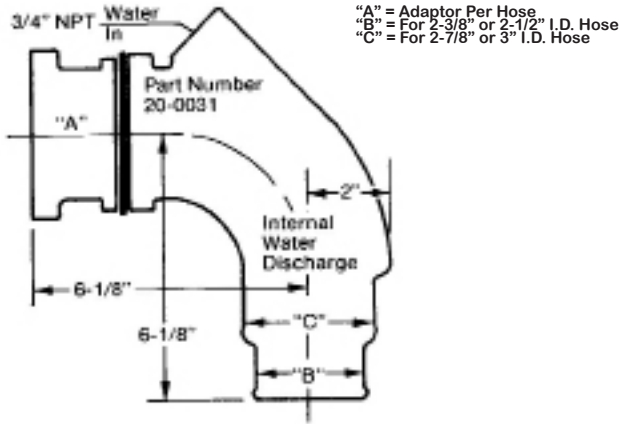

"A" = Adaptor Per Hose
"B" = For 2-3/8" or 2-1/2" I.D. Hose
"C" = For 2-7/8" or 3" I.D. Hose

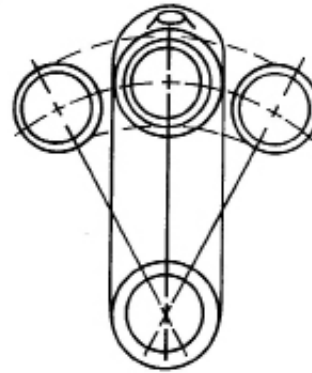
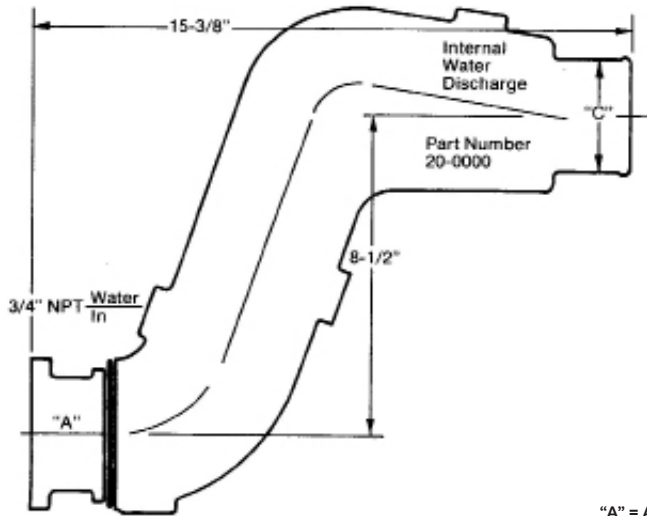
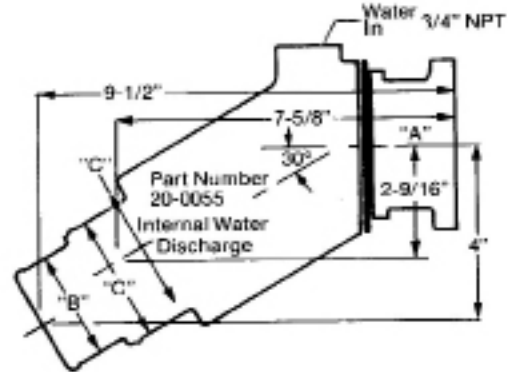

"A" = Adaptor Per Hose
"B" = For 2-3/8" or 2-1/2" I.D. Hose
"C" = For 2-7/8" or 3" I.D. Hose

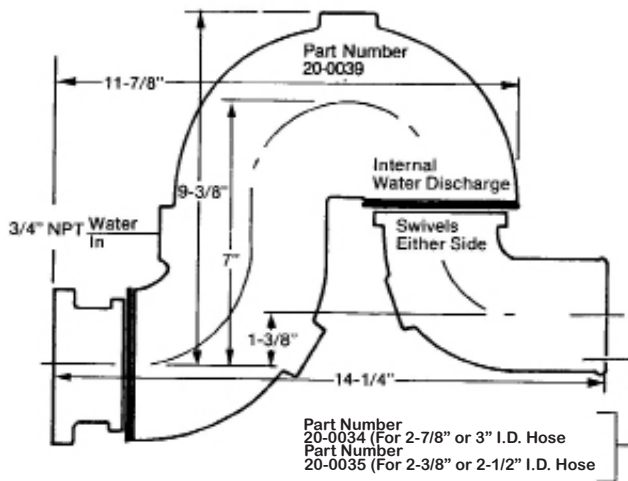

Part Number 20-0034 (For 2-7/8" or 3" I.D. Hose)
Part Number 20-0035 (For 2-3/8" or 2-1/2" I.D. Hose)

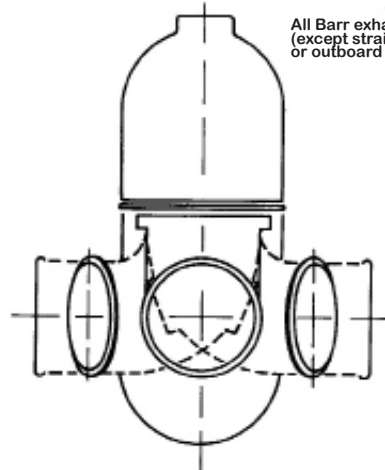

All Barr exhaust risers and connectors (except straight) can be swiveled inboard or outboard in vertical plane.

Exhaust connectors 20-0034 and 20-0035 can be swiveled inboard or outboard in horizontal plane.

Thermostat and Thermostat Housing Assemblies Barr Marine Style



CHV 29 0120



CHV 29 80



CHVA 29 78



FM 29 0083



OR 29 74



CM 29 3675303



CM 29 4142522



CR 29 96319



MC 29 59078



MC 29 59137



OMC 29 383307

CHV-29-0120	Thermostat housing assembly for dual pump cooling system on 4 cyl. Chevrolet engines.
CHV-29-80	Thermostat housing assembly for dual pump cooling system on Chevrolet V6 and Small Block V8 engines.
CHVA-29-78	Thermostat housing assembly for dual pump cooling system on Big Block Chevrolet V8's.
CM-29-3675303	Chrysler thermostat (140 degree).
CM-29-4142522	Chrysler thermostat (163 degree).
CR-29-96319	Crusader thermostat (143 degree).
FM-29-0083	Thermostat housing assembly for dual pump system on Small Block Ford V8's.
MC-29-59078	MerCruiser thermostat for models 120, 140, 120R/140R, 160, 165 and 200.
MC-29-59137	MerCruiser thermostat for models 888 (Ford), 225 (Ford), 233 (Ford) and 255 (Ford).
OMC-29-383307	OMC thermostat (160 degree).
OR-29-74	Thermostat housing assembly for dual pump cooling system on Oldsmobile V8's (350, 403 and 455 C.I.D.).

BARR
MARINE BY EDM

Adaptor Bell Housings



CHV-24-0001



CHV-WVDC-5561A



CHVA-WVDC-77A



FM-WVDC-70A

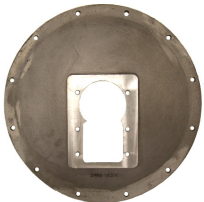

HUR-SAE4



MC-24-14043



MC-24-44187



OR-WVDC-65A

Not Pictured/Call
SAE3-WVDC

Not Pictured/Call
SAE2 502



OR-WVDC-73A



OR-WVDC-76A

Not Pictured/Call
CHV-WVDC-70A

Not Pictured/Call
MC-24-0001

Not Pictured/Call
OR-WVDC-78A

Part#

Detailed Description

CHV-24-0001	Chevrolet in-line 6 cylinder 1962-79; 194, 230 and 250 C.I.D.; all models with 12 5/8" diameter flywheel. Also for 1963-283, 307, 327 and 350 C.I.D. with 12 5/8" diameter flywheel (26 spline applications).
CHV-WVDC-5561A	Chevrolet V8 OHV 1955-62; 265, 283 and 327 C.I.D.; 1963 to date, 292 C.I.D. with 14" flywheel and starter mounting to flywheel housing; 1959-70; 348, 396, 409, 427 and 454 C.I.D. with 14" diameter flywheel (26 spline applications).
CHV-WVDC-70A	Chevrolet V8 OHV 1971 to date; all models with 14" diameter flywheel and starter mounting to the underside of block (26 spline applications).
CHVA-WVDC-77A	Chevrolet V8 OHV 1971 to date; all models with 14" flywheel and top mounted starter (26 spline applications).
FM-WVDC-70A	Ford and Mercury in-line 6 cylinder 1965-69; 240 and 300 C.I.D. Ford and Mercury V8 OHV 1965 to date; 289, 302 and 351 C.I.D. (identified by the use of 6 bolts to attach flywheel housing to cylinder block-26 spline applications).
HUR-SAE4	Kubota Diesel 1902 Series; flywheel housing for Hurth HBW-50, 100 and 150-2R gear (2:1 ratio).
MC-24-0001	Starter cover plate for use on housings (MC-24-44187) utilizing bottom mounted starters (26 spline applications).
MC-24-14043	Dust cover plate used on MerCruiser style flywheel housing (MC-24-44187)(26 spline transmissions).
MC-24-44187	Direct replacemet for MerCruiser part # 44187. Fits Chevrolet in-line 6 cylinder 250 and 292 C.I.D. with 14" flywheel, Chevrolet V6 200, 201, 229 and 262 C.I.D. with 14" flywheel, Chevrolet V8 (Small Block) 265, 283, 305, 307, 327 and 350 C.I.D. with 14" flywheel and Chevrolet V8 (Big Block) 348, 396, 409, 427 and 454 C.I.D. with 14" flywheel (26 spline applications).
OR-WVDC-65A	Buick V8 1967-75; 400, 430 and 455 C.I.D., Oldsmobile V8 1964-84; 330, 350, 400, 403, 425 and 455 C.I.D. and Pontiac V8 1965-78; 326, 350, 389, 400, 428 and 455 C.I.D. (26 spline applications).
OR-WVDC-73A	All above Pontiac, Olds and Buick models with use of top mounted starter. Requires separte rear motor supports which mount to transmission. Order part # AS1-9 for centerline mounting; 9-0003 for 3" offset above centerline mounting and 9-0004 for 6" (26 spline applications).
OR-WVDC-76A	All above Pontiac, Olds and Buick models with use of top mounted starter. Requires separte rear motor supports which mount to transmission. Order part # AS1-9 for centerline mounting; 9-0003 for 3" offset above centerline mounting and 9-0004 for 6" (26 spline applications). Rear engine mounts are incorporated into housing for top mounted starter.
OR-WVDC-78A	Buick V8 1967-75; 400, 430 and 455 C.I.D., Oldsmobile V8 1964-84; 330, 350, 400, 403, 425 and 455 C.I.D. and Pontiac V8 1965-78; 326, 350, 389, 400, 428 and 455 C.I.D. (26 spline applications). Except not equipped with rear engine mount.
SAE3-WVDC	Caterpillar 3100 and 3200 Series 636 C.I.D.; Adapts SAE # 3 pattern to Warner "Velvet Drive" transmission (26 Spline applications).
SAE2-502	Twin Disc SAE pattern; adapts SAE # 2 pattern to Twin Disc 502 transmission.

Rubber Engine Mounts

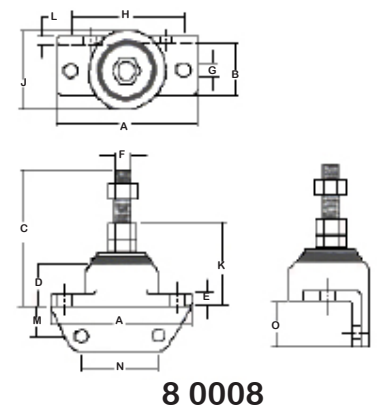
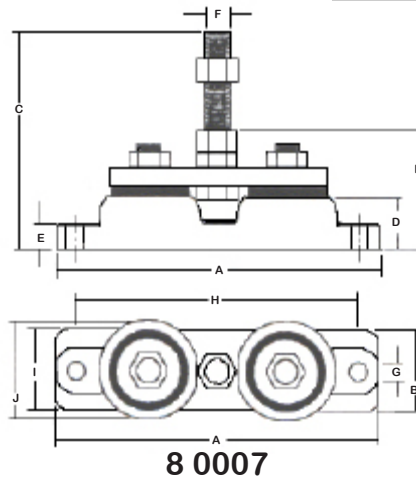
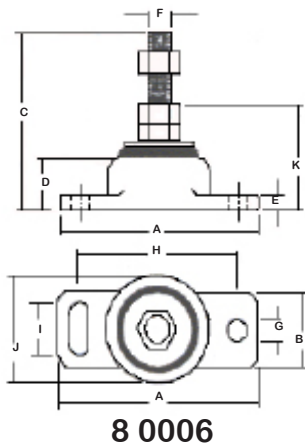
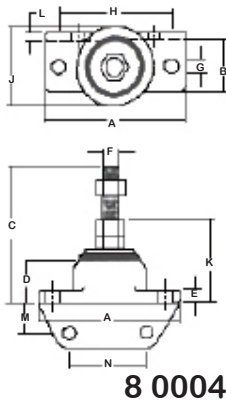
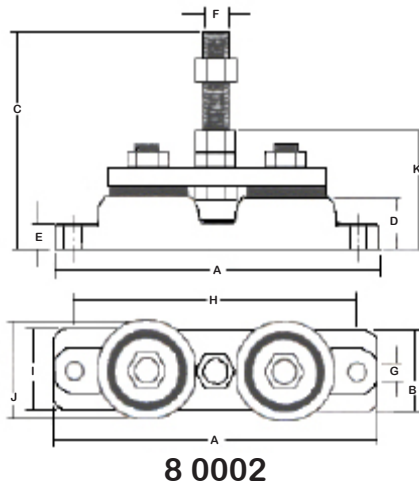
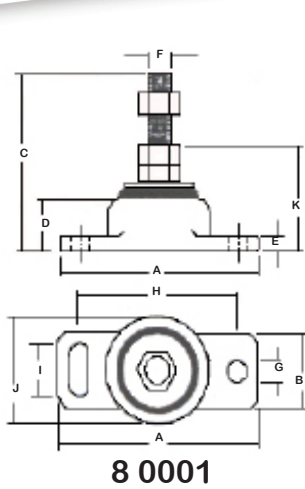

8-0001	Rubber engine mount; single. Adjustable both vertically and horizontally to facilitate engine-propeller shaft alignment. Each mount has a capacity of 350 lbs. The rubber cushions are locked to the base and are oil and fuel resistant.
8-0002	Rubber engine mount; double. Increased capacity for Diesel and extra heavy-duty applications. The rubber cushions are locked to the base, not vulcanized and can be replaced. This mount is vertically adjustable to facilitate engine alignment. Each mount has a capacity of 350 lbs.
8-0004	Rubber engine mount; single. This mount retains all of the fine features of the 8-0001 augmented by an additional tie-down area to bolt to the stringer pads. Each mount has a capacity of 350 lbs.
8-0006	Rubber engine mount; single. Adjustable both vertically and horizontally to facilitate engine-propeller shaft alignment. Each mount has a capacity of 350 lbs. The rubber cushions are locked to the base and are oil and fuel resistant.
8-0007	Rubber engine mount; double. Increased capacity for Diesel and extra heavy-duty applications. The rubber cushions are locked to the base, not vulcanized and can be replaced. This mount is vertically adjustable to facilitate engine alignment. Each mount has a capacity of 550 lbs.
8-0008	Rubber engine mount; single. This mount retains all of the fine features of the 8-0006 augmented by an additional tie-down area to bolt to the stringer pads. Each mount has a capacity of 350 lbs.

Specifications For Rubber Engine Mounts

Part #	A	B	C	D	E	F	Bolt Size & Thread	Hold Down Bolt Size	G	H	I	J	K	L	M	N	O	Max Rated Load Per Mount In Lbs.	Deflection at Avg. Rated Load In Ins.	Packaged Weight In Lbs.
8-0001	5	1 3/4	4 1/2	1 5/16	5/8	5/8 - 18UNF	7/16	4	1 3/16	2 1/2	2 11/16	N/A	N/A	N/A	N/A	N/A	N/A	350	0.060	3
8-0002	8 1/4	2	5 5/8	1 5/16	5/8	5/8 - 18UNF	7/16	7 1/4	N/A	2 1/2	3 1/8	N/A	N/A	N/A	N/A	N/A	N/A	550	0.060	5
8-0004	5	1 3/4	4 1/2	1 5/16	5/8	5/8 - 18UNF	7/16	4	N/A	2 3/4	2 11/16	1/4	1	2 3/4	1 1/2	350	0.060	3.5		
8-0006	5	1 3/4	4 1/2	1 5/16	5/8	3/4 - 16UNF	7/16	4	1 3/16	2 1/2	2 11/16	N/A	N/A	N/A	N/A	N/A	N/A	350	0.060	3
8-0007	8 1/4	2	5 5/8	1 5/16	5/8	3/4 - 16UNF	7/16	7 1/4	N/A	2 1/2	N/A	N/A	N/A	N/A	N/A	N/A	N/A	550	0.060	5
8-0008	5	1 3/4	4 1/2	1 5/16	5/8	3/4 - 16UNF	7/16	4	N/A	2 3/4	2 11/16	1/4	1	2 3/4	1 1/2	350	0.060	3		

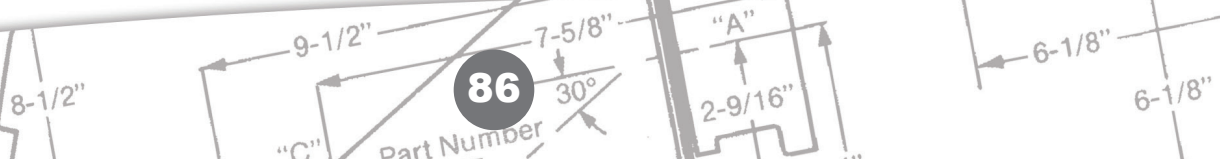

Torsional Dampers

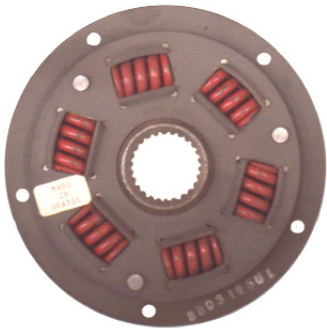

AS4 K1C



AS7 K1C

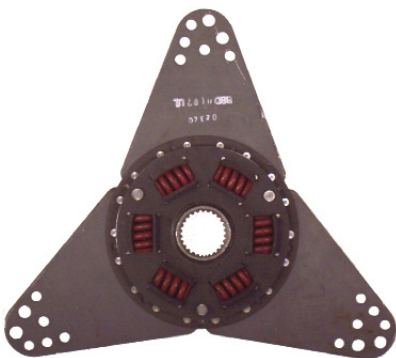

AS4 K2C

AS3-K2C	Heavy duty damper for diesel applications up to 15" diameter for 26 spline transmissions. Not pictured.
AS4-K1C	6.50" diameter damper (5.593" bolt circle diameter) for 26 spline transmissions as used on flywheel forward Flagship and Chris Craft installations Replaces Chris Craft part # 16.99-08334.
AS4-K2C	Three-legged damper for 26 spline transmissions and flywheel diameters more than 13.32". For V8 engines up to 350 C.I.D.
AS5-K2C	Full circle damper 13.25" diameter for 26 spline transmissions. For engines up to 370 C.I.D. Not pictured.
AS7-K1C	7.12" diameter damper (6.58" bolt circle diameter) for 26 transmissions
AS7-K2C	Full circle damper 13.25" diameter for 26 spline transmissions. For engines up to 454 C.I.D.
AS8-K2C	Three-legged damper for 26 spline transmissions and flywheel diameters less than 13.32". For V8 engines up to 350 C.I.D.
1004-65-0001	Full circle damper 13.87" diameter for 26 spline transmissions (use on CAT 3208's and Detroit Diesel 6-71's). Not pictured.

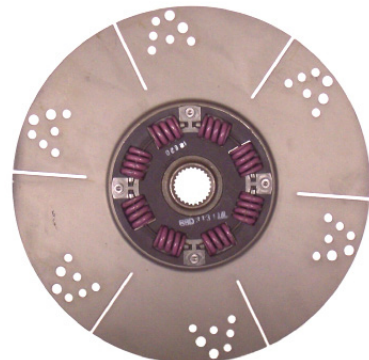

AS7 K2C

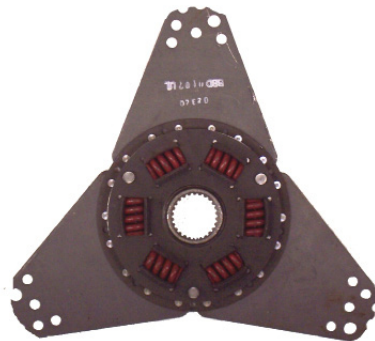

AS8 K2C

BARR
MARINE BY EDM

Flame Arrestors



CAO 10 59

CAO-10-59	Flame arrestor; throat diameter-4 1/4" and height-2 1/8".
CHV-10-56	Flame arrestor; throat diameter-2 5/8" and height-1 7/8".
LEM-10-58	Flame arrestor; throat diameter-5 1/8" and height-3 1/4".
OR-10-61	Flame arrestor; throat diameter-3 1/8" and height-1 7/8".
OR-10-66	Flame arrestor; throat diameter-5 1/8" and height-2 1/4".

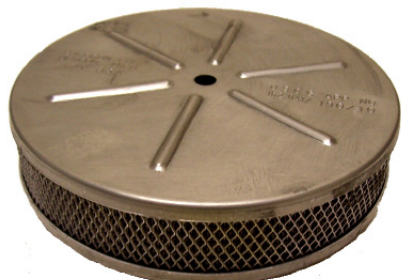

CHV 10 56



OR 10 61



LEM 10 58



OR 10 66

BARR
MARINE BY EDM

8-1/2"

9-1/2"

7-5/8"

88

Part Number

30°

"A"

2-9/16"

6-1/8"

6-1/8"

Crossover Reference Guide

CHRIS CRAFT TO BARR

CHRIS CRAFT PART #	BARR PART #
16.20-07593	CC 20 07593
16.20-07605	CC 20 07605
16.20-07686	CC 1 07686
16.20-08288	CC 20 08288
16.20-08289	CC 20 08289
16.50-05944	CC47 1650 05944
16.50-06022	CC47 1650 06022
16.50-07290	CC47 1650 07290
16.50-07596	CC47 1650 07596
16.50-07597	CC47 1650 07597
16.50-07681	CC47 1650 07681

CHRYSLER TO BARR

CHRYSLER PART #	BARR PART #
2469556	CM 1 6672A
2469639	CM 20 2847405
2600402	CM 20 2600402
2846106	CM 1 6672B
2846689	CM 20 6674
2847404	CM 20 4142411
2847405	CM 20 2847405
2847623	CM 20 4142411
3527781	CM 1 6672E
3527794	CM 20 6672
3619659	CM 1 5972A
3675826	CM 1 6677A
3745639	CM 20 4142411
4142322	CM 1 6677A
4417063	CM 1 4417063
E7081M	CM 1 5972A
E9232M	CM 20 9232
E9233M	CM 20 4142411

CRUSADER TO BARR

CRUSADER PART #	BARR PART #
20471	CR 50 20471
22032	CR 50 22032
22033	CR 50 22033
96108	CR47 C 96108
96120	CR 1 97752
96121	CR 1 97753
96306	CHV 47 0000
96369	CR 50 96369
96560	CR 20 96560
96562	CR47 C 96562
96653	CHVA 47 0000
97169	CR 20 97169
97387	CR 20 97387
97624	CR 20 97624
97752	CR 1 97752
97753	CR 1 97753

CRUSADER TO BARR (CONTINUED)

CRUSADER PART #	BARR PART #
97772	CR 20 97772
97924	CR 20 97924
97992	CR 1 97992
97993	CR 1 97993
98068	CR 20 98068
98126	CR 20 98126
98243	CR 1 98243

MARINE POWER TO BARR

MARINE POWER PART #	BARR PART #
0000-815H7	50 525 020
0991-110	CHVA 1 84
0991-600	CHVA 47 0000
0992-000	20 0082
0992-001	1 0106P
0992-300	1 0104P
0992-400	MC 20 44354
0992-593	20 0100
0994-000	CHV 1 83
0994-600	CHV 47 0000

MERCURISER TO BARR

MERC. PART #	BARR PART #
97429	MC 29 97429
12076A2	MC 20 12076
47441A1	MC 29 47441
47442A1	MC 20 47442
47638A1	1 47638
47735A17	MC 1 47735
47736A17	MC 1 47736
47737A10	MC 1 47737
47738A10	MC 1 47738
55538A2	MC 20 55538
58759A14	MC 1 58759
59498A1	MC 29 59498
60252A2	1 60252
60783A3	MC 29 60783
61851A3	MC 20 61851A2
62898A1	MC 29 62898
63122A13	MC 1 63122
63588A1	MC 29 63588
65603A13	MC 1 65603
65604A12	MC 1 65604
72963A9	MC 20 72963
73811A1	1 73811
73813A1	1 54870
73813A1	1 73813
76325A9	MC 20 76325
76351A2	MC 20 60426
76351A2	MC 20 76351
76668A3	MC 20 76668

Crossover Reference Guide

MERCUISER TO BARR (CONTINUED)

MERC. PART #	BARR PART #
76771A3	MC 20 76771
77234A7	MC 1 77234
77235A8	MC 1 77235
78984A1	MC 29 78984
78985A1	MC 29 78985
806867A8	MC 1 99798
807078A6	MC 1 89011
807476A6	MC 20 93320A3
807477A5	MC 20 93322A3
807988A2	MC 20 44354
860246A10	MC 1 87114
861493A3	MC 29 47587
861493A3	MC 29 60372
87290A4	MC 29 87290
90736A18	MC 29 90736
90880A2	MC 20 90880
95862A5	MC 1 95862
96705A1	MC 1 52390
96705A10	MC 1 96705
97428T 2	MC 29 97428
98502A2	MC 20 98502
98504A3	MC 20 98504
99746A17	MC 1 99746
NLA	MC 20 61811A4
NLA	MC 29 79468
1623-8951A37	MC51 1623 8951A27

OMC TO BARR

OMC PART #	BARR PART#
311550	1 910280
312148	1 312148
312149	1 312149
314810	OMC 29 982201
384560	OMC 24 0000
385799	OMC 20 910380
907776	OMC 20 981281
907777	OMC 20 981281
907885	1 907885
908719	1 908719
909280	OMC 1 912441
910144	OMC 1 912442
910280	1 910280
910380	OMC 20 910380
910384	1 910384
912441	OMC 1 912441
912442	OMC 1 912442
913784	OMC 20 913784
914035	OMC 1 914035
979729	OMC 1 981462
979730	OMC 20 980536

OMC TO BARR (CONTINUED)

OMC PART #	BARR PART#
979758	OMC 1 979758
979759	OMC 1 979759
979760	OMC 1 979760
979761	OMC 1 979761
980083	OMC 1 984054
980188	OMC 20 910380
980382	OMC 24 0000
980459	OMC 1 981462
980460	OMC 1 984054
980536	OMC 20 980636
980572	OMC 1 980959
980617	OMC 20 980617
980957	OMC 1 984054
980959	OMC 1 980959
981281	OMC 20 981281
982490	OMC 1 984054
982680	OMC 20 982680

OSCO TO BARR

OSCO#	EDM PART#
106	CM 1 6672B
121	CM 1 5972C
150	CM 1 5972B
424	CM 1 5972D
557	CM 1 6672E
639	CM 20 2847405
689	CM 20 6674
794	CM 20 6672
826	CM 1 6677A
992	20 0082
994	CHV 1 83
2018	20 0102
2076	MC 20 12076
2441	OMC 1 912441
2442	OMC 1 912442
4354	MC 20 44354
5538	MC 20 55538
5603	MC 1 65603
5604	MC 1 65604
5639	CM 20 4142411
5805	VO 1 835804
5862	MC 1 95862
6022	CC47 1650 06022
6108	CR47 C 96108
6325	MC 20 76325
6351	MC 20 76351
6562	CR47 C 96562
6705	MC 1 96705
6771	MC 20 76771
7056	CC 1 07686

Discharge
Part Number
20-0000

"C"

"A"

Internal
Water
Discharge

2"

8-1/2"

9-1/2"

7-5/8"

90

30°

"A"

2-9/16"

6-1/8"

6-1/8"

Part Number

Crossover Reference Guide

OSCO TO BARR (CONTINUED)

OSCO PART #	BARR PART #
7081	CM 1 5972A
7169	CR 20 97169
7296	CR 20 97296
7387	CR 20 97387
7624	CR 20 97624
7752	CR 1 97752
7753	CR 1 97753
7772	CR 20 97772
7924	CR 20 97924
7992	CR 1 97992
7993	CR 1 97993
8068	CR 20 98068
8243	CR 1 98243
8759	MC 1 58759
9011	MC 1 89011
9234	CM 20 9234
9745	MC 1 99746
9798	MC 1 99798
41812	MC47 27 41812
47510	MC47 27 47510
48818	MC47 27 48818
50456	OMC 20 913784
52076	MC47 27 52076
MC553-BB	MC 29 78985
54870	1 54870
56879	VO 20 855384
60252	1 60252
99204	20 0100
0188	OMC 20 910380
0402	CM 20 2600402
05944	CC47 1650 05944
0879	MC 20 90880
106-T	CM 1 6672H
143-DEG	MC 29 59137
1851(SINGLE)	MC 20 61851A2
3320(SINGLE)	MC 20 93320A3
3322(SINGLE)	MC 20 93322A3
480-MK	CM 20 6672P
480-MK	CM 20 6674P
480-MK-FW	CM 20 6672J P
480-MK-FW	CM 20 6674J P
7081-GH	CM 1 5972P
7087-MK	CM 20 9232P
7087-OR	CM 20 9225/6
7114B2	MC 1 87114
7234B	MC 1 77234
7235B	MC 1 77235
826GH	CM 1 6672P
826-MK-SS	CM 1 6677 SS P
8503A	MC 20 98504
8503-G0	MC47 27 87105

OSCO TO BARR (CONTINUED)

OSCO PART #	BARR PART #
8503-GB	MC47 27 41811
8503-GR	MC47 27 41813
9863-T	OMC 20 982680
992-G	1 0107
992-G-FW	1 0105
992MK	20 0082P
994-S3	20 0097
BG	1 0019
CV-GH	CHV 47 0000
CW994	CHVA 1 84
CW-GH	CHVA 47 0000
CY4 GH	CHV 47 0120
CY-MG	MC 1 6364G
F66CS	50 512 019
F68C9	50 525 020
F68CS	50 512 020
FL994	FM 1 83
MC552-BB	MC 29 90736
MC552-SB	MC 29 87290
MC553-SB	MC 29 78984
MC55-TBB	MC 29 47442
MC55-TSB	MC 29 47441
V0418	VO 1 855387

SIERRA TO BARR

SIERRA PART #	BARR PART #
18-0113	MC47 27 97542
18-0114	OMC47 907761
18-0183	MC47 27 73866
18-0332	MC47 27 35898
18-0335	MC47 27 39947
18-0353	MC47 27 58764
18-0356	MC47 27 64692
18-0364	MC47 27 73812
18-0418	MC47 27 46820
18-0672	MC47 27 41811
18-0872	MC47 27 33395
18-0885	MC47 27 48042
18-0897	MC47 27 41813
18-0903	MC47 27 49110
18-0928	MC47 27 73814
18-0943	OMC47 909786
18-0954	MC47 27 92720
18-0992	MC47 27 68715
18-1203	MC47 27 53354
18-1204	MC47 27 96429
18-1209	MC47 27 39917
18-1210	MC47 27 39923
18-1902	OMC 1 912441
18-1903	OMC 1 912442

Crossover Reference Guide

SIERRA TO BARR (CONTINUED)

SIERRA PART #	BARR PART #
18-1904	OMC 1 980959
18-1916	CR 20 97169
18-1919	CR 20 97387
18-1921	OMC 20 982680
18-1922	OMC 20 910380
18-1924	CR 20 97624
18-1927	CR 20 97772
18-1929	CR 1 97992
18-1930-1	VO 1 855387
18-1931-1	VO 1 835804
18-1933	CR 1 97993
18-1935-1	VO 20 855384
18-1940	CM 1 6677A
18-1941	CM 1 6672B
18-1945	CM 20 6674
18-1946	CM 20 6672
18-1950-1	MC 1 77234
18-1951-1	MC 1 77235
18-1952-1	MC 1 99746
18-1953	MC 1 87114
18-1954	MC 1 95862
18-1955	MC 1 96705
18-1956-1	MC 1 99798
18-1957	MC 1 89011
18-1958	MC 1 65604
18-1959	MC 1 63122
18-1960-1	MC 1 58759
18-1961	MC 1 52390
18-1962	MC 1 65603
18-1968	MC 29 47587
18-1969	MC 29 60372
18-1970-1	MC 20 98504
18-1971	MC 20 76351
18-1972	MC 20 76325
18-1973	MC 20 55538
18-1974-1	MC 20 98502
18-1975	MC 20 12076
18-1976-1	MC 20 44354
18-1977	MC 29 47441
18-1978	MC 20 76771
18-1983	CR 1 98243
18-1990	1 73813
18-1991	20 0089P
18-1992-1	20 0087P
18-1993	MC 29 78984
18-1994	MC 29 87290
18-1995	1 47368
18-1997-1	CHV 1 83
18-1998-1	FM 1 83
18-1999	20 0082
18-2104	MC 51 75832

SIERRA TO BARR (CONTINUED)

SIERRA PART #	BARR PART #
18-2146	MC 51 59830
18-2554	MC47 27 41812
18-2819	MC47 27 39915
18-2830	MC47 27 46401
18-2831	MC47 27 47590
18-2832	MC47 27 48043
18-2833	MC47 27 99777
18-2844	MC47 27 48818
18-2849	MC47 27 87105
18-2850	OMC47 908935
18-2854	1 0107
18-2859	OMC47 311131
18-2860	OMC47 311130
18-2861	OMC47 311121
18-2875	OMC47 908013
18-2883	OMC47 907775
18-2896	MC47 27 52546
18-2743	MC47 27 94996
18-2820	MC47 27 64818
18-2902	MC47 27 33395
18-2909	MC47 27 97757
18-2917	MC47 27 53045
18-2941	CM 1 6672D
18-2949	CHV47 0000
18-2971	VO47 835908
18-4008	MC 20 60207
18-4009	1 60252
18-4360	CM 1 6672B P
18-4363	FM 1 83P
18-4364	20 0082P
18-4367	MC47 27
18-4394	99777A1
18-4395	MC47 27
18-4396	33395A1
18-4397	MC47 27
18-4398	35898A4
18-4399	MC47 27
18-4461	46401A1

VOLVO TO BARR

VOLVO PART #	BARR PART #
824532-6	VO 1 824532
825599-4	VO 20 825599
834438-4	VO 1 855387
835804-6	VO 1 835804
855384-4	VO 20 855384
855387-7	VO 1 855387
856883-4	VO 1 835804
3857723	OMC 1 914034
3863031	OMC 20 913784

IT'S THE LAW - KNOW YOUR RIGHTS!

Consumers are protected from manufacturers who attempt to unfairly chain the purchasers of their products to the continued purchase of their maintenance and repair products and authorized services. Congress has provided consumers with this protection under the Magnuson-Moss Warranty Act as well as specific provisions of the Federal Trade Commission Improvement Act.

It's against the law for an original equipment manufacturer to inform consumers that their warranty would be void should they use other than genuine replacement parts or if service were to be preformed by anyone other than an authorized "OEM" dealer unless, of course, such parts and service were to be performed "Free of Charge" under the terms of the warranty.

The laws were enacted to grant the consumers and dealers the basic right to select replacement parts from competent manufacturers without fear of jeopardizing their warranty. The law directly provides the consumer the right of choice, the right to an affordable alternative choice of manufactured product. Of course, the original equipment manufacturer is not responsible for product failures or damages caused by product failures of product manufactured by others. Such damages become the responsibility of the company providing such products under the terms of their own warranties. Barr Marine by EDM originated the three-year limited warranty that has recently become the standard for all others to follow. Our warranty can be found in our catalog directly following this notice.

Barr Marine by EDM has been a manufacturer of Marine Engine Parts for seventy-three years. The company has and continues to manufacture marine engine parts for many of the original equipment manufacturers. For years, we have represented the affordable alternative choice for your needs. We thank you for your continued support!

BARR
MARINE BY EDM



THREE YEAR LIMITED WARRANTY

Three-year warranty on exhaust manifolds, risers and exhaust connectors manufactured by Barr Marine by EDM.

Unless specifically indicated otherwise, Barr Marine by EDM (“Manufacturer”) warrants this product against defects in workmanship and material for three years from date of purchase by the original purchaser to the extent that Manufacturer will, at its option, replace or repair the product or any part thereof which in Manufacturer’s judgment has such a defect, provided that written notice of such defect is received by Manufacturer at the address above within three years after date of purchase by the original purchaser. The Buyer shall return the product to Manufacturer, at Buyer’s expense to the address above. Manufacturer’s obligation does not include any cost of removal or reinstallation, and this warranty shall not apply if the product has been misused, abused, altered, neglected or improperly installed or repaired work by anyone other than the Manufacturer was a cause of the defect.

This Warranty does not extend to Barr Marine by EDM products used in racing or “high performance” applications. Any work done by others without notifying Barr Marine by EDM in advance of such performance and without written authorized shall automatically terminate buyer’s rights or remedies against seller.

The warranties set forth above are the sole express warranties made by manufacturer with respect to this product or any thereof.

Any implied warranties, including without limitation any warranties of fitness or of merchantability, are hereby expressly limited in duration to the three-year period of this warranty.

Some states do not allow limitations on how long an implied warranty lasts, so the above limitation may not apply to you.

This warranty does not extend to anyone other than the original purchaser.

Notwithstanding anything to the contrary herein contained, if this product is specifically excluded or used for commercial purposes, rental, or other income-producing activities, then the duration of this warranty shall be one year from the date of purchase.

Manufacturer reserves the right to improve its products through changes in design or materials without being obligated to incorporate such changes in products of prior manufacture and to make changes at any time in design, materials, or parts of products without obligation or liability to owners or products of prior manufacture.

Some states do not allow the exclusion or limitation of incidental or consequential damages, so the above limitation or exclusion may not apply to you.

This warranty gives you specific legal rights, and may also have other rights, which vary from state to state.



BARR
MARINE BY EDM



94

ONE YEAR LIMITED WARRANTY

One-year warranty on exhaust manifolds, risers and connectors manufactured by Barr Marine by EDM (except for exhaust manifolds, risers and exhaust connectors, which are covered by a three-year warranty) then the duration of this warranty shall be one year from date of purchase.

Unless specifically indicated otherwise, Barr Marine by EDM ("Manufacturer") warrants this product against defects in workmanship and material for one year from date of purchase by the original purchaser to the extent that Manufacturer will, at its option, replace or repair the product or any part thereof which in Manufacturer's judgment has such a defect, provided that written notice of such defect is received by Manufacturer at the address above within one year after date of purchase by the original purchaser. The Buyer shall return the product to Manufacturer, at Buyer's expense to the address above. Manufacturer's obligation does not include any cost of removal or reinstallation, and this warranty shall not apply if the product has been misused, abused, altered, neglected or improperly installed or repaired work by anyone other than the Manufacturer was a cause of the defect.

This Warranty does not extend to Barr Marine by EDM products used in racing or "high performance" applications. Any work done by others without notifying Barr Marine by EDM in advance of such performance and without written authorization shall automatically terminate buyer's rights or remedies against seller.

The warranties set forth above are the sole express warranties made by manufacturer with respect to this product or any thereof.

Any implied warranties, including without limitation any warranties of fitness or merchantability, are hereby expressly limited in duration to the one-year period of this warranty.

Some states do not allow limitations on how long an implied warranty lasts, so the above limitation may not apply to you.

This warranty does not extend to anyone other than the original purchaser.

Notwithstanding anything to the contrary herein contained, if this product is specifically excluded or used for commercial purposes, rental, or other income-producing activities, then the duration of this warranty shall be one year from date of purchase.

Manufacturer reserves the right to improve its products though changes in design or materials without being obligated to incorporate such changes in products of prior manufacture and to make changes at any time in design, materials, or parts of products without obligation or liability to owners of products of prior manufacture.

Some states do not allow the exclusion or limitation of incidental or consequential damages, so the above limitation or exclusion may not apply to you.

This warranty gives you specific legal rights, and you may also have other rights, which vary from state to state.

BARR
MARINE BY EDM