













makute[®]
PROFESSIONAL POWER TOOLS

makute[®]
PROFESSIONAL POWER TOOLS



-  Conformity with European
-  Double insulation
-  Variable speed
-  Forward&Reverse
-  Carrying case
-  Soft-start
-  Bit coupling
-  Bit coupling
-  3 functions hammer
-  Vario Lock:
for arbitrary chisel position
-  Drill/hammer
-  Automatic lubrication
-  Soft start



YONGKANG XIAOCHENG ELECTRIC APPLIANCE CO.,LTD
 ADD:68# Tengfei road xiangzhu industrial zone,yongkang city zhejiang province
 MOBILE:0086-13777535466(JASON) TEL:0086-579-87566667 FAX: 0086-579-87566687
 E-mail: export@makute.com

Continuous technological
innovation is the eternal
goal of makute

www.makute.com

HR **DuPont** **NOMEX** **C&U** **Mobil**



POWER TOOLS PROFESSIONAL

Supply high quality and competitive price products is our purpose, welcome you to contact us for more information and look forward to working with you!

makute[®]
PROFESSIONAL POWER TOOLS

m

“moral” we will keep our ethics and never produce inferior products.

a

“aspiring” we always strive to innovate.

k

“kind” that we will keep kind and friendly.

u

“unfailing” and we are always steadfast.

t

“thankful” we will be grateful to the market for the society.

e

“efficient” we will maintain efficiency and mutual benefit.



makute[®]
PROFESSIONAL POWER TOOLS

POWER TOOLS PROFESSIONAL

YONGKANG XIAOCHENG ELECTRIC APPLIANCE CO.,LTD

is one of the professional manufacturers of power tools,
which located in Yongkang, the hardware center of China
We have more than 10 years experience in R&D,
manufacturing and marketing for power tools.

We have advanced equipment, and skilled engineers and strong QC team,
which guarantee all products in the high quality.

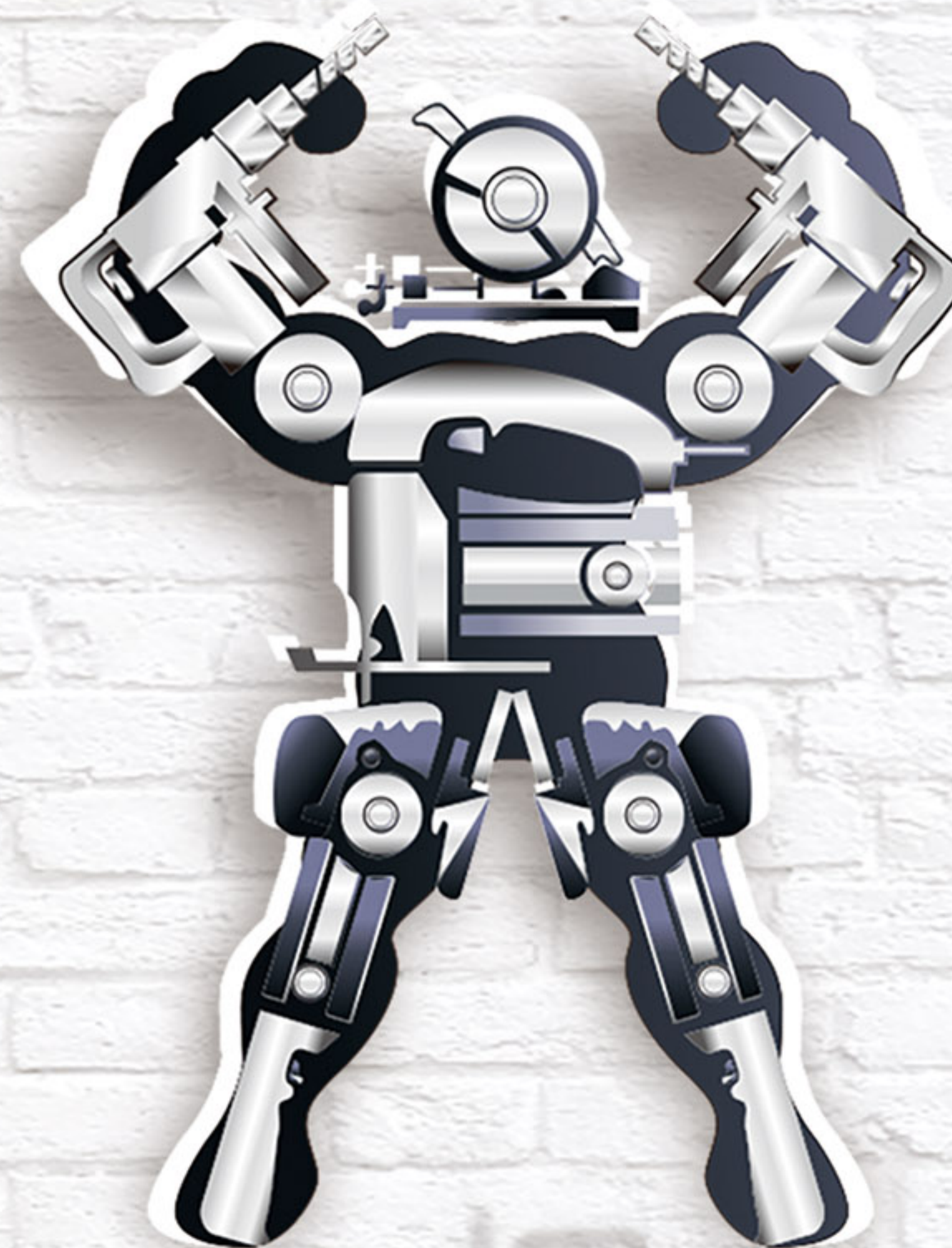

CONTENTS

Lithium Series	01
Impact Drill	07
Electric Drill	10
Angle Grinder	13
Car Polisher	21
Hammer Drill	23
Demolition Hammer	26
Die Grinder	28
Electric Planer	29
Circular Saw	31
Orbital Sander	31
Trimmer	31
Electric Router	32
Jig Saw	33
Portable Blower	35
Heat Gun	37
Electric Spray Gun	38
Cut Off Machine	39
Miter Saw	40
Marble Cutter	41
Concrete Vibrator	42
Wall Sander	42
Angle Grinder Stand	43
Impact Drill Stand	43
Electric Chain Saw	44
Gasoline Chain Saw	44
Brush Cutter	45
Optional Accessories	46



LITHIUM SERIES

Low / High Speed Change

Torque Regulation

Sanou Three-claw Type Keyless Chuck

Led Light

Variable Speed Switch

Battery Remove Button

Thermal Dissipation Window

Battery Status

Forward/Reverse Change

Slim Handle With Rubber

Lithium Battery



CORDLESS DRILL

- Two-gear mechanical speed regulation function
- One-button forward and backward adjustment conversion
- Double bearing structure, better concentricity
- Efficient heat sink can be used for a long time
- Electricity display, electricity at a glance



Model No.	CD026		CD027		
	12V	16V	12V	16V	20V
Battery Voltage:	12V	16V	12V	16V	20V
Max Torque:	23N·m	25N·m	23N·m	25N·m	30N·m
No Load Speed:	0-450/0-1450r/min		0-450/0-1450r/min		
Chuck Size:	0.8-10mm		0.8-10mm		
Color Box Size:	24.5x7.5x23.6cm		28.5x9.3x28.5cm		
G.W/n.w(Kgs):	21/19kg		24.4/22.4kg		
Case Pack:	10pcs		10pcs		
Packing Size:	57x39.5x25cm		64x48.5x30cm		

CORDLESS DRILL WITH SHAFT LOCK

- Two-gear mechanical speed regulation function
- One-button forward and backward adjustment conversion
- Double bearing structure, better concentricity
- Efficient heat sink can be used for a long time
- Electricity display, electricity at a glance



Model No.	CD026-L		CD027-L		
	12V	16V	12V	16V	20V
Battery Voltage:	12V	16V	12V	16V	20V
Max Torque:	23N·m	25N·m	23N·m	25N·m	30N·m
No Load Speed:	0-450/0-1450r/min		0-450/0-1450r/min		
Chuck Size:	0.8-10mm		0.8-10mm		
Color Box Size:	24.5x7.5x23.6cm		28.5x9.3x28.5cm		
G.W/n.w(Kgs):	21/19kg		24.4/22.4kg		
Case Pack:	10pcs		10pcs		
Packing Size:	57x39.5x25cm		64x48.5x30cm		

CORDLESS IMPACT DRILL

- Two-gear mechanical speed regulation function
- One-button forward and backward adjustment conversion
- Double bearing structure, better concentricity
- Efficient heat sink can be used for a long time
- Electricity display, electricity at a glance



Model No.	CD028		CD029		
	Battery Voltage:	12V	16V	12V	16V
Max Torque:	23N·m	25N·m	23N·m	25N·m	30N·m
No Load Speed:	0-450/0-1450r/min		0-450/0-1450r/min		
Chuck Size:	0.8-10mm		0.8-10mm		
Impact Rate:	22000ipm		22000ipm		
Color Box Size:	24.5x7.5x23.6cm		28.5x9.3x28.5cm		
G.W/n.w(Kgs):	21/19kg		24.4/22.4kg		
Case Pack:	10pcs		10pcs		
Packing Size:	57x39.5x25cm		64x48.5x30cm		

CORDLESS DRILL WITH SHAFT LOCK & QUICK CHANGE CHUCK

- Two-gear mechanical speed regulation function
- One-button forward and backward adjustment conversion
- Double bearing structure, better concentricity
- Efficient heat sink can be used for a long time
- Electricity display, electricity at a glance



Model No.	CD026-LX		CD027-LX		
	Battery Voltage:	12V	16V	12V	16V
Max Torque:	23N·m	25N·m	23N·m	25N·m	30N·m
No Load Speed:	0-450/0-1450r/min		0-450/0-1450r/min		
Chuck Size:	0.8-10mm		0.8-10mm		
Color Box Size:	24.5x7.5x23.6cm		28.5x9.3x28.5cm		
G.W/n.w(Kgs):	21/19kg		24.4/22.4kg		
Case Pack:	10pcs		10pcs		
Packing Size:	57x39.5x25cm		64x48.5x30cm		

CORDLESS IMPACT DRILL WITH SHAFT LOCK

- Two-gear mechanical speed regulation function
- One-button forward and backward adjustment conversion
- Double bearing structure, better concentricity
- Efficient heat sink can be used for a long time
- Electricity display, electricity at a glance



Model No.	CD028-L		CD029-L		
	Battery Voltage:	12V	16V	12V	16V
Max Torque:	23N·m	25N·m	23N·m	25N·m	30N·m
No Load Speed:	0-450/0-1450r/min		0-450/0-1450r/min		
Chuck Size:	0.8-10mm		0.8-10mm		
Impact Rate:	22000ipm		22000ipm		
Color Box Size:	24.5x7.5x23.6cm		28.5x9.3x28.5cm		
G.W/n.w(Kgs):	21/19kg		24.4/22.4kg		
Case Pack:	10pcs		10pcs		
Packing Size:	57x39.5x25cm		64x48.5x30cm		



20V CORDLESS WRENCH

MODEL NO: CW001

- It Has 320N.m Large Torque And High Efficiency
- High Strength Tungsten Steel Shaft, Durable
- Anti-lax And Self-listening, More Secure
- Fully Closed Controller, Better Dust-proof
- Diffusion Lighting, Large Area Of Illumination



DESCRIPTION	
Charging Voltage:	100V-240V
Frequency:	50/60Hz
Battery Voltage:	20V
Max Torque:	320N·m
No load speed:	0-2200r/min
Chuck Size:	
Color Box Size:	

SPECIFICATIONS	
G.W/N.W(KGS):	/
Case Pack:	/
20"GP:	/
Packing Size:	/



20V CORDLESS SCREWDRIVER

MODEL NO: CSD001

- It has 250N.M large torque and high efficiency
- The torsion of three gears can be adjusted
- High strength tungsten steel shaft, durable
- Anti-lax and self-listening, more secure
- All-aluminium head and shell is strong and durable



DESCRIPTION	
Charging Voltage:	100V-240V
Frequency:	50/60Hz
Battery Voltage:	20V
Max Torque:	280N·m
No Load Speed:	02800r/min
Chuck Size:	
Color Box Size:	

SPECIFICATIONS	
G.W/N.W(KGS):	/
Case Pack:	/
20"GP:	/
Packing Size:	/



20V CORDLESS HAMMER

MODEL NO: CHD001

- Brushless motors don't need replace carbon brushes
- Brushless wear is small, rare earth magnetism
- Low interference, stable and smooth operation
- Brushless pure copper motor without burning motor
- Pure ternary high-rate battery, safe and long life



DESCRIPTION	
Charging Voltage:	100V-240V
Frequency:	50/60Hz
Battery Voltage:	20V
Impact Frequency:	4700BPM
No Load Speed:	0-1000r/min
Cylinder Size:	26mm
Joule:	3J
Color Box Size:	37x11.3x33cm

SPECIFICATIONS	
G.W/N.W(KGS):	25/27kg
Case Pack:	4pcs
20"GP:	1600pcs
Packing Size:	47x39x34.5cm



20V CORDLESS ANGLE GRINDER

MODEL NO: CAG001

- High speed, high strength, no burning machine
- Individual electricity display, electricity at a glance
- Two gears speed one key adjustment, easy to operate
- Low interference, stable and smooth operation
- Pure ternary high-rate batteries are safe



DESCRIPTION	
Charging Voltage:	100V-240V
Frequency:	50/60Hz
Battery Voltage:	20V
No load speed:	0-4000-8000r/min
Disc Size:	100/115/125mm
Color Box Size:	

SPECIFICATIONS	
G.W/N.W(KGS):	/
Case Pack:	/
20"GP:	/
Packing Size:	/

12V RATCHET WRENCH

MODEL NO: CRW001

- Positive and negative inversions are loose and tight
- 45N.M large torque, more widely used
- Pure copper motor has more stable performance
- Pure ternary high-rate batteries are safe



DESCRIPTION	
Charging Voltage:	100V-240V
Frequency:	50/60Hz
Battery Voltage:	12V
Max Torque:	45N·m
No load speed:	0-250r/min
Chuck Size:	
Color Box Size:	

SPECIFICATIONS	
G.W/N.W(KGS):	/
Case Pack:	/
20"GP:	/
Packing Size:	/

20V CORDLESS BLOWER

MODEL NO: CPB001

- Widely used: furniture, factories, clubs, etc
- one-hand operation can be fast or slow
- Infinite speed regulation
- Blow and suck



DESCRIPTION	
Charging Voltage:	100V-240V
Frequency:	50/60Hz
Battery Voltage:	20V
No load speed:	0-2000r/min
Blower Rate:	2.3m³/min
Color Box Size:	

SPECIFICATIONS	
G.W/N.W(KGS):	/
Case Pack:	/
20"GP:	/
Packing Size:	/



12/16/20V CORDLESS RECIPROCATING SAW

MODEL NO: CRS001

- Pure copper motor has more stable performance
- Metal cutting, wood cutting, plastic cutting, etc
- High-performance batteries last longer
- Fast-loading locking chuck



DESCRIPTION	
Charging Voltage:	100V-240V
Frequency:	50/60Hz
Battery Voltage:	12/16/20V
Strokes Per Minute:	0-3000spm/m
Blower Rate:	
Color Box Size:	

SPECIFICATIONS	
G.W/N.W(KGS):	/
Case Pack:	/
20"GP:	/
Packing Size:	/



IMPACT DRILL



CB CE DuPont **NOMEX** Mobil



13MM IMPACT DRILL

MODEL NO: ID001

- Powerful Motor For High Durable Working
- High Performance Chuck
- Soft Grip Design For Comfortable Operation
- Variable Speed Switch With Forward And Reverse Function
- Multifunction Of Impact/drill/screw
- 360° rotate Handle



DESCRIPTION	
Voltage:	220-240V
Frequency:	50/60Hz
Power:	850W
No-load Speed:	0-2900r/min
Chuck Size:	13mm
Wood:	30mm
Concrete:	16mm
Steel:	13mm
Color Box Size:	29x7.5x28cm

SPECIFICATIONS	
G.W./N.W(KGS):	21/19kg
Case Pack:	10pcs
20"GP:	4430pcs
Carton Size:	58x40x30cm

CE DuPont **NOMEX** Mobil

13MM IMPACT DRILL

MODEL NO: ID002

- Powerful Motor For High Durable Working
- High Performance Chuck
- Soft Grip Design For Comfortable Operation
- Variable Speed Switch With Forward And Reverse Function
- Multifunction Of Impact/drill/screw
- 360° rotate Handle



DESCRIPTION	
Voltage:	220-240V
Frequency:	50/60Hz
Power:	780W
No-load Speed:	0-3000r/min
Chuck Size:	13mm
Wood:	30mm
Concrete:	16mm
Steel:	13mm
Color Box Size:	25.5x6.5x24.5cm

SPECIFICATIONS	
G.W./N.W(KGS):	24/23kg
Case Pack:	10pcs
20"GP:	5532pcs
Carton Size:	35.5x27x51cm

CE DuPont **NOMEX** Mobil

13MM IMPACT DRILL

MODEL NO: ID003

- Powerful Motor For High Durable Working
- High Performance Chuck
- Soft Grip Design For Comfortable Operation
- Variable Speed Switch With Forward And Reverse Function
- Multifunction Of Impact/drill/screw
- 360° rotate Handle



DESCRIPTION	
Voltage:	220-240V
Frequency:	50/60Hz
Power:	610W
No-load Speed:	0-2800r/min
Chuck Size:	13mm
Wood:	30mm
Concrete:	16mm
Steel:	13mm
Color Box Size:	29x7.5x24cm

SPECIFICATIONS	
G.W./N.W(KGS):	24/22kg
Case Pack:	10pcs
20"GP:	4600pcs
Carton Size:	60x39.5x25.5cm

DuPont **NOMEX** Mobil

13MM IMPACT DRILL

MODEL NO: ID003-X

- Powerful Motor For High Durable Working
- High Performance Chuck
- Soft Grip Design For Comfortable Operation
- Variable Speed Switch With Forward And Reverse Function
- Multifunction Of Impact/drill/screw
- 360° rotate Handle



DESCRIPTION	
Voltage:	220-240V
Frequency:	50/60Hz
Power:	710W
No-load Speed:	0-3000r/min
Chuck Size:	13mm
Wood:	30mm
Concrete:	16mm
Steel:	13mm
Color Box Size:	29x6.5x24cm

SPECIFICATIONS	
G.W/N.W(KGS):	21/19kg
Case Pack:	10pcs
20"GP:	4600pcs
Carton Size:	60x36.5x25.5cm



13MM IMPACT DRILL

MODEL NO: ID009

- Powerful Motor For High Durable Working
- High Performance Chuck
- Soft Grip Design For Comfortable Operation
- Variable Speed Switch With Forward And Reverse Function
- Multifunction Of Impact/drill/screw
- 360° rotate Handle



DESCRIPTION	
Voltage:	220-240V
Frequency:	50/60Hz
Power:	1020W
No-load Speed:	0-3200r/min
Chuck Size:	13mm
Wood:	30mm
Concrete:	16mm
Steel:	13mm
Color Box Size:	29.5x8.5x31cm

SPECIFICATIONS	
G.W/N.W(KGS):	14/13kg
Case Pack:	5pcs
20"GP:	3060pcs
Carton Size:	44.5x30.5x32.5cm



13MM IMPACT DRILL

MODEL NO: ID005

- Powerful Motor For High Durable Working
- High Performance Chuck
- Soft Grip Design For Comfortable Operation
- Variable Speed Switch With Forward And Reverse Function
- Multifunction Of Impact/drill/screw
- 360° rotate Handle



DESCRIPTION	
Voltage:	220-240V
Frequency:	50/60Hz
Power:	550W
No-load Speed:	0-3000r/min
Chuck Size:	13mm
Wood:	20mm
Concrete:	13mm
Steel:	10mm
Color Box Size:	25.5x7.5x25cm

SPECIFICATIONS	
G.W/N.W(KGS):	20/19kg
Case Pack:	10pcs
20"GP:	5090pcs
Carton Size:	39.5x27x52cm



6.5MM ELECTRIC DRILL

MODEL NO: ED001

- Powerful Motor For High Durable Working
- High Performance Chuck
- Soft Grip Design For Comfortable Operation
- Variable Speed Switch With Forward And Reverse Function
- Multifunction Of Impact/drill/screw
- 360° rotate Handle



DESCRIPTION	
Voltage:	220-240V
Frequency:	50/60Hz
Power:	260W
No-load Speed:	0-3600r/min
Chuck Size:	6.5mm
Wood:	15mm
Steel:	6.5mm
Color Box Size:	20x6.5x22cm

SPECIFICATIONS	
G.W/N.W(KGS):	13/12kg
Case Pack:	10pcs
20"GP:	7700pcs
Carton Size:	42x34x24cm



13MM IMPACT DRILL

MODEL NO: ID008

- Powerful Motor For High Durable Working
- High Performance Chuck
- Soft Grip Design For Comfortable Operation
- Variable Speed Switch With Forward And Reverse Function
- Multifunction Of Impact/drill/screw
- 360° rotate Handle



DESCRIPTION	
Voltage:	220-240V
Frequency:	50/60Hz
Power:	850W
No-load Speed:	0-2900r/min
Chuck Size:	13mm
Wood:	30mm
Concrete:	16mm
Steel:	13mm
Color Box Size:	29x7.5x28cm

SPECIFICATIONS	
G.W/N.W(KGS):	21/19kg
Case Pack:	10pcs
20"GP:	3880pcs
Carton Size:	40x30x58cm



10MM ELECTRIC DRILL

MODEL NO: ED002

- Powerful Motor For High Durable Working
- High Performance Chuck
- Soft Grip Design For Comfortable Operation
- Variable Speed Switch With Forward And Reverse Function
- Multifunction Of Impact/drill/screw
- 360° rotate Handle



DESCRIPTION	
Voltage:	220-240V
Frequency:	50/60Hz
Power:	550W
No-load Speed:	0-1200r/min
Chuck Size:	10mm
Wood:	15mm
Steel:	6.5mm
Color Box Size:	24.5x6.5x22.5cm

SPECIFICATIONS	
G.W/N.W(KGS):	17/16kg
Case Pack:	10pcs
20"GP:	7700pcs
Carton Size:	34.5x26x47cm



10MM ELECTRIC DRILL

MODEL NO: **ED003**

- Powerful Motor For High Efficient Working
- Clamp Key Ring For Convient Change
- Simple And Comfortable Trigger Switch
- Light Weight Smart Body Economic High Performance
- Variable Speed Switch With Forward And Reverse Function



DESCRIPTION	
Voltage:	220-240V
Frequency:	50/60Hz
Power:	450W
No-load Speed:	0-3000r/min
Chuck Size:	10mm
Wood:	15mm
Steel:	6.5mm
Color Box Size:	25.5x7x22.5cm

SPECIFICATIONS	
G.W/N.W(KGS):	16/15kg
Case Pack:	10pcs
20"GP:	5950pcs
Carton Size:	37x27x47cm



10MM ELECTRIC DRILL

MODEL NO: **ED011**

- Powerful Motor For High Efficient Working
- Clamp Key Ring For Convient Change
- Simple And Comfortable Trigger Switch
- Light Weight Smart Body Economic High Performance
- Variable Speed Switch With Forward And Reverse Function



DESCRIPTION	
Voltage:	220-240V
Frequency:	50/60Hz
Power:	280W
No-load Speed:	0-350/0-1100r/min
Chuck Size:	10mm
Wood:	15mm
Concrete:	6.5mm
Color Box Size:	24x7.5x23cm

SPECIFICATIONS	
G.W/N.W(KGS):	16/15kg
Case Pack:	10pcs
20"GP:	5476pcs
Carton Size:	50x39.5x25cm



10/13MM ELECTRIC DRILL

MODEL NO: **ED009**

- Powerful Motor For High Efficient Working
- Clamp Key Ring For Convient Change
- Simple And Comfortable Trigger Switch
- Light Weight Smart Body Economic High Performance
- Variable Speed Switch With Forward And Reverse Function



DESCRIPTION	
Voltage:	220-240V
Frequency:	50/60Hz
Power:	550W
No-load Speed:	0-3000r/min
Chuck Size:	10/13mm
Wood:	20mm
Concrete:	13mm
Steel:	10mm
Color Box Size:	29x8x26.5cm

SPECIFICATIONS	
G.W/N.W(KGS):	16/15kg
Case Pack:	10pcs
20"GP:	3900pcs
Carton Size:	42x30x55cm



10MM ELECTRIC DRILL

MODEL NO: **ED012**

- Powerful Motor For High Efficient Working
- Clamp Key Ring For Convient Change
- Simple And Comfortable Trigger Switch
- Light Weight Smart Body Economic High Performance
- Variable Speed Switch With Forward And Reverse Function



DESCRIPTION	
Voltage:	220-240V
Frequency:	50/60Hz
Power:	280W
No-load Speed:	0-750r/min
Chuck Size:	10mm
Wood:	15mm
Concrete:	6.5mm
Color Box Size:	24x7.5x23cm

SPECIFICATIONS	
G.W/N.W(KGS):	16/15kg
Case Pack:	10pcs
20"GP:	5476pcs
Carton Size:	50x39.5x25cm



10MM ELECTRIC DRILL

MODEL NO: **ED010**

- Powerful Motor For High Efficient Working
- Clamp Key Ring For Convient Change
- Simple And Comfortable Trigger Switch
- Light Weight Smart Body Economic High Performance
- Variable Speed Switch With Forward And Reverse Function



DESCRIPTION	
Voltage:	220-240V
Frequency:	50/60Hz
Power:	450W
No-load Speed:	0-3000r/min
Chuck Size:	10mm
Wood:	20mm
Concrete:	13mm
Color Box Size:	23.5x7x23cm

SPECIFICATIONS	
G.W/N.W(KGS):	16/15kg
Case Pack:	10pcs
20"GP:	5869pcs
Carton Size:	49x37.5x25cm



13/16MM ELECTRIC DRILL

MODEL NO: **ED006**

- Professional Drill Chuck With High Quality
- Sturdy And Durable Aluminum Body
- Comfortable Auxiliary Handle
- Carbon Brushes With High Quality
- Rotatable And Insulation Rear Handle
- Two Function Of Drill And Mix



DESCRIPTION	
Voltage:	220-240V
Frequency:	50/60Hz
Power:	1050W
No-load Speed:	800r/min
Chuck Size:	13/16mm
Wood:	30mm
Concrete:	16mm
Steel:	13mm
Color Box Size:	33x10.5x27.5cm

SPECIFICATIONS	
G.W/N.W(KGS):	20/18kg
Case Pack:	5pcs
20"GP:	2030pcs
Carton Size:	55x34.5x30cm



ANGLE GRINDER



100/115/125MM ANGLE GRINDER

- Unique Motor Design For Strong Performance
- 2-positions Soft Touch Side Handle
- Dustproof Design
- Multifunction Make Working High Efficiency
- Shaft Lock For Easy Wheel Change



Model No.	AG001	AG002	AG014
Voltage:	220-240V	220-240V	220-240V
Frequency:	50/60Hz	50/60Hz	50/60Hz
Power:	950W	950W	710W
No-load Speed:	11500r/min	11500r/min	11000r/min
Disc Size:	100/115/125mm	100/115/125mm	100/115/125mm
Spindle:	M10/M14	M10/M14	M10/M14
Color Box Size:	30.5x12.5x11cm	30.5x12.5x11cm	34x12x12cm
G.W/N.W(KGS):	24/22kg	25/23kg	23/21kg
Case Pack:	10pcs	10pcs	10pcs
20"GP:	4600pcs	4600pcs	4800pcs
Carton Size	65x32x24cm	65x32x24cm	62.5x36x26cm

115/125/150MM ANGLE GRINDER

- Unique Motor Design For Strong Performance
- 2-positions Soft Touch Side Handle
- Dustproof Design
- Multifunction Make Working High Efficiency
- Shaft Lock For Easy Wheel Change



Model No.	AG013	AG013-V
Voltage:	220-240V	220-240V
Frequency:	50/60Hz	50/60Hz
Power:	1350W	1350W
No-load Speed:	11000r/min	3000-11000r/min
Disc Size:	115/125/150mm	115/125/150mm
Spindle:	M14	M14
Color Box Size:	36x12x12cm	36x12x12cm
G.W/N.W(KGS):	23.5/21.5kg	23.5/21.5kg
Case Pack:	8pcs	8pcs
20"GP:	4372pcs	4372pcs
Carton Size	50x38x26cm	50x38x26cm

100/115/125MM ANGLE GRINDER



- Unique Motor Design For Strong Performance
- 2-positions Soft Touch Side Handle
- Dustproof Design
- Multifunction Make Working High Efficiency
- Shaft Lock For Easy Wheel Change



Model No.	AG016	AG016-S	AG016-L
Voltage:	220-240V	220-240V	220-240V
Frequency:	50/60Hz	50/60Hz	50/60Hz
Power:	850W	850W	850W
No-load Speed:	11000r/min	11000r/min	11000r/min
Disc Size:	100/115/125mm	100/115/125mm	100/115/125mm
Spindle:	M10/M14	M10/M14	M10/M14
Color Box Size:	33x12x11cm	33x12x11cm	40x12x11cm
G.W/N.W(KGS):	23/21kg	23/21kg	23.5/21.5kg
Case Pack:	10pcs	10pcs	10pcs
20"GP:	5190pcs	5190pcs	4570pcs
Carton Size	62x35x24cm	62x35x24cm	62x42x24cm

100/115/125MM ANGLE GRINDER



- Unique Motor Design For Strong Performance
- 2-positions Soft Touch Side Handle
- Dustproof Design
- Multifunction Make Working High Efficiency
- Shaft Lock For Easy Wheel Change



Model No.	AG116-N	AG126	AG126-S
Voltage:	220-240V	220-240V	220-240V
Frequency:	50/60Hz	50/60Hz	50/60Hz
Power:	850W	850W	850W
No-load Speed:	11000r/min	11000r/min	11000r/min
Disc Size:	100/115/125mm	100/115/125mm	100/115/125mm
Spindle:	M10/M14	M10/M14	M10/M14
Color Box Size:	33x12x11cm	33x12x11cm	40x12x11cm
G.W/N.W(KGS):	23/21kg	23/21kg	23.5/21.5kg
Case Pack:	10pcs	10pcs	10pcs
20"GP:	5190pcs	5190pcs	4570pcs
Carton Size	62x35x24cm	62x35x24cm	62x42x24cm

100/115/125MM ANGLE GRINDER



- Unique Motor Design For Strong Performance
- 2-positions Soft Touch Side Handle
- Dustproof Design
- Multifunction Make Working High Efficiency
- Shaft Lock For Easy Wheel Change



Model No.	AG008	AG008-B	AG008-A
Voltage:	220-240V	220-240V	220-240V
Frequency:	50/60Hz	50/60Hz	50/60Hz
Power:	680W	850W	1000W
No-load Speed:	11000r/min	11000r/min	10000r/min
Disc Size:	100/115/125mm	100/115/125mm	100/115/125mm
Spindle:	M10/M14	M10/M14	M10/M14
Color Box Size:	33x12x11cm	33x12x11cm	33x12x11cm
G.W/N.W(KGS):	23/21kg	23/21kg	23/21kg
Case Pack:	10pcs	10pcs	10pcs
20"GP:	5280pcs	5280pcs	5280pcs
Carton Size	62.5x35x24cm	62.5x35x24cm	62.5x35x24cm

100/115/125MM ANGLE GRINDER



- Unique Motor Design For Strong Performance
- 2-positions Soft Touch Side Handle
- Dustproof Design
- Multifunction Make Working High Efficiency
- Shaft Lock For Easy Wheel Change



Model No.	AG009	AG009-B	AG009-A
Voltage:	220-240V	220-240V	220-240V
Frequency:	50/60Hz	50/60Hz	50/60Hz
Power:	680W	850W	1000W
No-load Speed:	11000r/min	11000r/min	10000r/min
Disc Size:	100/115/125mm	100/115/125mm	100/115/125mm
Spindle:	M10/M14	M10/M14	M10/M14
Color Box Size:	33x12x11cm	33x12x11cm	33x12x11cm
G.W/N.W(KGS):	23/21kg	23/21kg	23/21kg
Case Pack:	10pcs	10pcs	10pcs
20"GP:	5280pcs	5280pcs	5280pcs
Carton Size	62.5x35x24cm	62.5x35x24cm	62.5x35x24cm

100/115/125MM ANGLE GRINDER

- Unique Motor Design For Strong Performance
- 2-positions Soft Touch Side Handle
- Dustproof Design
- Multifunction Make Working High Efficiency
- Shaft Lock For Easy Wheel Change



Model No.	AG007	AG010
Voltage:	220-240V	220-240V
Frequency:	50/60Hz	50/60Hz
Power:	1400W	1400W
No-load Speed:	10800r/min	800-10800r/min
Disc Size:	115/125mm	115/125mm
Spindle:	M10/M14	M10/M14
Color Box Size:	40.5x12.5x12cm	40.5x12.5x12cm
G.W/N.W(KGS):	28/26kg	29/27kg
Case Pack:	10pcs	10pcs
20"GP:	4050pcs	4100pcs
Carton Size	65x42x27cm	65x42x27cm



100/115/125MM ANGLE GRINDER

- Unique Motor Design For Strong Performance
- 2-positions Soft Touch Side Handle
- Dustproof Design
- Multifunction Make Working High Efficiency
- Shaft Lock For Easy Wheel Change



Model No.	AG005	AG005-V
Voltage:	220-240V	220-240V
Frequency:	50/60Hz	50/60Hz
Power:	1400W	1400W
No-load Speed:	10800r/min	10800r/min
Disc Size:	100/115/125mm	100/115/125mm
Spindle:	M10/M14	M10/M14
Color Box Size:	40.5x12.5x12cm	40.5x12.5x12cm
G.W/N.W(KGS):	28/26kg	28/26kg
Case Pack:	10pcs	10pcs
20"GP:	4050pcs	4050pcs
Carton Size	65x42x26cm	65x42x26cm

150MM ANGLE GRINDER

- Unique Motor Design For Strong Performance
- 2-positions Soft Touch Side Handle
- Dustproof Design
- Multifunction Make Working High Efficiency
- Shaft Lock For Easy Wheel Change



Model No.	AG015	AG015-A
Voltage:	220-240V	220-240V
Frequency:	50/60Hz	50/60Hz
Power:	1550W	1550W
No-load Speed:	800-10800r/min	9000r/min
Disc Size:	150mm	150mm
Spindle:	M14	M14
Color Box Size:	42x12.5x12cm	42x12.5x12cm
G.W/N.W(KGS):	28/26kg	29/27kg
Case Pack:	10pcs	10pcs
20"GP:	3700pcs	3700pcs
Carton Size	65x43.5x26cm	65x43.5x26cm

180MM ANGLE GRINDER

MODEL NO: **AG018**

- Unique Motor Design For Strong Performance
- 2-positions Soft Touch Side Handle
- Dustproof Design
- Multifunction Make Working High Efficiency
- Shaft Lock For Easy Wheel Change



DESCRIPTION	
Voltage:	220-240V
Frequency:	50/60Hz
Power:	1680W
No-load Speed:	8500r/min
Disc Size:	180mm
Spindle:	M14
Color Box Size:	46x14x14cm

SPECIFICATIONS	
G.W/N.W(KGS):	16/14kg
Case Pack:	4pcs
20"GP:	2500pcs
Carton Size:	48x30x30cm



180MM ANGLE GRINDER

MODEL NO: **AG018-A**

- Unique Motor Design For Strong Performance
- 2-positions Soft Touch Side Handle
- Dustproof Design
- Multifunction Make Working High Efficiency
- Shaft Lock For Easy Wheel Change



DESCRIPTION	
Voltage:	220-240V
Frequency:	50/60Hz
Power:	1750W
No-load Speed:	8500r/min
Disc Size:	180mm
Spindle:	M14
Color Box Size:	46x14x14cm

SPECIFICATIONS	
G.W/N.W(KGS):	17/15kg
Case Pack:	4pcs
20"GP:	2500pcs
Carton Size:	48x30x30cm



180/230MM ANGLE GRINDER

MODEL NO: **AG003**

- Unique Motor Design For Strong Performance
- 2-positions Soft Touch Side Handle
- Dustproof Design
- Multifunction Make Working High Efficiency
- Shaft Lock For Easy Wheel Change



DESCRIPTION	
Voltage:	220-240V
Frequency:	50/60Hz
Power:	2400W
No-load Speed:	8500/6000r/min
Disc Size:	180/230mm
Spindle:	M14
Color Box Size:	57.5x19x12.5cm

SPECIFICATIONS	
G.W/N.W(KGS):	25/23kg
Case Pack:	4pcs
20"GP:	1800pcs
Carton Size:	59x40.5x26.5cm



180/230MM ANGLE GRINDER

MODEL NO: **AG012**

- Unique Motor Design For Strong Performance
- 2-positions Soft Touch Side Handle
- Dustproof Design
- Multifunction Make Working High Efficiency
- Shaft Lock For Easy Wheel Change



DESCRIPTION	
Voltage:	220-240V
Frequency:	50/60Hz
Power:	2600W
No-load Speed:	8500/6500r/min
Disc Size:	180/230mm
Spindle:	M14
Color Box Size:	57.5x19x12.5cm

SPECIFICATIONS	
G.W/N.W(KGS):	26/24kg
Case Pack:	4pcs
20"GP:	1800pcs
Carton Size:	59x39.5x27cm



180/230MM ANGLE GRINDER

MODEL NO: **AG026**

- Unique Motor Design For Strong Performance
- 2-positions Soft Touch Side Handle
- Dustproof Design
- Multifunction Make Working High Efficiency
- Shaft Lock For Easy Wheel Change



DESCRIPTION	
Voltage:	220-240V
Frequency:	50/60Hz
Power:	2400W
No-load Speed:	8500/6500r/min
Disc Size:	180/230mm
Spindle:	M14
Color Box Size:	57.5x19x12.5cm

SPECIFICATIONS	
G.W/N.W(KGS):	26/24kg
Case Pack:	4pcs
20"GP:	1800pcs
Carton Size:	59x40.5x27.5cm



180/230MM ANGLE GRINDER

MODEL NO: **AG029**

- Unique Motor Design For Strong Performance
- 2-positions Soft Touch Side Handle
- Dustproof Design
- Multifunction Make Working High Efficiency
- Shaft Lock For Easy Wheel Change



DESCRIPTION	
Voltage:	220-240V
Frequency:	50/60Hz
Power:	2600W
No-load Speed:	8500/6500r/min
Disc Size:	180/230mm
Spindle:	M14
Color Box Size:	57.5x19x12.5cm

SPECIFICATIONS	
G.W/N.W(KGS):	27/25kg
Case Pack:	4pcs
20"GP:	1800pcs
Carton Size:	59x40.5x26.5cm



CAR POLISHER



CE RoHS DuPont **NOMEX** Mobil

100-150MM CAR POLISHER

MODEL NO: CP005

- Powerful Motor Strong Performance
- Dustproof Design
- Variable Speed Control For High Efficiency
- Light Weigh Optimization Handle For Easy Operation
- High Wearable And Low Noise



DESCRIPTION	
Voltage:	220-240V
Frequency:	50/60Hz
Power:	780W
No-load Speed:	1500-5500r/min
Disc Size:	100-150mm
Spindle:	M14
Color Box Size:	37X14X14cm

SPECIFICATIONS	
G.W/N.W(KGS):	17/16kg
Case Pack:	6pcs
20"GP:	3168pcs
Carton Size:	44x39x30cm

CE RoHS DuPont **NOMEX** Mobil

180MM CAR POLISHER

MODEL NO: CP001

- Powerful Motor Strong Performance
- Dustproof Design
- Variable Speed Control For High Efficiency
- Light Weigh Optimization Handle For Easy Operation
- High Wearable And Low Noise



DESCRIPTION	
Voltage:	220-240V
Frequency:	50/60Hz
Power:	1300W
No-load Speed:	600-3000r/min
Disc Size:	180mm
Spindle:	M14
Color Box Size:	46x16x14cm

SPECIFICATIONS	
G.W/N.W(KGS):	15/13kg
Case Pack:	4pcs
20"GP:	1800pcs
Carton Size:	48x34x30cm

CE RoHS DuPont **NOMEX** Mobil

180MM CAR POLISHER

MODEL NO: CP003

- Powerful Motor Strong Performance
- Dustproof Design
- Variable Speed Control For High Efficiency
- Light Weigh Optimization Handle For Easy Operation
- High Wearable And Low Noise



DESCRIPTION	
Voltage:	220-240V
Frequency:	50/60Hz
Power:	1600W
No-load Speed:	600-3000r/min
Disc Size:	180mm
Spindle:	M14
Color Box Size:	48x16x16cm

SPECIFICATIONS	
G.W/N.W(KGS):	17/15kg
Case Pack:	4pcs
20"GP:	1500pcs
Carton Size:	50x34x34cm

CE RoHS DuPont **NOMEX** Mobil

180MM CAR POLISHER

MODEL NO: CP006

- Powerful Motor Strong Performance
- Dustproof Design
- Variable Speed Control For High Efficiency
- Light Weigh Optimization Handle For Easy Operation
- High Wearable And Low Noise



DESCRIPTION	
Voltage:	220-240V
Frequency:	50/60Hz
Power:	1680W
No-load Speed:	600-3000r/min
Disc Size:	180mm
Spindle:	M14
Color Box Size:	55x18x12cm

SPECIFICATIONS	
G.W/N.W(KGS):	15/13.5kg
Case Pack:	4pcs
20"GP:	1960pcs
Carton Size:	56x38x26cm

CE RoHS DuPont **NOMEX** Mobil

HAMMER DRILL



CE RoHS SDS PLUS DuPont **NOMEX C&U. Mobil**



26MM HAMMER DRILL

MODEL NO: **HD001**

- Industry Heavy Duty Performance
- Three Functions Easily Convert Design
- Forward And Reverse Switch Function
- Locking Button Design For Continuous Drilling
- Soft Grip Handle Reduces Work Fatigue



DESCRIPTION	
Voltage:	220-240V
Frequency:	50/60Hz
Power:	800W
Joule:	3J
No-load Speed:	0-900r/min
Cylinder Size:	26mm
Color Box Size:	43x11x31cm

SPECIFICATIONS	
G.W./N.W(KGS):	26.7/24.7kg
Case Pack:	5pcs
20"GP:	1480pcs
Carton Size:	57x44.5x32cm

CE RoHS SDS PLUS DuPont **NOMEX C&U. Mobil**

24MM HAMMER DRILL

MODEL NO: **HD003**

- Industry Heavy Duty Performance
- Three Functions Easily Convert Design
- Forward And Reverse Switch Function
- Locking Button Design For Continuous Drilling
- Soft Grip Handle Reduces Work Fatigue



DESCRIPTION	
Voltage:	220-240V
Frequency:	50/60Hz
Power:	620W
Joule:	2.5J
No-load Speed:	0-870r/min
Cylinder Size:	24mm
Color Box Size:	43x11x31cm

SPECIFICATIONS	
G.W./N.W(KGS):	26/24kg
Case Pack:	5pcs
20"GP:	1480pcs
Carton Size:	60x46x33cm

CE RoHS SDS PLUS DuPont **NOMEX Mobil**

32MM HAMMER DRILL

MODEL NO: **HD012**

- Industry Heavy Duty Performance
- Three Functions Easily Convert Design
- Forward And Reverse Switch Function
- Locking Button Design For Continuous Drilling
- Soft Grip Handle Reduces Work Fatigue



DESCRIPTION	
Voltage:	220-240V
Frequency:	50/60Hz
Power:	1050W
Joule:	5J
No-load Speed:	0-3150r/min
Cylinder Size:	32mm
Color Box Size:	40x12.8x35.6cm

SPECIFICATIONS	
G.W./N.W(KGS):	17/16kg
Case Pack:	2pcs
20"GP:	1150pcs
Carton Size:	45x28x38.5cm

CE RoHS SDS PLUS DuPont **NOMEX Mobil**

38MM HAMMER DRILL

MODEL NO: **HD018**

- Industry Heavy Duty Performance
- Three Functions Easily Convert Design
- Forward And Reverse Switch Function
- Locking Button Design For Continuous Drilling
- Soft Grip Handle Reduces Work Fatigue



DESCRIPTION	
Voltage:	220-240V
Frequency:	50/60Hz
Power:	1200W
Joule:	6J
No-load Speed:	500r/min
Cylinder Size:	38mm
Color Box Size:	42.5x15x38cm

SPECIFICATIONS	
G.W/N.W(KGS):	23/22.5kg
Case Pack:	2pcs
20"GP:	920pcs
Carton Size:	49x31x41.5cm



26MM HAMMER DRILL

MODEL NO: **HD019**

- Industry Heavy Duty Performance
- Three Functions Easily Convert Design
- Forward And Reverse Switch Function
- Locking Button Design For Continuous Drilling
- Soft Grip Handle Reduces Work Fatigue



DESCRIPTION	
Voltage:	220-240V
Frequency:	50/60Hz
Power:	900W
Joule:	5J
No-load Speed:	850r/min
Cylinder Size:	26mm
Color Box Size:	42x12x37cm

SPECIFICATIONS	
G.W/N.W(KGS):	23/21kg
Case Pack:	3pcs
20"GP:	1150pcs
Carton Size:	43x38x36cm



32MM HAMMER DRILL

MODEL NO: **HD32**

- Industry Heavy Duty Performance
- Three Functions Easily Convert Design
- Forward And Reverse Switch Function
- Locking Button Design For Continuous Drilling
- Soft Grip Handle Reduces Work Fatigue



DESCRIPTION	
Voltage:	220-240V
Frequency:	50/60Hz
Power:	1200W
Joule:	6J
No-load Speed:	4000r/min
Cylinder Size:	32mm
Color Box Size:	45x13x34.5cm

SPECIFICATIONS	
G.W/N.W(KGS):	24/22kg
Case Pack:	3pcs
20"GP:	1265pcs
Carton Size:	47x41x36.5cm



35MM DEMOLITION HAMMER

MODEL NO: **DH35**

- Industry Heavy Duty Performance
- Three Functions Easily Convert Design
- Forward And Reverse Switch Function
- Locking Button Design For Continuous Drilling
- Soft Grip Handle Reduces Work Fatigue



DESCRIPTION	
Voltage:	220-240V
Frequency:	50/60Hz
Power:	1900W
Joule:	15J
No-load Speed:	3800r/min
Cylinder Size:	35mm
Color Box Size:	53.5x13x37cm

SPECIFICATIONS	
G.W/N.W(KGS):	20/18kg
Case Pack:	2pcs
20"GP:	982pcs
Carton Size:	54.5x28x36cm



35MM DEMOLITION HAMMER

MODEL NO: **DH35-A**

- Industry Heavy Duty Performance
- Three Functions Easily Convert Design
- Forward And Reverse Switch Function
- Locking Button Design For Continuous Drilling
- Soft Grip Handle Reduces Work Fatigue



DESCRIPTION	
Voltage:	220-240V
Frequency:	50/60Hz
Power:	1600W
Joule:	12J
No-load Speed:	3800r/min
Cylinder Size:	35mm
Color Box Size:	51x12.5x33.5cm

SPECIFICATIONS	
G.W/N.W(KGS):	19/17kg
Case Pack:	2pcs
20"GP:	1150pcs
Carton Size:	52.5x27x35.5cm



65MM DEMOLITION HAMMER

MODEL NO: **DH65**

- Strong Power Make Working Easily And Effectively
- 360 Degree Rotation Auxiliary Handle Apply For Multi Angle Operation
- Convenient And Quick Change For The Carbon Brush



DESCRIPTION	
Voltage:	220-240V
Frequency:	50/60Hz
Power:	2200W
Joule:	45J
No-load Speed:	1500r/min
Hammer rate:	4000r/min
Cylinder Size:	65mm
Color Box Size:	69.2x16.5x29cm

SPECIFICATIONS	
G.W/N.W(KGS):	22/20kg
Case Pack:	1pcs
20"GP:	718pcs
Carton Size:	71.5x17x31cm



85MM DEMOLITION HAMMER

MODEL NO: **DH85**

- Strong Power Make Working Easily And Effectively
- 360 Degree Rotation Auxiliary Handle Apply For Multi Angle Operation
- Convenient And Quick Change For The Carbon Brush



DESCRIPTION	
Voltage:	220-240V
Frequency:	50/60Hz
Power:	2800W
Joule:	48J
No-load Speed:	1400r/min
Hammer rate:	4000r/min
Cylinder Size:	85mm
Color Box Size:	69.2x16.5x29cm

SPECIFICATIONS	
G.W/N.W(KGS):	23/21kg
Case Pack:	1pcs
20"GP:	718pcs
Carton Size:	71.5x17x31cm



3MM DIE GRINDER

MODEL NO: **DG002**

- Powerful Motor Strong Performance
- Precision Chuck For Durable Performance
- Variable Speed Control For High Efficiency
- Unique Heat Dissipation Design
- Slim Body For Comfortable Handle
- External Carbon Brush Design Easy For Change



DESCRIPTION	
Voltage:	220-240V
Frequency:	50/60Hz
Power:	350W
No-load Speed:	0-30000r/min
Chuck Size:	3mm

SPECIFICATIONS	
G.W/N.W(KGS):	18/17kg
Case Pack:	10pcs
20"GP:	13920pcs
Carton Size:	70x34x30cm

6MM DIE GRINDER

MODEL NO: **DG003**

- Powerful Motor Strong Performance
- Precision Chuck For Durable Performance
- Variable Speed Control For High Efficiency
- Unique Heat Dissipation Design
- Slim Body For Comfortable Handle
- External Carbon Brush Design Easy For Change



DESCRIPTION	
Voltage:	220-240V
Frequency:	50/60Hz
Power:	400W
No-load Speed:	0-26000r/min
Chuck Size:	6mm

SPECIFICATIONS	
G.W/N.W(KGS):	22/20kg
Case Pack:	20pcs
20"GP:	9400pcs
Carton Size:	52x33x35cm

6MM DIE GRINDER

MODEL NO: **DG004**

- Powerful Motor Strong Performance
- Precision Chuck For Durable Performance
- Variable Speed Control For High Efficiency
- Unique Heat Dissipation Design
- Slim Body For Comfortable Handle
- External Carbon Brush Design Easy For Change



DESCRIPTION	
Voltage:	220-240V
Frequency:	50/60Hz
Power:	600W
No-load Speed:	0-20000r/min
Chuck Size:	6mm

SPECIFICATIONS	
G.W/N.W(KGS):	20/18kg
Case Pack:	10pcs
20"GP:	7140pcs
Carton Size:	52x41.5x18.5cm

6MM DIE GRINDER

MODEL NO: **DG012**

- Powerful Motor Strong Performance
- Precision Chuck For Durable Performance
- Variable Speed Control For High Efficiency
- Unique Heat Dissipation Design
- Slim Body For Comfortable Handle
- External Carbon Brush Design Easy For Change



DESCRIPTION	
Voltage:	220-240V
Frequency:	50/60Hz
Power:	500W
No-load Speed:	0-30000r/min
Chuck Size:	3mm

SPECIFICATIONS	
G.W/N.W(KGS):	19/17kg
Case Pack:	10pcs
20"GP:	4580pcs
Carton Size:	58.5x39.5x25.5cm

ELECTRIC PLANER



CE DuPont **NOMEX**



ELECTRIC PLANER

MODEL NO: **EP003**

- High power for more efficiency working
- High-density aluminum board
- Safe and comfortable self-locking switch
- Free adjustment planing depth design
- High strength carbon steel double rolling blade
- High toughness conveyor belt design



DESCRIPTION	
Voltage:	220-240V
Frequency:	50/60Hz
Power:	600W
No-load Speed:	16000r/min
Max Planing Depth:	1mm
Max Planing Width:	82mm
Color Box Size:	29.5x16.5x18.5cm

SPECIFICATIONS	
G.W/N.W(KGS):	19/18kg
Case Pack:	6pcs
20"GP:	2433pcs
Carton Size:	52x32x40cm

CE DuPont **NOMEX**

ELECTRIC PLANER

MODEL NO: **EP005**

- High power for more efficiency working
- High-density aluminum board
- Safe and comfortable self-locking switch
- Free adjustment planing depth design
- High strength carbon steel double rolling blade
- High toughness conveyor belt design



DESCRIPTION	
Voltage:	220-240V
Frequency:	50/60Hz
Power:	560W
No-load Speed:	16000r/min
Max Planing Depth:	1mm
Max Planing Width:	82mm
Color Box Size:	31.5x17.5x18cm

SPECIFICATIONS	
G.W/N.W(KGS):	13/12kg
Case Pack:	4pcs
20"GP:	pcs
Carton Size:	37x33x38cm

CE DuPont **NOMEX**

ELECTRIC PLANER

MODEL NO: **EP006**

- High power for more efficiency working
- High-density aluminum board
- Safe and comfortable self-locking switch
- Free adjustment planing depth design
- High strength carbon steel double rolling blade
- High toughness conveyor belt design



DESCRIPTION	
Voltage:	220-240V
Frequency:	50/60Hz
Power:	650W
No-load Speed:	16000r/min
Max Planing Depth:	2mm
Max Planing Width:	82mm
Color Box Size:	32x19x18cm

SPECIFICATIONS	
G.W/N.W(KGS):	20/19kg
Case Pack:	4pcs
20"GP:	pcs
Carton Size:	40x33.5x38cm

CE DuPont **NOMEX**

185MM CIRCULAR SAW

MODEL NO: **CS003**

- Unique Environmental-friendly Exit For Dust
- Adjustable Cutting Depth
- Big Switch And Safety Button
- Suitable For Cutting All Kinds Of Wood



DESCRIPTION	
Voltage:	220-240V
Frequency:	50/60Hz
Power:	1380W
No-load Speed:	5300r/min
Blade Size:	185mm
Color Box Size:	31.5x22.5x19cm

SPECIFICATIONS	
G.W/N.W(KGS):	18/16kg
Case Pack:	4pcs
20"GP:	1784pcs
Carton Size:	46.5x33x39.5cm



185MM CIRCULAR SAW

MODEL NO: **CS004**

- Unique Environmental-friendly Exit For Dust
- Adjustable Cutting Depth
- Big Switch And Safety Button
- Suitable For Cutting All Kinds Of Wood



DESCRIPTION	
Voltage:	220-240V
Frequency:	50/60Hz
Power:	2200W
No-load Speed:	4100r/min
Blade Size:	235mm
Color Box Size:	38.5x27.5x21.5cm

SPECIFICATIONS	
G.W/N.W(KGS):	13/12kg
Case Pack:	2pcs
20"GP:	1038pcs
Carton Size:	56.5x40x23cm



ORBITAL SANDER

MODEL NO: **OS002**

- Strong Motor With Low Vibration
- Succinct Durable Clamping System
- Sturdy And Durable Aluminum Bottom
- Self-locking Push Switch



DESCRIPTION	
Voltage:	220-240V
Frequency:	50/60Hz
Power:	480W
No-load Speed:	14000r/min
Pad Size:	93x185mm
Color Box Size:	27.5x10x16cm

SPECIFICATIONS	
G.W/N.W(KGS):	21/19kg
Case Pack:	10pcs
20"GP:	4800pcs
Carton Size:	52x29x33.5cm



6MM TRIMMER

MODEL NO: **TR001**

- Accurate Concentricity
- Good Guiding Performance
- Transparent Bottom
- Full Control Operation
- Conveniently Replacing External Carbon Brushes



DESCRIPTION	
Voltage:	220-240V
Frequency:	50/60Hz
Power:	580W
No-load Speed:	30000r/min
Chuck Size:	6mm
Color Box Size:	23x15x10cm

SPECIFICATIONS	
G.W/N.W(KGS):	16/15kg
Case Pack:	8pcs
20"GP:	6480pcs
Carton Size:	47.5x31.5x22cm



12/8MM ELECTRIC ROUTER

MODEL NO: **ER001**

- Powerful Motor For More Efficiency Working
- Precise Positioning Design
- All Ball Bearing Construction For Long Tool Life
- Shaft Lock For Quick And Easy Bit Changes
- Base Lift Control Knob Design For Easy Operation
- External Carbon Brush Design Easy For Change



DESCRIPTION	
Voltage:	220-240V
Frequency:	50/60Hz
Power:	2100W
No-load Speed:	24000r/min
Chuck Size:	12mm
Color Box Size:	31x21.5x31cm

SPECIFICATIONS	
G.W/N.W(KGS):	22/20kg
Case Pack:	3pcs
20"GP:	1161pcs
Carton Size:	66x32.5x32.5cm



12/8MM ELECTRIC ROUTER

MODEL NO: **ER002**

- Powerful Motor For More Efficiency Working
- Precise Positioning Design
- All Ball Bearing Construction For Long Tool Life
- Shaft Lock For Quick And Easy Bit Changes
- Base Lift Control Knob Design For Easy Operation
- External Carbon Brush Design Easy For Change



DESCRIPTION	
Voltage:	220-240V
Frequency:	50/60Hz
Power:	2200W
No-load Speed:	6000-22000r/min
Chuck Size:	8/12mm
Color Box Size:	31x17.5x29cm

SPECIFICATIONS	
G.W/N.W(KGS):	13/12kg
Case Pack:	2pcs
20"GP:	1470pcs
Carton Size:	37x32x31cm



8MM ELECTRIC ROUTER

MODEL NO: **ER003**

- Powerful Motor For More Efficiency Working
- Precise Positioning Design
- All Ball Bearing Construction For Long Tool Life
- Shaft Lock For Quick And Easy Bit Changes
- Base Lift Control Knob Design For Easy Operation
- External Carbon Brush Design Easy For Change



DESCRIPTION	
Voltage:	220-240V
Frequency:	50/60Hz
Power:	1200W
No-load Speed:	15000-34000r/min
Chuck Size:	8mm
Color Box Size:	27x16x26cm

SPECIFICATIONS	
G.W/N.W(KGS):	17/16kg
Case Pack:	4pcs
20"GP:	2152pcs
Carton Size:	66x28x28cm



JIG SAW



55MM JIG SAW

MODEL NO: **JS011**

- Multi Directions Cutting
- Chosen By Quality Parts For Long Life Use
- Easy And Quick Change Of Chuck Set



DESCRIPTION	
Voltage:	220-240V
Frequency:	50/60Hz
Power:	450W
No-load Speed:	3000r/min
Capacity Wood:	55mm
Capacity Steel:	6mm
Color Box Size:	22.5x8.2x22.5cm

SPECIFICATIONS	
G.W./N.W(KGS):	18/17kg
Case Pack:	10pcs
20"GP:	6000pcs
Carton Size:	47x44.5x24cm

65MM JIG SAW

MODEL NO: **JS012**

- Power Supply Self-locking To Relieve Working Pressure
- Laser Guide For More Accurate Cutting
- Third Level Blade Adjustment Function
- Multi Directions Cutting
- Quick Installation Chuck Device



DESCRIPTION	
Voltage:	220-240V
Frequency:	50/60Hz
Power:	710W
No-load Speed:	0-3000r/min
Capacity Wood:	65mm
Capacity Steel:	6mm
Length of Stroke:	26mm
Color Box Size:	26x8x22cm

SPECIFICATIONS	
G.W./N.W(KGS):	21/19kg
Case Pack:	10pcs
20"GP:	664pcs
Carton Size:	55x42.5x24cm

65MM JIG SAW

MODEL NO: **JS015**

- Power Supply Self-locking To Relieve Working Pressure
- Laser Guide For More Accurate Cutting
- Third Level Blade Adjustment Function
- Multi Directions Cutting
- Quick Installation Chuck Device



DESCRIPTION	
Voltage:	220-240V
Frequency:	50/60Hz
Power:	500W
No-load Speed:	500-3000r/min
Capacity Wood:	65mm
Capacity Steel:	10mm
Color Box Size:	35.5x10.5x31cm

SPECIFICATIONS	
G.W./N.W(KGS):	19/18kg
Case Pack:	5pcs
20"GP:	2030pcs
Carton Size:	54.5x37x33cm





PORTABLE BLOWER

MODEL NO: PB001

- Portability And Flexibility Operation
- Blower And Aspirate Function Fit For Multi Applications
- Convenient And Quick Change For The Carbon Brush
- Can Clean Dust By Blowing And Extracting With Great Wind.
- Variable Speed Control



DESCRIPTION	
Voltage:	220-240V
Frequency:	50/60Hz
Power:	800W
No-load Speed:	0-13000r/min
Blower Rate:	3.8m³/min
Color Box Size:	37.5x25x20.5cm

SPECIFICATIONS	
G.W/N.W(KGS):	13/12kg
Case Pack:	4pcs
20"GP:	1300pcs
Carton Size:	52x39.5x43cm



PORTABLE BLOWER

MODEL NO: PB005

- Pure Copper Motor With Big Power
- Suction And Blowing With Easy Operation
- Strengthened Wind & Sturdy And Durable
- Comfortable Auxiliary Handle
- Simple Switch Lock System
- Optimized Fan Shell Design



DESCRIPTION	
Voltage:	220-240V
Frequency:	50/60Hz
Power:	650W
No-load Speed:	0-13000r/min
Blower Rate:	3.2m³/min
Color Box Size:	30.2x19.3x18.5cm

SPECIFICATIONS	
G.W/N.W(KGS):	14/12kg
Case Pack:	6pcs
20"GP:	2250pcs
Carton Size:	60x31x40cm



PORTABLE BLOWER

MODEL NO: PB004

- Portability And Flexibility Operation
- Blower And Aspirate Function Fit For Multi Applications
- Convenient And Quick Change For The Carbon Brush



DESCRIPTION	
Voltage:	220-240V
Frequency:	50/60Hz
Power:	600W
No-load Speed:	13000r/min
Blower Rate:	2.3m³/min
Color Box Size:	23.5x17.5x17.5cm

SPECIFICATIONS	
G.W/N.W(KGS):	17/16kg
Case Pack:	12pcs
20"GP:	2362pcs
Carton Size:	54x49x37cm



PORTABLE BLOWER

MODEL NO: PB006

- Pure Copper Motor With Big Power
- Suction And Blowing With Easy Operation
- Strengthened Wind & Sturdy And Durable
- Comfortable Auxiliary Handle
- Simple Switch Lock System
- Optimized Fan Shell Design



DESCRIPTION	
Voltage:	220-240V
Frequency:	50/60Hz
Power:	600W
No-load Speed:	100-13000r/min
Blower Rate:	2.3m³/min
Color Box Size:	23.5x17.5x17.5cm

SPECIFICATIONS	
G.W/N.W(KGS):	17/16kg
Case Pack:	12pcs
20"GP:	2362pcs
Carton Size:	54x49x37cm



PORTABLE BLOWER

MODEL NO: PB007

- Pure Copper Motor With Big Power
- Suction And Blowing With Easy Operation
- Strengthened Wind & Sturdy And Durable
- Comfortable Auxiliary Handle
- Simple Switch Lock System
- Optimized Fan Shell Design



Variable speed control by dial
PB007-V

DESCRIPTION	
Voltage:	220-240V
Frequency:	50/60Hz
Power:	600W
No-load Speed:	13000r/min
Blower Rate:	2.3m³/min
Color Box Size:	23.5x17.5x17.5cm

SPECIFICATIONS	
G.W/N.W(KGS):	18/17kg
Case Pack:	12pcs
20"GP:	6480pcs
Carton Size:	54x49x37cm



HEAT GUN

MODEL NO: HG001

- High Quality High Temperature Resistant Insulation Heating Wire
- Energy-saving Insulation Saves Energy
- High-power Turbo Fan For Stronger Air Supply
- With High Temperature Protection Cover
- Lattice Wind Mouth



DESCRIPTION	
Voltage:	220-240V
Frequency:	50/60Hz
Input Power:	1800W
Temperature:	I:50°C II:450°C III:550°C
Air Flow:	I:250L/M II:250L/M III:500L/M
Continue Use:	500 hours
Color Box Size:	26.5x9.2x26.8cm

SPECIFICATIONS	
G.W/N.W(KGS):	8.2/7.5kg
Case Pack:	8pcs
20"GP:	3600pcs
Carton Size:	54.5x38.8x28.8cm



HEAT GUN

MODEL NO: HG002

- High Quality High Temperature Resistant Insulation Heating Wire
- Energy-saving Insulation Saves Energy
- High-power Turbo Fan For Stronger Air Supply
- With High Temperature Protection Cover
- Lattice Wind Mouth



DESCRIPTION	
Voltage:	220-240V
Frequency:	50/60Hz
Input Power:	2000W
Temperature:	I:50°C II:50-450°C III:90-600°C
Air Flow:	I:250L/M II:250L/M III:500L/M
Continue Use:	500 hours
Color Box Size:	35.2x10.8x30.7cm

SPECIFICATIONS	
G.W/N.W(KGS):	11.8/11kg
Case Pack:	5pcs
20"GP:	1985pcs
Carton Size:	57x36.5x32.7cm



HEAT GUN

MODEL NO: HG003

- High Quality High Temperature Resistant Insulation Heating Wire
- Energy-saving Insulation Saves Energy
- High-power Turbo Fan For Stronger Air Supply
- With High Temperature Protection Cover
- Lattice Wind Mouth



DESCRIPTION	
Voltage:	220-240V
Frequency:	50/60Hz
Input Power:	1600W
Temperature:	I:350°C II:500°C
Air Flow:	I:300L/M II:500L/M
Continue Use:	500 hours
Color Box Size:	22x8.25x28cm

SPECIFICATIONS	
G.W/N.W(KGS):	6.8/6kg
Case Pack:	8pcs
20"GP:	4472pcs
Carton Size:	46x35x30cm



ELECTRIC SPRAY GUN

MODEL NO: SG001

- Adjustable Spray Size
- Low Noise And Anti-dust
- Durable Large Watering Can



DESCRIPTION	
Voltage:	220-240V
Frequency:	50/60Hz
Input Power:	400W
Nozzle Size:	2.5mm
Max Viscosity:	60DIN-S
Max.Spraying Pressure:	0.1-0.2BAP
Delivery Rate:	700ml/min
Container Capacity:	900ml
Color Box Size:	27.6x13.5x25.8cm

SPECIFICATIONS	
G.W/N.W(KGS):	8.8/7kg
Case Pack:	4pcs
Carton Size:	56.7x28.5x27.8cm



ELECTRIC SPRAY GUN

MODEL NO: SG002

- Adjustable Spray Size
- Low Noise And Anti-dust
- Durable Large Watering Can



DESCRIPTION	
Voltage:	220-240V
Frequency:	50/60Hz
Input Power:	80W
Nozzle Size:	0.8mm
Max Viscosity:	40DIN-S
Max.Spraying Pressure:	140BAP
Delivery Rate:	250ml/min
Container Capacity:	800ml
Color Box Size:	27.6x12.6x25.8cm

SPECIFICATIONS	
G.W/N.W(KGS):	8.2/7.5kg
Case Pack:	4pcs
Carton Size:	52.4x29.1x27.8cm



355MM CUT OFF MACHINE

MODEL NO: **CM002**

- Multi Angle Cutting For Easy Operation
- Strong Power Low Noise
- Multifunction Make Working High Efficiency
- Double Dustproof High Efficient Heat Dissipation
- Multifunction On Wood /steel/aluminum Cutting



DESCRIPTION	
Voltage:	220-240V
Frequency:	50/60Hz
Power:	2700W
No-load Speed:	4100r/min
Wheel Size:	355mm

SPECIFICATIONS	
G.W/N.W(KGS):	17.8/16.5kg
Case Pack:	1pcs
20"GP:	387pcs
Carton Size:	53.5x31x42cm



355MM CUT OFF MACHINE

MODEL NO: **CM005**

- Multi Angle Cutting For Easy Operation
- Strong Power Low Noise
- Multifunction Make Working High Efficiency
- Double Dustproof High Efficient Heat Dissipation
- Multifunction On Wood /steel/aluminum Cutting



DESCRIPTION	
Voltage:	220-240V
Frequency:	50/60Hz
Power:	2000W
No-load Speed:	3700r/min
Wheel Size:	355mm

SPECIFICATIONS	
G.W/N.W(KGS):	14/13kg
Case Pack:	1pcs
20"GP:	450pcs
Carton Size:	53.5x30x39.5cm



355MM CUT OFF MACHINE

MODEL NO: **CM006**

- Multi Angle Cutting For Easy Operation
- Strong Power Low Noise
- Multifunction Make Working High Efficiency
- Double Dustproof High Efficient Heat Dissipation
- Multifunction On Wood /steel/aluminum Cutting



DESCRIPTION	
Voltage:	220-240V
Frequency:	50/60Hz
Power:	2000W
No-load Speed:	3800r/min
Wheel Size:	355mm

SPECIFICATIONS	
G.W/N.W(KGS):	12/11kg
Case Pack:	1pcs
20"GP:	450pcs
Carton Size:	55x31x41cm



255MM MITER SAW

MODEL NO: **MS001**

- Can Turn 180 Degrees With Strong Power
- Wide Usage For Different Cutting Need
- Professional Quality Handysize Strength Faction
- High Precision Disc
- High Precision Free Cutting



DESCRIPTION	
Voltage:	220-240V
Frequency:	50/60Hz
Power:	1800W
No-load Speed:	4800r/min
Blade Size:	255mm

SPECIFICATIONS	
G.W/N.W(KGS):	17.5/15.5kg
Case Pack:	1pcs
20"GP:	183pcs
Carton Size:	82x46x42cm



255MM MITER SAW

MODEL NO: **MS005**

- Can Turn 180 Degrees With Strong Power
- Wide Usage For Different Cutting Need
- Professional Quality Handysize Strength Faction
- High Precision Disc
- High Precision Free Cutting



DESCRIPTION	
Voltage:	220-240V
Frequency:	50/60Hz
Power:	1800W
No-load Speed:	6000r/min
Blade Size:	255mm

SPECIFICATIONS	
G.W/N.W(KGS):	10.5/10kg
Case Pack:	1pcs
20"GP:	330pcs
Carton Size:	51x40x40cm



255MM MITER SAW

MODEL NO: **MS006**

- Can Turn 180 Degrees With Strong Power
- Wide Usage For Different Cutting Need
- Professional Quality Handysize Strength Faction
- High Precision Disc
- High Precision Free Cutting



DESCRIPTION	
Voltage:	220-240V
Frequency:	50/60Hz
Power:	1800W
No-load Speed:	5300r/min
Blade Size:	255mm

SPECIFICATIONS	
G.W/N.W(KGS):	12/11kg
Case Pack:	1pcs
20"GP:	270pcs
Carton Size:	58.5x42.5x42cm





100MM MARBLE CUTTER

MODEL NO: MC002

- Aluminum Head
- External Carbon Brushes Design
- Power Locking Design For Long-playing Use
- 34mm Max Cutting Depth



DESCRIPTION	
Voltage:	220-240V
Frequency:	50/60Hz
Power:	1480W
No-load Speed:	12000r/min
Wheel Size:	110mm
Color Box Size:	23x22x17.5cm

SPECIFICATIONS	
G.W/N.W(KGS):	15/13.5kg
Case Pack:	4pcs
20"GP:	2600pcs
Carton Size:	46x24.5x37cm



100MM MARBLE CUTTER

MODEL NO: MC003

- Aluminum Head
- External Carbon Brushes Design
- Power Locking Design For Long-playing Use
- 34mm Max Cutting Depth



DESCRIPTION	
Voltage:	220-240V
Frequency:	50/60Hz
Power:	1600W
No-load Speed:	13500r/min
Wheel Size:	110mm
Color Box Size:	24x22x19cm

SPECIFICATIONS	
G.W/N.W(KGS):	13/12kg
Case Pack:	4pcs
20"GP:	2360pcs
Carton Size:	45.5x25.5x39.5cm



35MM CONCRETE VIBRATOR

MODEL NO: CV001

- Specialized in concrete, widely used
- High-hardness helical gear, low noise
- Thickened cast aluminum casing for durability
- The vibration effect is good
- It is suitable for long-term concrete
- Fast cooling system for long lasting service



DESCRIPTION	
Voltage:	220-240V
Frequency:	50/60Hz
Power:	960W
No-load Speed:	4600r/min
Vibrator Diameter:	35mm
Color Box Size:	62x9x33cm

SPECIFICATIONS	
G.W/N.W(KGS):	26/24kg
Case Pack:	4pcs
20"GP:	574pcs
Carton Size:	64x38x35cm



35MM CONCRETE VIBRATOR

MODEL NO: CV002

- Specialized in concrete, widely used
- High-hardness helical gear, low noise
- Thickened cast aluminum casing for durability
- The vibration effect is good
- It is suitable for long-term concrete
- Fast cooling system for long lasting service



DESCRIPTION	
Voltage:	220-240V
Frequency:	50/60Hz
Power:	800W
No-load Speed:	4500r/min
Vibrator Diameter:	35mm
Color Box Size:	32.5x8x16cm

SPECIFICATIONS	
G.W/N.W(KGS):	21.5/19.5kg
Case Pack:	10pcs
20"GP:	5570pcs
Carton Size:	42.5x33.5x34cm



180MM WALL SANDER

MODEL NO: WS001

- Copper core motor, strong power
- Lighting device for easy work
- Reinforced nylon housing for longer life and durability
- Strong suction, self-contained vacuum cleaner
- Self-cleaning dust-removing design, 5-speed switch



DESCRIPTION	
Voltage:	220-240V
Frequency:	50/60Hz
Power:	850W
No-load Speed:	1400-2700r/min
Diameter Disc:	180mm
Color Box Size:	30x30x27cm

SPECIFICATIONS	
G.W/N.W(KGS):	16.2/15.2kg
Case Pack:	4pcs
20"GP:	988pcs
Carton Size:	62x31.5x56cm



ANGLE GRINDER STAND

MODEL NO: **AG-S2**

- Precision Fixture, Adjustable From 0-45°
- Cast Iron Base, Thickening And Thickening
- Suitable For Most Models Of Angle Grinders



SPECIFICATIONS	
G.W/N.W(KGS):	28/26kg
Case Pack:	10pcs
20"GP:	4520pcs
Carton Size:	48.5x22x56cm

IMPACT DRILL STAND

MODEL NO: **ID-S2**

- Bold Thickened Pipe, Stable And Not Shaking
- Highly Flexible Adjustment For Various Working Situations
- Precision Scale, Precise Punching



SPECIFICATIONS	
G.W/N.W(KGS):	19/17kg
Case Pack:	10pcs
20"GP:	3465pcs
Carton Size:	42.5x39x47cm

IMPACT DRILL STAND

MODEL NO: **ID-S3**

- Bold Thickened Pipe, Stable And Not Shaking
- Highly Flexible Adjustment For Various Working Situations
- Precision Scale, Precise Punching
- Cast Iron Base, Double Thickening

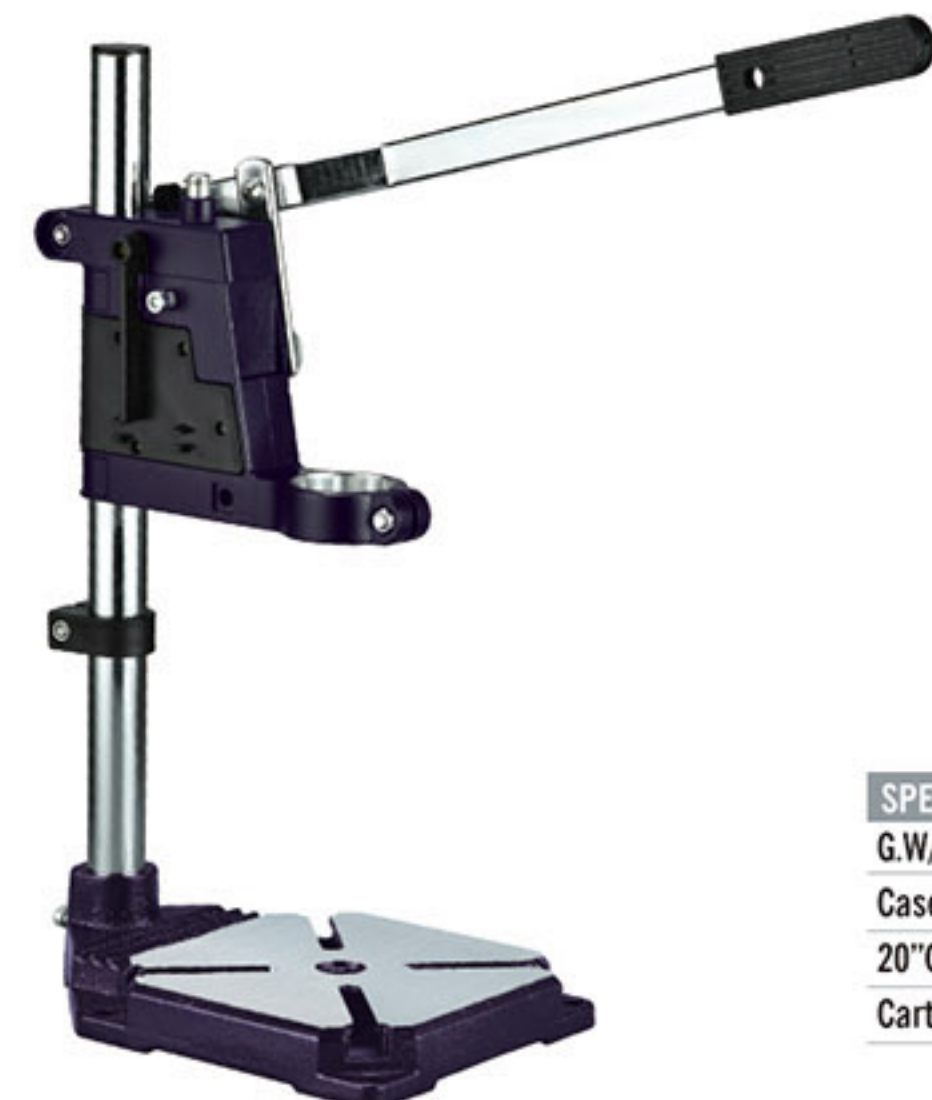

SPECIFICATIONS	
G.W/N.W(KGS):	29/26kg
Case Pack:	10pcs
20"GP:	3465pcs
Carton Size:	42.5x39x47cm

ELECTRIC CHAIN SAW

MODEL NO: **EC003**

- Powerful Motor Strong Performance
- Soft Grip Handle For Comfortable Operation
- High Efficient Heat Dissipation Design
- Automatic Fuel Injection System



DESCRIPTION	
Voltage:	220-240V
Frequency:	50/60Hz
Power:	1480W
No-load Speed:	840r/min
Chain Length:	360mm
Color Box Size:	44x24.5x20cm

SPECIFICATIONS	
G.W/N.W(KGS):	16.5/14.5kg
Case Pack:	4pcs
20"GP:	1096pcs
Carton Size:	51x46x42cm



ELECTRIC CHAIN SAW

MODEL NO: **EC004**

- Powerful Motor Strong Performance
- Soft Grip Handle For Comfortable Operation
- High Efficient Heat Dissipation Design
- Automatic Fuel Injection System



DESCRIPTION	
Voltage:	220-240V
Frequency:	50/60Hz
Power:	2200W
No-load Speed:	1200r/min
Chain Length:	405mm
Color Box Size:	48x26.5x22.5cm

SPECIFICATIONS	
G.W/N.W(KGS):	13/12kg
Case Pack:	2pcs
20"GP:	836pcs
Carton Size:	50x28.5x47.5cm



52CC GASOLINE CHAIN SAW

MODEL NO: **GC002**

- Fuel Economy And Stable Output
- Easily Launch With High Efficiency
- High Temperature And Not Easy To Turn Off
- High Precision Bent Axle
- Triple Filter System
- Side Commissioning Adjustment Device
- High Quality Anti-skid Handle



DESCRIPTION	
Power:	2100W
No-load Speed:	8500r/min
Bar Length:	20"
Max Cutting Length:	455mm/520mm
Max Speed:	10500r/min
Ldliing Speed:	3000r.m
Enginee Displacement:	49.3cm³
Brake Time:	<0.12
Torque:	2.45N
Color Box Size:	48x26x31cm

SPECIFICATIONS	
G.W/N.W(KGS):	14/13kg
Case Pack:	2pcs
20"GP:	900pcs
Carton Size:	50x27x44cm



BRUSH CUTTER

MODEL NO: BC001

- Efficient heat dissipation, continuous operation for 72 hours without flameout, suitable for industrial grade all day use
- High precision gear, high power and high efficiency transmission



DESCRIPTION	
Engine Type:	2 Stroke, Single Cylinder, Air Cooled
Displacement:	52CC
Output Power:	1650W
Engine Ltem:	1E44F-5
Shaft Diameter	26mm
Shaft Length:	1500mm

SPECIFICATIONS	
G.W/N.W(KGS):	8.5/7.5kg
Case Pack:	1pcs
20"GP:	1173pcs
Carton Size:	33x27x26cm

BRUSH CUTTER

MODEL NO: BC002

- Efficient heat dissipation, continuous operation for 72 hours without flameout, suitable for industrial grade all day use
- High precision gear, high power and high efficiency transmission



DESCRIPTION	
Engine Type:	2 Stroke, Single Cylinder, Air Cooled
Displacement:	43CC
Output Power:	1250W
Engine Ltem:	1E40F-5
Shaft Diameter	26mm
Shaft Length:	1500mm

SPECIFICATIONS	
G.W/N.W(KGS):	8.5/7.5kg
Case Pack:	1pcs
20"GP:	1173pcs
Carton Size:	33x27x26cm

BRUSH CUTTER

MODEL NO: BC003

- Efficient heat dissipation, continuous operation for 72 hours without flameout, suitable for industrial grade all day use
- High precision gear, high power and high efficiency transmission



DESCRIPTION	
Engine Type:	2 Stroke, Single Cylinder, Air Cooled
Displacement:	55CC
Output Power:	1800W
Engine Ltem:	1E44F-5
Shaft Diameter	26mm
Shaft Length:	1500mm

SPECIFICATIONS	
G.W/N.W(KGS):	8.5/7.5kg
Case Pack:	1pcs
20"GP:	1173pcs
Carton Size:	33x28x27cm

Optional Accessories

