



# AV over IP Series

**A flexible solution that integrates  
4K@30Hz 4:4:4 HDMI,**

**1080p HDMI, DVI, and VGA devices**

**Diversify your existing AV system over  
standard 1G Lan/ Wan networks.**



Transport Hub



Church



Department Store



Data Center



Sports Bar



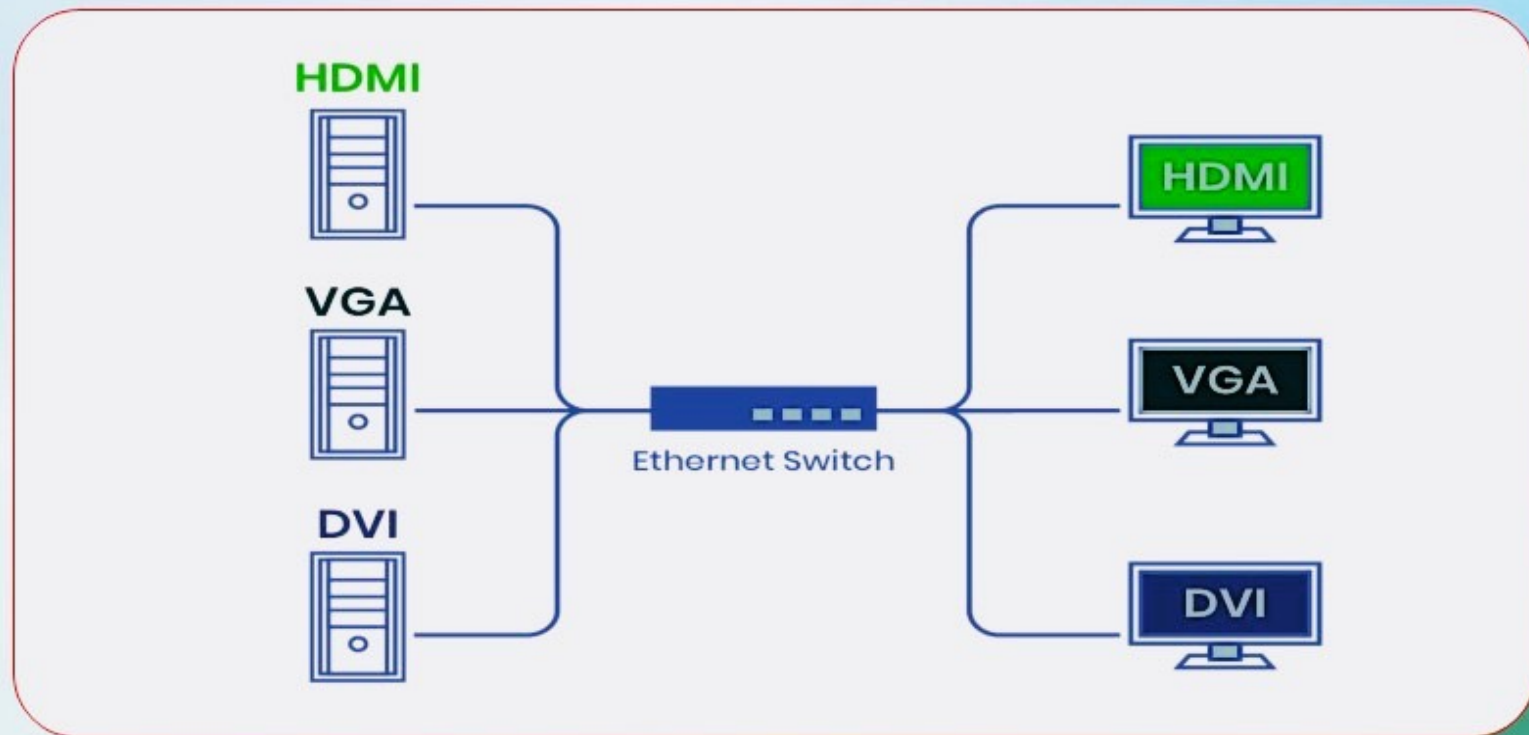

Resolution	Bandwidth (Mbps)
3840x2160 (4K)	146-268
1920x1080 (1080p)	80-210
1280x720 (720P)	112-177
1600x1200 (UXGA)	57-105
1280x1024 (SXGA)	79-150
1024x768 (XGA)	72-120
800x600 (SVGA)	49-82
640x480 (VGA)	29-56

# Product Array

**HKM02BP-4K**  
**HKM02B-4K**



**HKM02B**



**VDKM02B**



<b>Model</b>	<b>HKM02BP-4K</b>	<b>HKM02B-4K</b>	<b>HKM02B</b>	<b>VDKM02B</b>
<b>Video Format</b>	<b>HDMI</b>	<b>HDMI</b>	<b>HDMI</b>	<b>VGA/DVI</b>
<b>Resolution</b>	<b>4K@30Hz</b>	<b>4K@30Hz</b>	<b>1080P@60Hz</b>	<b>1080P@60Hz</b>
<b>Audio Embed / Extract</b>	<b>✓</b>	<b>✓</b>	<b>✓</b>	<b>✓</b>
<b>IR</b>	<b>✓</b>	<b>✓</b>	<b>✓</b>	<b>✓</b>
<b>RS232</b>	<b>✓</b>	<b>✓</b>	<b>✓</b>	<b>✓</b>
<b>PoE</b>	<b>✓</b>			
<b>Fiber Module</b>	<b>✓</b>	<b>✓</b>		





# 4K UHD HDMI Matrix Switcher AUDIO EXTRACTOR SCALER

- Resolution up to 4K@60Hz 4:4:4.
- Supports HDMI matrix, distribution, separation (combine video from OUTPUT A with audio from OUTPUT B) modes.
- Built-in optical audio & LPCM audio interfaces.
- Built in IR sensor and 3.5mm phone jack for external IR receiver cable.
- Supports resolution up/ down scaling function, 1080p to 4K or 1080p to 4K.

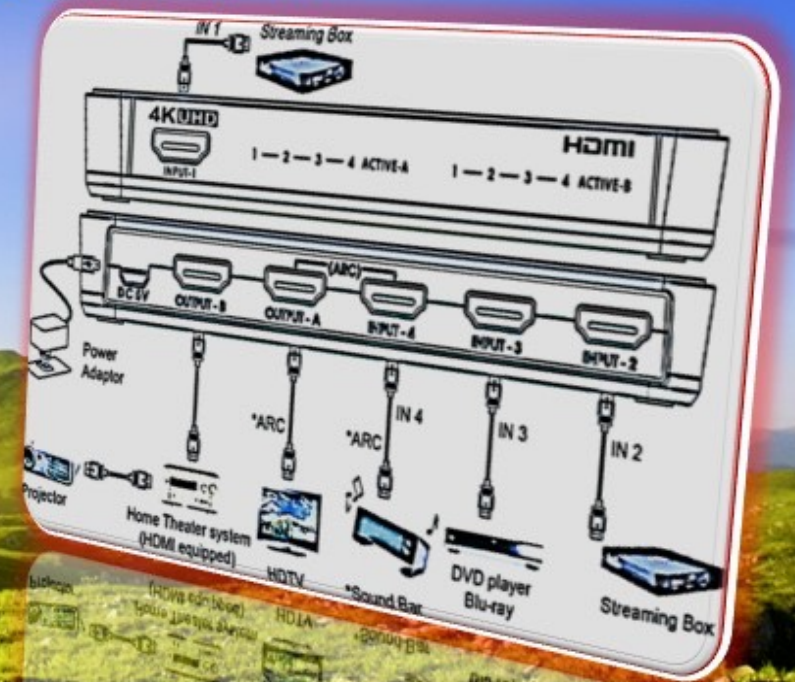

Part Number HDMXS4X2-4K  
\$120.00

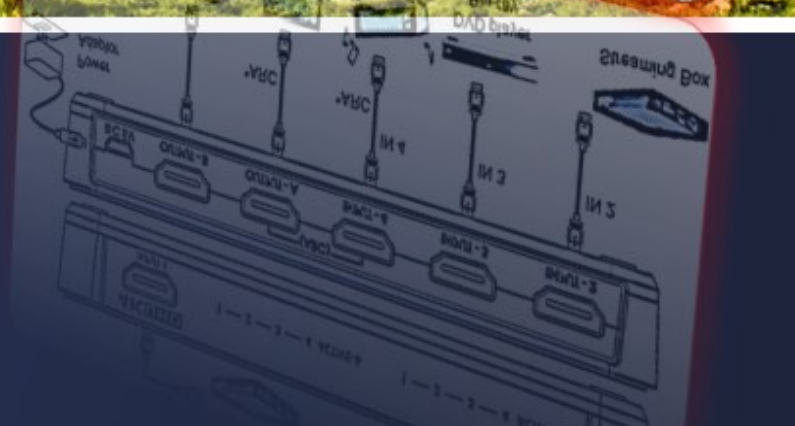

# HDMI 4K 30Hz SPLITTER

1 x 2 HDMI Distribution Amplifier

1 x 4 HDMI Distribution Amplifier

**Splits an HDMI signal into 2 or 4  
Resolution up to 4K@30Hz  
Supports EDID management**

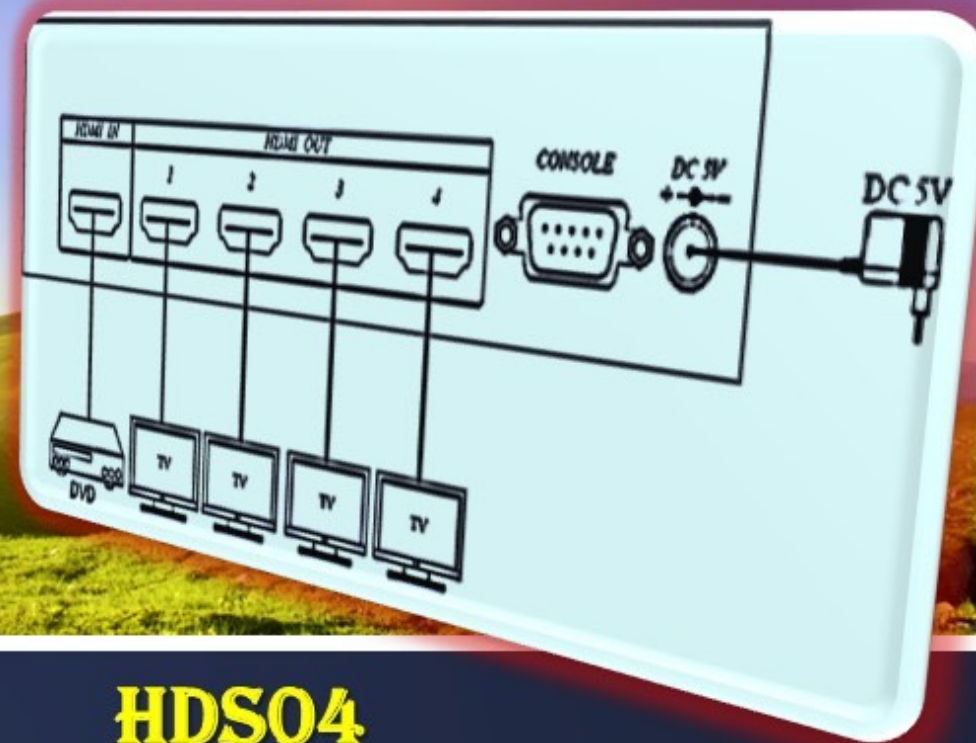

**HDSS02**

**\$110.00**

**PART NUMBERS**

**HDS04**

**\$175.00**



# HDMI 4K 60Hz SPLITTER SCALER

1 x 2 Scaler HDMI Distribution Amplifier

1 x 4 HDMI Distribution Amplifier

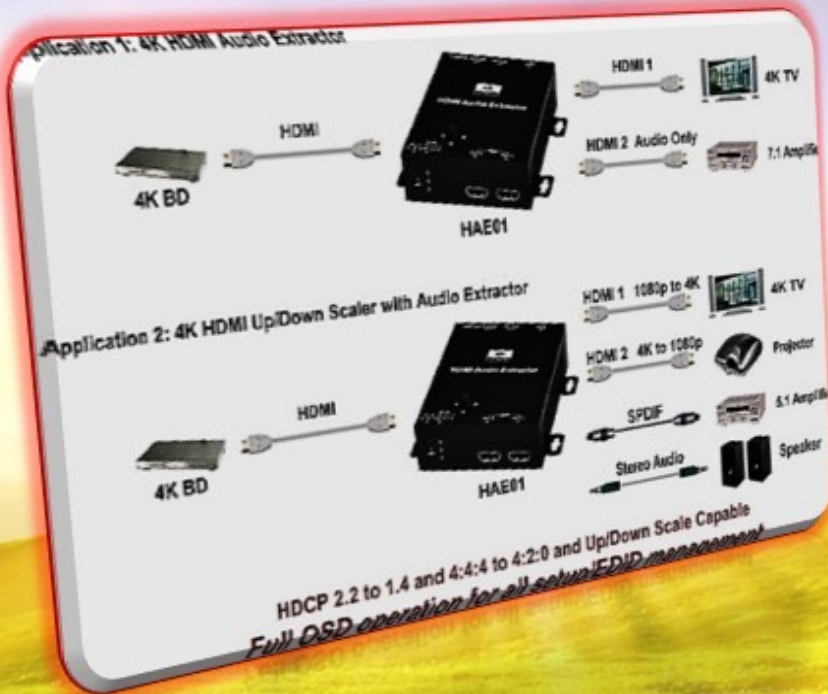

**Splits an HDMI signal into 2 or 4**

**Resolution up to 4K@60Hz  
4:4:4, 18Gbps bandwidth  
(6Gbps per color).**

**Supports EDID  
management, allowing  
showing the best  
resolution for connected  
displays.**

**Clear LED indication,  
easy to see the  
connection status.**

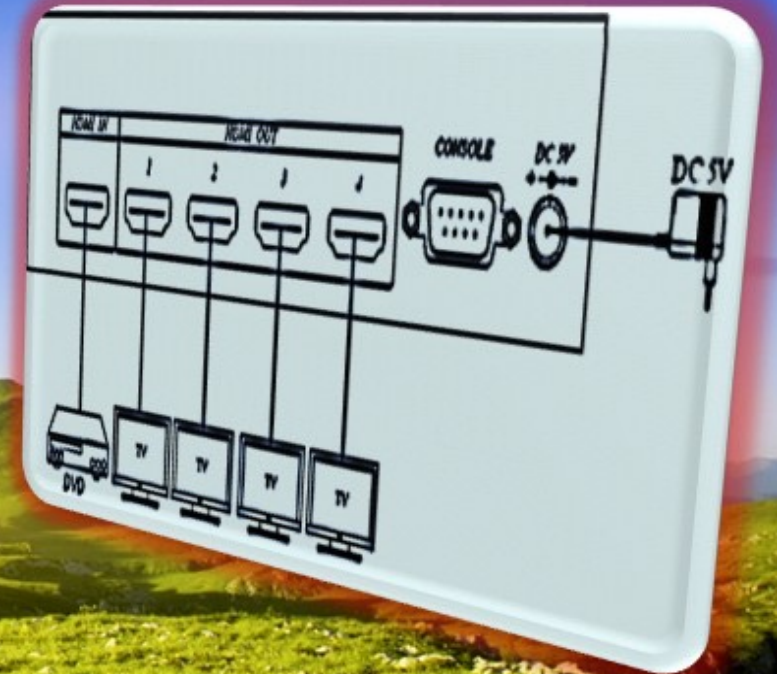

**HDS02-4K**  
**\$130.00**

Part  
Numbers

**HDS04-4K**  
**\$240.00**







# 12G-SDI to HDMI 2.0 Converter With Audio Embedded/Extractor

The 12G-SDI to HDMI 2.0 Converter allows you to monitor 12G SDI video using a cost-effective HDMI display. The new converter has a built-in SDI loop-out port to send the input SDI signal to an extra SDI device. Features: - Resolution up to 4K@60Hz 4:4:4 HDMI and 12G SDI. - SFP port for long distance transmission. - Built-in SDI loop out. - Support for HDMI video up/down scaling.

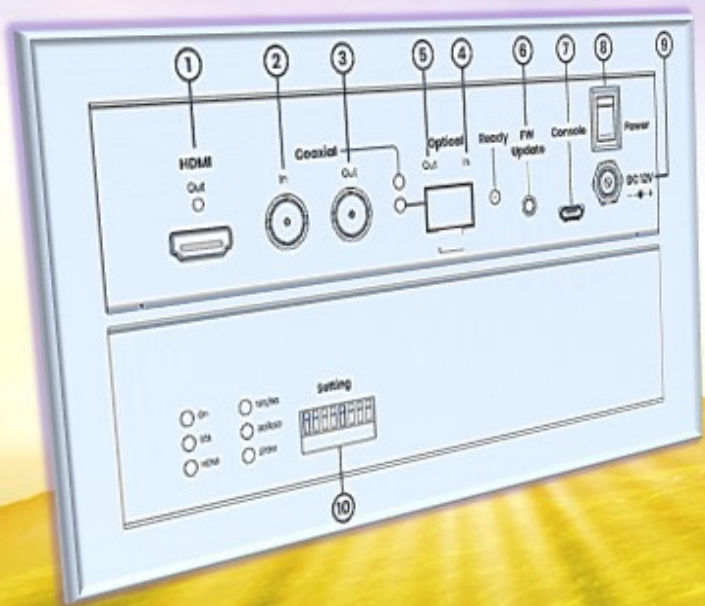

12G-SDI to HDMI 2.0 Converter (no SFP) \$800.00  
with PA-SFP-12TXRX \$1,300.00  
with PA-SFP-TX \$1,000.00  
with PA-SFP-TXRX-CWDM \$1,200.00  
with PA-SFP-DECAP \$1,800.00

Part Number SD101-12G \$800.00  
with PA-SFP-RX \$1,000.00  
with PA-SFP-TRX \$1,100.00  
with PA-SFP-TX-CWDM \$1,150.00  
with PA-SFP-ENCAP \$1,800.00

## Part Number SDI01-12G \$800.00

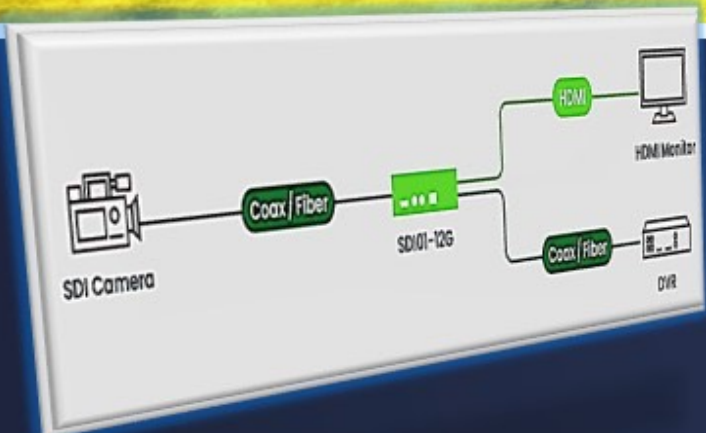



# HDMI 4K CAT5 Extender 70 & 100M

## Features

- Extends HDMI Signal over one CAT5/5e/6 cable.
- Uncompressed high-definition video up to 1080p@60Hz@48bits and 3D and 4K\*2K capable.
- Max. Data Rate- 10.2Gbps.
- HDMI 1.4 and HDCP compliance.
- Transmission range up to 100 meters at 1080p resolution

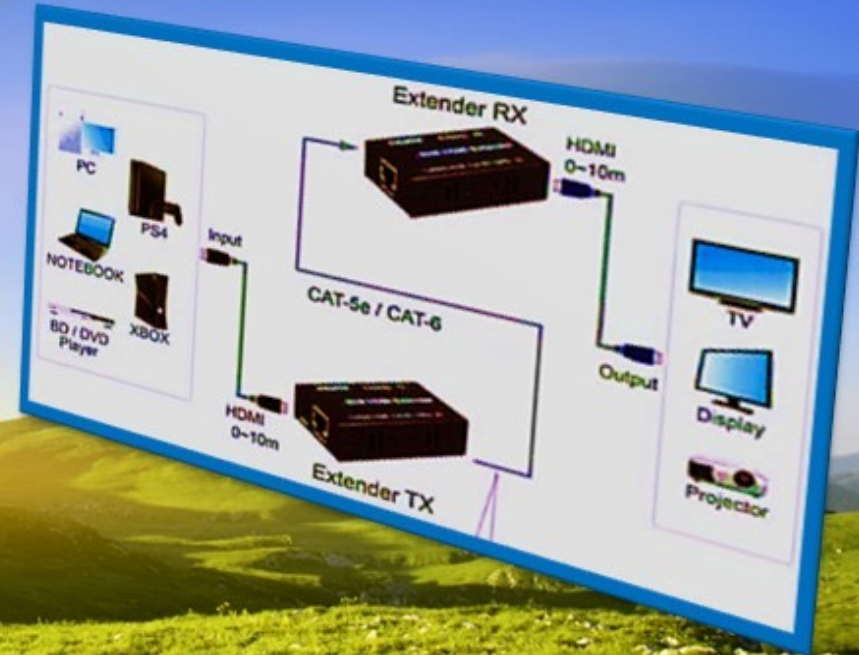

## Part Numbers

- HDE70M** 70meters w IR \$160.00
- HDE100M** 100meters \$325.00





# HDMI 4K 60Hz AUTOMATIC SWITCHER

## 3, 4 & 5 TO 1

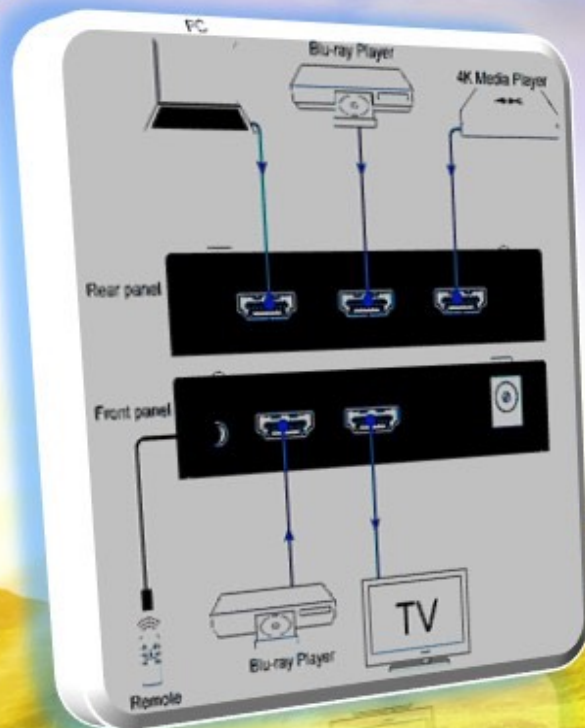

### FEATURES

- Resolution up to 4K@60hz 4:4:4 HDCP
- Built in RS232 console port for remote control or firmware update.
- Supports auto-scan function, automatically switch to the next available input when the selected one is unable to display.
- Supports auto switching function, automatically switch to the last connected input source.
- Managed via front panel buttons, IR remote, and RS232

## Part Numbers



**HDSW03-4K**  
**\$60.00**



**HDSW04-4K**  
**\$120.00**



**HDSW05-4K**  
**\$70.00**

# 4K 60Hz 3X1 HDMI/USB-C Presentation Switcher

## Features

- Resolution up to 4K60@Hz 4:4:4.
- Supports auto video detecting and switching.
- Supports audio embedding & extraction functions.
- Supports up to 60W PD charging for a connected USB device.
- Supports EDID management.

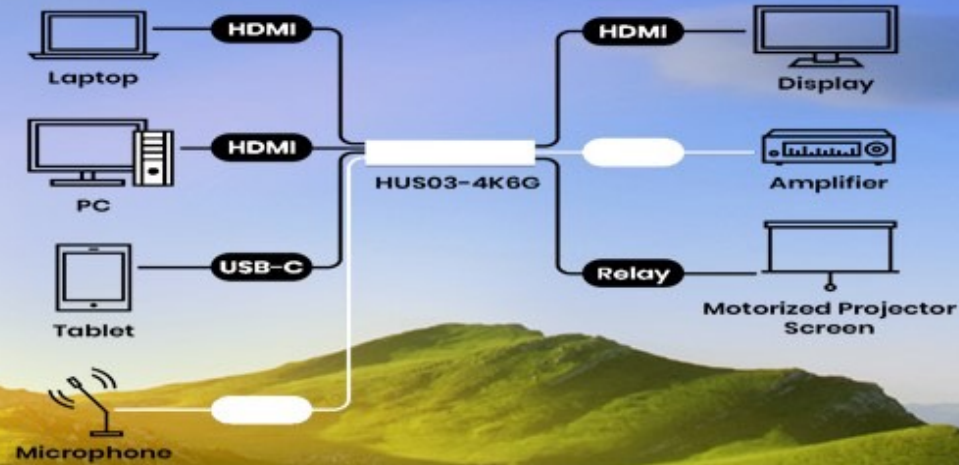

Part Number

**HDSW03**  
**\$240.00**

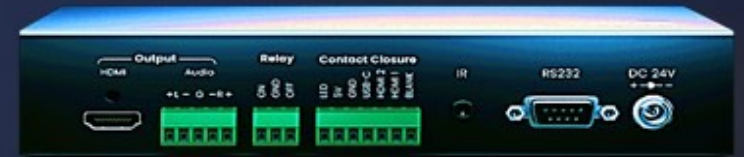

# 4K 10 in 10 out HDMI Matrix Switcher for Your Professional Bank Projects

**HD4K-MXSW10X10** 4K 60Hz 4:4:4 HDMI videos  
PCs, game consoles, Blu-ray players,  
ON hi-resolution PC monitors, TVs, and projectors  
Distance up to 35 feet, double the distance using  
HR01-4K6G (HDMI Repeater)  
Perfect for large spaces - conference rooms, banks,  
sports bars, control centers

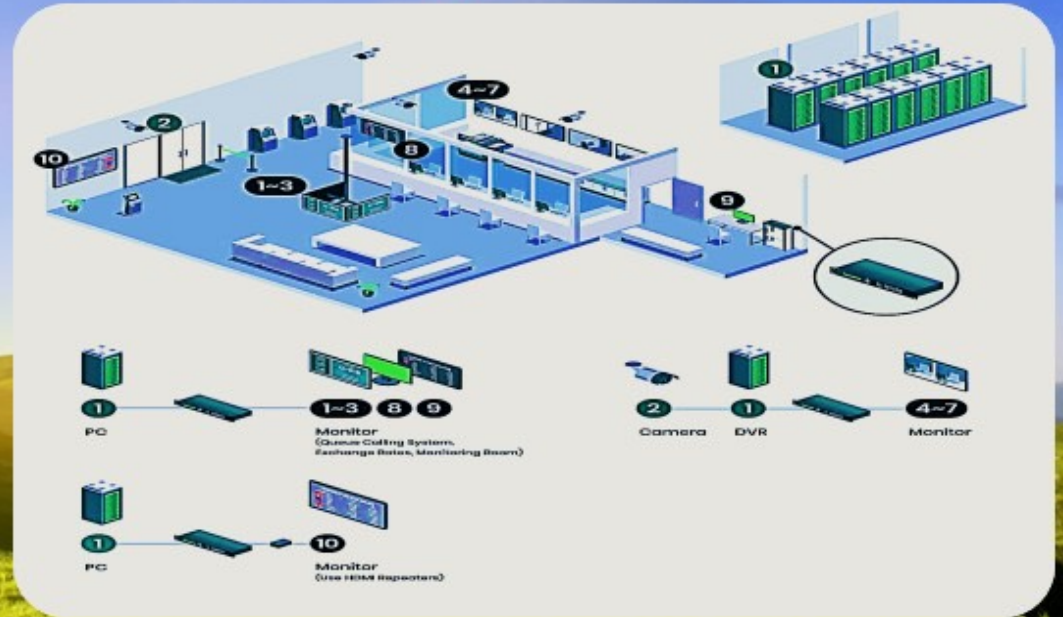

Part Number  
**HD4K-MXSW10X10**





# 8K HDMI SWITCHER 3 X 1

## FEATURES

**Up to 8K @60Hz/ 4K@120Hz,**

**HDCP 2.3 UHD 48Gbps 7680x4320P**

**with Remote controller and USB  
power Cable**

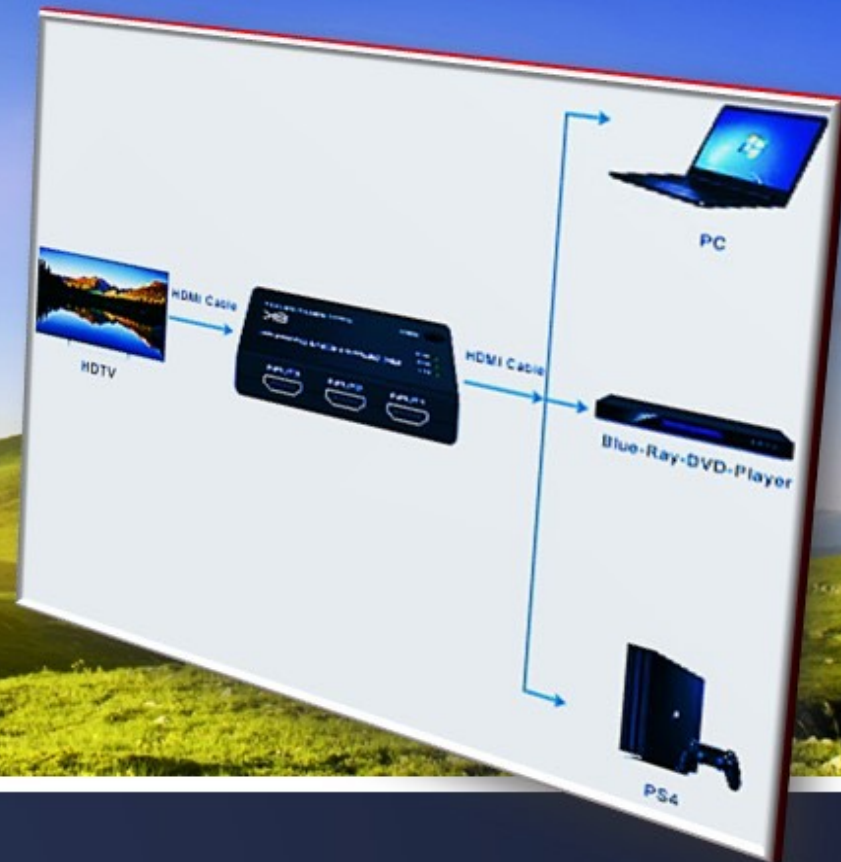

**PART NUMBER HD8K-SW3x1**  
**\$155.00**



# 8K HDMI SPLITTER 2 In 1 OUT

## FEATURES

**Video Splitter 2 X 1, 1 X 2**  
**Compatible 2.1**  
**HDCP 2.3, 8K HDMI**  
**Out For PS5 8K TV**

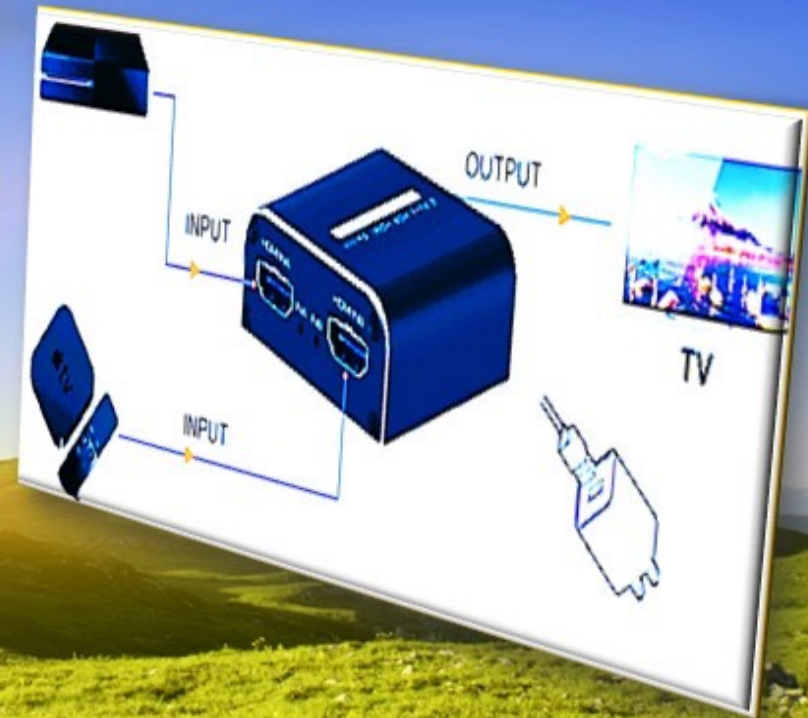

**PART NUMBER HD8K-SW2X1**  
**\$90.00**



# 8K HDMI SPLITTER 1 X 2

## FEATURES

**Up to 8K @ 60Hz / 4K@120hz**

**HDCP 2.2 UHD 48Gbps 7680 X 4320P**

**With Micro-USB Power Cable**

**ODC5V / 500mA**



**PART NUMBER HD8K-S1X2**

**\$220.00**



# 8K HDMI BI-DIRECTIONAL SWITCHER

## FEATURES

**A/B Switch 2 X 1 & 1 X 2 4320p**

**8K @ 60Hz 4K @ 120Hz For PS5**

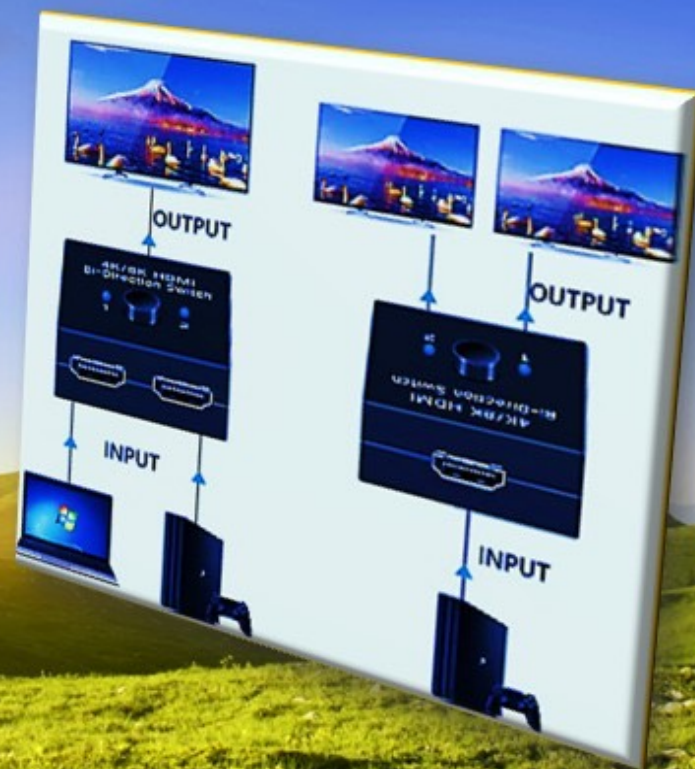

**PART Number HD8K –BiSW**  
**\$45.00**



# 8K HDMI SWITCHER 4 X 1

## FEATURES

**Up to 8K @60Hz/ 4K@120Hz,**

**HDCP 2.3 UHD 48Gbps 7680x4320P**

**with Remote controller and USB  
power Cable**



**PART NUMBER HD8K-SW4x1**  
**\$200.00**



# 8K HDR HDMI True Matrix 4x2

## FEATURES

4 HDMI Input, 2 HDMI Output, (without audio)  
Support 3840x2160P 4K@120Hz  
7680x4320@60 Hz Support HDCP2.3  
Support HDR/Dolby Vision Transmission  
Rate 40Gbps Max.



**PART NUMBER HD8K-MXSW4X2**  
**\$220.00**

# 8K HDR HDMI True Matrix 4x2

## FEATURES

4 HDMI Input, 2 HDMI Output, 2 RCA out ports,  
1 Optical out port Support 3840x2160P  
4K@120Hz  
7680x4320@60 Hz Support HDCP2.3  
Support HDR/Dolby Vision Transmission  
Rate 40Gbps Max.

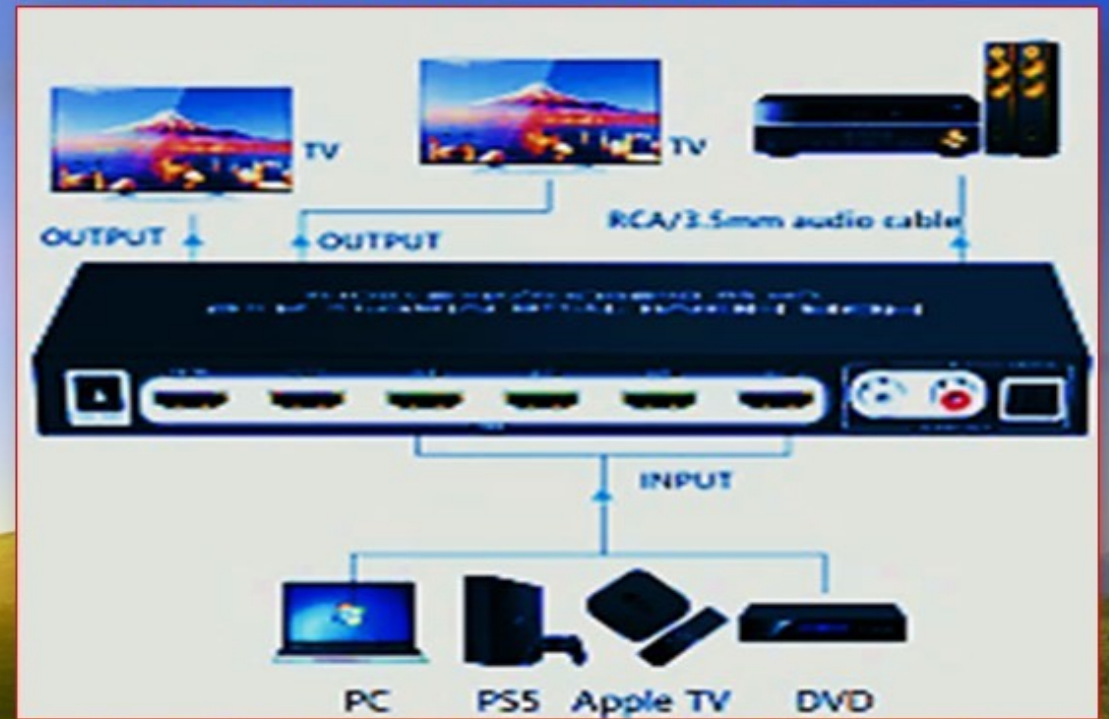

**PART NUMBER HD8K-MXSW4X2A**

**\$220.00**







# HDMI 16 PORT RACK KVM SWITCH

## Product Description

4K\*2K@60HZ Video Resolution

\*Single USB console control 16 HDMI interface computer and two additional USB device

\*Supports USB TYPE A interface type keyboard and mouse device

\*HDMI LCD Console resolution in Max: 1920x1200@60Hz(1080P); HDMI standard alone KVM resolution in Max: 4K x 2K/60Hz

\*Switch the computer through the front panel buttons, keyboard hotkeys and screen menu (OSD)

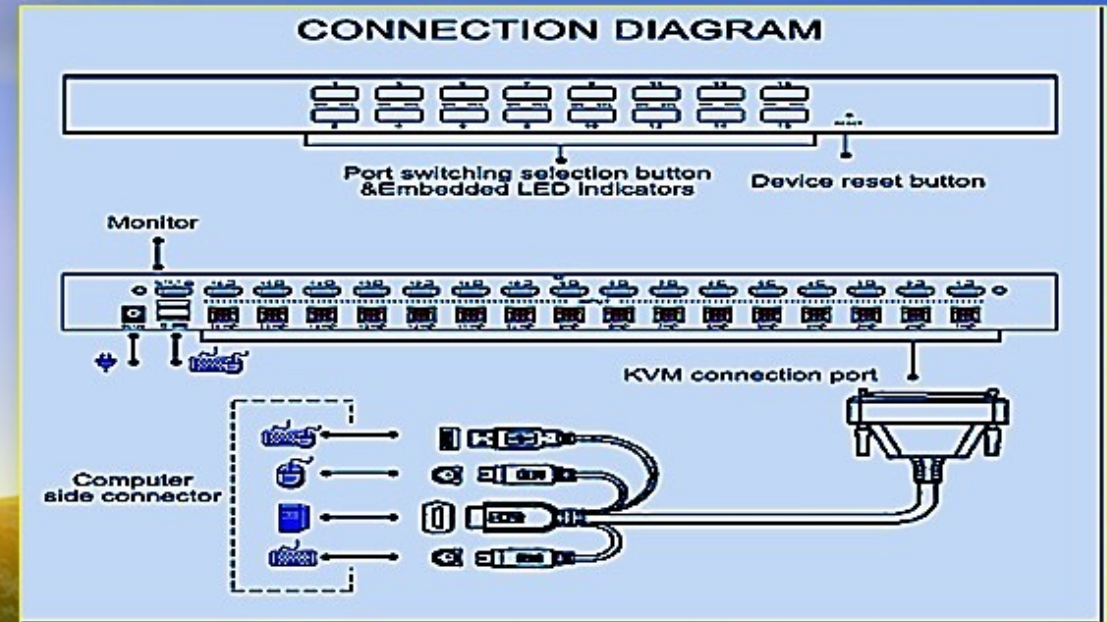

**PART NUMBER HD16P-SKVM**



# WIRELESS KVM

Part Number: HDWL-KVM \$220.00



**Low Delay 5G 4K@30Hz KVM HDMI Wireless**  
**Extender 100m with Loop out, USB, IR Control,**  
**RS232 to Control your PC's Mouse and Keyboard.**

# 4 Port SDI Splitter 3G/HD/SD-SDI Repeater

- 1 SDI input signal split to 4 SDI sink devices.
2. Supports SD-SDI(270Mb/s), HD-SDI(1.485Gb/s), 3G-SDI(2.97Gb/s) video format.
3. Built-in cable equilibrium, clock recovery and drive.
4. Supports resolutions up to 1920x1080@60Hz.
5. Supports signal input and output distances of up to 300m for SD signals, 200m for HD signals and 100m for 3G signals.
6. Supports 5-12V wide voltage input.

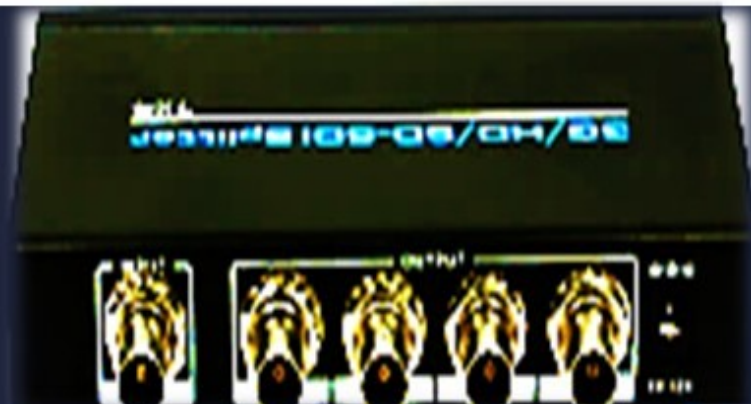
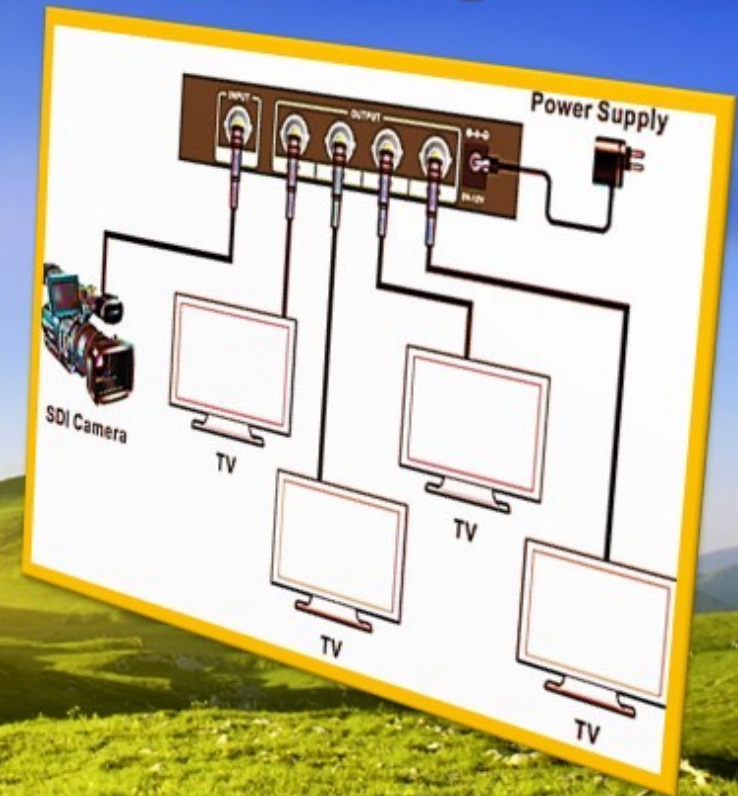

Part Number SDIS-1X4  
\$100.00



# Show HDMI Source On Two SDI DisplayPorts

**SDI interface operates at bitrates of 2.970 Gbit/s, 1.485 Gbit/s.**  
**Supports HDMI input timings: 480i, 576i, 720p, 1080i, 1080p.**  
**Converts HDMI signal to SDI:**  
**720p/1080i to HD-SDI (SMPTE 292M, at bitrates of 1.485 Gbit/s)**  
**1080p to 3G-SDI (SMPTE 424M/425M-AB, at bitrates of 2.970 Gbit/s)**  
**Supports SDI output distance up to 100 meters (3G-SDI), 200 meters (HD-SDI), or 300 meters (SD-SDI)**

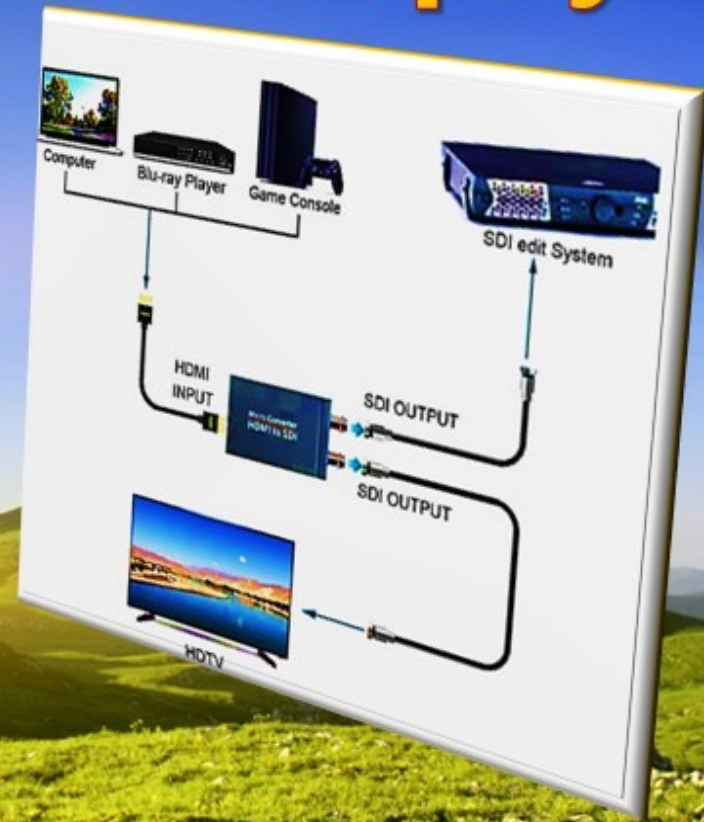

**Part Number HDMI-SDIC**  
**\$100.00**

# SDI to HDMI+SDI Converter

Operation at 2.970Gbit/s, 1.485Gbit/s  
Supports SMPTE 425M, SMPTE 424M,  
SMPTE 292M, SMPTE 259M-C  
Connect with other units to extend your  
signal over long distances

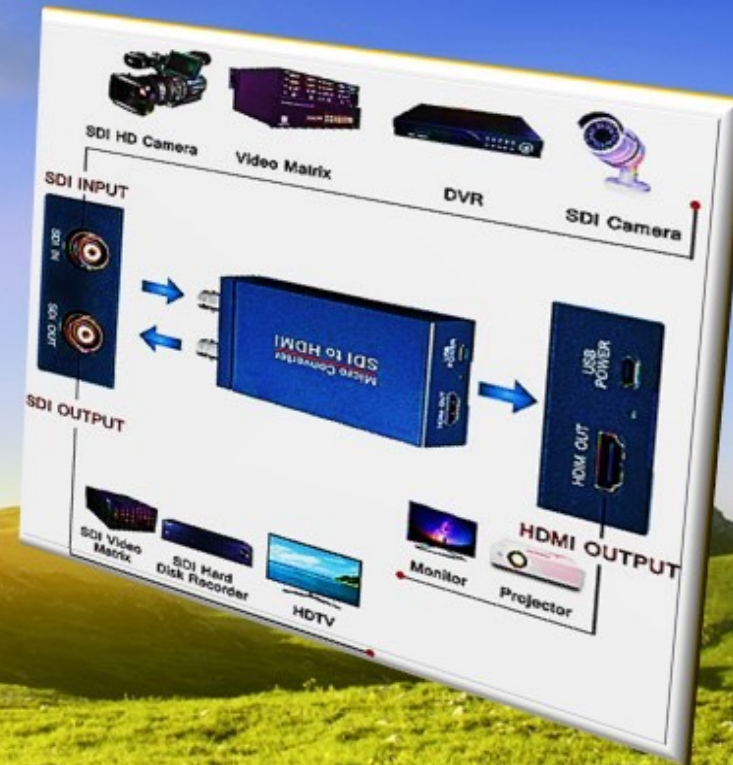

Part Number SDI-HDMIC  
\$100.00

# 18Gbps HDBaset Extender with IR, RS232, CEC, PoC

HDCP 2.2 / HDCP 1.4 and DVI 1.0 compliant

Support 18Gbps video bandwidth

The maximum extended transmission distance via a single Cat5e/6 cable:

394ft / 120 meters for 4K2K signal;

492ft / 150 meters for 1080P signal

Support one HDMI loop output on the transmitter

De-embedded audio to analog stereo output on receiver

With bi-directional IR, RS-232 and CEC pass-through

HDR, HDR10+, Dolby Vision and HLG function supported

Support PoC (Power over Cable) function

Compact design for easy and flexible installation

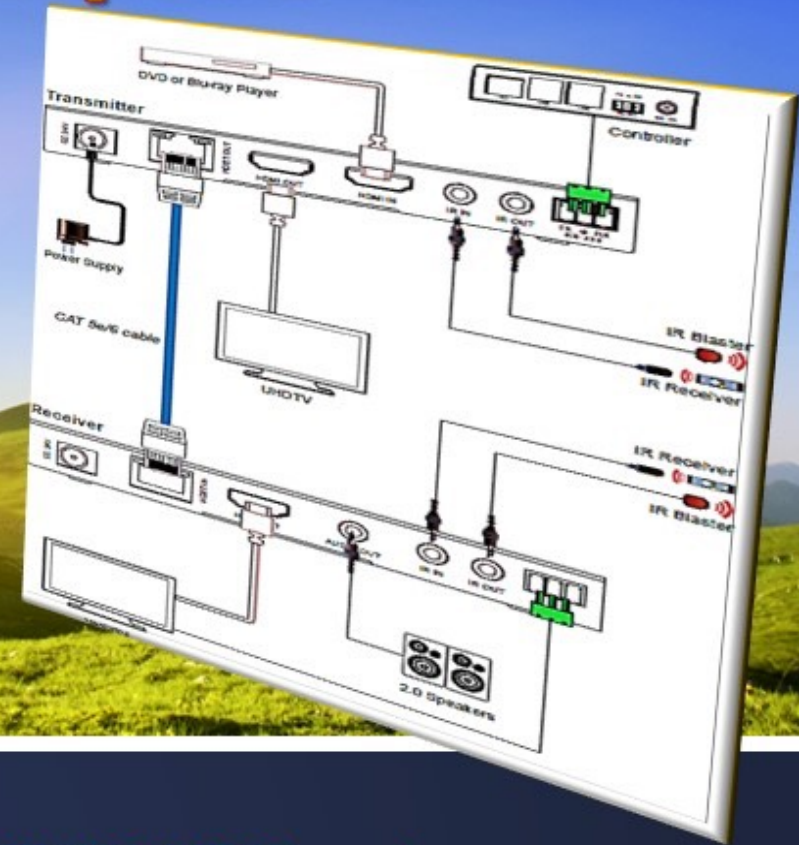

Part Number HD4K-HDBaset  
\$350.00

# 8x8 HDMI Matrix HDBaset extender with 8 receivers 4K 120-150meter 4K60HZ ,YUV 4:4:4

**HDMI 2.0b, HDCP 2.2 and HDCP 1.x compliant**

**Video resolution up to 4K2K@60Hz (YUV 4:4:4) on all HDMI & HDBaseT ports**

**8 HDMI inputs, 8 HDMI & HDBaseT mirrored outputs**

**HDMI ports transmit 18Gbps lossless uncompressed video bandwidth**

**Support 18Gbps lossless compressed HDBaseT signal transmission**

**Support 4K->1080P Down Scaler for each output port**

**HDR, HDR10, HDR10+, Dolby Vision, HLG are supported**

**HDBaseT output can extend video transmission distance up to 492ft / 150m for 1080P**

**or 394ft / 120m for 4K2K via a single Cat 5e/6/7 cable**

**HDMI audio pass-through up to 7.1CH HD audio (LPCM, Dolby TrueHD and DTS-HD Master Audio)**

**Support IR matrix**

**Audio de-embedded is supported via analog and coax ports**

**Advanced EDID management and CEC control are supported**

**24V POC on all HDBaseT ports**

**1U rack mounted design with front panel OLED display**

**Control via front panel buttons, IR remote, RS-232, LAN and Web GUI**

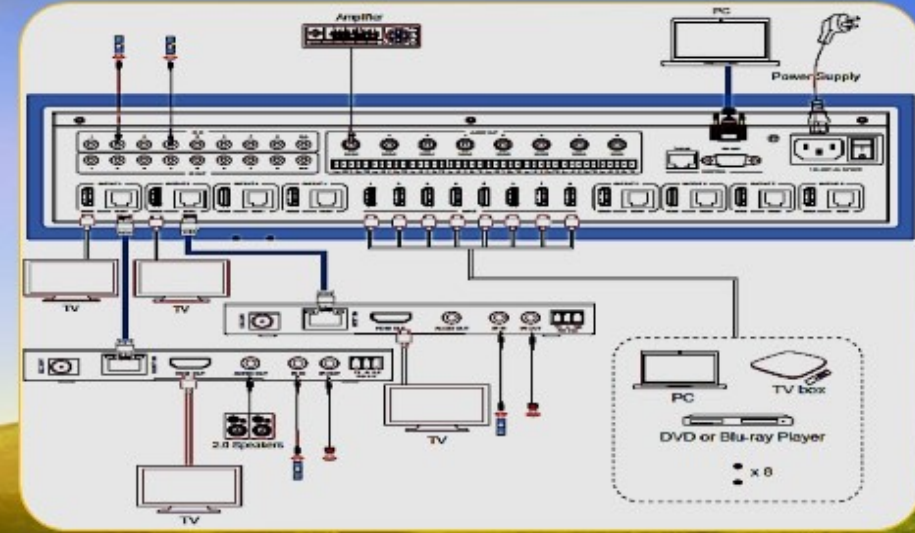

**Part Number HDME4K-8 X 8**  
**\$3500.00**



# HD 12G BROADCAST CONNECTORS STELLAR CHARACTERISTICS



Order online [shop.patchamp.com](http://shop.patchamp.com)  
**4K 12G 12GHZ/18GHZ 75 OHM**  
**Belden 1694A/4694R, 1805A/4805R,**  
**1855A/4855R CANARE L-3.3**

HDBNC-1855 BNC Crimp Plug, 1855A, 4855R \$3.50 Ea.  
HDBNC-1505 BNC Crimp Plug, 1505A, 4505R \$3.50 Ea.  
HDBNC-1694 BNC Crimp Plug, 1964A, 4694R \$3.50 Ea.  
DIN-1885 DIN Crimp Plug 1855A, 4855R \$3.10 Ea.  
DIN-1505 DIN Crimp Plug 1505A, 4505R \$3.10 Ea.  
DIN-1694 DIN Crimp Plug 1964A, 4964R \$3.10 Ea.

HDMBNC-1885 MICRO BNC Crimp Plug 1855A, 4855R \$3.75 Ea.  
HDMBNC-1505 MICRO BNC Crimp Plug 1505A, 4505R \$3.75 Ea.  
HDMBNC-1694 MICRO BNC Crimp Plug 1694A, 4694R \$3.75 Ea.

HDBNC-L.3 BNC Crimp Plug Canare L-3.3 CUHD \$3.50 Ea.  
DIN-L-3.3 DIN Crimp Plug Canare L-3.3 CUHD \$3.50 Ea.  
HDMBNC-L-3.3 MICRO BNC Crimp Plug Canare L-3.3 CUHD \$3.50 Ea.



**BNC Crimp PLUG**



**HDBNC Crimp Plug Micro BNC**



**CABLE \$300.00 / REEL OF 300 METERS**

**DIN Crimp Plug 1.0/2.3**



**This Space Reserved  
For Creativity**

### Premium 12G SDI Structure

The conductor is made of 16 AWG silver-plated copper. It has a better conductivity than oxygen-free copper.



### RGSDI-12G COAX 75 OHM 4K HD 12G - SDI CABLE

Is suitable for HDTV and professional SDI applications: Supports HD-SDI, 12G-SDI, component, composite. This shielded coaxial cable is compatible with a wide variety of popular software, including Blackmagic, AJA, Grass Valley, Everts, Marshall, Cobalt Digital, Atomos, Positum, AVID, and Decimator. Our HD-SDI cable is great for use in HD-serial digital video transfer, HDTV upgrades, broadband facilities, and other applications with HD-SDI video