

# MacroPower 400 – 2000 t

The compact large machine

world of innovation

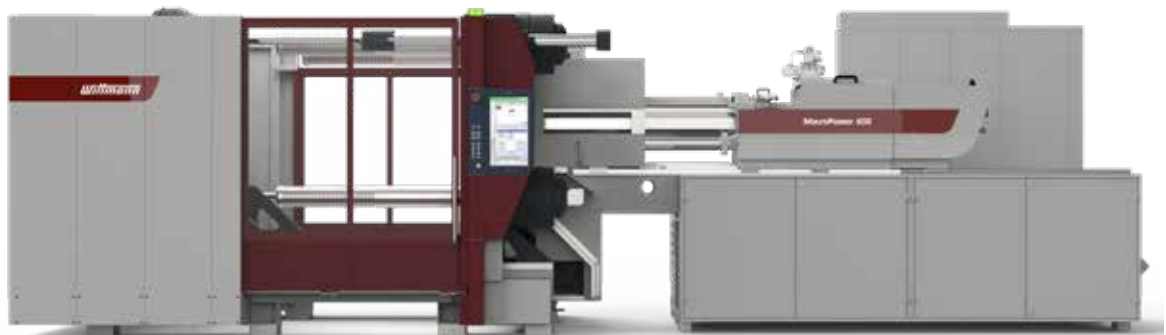

# POWERFUL – COMPACT – UNIVERSAL

## The benchmark for large machines

### The advantages

- » Small footprint through compact design
- » Generously dimensioned 4 tie-bar/2 platen clamping system
- » Long-stroke system to “release” the tie-bars facilitates lateral insertion of large molds
- » Minimal dry cycle time through synchronized closing of the tie-bar nuts
- » Smooth-running platen movements and sensitive mold protection thanks to linear guides
- » User-friendly thanks to Unilog B8 control system with integrated assistance systems
- » Fast through parallel operation of ejector and core pull with platen movement
- » Powerful injection unit with servo valve control
- » With Wittmann 4.0 central operation of machine and peripherals via B8 monitor screen
- » Positioning of hydraulic system and electric modules for easy servicing
- » Attractive price/size ratio

### The machine series

MacroPower standard: 21 clamping force sizes from 400 to 2000 t

MacroPower Combimould: for multi-component injection molding – from 400 to 2000 t





## MacroPower

### The system highlights

- » **Servo drive is standard for the hydraulic system ("Drive-on-Demand")**  
All standard MacroPower machines are driven via a modular twin-pump hydraulic system with fixed displacement pump. Parallel movements for core pull and ejector are standard. Additional pump stages (optional) increase the number and performance of parallel movements.
- » **Precise and powerful screw drive**  
All MacroPower injection units come with hydraulic drive systems as standard. Servo drives for dosing are available as an option. Injection and holding pressure are controlled via a servo valve. Thanks to the system-specific low height of the machine, access to the barrel unit and nozzle for cleaning is easy.
- » **Clamping system – generously dimensioned**  
The MacroPower clamping system is a 4 tie-bar/ 2 platen system with generously dimensioned mold mounting platens. All four tie-bars each come with a pressure cushion unit and are anchored in the fixed platen of the machine. The tie-bars are position-monitored and guarantee optimal platen parallelism.
- » **Quicklock clamping system – synchronous, fast**  
The power transmission between the fixed and the moving system platen is effected by positive locking via the tie-bars, which are gripped by toothed segment half shells in the moving platen. Short locking times are achieved by synchronized movements of all nuts. Long-stroke cylinders move the platen, which is guided on linear bearings. The pressure cushions serve to build up the clamping force.
- » **Insertion of the mold made easy**  
The MacroPower clamping system provides a large gap between the ends of the tie-bars and the moving platen, thanks to its standard large platen stroke and the relatively short length of the tie-bars. This allows for lateral insertion and fastening of the molds from the rear of the machine using a crane.

# CLAMPING UNIT

## High functionality with ample mold space

- » **Large and flexible**  
The extensive MacroPower system construction kit offers a wide range of combination options from numerous clamping force variants with matching distances between tie-bars, in both standard and XL versions.
- » **Sensitive and precise**  
In the MacroPower clamping system, the tie-bars are only used for the force transmission between the mold platens. The moving platen is mounted on a carriage, which travels on high-precision linear bearings along the machine frame. The minimal rolling friction in the linear bearings is the prerequisite for highly sensitive mold protection and high cleanliness.
- » **Fast and synchronized**  
The Quicklock locking system between the tie-bars and the moving platen consists of four synchronized tooth segment nuts, which are integrated in the moving platen to minimize the machine's footprint.
- » **Compact design for minimal footprint**  
The integrated tie-bar nuts and short tie-bars offer two advantages: short footprint and simultaneously free space for lateral mold insertion.
- » **Symmetrical and powerful**  
The moving platen is driven by two diagonally positioned traveling cylinders designed for high speed. The traveling drive in combination with a hydraulic differential gear system provides the basic conditions for high speed, precision in movements and power.



# INJECTION UNIT

Servo-controlled and precise

**Wittmann**

- » **Everything to ensure series consistency**
  - All screws come with a 22:1 L/D ratio.
  - Direct drive via hydro motor (fast-running servo motor available as an option)
  - Maximum repeatability through servo valve control for injection and holding pressure
  - Moment-free nozzle contact through axial positioning of the traveling cylinders
  - Wide range of suitable screws and barrels for various process technologies available
  - WITTMANN BATTENFELD HiQ software modules (optional) offer extensive facilities for compensating environmental factors such as fluctuations in temperature, moisture, regrind or masterbatch content.
  
- » **Extremely easy operation and flexibility**
  - Free access to the injection unit for easy material feeding, machine setting and servicing
  - Maximum maintenance-friendliness thanks to compact design and free accessibility



#### Anti-wear options

In addition to the premium-quality standard equipment, an extensive range of options is available to provide extra anti-wear and/or anti-corrosion protection. Predefined option packages and a selection matrix facilitate the selection of the right plasticizing unit.



# DRIVE TECHNOLOGY

Energy efficient and modular



## Fast-responding, precise, thrifty

"Drive-on-Demand" is the innovative combination of a fast-responding, speed-controlled, air-cooled servo motor with a fixed displacement pump. This drive unit is only activated when required by movements and pressure build-up. During cooling times or cycle pauses for parts handling, the servo drive remains switched off and thus consumes no energy. In operation, "Drive-on-Demand" is the basis for highly dynamic, controlled machine movements and short cycle times. Monitored shut-off valves are installed in the suction pipes to ensure operational safety.

The "Drive-on-Demand" system is standard in the MacroPower machine series.

## Hydraulic system extension levels for parallel functions

- » S1: twin pump system for parallel movements of ejector and core pull
- » S2: twin pump system with increased drive performance (optional) for parallel movements of ejector and core pull plus faster injection
- » S4: twin pump system with increased drive performance (optional) for parallel movements of ejector and core pull and high-speed injection with an accumulator for short cycle times

## A brake on operating costs

- » The "Drive-on-Demand" system is standard equipment.
- » "Drive-on-Demand" lowers energy consumption by up to 40 per cent compared to modern variable displacement pump systems.
- » Additional energy cost cuts through reduction of idle power
- » Lower total expense for cooling, since oil cooling is normally not required
- » Lower maintenance expense through longer preservation of the oil quality due to less thermal load
- » Lower sound emission levels, consequently less investment in sound protection required
- » Second servo drive package is standard, third servo drive package for parallel movements for the mold shut-off nozzle system as an option



# PRODUCTION CELL

## Customized configuration

Wittmann

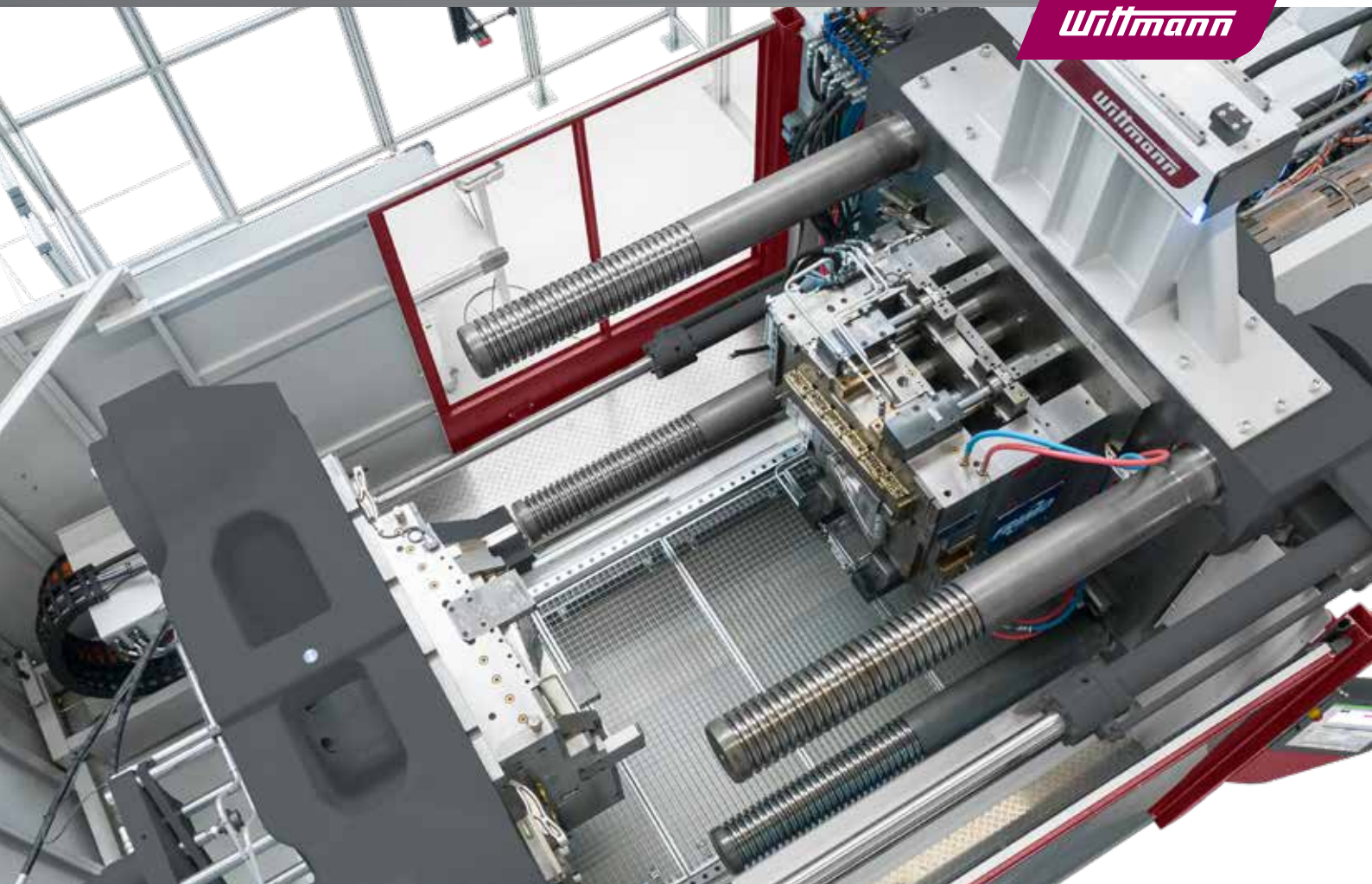

WITTMANN BATTENFELD injection molding machines come with a flexibly adjustable basic modular design. From this basis, the machine can be extended with a wide range of automation equipment into a production cell. This includes primarily devices for fast mold change, fast coupling of complex media connections and the automation of finished parts handling.

### MacroPower automation options:

- » **"Handling robot automation module"** with linear or articulated arm robot and logistics peripherals
- » **Mold clamping systems**  
Both hydraulic and magnetic clamping systems are available including all safety monitoring features, if required combined with roller conveyor units for lateral mold transfer.
- » **Automatic mold change system** as fixed carriage and pre-heating station or as a flexibly movable carriage system with docking interface
- » **Combination with WITTMANN peripheral units via Wittmann 4.0**  
Temperature control or cooling, material feeding, coloring and drying

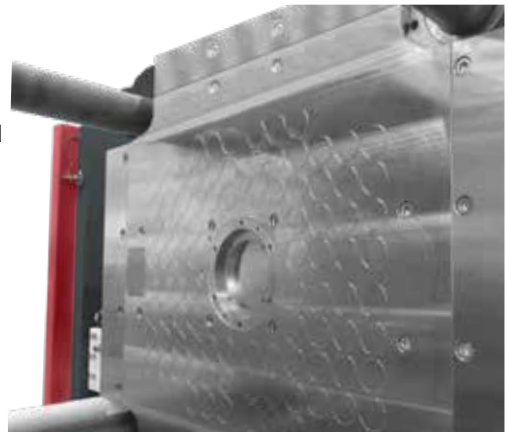



# UNILOG B8

## Complex matters simplified

The Unilog B8 machine control system is the WITTMANN BATTENFELD solution to facilitate the operation of complex processes for human operators. For this purpose, the integrated industrial PC has been equipped with an enlarged intuitive touch screen operator terminal. The visualization screen is the interface to the new Windows® 10 IoT operating system, which offers extensive process control functions. Next to the pivotable monitor screen, a connected panel/handset is mounted on the machine's central console.



### Unilog B8 Highlights

- » **Operating logic**  
with a high degree of self-explanation, similar to modern communication devices
- » **2 major operating principles**
  - Operating/movement functions via tactile keys
  - Process functions on touch screen (access via RFID, key card or key ring)
- » **Process visualization**  
via 21.5" touch screen display (full HD), pivoting laterally
- » **New screen functions**
  - Uniform layout for all WITTMANN units
  - Recognition of gestures (wiping and zooming by finger movements)
  - Container function – split screen for sub-functions and programs
- » **Status visualization**  
uniform signaling system across the entire WITTMANN Group
  - Headline on the screen with colored status bars and pop-up menus
  - ambiLED display on machine
- » **Operator assistance**
  - QuickSetup: process parameter setting assistant using an integrated material database and a simple query system to retrieve molded part data with machine settings pre-selection
  - Extensive help library integrated



# The process in constant view



» **SmartEdit**

SmartEdit is a visual, icon-based cycle sequence programming facility, which enables direct addition of special functions (core pulls, air valves, etc.) based on a standard process via touch operation on the screen. In this way, a total user-defined sequence can be compiled from a sequence menu. This machine cycle, visualized either horizontally or vertically, can be adjusted simply and flexibly to the process requirements by finger touch with "drag & drop" movements.

**The advantages**

- Icon visualization ensures clarity.
- Clear events sequence through node diagram
- Alterations without consequences through "dry test runs"
- Theoretical process sequence can be quickly implemented in practice.
- Automatic calculation of the automation sequence based on the actual set-up data set without machine movements

» **SmartScreen**

- Partitioning of screen displays to visualize and operate two different functions simultaneously (e.g. machines and peripherals)
- Uniform design of the screen pages within the WITTMANN Group
- Max. 3 containers can be addressed simultaneously for the SmartScreen function.
- Adjustments of set values can be effected directly in the set value profile.

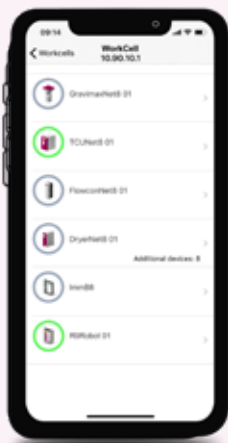
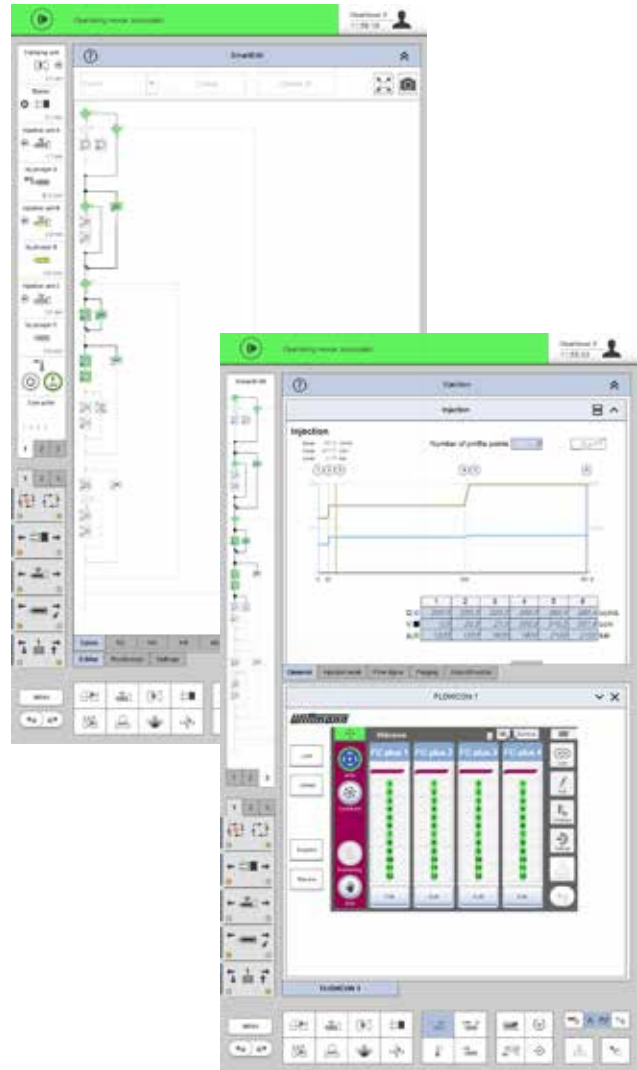

**Remote communication**

» **QuickLook 4.0**

Quick & easy production status check via Smartphone:

- Operation and status data from all Wittmann 4.0-compatible appliances in a production cell
- Complete overview of the most important production parameters
- Access to operation data, alarm signals and user-defined data
- The production cell overview offers a clear, simple overview of the production cell's general condition and that of its individual Wittmann 4.0 appliances.

» **Global online service network**

- Web-Service 24/7: direct Internet connection to WITTMANN BATTENFELD service
- Web training: efficient staff training by means of the virtual training center

# WITTMANN 4.0

## Communication in and with production cells

With its communication standard Wittmann 4.0, the WITTMANN group offers a uniform data transfer platform between injection molding machines and auxiliary equipment from WITTMANN. In case of an appliance change, the corresponding visualizations and settings are loaded automatically via an update function, following the principle of "Plug & Produce".

### Connection of peripherals via Wittmann 4.0

- » **WITTMANN Flowcon plus water flow regulator, Gravimax blenders and Aton dryers**
  - Units directly addressed and controlled via the machine's control system
  - Joint saving of data in the production cell, the machine and in the network via MES
- » **WITTMANN robots with R9 control system**
  - Operation of robots via the machine's monitor screen
  - High-speed communication between machine and robot to synchronize movements
  - Important machine movements can be set via the R9 robot control system
- » **WITTMANN Tempro plus D temperature controllers**
  - Setting and control of temperatures via the machine's control system possible
  - All functions can be operated either on the unit or via the machine's control system

### Integration in MES system

The integration of machines and complete production cells in an MES system is a prerequisite for an efficient and transparent production facility according to the Industry 4.0 concept.

Depending on customers' requirements, small and medium-sized companies as well as global players are offered a compact MES solution based on TEMI+. With the Windows® 10 IoT operating system it is also possible to have selected status information from all connected machines on the production floor shown under Smart-Monitoring on the display screen of every machine.

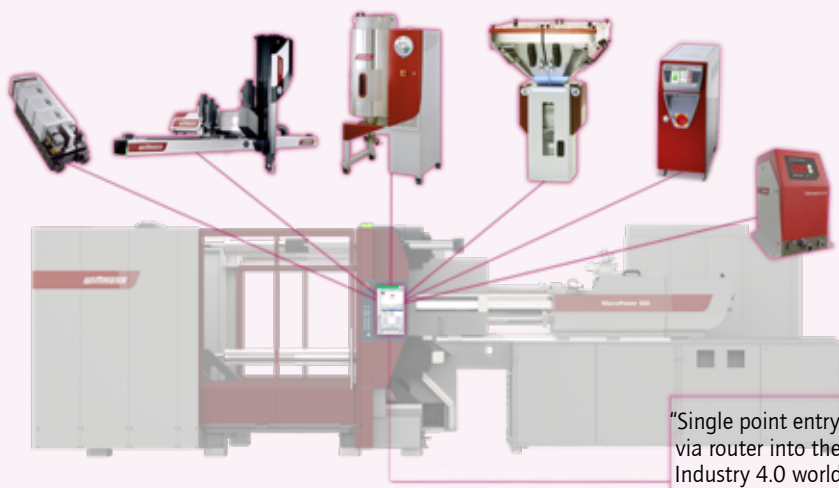
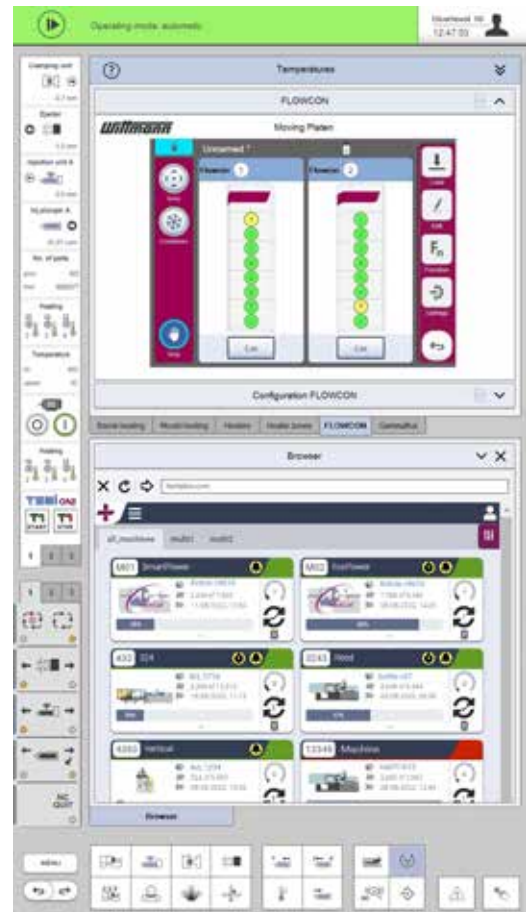

**Wittmann 4.0 system**  
With Wittmann 4.0, a machine and its robots and auxiliaries are transformed into a uniform technical organism, which communicates externally via a specific IP address. Such a "single point entry" with an integrated internal firewall substantially increases cyber security.

# OPTIONS

Modular and flexible

**Wittmann**



## MacroPower

### The optional highlights

- » **Tie-bar removal device**  
If the standard platen stroke to release the tie-bars is not sufficient for a mold change, a hydro-mechanical tie-bar removal device integrated in the pressure cushion is available as an option. Removing and pushing back the tie-bars are fully automatic processes taking no more than a few minutes.
- » **Servo-electric plasticizing**  
As an alternative to screw rotation by a hydro motor, an optional direct drive with a servomotor can be supplied. It reduces energy consumption and offers additional facilities for parallel operation of the clamping and plasticizing units.
- » **Free space for conveyor belt in the small sizes of large machines as standard**  
In the machines from 400 to 700 t clamping force, the machine frame comes prepared for the installation of a conveyor belt inside the frame for longitudinal transport of molded parts. An optional elevation of the frame to accommodate a conveyor belt for parts transport to the side can also be supplied.
- » **Fast media coupling**  
In addition to the ergonomically positioned standard connection points for cooling water, air and core pull hydraulics, optional fast coupling units can be installed (individual or system plates), which also accommodate the power connections for the hot runner heating circuits, temperature and pressure sensors and coding signals. The degree of automation can be further increased by adding a quick mold clamping system.
- » **WITTMANN peripherals**  
The comprehensive range of WITTMANN peripherals offers appropriate solutions for all secondary processes of injection molding, including parts handling, material feeding and drying, sprue recycling, mold cooling and temperature control. Via the optional Wittmann 4.0 integration package, all additional appliances can be integrated into the injection molding machine's program sequence according to the "Plug & Produce" principle.



# APPLICATION TECHNOLOGY

## Outstanding competence

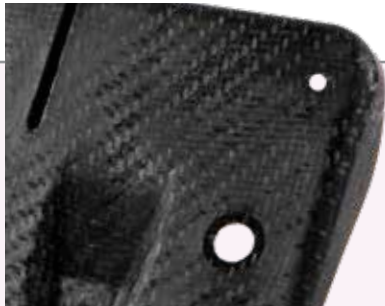

- » **Lightweight construction**  
MacroPower machines and WITTMANN handling technology including automation expertise offer ideal conditions for making large composite parts from flat fiber materials and injection-molded carrier structures.



- » **Cellmould – structured foam technology**  
The production of structured foam parts through targeted blending of pressurized nitrogen or carbon dioxide into the plastic melt prior to injection into the mold has been a WITTMANN BATTENFELD core competence based on in-house R & D for more than 30 years.



- » **Airmould – gas injection process**  
Airmould is the gas-assisted injection molding process developed by WITTMANN BATTENFELD. Its two variants are the Airmould internal gas pressure process and the Airmould CONTOUR external gas pressure process.



- » **Combimould**  
When two or more plastic materials in different colors or plastic materials with different attributes need to be combined into one component, the MacroPower machines can be equipped with additional injection units in V, L, S or HH configuration and rotary tables with servo drives.

Photo: Haidlmaier GmbH



# TECHNICAL DATA

## MacroPower

**Wittmann**



COMBINATIONS OF CLAMPING UNITS/INJECTION UNITS										
Clamping unit	Injection unit									
t	1330	2250	3400	5100	8800	12800	16800	19000	23300	33000
400	•	•	•	•						
450	•	•	•	•						
XL 450	•	•	•	•	•					
500	•	•	•	•	•					
550	•	•	•	•	•					
XL 550		•	•	•	•					
650		•	•	•	•					
700		•	•	•	•					
XL 700		•	•	•	•	•				
850		•	•	•	•	•				
900		•	•	•	•	•				
XL 900			•	•	•	•	•			
1000			•	•	•	•	•			
1100			•	•	•	•	•			
XL 1100				•	•	•	•	•	•	
1300				•	•	•	•	•	•	
1500				•	•	•	•	•	•	
1600				•	•	•	•	•	•	
XL 1600					•	•	•	•	•	•
1800					•	•	•	•	•	•
2000					•	•	•	•	•	•

Material	Factor
ABS	0.88
CA	1.02
CAB	0.97
PA	0.91
PC	0.97
PE	0.71
PMMA	0.94
POM	1.15
PP	0.73

The maximum shotweights (g) are calculated by multiplying the theoretical shot volume (cm<sup>3</sup>) by the above factor.

Material	Factor
PP + 20 % Talc	0.85
PP + 40 % Talc	0.98
PP + 20 % GF	0.85
PS	0.91
PVC hard	1.12
PVC soft	1.02
SAN	0.88
SB	0.88
PF	1.3
UP	1.6

Dark grey boxes = thermosets

# MOLD DIMENSIONS

## » Overview mold weights

The MacroPower series is laid out for the following maximum mold weights and/or mold torques. If the maximum weight or maximum torque is exceeded, an additional mold support will be necessary. Whenever the values are exceeded, WITTMANN BATTENFELD must be consulted.

$$W_m = 2/3 \times W$$

$$T_m = W_s \times \text{max. mold h.}/3$$

$$W_f = 1/2 \times W$$

$$T_f = W_f \times \text{max. mold h.}/4$$

$$W_c = 2/5 \times W$$

$$W_{\text{max.}} = W + W_c$$

Clamping Unit	Machine		Moveable platen		Fixed platen		Center platen	
	max. mold weight	max. mold height	max. weight	max. torque	max. weight	max. torque	max. weight	max. total weight
	W (t)	(mm)	W <sub>m</sub> (t)	T <sub>m</sub> (tm)	W <sub>f</sub> (t)	T <sub>f</sub> (tm)	W <sub>c</sub> (t)	W <sub>max</sub> (t)
400, 450	6.5	850	4.3	1.2	3.3	0.7	2.6	9.1
XL 450, 500, 550	8	900	5.3	1.6	4.0	0.9	3.2	11.2
XL 550, 650, 700	10	950	6.7	2.1	5.0	1.2	4.0	14.0
XL 700, 850, 900	12	1000	<b>8.0</b>	<b>2.7</b>	<b>6.0</b>	<b>1.5</b>	4.8	16.8
XL 900, 1000, 1100	19	1200	12.7	5.1	9.5	2.9	7.6	26.6
XL 1100, 1300, 1500, 1600	30	1400	20.0	9.3	15.0	5.3	12.0	42.0
XL 1600, 1800, 2000	45	1600	30.0	16.0	22.5	9.0	18.0	63.0

## » Mold torque calculation examples

MacroPower 850 t clamping force  
Mold weight W = 11 t

Mold weight clamping side W<sub>m</sub> = 7 t  
Distance to center of gravity x<sub>m</sub> = 0.3 m

Mold weight on fixed platen side W<sub>f</sub> = 4 t  
Distance to center of gravity x<sub>f</sub> = 0.2 m

$$T_m = 7 \text{ t} \times 0.3 \text{ m} = \mathbf{2.1 \text{ tm}}$$

$$T_f = 4 \text{ t} \times 0.2 \text{ m} = 0.8 \text{ tm}$$

All values within specifications, no additional support required.

MacroPower 850 t clamping force  
Mold weight W = 11 t

Mold weight clamping side W<sub>m</sub> = 8 t  
Distance to center of gravity x<sub>m</sub> = 0.4 m

Mold weight on fixed platen side W<sub>f</sub> = 3 t  
Distance to center of gravity x<sub>f</sub> = 0.2 m

$$T_m = 8 \text{ t} \times 0.4 \text{ m} = \mathbf{3.2 \text{ tm}}$$

$$T_f = 3 \text{ t} \times 0.2 \text{ m} = 0.6 \text{ tm}$$

Value T<sub>m</sub> exceeds specification, additional support required.

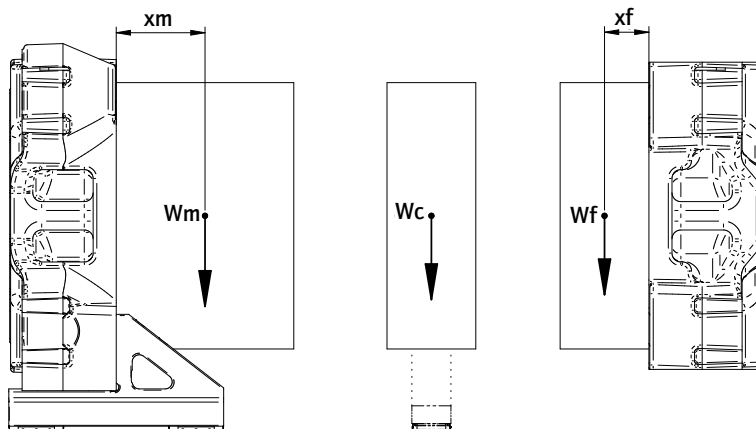

# REDUCTIONS IN CLAMPING FORCE

- » **Reductions in clamping force for smaller molds**  
The MacroPower machine series is laid out for minimum mold dimensions as indicated in the technical specifications. Down to the minimum mold size specified, the machine's clamping force can be fully utilized. When smaller molds are used, the clamping force must be reduced, depending on the mold dimensions, according to the overview below. The mold size used must not fall below the minimum mold dimensions specified in the chart.
- » **Example of clamping force reduction (chart)**  
MacroPower 850 t clamping force, mold dimensions 700 mm x 800 mm (smaller dimension is relevant). A mold dimension of 700 mm leads to a reduced maximum clamping force of 780 t.

- » **Mold parallelism**  
The MacroPower is equipped with high-precision linear guides on the moving platen and therefore guided with extreme accuracy and parallelism across the entire stroke.

Its platen parallelism is within half of EUROMAP 9 tolerance. For correct operation, the maximum parallelism of 0.2 mm with minimum mold dimensions must not be exceeded.

**PLEASE NOTE:**

The molds must be inserted symmetrically to both axes of the clamping platens!

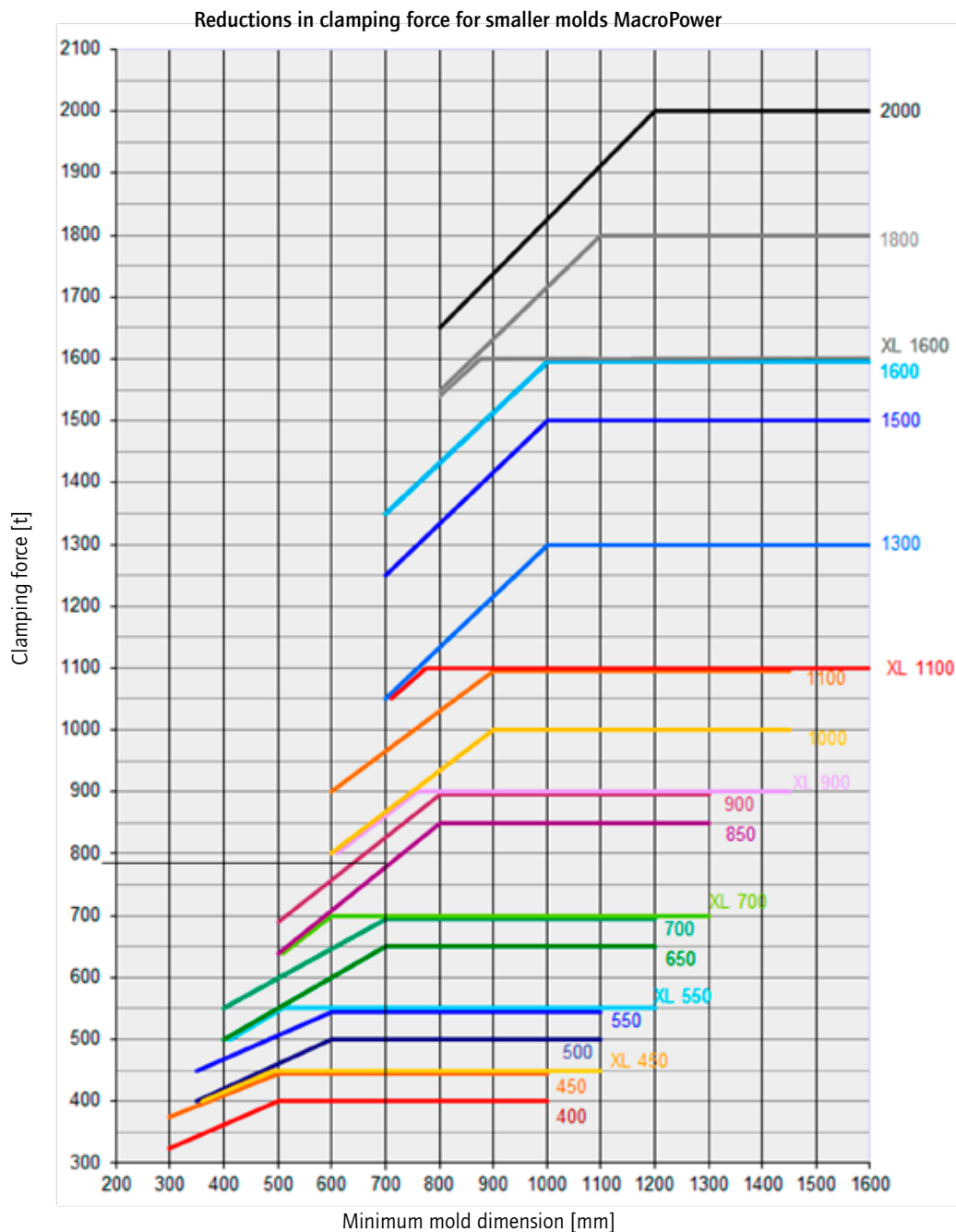

# STANDARD

## Base machine

Paint RAL 7016 anthracite / RAL 3004 crimson  
Two-piece machine frame, clamping unit/injection unit  
Built-in control cabinet

## Hydraulics

Drive unit with speed controlled servo motor for hydraulic pump incl. additional pump for core pull movement, parallel ejection and fast injection  
Bypass oil filtration by fine flow filter with electrical clogging indicator  
Oil level indicator with alarm  
Closed loop oil temperature control with oil pre-heating  
Oil temperature monitoring  
Lock-up valve with supervision for suction pipe  
Oil tank with connections for external oil filtration  
Hydraulic pressure displayed

## Clamping unit

Clamping force adjustable via touchscreen  
Closing and opening speed adjustable  
Closing and opening force adjustable  
Mold safety program  
Moving platen supported by positioned linear guides  
Platen drillings and register rings according to EUROMAP  
Fixing holes for robot on top of the fixed platen as per EUROMAP 18  
Central hydraulic multi-stroke ejector, adjustable  
Scanner in the mold area for protection against unauthorized access (from MacroPower XL 700)

## Injection unit

Closed loop controlled injection  
Screw L/D = 22 with check valve, wear and corrosion resistant screw and barrel AK+  
Thermocouple failure monitor  
Maximum temperature supervision  
Defined nozzle carriage pressure  
Plug-in ceramic heater bands  
Temperature control of feed throat integrated  
Open nozzle  
Purge guard electrically monitored  
Slide device without material hopper, prepared for WITTMANN material feeder  
Linear bearings for the injection unit  
Selectable barrel stand-by temperature  
Decompression before and/or after metering  
Physical units like bar, ccm, mm/s, etc.  
Screw protection  
Peripheral screw speed indication  
Linear interpolation of holding pressure set values  
Bar chart for barrel temperature with set value and actual value display  
Selectable injection pressure limitation  
Changeover from injection to holding pressure depending on stroke, time and pressure

## Safety gate

Monitored safety gate electrically controlled according to CE on front and rear side  
Maintenance-free safety gate locked by electromagnet  
Safety gate free for mold change and handling by robot  
Safety gate rear side lowered at the top of the upper tie-bar  
Safety gate rear side to be opened to max. daylight for easy mold change, from size 850 t

## Electrics

Operating voltage 230/400 V-3PH, 50 Hz  
ambiLED status indicator  
Fuse protection for sockets  
Non-contact stroke transducers  
USB 1 x operating units  
1 Ethernet interface (switch cabinet)  
Printer via USB connection or network

## Control system

Control system Unilog B8 – 21,5" multi-touch screen (full HD)  
Control panel with selectable haptic keys  
Clamp force display and supervision  
Software for operating hours counter  
Closing/Opening – 5 profile steps  
Ejection forward/back – 3 profile steps  
Nozzle forward/back – 3 profile steps  
Injection/Holding pressure – 10 profile steps  
Screw speed/Back pressure – 6 profile steps  
Parts counter with good/bad part evaluation  
Purging program through open mold  
Stroke zero offset settings  
Start-up program  
Switchover to holding pressure MASTER/SLAVE by injection time, screw stroke/injection volume and injection pressure  
Self-teaching temperature controller  
Display of temperature inside electrical cabinet  
Seven-day timer  
Access authorization via USB interface, password system and RFID authorization system  
Freely configurable status bar  
Physical, process-related units  
Automatic dimming  
Logbook with filter function  
User programming system (APS)  
Userpage  
Note pad function  
Cycle time analysis  
Hardcopy function  
Internal data storage via USB connection or network  
Online language selection  
Online selection of imperial or metric units  
Operator manual incl. hydr., mech. and electr. schedules online  
Time Monitoring  
BASIC Quality Monitoring (1 freely configurable network connection, quality table with 1000 storage depth, events protocol (logbook) for 1000 events, actual value graphics with 5 curves, 1 envelope curves monitoring)  
Injection integral supervision  
Metering integral supervision  
Alarm message via e-mail  
SmartEdit – sequence editor  
QuickSetup – assistance program for initial parameter setting



## Base machine

Non-standard mold height/opening stroke  
 Mounting of fast-stroking cylinder exchanged diagonally  
 Machine frame increased

## Hydraulics

Hydraulic accumulator for fast injection incl. loading pump  
 Fast injection with double pump  
 Injection parallel to clamp force build-up  
 Hydraulic core pulls. Limit switch function according to EUROMAP 13. Pressure and speeds adjustable  
 Core pull pressure release  
 Pneumatic core pull  
 Hydraulic manifold for Mouldmaster nozzle (controlling 1 nozzle or more, parallelly or sequentially, in the mold), with or without stand-alone servo drive unit  
 Pneumatic manifold for Mouldmaster nozzle (controlling 1 nozzle or more, parallelly or sequentially, in the mold)  
 Ejector pressure/speed controlled by P/Q servo valve  
 Filter in water inlet of oil cooler  
 Adapter with ball valve on the oil tank for oil maintenance

## Clamping unit

Support for middle plate or heavy molds  
 T-slots in mold platens  
 SPI bolt pattern  
 Ejector cross in clamping platen as per EUROMAP/SPI  
 Maximum ejector force increased  
 Ejector platen safety device  
 Hydromechanical mold safety mechanism  
 Air valve, action initiated (ON) and timer (OFF)  
 Tie-bar retract device for upper tie bar on operating or opposite operating side  
 Quick mold clamping system electromagnet. or hydr.

## Injection unit

Grooves in the feeding zone of barrel for improved feeding  
 High revolution hydraulic screw drive motor  
 High torque screw motor in lieu of standard  
 High temperature heaterbands (max. 450 °C)  
 Barrel insulation (standard up from injection unit 12800)  
 Screw drive by a.c. servomotor for parallel plasticizing  
 Ball type screw tip  
 Check valve with carbide insert  
 Needle type shut-off nozzle, pneumatically or hydraulically operated  
 Pneumatic cross-bolt type shut-off nozzle  
 Melt temperature sensor in cylinder head (up to injection unit 8800)  
 Pressure transducer for melt pressure switch over  
 Open Airmould nozzle, pressure controlled  
 Corrosion resistant screw and barrel AKCN in chrome nitride  
 High wear and corrosion resistant screw and barrel AK ++  
 Screw with mixing section or barrier section  
 Injection unit equipped for rigid PVC  
 Injection unit equipped for Cellmould  
 Slide device with spindle/crank handle adjustment (standard up from injection unit 12800)  
 Material hopper volume 60 liters  
 Hopper magnet  
 Access to material hopper via ladder and platform

## Safety gate

Front side gate safety system for manual part removal  
 Electric safety gate at the operator side, standard from size 1000 t  
 Safety gate clearance operator side/rear side extended

## Cooling and conditioning

Flow controller with temperature gauges  
 Shut-off valve for cooling water battery  
 Blow out valve for cooling water battery  
 Distributor of cooling circuits on the fixed platen and the moving platen  
 Cooling water flow rate integrated into control system via Flowcon plus

## Electrics

Temperature control zone for hot runner  
 Special voltage  
 Control cabinet cooler  
 Additional sockets  
 Emergency stop button on rear side  
 Signal tower with acoustic element  
 Temperature control interface digital, serial 20 mA TTY protocol  
 CAN-Bus-interface for mold conditioner as per EUROMAP 66-2  
 Interface for BFMOLD via CAN BUS for WITTMANN D series  
 Interface for Airmould mobile  
 Interface for robots as per EUROMAP 67  
 Interface for conveyor belt  
 Interface for dosing pump  
 RJG eDart interface  
 Master interface for danger zone boundary (DZB)/EUROMAP 78  
 Interface for full integration of robot incl. Ethernet switch  
 Host computer interface/PDA (EUROMAP 63/EUROMAP 77)  
 Relays contact parallel to plasticizing  
 Machine fault (potential-free contact)  
 BNC connectors for injection process analysis  
 Interface for vacuum pump

## Control system

Energy consumption analysis  
 Integrated Tandemmould  
 Switch over to holding pressure by cavity pressure  
 Switch over to holding pressure by external signal  
 Injection compression program/venting program  
 Melt cushion control  
 Second injection data setting for automatic start up  
 User specific programable set value limits  
 Web and remote service  
 HiQ Cushion - melt cushion control  
 HiQ Flow - injection integral control  
 HiQ Melt - monitoring of material quality  
 EXPERT Quality Monitoring (4 freely configurable network connections, quality table with 10000 storage depth, events protocol (logbook) for 10000 events, actual value graphic with 16 curves, 4 envelope curves monitoring, SPC charts, trend diagrams)

## Additional equipment

Lighting in mold space  
 Europackage  
 Webcam  
 Special paint and/or touch-up paint  
 Tool kit  
 Levelling pads  
 Additional manual on USB flash drive





The Wittmann logo is located in the bottom right corner of the page. It consists of the word "Wittmann" in a white, italicized, sans-serif font, set against a dark red, rounded rectangular background.

**WITTMANN BATTENFELD GmbH**

Wiener Neustädter Strasse 81

2542 Kottlingbrunn | Austria

Tel.: +43 2252 404-0

[info@wittmann-group.com](mailto:info@wittmann-group.com)

[www.wittmann-group.com](http://www.wittmann-group.com)