



DELLVIEW AREA COP

HOME SECURITY SURVEY

A Home Security Survey is a critical on-sight examination of a property to determine what the present security status is, identify any deficiencies or excesses of security, determine what level of protection is needed, and make recommendations to improve the overall security of the premises.

Most burglaries in San Antonio are committed by low- to medium-skilled burglars. They use such tools as rocks, screwdrivers, channel lock pliers, etc. to gain entry. Their targets are often selected at random, based on their perceived opportunity to successfully commit the crime. Due to the inadequate security of many premises, these relatively unskilled people can gain entry in 4 to 45 seconds.

This booklet is designed to help you understand how to improve the security of your home. All of the suggestions are relatively simple and do not cost a great deal to implement. While there are no foolproof methods for preventing burglaries, the tips in this booklet can make your home more crime resistant.

There are many good security devices that are not mentioned here. This booklet is meant to be used as a guide and a reminder only, and some items mentioned will not apply to you.

Necessary Precautions

Many of these recommendations call for minor modifications to be made to windows, doors, or other fixtures. When you implement these recommendations, caution must be exercised to prevent personal injury or unintended damage.

- If you feel that you lack the skills or tools necessary to make these modifications, please contact a qualified professional or a friend who has the expertise needed to perform these tasks safely.
- Eye protection should always be worn when performing the recommended modifications. All other appropriate safety measures must be observed as dictated by the tools being used and the manufacturer's instructions.
- Whenever you drill into a surface, be certain that there are no electrical wires, pipes, or other fixtures beneath the surface that may be damaged by the drill bit.
- When drilling near a window, great care should be taken to avoid drilling into the glass.
- If you are renting your residence, obtain permission from the owner/manager before making any modifications to the property.



DELLVIEW AREA COP

DOOR SYSTEMS

Hinged Doors

Reinforce Frame

One method of doing this is to replace one screw in each of the hinge plates with a 2½-inch screw. This will reach past the door frame into the 2x4 studs behind the door frame.

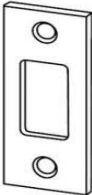

Security Strike Plate

The strike plate is the metal piece on the door frame that the deadbolt “throw” goes into. It should be 4 or more inches in length and be mounted with two or more case-hardened screws at least 3 inches long.

Single Cylinder Deadbolt

This lock has a keyway on the outside and a turn knob on the inside. It is recommended on all exterior doors. (If there is glass within 40 inches of the door lock, it should be covered with a security grille to prevent reaching through the glass area to unlock it.) The throw bolt should extend at least 1 inch from the edge of the door, and it should have a hardened steel pin inside the throw bolt. The lock should be installed with at least two ¼-inch case-hardened steel fasteners, and should have a tapered or rotating guard around the key section so that it cannot be compromised with a pair of pliers.

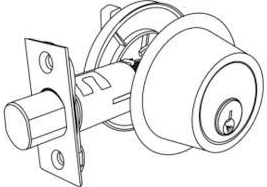

Double Cylinder Deadbolt

This lock is keyed in both the inside and outside, requiring a key to unlock it. It is the same as the single cylinder deadbolt, except the keyway on both sides of the door. For safety reasons, some city codes prohibit the installation of this type of lock. San Antonio is not one of those cities.

Pin Hinges

These are recommended for exterior doors that open out. A hinged door that opens out has the hinge pins on the outside, making it possible to remove the pins and open the door from the hinge side. To prevent this, remove one of the screws of the hinge (on the door frame side) and drive a nail into the hole, leaving the nail exposed ½ inch. Then cut off the head of the nail. Remove the matching screw from the other half of the hinge. The nail should now fit into this second hole when the door is closed, connecting the two parts of the hinge and securing the door from being opened by removing a hinge pin from the outside.

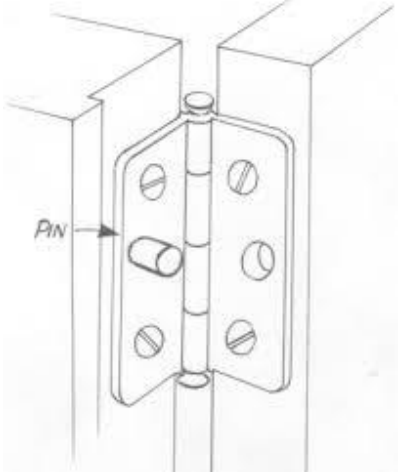



DELLVIEW AREA COP

Install A 190-Degree Viewer

A door viewer, or “peep hole” should be installed in all exterior doors where there is no visibility from inside to see who is at the door.

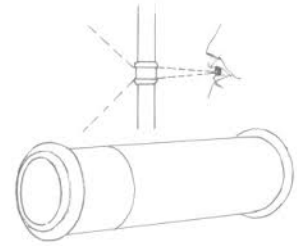

Double Door

Entrances that have two swinging doors that close in the middle should have flush bolts installed on one of the doors. These bolts extend up into the frame at the top and down into the floor at the bottom, providing a base to lock the other door to.

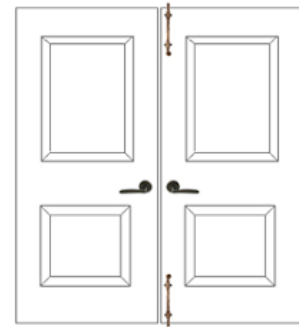
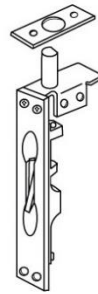
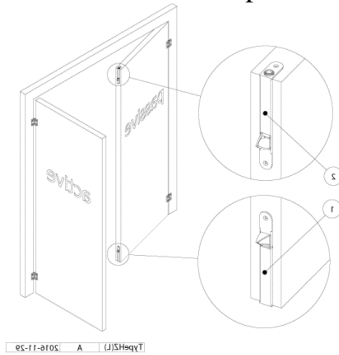

Replace Door

Any exterior door that is hollow core construction, or that is in weakened condition due to age or weathering should be replaced.

Grille Over Window In Door

Doors that are half wood/half window should be replaced or have a security grille installed over the glass part. Install this grille on the inside of the door, or use tamper resistant fasteners, such as round-headed thru-bolts, if installing the grille on the outside. (An alternative to replacing the door would be to install a security wrought iron door on that entrance.)

Sliding Door

Take Up Slack

Install panhead screws in the upper track of the movable panel of all sliding doors. The purpose is to prevent the sliding door from being lifted off the track and removed from the frame when it is in the closed position. These screws have rounded heads and should be installed about 2 feet apart. They should be screwed in so that the door can just barely slide by, while preventing it from being lifted up out of the track.

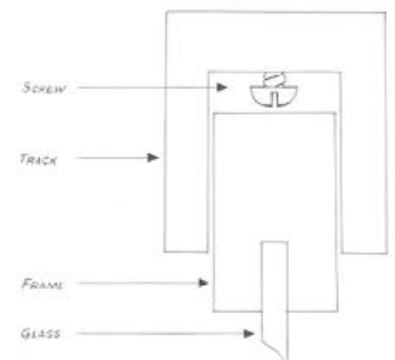



DELLVIEW AREA COP

Use Charlie Bar Or Stick

A Charlie bar is a commercially available device that mounts to the frame opposite the sliding door and swings down behind the door to stop it from sliding. A stick or dowel inserted snugly into the bottom track can be used in much the same way. (This recommendation will only work on doors that slide on the inside track.)

Pin Doors

With the door in the closed position, drill a small-diameter hole from the inside center frame through into the outside frame, but not through the outside frame. Insert a nail or other sturdy pin. To be most effective the hole should be made at a slight downward angle to prevent the pin from falling out if someone tries to lift the door up out of the frame. Caution: When drilling holes in the frame great care should be taken to avoid drilling into or striking the glass. Tempered glass will frequently shatter on contact with the drill bit.

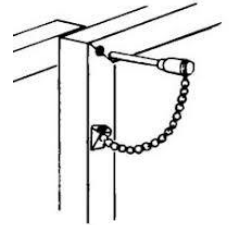

Auxiliary Latch (Or Lock)

Add another lock or latch to supplement existing one. This is recommended when the existing lock or latch provides inadequate protection.

Adjust Rollers

Some modern sliding doors can be adjusted in order to prevent lifting or removing the door when it is in the closed position.

Garage Doors

Add Auxiliary Lock

Add another lock or latch to supplement the existing one. This may include a padlock on garage doors.

Pin Track

On garage doors that roll up or slide overhead on a track, drill a hole in the track that the door moves in, while the door is in the closed position, and install a pin or padlock into the hole to prevent the door from moving along the track. If a pin is selected, it should be sturdy enough to withstand considerable pressure.

Electronic Door Opener

Garage doors that are opened by remote control can often be opened by anyone possessing a remote control. These controls can be changed to different frequencies by turning small dials inside, until your frequency is found and your garage door opens. Use a pin in the track to stop the door from moving when you are gone, or add an auxiliary lock. Consider unplugging your garage door opener if you are gone for a long period of time, such as a vacation.



DELLVIEW AREA COP

WINDOW SYSTEMS

Double Hung Windows

Pin Windows

With the window in the closed position, drill a small-diameter hole through the inside frame into the outside frame, but not through to the outside of the frame. The hole should be drilled at a slight downward angle to be most effective. Drill two holes for each window on each side of the window near the top. Insert a sturdy nail or pin in the holes. Caution: When drilling great care should be taken to avoid drilling into the glass.

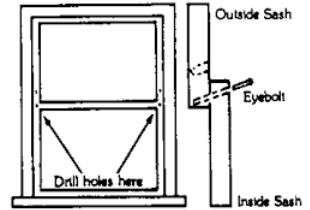

Install Auxiliary Latch

Add an additional device to supplement the existing latch or lock, such as a simple hook and eye commonly used on screen doors.

Secure Air Conditioning Unit From Inside

Many air conditioners simply sit in window frames supported on legs or by straps on the outside. Secure the unit from the inside by attaching a bar to the unit that extends past both sides of the window frame so that the unit cannot be removed from the outside.

Casement Windows

Adjust Or Replace Latch

If the latch is bent and not securing the window, adjust it so that the window closes and locks securely. If the latch is broken or cannot be adjusted it should be replaced. (Sometimes it is just covered by many layers of paint and when cleaned and realigned works again.)

Pin Latching Mechanism

Remove the latch from the window and drill a hole through the latch housing and latch while the latch is in the closed position. Insert a sturdy pin or nail that is removable. Do not use a screw or bolt; they would not allow escape if necessary.



Remove Crank

Removing the crank/handle may discourage someone from breaking the window pane to gain access to the handle. It does not stop the window from being opened. Do not screw or bolt the window shut.



DELLVIEW AREA COP

Install Clevis Pins

The standard latch on casement windows is relatively easy to defeat. Installing clevis pins provides an additional point of strength. At the top center of each movable window, drill a small-diameter hole through the window and the casement frame. This should be done from the outside, with the window closed securely. Caution: When drilling, great care should be taken to avoid drilling into the glass. Glass will frequently shatter on contact with the drill bit.

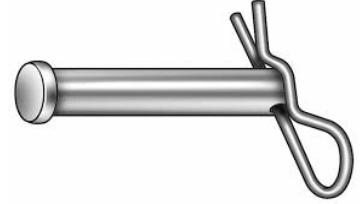

Sliding Windows

Pin Windows

See Sliding Doors.

Install Auxiliary Latch

There are many varieties. Most clamp into the window frame behind the sliding window to stop the window from sliding past that point. Consider using the type that has a pointed screw. Greater security can be gained by drilling a small indentation in the window frame to give the latch screw a place to grab onto. Do not tighten the screw so tight that you cannot escape if necessary.



Overhead Screws Or Lift Locks

These are recommended, along with auxiliary latches or a Charlie bar. Install lift locks or two round head screws (panhead) vertically into the upper track above the movable window about 6 inches in from the edges of the window frame. Adjust the screws until the window will just clear the screws as it slides. The screws will prevent the window from being lifted up and removed from the track from the outside.

Adjust Rollers

Some newer sliding windows have adjustable rollers or expanders that can be set so that the window cannot be lifted out of the track. An auxiliary latch is still recommended for additional protection.

MISCELLANEOUS OPENINGS

Secure Access To Attic

Any outside access doors to the attic or crawlspace should be secured with a hasp and padlock or covered by a security grille.



DELLVIEW AREA COP

Secure Access To Basement

All basement doors and windows may be secured using the same methods listed under Door Systems and Window Systems. Access to crawlspaces under the house should be secured with a hasp and padlock or covered by a security grille.

Block Off Or Replace Pet Door

Any opening larger than 9 inches by 10 inches can be used to gain entrance to a home. You should block off pet doors by building a frame that allows you to slide a security plate into the opening when you will be gone, or look for the new security pet doors that will allow only your pet to enter, and/or do not allow a person to enter because of a trap or maze system.

Secure Skylight

Skylights should be fastened securely to the roof with sheet screws (if installed from the outside, screws should be non-removable). Another option would be to install bars or a grille inside the house at or just above ceiling level.

EXTERIOR

Trim Shrubbery

Windows and doors should be clearly visible to neighbors and the street. Trees should be trimmed up 6 feet from the ground. Bushes should be trimmed down to 3 feet and below windowsill level so no one can hide behind them while tampering with the window or looking in.

Add Security Plants

Plants such as thorny cacti, pyracantha, and acacia bushes or trees all provide natural security barriers when planted along your property lines and underneath windows. Additionally, they are low water users and require little maintenance once established.

House Numbers—Front, Rear, and Roof

House numbers at least 5 inches high should be clearly visible from the street. If possible, they should be lighted or reflective and be located near the street, facing both directions. House numbers should also be located on the rear fence or gate. House numbers on the roof assist the helicopter crew. These should be NON-reflective, and be done in a color that contrasts to the roof. They need to be 3½ feet to 4 feet high to be visible to the helicopter crew.

Additional Lighting

You should have lights at your front, back, and carport areas. These should be left on all night. “Dusk to dawn” or photocell fixtures should be installed/attached to the light fixtures, so that your exterior lights come on automatically at dark and do not give clues about whether or not you are home.





DELLVIEW AREA COP

Consider motion detector lights for large yards or areas such as a side yard that are hidden from view, but provide a place to hide. Porch and carport area lights need only be 60-watt light bulbs. Lighting your home in this manner provides one of the cheapest, most effective crime deterrents available.



Lock Gates

An open gate is an invitation to the criminal. Although locking a gate does not prevent someone from jumping the gate or fence, it does make an intruder appear much more suspicious, and your neighbors will be more likely to call police to report such activity. It is also much harder to carry large items over the fence, and it takes more time. Make sure the hardware is installed using thru-bolts with round heads so that they cannot be removed from the outside.

Secure Tools And Other Property

Tools such as hammers, screwdrivers, pliers, ladders, etc., that are left lying around or stored in the open may provide the means for a criminal to gain entry into your home. Bicycles, skateboards, etc., left lying around may entice someone onto your property to commit a petty theft. Once there, he may decide to commit a burglary.

SECURITY & SAFETY

Smoke Or Fire Alarm

When you upgrade the security of your home or property, make certain that you can get out quickly and safely in an emergency. Install and/or inspect all smoke/fire alarms, and plan escape routes. Practice using all escape routes. (Wrought iron grilles/bars on bedroom windows must have an escape latch—make certain that it is checked regularly to be sure it does not rust shut.)

Burglar Alarm

Intrusion detection alarms are not always necessary, and are usually recommended on the basis of the individual crime risk of your residence—for example, if you have expensive jewelry, or a gun collection.

Bank Or Safe Deposit Box

If you have very valuable jewelry, stamps, etc., that you rarely use, keep them in a safe deposit box instead of at home to reduce the risk of them being stolen.

Insurance Rider

Many people are not aware that their homeowners insurance does not cover, or is limited in covering, jewelry, guns, computers, and other specialty items. Ask your insurance company about what items would not be covered, or have limited coverage. Check into purchasing an insurance rider that will cover these items.



DELLVIEW AREA COP

Security Cabinet Or Safe

If you prefer to keep your valuables at home, consider installing a home safe or a security cabinet.

Security Closet

Any closet in your home that has a swing door on it can be converted to a security closet. It should have a solid core door, a good single cylinder deadbolt lock, and a security strike plate. If the door opens out, be sure to pin the hinges.

OPERATION IDENTIFICATION

Engrave Property

Marking your property may not prevent it from being stolen, but it does increase the chances of that property being returned to you if it is stolen. Mark your property in two places: one obvious and one hidden. Use your drivers license or state I.D. card number: L123456/AZ/94 (license number/state/expiration year). Electric engraving tools can be purchased at hardware stores and large department stores in the “tools” section.



Photograph Valuables

Make individual color photographs of items such as silver, coin collections, jewelry, etc., that cannot be marked or engraved. Sign and date the backs of the photographs to assist in proving ownership.

Update Inventory

Make a current list of property that is marked or photographed and list its value. Copy all serial numbers available to you onto this list. Keep the list updated regularly.

Spread Risks

Do not keep all of your valuables in one place. The first place a burglar looks when he enters your home is the master bedroom and the bureau drawers. Find several hiding places that would not be easily found by someone searching your home. Be creative.