

Spannsysteme
Clamping Systems

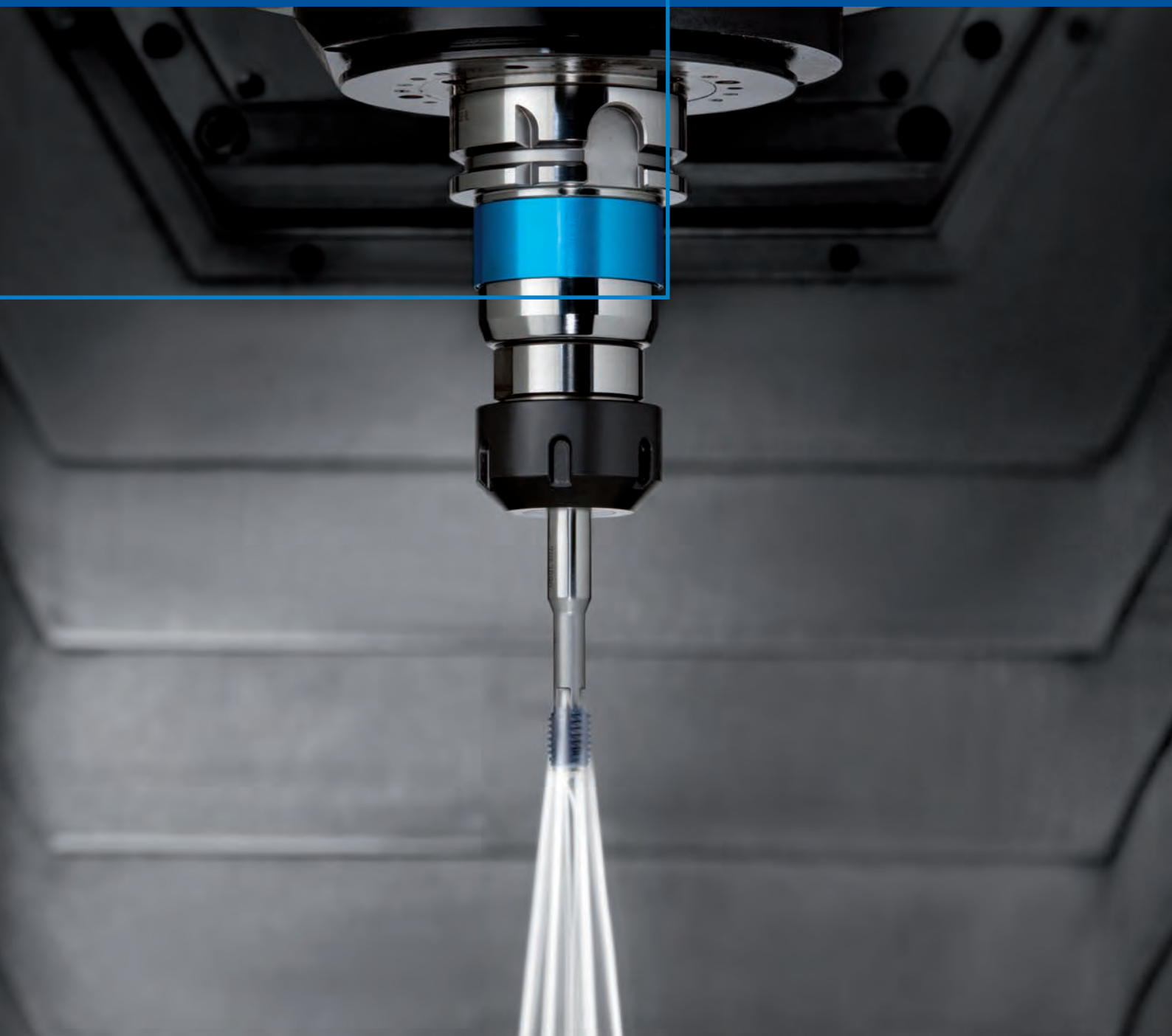























4	Übersicht, Zeichenerklärung Overview, signs and symbols
6	SCK – Synchro Gewindeschneidfutter SCK – Synchro Tapping Chucks
36	WFLC-WFLC K – Gewindeschneid-Schnellwechselfutter WFLC-WFLC K – Quick change tapping chucks
60	WFLK – Gewindeschneid-Schnellwechselfutter WFLK – Quick change tapping chucks
68	GNCN-GNCK – Gewindeschneidapparat für NC-Bearbeitung GNCN-GNCK – Tapping attachments for NC-machining
74	WFSL – Gewindeschneid-Schnellwechselfutter WE – Einsätze WFSL – Quick change tapping chucks, WE – adaptors
88	WFLP-WF – Gewindeschneid-Schnellwechselfutter WFLP-WF – Quick change tapping chucks
98	WE-WES...B – Schnellwechseleinsätze WE-WES...B – Quick change tapping adaptors
132	Einstellwerkzeuge für WES Einsätze Adjustment tools for WES adaptors
135	GBV – Gewindebohrer-Verlängerungen GBV – Tap extensions
138	DSPL-D – Gewindeschneidfutter DSPL-D – Tapping chucks
144	TA – Gewindeschneidapparat für manuelle Betätigung TA – Tapping attachments for manual use
148	SBK – Schnellwechsel-Bohrfutter SBK – Quick Change Drilling Chuck
154	ASR/WZHR – aufsetzbare Schnellwechselbohrfutter, Werkzeughalter ASR/WZHR – Adaptable quick change drilling chucks, toolholders
162	ASB-ASBA – aufsetzbare Schnellwechselbohrfutter, Werkzeughalter ASB-ASBA – Over spindle quick change drilling chucks, toolholders
171	Technische Information, Drehmomente, Schaftabmessungen Technical Information, torque, shank dimensions



Schnellwechselbohrfutter Quick change drilling chucks					
	Seite Page		Seite Page		Seite Page
SBK/MK	150	ASR	156	ASB / ASBA	164
SEK/B	150	Bedienungsanl. Oper. Instruction	157	ASBV / ASBVA	165
SEK/ESX	151	WZHR...N/E	158	Stellhülsen Adjustable adaptors	166 - 167
SEK/MK	151	WZHR...NK/E	159	SSM/SM	168
SEK/RF	152	WZHR...ESX	160	Klemmhülsen Adjustable adaptors	169
SELK	153	WZHR...K/ESX	161	Bedienungsanl. Oper. Instruction	170

BOHREN DRILLING

Synchro Gewindeschneid- futter Synchro Tapping Chucks	Gewindeschneid Schnell- wechselfutter Quick change tapping chucks	Gewindeschneid Schnell- wechselfutter Quick change tapping chucks	Gewindeschneidapparate Tapping attachments	Gewindeschneid Schnell- wechselfutter Quick change tapping chucks					
	Seite Page	Seite Page	Seite Page	Seite Page	Seite Page				
SCK - ESX	7 - 12	WFLC...(IK)/HSK-A	38 - 39	WFLK/MK	62	GNCN-GNCK	70 - 72	WFSL	76 - 77
SCK - MMS	14 - 17	WFLC...(IK)/HSK-C	40 - 41	WFLK/A126/SK	63			WEK	79
SCK - BZ	18 - 19	WFLC...(K)/W-MS	42 - 45	WFLK/TR	64	Benötigte Info Required Info	71	Bedienungsanl.	80 - 81
UE - HSK	20 - 21	WFLC...(K)/TR	46 - 47	WFLK/A308	65	BN 17 ... - ...	72	Oper. Instruction	82 - 83
SCK - Instr.	22 - 25	WFLC.../A126	48 - 49	WFLK/A73/SK	66			Drehmomente Torque	84 - 86
Zubehör Accessories	26 - 35	WFLC...	49 - 59	WFLK/SK	67	Spannzange ESX Collet ESX	34		

GEWINDESCHNEIDEN TAPPING

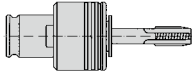
-  Rundlauf
Concentricity
-  Längennachstellung
Length adjustment
-  Längenausgleich Druck
Length compensation compression
-  Längenausgleich Zug
Length compensation tension
-  achsparallele Pendelung
Radial parallel float
-  Sicherheitskupplung
Safety clutch
-  Minimalmengenschmierung (MMS) 10 bar
Minimum quantity lubrication (MQL) 10 bar
-  Ansnittdruckverstärker, nur bei Druckausgleich,
nicht bei WFLK-Gr. 0
Hard start, only with compression,
not at WFLK size 0
-  kugelgelagert
Ball carried
-  Kühlmitteldurchführung
Coolant feed
-  Rubber-Flex®
Rubber-Flex®
-  Spanschlüssel
Wrench
-  Dichtscheibe
Sealing disc
-  Spannzange
Collet
-  Schraube
Screw
-  Mutter
Collet nut
-  Futter SBK
Quick change chuck SBK
-  Einsatz SEK
Quick change adapter SEK
-  Einsatz WES
Quick change adapter WES
-  Gewindegröße
Thread size
-  mit Querkeilschlitz
with cotter slot
-  Einsatz WEK
Quick change adapter WEK
-  Gewindeschneidfutter
Tapping chuck

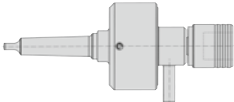
											
		Gewindeschneid Schnell- wechselfutter Quick change tapping chucks		Gewindeschneid Schnell- wechseleinsätze Tapping attachments		Gewindebohrer-Verlänge- rungen Tap extension		Gewindeschneidfutter Tapping chucks		Gewindeschneidapparate Tapping attachments	
	Seite Page		Seite Page		Seite Page		Seite Page		Seite Page		Seite Page
WF/HSK...	90	WE/WEN...	100-117	GBV	136-137	DSPL/MK	140	TA / MK-WF	146		
WF/WFP... MS	91	WES/WESN	118-131			DSPL/B	140	Bedienungsanl. Oper. Instruction	147		
WF/WFP...TR	92-93	GE	134-135			DSP/B	141				
WFL/WFLP...TR	94-95					D/B	141				
WF/WFP...B	96					B...xMK... V...-SW...	142	WE	104-106		
WF/WFL...MK	97					Bedienungsanl. Oper. Instruction	143	WES	118-121		

Anwendung: Gewindeschneiden, -formen
auf Maschinen mit synchronisiertem Vorschub (Drehzahl/Vorschub Synchronisation, auch Rigid Tapping genannt)

Maschinentyp: Bearbeitungszentren, CNC-Drehmaschinen, Sondermaschinen mit synchronisiertem Vorschub
beim Gewindeschneiden

Application: tapping, roll forming
on machines with synchronized feed (speed/feed synchronisation, also named Rigid Tapping)

Machine type: machining centres, CNC-turning and special purpose machines with synchronized feed
for the tapping operation

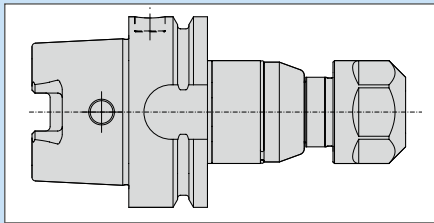

Die neueste Generation SCK- Synchrofutter wurde den aktuellen Marktanforderungen angepasst. Die Werkzeugvoreinstellung ist von Maschinenseite und Werkzeugseite aus möglich, die Schmierstoffdurchführung wurde optimiert, dadurch ist eine leckagefreie Übergabe zum Gewindebohrer gewährleistet. Der Längenausgleich auf Druck und Zug (z. B. +/- 0,15 mm), sowie die radiale Dämpfung kompensieren kleinste Synchronisationsfehler und Lageabweichungen. Dadurch wird der Druck auf die Gewindeflanken des Werkzeuges verringert und das erforderliche Schneidmoment minimiert. Die verwendeten Elastomere sind formstabil und beständig gegen alle Kühl-/Schmierstoffe. Durch den definierten Längenausgleich wird eine plastische Verformung der Dämpfungselemente ausgeschlossen. Dies führt zu einem gleich bleibenden Schneidverhalten über die gesamte Lebensdauer des Werkzeuges.

Market demands have triggered the development of the new design BILZ synchro chucks. Adjustment of the chuck with regard to the taps pre-setting position can be completed from both sides of the chuck, the minimum quantity lubrication has been optimised and comes with an absolute leak free application of lubrication flow to the tap. The tension and compression length compensation, (e.g. +/- 0,15 mm) in combination with radial dampening effect compensates small synchronisation and location anomalies. Through this defined application compensation the user achieves reduced tap flank wear in combination with considerably less cutting loads which in turn increases tap life and is more machine friendly. The use of the "Elastomere" dampening and length compensating elements are form-secure, they are also resistant to all coolant substances used in today's modern industries. Dampening elements remain stable due to the predetermined length compensation thus eliminating any potential plastic deformation. This results in a constant cutting condition and therefore the user benefits.

Merkmale:	Vorteile:	Nutzen:
<ul style="list-style-type: none"> ■ minimaler Längenausgleich auf Druck und Zug 	<ul style="list-style-type: none"> ■ Abbau des Druckes auf die Gewindeflanken ■ Kompensation von Synchronisationsfehlern 	<ul style="list-style-type: none"> ■ Höhere Standzeit der Gewindebohrer, geringerer Werkzeugbedarf,- verschleiß ■ verringerte Bruchgefahr ■ bessere Gewindequalität
Features:	Advantages:	Benefits:
<ul style="list-style-type: none"> ■ minimum compensation on tension/compression 	<ul style="list-style-type: none"> ■ reduction of the pressure on the thread flanks ■ compensation of the synchronisation error, while reversing the spindle 	<ul style="list-style-type: none"> ■ higher life time of the taps, less number of tools required ■ reduced risk of tool breakage ■ better thread quality

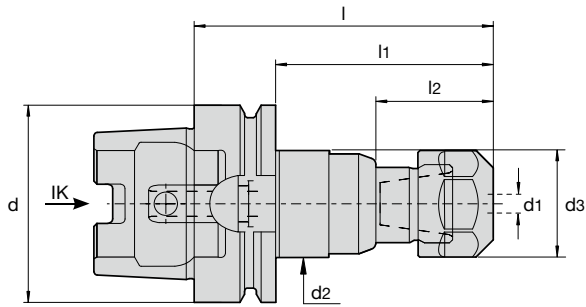

SCK/HSK-A – ESX

Bezeichnung/Id. Nr. Designation/Id. No.		d	 d1	d2	d3	l	l1	l2	 		
SCK0-69/HSK-A40-ESX12-BL 5053610	+/-0,15	40	M2 – M8 2,8 – 6,0	25	25	69	49	24,5	Spanneinheiten und Ersatzteile siehe Seite 10 – 12, 26 – 29 Clamping units and components see page 10 – 12, 26 – 29	DIN902-17 6953508	EX12-Ø-IC
SCK0-75/HSK-A50-ESX12-BL 5040620	+/-0,15	50	M2 – M8 2,8 – 6,0	25	25	75	49	24,5		DIN902-17 6953508	EX12-Ø-IC
SCK1-89,5/HSK-A40-ESX20-BL 5053602	+/-0,15	40	M4 – M12 4,5 – 11,2	34	34	89,5	69,5	37,5		DIN 984-30 6934034	EX20-IC 6931227
SCK1-94/HSK-A50-ESX20-BL 5052056	+/-0,15	50	M4 – M12 4,5 – 11,2	34	34	93,5	67,5	37,5		DIN 984-30 6934034	EX20-IC 6931227
SCK1-95,5/HSK-A63-ESX20-BL 5010567	+/-0,15	63	M4 – M12 4,5 – 11,2	34	34	95,5	69,5	37,5		DIN 894-30 6934034	EX20-IC 6931227
SCK1-160/HSK-A63-ESX20-BL 5013409	+/-0,15	63	M4 – M12 4,5 – 11,2	34	34	160	134	37,5		DIN 894-30 6934034	EX20-IC 6931227
SCK1-100/HSK-A80-ESX20-BL 5053619	+/-0,15	80	M4 – M12 4,5 – 11,2	34	34	100	74	37,5		DIN984-30 6934034	EX20-IC 6931227
SCK1-102/HSK-A100-ESX20-BL 5012119	+/-0,15	100	M4 – M12 4,5 – 11,2	34	34	102	73	37,5		DIN 894-30 6934034	EX20-IC 6931227
SCK2-124/HSK-A50-ESX32-BL 5040633	+/-0,15	50	M8 – M20 6 – 18	50	50	124	104	43,5		E32 6921609	EX32-IC 6933897
SCK2-109/HSK-A63-ESX32-BL 5011981	+/-0,15	63	M8 – M20 6 – 18	50	50	109	83	43,5		E 32 6921609	EX32-IC 6933897
SCK2-113,5/HSK-A80-ESX32-BL 5040636	+/-0,15	80	M8 – M20 6 – 18	50	50	113,5	87,5	43,5		E32 6921609	EX32-IC 6933897
SCK2-115,5/HSK-A100-ESX32-BL 5012062	+/-0,15	100	M8 – M20 6 – 18	50	50	115,5	86,5	43,5		E 32 6921609	EX32-IC 6933897
SCK3-146,5/HSK-A63-ESX40-BL 5017524	+/-0,8	63	M14 – M30 11 – 22	63	58,5	146,5	120,5	50,3		E 40 6921610	EX40-IC 6948425
SCK3-136/HSK-A80-ESX40-BL 5040638	+/-0,8	80	M14 – M30 11 – 22,0	63	58,5	136	110	50,3		E40 6021610	EX40-IC 6948425
SCK3-138/HSK-A100-ESX40-BL 5017526	+/-0,8	100	M14 – M30 11 – 22	63	58,5	138	109	50,3		E 40 6921610	EX40-IC 6948425
SCK4-205/HSK-A100-ESX50-BL 5085403	+/-2,0	100	M30 – M42 22 – 32	100	78	205	176	66		E 50 6951711	EX50-IC 5085410

Kühlmittelrohr ist im Lieferumfang enthalten. Spanneinheit (Seite 10 – 12) und Spannschlüssel (Seite 26 – 29) sind nicht im Lieferumfang enthalten.
Coolant tube included. Clamping unit (page 10 – 12) and wrench (page 26 – 29) not included.



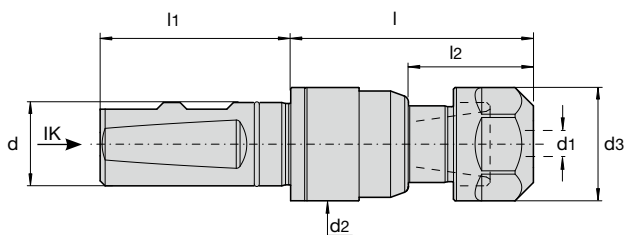

DIN 1835 B+E



SCK/W – ESX

Bezeichnung/Id. Nr. Designation/Id. No.													
			d	d1	d2	d3	l	l1	l2				
SCK0-50/W16-ESX12-BL 5053631	+/-0,15		16	M2 – M8 2,8 – 6,0	25	25	50	49	24,5	Spanneinheiten und Ersatzteile siehe Seite 10 – 12, 26 – 29 Clamping units and components see page 10 – 12, 26 – 29	DIN902-17 6953508	EX12-Ø-IC	
SCK1-73/W20-ESX20-BL 5053635	+/-0,15		20	M4 – M12 4,5 – 11,2	34	34	73	51	37,5		DIN894-30 6934034	EX20-IC 6931227	
SCK1-73/W25-ESX20-BL 5012220	+/-0,15		25	M4 – M12 4 – 11,2	34	34	73	57	37,5		DIN 894-30 6934034	EX20-IC 6931227	
SCK2-87,5/W25-ESX32-BL 5012276	+/-0,15		25	M8 – M20 6 – 20	50	50	87,5	57	43,5		E 32 6921609	EX32-IC 6933897	
SCK3-113,5/W32-ESX40-BL 5017528	+/-0,8		32	M14 – M30 11 – 22	63	58,5	113,5	61	50,3		E 40 6921610	EX40-IC 6948425	
SCK4-176/W40-ESX50-BL 5085404	+/-2,0		40	M30 – M42 22 – 32	100	78	176	71	66		E 50 6951711	EX50-IC 5085410	

SCK0... /ESX12 werden ohne Spannmutter ausgeliefert (siehe SPE, Seite 10)
 SCK0... /ESX12 are delivered without nut (see SPE, page 10)

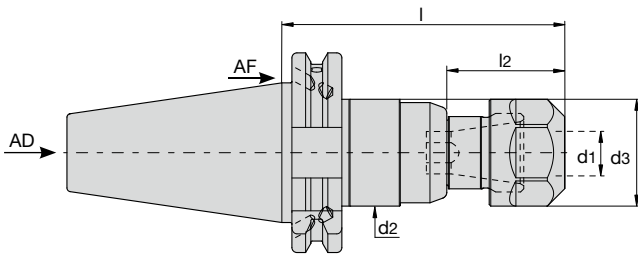

SCK/ADF – ESX (Alt/Old: DIN 69871, ADB)											
Bezeichnung/Id. Nr. Designation/Id. No.				d1	d2	d3	l	l2			
SCK1-90/ADB40-ESX20-BL 5053645	+/-0,15			M4–M12 4,5–11,2	34	34	90	37,5	Spanneinheiten und Ersatzteile siehe Seite 10 – 12, 26 – 29 Clamping units and components see page 10 – 12, 26 – 29	DIN 894-30 6934034	EX20-IC 6931227
SCK1-90/ADB50-ESX20-BL 5053646	+/-0,15			M4–M12 4,5–11,2	34	34	90	37,5		DIN 894-30 6934034	EX20-IC 6931227
SCK2-101/ADB40-ESX32-BL 5053647	+/-0,15			M8–M20 6–18	50	50	101	43,5		E 32	EX32-IC 6933897
SCK2-101/ADB50-ESX32-BL 5053648	+/-0,15			M8–M20 6–18	50	50	101	43,5		E 32	EX32-IC 6933897
SCK3-123/ADB50-ESX40-BL 5053649	+/-0,8			M14–M30 11–22	63	58,5	123	50,3		E 40	EX40-IC 6948425
SCK4-212/ADB50-ESX50-BL 5085407	+/-2,0			M30–M42 22–32	100	78	212	66		E 50	EX50-IC 5085410

Spanneinheit (Seite 10 – 12) und Spanschlüssel (Seite 26 – 29) sind nicht im Lieferumfang enthalten.
Clamping unit (page 10 – 12) and wrench (page 26 – 29) not included.

DIN 69871

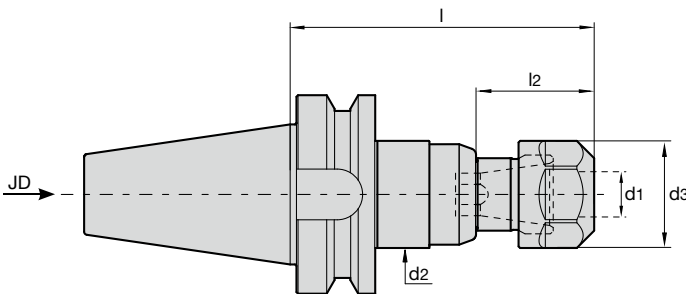

SCK/JD – ESX (Alt/Old: MAS403, BT)											
Bezeichnung/Id. Nr. Designation/Id. No.				d1	d2	d3	l	l2			
SCK1-91,5/BT30-ESX20-BL 5049400	+/-0,15			M4–M12 4,5–11,2	34	34	91,5	37,5	Spanneinheiten und Ersatzteile siehe Seite 10 – 12, 26 – 29 Clamping units and components see page 10 – 12, 26 – 29	DIN984-30 6934034	EX20-IC 6931227
SCK1-96,5/BT40-ESX20-BL 5053652	+/-0,15			M4–M12 4,5–11,2	34	34	96,5	37,5		DIN 894-30 6934034	EX20-IC 6931227
SCK1-107,5/BT50-ESX20-BL 5053653	+/-0,15			M4–M12 4,5–11,2	34	34	107,5	37,5		DIN 894-30 6934034	EX20-IC 6931227
SCK2-120/BT30-ESX32-BL 5053654	+/-0,15			M8–M20 6–18	50	50	120	43,5		E 32	EX32-IC 6933897
SCK2-110/BT40-ESX32-BL 5053655	+/-0,15			M8–M20 6–18	50	50	110	43,5		E 32	EX32-IC 6933897
SCK2-121/BT50-ESX32-BL 5053656	+/-0,15			M8–M20 6–18	50	50	121	73,5		E 32	EX32-IC 6933897
SCK3-141,5/BT50-ESX40-BL 5053658	+/-0,8			M14–M30 11–22	63	58,5	141,5	50,3	E 40	EX40-IC 6948425	

Spanneinheit (Seite 10 – 12) und Spanschlüssel (Seite 26 – 29) sind nicht im Lieferumfang enthalten.
Clamping unit (page 10 – 12) and wrench (page 26 – 29) not included.

DIN 69871



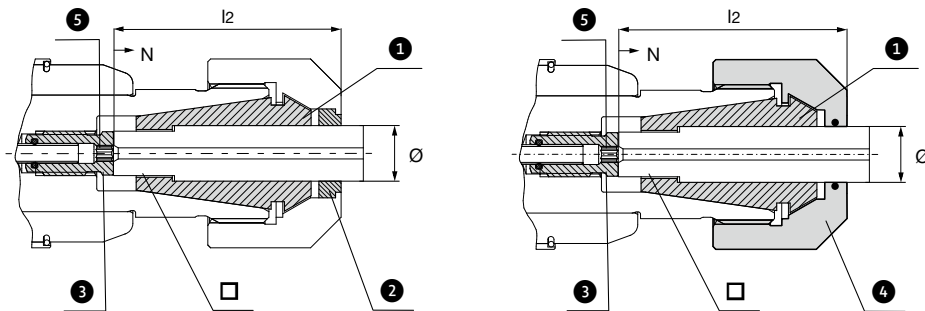

N = Nachstellung
Adjustment
l2 = Einstecktiefe
Insert depth
Ø = Schaftdurchmesser
Shank diameter
□ = Schaftvierkant
Drive square



ESX DIN/ISO											
Spanneinheit – ESX Ausführung C						Clamping unit ESX Version C					bestehend aus: consisting of:
Bezeichnung/Id. Nr. Designation/Id. No.	SCK.../ ESX...	Ø x □	DIN	ISO	l2	N	1	2	3	5	
SPE4x3,2C-ESX12 5020194	SCK0/ ESX12	4 x 3,15/3,2		M4 M5	23,5	2	ESX12GB-4x3,15/3,2 5020195	EX12-4-IC 5020211	SCK010C-4x3,2 5020198	2	
SPE4,5x3,4C-ESX12 5020214		4,5 x 3,4	M4 M6		23,5		ESX12GB-4,5x3,4 5020217	EX12-4,5-IC 5020219	SCK010C-4,5x3,4 5020221		
SPE5x4C-ESX12 5020215		5,0 x 4,0		M5	24,5		ESX12GB-5x4 5020218	EX12-5-IC 5020220	SCK010C-5x4 5020222		
SPE6x4,9C-ESX12 5020216		6,0 x 4,9	M5, M6, M8		25,5		ESX12GB-6x4,9 6950826	EX12-6-IC 6952625	SCK010C-6x4,9 5020223		
SPE4,5x3,4C-ESX20 5013770	SCK1/ ESX20	4,5 x 3,4	M4 M6		29	2	ESX20GB-4,5x3,4 6948389	DS/ER20-4,5 6948386	SCK110C-4,5x3,4 5013780	2,5	
SPE5x4C-ESX20 5013774		5,0 x 4,0		M5	30		ESX20GB-5x4 6949763	DS/ER20-5 6953236	SCK110C-5x4 5013781		
SPE6x4,9C-ESX20 5012479		6,0 x 4,9	M5, M6, M8		31	ESX20GB-6x4,9 6948390	DS/ER20-6 6943901	SCK110C-6x4,9 5012783			
SPE6,3x5C-ESX20 5073202		6,3 x 5,0		M6 M8		ESX20GB-6,3x5 6951397	DS/ER20-6,5 6953031	SCK110C-6x4,9 5012783			
SPE7x5,5C-ESX20 5012480		7,0 x 5,5	M7, M9, M10			ESX20GB-7x5,5 6949767	DS/ER20-7 6950178	SCK110C-7x5,5 5012792			
SPE7,1x5,6C-ESX20 5073203		7,1 x 5,6		M9	36	ESX20GB-7,1x5,6 6953228	DS/ER20-7,5 6953237	SCK110C-7x5,5 5012792			
SPE8x6,2/6,3C-ESX20 5012481		8,0 x 6,2/6,3	M8 M11	M8 M10		ESX20GB-8x6,2/6,3 6949202	DS/ER20-8 6946991	SCK110C-8x6,2 5012793			
SPE9x7/7,1C-ESX20 5012482		9,0 x 7,0/7,1	M9 M12	M12		ESX20GB-9x7/7,1 6947338	DS/ER20-9 6947339	SCK110C-9x7 5012796			
SPE10x8C-ESX20 5012483		10,0 x 8,0	M10	M10	41	ESX20GB-10x8 6949111	DS/ER20-10 6931347	SCK110C-10x8 5012809			
SPE11x9C-ESX20 5013775		11,0 x 9,0	M14		42	ESX20GB-11x9 6949177	DS/ER20-11 6944294	SCK110C-11x9 5013782			
SPE11,2x9C-ESX20 5035343	11,2 x 9,0				ESX20GB-11,2x9 6949353	DS/ER20-11,5 6953239	SCK110C-11x9 5013782				
SPE6x4,9C-ESX32 5013821	SCK2/ ESX32	6,0 x 4,9	M5, M6, M8		31	ESX32GB-6x4,9 6949997	DS/ER32-6 6948674	SCK210C-6x4,9 5013824	3		
SPE6,3x5C-ESX32 5073204		6,3 x 5,0				ESX32GB-6,3x5 6946964	DS/ER32-6,5 6954198	SCK210C-6x4,9 5013824			
SPE7x5,5C-ESX32 5013822		7,0 x 5,5	M7, M9, M10		36	ESX32GB-7x5,5 6950029	DS/ER32-7 6953637	SCK210C-7x5,5 5013825			
SPE7,1x5,6C-ESX32 5073205		7,1 x 5,6				ESX32GB-7,1x5,6 6951552	DS/ER32-7,5 6954199	SCK210C-7x5,5 5013825			
SPE8x6,2/6,3C-ESX32 5013823		8,0 x 6,2/6,3	M8 M11	M8 M10		ESX32GB-8x6,2/6,3 6949769	DS/ER32-8 6949999	SCK210C-8x6,2 5013826			
SPE9x7/7,1C-ESX32 5012485		9,0 x 7,0/7,1	M9 M12	M12	37	ESX32GB-9x7/7,1 6946965	DS/ER32-9 6949298	SCK210C-9x7 5012864			
SPE10x8C-ESX32 5012486		10,0 x 8,0	M10	M10	41	ESX32GB-10x8 6949998	DS/ER32-10 6948675	SCK210C-10x8 5012868			
SPE11x9C-ESX32 5012487		11,0 x 9,0	M14		42	ESX32GB-11x9 6946104	DS/ER32-11 6948387	SCK210C-11x9 5012869			
SPE11,2x9C-ESX32 5073206		11,2 x 9,0				ESX32GB-11,2x9 6951219	DS/ER32-11,5 6951274	SCK210C-11x9 5012869			



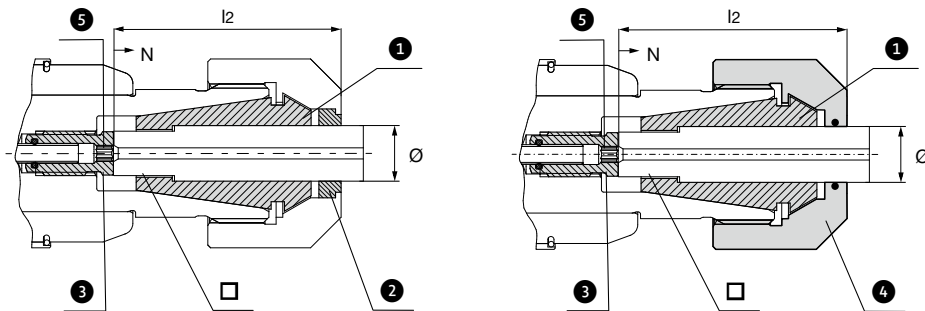

N = Nachstellung
Adjustment
l2 = Einstecktiefe
Insert depth
Ø = Schaftdurchmesser
Shank diameter
□ = Schaftvierkant
Drive square



ESX DIN/ISO														
Spanneinheit – ESX Ausführung C Clamping unit ESX Version C							bestehend aus: consisting of:							
Bezeichnung/Id. Nr. Designation/Id. No.	SCK.../ ESX...	Ø x □	DIN	ISO	l2	N	1	2	3	5				
SPE12x9C-ESX32 5012488	SCK2/ ESX32	12,0 x 9,0	M12 M16		42	3	ESX32GB-12x9 6946106	DS/ER32-12 6946689	SCK210C-11x9 5012869	3				
SPE14x11/11,2C-ESX32 5012489		14,0 x 11,0/11,2	M18	M18	44		ESX32GB-14x11/11,2 6947337	DS/ER32-14 6946613	SCK210C-14x11 5012870					
SPE16x12/12,5C-ESX32 5012490		16,0 x 12,0/12,5	M20	M22	45		ESX32GB-16x12/12,5 6948391	DS/ER32-16 6946822	SCK210C-16x12 5012871					
SPE18x14,5C-ESX32 5013787		18,0 x 14,5	M22		47		ESX32GB-18x14,5 6950206	DS/ER32-18 6946002	SCK210C-18x14,5 5013789					
SPE10x8C-ESX40 5016652	SCK3/ ESX40	10,0 x 8,0	M10	M10	41	3	ESX40GB-10x8 9080012	DS/ER40-10 6952199	SCK310C-10x8 5016661	4				
SPE11x9C-ESX40 5016653		11,0 x 9,0	M14		42		ESX40GB-11x9 6955398	DS/ER40-11 6954278	SCK310C-11x9 5016662					
SPE11,2x9C-ESX40 5073207		11,2 x 9		M14			ESX40GB-11,2x9 5069535	DS/ER40-11,5 6954279	SCK310C-11x9 5016662					
SPE12x9C-ESX40 5016654		12,0 x 9,0	M12 M16		44		ESX40GB-12x9 9074741	DS/ER40-12 6954280	SCK310C-11x9 5016662					
SPE14x11/11,2C-ESX40 5016655		14,0 x 11,0/11,2	M18	M18			ESX40GB-14x11/11,2 9074742	DS/ER40-14 6954284	SCK310C-14x11 5016663					
SPE16x12/12,5C-ESX40 5016656		16,0 x 12,0/12,5	M20	M22			45	ESX40GB-16x12/12,5 9080073	DS/ER40-16 6946054		SCK310C-16x12 5016664			
SPE18x14,5C-ESX40 5016657		18,0 x 14,5	M22				47	ESX40GB-18x14,5 6952207	DS/ER40-18 6946120		SCK310C-18x14,5 5016665			
SPE20x16C-ESX40 5016658		20,0 x 16,0	M27	M27 M30			52	ESX40GB-20x16 6948903	DS/ER40-20 6952971		SCK310C-20x16 5016666			
SPE22x18C-ESX40 5016659		22,0 x 18,0	M30				54	ESX40GB-22x18 6949124	DS/ER40-22 6949887		SCK310C-22x18 5016667			
SPE22x18C-ESX50 5085426		SCK4/ ESX50	22 x 18	M30				69	4		ESX50GB-22x18 5065799	DS/ER50-22 5085415	SCK410-1-BZ53/3 5088463	6
SPE25x20C-ESX50 5085427			25 x 20	M33				71			ESX50GB-25x20 5065800	DS/ER50-25 5085420		
SPE28x22C-ESX50 5085428			28 x 22	M36				73			ESX50GB-28x22 5065801	DS/ER50-28 5085421		
SPE32x24C-ESX50 5085429	32 x 24		M39 M42			75	ESX50GB-32x24 5065802	DS/ER50-32 5085422						

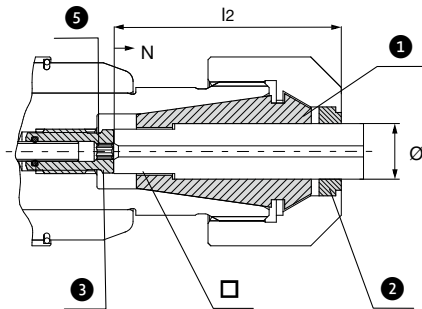

N = Nachstellung
Adjustment
l2 = Einstecktiefe
Insert depth
Ø = Schaftdurchmesser
Shank diameter
□ = Schaftvierkant
Drive square



ESX JIS												
Spanneinheit – ESX Ausführung C					Clamping unit ESX Version C					bestehend aus: consisting of:		
Bezeichnung/Id. Nr. Designation/Id. No.	SCK.../ ESX...	Ø x □	JIS	l2	N	1	2	3	5			
SPE5,0x4,0C-ESX20 5013774	SCK1/ ESX20	5,0 x 4,0	M4, M4,5	30	3	ESX20GB-5x4 6949763	DS/ER20-5 6949763	SCK110C-5x4 5013781	2,5			
SPE5,5x4,5C-ESX20 5068609		5,5 x 4,5	M5			ESX20GB-5,5x4,5 6949765	DS/ER20-5,5 6952104	SCK110C-5x4 5013781				
SPE6,0x4,5C-ESX20 5068620		6,0 x 4,5	M6	31		ESX20GB-6x4,5 6949766	DS/ER20-6 6943901	SCK110C-5x4 5013781				
SPE6,2x5,0C-ESX20 5068623		6,2 x 5,0	M7, M8			ESX20GB-6,2x5,0 5049187	DS/ER20-6,5 6953031	SCK110C-6x4,9 5012783				
SPE7,0x5,5C-ESX20 5012480		7,5 x 5,5	M9, M10			ESX20GB-7x5,5 6949767	DS/ER20-7 6950178	SCK110C-7x5,5 5012792				
SPE8,5x6,5C-ESX20 5035341		8,5 x 6,5	M12	36		ESX20GB-8,5x6,5 6949768	DS/ER20-8,5 6953238	SCK110C-8x6,2 5012793				
SPE10,5x8,0C-ESX20 5035342		10,5 x 8,0	M14	41		ESX20GB-10,5x8 6953229	DS/ER20-10,5 6952196	SCK110C-11x8 5012809				
SPE6,2x5,0C-ESX32 5068629		SCK2/ ESX32	6,2 x 5,0	M7, M8		31	3	ESX32GB-6,2x5 5069533		DS/ER32-6,5 6954198	SCK210C-6x4,9 5013824	3
SPE7,0x5,5C-ESX32 5013822			7,5 x 5,5	M9, M10				ESX32GB-7x5,5 6950029		DS/ER32-7 6953637	SCK210C-7x5,5 5013825	
SPE8,5x6,5C-ESX32 5068632			8,5 x 6,5	M12		41		ESX32GB-8,5x6,5 6953221		DS/ER32-8,5 6954200	SCK210C-8x6,2 5013826	
SPE10,5x8,0C-ESX32 5068635	10,5 x 8,0		M14	ESX32GB-10,5x8 6952835	DS/ER32-10,5 6952918			SCK210C-10x8 5012868				
SPE12,5x10,0C-ESX32 5035344	12,5 x 10,0		M16	ESX32GB-12,5x10 6951553	DS/ER32-12,5 6951275			SCK210C-11x9 5012869				
SPE13,0x10,0C-ESX32* 5068628	13,0 x 10,0		M17	42	2	ESX32-13* 6921677		DS/ER32-13 6952973	SCK210C-11x9 5012869			
SPE14,0x11,0/11,2C-ESX32 5012489	14,0 x 11,0/11,2		M18	44	3	ESX32GB-14x11/11,2 6947337		DS/ER32-14 6946613	SCK210C-14x11 5012870			
SPE15,0x12,0C-ESX32 5035345	15,0 x 12,0		M20	45	2	ESX32GB-15x12 6953222		DS/ER32-15 6954204	SCK210C-16x12 5012871			
SPE17,0x13,0C-ESX32 5068637	17,0 x 13,0		M22	45	3	ESX32GB-17x13 5066606		DS/ER32-17 6954207	SCK210C-16x12 5012871			
SPE12,5x10,0C-ESX40 5068639	SCK3/ ESX40		12,5 x 10,0	M16	42	3		ESX40GB-12,5x10 6951493	DS/ER40-12,5 6954281	SCK310C-11x9 5016662	4	
SPE13,0x10,0C-ESX40* 5068640		13,0 x 10,0	M17	ESX40-13* 6921694			DS/ER40-13 6954284	SCK310C-11x9 5016662				
SPE14,0x11,0C-ESX40 5016655		14,0 x 11,0	M18	44	ESX40GB-14x11,2 9074742		DS/ER40-14 6954114	SCK310C-14x11 5016663				
SPE15,0x12,0C-ESX40 5068641		15,0 x 12,0	M20	44	ESX40GB-15x12 5066068		DS/ER40-15 6954288	SCK310C-16x12 5016664				
SPE17,0x13,0C-ESX40 5068646		17,0 x 13,0	M22	45	ESX40GB-17x13 5066609		DS/ER40-17 6954115	SCK310C-16x12 5016664				
SPE20,0x15,0C-ESX40* 5068648		20,0 x 15,0	M27	52	ESX40-20* 6921701		DS/ER40-20 6952971	SCK310C-20x16 5016666				
SPE21,0x17,0C-ESX40* 5068649		21,0 x 17,0	M28	52	ESX40-21* 6921702		DS/ER40-21 9071745	SCK310C-20x16 5016666				
SPE23,0x17,0C-ESX40* 5068650		23,0 x 17,0	M30	54	ESX40-23* 6921704		DS/ER40-23 9071747	SCK310C-20x16 5016666				

* Für diese JIS-Gewindebohrer gibt es keine ESX...GB Spannzangen. Dort können normale ESX Spannzangen benutzt werden.
* These ESX...GB style collets for JIS taps are not available. Here you can use normal ER/ESX collets.

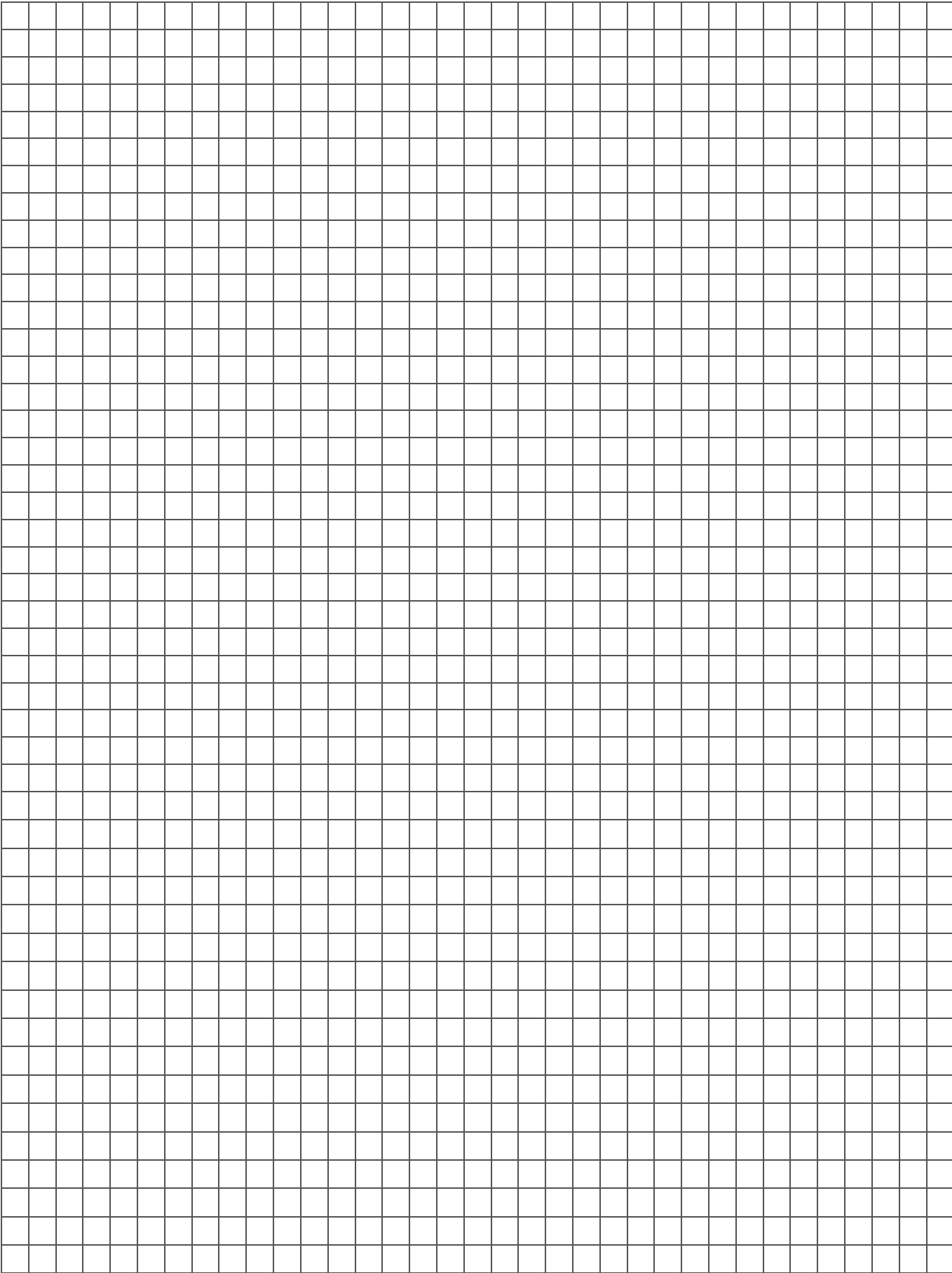

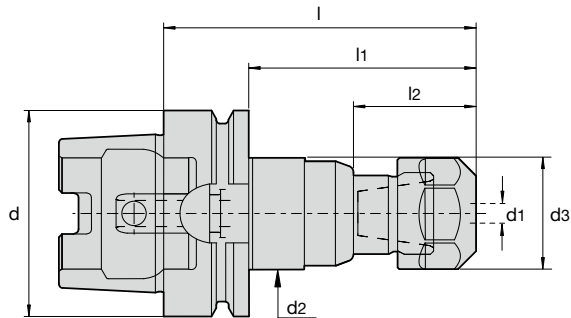

DIN
69893A



MQL
10 bar



SCK/HSK-A – ESX -1-Kanal MMS 1 channel MQL												
Bezeichnung/Id. Nr. Designation/Id. No.												
			d	d1	d2	d3	l	l1	l2			
SCK1-95,5/HSK-A63-ESX20-GN 5010561	+/-0,15		63	M4 – M12 4,5 – 11,2	34	34	95,5	69,5	37,5	Spanneinheiten und Ersatzteile siehe Seite 15, 26 – 29 Clamping units and components see page 15, 26 – 29	DIN 894-30	EX20-IC
SCK1-160/HSK-A63-ESX20-GN 5024594	+/-0,15		63	M4 – M12 4,5 – 11,2	34	34	160	134	37,5		DIN 894-30	EX20-IC
SCK1-102/HSK-A100-ESX20-GN 5012121	+/-0,15		100	M4 – M12 4,5 – 11,2	34	34	102	73	37,5		DIN 894-30	EX20-IC
SCK2-109/HSK-A63-ESX32-GN 5011986	+/-0,15		63	M8 – M20 6 – 18	50	50	109	83	43,5		E 32	EX32-IC
SCK2-160/HSK-A63-ESX32-GN 5024254	+/-0,15		63	M8 – M20 6 – 18	50	50	160	83	43,5		6921609	6933897
SCK2-115,5/HSK-A100-ESX32-GN 5012066	+/-0,15		100	M8 – M20 6 – 18	50	50	115,5	86,5	43,5		E 32	EX32-IC
SCK3-146,5/HSK-A63-ESX40-GN 5024613	+/-0,8		63	M14 – M30 11 – 22	63	58,5	146,5	120,5	50,3		6921610	6948425
SCK3-138/HSK-A100-ESX40-GN 5024615	+/-0,8		100	M14 – M30 11 – 22	63	58,5	138	109	50,3		E 40	EX40-IC
											6921610	6948425

SCK/HSK-A – ESX -2-Kanal MMS 2 channel MQL												
Bezeichnung/Id. Nr. Designation/Id. No.												
			d	d1	d2	d3	l	l1	l2			
SCK1-B-95,5/HSK-A63-ESX20-GN 5011971	+/-0,15		63	M4 – M12 4,5 – 11,2	34	34	95,5	69,5	37,5	Spanneinheiten und Ersatzteile siehe Seite 15, 26 – 29 Clamping units and components see page 15, 26 – 29	DIN 894-30	EX20-IC
SCK1-B-160/HSK-A63-ESX20-GN 5024976	+/-0,15		63	M4 – M12 4,5 – 11,2	34	34	160	134	37,5		DIN 894-30	EX20-IC
SCK1-B-102/HSK-A100-ESX20-GN 5012122	+/-0,15		100	M4 – M12 4,5 – 11,2	34	34	102	73	37,5		DIN 894-30	EX20-IC
SCK2-B-109/HSK-A63-ESX32-GN 5011987	+/-0,15		63	M8 – M20 6 – 18	50	50	109	83	43,5		E 32	EX32-IC
SCK2-B-160/HSK-A63-ESX32-GN 5024978	+/-0,15		63	M8 – M20 6 – 18	50	50	160	83	43,5		6921609	6933897
SCK2-B-115,5/HSK-A100-ESX32-GN 5012067	+/-0,15		100	M8 – M20 6 – 18	50	50	115,5	86,5	43,5		E 32	EX32-IC
SCK3-B-146,5/HSK-A63-ESX40-GN 5052547	+/-0,8		63	M14 – M30 11 – 22	63	58,5	146,5	120,5	50,3		6921610	6948425
SCK3-B-138/HSK-A100-ESX40-GN 5016680	+/-0,8		100	M14 – M30 11 – 22	63	58,5	138	109	50,3		E 40	EX40-IC
											6921610	6948425

Spanneinheit (Seite 15) und Spanschlüssel (Seite 26 – 29) sind nicht im Lieferumfang enthalten.

Clamping unit (page 15) and wrench (page 26 – 29) not included.

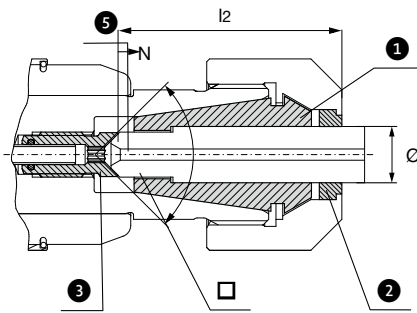

N = Nachstellung
Adjustment
l2 = Einstecktiefe
Insert depth
Ø = Schaftdurchmesser
Shank diameter
□ = Schaftvierkant
Drive square

ESX												
Spanneinheit – ESX Ausführung B Clamping unit ESX Version B						bestehend aus: consisting of:						
Bezeichnung/Id. Nr Designation/Id. No	SCK.../ ESX...	Ø x □	DIN	ISO	l2	N	1	2	3	5		
SPE4,5x3,4B-ESX20 5047586	SCK1/ ESX20	4,5 x 3,4	M4, M6,		29	2	ESX20GB-4,5x3,4 6948389	DS/ER20-4,5 6948386	SCK110B-4,5x3,4 5047555	2,5		
SPE5x4B-ESX20 5047587		5,0 x 4,0		M5	30		ESX20GB-5x4 6949763	DS/ER20-5 6953236	SCK110B-5x4 5010618			
SPE6x4,9B-ESX20 5011485		6,0 x 4,9	M5, M6, M8		31	3	ESX20GB-6x4,9 6948390	DS/ER20-6 6943901	SCK110B-6x4,9 5010622			
SPE7x5,5B-ESX20 5011486		7,0 x 5,5	M7, M8, M10		31		ESX20GB-7x5,5 6949767	DS/ER20-7 6950178	SCK110B-7x5,5 5010623			
SPE8x6,2/6,3B-ESX20 5011487		8,0 x 6,2/6,3	M8, M11	M8, M10	36	3	ESX20GB-8x6,2/6,3 6949202	DS/ER20-8 6946991	SCK110B-8x6,2 5010626			
SPE9x7/7,1B-ESX20 5011488		9,0 x 7,0/7,1	M9, M12	M12	37		ESX20GB-9x7/7,1 6947338	DS/ER20-9 6947339	SCK110B-9x7 5010628			
SPE10x8B-ESX20 5011489		10,0 x 8,0	M10	M10	41		ESX20GB-10x8 6949111	DS/ER20-10 6931347	SCK110B-10x8 5010646			
SPE11x9B-ESX20 5045461		11,0 x 9,0	M14		42		ESX20GB-11x9 6949177	DS/ER20-11 6944294	SCK110B-11x9 5010649			
SPE9x7/7,1B-ESX32 5012108		SCK2/ ESX32	9,0 x 7,0/7,1	M9, M12	M12	37	3	ESX32GB-9x7/7,1 6946965	DS/ER32-9 6949298		SCK210B-9x7 5010674	3
SPE10x8B-ESX32 5012109			10,0 x 8,0	M10	M10	41		ESX32GB-10x8 6949998	DS/ER32-10 6948675		SCK210B-10x8 5010679	
SPE11x9B-ESX32 5012110	11,0 x 9,0		M14		42	ESX32GB-11x9 6946104		DS/ER32-11 6948387	SCK210B-11x9 5010680			
SPE12x9B-ESX32 5012111	12,0 x 9,0		M12, M16			ESX32GB-12x9 6946106		DS/ER32-12 6946689	SCK210B-11x9 5010680			
SPE14x11B-ESX32 5012112	14,0 x 11,0		M18	M18	44	ESX32GB-14x11 6947337		DS/ER32-14 6946613	SCK210B-14x11 5010682			
SPE16x12,5B-ESX32 5012113	16,0 x 12,0/12,5		M20	M20	45	ESX32GB-16x12,5 6948391		DS/ER32-16 6946822	SCK210B-16x12 5010683			
SPE10x8B-ESX40 5016689	SCK3/ ESX40		10,0 x 8,0	M10	M10	41		3	ESX40GB-10x8 9080012	DS/ER40-10 6952199	SCK310B-10x8 5016699	
SPE11x9B-ESX40 5016690		11,0 x 9,0	M14		42	ESX40GB-11x9 6955398	DS/ER40-11 6954278		SCK310B-11x9 5016701			
SPE12x9B-ESX40 5016691		12,0 x 9,0	M12, M16			ESX40GB-12x9 9074741	DS/ER40-12 6954280		SCK310B-11x9 5016701			
SPE14x11/11,2B-ESX40 5016694		14,0 x 11,0/11,2	M18	M18	44	ESX40GB-14x11/11,2 9074742	DS/ER40-14 6954284		SCK310B-14x11 5016702			
SPE16x12/12,5B-ESX40 5016695		16,0 x 12,0/12,5	M20	M20	45	ESX40GB-16x12/12,5 9080073	DS/ER40-16 6946054		SCK310B-16x12 5016703			
SPE18x14,5B-ESX40 5016696		18,0 x 14,5	M22		47	ESX40GB-18x14,5 6952207	DS/ER40-18 6946120		SCK310B-18x14,5 5016704			
SPE20x16B-ESX40 5016697		20,0 x 16,0	M27	M27, M30	52	ESX40GB-20x16 6948903	DS/ER40-20 6952971		SCK310B-20x16 5016705			
SPE22x18B-ESX40 5016698		22,0 x 18,0	M30		54	ESX40GB-22x18 6949124	DS/ER40-22 6949887		SCK310B-22x18 5016706			



SCK – Synchrofutter für BZK-Spannzangen
SCK – Synchro chucks for BZK collets

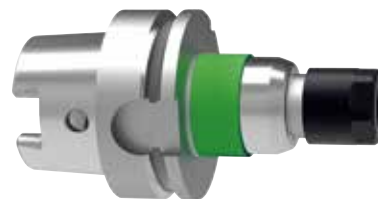
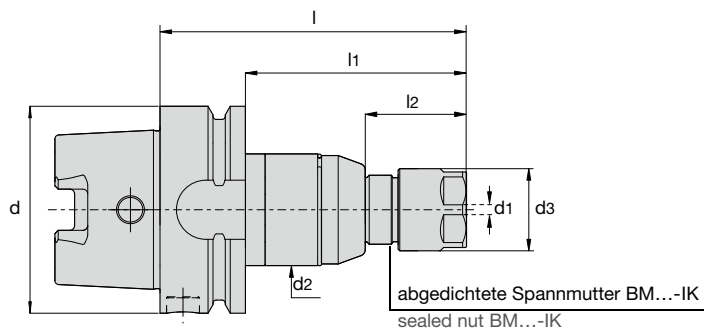

DIN
69893A



MQL
10 bar



SCK/HSK-A – BZ -1-Kanal MMS 1 channel MQL												
Bezeichnung/Id. Nr. Designation/Id. No.			d	d1	d2	d3	l	l1	l2			
SCK1-86/HSK-A63-BZ18-GN 5013556	+/-0,15		63	M3,5-M14 4,0 – 10,0	34	25	86	60	28	Spanneinheiten und Ersatzteile siehe Seite 17, 26 – 29 Clamping units and components see page 17, 26 – 29		DIN3110-21x23 6952334
SCK1-92,5/HSK-A100-BZ18-GN 5024602	+/-0,15		100	M3,5-M14 4,0 – 10,0	34	25	92,5	63,5	28		DIN3110-21x23 6952334	
SCK2-104/HSK-A63-BZ25-GN 5024596	+/-0,15		63	M10-M20 10,0 – 18,0	50	34	104	78	38,5		DIN894-30 6934034	
SCK2-110,5/HSK-A100-BZ25-GN 5024604	+/-0,15		100	M10-M20 10,0 – 18,0	50	34	110,5	81,5	38,5		DIN894-30 6934034	

SCK/HSK-A – BZ -2-Kanal MMS 2 channel MQL												
Bezeichnung/Id. Nr. Designation/Id. No.			d	d1	d2	d3	l	l1	l2			
SCK1-B-86/HSK-A63-BZ18-GN 5022432	+/-0,15		63	M3,5-M14 4,0 – 10,0	34	25	86	60	28	Spanneinheiten und Ersatzteile siehe Seite 17, 26 – 29 Clamping units and components see page 17, 26 – 29		DIN3110-21x23 6952334
SCK1-B-92,5/HSK-A100-BZ18-GN 5024981	+/-0,15		100	M3,5-M14 4,0 – 10,0	34	25	92,5	63,5	28		DIN3110-21x23 6952334	
SCK2-B-104/HSK-A63-BZ25-GN 5024983	+/-0,15		63	M10-M20 10,0 – 18,0	50	34	104	78	38,5		DIN894-30 6934034	
SCK2-B-110,5/HSK-A100-BZ25-GN 5024984	+/-0,15		100	M10-M20 10,0 – 18,0	50	34	110,5	81,5	38,5		DIN894-30 6934034	

Spanneinheit (Seite 17) und Spannschlüssel (Seite 28+29) sind nicht im Lieferumfang enthalten.
 Clamping unit (page 17) and wrench (page 28+29) not included.

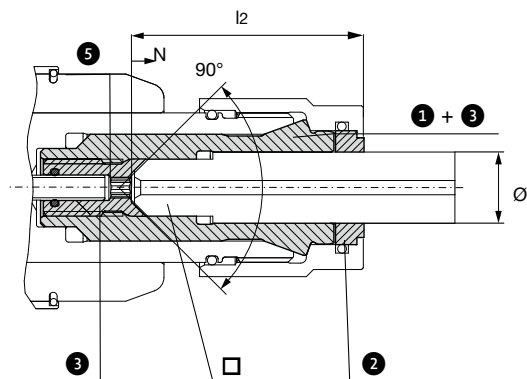

N = Nachstellung
Adjustment
l2 = Einstecktiefe
Insert depth
Ø = Schaftdurchmesser
Shank diameter
□ = Schaftvierkant
Drive square

BZK										
Spanneinheit – BZ Ausführung B Clamping unit BZ Version B						bestehend aus: consisting of:				
Bezeichnung/Id. Nr Designation/Id. No	SCK.../ BZ...	Ø x □	DIN	ISO	l2	N	1 + 3	2	3	5
SPE6x4,9B-BZ18 5011572	SCK1/ BZ18	6 x 4,9	M5, M6, M8		29	2	BZK18B-6x4,9 5011035	DS/ER20-6 6943901	SCK110B-BZ18-6x4,9 5010725	2,5
SPE7x5,5B-BZ18 5012025		7 x 5,5	M7, M8, M10				BZK18B-7x5,5 5012002	DS/ER20-7 6950178	SCK110B-BZ18-7x5,5 5012023	
SPE8x6,2B-BZ18 5011571		8 x 6,2	M8, M11	M8 M10	30	3	BZK18B-8x6,2 5011036	DS/ER20-8 6946991	SCK110B-BZ18-8x6,2 5010726	
SPE9x7B-BZ18 5012031		9x 7,0	M9, M12	M12			BZK18B-9x7 5012003	DS/ER20-9 6947339	SCK110B-BZ18-9x7 5010727	
SPE10x8B-BZ18 5012039		10 x 8,0	M10	M10			BZK18B-10x8 5012041	DS/ER20-10 6931347	SCK110B-BZ18-10x8 5012042	
SPE11x9B-BZ18 5071686		11 x 9,0	M14		33		BZK18B-11x9 -	DS/ER20-11 6944294	SCK110B-BZ18-11x9 -	
SPE9x7B-BZ25 5013677		SCK2/ BZ25	9 x 7,0	M9, M12	M12	40	3	BZK25B-9x7 5013672	DS/ER25-9 6941679	
SPE10x8B-BZ25 5013679	10 x 8,0		M10	M10	41	BZK25B-10x8 5012005		DS/ER25-10 6943423	SCK210B-BZ25-10x8 5013646	
SPE11x9B-BZ25 5013680	11 x 9,0		M14		42	BZK25B-11x9 5012006		DS/ER25-11 6943534	SCK210B-BZ25-11x9 5013648	
SPE12x9B-BZ25 5013681	12 x 9,0		M12, M16			BZK25B-12x9 5013664		DS/ER25-12 6943424	SCK210B-BZ25-11x9 5013648	
SPE14x11B-BZ25 5013683	14 x 11,0		M18	M18	44	BZK25B-14x11 5013666		DS/ER25-14 6943342	SCK210B-BZ25-14x11 5013650	
SPE16x12B-BZ25 5013684	16 x 12,0		M20	M22	45	BZK25B-16x12 5013670		DS/ER25-16 6943422	SCK210B-BZ25-16x12 5013652	
SPE18x14,5B-BZ25* 5013725	18 x 14,5		M22			BZK25B-18x14,5 5013724		DS/ER25-18 9088550	SCK210B-BZ25-18x14,5 5013654	

* nur für leichte Bearbeitung; max 90 Nm
* for light machining only; max 90 Nm



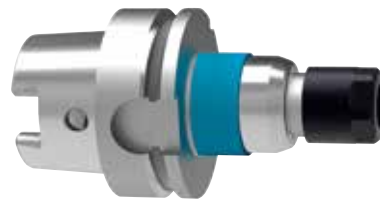
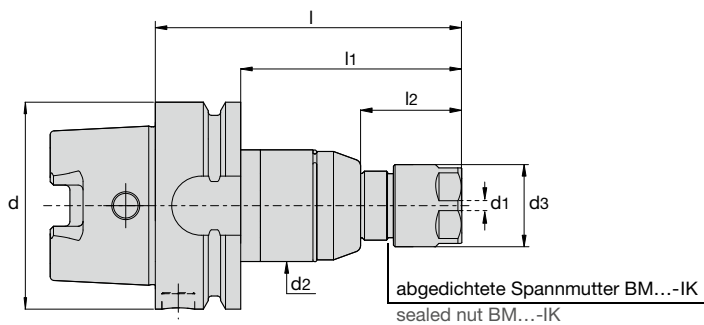

DIN
69893A



SCK/HSK-A – BZ

Bezeichnung/Id. Nr. Designation/Id. No.												
			d1	d2	d3	l	l1	l2				
SCK1-86/HSK-A63-BZ18-BL 5014929	+/-0,15	63	M3,5-M14 4,0 – 10,0	34	25	86	60	28	Spanneinheiten und Ersatzteile siehe Seite 19, 26 – 29 Clamping units and components see page 19, 26 – 29	DIN3110-21x23 6952334		
SCK1-92,5/HSK-A100-BZ18-BL 5017529	+/-0,15	100	M3,5-M14 4,0 – 10,0	34	25	92,5	63,5	28		DIN3110-21x23 6952334		
SCK2-104/HSK-A63-BZ25-BL 5017530	+/-0,15	63	M10-M20 10,0 – 18,0	50	34	104	78	38,5		DIN894-30 6934034		
SCK2-110,5/HSK-A100-BZ25-BL 5017531	+/-0,15	100	M10-M20 10,0 – 18,0	50	34	110,5	81,5	38,5		DIN894-30 6934034		

Kühlmittelrohr ist im Lieferumfang enthalten. Spanneinheit (Seite 19) und Spannschlüssel (Seite 28+29) sind nicht im Lieferumfang enthalten.
Coolant tube included. Clamping unit (page 19) and wrench (page 28+29) not included.

Mit den BILZ BZK-Spannzangen lassen sich schlankere Ausführungen (Störkonturen) realisieren als mit den ER/ESX-Spannzangen.

Die formschlüssige Mitnahme der BZK-Spannzange im Gehäuse verhindert ein unkontrolliertes Verdrehen im Futter.

Weitere Vorteile sind:

- einfache Längeneinstellung des Werkzeuges
- vom Spannweg der Spannzange unabhängige, gleichbleibende Anlagekraft der Einstellschraube am Gewindebohrer

The BILZ, BZK-collet tap clamping system allows slim build combinations when compared to conventional ER collet chucks they therefore avoid or overcome problematic and difficult access applications. In addition, the direct drive mechanism of the collet to the tap allows twist free applications or eliminates tap spinning.

Further benefits are:

- Easy length setting of the tap.
- Irrespective of the clamping stroke of the collet during the tightening process the backstop screw pressure remains constant in relation to the tap.

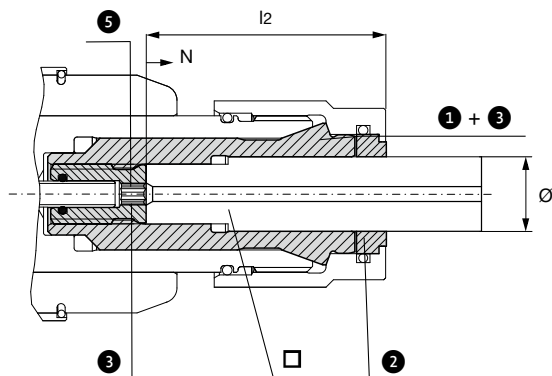

N = Nachstellung
Adjustment
l2 = Einstecktiefe
Insert depth
Ø = Schaftdurchmesser
Shank diameter
□ = Schaftvierkant
Drive square

BZK												
Spanneinheit – BZ Ausführung C Clamping unit BZ Version C							bestehend aus: consisting of:					
Bezeichnung/Id. Nr Designation/Id. No	SCK.../ BZ...	Ø x □	DIN	ISO	L2	N	1 + 3	2	3	5		
SPE4,5x3,4C-BZ18 5025987	SCK1/ BZ18	4,5 x 3,4	M4, M6		27	2	BZK18C-4,5x3,4 5025978	DS/ER20-4,5 6948386	SCK110C-BZ18-4,5x3,4 5025981	2,5		
SPE5x4C-BZ18 5025986		5 x 4,0		M5	28		BZK18C-5x4 5025977	DS/ER20-5 6953236	SCK110C-BZ18-5x4 5025980			
SPE6x4,9C-BZ18 5012926		6 x 4,9	M5, M6, M8		29		BZK18C-6x4,9 5012934	DS/ER20-6 6943901	SCK110C-BZ18-6x4,9 5012939			
SPE7x5,5C- BZ18 5012927		7 x 5,5	M7, M8, M10		29		BZK18C-7x5,5 5012935	DS/ER20-7 6950178	SCK110C-BZ18-7x5,5 5012940			
SPE8x6,2C-BZ18 5012928		8 x 6,2	M8, M11	M8 M10	30	3	BZK18C-8x6,2 5012936	DS/ER20-8 6946991	SCK110C-BZ18-8x6,2 5012941			
SPE9x7C-BZ18 5012929		9 x 7,0	M9, M12	M12	31		BZK18C-9x7 5012937	DS/ER20-9 6947339	SCK110C-BZ18-9x7 5012942			
SPE10x8C-BZ18 5012930		10 x 8,0	M10	M10	32		BZK18C-10x8 5012938	DS/ER20-10 6931347	SCK110C-BZ18-10x8 5012943			
SPE11x9C-BZ18 5026031		11 x 9,0	M14		33		BZK18C-11x9 5026027	DS/ER20-11 6944294	SCK110C-BZ18-11x9 5026028			
SPE9x7C-BZ25 5029319		SCK2/ BZ25	9 x 7,0	M9, M12	M12	40	3	BZK25C-9x7 5029318	DS/ER25-9 6941679		SCK210C-BZ25-9x7 5029317	3
SPE10x8C-BZ25 5029322			10 x 8,0	M10	M10	41		BZK25C-10x8 5029328	DS/ER25-10 6943423		SCK210C-BZ25-10x8 5029340	
SPE11x9C-BZ25 5029323			11 x 9,0	M14		42		BZK25C-11x9 5029329	DS/ER25-11 6943534		SCK210C-BZ25-11x9 5029341	
SPE12x9C-BZ25 5029324	12 x 9,0		M12, M16		42	BZK25C-12x9 5029330		DS/ER25-12 6943424	SCK210C-BZ25-11x9 5029341			
SPE14x11C-BZ25 5029325	14 x 11,0		M18	M18	44	BZK25C-14x11 5029331		DS/ER25-14 6943342	SCK210C-BZ25-14x11 5029343			
SPE16x12C-BZ25 5029326	16 x 12,0		M20	M22	45	BZK25C-16x12 5029332		DS/ER25-16 6943422	SCK210C-BZ25-16x12 5029344			
SPE18x14,5C-BZ25* 5029327	18 x 14,5		M22			BZK25C-18x14,5 5029333		DS/BZ25-18 9088550	SCK210C-BZ25-18x14,5 5029345			

* nur für leichte Bearbeitung; max 90 Nm

* for light machining only; max 90 Nm



UE-HSK Übersicht Übernahme-Einheiten SCK – IK

UE-HSK Overview Coolant Units SCK – IK

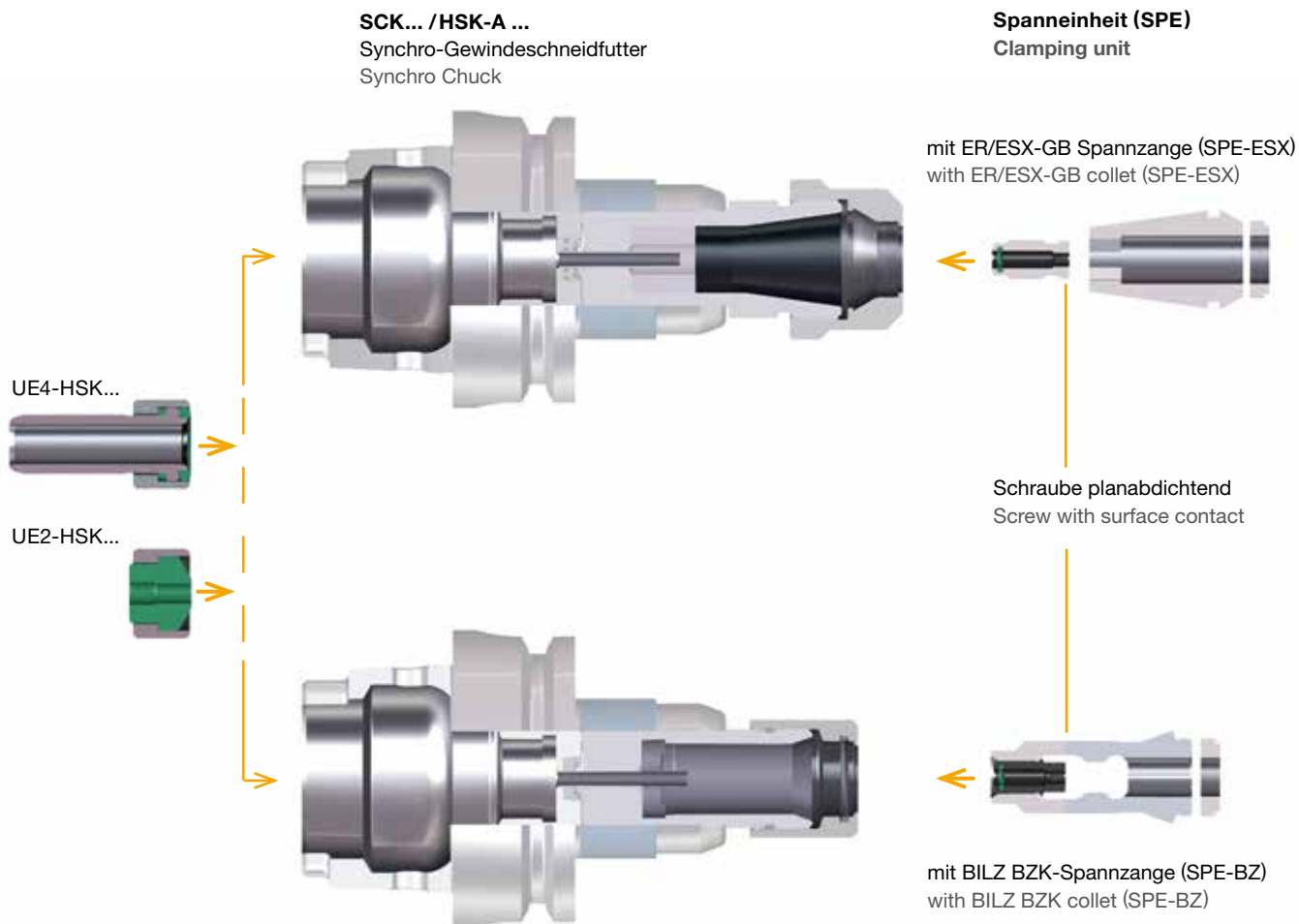

UE4 HSK Form A		UE2 HSK Form AC	
automatischer Werkzeugwechsel IK innere Kühlmitteldurchführung automatic tool change IK internal coolant		manueller Werkzeugwechsel IK innere Kühlmitteldurchführung manual tool change IK internal coolant	
Bezeichnung Designation	Ident No.	Bezeichnung Designation	Ident No.
UE4/HSK32	5064893	UE2/HSK32AC	5026724
UE4/HSK40	5028425	UE2/HSK40AC	5023961
UE4/HSK50	5028426	UE2/HSK50AC	5023060
UE4/HSK63	5025376	UE2/HSK63AC	5021993
UE4/HSK80	5028427	UE2/HSK80AC	5023939
UE4/HSK100	5028428	UE2/HSK100AC	5023940

Hinweis: UE – Übernahmeinheit im Lieferumfang des Futteres enthalten
Note: UE – Coolant unit supplied with the chuck

UE-HSK Übersicht Übernahme-Einheiten SCK – MMS

UE-HSK Overview Coolant Units SCK – MQL

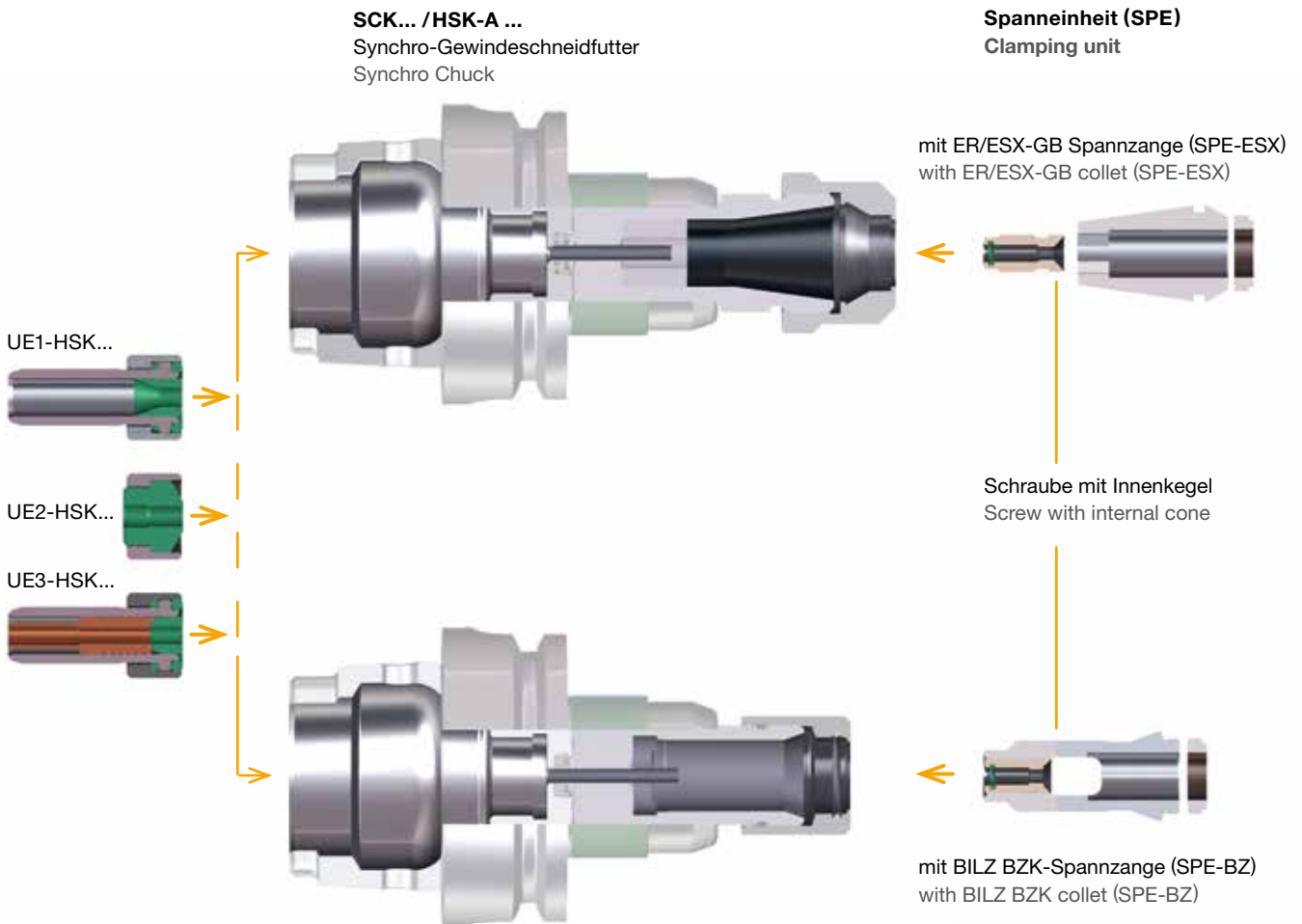

UE1 HSK Form A		UE2 HSK Form AC		UE3 HSK Form A	
automatischer Werkzeugwechsel MMS-1 Kanalsystem automatic tool change MQL 1 channel system		manueller Werkzeugwechsel MMS-1 und 2-Kanalsystem manual tool change MQL 1 and 2 channel system		automatischer Werkzeugwechsel MMS-2 Kanalsystem automatic tool change MQL 2 channel system	
Bezeichnung Designation	Ident No.	Bezeichnung Designation	Ident No.	Bezeichnung Designation	Ident No.
UE1/HSK32	5040137	UE2/HSK32AC	5026724		
UE1/HSK40	5023928	UE2/HSK40AC	5023061	UE3/HSK40	5023934
UE1/HSK50	5023933	UE2/HSK50AC	5023060	UE3/HSK50	5023935
UE1/HSK63	5004090	UE2/HSK63AC	5021993	UE3/HSK63	5004093
UE1/HSK80	5003462	UE2/HSK80AC	5023939	UE3/HSK80	5023937
UE1/HSK100	5012117	UE2/HSK100AC	5023940	UE3/HSK100	5012068

Hinweis: UE – Übernahmeinheit im Lieferumfang des Futter enthalten
Note: UE – Coolant unit supplied with the chuck

Betriebsanleitung SCK

1. Sicherheit

BILZ SCK Synchrofutter zeichnen sich neben ihren hervorragenden technischen Eigenschaften zusätzlich durch einfache Bedienbarkeit und Wartungsfreiheit aus.

Bitte beachten Sie für den bestimmungsgemäßen Gebrauch die folgenden Hinweise.

1.1 Symbolerklärung

Soweit dieses Symbol verwendet wird, kann die Missachtung unserer Angaben zu Gefahren für Personen und Sachen führen.

1.2 Bestimmungsgemäßer Gebrauch

BILZ SCK Synchrofutter eignen sich zum Spannen von Gewindebohrern und Formern.

Das Produkt darf ausschließlich im Rahmen seiner technischen Daten eingesetzt werden. Dazu gehört auch die Einhaltung der vom Hersteller vorgeschriebenen Inbetriebnahme, Betriebs-, Montage-, Wartungs- und Umgebungsbedingungen. Ein darüber hinausgehender Gebrauch gilt als nicht bestimmungsgemäß. Für Schäden aus solchem Gebrauch haftet der Hersteller nicht.

1.3 Sicherheitshinweise

1.3.1 Beim Gebrauch dürfen die Werte der technischen Daten nicht überschritten werden. (Siehe Tabelle)

Bezeichnung	Spannbereich		Anzugsmoment Mutter max.	Druck/Zug Ausgleich	Kühlmittel- druck max.	Leerlauf Drehzahl max.	Einstecktiefe
	Gewindegröße	Schaft					
SCK0.-ESX12	M2-M8	2,8-6,0mm	< Ø 3; 8Nm > Ø 3; 16Nm	± 0,15mm	50bar	15.000min-1	23,5-25,5mm
SCK1.-ESX20	M4-M12	4,5-11,2mm	< Ø 6,5; 32Nm > Ø 7; 35Nm	± 0,15mm	50bar	15.000min-1	29-42mm
SCK2.-ESX32	M8-M20	6,0-18,0mm	136Nm	± 0,15mm	50bar	15.000min-1	31-47mm
SCK3.-ESX40	M14-M30	11,0-22,0mm	176Nm	± 0,80mm	50bar	15.000min-1	41-54mm
SCK4.-ESX50	M30-M42	22,0-32,0mm	300Nm	± 2,0mm	50bar	15.000min-1	63-69mm

1.3.2 Beim Einsatz unter Rotation müssen Schutzabdeckungen gemäß EG-Maschinenrichtlinie 2006/42/EG vorgesehen werden.

1.3.3 Das Spannen von Werkzeugen und das Einbringen des Synchrofutters in eine Maschine nur von technisch geschultem Personal durchführen lassen. Dabei bitte die vollständige Bedienungsanleitung beachten.

Grundregeln:

- Tragen Sie beim Werkzeugwechsel Arbeitshandschuhe um Schnittverletzungen zu vermeiden.
- Halten Sie das Werkzeug beim Lösen der Werkzeugspannung gut fest, damit es nicht herunterfällt und dadurch das Werkzeug und das Werkstück beschädigt werden.
- Beachten Sie die max. Werkzeugabmessungen.
- Für jede Bearbeitung gibt es maximale Werte für Schnittgeschwindigkeit und Vorschub. Beachten Sie diese Schnittdaten.

2. Gewährleistung

Die Gewährleistung beträgt 12 Monate ab Lieferdatum Werk bei bestimmungsgemäßem Gebrauch und unter Beachtung der vorgeschriebenen Bedienungs- und Pflegevorschriften. (Siehe Seite 2, Punkt 6)

3. Inbetriebnahme

3.1 Futter mit einem Lappen reinigen, um das Konservierungsöl zu entfernen

Wichtig: Keine aggressiven Lösungsmittel verwenden. Keine fasernden Materialien, wie z.B. Putzwolle verwenden.

3.2 Die Aufnahme des Gewindeschneidwerkzeuges erfolgt über eine Spannzange Typ ER/ESX..GB. , DIN6499-B

3.3 Montage der Spannzangen und des Gewindebohrers

Um eine Verschmutzung der Spannzange zu vermeiden und wenn Sie mit Kühlmittel, bzw. MMS arbeiten müssen Sie zuerst die Dichtscheibe in die Spannmutter einsetzen.

4. Spannen / Entspannen

4.1. Das Werkzeug muss am Schaft gratfrei und schmutzfrei sein.

4.2. Montage Spannzangen:

Nut der Spannzange an der markierten Stelle in den Exzenterring der Spannmutter einhängen. Spannzange in entgegen gesetzte Richtung kippen, bis diese deutlich hörbar einrastet. Werkzeug einsetzen. Spannmutter mit der eingerasteten Spannzange auf das Gewinde des Halters schrauben. Wir empfehlen, die Spannmutter mit einem Drehmomentschlüssel anzuziehen und an der Schlüsselfläche gegenzuhalten. (Anzugsdrehmomente siehe Tabelle unter Punkt 1.3).

Eine falsche Handhabung beeinträchtigt den Rundlauf der Spannzange und kann die Spannmutter beschädigen. Nur Spannmuttern mit richtig eingesetzter Spannzange in den Spannzangenhalter einsetzen.

Betriebsanleitung SCK



4.3. Einbau Dichtscheibe:

Beim Einsetzen der Dichtscheibe in der Spannmutter muss die Beschriftung der Dichtscheibe von hinten her lesbar sein. Dichtscheibe in die Spannmutter einlegen und nach vorne drücken, bis eindeutiges "Klicken" zu hören ist. Jetzt ist die Dichtscheibe richtig in die Spannmutter eingesetzt. Die richtig montierte Dichtscheibe ist mit der Spannmutter bündig.

4.4 Ausbau Dichtscheibe:

Um die Dichtscheibe herauszunehmen, von der Außenseite auf die Dichtscheibe drücken, bis sie herauspringt.



Unbedingt Werkzeug von vorne einführen, sonst wird der O-Ring in der Dichtscheibe beschädigt. Beim Einführen vom Werkzeug darauf achten, dass die Dichtscheibe nicht zurück geschoben wird.



4.5 Das Werkzeug muss mindestens bis zur minimalen Einstecktiefe in das Futter eingeführt werden. (siehe Tabelle Seite 1)

4.6 Demontage Spannzangen:

Nach dem Abschrauben vom Halter auf die Frontseite der Spannzange drücken und gleichzeitig die Spannzange durch seitlichen Druck auf den hinteren Teil, gegenüber der Markierung, aus der Einrastung der Mutter heraus drücken.

5. Längennachstellung

5.1. Die Bedienung erfolgt durch die maschinenseitige Aufnahme oder durch die Spannzange mittels eines Innensechskantschlüssels.

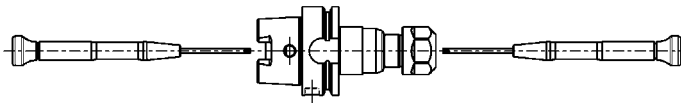

5.2. Das max. Betätigungsmoment für die Nachstellschraube darf 4Nm nicht überschreiten.

5.3. Es ist darauf zu achten, dass für Gewindebohrerschaft die passende Nachstellschraube verwendet wird. (s. Tabelle Punkt 5.3) Max. Längennachstellung 3mm.

Bezeichnung Synchrofutter	Nachstell- schraube IK	Gewindebohrer Ø x □													
		4,5x3,4	5x4	6x4,9	7x5,5	8x6,2	9x7	10x8	11x9	12x9	14x11	16x12	18x14,5	20x16	22x18
SCK1... ESX20	SCK110C-...	5013780	5013781	5012783	5012792	5012793	5012796	5012809	5013782						
SCK2... ESX32	SCK210C-...			5013824	5013825	5013826	5012864	5012868	5012869	5012869	5012870	5012871	5013789		
SCK3... ESX40	SCK310C-...							5016661	5016662	5016662	5016663	5016664	5016665	5016666	5016667

5.4. Die Nachstellschraube ist über ein Elastomer federnd gelagert. Somit wird beim Anziehen der Spannmutter verhindert, dass der Gewindebohrer oder die Nachstellschraube beschädigt werden.

5.5. SCK4-ESX50; SCK410G-M16x1, 5065065 eine Schraube für alle Gewindebohrerschaften 22-32 mm.



ACHTUNG!

Einsteilschraube muss 1 Umdrehung gelöst werden, nach Erreichung der max. Einschraubtiefe. (Gewährleistung der Abfederung)

Nur die mitgelieferten Steckschlüssel verwenden.

Die Nachstellschraube nicht bei gespanntem Werkzeug betätigen.

6. Wartung und Pflege

6.1. Regelmäßig mit einem Handlappen reinigen. Keine aggressiven Lösungsmittel und fasernde Materialien verwenden.

6.2. Vor dem Einlagern, alle Kühlmittelreste sowie Bearbeitungsrückstände entfernen und mit Korrosionsschutzmittel einsprühen.

Operating Instructions SCK

1. Safety

The BILZ SCK synchro chuck is not only characterised by its outstanding technical features, but also by its easy handling and maintenance free properties

Please note to the following points in order to ensure correct application.

1.1 Explanation of Symbols

If this symbol is used, disregard of our instructions can lead to danger to people and property.

1.2 Area of Application

BILZ SCK synchro chucks are suitable for tool clamping.

The product may only be used within the given technical limits. This includes the conditions set down by the manufacturer for installation, operation, assembly, maintenance and working environment. Usage above and beyond these conditions is considered as not correct for purpose. The manufacturer will not give any guarantee on such usage.

1.3 Safety Advice

1.3.1 The following technical limits must not be exceeded. (see table below)

Description	Clamping Tap Size	Range Shank	Nut Torque max.	Compensation Compression/Tension	Coolant Pressure max.	Idle Running Speed max.	Minimum Insert Depth
SCK0.-ESX12	M2-M8	2,8-6,0mm	< Ø 3; 8Nm > Ø 3; 16Nm	± 0,15mm	50bar	15.000min ⁻¹	23,5-25,5mm
SCK1.-ESX20	M4-M12	4,5-11,2mm	< Ø 6,5; 32Nm > Ø 7,0; 35Nm	± 0,15mm	50bar	15.000min ⁻¹	29-42mm
SCK2.-ESX32	M8-M20	6,0-18,0mm	136Nm	± 0,15mm	50bar	15.000min ⁻¹	31-47mm
SCK3.-ESX40	M14-M30	11,0-22,0mm	176Nm	± 0,80mm	50bar	15.000min ⁻¹	41-54mm
SCK4.-ESX50	M30-M42	22,0-32,0mm	300Nm	± 2,0mm	50bar	15.000min ⁻¹	63-69mm

1.3.2. For rotation applications, a protective cover according to EC Machinery Directive 2006/42/EG must be used.

1.3.3 Tool clamping and installation of the synchro chuck in a machine may only be carried out by technically trained staff who have familiarised themselves with the operating instructions.

Basic rules:

- Wear gloves when changing tools to avoid injury.
- When releasing the tool, hold it tightly to prevent it falling and damaging both the tool and workpiece.
- Do not exceed the max. tool dimensions.
- Maximum cutting speed and feed values exist for every application. Do not exceed these values.

2. Warranty:

The warranty period is 12 months from delivery date, if used correctly and in adherence to the operating and maintenance instructions (See Page 2, Point 6)

3. Installation

3.1 Clean chuck with a cloth in order to remove oil.

Important: Do not use aggressive solvents. Only use lint-free cloths.

3.2 The tapping tool is held by means of a collet type ER/ESX..GB. , DIN6499-B

3.3 Assembly of the collets and tap

To prevent soiling of the collet, and if you are using coolant or MQL, the sealing disc must first be fitted into the clamp nut.

4. Clamping / Releasing

4.1. The tool shank must be free of burrs and dirt.

4.2. Assembly of the collets:

Mount the collet groove on the marked position on the eccentric ring of the clamp nut. Tilt the collet in the opposite direction until this locks audibly. Insert the tool. Screw the clamp nut with the locked collet onto the thread of the holder. We recommend tightening the collet with a torque wrench and use the spanner flat to hold against this (tightening torques see table under Point 1.3).

Incorrect handling will affect the concentricity of the collet and can damage the clamping nut. Only clamping nuts with a correctly mounted collet should be inserted into the collet holder.

Operating Instructions SCK



4.3. Assembly of the sealing disc:

When inserting the sealing disc into the clamping nut, the marking on the sealing disc must be legible from behind. Insert the sealing disc into the collet and push it forward until it clicks. The correct assembled sealing disc is plane with the nut.

4.4 Removal of the sealing disc:

To remove the sealing disc, press on the disc from the outside until it jumps out.



It is essential to insert the tool from the front, otherwise the O-ring in the sealing ring will be damaged. When inserting the tool, make sure that the sealing disc is not pushed back.



4.5 The tool must be inserted into the chuck at least to the minimum insert depth (see table Page 1).

4.6 Removal of the collets:

After unscrewing the holder, press the front of the collet and at the same time press the collet out of the clamping nut by pressing the back part, opposite the marking.

5. Length Adjustment

5.1. The length adjustment is operated through the connection on the machine side, or through the collet by means of an Allen key.

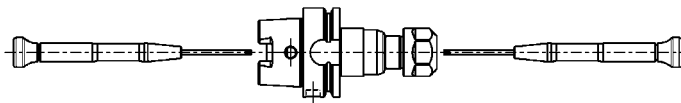

5.2. The max. torque on the adjustment screw must not exceed 4Nm.

5.3. Please ensure that the suitable adjusting screw for the tap shank is used (see table under Point 5.3)
Max. length adjustment 3mm.

Description Synchro Chuck	Adjusting Screw IC	Tap \varnothing x \square													
		4,5x3,4	5x4	6x4,9	7x5,5	8x6,2	9x7	10x8	11x9	12x9	14x11	16x12	18x14,5	20x16	22x18
SCK1.-ESX20	SCK110C-...	5013780	5013781	5012783	5012792	5012793	5012796	5012809	5013782						
SCK2.-ESX32	SCK210C-...			5013824	5013825	5013826	5012864	5012868	5012869	5012869	5012870	5012871	5013789		
SCK3.-ESX40	SCK310C-...							5016661	5016662	5016662	5016663	5016664	5016665	5016666	5016667

5.4. Behind the length adjustment screw there is elastomer for damping. So we prevent damage of the tap or length adjustment screw while tightening the clamping nut.

5.5. SCK4-ESX50; SCK410G-M16x1, 5065065, one screw for all tap shanks 22-32 mm



ATTENTION!

The setting screw must be released by one turn after reaching the max. screwing depth.

(to ensure the function of the spring system)

Only use the socket wrenches provided.

Do not move the adjusting screw when the tool is clamped.

6. Care and Maintenance

6.1. Clean regularly with a cloth. Do not use aggressive solvents and only use lint-free cloths.

6.2. Before storage ensure that all coolant and other residue is removed and the tools are sprayed with an anticorrosion agent.

Bezeichnung/Id. Nr. Designation/Id. No.		A	B	C	L1	L2	SW	
Spannmutter für Dichtscheibe / Spannschlüssel (Dichtscheibe Seite 31) Clamping Nut for sealing disc / wrench (sealing disc page 31)								
EX16-IC 6931372		28	22,5	M22x1,5	12,0-15,5	5	25	
EX20-IC 6931227		34	24	M25x1,5	13,0-16,5	5	30	
EX25-IC 6941678		42	25	M32x1,5	13,5-17,0	5		
EX32-IC 6933897		50	27,5	M40x1,5	14,5-18,0	5		
EX40-IC 6948425		63	30,5	M50x1,5	16,5-20,0	5		
EX50-IC 5085410		78	40,3	M64x2	19,0-26,0	7		
Spannmutter mit integrierter Dichtung / Spannschlüssel Clamping Nut with integrated seal / wrench								
EX12-3-IC 5058947		19	14,6	M14x0,75	8,10-9,80	3,5	17	
EX12-3,5-IC 5055118								
EX12-4-IC 5020211								
EX12-4,5-IC 5020219								
EX12-5-IC 5020220								
EX12-5,5-IC 5058948								
EX12-6-IC 6952625								
EX12-6,5-IC 5058949								
EX12-7-IC 5058950								
Spannmutter ohne Dichtscheibe / Spannschlüssel Clamping Nut without sealing disc / wrench								
EX12 6919083			19	11,3	M14x0,75	4,9-6,6		17
EX16 6919040			28	17,5	M22x1,5	7,0-10,5		25
EX20 6918743			34	19	M25x1,5	8,0-11,5		30
EX25 6919084		42	20	M32x1,5	8,5-12,0			
EX32 6918697		50	22,5	M40x1,5	9,5-13,0			
EX40 6919085		63	25,5	M50x1,5	11,5-15,0			
EX50 6951202		78	35,3	M64x2,0	14,0-21,0			

Id-No.			ESX	Ø mm	ESX-GB	Bez./Id.Nr. Des./Id.No.	TORCO-FIX Aufsteckschlüssel Fitting key
E16P-25 5105244			8 Nm	1		A-E16P	
			20 Nm	1,5-3,5		6953670	
			40 Nm	4,0-4,5	40 Nm		
			56 Nm	5,0-10,0	44 Nm		
E20P-30 5105245			16 Nm	1		A-E20P	
	32 Nm	1,5-6,5	32 Nm	5003125			
	80 Nm	7,0-13,0	35 Nm				
E25 6921608			24 Nm	1,0-3,5		A-E25	
			56 Nm	4,0-4,5	56 Nm	6953671	
			80 Nm	5,0-7,5	80 Nm		
			104 Nm	8,0-17,0	104 Nm		
E32 6921609			24 Nm	2,0-2,5		A-E32	
E40 6921610	136 Nm	3,0-22,0	136 Nm	6952304			
E50 6951711	176 Nm	3,0-26,0	176 Nm	A-E40 5000742			
	300 Nm	22,0-32,0	300 Nm	A-E50 5003124			
E11P-17 5105243			24 Nm	3,0-7,0	24 Nm	A-E11P 5047900	
E11P-17 5105243			24 Nm	3,0-7,0	24 Nm	A-E11P 5047900	
E16P-25 5105244			8 Nm	1		A-E16P	
			20 Nm	1,5-3,5		6953670	
			40 Nm	4,0-4,5	40 Nm		
E20P-30 5105245			56 Nm	5,0-10,0	44 Nm		
	16 Nm	1		A-E20P			
	32 Nm	1,5-6,5	32 Nm	5003125			
	80 Nm	7,0-13,0	35 Nm				
E25 6921608			24 Nm	1,0-3,5		A-E25	
			56 Nm	4,0-4,5	56 Nm	6953671	
			80 Nm	5,0-7,5	80 Nm		
			104 Nm	8,0-17,0	104 Nm		
E32 6921609			24 Nm	2,0-2,5		A-E32	
E40 6921610	136 Nm	3,0-22,0	136 Nm	6952304			
E50 6951711	176 Nm	3,0-26,0	176 Nm	A-E40 5000742			
	300 Nm	22,0-32,0	300 Nm	A-E50 5003124			

Bezeichnung/Id. Nr. Designation/Id. No.		A	B	C	L1	L2	SW
Mini-Spannmutter mit Dichtscheibe/Spanschlüssel Mini Clamping Nut with sealing disc/wrench							
EX16-MC 6944416		22	22	M19x1,0	11,5–15,0	4,5	
EX20-MC 6951224		28	24	M24x1,0	13,0–16,5	5	
EX25-MC 6955533		35	25	M30x1,0	13,5–17,0	5	
Mini-Spannmutter mit integrierter Dichtung/Spanschlüssel Mini Clamping Nut with integrated seal/wrench							
EX12-...-MC auf Anfrage, Ø angeben on request, state Ø		16	14,6	M13x0,75	8,1–9,8	3,5	
Mini-Spannmutter ohne Dichtscheibe/Spanschlüssel Mini Clamping Nut without sealing disc/wrench							
EX12-M 6941535		16	12	M13x0,75	5,7–7,5	0,4	
EX16-M 6932504		22	18,4	M19x1	8,0–11,5	0,9	
EX20-M 6940464		28	19	M24x1	8,0–11,5		
EX25-M 6951256		35	20	M30x1	8,5–12,0		
BILZ-Spannmutter mit Dichtscheibe/Spanschlüssel BILZ Clamping Nut with sealing disc/wrench							
BM12-D-BG 5022101		17	18	M14x1			15
BM18-D-BG 5003288		25	18	M21x1			23
BM25-D-BG 5003981		34	24	M30x1			30

Drehmomentschlüssel TORCO-FIX Torque wrench TORCO-FIX				
	Bezeichnung Designation	Id.No.	I 1	Drehmoment Nm Torque Nm
	TORCO-FIX I	6734177	335	5 – 50
	TORCO-FIX II	6734178	465	20 – 200
	TORCO-FIX III	6734179	565	60 – 300

Id-No.			ESX	Ø mm	ESX-GB	Bez./Id.Nr. Des./Id.No.	TORCO-FIX Aufsteckschlüssel Fitting key
E16M 6932510			8 Nm	1		A-E16M	
			20 Nm	1,5-3,5		5047902	
			40 Nm	4,0-10,0	24 Nm		
E20M 6934089			16 Nm	1		A-E20M	
			28 Nm	1,5-13,0	28 Nm	5047903	
E25M 6933989			24 Nm	1,0-3,5		A-E25M	
	32 Nm	4,0-17,0	32 Nm	5076778			
E11M 6942650			8 Nm	1,0-2,9		A-E11M	
			16 Nm	3,0-7,0	13 Nm	5047901	
E11M 6942650			8 Nm	1,0-2,9	8 Nm	A-E11M	
			16 Nm	3,0-7,0	13 Nm	5047901	
E16M 6932510			8 Nm	1		A-E16M	
			20 Nm	1,5-3,5		5047902	
			24 Nm	4,0-10,0	24 Nm		
E20-M 6934089			16 Nm	1		A-E20M	
			28 Nm	1,5-13	28 Nm	5047903	
E25-M 6933989			24 Nm	1,0-3,5		A-E25M	
	32 Nm	4,0-217,0	32 Nm	5076778			
			BZK				
DIN3110-21x23 6952334 DIN894-30 6934034			18 Nm			16Z-SW15 5056892	
			30 Nm			16Z-SW23 5056896	
			40 Nm			16Z-SW30 5056897	

Aufsteckschlüssel TORCO-FIX Fitting keys TORCO-FIX					
	Bez. Des.	Nr No	TORCO- FIX	a	b
	A-E11P	5047900	I	32	61
	A-E16P	6953670	I, II	44	71
	A-E20P	5003125	II	52	81
	A-E25	6953671	II	70	72
	A-E32	6952304	II, III	80	72
	A-E40	5000742	II, III	96	82
	A-E50	5003124	III	111	94
	A-E11M	5047901	I	16,8	54,4
	A-E16M	5047902	I, II	22,5	56,2
	A-E20M	5047903	I, II	29	68,2
	A-E25M	5076778	I, II	36	70,0
	16Z-SW15	5056892	I	34,5	32
	16Z-SW23	5056896	I, II	56	32
	16Z-SW30	5056897	I, II	68	32

Montagevorrichtung
Assembly device

Bezeichnung/Id. Nr. Designation/Id. No.		h mm	l mm	b mm
V-V274	SCK0-3	105	105	170
5069450				

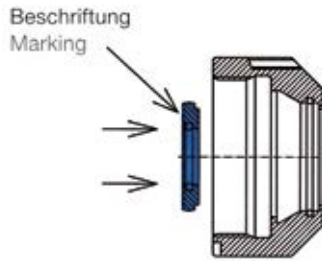

Einbau

Beim Einsetzen der Dichtscheibe in die Spannmutter muss die Beschriftung der Dichtscheibe von hinten her lesbar sein.

Assembling

The disc must be flush with the outside of the nut and the marking on the disc must be seen inside the nut.



Dichtscheibe in die Spannmutter einlegen und nach vorne drücken, bis ein deutliches „Klicken“ zu hören ist. Jetzt ist die Dichtscheibe richtig in die Spannmutter eingesetzt. Die richtig montierte Dichtscheibe ist vorne mit der Spannmutter bündig.

Insert the small diameter of the disc into the center of the coolant nut and apply even pressure until the disc is properly seated into the nut.

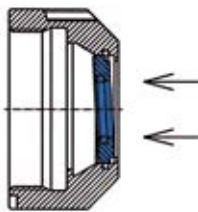

Ausbau

Um die Dichtscheibe herauszunehmen, von der Außenseite auf die Dichtscheibe drücken, bis sie herausspringt.

Removing

To remove the disc, simply press on the outside of the disk evenly until it snaps out.

! Unbedingt Werkzeug von vorne einführen, sonst wird der O-Ring in der Dichtscheibe beschädigt.

! Insert tool from the front. O-ring will be damaged if cutting tool is inserted from the back.

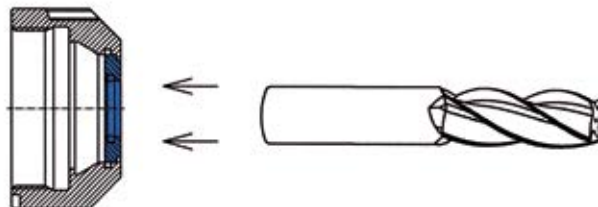

! Beim Einführen vom Werkzeug darauf achten, dass die Dichtscheibe nicht zurück geschoben wird.

! Take care when inserting the tool that you do not push back the sealing disc.

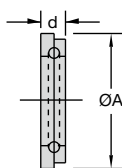

DS/ER							
Dichtbereich Sealing Range mm	 ESX12*	DS/ER 16 (dxA) 4x13 mm	DS/ER 20 (dxA) 4x16 mm	Id. No. DS/ER 25 (dxA) 4x21 mm	DS/ER 32 (dxA) 4x27 mm	DS/ER 40 (dxA) 4x33,5 mm	DS/ER 50 (dxA) 5,5x42,5 mm
3,00 – 2,50		6953629	6954178	6954181	6954194	6954264	
3,50 – 3,00		6954176	6948385	6947674	6954195	6954265	
4,00 – 3,50	5020211	6952696	6953235	6954182	6954112	6954266	
4,50 – 4,00	5020219	6944324	6948386	6954183	6954196	6954267	
5,00 – 4,50	5020220	6952972	6953236	6954184	6954113	6954268	
5,50 – 5,00		6954177	6952104	6954185	6954197	6954269	
6,00 – 5,50	6952625	6931371	6943901	6953215	6948674	6954270	
6,50 – 6,00		6943060	6953031	6954186	6954198	6954271	
7,00 – 6,50		6940533	6950178	6943420	6953637	6954272	
7,50 – 7,00		6952195	6953237	6943421	6954199	6954273	
8,00 – 7,50		6941539	6946991	6943419	6949999	6952197	
8,50 – 8,00		6946898	6953238	6952198	6954200	6954274	
9,00 – 8,50		6941992	6947339	6941679	6949298	6954275	
9,50 – 9,00		6946897	6954179	6946744	6954201	6954276	
10,00 – 9,50		6942300	6931347	6943423	6948675	6952199	
10,50 – 10,00			6952196	6954187	6952918	6954277	
11,00 – 10,50			6944294	6943534	6948387	6954278	
11,50 – 11,00			6953239	6954188	6951274	6954279	
12,00 – 11,50			6943902	6943424	6946689	6954280	
12,50 – 12,00			6954180	6954189	6951275	6954281	
13,00 – 12,50			6947968	6948123	6952973	6954282	
13,50 – 13,00				6954190	6954202	6954283	
14,00 – 13,50				6943342	6946613	6954284	
14,50 – 14,00				6954191	6954203	6954285	
15,00 – 14,50				6954192	6954204	6954114	
15,50 – 15,00				6954193	6954205	6954286	
16,00 – 15,50				6943422	6946822	6946054	
16,50 – 16,00					6954206	6954287	
17,00 – 16,50					6954207	6954288	
17,50 – 17,00					6954208	6954289	
18,00 – 17,50					6946002	6946120	
18,50 – 18,00					6954209	6952210	
19,00 – 18,50					6954210	6954115	
19,50 – 19,00					6954211	6954290	
20,00 – 19,50					6933868	6952971	
20,50 – 20,00						6954291	
21,00 – 20,50						9071745	
21,50 – 21,00						6954292	
22,00 – 21,50						6949887	5085415
22,50 – 22,00						6952212	
23,00 – 22,50						9071747	
23,50 – 23,00						6954293	
24,00 – 23,50						9071748	
24,50 – 24,00						6954294	
25,00 – 24,50						6948426	5085420
25,50 – 25,00						6954295	
26,00 – 25,50						9072720	
28,00 – 27,50							5085421
32,00 – 31,50							5085422
36,00 – 35,50							5085423

Hinweis: *ESX12 keine Dichtscheibe/abgedichtete Spannmutter

Note: *ESX12 no sealing disc/sealing nut only

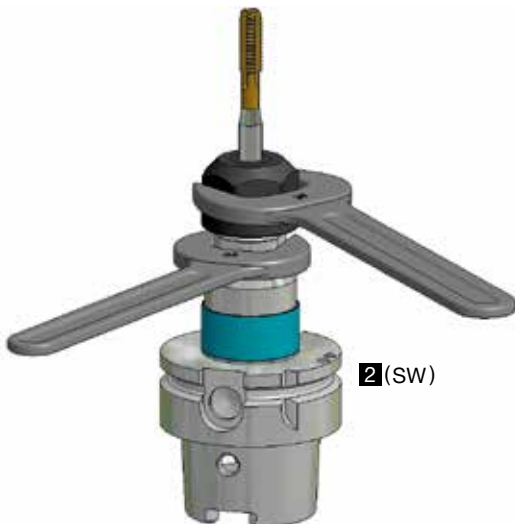
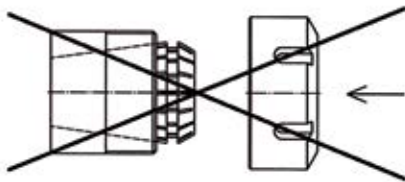
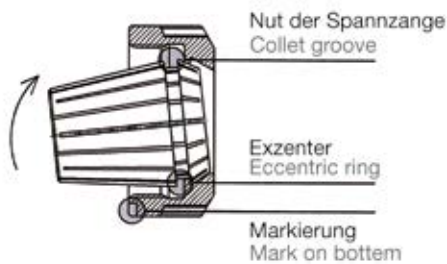

Montageanleitung

Nut der Spannzange an der markierten Stelle in den Exzentering der Spannmutter einhängen. Spannzange in entgegengesetzte Richtung kippen, bis diese deutlich hörbar einrastet.

Werkzeug einsetzen.

Spannmutter mit der eingerasteten Spannzange auf das Gewinde des Halters schrauben. Wir empfehlen, die Spannmutter mit einem Drehmomentschlüssel anzuziehen.

Assembling Collet:

Insert groove of the collet into eccentric ring of the clamping nut at the mark on the bottom of the nut. Push collet in the direction of the arrow until it clicks in.

Insert tool. Screw nut with collet onto tool holder.

Demontage

Nach dem Abschrauben vom Halter auf die Frontseite der Spannzange drücken und gleichzeitig die Spannzange durch seitlichen Druck auf den hinteren Teil, gegenüber der Markierung, aus der Einrastung der Mutter heraus drücken.

Removing Collet:

After the nut is unscrewed from the toolholder, press on the face of the collet while simultaneously pushing sideways on the back of the collet opposite the mark until it disengages from the clamping nut.

- ! **Eine falsche Handhabung** beeinträchtigt den Rundlauf der Spannzange und kann die Spannmutter beschädigen.
- Nur Spannmuttern mit richtig eingerasteter Spannzange in den Spannzangenhalter einsetzen!

- ! **Improper assembly** can permanently damage the concentricity of the collet and may result in the destruction of the clamping nut.
- Only mount nuts with correctly inserted collets.
- Never place the collet into the holder without first assembling into the nut.

Zur Vermeidung von Schäden an dem Synchrofutter mit dem Schlüssel **2** (SW) beim Anziehen der Mutter gegenhalten. Siehe auch Montagevorrichtung Seite 29.

Die Schlüssel sind nicht im Lieferumfang enthalten.

To avoid any damage of the synchro chuck use key **2** (SW) to hold the chuck while tightening the nut. See also assembly device page 29.

Setting key not included.

SCK	ESX	2 (SW)	DIN	Id. No.
1	20	23 mm	DIN 3110 - 21 x 23	6952334
2	32	38 mm	DIN 894 - 38	5058889
3	40	46 mm	DIN 894 - 46	5058890

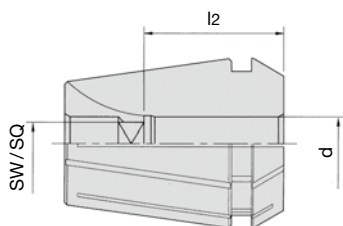

ESX ... GB Spannzange mit Innenvierkant für Gewindebohrer ESX ... GB collet with drive square for taps														
d x SW	l2	DIN 371	DIN 374	DIN 376	JIS B 4430 1988	ISO		Id.No.						
							①	ESX 12 GB	ESX 16 GB	ESX 20 GB	ESX 25 GB	ESX 32 GB	ESX 40 GB	ESX 50 GB
2,8 x 2,1	12	M2-2,5	M4	M4				5073435						
3,5 x 2,7	14	M3	M5	M4,5 M5				5055115						
4,0 x 3,0	14	M3,5	M5,5					5073436						
4,0 x 3,15	*14/15				M3			5020195	6954588	6949762		6950665		
4,0 x 3,2					M3,5									
4,5 x 3,4	*14/15	M4	M6	M6				5020217	6951393	6948389	6951218	6952585		
5,0 x 4,0	*14/18				M4 M4,5		M5	5020218	6954872	6949763	5073850	5069529		
5,5 x 4,3	18		M7	M7					6954656	6949764	5073851	5069531		
5,5 x 4,5	18				M5				6952288	6949765	5073852	5069532		
6,0 x 4,5	18				M6				6952289	6949766	5073853	6953220		
6,0 x 4,9	*14/18	M4,5 M6	M8	M8				6950826	6951392	6948390	6951544	6949997		
6,2 x 5,0	18				M7 M8				5073846	5049187	5073854	5069533		
6,3 x 5,0	18					M8	M6		6946901	6951397	6951217	6946964		
7,0 x 5,5	18	M7	M9 M10	M9 M10	M9 M10				6947340	6949767	6951797	6950029		
7,1 x 5,6	18								5073847	6953228	5073855	6951552		
8,0 x 6,2	22	M8	M11			M10	M8		6946213	6949202	6951214	6949769	6955396	
8,0 x 6,3														
8,5 x 6,5	22				M12				5073849	6949768	6954875	6953221	5069534	
9,0 x 7,0	22	M9	M12	M12		M12			6947393	6947338	6951216	6946965	6955397	
9,0 x 7,1														
10,0 x 8,0	25	M10					M10			6949111	6951215	6949998	9080012	
10,5 x 8,0	25				M14					6953229	6954876	6952835	5066607	
11,0 x 9,0	25		M14	M14						6949177	6946167	6946104	6955398	
11,2 x 9,0	25					M14				6949353	6951551	6951219	5069535	
12,0 x 9,0	25	M12	M16	M16						9206617	6950343	6946106	9074741	
12,5 x 10,0	25				M16	M16					6951398	6951553	6951493	
14,0 x 11,0	25		M18	M18	M18	M18					6951559	6947337	9074742	
14,0 x 11,2														
15,0 x 12,0	25				M20						5073856	6953222	5066608	
16,0 x 12,0	25		M20	M20							6951399	6948391	9080073	
16,0 x 12,5														
17,0 x 13,0	25				M22							5066606	5066609	
18,0 x 14,0	25		M22	M22		M24						6950206	6952207	
18,0 x 14,5			M24	M24										
20,0 x 16,0	28		M27	M27		M27 M30						6948392	6948903	
22,0 x 18,0	28		M30	M30									6949124	
22,0 x 18,0	41		M30	M30										5065799
25,0 x 20,0	41		M33	M33		M36								5065800
28,0 x 22,0	41		M36	M36										5065801
32,0 x 24,0	41		M39	M39										5065802
			M42	M42										

① Schaft verstärkt
① Reinforced shank

* ESX12 = 14
* ESX16-32 = 15 bzw. 18

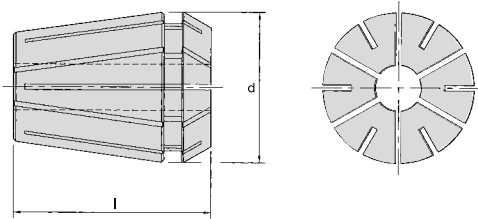

			ER8	ER11	ER16	ER20	ER25	ER32	ER40
Spannbereich Clamping range			ESX 8 l = 13,6 d = 8,5	ESX 12 l = 18,0 d = 11,5	ESX 16 l = 27,5 d = 17,0	ESX 20 l = 31,5 d = 21,0	ESX 25 l = 34,0 d = 26,0	ESX 32 l = 40,0 d = 33,0	ESX 40 l = 46,0 d = 41,0
mm	Zoll/inch		Id. No.	Id. No.	Id. No.	Id. No.	Id. No.	Id. No.	Id. No.
	nominal	fractional							
1,00 - 0,50	0,0394...0,1097	1/32"	5118029	6921612					
1,50 - 1,00	0,0591...0,0394		5118031	6921613					
2,00 - 1,50	0,0787...0,0591	1/16"	5118032	6921614					
2,50 - 2,00	0,0984...0,0787	3/32"	5118033	6921615					
3,00 - 2,50	0,1184...0,0984		5118034	6921616					
3,50 - 3,00	0,1378...0,1181	1/8"	5118035	6927917					
4,00 - 3,50	0,1575...0,1378	5/32"	5118036	6921617					
4,50 - 4,00	0,1772...0,1575		5118037	6927918					
5,00 - 4,50	0,1969...0,1772	3/16"	5118038	6921618					
5,50 - 5,00	0,2165...0,1969			6927919					
6,00 - 5,50	0,2362...0,2165	7/32"		6921619					
6,50 - 6,00	0,2559...0,2362	1/4"		6927920					
7,00 - 6,50	0,2756...0,2559			6921620					
1,00 - 0,50	0,0394...0,1097	1/32"			6921621	6954299	6952416		
1,50 - 1,00	0,0591...0,0394				6951299	6921634	6954309		
2,00 - 1,00	0,0787...0,0394				6921623	6921635	6949055	6951900	
3,00 - 2,00	0,1181...0,0787				6921625	6921637	6921652	6921667	6953179
4,00 - 3,00	0,1575...0,1181	5/32"			6921626	6921638	6921653	6921668	6921685
5,00 - 4,00	0,1969...0,1575	3/16"			6921627	6921639	6921654	6921669	6921686
6,00 - 5,00	0,2362...0,1969	7/32"			6921628	6921640	6921655	6921670	6921687
7,00 - 6,00	0,2756...0,2362				6921629	6921641	6921656	6921671	6921688
8,00 - 7,00	0,3150...0,2756	5/16"			6921630	6921642	6921657	6921672	6921689
9,00 - 8,00	0,3543...0,3150	11/32"			6921631	6921643	6921658	6921673	6921690
10,00 - 9,00	0,3937...0,3543				6921632	6921644	6921659	6921674	6921691
11,00 - 10,00	0,4330...0,3937					6921645	6921660	6921675	6921692
12,00 - 11,00	0,4724...0,4375	15/32"				6921646	6921661	6921676	6921693
13,00 - 12,00	0,5118...0,4724	1/2"				6921647	6921662	6921677	6921694
14,00 - 13,00	0,5512...0,5118						6921663	6921678	6921695
15,00 - 14,00	0,5905...0,5512						6921664	6921679	6921696
16,00 - 15,00	0,6300...0,5905	5/8"					6921665	6921680	6921697
17,00 - 16,00	0,6693...0,6300	21/32"						6921681	6921698
18,00 - 17,00	0,7087...0,6693							6921682	6921699
19,00 - 18,00	0,7480...0,7078							6921683	6921700
20,00 - 19,00	0,7874...0,7480	25/32"						6921684	6921701
21,00 - 20,00	0,8268...0,7874	13/16"							6921702
22,00 - 21,00	0,8661...0,8268								6921703
23,00 - 22,00	0,9055...0,8661								6921704
24,00 - 23,00	0,9449...0,9055	15/16"							6921705
25,00 - 24,00	0,9843...0,9449	31/32"							6921706
26,00 - 25,00	1,0236...0,9843								6921707
27,00 - 26,00	1,0630...1,0236	1.1/16"							6923957
28,00 - 27,00	1,1024...1,0630	1.3/32"							6954680
29,00 - 28,00	1,1417...1,1024	1.1/8"							6954966
30,00 - 29,00	1,1811...1,1417	1.5/32"							6953214

Für periphere Kùhlung der Werkzeuge / For peripheral cooling of the tools

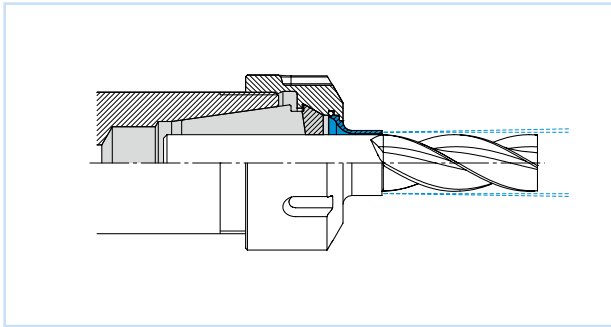

Einbau/Ausbau Assembly/Disassembly

Beschriftung/Description

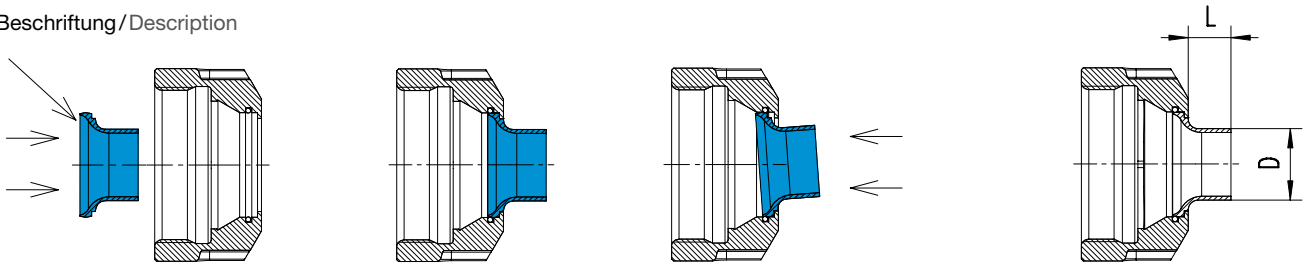

Bezeichnung Designation	Id. No.	L mm	D mm	Bezeichnung Designation	Id. No.	L mm	D mm
KS/ER16-3,0	5083082	11,0	6,4	KS/ER25-3,0	5083090	11,0	6,4
KS/ER16-4,0	5083083	11,0	7,4	KS/ER25-4,0	5083091	11,0	7,4
KS/ER16-5,0	5083084	11,0	8,4	KS/ER25-5,0	5083092	11,0	8,4
KS/ER16-6,0	5083085	11,0	9,4	KS/ER25-6,0	5083093	11,0	9,4
KS/ER16-7,0	5083086	11,0	12,0	KS/ER25-7,0	5083094	11,0	10,4
KS/ER16-8,0	5083087	11,0	11,0	KS/ER25-8,0	5083095	11,0	11,3
KS/ER16-9,0	5083088	3,0	11,0	KS/ER25-9,0	5083096	11,0	12,4
KS/ER16-10,0	5083089	3,0	11,0	KS/ER25-10,0	5083097	11,0	13,4
KS/ER20-3,0	5083073	11,0	6,4	KS/ER25-12,0	5083098	11,0	15,4
KS/ER20-4,0	5083074	11,0	7,4	KS/ER25-14,0	5083099	11,0	17,4
KS/ER20-5,0	5083075	11,0	8,4	KS/ER25-16,0	5083100	11,0	19,0
KS/ER20-6,0	5069262	11,0	9,4	KS/ER32-3,0	5083101	11,0	6,4
KS/ER20-7,0	5083077	11,0	10,4	KS/ER32-4,0	5083102	11,0	7,4
KS/ER20-8,0	5083078	11,0	11,4	KS/ER32-5,0	5083103	11,0	8,4
KS/ER20-9,0	5083079	11,0	12,4	KS/ER32-6,0	5083104	11,0	9,4
KS/ER20-10,0	5083080	11,0	14,4	KS/ER32-7,0	5083105	11,0	10,4
KS/ER20-12,0	5083081	3,0	14,4	KS/ER32-8,0	5083106	11,0	11,4
				KS/ER32-9,0	5083107	11,0	12,4
				KS/ER32-10,0	5083108	11,0	13,4
				KS/ER32-12,0	5083109	11,0	15,4
				KS/ER32-14,0	5083110	11,0	17,4
				KS/ER32-16,0	5083111	11,0	19,4
				KS/ER32-18,0	5083112	11,0	19,4
				KS/ER32-20,0	5083113	11,0	24,0

Anwendung: Gewindeschneiden, -formen

Maschinentyp: Bearbeitungszentren, Transferstraßen, Sondermaschinen, Bohr-, Fräsmaschinen

Application: tapping, roll forming

Machine type: machining centres, transfer lines, special purpose, drilling and milling machines

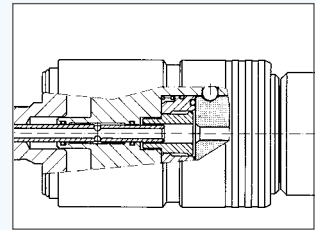
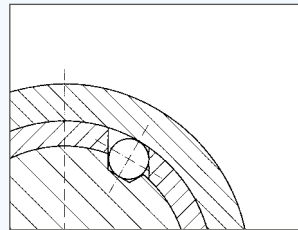
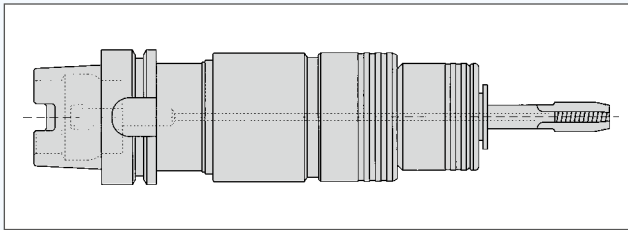

Gewindeschneiden und -formen mit neuer Technik

BILZ-Futter WFLC und WFLC K zum Gewindeschneiden auf mechanisch und numerisch gesteuerten Maschinen zeichnen sich vor allem durch einen neu entwickelten Längenausgleich aus, der auf Druck sowie auf Zug wirksam ist.

Durch die spezielle Anordnung der Kugeln und die damit verbundene optimale Kräfteverteilung ist der Längenausgleich bisherigen Systemen deutlich überlegen.

Ein harter Anschnittdruck und ein leichtgängiger Längenausgleich garantieren auch unter schwierigsten Bedingungen toleranzhaltige Gewinde und damit Sicherheit in der Produktion.

Das WFLC K-Futter mit Kühlmitteldurchführung ist für Drücke bis max. 50 bar ausgelegt.

Durch die hydrostatisch neutrale Kühlmitteldurchführung funktioniert der Längenausgleich unter jeder Bedingung.

Beim WFLC-Futter erfolgt das Wechseln der BILZ-Standard-einsätze über den Längenausgleich. Beim WFLC K-Futter erfolgt das Wechseln der Kühlmiteileinsätze über ein vom Längenausgleich unabhängiges Wechselsystem.

Durch das modulare Schaftsystem können die Gewindeschneid-futter mit unseren Werkzeugaufnahmen Typ WA maschinen-spezifisch angepasst werden.

Für Standardaufnahmen sind auch Monoblock-Werkzeuge lieferbar.

Die WFLC- und WFLC K-Futter sind wartungsfrei und erreichen dadurch eine hohe Prozesssicherheit.

A new concept in tapping and cold forming of threads

The Bilz range of WFLC and WFLC K tapping systems with extension and compression are designed for use on both manual and numerically controlled machines.

The new concept is characterised by the asymmetric arrangement of the balls which results in the optimum distribution of force, thus making the length compensation superior to previous systems, which, when combined with a stiff initial cutting pressure, ensures accuracy and effective operation under the most difficult of machining conditions.

The length compensation is unaffected by the hydrostatic neutral coolant feed, and the WFLC K chuck is designed to operate with internal coolant up to 50 bar pressure. The changing of tap adaptors is simple and effective and does not affect the systems of the chuck.

Because of its modular shank system and by utilising the Bilz WA toolholder, it is possible to use the Bilz WFLC on numerous machine configurations.

Both the WFLC and WFLC K tapping systems are maintenance free and therefore maintain a high level of long term efficiency.

Merkmale:	Vorteile:	Nutzen:
<ul style="list-style-type: none"> ▪ außermittige Kugelanordnung 	<ul style="list-style-type: none"> ▪ optimale Kräfteverteilung 	<ul style="list-style-type: none"> ▪ weniger wartungsanfällig
<ul style="list-style-type: none"> ▪ Anschnittdruckverstärker, höhere Axialkraft, nicht einstellbar 	<ul style="list-style-type: none"> ▪ Vermeidet Einfedern im Druckbereich beim Anschneiden 	<ul style="list-style-type: none"> ▪ Reduzierung der Fehlerquote
<ul style="list-style-type: none"> ▪ Hydrostatischer Druckausgleich max. 50 bar 	<ul style="list-style-type: none"> ▪ kein Vorfahren des Längenausgleichs bei höheren Kühlmitteldrücken, bzw. Druckstau bei verschlossenem Gewindebohrerkühlkanal 	<ul style="list-style-type: none"> ▪ keine Kollisions- bzw. Werkzeugbruchgefahr
<ul style="list-style-type: none"> ▪ besser abgedichtet 	<ul style="list-style-type: none"> ▪ weniger verschmutzungsanfällig 	<ul style="list-style-type: none"> ▪ längere Wartungsintervalle
<ul style="list-style-type: none"> ▪ modulares Schaftsystem MS, W 	<ul style="list-style-type: none"> ▪ höhere Flexibilität 	<ul style="list-style-type: none"> ▪ geringerer Werkzeugbestand
<ul style="list-style-type: none"> ▪ horizontal, vertikal einsetzbar 	<ul style="list-style-type: none"> ▪ höhere Flexibilität 	<ul style="list-style-type: none"> ▪ geringerer Werkzeugbestand
<ul style="list-style-type: none"> ▪ geeignet für Links- und Rechtsgewinde 	<ul style="list-style-type: none"> ▪ höhere Flexibilität 	<ul style="list-style-type: none"> ▪ geringerer Werkzeugbestand
Features:	Advantages:	Benefits:
<ul style="list-style-type: none"> ▪ out of centre ball configuration 	<ul style="list-style-type: none"> ▪ optimal force distribution 	<ul style="list-style-type: none"> ▪ less maintenance required
<ul style="list-style-type: none"> ▪ hard start with higher axial force, not adjustable 	<ul style="list-style-type: none"> ▪ to avoid the chuck getting into compression during the start of the tap 	<ul style="list-style-type: none"> ▪ reduction of error rate
<ul style="list-style-type: none"> ▪ hydrostatic pressure compensation max. 50 bar 	<ul style="list-style-type: none"> ▪ no axial movement of the spindle into tension, even when the coolant flow is blocked 	<ul style="list-style-type: none"> ▪ no risk of collision or tap breakage
<ul style="list-style-type: none"> ▪ better sealing 	<ul style="list-style-type: none"> ▪ no malfunction due to contamination 	<ul style="list-style-type: none"> ▪ longer maintenance sequences
<ul style="list-style-type: none"> ▪ modular shank system MS, W 	<ul style="list-style-type: none"> ▪ higher flexibility 	<ul style="list-style-type: none"> ▪ reduced number of tools required
<ul style="list-style-type: none"> ▪ horizontally, vertically applicable 	<ul style="list-style-type: none"> ▪ higher flexibility 	<ul style="list-style-type: none"> ▪ reduced number of tools required
<ul style="list-style-type: none"> ▪ applicable for left and right handed threads 	<ul style="list-style-type: none"> ▪ higher flexibility 	<ul style="list-style-type: none"> ▪ reduced number of tools required

WFLC – Gewindeschneid-Schnellwechselfutter
WFLC – Quick change tapping chucks

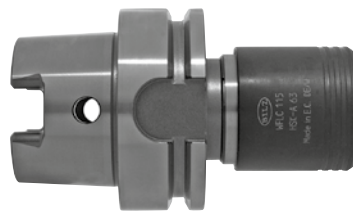
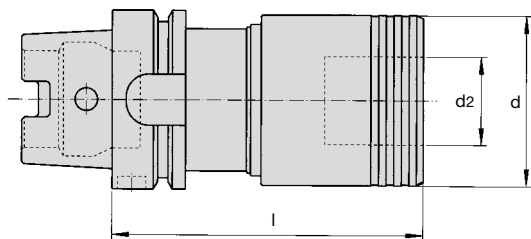

DIN
69 893 A



WFLC/HSK-A...											
Bezeichnung Designation					d	d2		HSK50	HSK63	HSK80	HSK100
WFLC012/HSK-A...	0	M2-M8	6	6	28	13	I	-	66	-	-
							Id. No.	-	9163079	-	-
WFLC115/HSK-A...	1	M3-M12	7,5	7,5	39	19	I	72	72	75	80
							Id. No.	6728133	6727989	6728062	6728020
WFLC115-0/HSK-A...	1	M3-M12	0	12,5	39	19	I	64,5	64,5	67,5	72,5
							Id. No.	6728083	6728015	6728157	6728078
WFLC220/HSK-A...	2	M8-M20	10	10	60	31	I	110	110	95	100
							Id. No.	6728386	6728293	6728335	6728286
WFLC220-0/HSK-A...	2	M8-M20	0	16,5	60	31	I	100	100	85	90
							Id. No.	-	6728292	6728403	6728284
WFLC335/HSK-A...	3	M14-M33	17,5	17,5	86	48	I	-	141	141	144
							Id. No.	-	6728463	-	6728469
WFLC335-0/HSK-A...	3	M14-M33	0	35	86	48	I	-	123,5	123,5	126,5
							Id. No.	-	6728474	-	6728533
WFLC440/HSK-A...	4	M22-M48	20	20	107	60	I	-	164	164	167
							Id. No.	-	6728551	-	6728571

Passende Schnellwechsel-Einsätze siehe Seite 98 – 132
 Suitable quick change adaptors see page 98 – 132

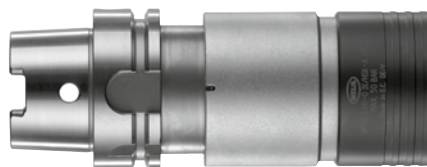
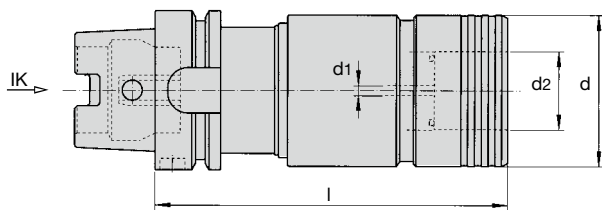

WFLC..IK/HSK-A...															
Bezeichnung Designation					d	d1	d2		HSK32	HSK40	HSK50	HSK63	HSK80	HSK100	
WFLC012-0-IK/HSK-A...	0	M2-M8	0	12	28	2	13	I	84	80	-	86	-	-	
								Id. No.	6727938	6727939	-	5060281	-	-	
WFLC115-IK/HSK-A...	1	M3-M12	7,5	7,5	39	2,5	19	I	-	-	103	105	110	112	
								Id. No.	-	-	6728134	6728000	6728129	6728026	
WFLC115-0-IK/HSK-A...	1	M3-M12	0	15	39	2,5	19	I	-	-	95,5	97,5	102,5	104,5	
								Id. No.	-	-	6728067	6728001	6728121	6728068	
WFLC220-IK/HSK-A...	2	M8-M20	10	10	60	4	31	I	-	-	140	140	142	144	
								Id. No.	-	-	6728342	6728256	6728385	6728294	
WFLC220-0-IK/HSK-A...	2	M8-M20	0	20	60	4	31	I	-	-	130	130	132	134	
								Id. No.	-	-	6728339	6728282	6728369	6728285	
WFLC335-IK/HSK-A...	3	M14-M33	17,5	17,5	86	5	48	I	-	-	-	203	208	210	
								Id. No.	-	-	-	6728526	-	6728477	
WFLC335-0-IK/HSK-A...	3	M14-M33	0	35	86	5	48	I	-	-	-	185,5	190,5	192,5	
								Id. No.	-	-	-	6728512	6728525	6728535	
WFLC440-IK/HSK-A...	4	M22-M48	20	20	107	6	60	I	-	-	-	-	-	235	
								Id. No.	-	-	-	-	-	6728577	
WFLC440-0-IK/HSK-A...	4	M22-M48	0	35	107	6	60	I	-	-	-	-	-	215	
								Id. No.	-	-	-	-	-	6728581	

Passende Schnellwechsel-Einsätze siehe Seite 98 – 132
Suitable quick change adaptors see page 98 – 132

Kühlmittelrohr ist im Lieferumfang enthalten.
Coolant tube included.

DIN
69893A



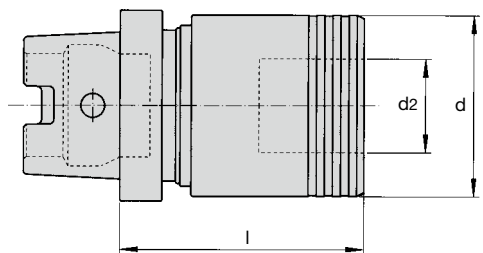

DIN
69893 C



WFLC/HSK-C...													
Bezeichnung Designation					d	d2	l						
								HSK32	HSK40	HSK50	HSK63	HSK80	HSK100
WFLC012/HSK-C...	0	M2-M8	6	6	28	13	I	53	-	52	-	-	-
							Id. No.	6727899	-	6773366	-	-	-
WFLC012-0/HSK-C...	0	M2-M8	0	12	28	13	I	47	47	52	-	-	-
							Id. No.	6727898	6727903	6727901	-	-	-
WFLC115/HSK-C...	1	M3-M12	7,5	7,5	39	19	I	-	-	59	62	66	66
							Id. No.	-	-	6728012	6727965	-	6728024
WFLC115-0/HSK-C...	1	M3-M12	0	12,5	39	19	I	-	-	51,5	54,5	58,5	58,5
							Id. No.	-	-	6728018	6728088	-	-
WFLC220/HSK-C...	2	M8-M20	10	10	60	31	I	-	-	81	81	90	90
							Id. No.	-	-	6728287	6728281	-	-
WFLC220-0/HSK-C...	2	M8-M20	0	16,5	60	31	I	-	-	71	71	80	80
							Id. No.	-	-	6728253	6728296	6728384	-
WFLC335/HSK-C...	3	M14-M33	17,5	17,5	86	48	I	-	-	115	115	115	-
							Id. No.	-	-	-	6728467	-	-
WFLC335-0/HSK-C...	3	M14-M33	0	35	86	48	I	-	-	97,5	97,5	97,5	-
							Id. No.	-	-	-	6728472	-	-
WFLC440/HSK-C...	4	M22-M48	20	20	107	60	I	-	-	-	135	-	-
							Id. No.	-	-	-	9077564	-	-

Passende Schnellwechsel-Einsätze siehe Seite 98 – 132
 Suitable quick change adaptors see page 98 – 132

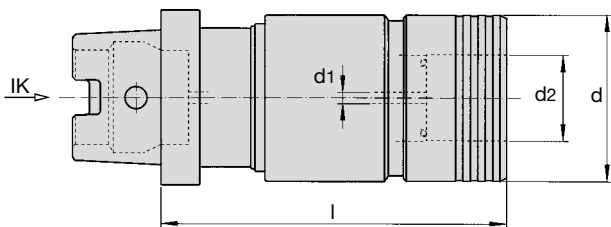

WFLC...IK/HSK-C...														
Bezeichnung Designation					d	d1	d2	I	DIN 69893 C					
									HSK32	HSK40	HSK50	HSK63	HSK80	HSK100
WFLC012-0-IK/HSK-C...	0	M2-M8	0	12	28	2	13	I	72	72	-	-	-	-
								Id. No.	6727924	5001509	-	-	-	-
WFLC115-IK/HSK-C...	1	M3-M12	7,5	7,5	39	2,5	19	I	-	-	93	93	96	96
								Id. No.	-	-	6728058	6727999	-	-
WFLC115-0-IK/HSK-C...	1	M3-M12	0	15	39	2,5	19	I	-	-	85,5	85,5	88,5	88,5
								Id. No.	-	-	6728060	6728074	-	-
WFLC 220-IK/HSK-C...	2	M8-M20	10	10	60	4	31	I	-	-	125	125	128	128
								Id. No.	-	-	6728329	6728353	-	-
WFLC220-0-IK/HSK-C...	2	M8-M20	0	20	60	4	31	I	-	-	115	115	118	118
								Id. No.	-	-	6728346	6728352	-	-
WFLC335-IK/HSK-C...	3	M14-M33	17,5	17,5	86	5	48	I	-	-	-	191	194	194
								Id. No.	-	-	-	-	-	-
WFLC335-0-IK/HSK-C...	3	M14-M33	0	35	86	5	48	I	-	-	-	173,5	176,5	176,5
								Id. No.	-	-	-	6728507	-	-

Passende Schnellwechsel-Einsätze siehe Seite 98 – 132
 Suitable quick change adaptors see page 98 – 132

DIN 69893 C



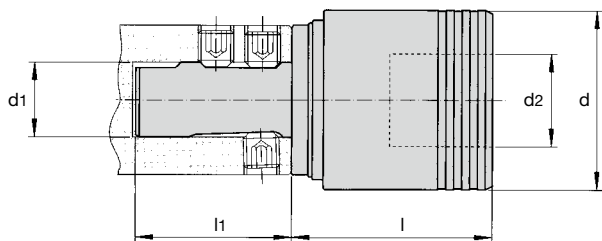

WFLC/MS

Mit Bilz-Modular-Schaft MS ähnlich DIN 1835 zum Kombinieren mit Werkzeugaufnahme Bilz-WA
 With Bilz modular shank MS similar to DIN 1835 to combine with toolholder Bilz-WA

Bezeichnung/Id. Nr. Designation/Id. No.					d	d1	d2	l	l1
WFLC012/MS16 6727907	0	M2-M8	6	6	28	16	13	39,5	40
WFLC012-0/MS16 6727909	0	M2-M8	0	12	28	16	13	39,5	40
WFLC115/MS25 6728583	1	M3-M12	7,5	7,5	39	25	19	45	53
WFLC115-0/MS25 6728584	1	M3-M12	0	12,5	39	25	19	37,5	53
WFLC220/MS25 6728595	2	M8-M20	10	10	60	25	31	68	53
WFLC220-0/MS25 6728597	2	M8-M20	0	16,5	60	25	31	58	53
WFLC335/MS32 6728601	3	M14-M33	17,5	17,5	86	32	48	99	60
WFLC335-0/MS32 6728602	3	M14-M33	0	35	86	32	48	81,5	60
WFLC440/MS40 6728603	4	M22-M48	20	20	107	40	60	122	68
WFLC440-0/MS40 6728604	4	M22-M48	0	40	107	40	60	102	68

Passende Schnellwechsel-Einsätze siehe Seite 98 – 132
 Suitable quick change adaptors see page 98 – 132

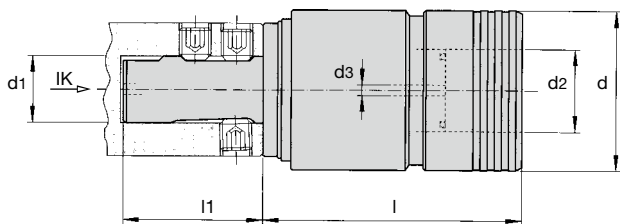

WFLC...K/MS										
Mit Bilz-Modular-Schaft MS... ähnlich DIN 1835 zum Kombinieren mit Werkzeugaufnahme Bilz WA. Mit Kühlmitteldurchführung										
With Bilz modular shank MS... similar to DIN 1835 to combine with toolholder Bilz-WA with coolant feed										
Bezeichnung/Id. Nr. Designation/Id. No.					d	d1	d2	d3	l	l1
WFLC012-K/MS16 6727908	0	M2-M8	6	6	28	16	13	2	54	40
WFLC012-0K/MS16 6727906	0	M2-M8	0	12	28	16	13	2	48	40
WFLC115-K/MS25 6728606	1	M3-M12	7,5	7,5	39	25	19	2,5	62	53
WFLC115-0K/MS25 6728609	1	M3-M12	0	15	39	25	19	2,5	54,5	53
WFLC220-K/MS25 6728611	2	M8-M20	10	10	60	25	31	4	98	53
WFLC220-0K/MS25 6728614	2	M8-M20	0	20	60	25	31	4	88	53
WFLC335-K/MS32 6728620	3	M14-M33	17,5	17,5	86	32	48	5	147	60
WFLC335-0K/MS32 6728621	3	M14-M33	0	35	86	32	48	5	129,5	60
WFLC440-K/MS40 6728625	4	M22-M48	20	20	107	40	60	6	172	68
WFLC440-0K/MS40 6728627	4	M22-M48	0	40	107	40	60	6	152	68

Passende Schnellwechsel-Einsätze siehe Seite 98 – 132
 Suitable quick change adaptors see page 98 – 132



WFLC – Gewindeschneid-Schnellwechselfutter
WFLC – Quick change tapping chucks

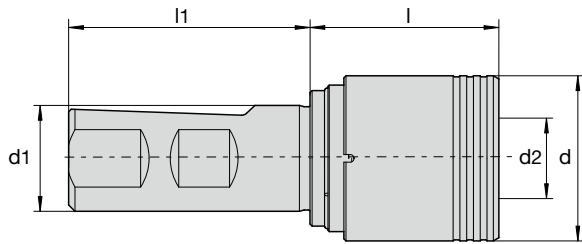

DIN 1835 B+E



WFLC/W

Schaft Weldon, Whistle-Notch nach DIN 1835 B+E für Fräseraufnahmen
 Shank Weldon, Whistle-Notch acc. DIN 1835 B+E for end mill holder

Bezeichnung/Id. Nr. Designation/Id. No.					d	d1	d2	l	l1
WFLC115/W25 9078378	1	M3-M12	7,5	7,5	39	25	19	45	57
WFLC115-0/W25 5075970	1	M3-M12	0	12,5	39	25	19	37,5	57
WFLC220/W25 9078379	2	M8-M20	10	10	60	25	31	68	57
WFLC220-0/W25 5075971	2	M8-M20	0	16,5	60	25	31	58	57
WFLC335/W32 9078380	3	M14-M33	17,5	17,5	86	32	48	99	61
WFLC335-0/W32 5075972	3	M14-M33	0	35	86	32	48	81,5	61

Passende Schnellwechsel-Einsätze siehe Seite 98 – 132
 Suitable quick change adaptors see page 98 – 132

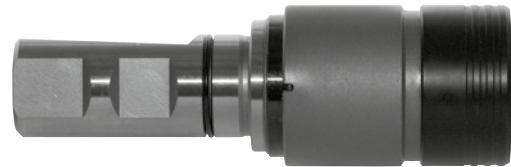
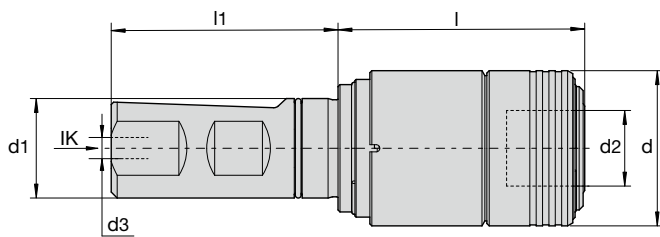

WFLC...K/W										
Schaft Weldon, Whistle-Notch nach DIN 1835 B+E für Fräseraufnahmen										
Shank Weldon, Whistle-Notch acc. DIN 1835 B+E for end mill holder										
Bezeichnung/Id. Nr. Designation/Id. No.					d	d1	d2	d3	l	l1
WFLC115-K/W25 9078428	1	M3-M12	7,5	7,5	39	25	19	2,5	62	57
WFLC115-0K/W25 5075973	1	M3-M12	0	15	39	25	19	2,5	54,5	57
WFLC220-K/W25 9078429	2	M8-M20	10	10	60	25	31	4	98	57
WFLC220-0K/W25 5075974	2	M8-M20	0	20	60	25	31	4	88	57
WFLC335-K/W32 9078431	3	M14-M33	17,5	17,5	86	32	48	5	147	68
WFLC335-0K/W32 5075976	3	M14-M33	0	35	86	32	48	5	129,5	68

Passende Schnellwechsel-Einsätze siehe Seite 98 – 132
 Suitable quick change adaptors see page 98 – 132

DIN 1835 B+E



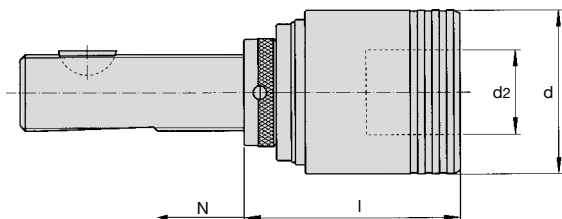

DIN 6327



WFLC/TR												
Bezeichnung Designation					d	d2		TR16	TR20	TR28	TR36	TR48
WFLC012/TR...	0	M2-M8	6	6	28	13	I	45,5	-	-	-	-
							Id. No.	-	-	-	-	-
WFLC012-0/TR...	0	M2-M8	0	12	28	13	I	39,5	-	-	-	-
							Id. No.	6727902	6727922	-	-	-
WFLC115/TR...	1	M3-M12	7,5	7,5	39	19	I	57	57	57	-	-
							Id. No.	6727967	6727966	6727968	-	-
WFLC115-0/TR...	1	M3-M12	0	12,5	39	19	I	49,5	49,5	49,5	-	-
							Id. No.	6728076	6727996	6728041	-	-
WFLC220/TR...	2	M8-M20	10	10	60	31	I	-	80	80	82	-
							Id. No.	-	6728258	6728259	6728260	-
WFLC220-0/TR...	2	M8-M20	0	16,5	60	31	I	-	70	70	72	-
							Id. No.	-	6728303	6728305	6728309	-
WFLC335/TR...	3	M14-M33	17,5	17,5	86	48	I	-	-	111	113	117
							Id. No.	-	-	6728449	6728450	6728451
WFLC335-0/TR...	3	M14-M33	0	35	86	48	I	-	-	93,5	95,5	99,5
							Id. No.	-	-	6728481	6728482	-
WFLC440/TR...	4	M22-M48	20	20	107	60	I	-	-	-	-	140
							Id. No.	-	-	-	-	6728553
WFLC440-0/TR...	4	M22-M48	0	40	107	60	I	-	-	-	116	120
							Id. No.	-	-	-	-	-

Passende Schnellwechsel-Einsätze siehe Seite 98 – 132
Suitable quick change adaptors see page 98 – 132

Längenverstellung Length adjustment	
SM	N
TR16	28
TR20	28
TR28	30
TR36	36
TR48	47

WFLC – Gewindeschneid-Schnellwechselfutter
WFLC – Quick change tapping chucks

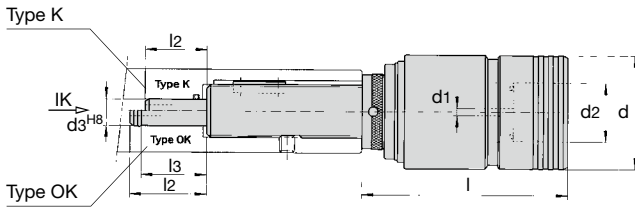

	Type	d3	l2	l3
TR 20x2	K	8	41	-
	OK	12	47	41
TR 28x2	K	12	43	-
	OK	16	51	45
TR 36x2	K	14	50	-
	OK	16	61	54
TR 48x2	K	18	62	-
	OK	18	77	70

Typ IK: Ohne Zapfen. Abdichtung an der Klemmmutter.
 Type IK: Without plug. Seal at clamping nut.

WFLC...-K/TR...														
Bezeichnung Designation					d	d1	d2			TR16	TR20	TR28	TR36	TR48
WFLC012-IK/TR...	0	M2-M8	6	6	28	2	13	I	66	-	-	-	-	-
Id. No.			6727931	-				-	-	-				
WFLC012-0-K/TR...			0	12				I	60	60	-	-	-	
Id. No.			-	6727934				-	-	-				
WFLC012-0-OK/TR...								I	60	-	-	-	-	
Id. No.	6727911	-	-	-	-									
WFLC012-0-IK/TR...								I	60	-	-	-	-	
Id. No.	6727910	-	-	-	-									
WFLC115-K/TR...	1	M3-M12	7,5	7,5	39	2,5	19	I	-	74	74	-	-	
Id. No.								-	6727992	6727980	-	-		
WFLC115-OK/TR...								I	-	-	-	-		
Id. No.	-	6728005	6727979	-	-									
WFLC115-IK/TR...								I	-	-	-	-		
Id. No.	-	6727955	6727943	-	-									
WFLC115-0-K/TR...	1	M3-M12	0	15	39	2,5	19	I	-	66,5	66,5	-	-	
Id. No.								-	6728033	6728040	-	-		
WFLC115-0-OK/TR...								I	-	-	-	-		
Id. No.	-	6727997	6727998	-	-									
WFLC115-0-IK/TR...								I	-	-	-	-		
Id. No.	-	6728013	6727956	-	-									
WFLC220-K/TR...	2	M8-M20	10	10	60	4	31	I	-	-	110	112	-	
Id. No.								-	-	6728273	6728257	-		
WFLC220-OK/TR...								I	-	-	-	-		
Id. No.	-	-	6728288	6728289	-									
WFLC220-IK/TR...								I	-	-	-	-		
Id. No.	-	-	6728224	6728272	-									
WFLC220-0-K/TR...	2	M8-M20	0	20	60	4	31	I	-	-	100	102	-	
Id. No.								-	-	6728304	6728321	-		
WFLC220-0-OK/TR...								I	-	-	-	-		
Id. No.	-	-	6728280	6728322	-									
WFLC220-0-IK/TR...								I	-	-	-	-		
Id. No.	-	-	6728246	6728393	-									
WFLC335-K/TR...	3	M14-M33	17,5	17,5	86	5	48	I	-	-	159	161	165	
Id. No.								-	-	6728484	6728462	6728448		
WFLC335-OK/TR...								I	-	-	-	-		
Id. No.	-	-	6728487	6728489	-									
WFLC335-IK/TR...								I	-	-	-	-		
Id. No.	-	-	6728446	6728442	6728460									
WFLC335-0-K/TR...	3	M14-M33	0	35	86	5	48	I	-	-	141,5	143,5	147,5	
Id. No.								-	-	6728485	6728486	-		
WFLC335-0-OK/TR...								I	-	-	-	-		
Id. No.	-	-	6728488	6728490	-									
WFLC335-0-IK/TR...								I	-	-	-	-		
Id. No.	-	-	6728445	-	-									
WFLC440-IK/TR...	4	M22-M48	20	20	107	6	60	I	-	-	-	186	190	
Id. No.			-	-				-	6728552	6728557				
WFLC440-0-IK/TR...			0	40				I	-	-	-	166	170	
Id. No.	-	-	-	-	-									

Achtung! Beim Typ IK ist der Kühlmitteldruck unterschiedlich, je nach Schaft Ø
 Attention! Typ IK coolant pressure different, acc to shank Ø

Passende Schnellwechsel-Einsätze siehe Seite 98 – 132
 Suitable quick change adaptors see page 98 – 132



WFLC – Gewindeschneid-Schnellwechselfutter
WFLC – Quick change tapping chucks

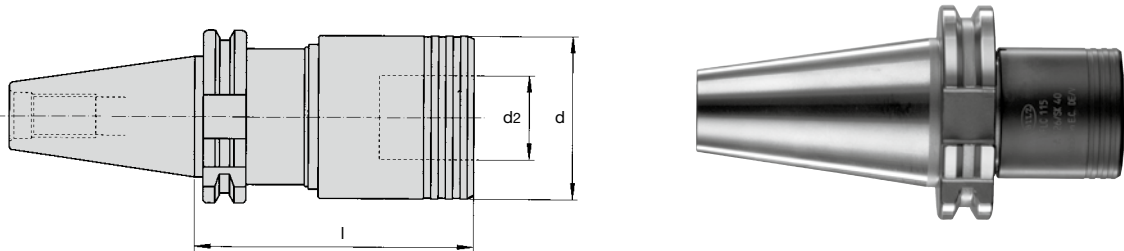

DIN 69871



WFLC/A126/SK... (Alt/Old: DIN 69871)											
Bezeichnung Designation					d	d2	l	SK			
								SK30	SK40	SK45	SK50
WFLC115/A126/SK...	1	M3-M12	7,5	75	39	19	I	65	65	65	65
							Id. No.	6727975	6727958	6727977	9082571
WFLC115-0/A126/SK...	1	M3-M12	0	12,5	39	19	I	57,5	57,5	57,5	57,5
							Id. No.	6728123	6727982	–	–
WFLC220/A126/SK...	2	M8-M20	10	10	60	31	I	103	103	88	88
							Id. No.	6728268	6728248	6728269	6728249
WFLC220-0/A126/SK...	2	M8-M20	0	16,5	60	31	I	93	93	78	78
							Id. No.	6728351	6728298	6728388	6728324
WFLC335/A126/SK...	3	M14-M33	17,5	17,5	86	48	I	–	134	134	134
							Id. No.	–	6728443	6728458	6728444
WFLC335-0/A126/SK...	3	M14-M33	0	35	86	48	I	–	116,5	116,5	116,5
							Id. No.	–	6728483	–	6728480
WFLC440-A126/SK...	4	M22-M48	20	20	107	60	I	–	157	157	157
							Id. No.	–	6728559	6728561	6728578
WFLC440-0/A126/SK...	4	M22-M48	0	40	107	60	I	–	–	137	137
							Id. No.	–	–	–	6728582

Passende Schnellwechsel-Einsätze siehe Seite 98 – 132
 Suitable quick change adaptors see page 98 – 132

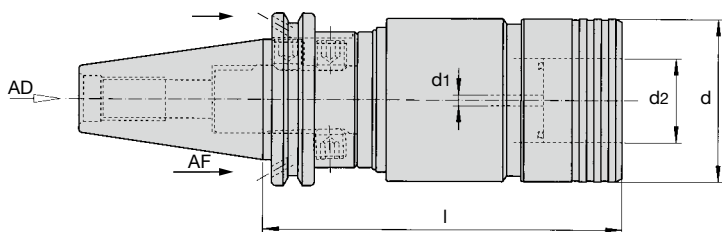

WFLC...M/A126/... (Alt/Old: DIN 69871, ADB)

WFLC...K/MS... zusammengesetzt mit Werkzeugaufnahme WA.../A126 mit Kühlmitteldurchführung B bzw. AD

WFLC...K/MS... combined with toolholder WA.../A126, with coolant feed B or AD

Bezeichnung Designation					d	d1	d2	l			
									AD40/B40	AD45/B45	AD50/B50
WFLC115M/A126/AD...	1	M3-M12	7,5	7,5	39	2,5	19	l	97	97	97
WFLC115M/A126/B...									Id. No. 6727949	–	6727946
WFLC115-0M/A126/AD...	1	M3-M12	0	15	39	2,5	19	l	89,5	89,5	89,5
WFLC115-0M/A126/B...									Id. No. 6728036	–	6728061
WFLC220M/A126/AD...	2	M8-M20	10	10	60	4	31	l	133	133	133
WFLC220M/A126/B...									Id. No. 6728232	6728334	6728231
WFLC220-0M/A126/AD...	2	M8-M20	0	20	60	4	31	l	123	123	123
WFLC220-0M/A126/B...									Id. No. 6728254	–	6728325
WFLC335M/A126/AD...	3	M14-M33	17,5	17,5	86	5	48	l	192	182	182
WFLC335M/A126/B...									Id. No. 6728440	6728508	6728436
WFLC335-0M/A126/AD...	3	M14-M33	0	35	86	5	48	l	174,5	164,5	164,5
WFLC335-0M/A126/B...									Id. No. 6728491	–	6728492
WFLC440-M/A126/AD...	4	M22-M48	20	20	107	6	60	l	287	242	217
WFLC440-M/A126/B...									Id. No. 6728573	–	6728549
WFLC440-0M/A126/AD...	4	M22-M48	0	40	107	6	60	l	267	222	197
WFLC440-0M/A126/B...									Id. No. 6728575	–	6728575

Passende Schnellwechsel-Einsätze siehe Seite 98 – 132
Suitable quick change adaptors see page 98 – 132

DIN 69871



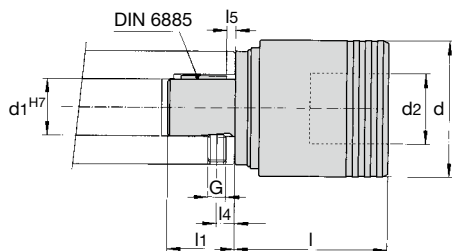

WFLC/A 308

Zylinderschaft mit Passfeder DIN 6885 Bl. 2 u. 3. Kurze Ausführung. Zur Aufnahme in Spindelbohrung nach vorgegebener Zeichnung
 Cylindrical shank with woodruff key DIN 6885 sheet 2 and 3. Short design. Fitting into spindle bore as per drawing

Bezeichnung/Id. Nr. Designation/Id. No.					d	d1	d2	l	l1	l4	l5	G	DIN 6885
WFLC012/A308 -	0	M2-M8	6	6	28	16	13	39,5	18	6	3	M5	A5x3x12
WFLC012-0/A308 -	0	M2-M8	0	12	28	16	13	33,5	18	6	3	M5	A5x3x12
WFLC115/A308 6727976	1	M3-M12	7,5	7,5	39	20	19	45	24	6	3	M6	A6x4x16
WFLC115-0/A308 6728047	1	M3-M12	0	12,5	39	20	19	37,5	24	6	3	M6	A6x4x16
WFLC220/A308 6728270	2	M8-M20	10	10	60	25	31	68	30	8	4	M8	A6x6x20
WFLC220-0/A308 6728320	2	M8-M20	0	16,5	60	25	31	58	30	8	4	M8	A6x6x20
WFLC335/A308 6728459	3	M14-M33	17,5	17,5	86	36	48	99	46	10	5	M10	A10x6x32
WFLC335-0/A308 6728495	3	M14-M33	0	35	86	36	48	81,5	46	10	5	M10	A10x6x32
WFLC440/A308 -	4	M22-M48	20	20	107	48	60	122	60	12	6	M12	A10x6x45
WFLC440-0/A308 6728560	4	M22-M48	0	40	107	48	60	102	60	12	6	M12	A10x6x45

Passende Schnellwechsel-Einsätze siehe Seite 98 – 132
 Suitable quick change adaptors see page 98 – 132

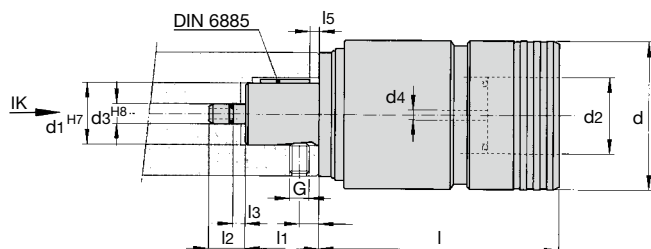

WFLC-IK/A308

Zylinderschaft mit Passfeder DIN 6885 Bl. 2 u. 3. Zur Aufnahme in Spindelbohrung nach vorgegebener Zeichnung.
 Mit Kühlmitteldurchführung

Cylindrical shank with woodruff key DIN 6885 sheet 2 and 3. Fitting into spindle bore as per drawing. With coolant feed

Bezeichnung/Id. Nr. Designation/Id. No.					d	d1	d2	d3	d4	l	l1	l2	l3	l4	l5	G	DIN 6885
WFLC012-IK/A308 6727897	0	M2-M8	6	6	28	16	13	5	2	54	18	12	2,5	6	3	M5	A5x3x12
WFLC012-0-IK/A308 6727920	0	M2-M8	0	12	28	16	13	5	2	48	18	12	2,5	6	3	M5	A5x3x12
WFLC115-IK/A308 6728004	1	M3-M12	7,5	7,5	39	20	19	7	2,5	62	24	11	3	6	3	M6	A6x4x16
WFLC115-0-IK/A308 6728064	1	M3-M12	0	15	39	20	19	7	2,5	54,5	24	11	3	6	3	M6	A6x4x16
WFLC220-IK/A308 6728350	2	M8-M20	10	10	60	25	31	8	4	98	30	15	5	8	4	M8	A6x6x20
WFLC220-0-IK/A308 6728382	2	M8-M20	0	20	60	25	31	8	4	88	30	15	5	8	4	M8	A6x6x20
WFLC335-IK/A308 -	3	M14-M33	17,5	17,5	86	36	48	10	5	147	46	15	3,5	10	5	M10	A10x6x32
WFLC335-0-IK/A308 -	3	M14-M33	0	35	86	36	48	10	5	129,5	46	15	3,5	10	5	M10	A10x6x32

Passende Schnellwechsel-Einsätze siehe Seite 98 – 132
 Suitable quick change adaptors see page 98 – 132



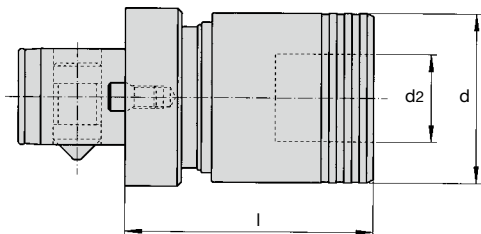

WFLC/A 313.1/... Komet ABS-System														
Bezeichnung Designation					d	d2		.../25	.../32	.../40	.../50	.../63	.../80	.../100
WFLC012/A313.1/...	0	M2-M8	6	6	28	13	I	46	48	-	-	-	-	-
							Id.No.	6727930	6727912	-	-	-	-	-
WFLC012-0/A313.1/...	0	M2-M8	0	12	28	13	I	40	42	-	-	-	-	-
							Id.No.	-	-	-	-	-	-	-
WFLC115/A313.1/...	1	M3-M12	7,5	7,5	39	19	I	-	47	56	55	56	-	-
							Id.No.	-	6727993	6728003	6728007	6728132	-	-
WFLC115-0/A313.1/...	1	M3-M12	0	12,5	39	19	I	-	39,5	48,5	47,5	50	-	-
							Id.No.	-	6728008	6728045	6728046	6728102	-	-
WFLC220/A313.1/...	2	M8-M20	10	10	60	31	I	-	-	-	70	81	-	-
							Id.No.	-	-	6728373	6728276	6728336	-	-
WFLC220-0/A313.1/...	2	M8-M20	0	16,5	60	31	I	-	-	-	60	71	-	-
							Id.No.	-	-	6728377	6728319	6728377	-	-
WFLC335/A 313.1/...	3	M14-M33	17,5	17,5	86	48	I	-	-	-	-	103	117	-
							Id.No.	-	-	-	-	6728464	6728529	-
WFLC335-0/A313.1/...	3	M14-M33	0	35	86	48	I	-	-	-	-	85,5	99,5	-
							Id.No.	-	-	-	-	6728510	6728509	-
WFLC440/A313.1/...	4	M22-M48	20	20	107	60	I	-	-	-	-	132	125	144,5
							Id.No.	-	-	-	-	6728566	6728574	6728579
WFLC440-0/A313.1/...	4	M22-M48	0	40	107	60	I	-	-	-	-	112	105	124,5
							Id.No.	-	-	-	-	-	-	-

Passende Schnellwechsel-Einsätze siehe Seite 98 – 132
 Suitable quick change adaptors see page 98 – 132

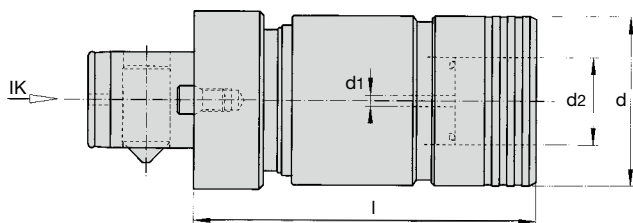

WFLC-IK/A313.1/... Komet ABS-System														
Bezeichnung Designation					d	d1	d2	l	.../32	.../40	.../50	.../63	.../80	.../100
WFLC012-IK/A313.1/...	0	M2-M8	6	6	28	2	13	l	62	64	-	-	-	-
								Id.No.	6727925	6727929	-	-	-	-
WFLC012-0-IK/A313.1/...	0	M2-M8	0	12	28	2	13	l	56	58	-	-	-	-
								Id.No.	6727932	6727915	-	-	-	-
WFLC115-IK/A313.1/...	1	M3-M12	7,5	7,5	39	2,5	19	l	69	73	72	74	-	-
								Id.No.	6727960	6727981	6727984	6727985	-	-
WFLC115-0-IK/A313.1/...	1	M3-M12	0	15	39	2,5	19	l	61,5	65,5	64,5	66,5	78,5	-
								Id.No.	6728048	6728017	6728049	6728016	6728201	-
WFLC 220-IK/A313.1/...	2	M8-M20	10	10	60	4	31	l	-	111	98	111	-	-
								Id.No.	-	6728299	6728230	6728277	-	-
WFLC220-0-IK/A313.1/...	2	M8-M20	0	20	60	4	31	l	-	101	88	101	-	-
								Id.No.	-	-	6728301	6728251	-	-
WFLC335-IK/A313.1/...	3	M14-M33	17,5	17,5	86	5	48	l	-	-	-	160	165	-
								Id.No.	-	-	-	6728466	6728519	-
WFLC335-0-IK/A313.1/...	3	M14-M33	0	35	86	5	48	l	-	-	-	142,5	147,5	-
								Id.No.	-	-	-	-	-	-
WFLC440-IK/A313.1/...	4	M22-M48	20	20	107	6	60	l	-	-	-	-	186	195
								Id.No.	-	-	-	-	6728558	9156282
WFLC440-0-IK/A313.1/...	4	M22-M48	0	40	107	6	60	l	-	-	-	-	166	175
								Id.No.	-	-	-	-	5069417	-

Passende Schnellwechsel-Einsätze siehe Seite 98 – 132
Suitable quick change adaptors see page 98 – 132



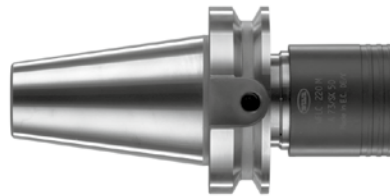
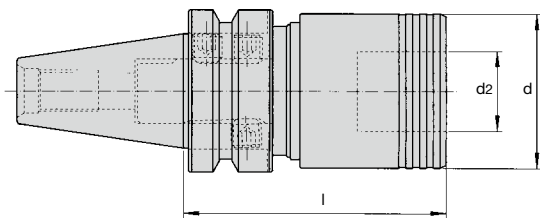

DIN
69871



WFLC...M/A73/SK... (Alt/Old: MAS403, BT)

WFLC.../MS... zusammgebaut mit Werkzeugaufnahme WA.../A73/SK... nach MAS 403

WFLC.../MS... combined with toolholder WA.../A73/SK... to MAS 403

Bezeichnung Designation					d	d2	l	SK30	SK40	SK45	SK50
WFLC012M/A73/SK...	0	M2-M8	6	6	28	13	I	74,5	-	-	-
							Id. No.	-	-	-	-
WFLC012-0M/A73/SK...	0	M2-M8	0	12	28	13	I	68,5	-	-	-
							Id. No.	-	-	-	-
WFLC115M/A73/SK...	1	M3-M12	7,5	7,5	39	19	I	80	80	80	80
							Id. No.	-	6728014	-	6727959
WFLC115-0M/A73/SK...	1	M3-M12	0	12,5	39	19	I	72,5	72,5	72,5	72,5
							Id. No.	-	6728210	-	6728116
WFLC220M/A73/SK...	2	M8-M20	10	10	60	31	I	103	103	103	103
							Id. No.	-	6728340	-	6728250
WFLC220-0M/A73/SK...	2	M8-M20	0	16,5	60	31	I	86,5	93	93	93
							Id. No.	-	6728312	5005034	6728291
WFLC335M/A73/SK...	3	M14-M33	17,5	17,5	86	48	I	-	144	134	134
							Id. No.	-	6728497	-	6728498
WFLC335-0M/A73/SK...	3	M14-M33	0	35	86	48	I	-	126,5	116,5	116,5
							Id. No.	-	-	-	-
WFLC440M/A73/SK...	4	M22-M48	20	20	107	60	I	-	-	-	167
							Id. No.	-	-	-	6728564
WFLC440-0M/A73/SK...	4	M22-M48	0	40	107	60	I	-	-	-	147
							Id. No.	-	-	-	-

Passende Schnellwechsel-Einsätze siehe Seite 98 – 132
 Suitable quick change adaptors see page 98 – 132

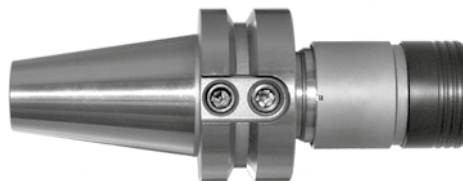
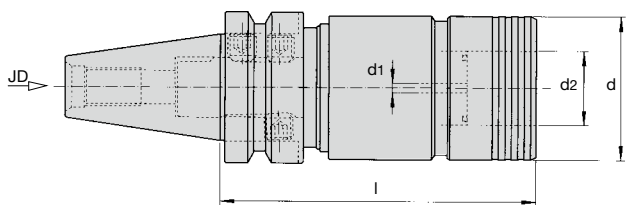

WFLC...M-IK/A73/SK... (Alt/Old: MAS403, BT) WFLC... K/MS... zusammengebaut mit Werkzeugaufnahme WA.../A73/SK... nach MAS 403, mit Kühlmitteldurchführung WFLC... K/MS... combined with toolholder WA.../A73/SK... to MAS 403, with coolant feed													
Bezeichnung Designation					d	d1	d2		SK30	SK40	SK45	SK50	
WFLC012M-IK/A73/SK...	0	M2-M8	6	6	28	2	13	I	89	–	–	–	
								Id. No.	–	–	–	–	
WFLC012-0M-IK/A73/SK...	0	M2-M8	0	12	28	2	13	I	83	–	–	–	
								Id. No.	–	–	–	–	
WFLC115M-IK/A73/SK...	1	M3-M12	7,5	7,5	39	2,5	19	I	97	97	97	97	
								Id. No.	5082079	6728218	–	9158588	
WFLC115-0M-IK/A73/SK...	1	M3-M12	0	15	39	2,5	19	I	89,5	89,5	89,5	89,5	
								Id. No.	–	–	–	–	
WFLC220M-IK/A73/SK...	2	M8-M20	10	10	60	4	31	I	133	133	133	133	
								Id. No.	–	6728429	–	6728430	
WFLC220-0M-IK/A73/SK...	2	M8-M20	0	20	60	4	31	I	123	123	123	123	
								Id. No.	–	6728411	–	–	
WFLC335M-IK/A73/SK...	3	M14-M33	17,5	17,5	86	5	48	I	–	–	182	182	
								Id. No.	–	–	–	9158600	
WFLC335-0M-IK/A73/SK...	3	M14-M33	0	35	86	5	48	I	–	–	164,5	164,5	
								Id. No.	–	–	–	5045923	
WFLC440M-IK/A73/SK...	4	M22-M48	20	20	107	6	60	I	–	–	–	217	
								Id. No.	–	–	–	6728572	
WFLC440-0M-IK/A73/SK...	4	M22-M48	0	40	107	6	60	I	–	–	–	197	
								Id. No.	–	–	–	–	

Passende Schnellwechsel-Einsätze siehe Seite 98 – 132
 Suitable quick change adaptors see page 98 – 132

DIN 69871



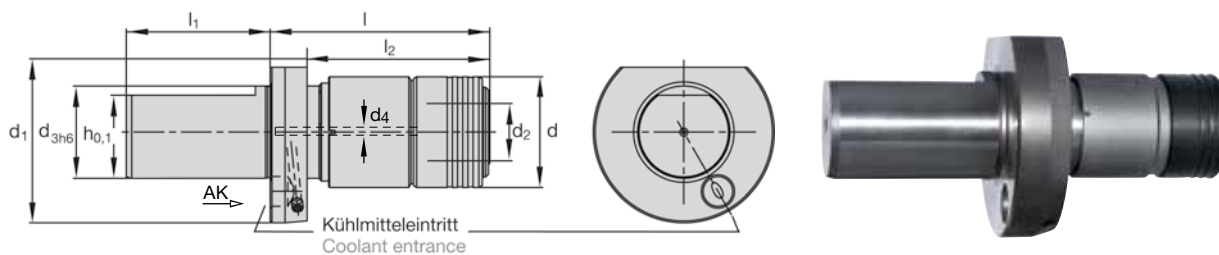

DIN
69880



WFLC...-AK/A65/...

ohne Verzahnung, ähnlich DIN 69880
 without tooth system, similar DIN 69880

Bezeichnung/Id. Nr. Designation/Id. No.					d	d1	d2	d3 h6	d	h	l ± 0,05	l1	l2
WFLC115-AK/A65/20 6728215	1	M3-M12	7,5	7,5	39	50	19	20	2,5	18	85	40	65,5
WFLC115-AK/A65/30 6728194						68		30		27	82	55	62,5
WFLC115-AK/A65/40 6727995						83		40		36	82	63	62,5
WFLC115-AK/A65/50 6728066						98		50		45	82	78	62,5
WFLC220-AK/A65/30 6728395	2	M8-M20	10	10	60	68	31	30	4	27	119	55	98,5
WFLC220-AK/A65/40 6728391						83		40		36	119	63	98,5
WFLC220-AK/A65/50 6728421						98		50		45	119	78	98,5
WFLC220-AK/A65/60 -						123		60		55	119	94	98,5
WFLC335-AK/A65/40 6728543	3	M14-M33	17,5	17,5	86	83	48	40	5	36	181	63	-
WFLC335-AK/A65/50 9107934						98		50		45	172	78	148
WFLC335-AK/A65/60 -						123		60		55	172	94	148

Hinweis: Mit Verzahnung A65.2 bestellen
 Hint: Please order with serration A65.2

Passende Schnellwechsel-Einsätze siehe Seite 98 – 132
 Suitable quick change adaptors see page 98 – 132

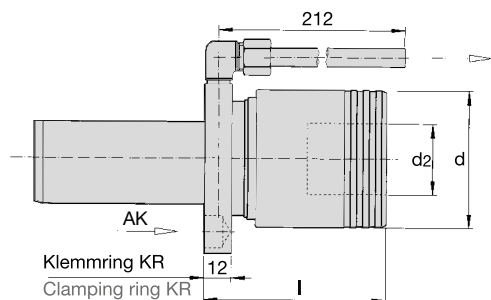

WFLC/A82/... ohne Verzahnung, ähnlich DIN 69880 without tooth system, similar DIN 69880													
Bezeichnung Designation					d	d2		Ø20	Ø25	Ø30	Ø40	Ø50	Ø60
WFLC115/A82/	1	M3-M12	7,5	7,5	39	19	I	57	57	61	61	61	–
							Id. No.	6728051	6728055	6728023	6728002	6728144	–
WFLC115-0/A82/	1	M3-M12	0	12,5	39	19	I	49,5	49,5	53,5	53,5	53,5	–
							Id. No.	6728052	–	6728053	6728054	9070935	–
WFLC220/A82/	2	M8-M20	10	10	60	31	I	–	80	80	80	80	–
							Id. No.	–	6728390	6728271	6728278	6728297	–
WFLC220-0/A82/	2	M8-M20	0	16,5	60	31	I	–	70	70	70	70	–
							Id. No.	–	–	6728327	6728328	6728392	–
WFLC335/A82/	3	M14-M33	17,5	17,5	86	48	I	–	–	–	111	111	111
							Id. No.	–	–	–	6728476	9082987	6728544
WFLC335-0/A82/	3	M14-M33	0	35	86	48	I	–	–	–	93,5	93,5	93,5
							Id. No.	–	–	–	6728537	–	6728540
Klemmring Clamping ring								KR20	KR25	KR30	KR40	KR50	KR60
							Id. No.	6804000	6804007	6804001	6804002	6804003	6804004

Hinweis: Mit Verzahnung A82.2 bestellen
 Hint: Please order with serration A82.2

Passende Schnellwechsel-Einsätze siehe Seite 98 – 132
 Suitable quick change adaptors see page 98 – 132

DIN 69880



50 bar



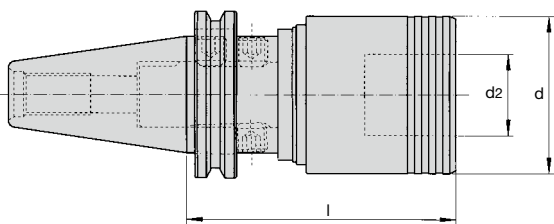

DIN 69871

WFLC...M/A86/SK... (Alt/Old: ANSI B5.50, CAT)

WFLC.../MS... zusammgebaut mit Werkzeugaufnahme WA.../A 86/SK... nach ISO 7388-1
 WFLC.../MS... combined with tool holder WA.../A86/SK... to ISO 7388-1

Bezeichnung Designation	Icon 1	Icon 2	Icon 3	Icon 4	d	d2	l	SK40	SK45	SK50
								Id. No.	Id. No.	Id. No.
WFLC115M/A86/SK...	1	M3-M12	7,5	7,5	39	19	80	80	80	6728091
WFLC115-0M/A86/SK...	1	M3-M12	0	12,5	39	19	72,5	72,5	72,5	–
WFLC220M/A86/SK...	2	M8-M20	10	10	60	31	103	103	103	6728394
WFLC220-0M/A86/SK...	2	M8-M20	0	16,5	60	31	93	93	93	–
WFLC335M/A86/SK...	3	M14-M33	17,5	17,5	86	48	–	134	134	–
WFLC335-0M/A86/SK...	3	M14-M33	0	35	86	48	–	116,5	116,5	–

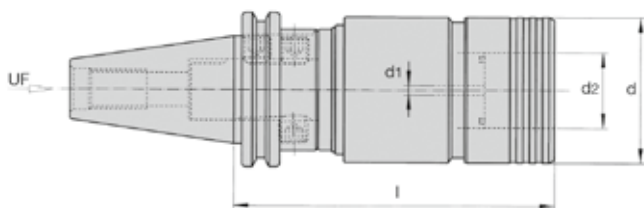

DIN 69871

WFLC...M-IK/A86/SK... (Alt/Old: ANSI B5.50, CAT)

WFLC...K/MS... zusammgebaut mit Werkzeugaufnahme WA.../A86/SK... nach ISO 7388-1, mit Kühlmitteldurchführung
 WFLC...K/MS... combined with toolholder WA.../A86/SK... to ISO 7388-1, with coolant feed

Bezeichnung Designation	Icon 1	Icon 2	Icon 3	Icon 4	d	d1	d2	l	SK40	SK45	SK50
									Id. No.	Id. No.	Id. No.
WFLC115M-IK/A86/SK...	1	M3-M12	7,5	7,5	39	2,5	19	97	97	97	6728206
WFLC115-0M-IK/A86/SK...	1	M3-M12	0	15	39	2,5	19	89,5	89,5	89,5	6728130
WFLC220M-IK/A86/SK...	2	M8-M20	10	10	60	4	31	133	133	133	–
WFLC220-0M-IK/A86/SK...	2	M8-M20	0	20	60	4	31	123	123	123	6728243
WFLC335M-IK/A86/SK...	3	M14-M33	17,5	17,5	86	5	48	–	182	182	–
WFLC335-0M-IK/A86/SK...	3	M14-M33	0	35	86	5	48	–	164,5	164,5	6728468



Hinweis: Größe 0 + 4 auf Anfrage
 Hint: Size 0 + 4 on request

Passende Schnellwechsel-Einsätze siehe Seite 98 – 132
 Suitable quick change adaptors see page 98 – 132

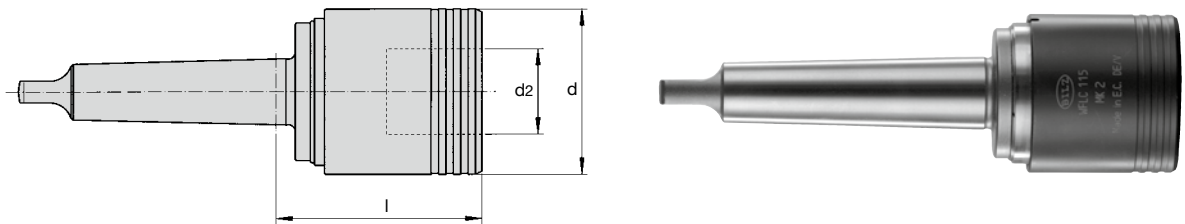

WFLC/MK											
Bezeichnung Designation					d	d2	l	MK2	MK3	MK4	MK5
								Id. No.	Id. No.	Id. No.	Id. No.
WFLC115/MK...	1	M3-M12	7,5	7,5	39	19	l	52	52	-	-
							Id. No.	6727971	6727972	-	-
WFLC115-0/MK...	1	M3-M12	0	12,5	39	19	l	44,5	44,5	-	-
							Id. No.	6728042	6728043	-	-
WFLC220/MK...	2	M8-M20	10	10	60	31	l	75	75	76	-
							Id. No.	6728417	6728264	6728265	-
WFLC220-0/MK...	2	M8-M20	0	16,5	60	31	l	65	65	66	-
							Id. No.	6728424	6728323	6728360	-
WFLC335/MK...	3	M14-M33	17,5	17,5	86	48	l	-	-	107	107,5
							Id. No.	-	-	6728454	6728455
WFLC335-0/MK...	3	M14-M33	0	35	86	48	l	-	-	89,5	90
							Id. No.	-	-	6728523	-
WFLC440/MK...	4	M22-M48	20	20	107	60	l	-	-	130	127,5
							Id. No.	-	-	5050890	6728569
WFLC440-0/MK...	4	M22-M48	0	40	107	60	l	-	-	110	107,5
							Id. No.	-	-	-	-

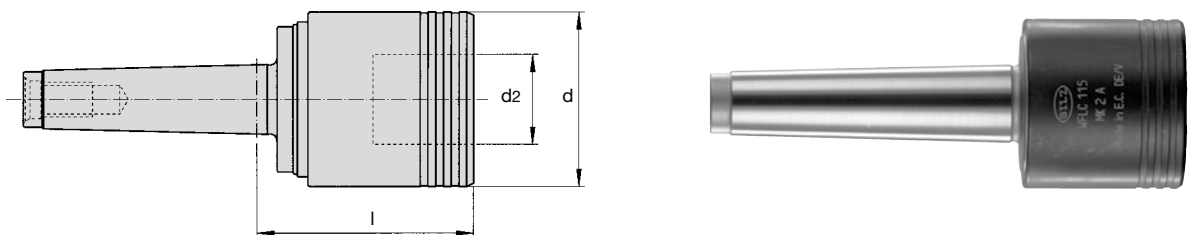

WFLC/MK...A											
Bezeichnung Designation					d	d2	l	MK2	MK3	MK4	MK5
								Id. No.	Id. No.	Id. No.	Id. No.
WFLC115/MK...A	1	M3-M12	7,5	7,5	39	19	l	52	52	-	-
							Id. No.	6727973	6727974	-	-
WFLC115-0/MK...A	1	M3-M12	0	12,5	39	19	l	44,5	44,5	-	-
							Id. No.	6728098	6728099	-	-
WFLC220/MK...A	2	M8-M20	10	10	60	31	l	75	75	76	-
							Id. No.	-	6728266	6728267	-
WFLC220-0/MK...A	2	M8-M20	0	16,5	60	31	l	65	65	66	-
							Id. No.	-	6728412	6728413	-
WFLC335/MK...A	3	M14-M33	17,5	17,5	86	48	l	-	-	107	107,5
							Id. No.	-	-	6728456	6728457
WFLC335-0/MK...A	3	M14-M33	0	35	86	48	l	-	-	89,5	90
							Id. No.	-	-	6728545	-

Passende Schnellwechsel-Einsätze siehe Seite 98 – 132
Suitable quick change adaptors see page 98 – 132

Anwendung: Gewindeschneiden, -formen

Maschinentyp: Bearbeitungszentren, Transferstraßen, Sondermaschinen, Bohr-, Fräsmaschinen

Application: tapping, roll forming

Machine type: machining centres, transfer lines, special purpose, drilling and milling machines

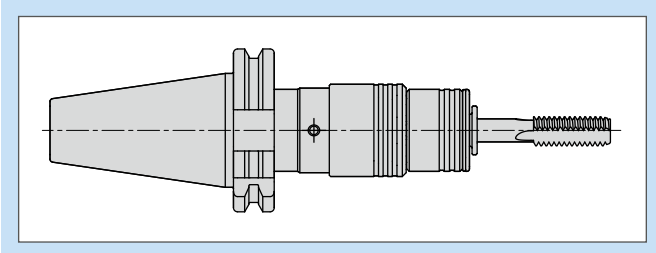

Gewindeschneiden und -formen

Bilz-Gewindeschneid-Schnellwechselfutter Typ WFLK werden vorwiegend auf mechanisch oder NC-gesteuerten Maschinen eingesetzt. Sie erfüllen alle Voraussetzungen zum rationellen Schneiden toleranzhaltiger Gewinde.

Die Schnellwechseinrichtung zur Aufnahme der verschiedenen Einsätze wird über den Längenausgleich betätigt. Beim Wechseln der Einsätze wird dieser ganz zusammengedrückt. Bei den Futtern ab Größe 3 kann zusätzlich auch durch betätigen des Zugausgleiches entkuppelt werden.

Bei der Baureihe mit vergrößertem Längenausgleich können die Einsätze nur durch betätigen des Zugausgleichs gewechselt werden.

Der im Futter eingebaute Längenausgleich auf Druck und Zug gleicht Differenzen zwischen Gewindebohrersteigung und Maschinenvorschub aus und verhindert das Verschneiden der Gewindeflanken.

Der Längenausgleich ist in einer Kugelführungsbuchse gelagert und deshalb auch bei hohen Drehmomenten besonders leichtgängig. Er ist in Nulllage positioniert und für den Druckbereich mit einer starken Feder versehen.

Bilz WFLK-Futter sind horizontal und vertikal sowie für Rechts- und Linksgewinde verwendbar.

Tapping and cold-forming

Bilz quick change tapping chucks type WFLK are mainly used on mechanically and numerically controlled machines. They fulfill all the requirements for tapping tolerance compliant threads whilst operating rationally.

The quick change feature is suitable for various adaptors and is activated by means of the length compensation. When changing the adaptors, the length compensation is completely compressed. When using chuck size 3, and bigger uncoupling can also be carried out by pulling out the extension compensation.

The integrated length compensation on extension and compression compensates for differences between tap pitch and machine feed and prevents cuts on the thread flanks.

The length compensation is situated in a ball cage sleeve and is therefore particularly easy-running, even when high torques are applied.

It is positioned in the zero position and is equipped with a strong pressure spring for the extension area.

Bilz WFLK chucks can be applied horizontally or vertically and can be used for right or left-handed threads.

Merkmale:	Vorteile:	Nutzen:
<ul style="list-style-type: none"> ▪ Anschnittdruckverstärker, höhere Axialkraft, einstellbar 	<ul style="list-style-type: none"> ▪ Vermeidet Einfedern im Druckbereich beim Anschneiden 	<ul style="list-style-type: none"> ▪ Reduzierung der Fehlerquote
<ul style="list-style-type: none"> ▪ besser abgedichtet 	<ul style="list-style-type: none"> ▪ weniger verschmutzungsanfällig 	<ul style="list-style-type: none"> ▪ längere Wartungsintervalle
<ul style="list-style-type: none"> ▪ modulares Schaftsystem MS, W 	<ul style="list-style-type: none"> ▪ höhere Flexibilität 	<ul style="list-style-type: none"> ▪ geringerer Werkzeugbestand
<ul style="list-style-type: none"> ▪ horizontal, vertikal einsetzbar 	<ul style="list-style-type: none"> ▪ höhere Flexibilität 	<ul style="list-style-type: none"> ▪ geringerer Werkzeugbestand
<ul style="list-style-type: none"> ▪ geeignet für Links- und Rechtsgewinde 	<ul style="list-style-type: none"> ▪ höhere Flexibilität 	<ul style="list-style-type: none"> ▪ geringerer Werkzeugbestand
Features:	Advantages:	Benefits:
<ul style="list-style-type: none"> ▪ hard start with higher axial force, adjustable 	<ul style="list-style-type: none"> ▪ to avoid the chuck getting into compression during the start of the tap 	<ul style="list-style-type: none"> ▪ reduction of error rate
<ul style="list-style-type: none"> ▪ better sealing 	<ul style="list-style-type: none"> ▪ no malfunction due to contamination 	<ul style="list-style-type: none"> ▪ longer maintenance sequences
<ul style="list-style-type: none"> ▪ modular shank system MS, W 	<ul style="list-style-type: none"> ▪ higher flexibility 	<ul style="list-style-type: none"> ▪ reduced number of tools required
<ul style="list-style-type: none"> ▪ horizontally, vertically applicable 	<ul style="list-style-type: none"> ▪ higher flexibility 	<ul style="list-style-type: none"> ▪ reduced number of tools required
<ul style="list-style-type: none"> ▪ applicable for left and right handed threads 	<ul style="list-style-type: none"> ▪ higher flexibility 	<ul style="list-style-type: none"> ▪ reduced number of tools required

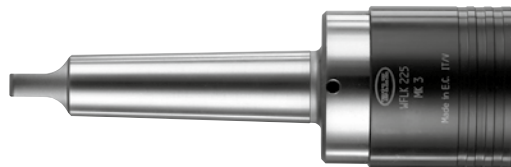
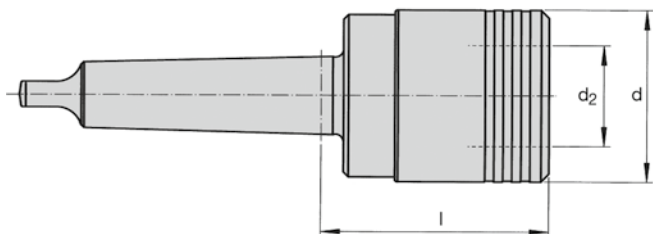

DIN 228 B



WFLK/MK												
Bezeichnung Designation					d	d2		MK2	MK3	MK4	MK5	MK6
WFLK013/MK...	0	M1-M10	6,5	6,5	26	13	I	45	-	-	-	-
							Id. No.	6709984	-	-	-	-
WFLK013B/MK... ①							I	45	-	-	-	-
							Id. No.	6710070	-	-	-	-
WFLK115/MK...	1	M3-M12	7,5	7,5	36	19	I	47	47	47	-	-
							Id. No.	6709998	6710000	6710002	-	-
WFLK115B/MK... ①							I	47	47	47	-	-
							Id. No.	6710082	6710084	-	-	-
WFLK225/MK...	2	M8-M20	12,5	12,5	53	31	I	-	71	72	-	-
							Id. No.	-	6710018	6710020	-	-
WFLK225B/MK... ①							I	-	71	72	-	-
							Id. No.	-	6710097	6710099	-	-
WFLK340/MK...	3	M14-M33	20,0	20,0	78	48	I	-	-	105	105,5	-
							Id. No.	-	-	6710036	6710038	-
WFLK340B/MK... ①							I	-	-	105	105,5	-
							Id. No.	-	-	6710111	6710113	-
WFLK445/MK...	4	M22-M48	22,5	22,5	96	60	I	-	-	-	116,5	118,5
							Id. No.	-	-	-	6710051	6710053
WFLK445B/MK... ①							I	-	-	-	116,5	118,5
							Id. No.	-	-	-	6710123	6710124

① = WFLK...B ohne Kugelführungsbuchse
 ① = WFLK...B without ball cage sleeve

Passende Schnellwechsel-Einsätze siehe Seite 98 – 132
 Suitable quick change adaptors see page 98 – 132

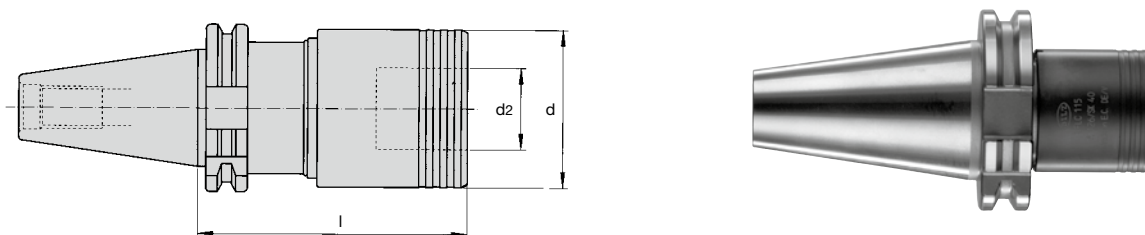

WFLK/A126/SK... (Alt/Old: DIN 69871)												
Bezeichnung Designation					d	d2		SK30	SK40	SK45	SK50	
WFLK115/A126/SK...	1	M3-M12	7,5	75	36	19	l	64	60	60	60	
							Id. No.	6709173	6709128	6709137	6709351	
WFLK115B/A126/SK... ①	1	M3-M12	7,5	75	36	19	l	64	60	60	60	
							Id. No.	6709251	6709168	6709196	9079390	
WFLK225/A126/SK...	2	M8-M20	12,5	12,5	53	31	l	99	98	84	84	
							Id. No.	6709485	6709435	6709438	6709436	
WFLK225B/A126/SK... ①	2	M8-M20	12,5	12,5	53	31	l	99	98	84	84	
							Id. No.	6709571	6709474	6709504	6709487	
WFLK340/A126/SK...	3	M14-M33	20,5	20,5	78	48	l	-	150	146	139	
							Id. No.	-	6709698	6709700	6709699	
WFLK340B/A126/SK... ①	3	M14-M33	20,5	20,5	78	48	l	-	150	146	139	
							Id. No.	-	6709733	6709734	6709735	
WFLK445/A126/SK...	4	M22-M48	22,5	22,5	96	60	l	-	165	160	152	
							Id. No.	-	6709838	6709837	6709836	
WFLK445B/A126/SK... ①	4	M22-M48	22,5	22,5	96	60	l	-	165	160	152	
							Id. No.	-	6709862	6709863	6709856	

① = WFLK...B ohne Kugelführungsbuchse
① = WFLK...B without ball cage sleeve

Passende Schnellwechsel-Einsätze siehe Seite 98 – 132
Suitable quick change adaptors see page 98 – 132

DIN 69871



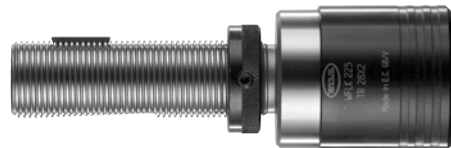
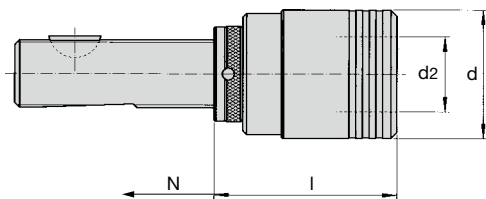

DIN 6327



WFLK/TR													
Bezeichnung Designation	0	M1-M10	6,5	6,5	d	d2	I	TR16	TR20	TR28	TR36	TR48	
								Id. No.	Id. No.	Id. No.	Id. No.	Id. No.	
WFLK013/TR...	0	M1-M10	6,5	6,5	26	13	I	50	50	-	-	-	
Id. No.							6709982	6709983	-	-	-		
WFLK013B/TR... ①	1	M3-M12	7,5	7,5	36	19	I	50	50	-	-	-	
Id. No.							6710068	6710069	-	-	-		
WFLK115/TR...	1	M3-M12	7,5	7,5	36	19	I	52	52	52	54	-	
Id. No.							6709993	6709994	6709995	6709996	-		
WFLK115B/TR... ①	2	M8-M20	12,5	12,5	53	31	I	52	52	52	54	-	
Id. No.							6710078	6710079	6710080	6710081	-		
WFLK225/TR...	2	M8-M20	12,5	12,5	53	31	I	-	76	76	78	-	
Id. No.							-	6710014	6710015	6710017	-		
WFLK225B/TR... ①	3	M14-M33	20,0	20,0	78	48	I	-	76	76	78	-	
Id. No.							-	6710094	6710095	6710096	-		
WFLK340/TR...	3	M14-M33	20,0	20,0	78	48	I	-	-	109	111	115	
Id. No.							-	-	6710031	6710033	6710035		
WFLK340B/TR... ①	4	M22-M48	22,5	22,5	96	60	I	-	-	109	111	115	
Id. No.							-	-	6710108	6710109	6710110		
WFLK445/TR...	4	M22-M48	22,5	22,5	96	60	I	-	-	-	122	126	
Id. No.							-	-	-	6710048	6710050		
WFLK445B/TR... ①	4	M22-M48	22,5	22,5	96	60	I	-	-	-	122	126	
Id. No.							-	-	-	6710121	6710122		

① = WFLK...B ohne Kugelführungsbuchse
② = WFLK...B without ball cage sleeve

Passende Schnellwechsel-Einsätze siehe Seite 98 – 132
Suitable quick change adaptors see page 98 – 132

Längenverstellung Length adjustment	
SM	N
TR16	28
TR20	28
TR28	30
TR36	36
TR48	47

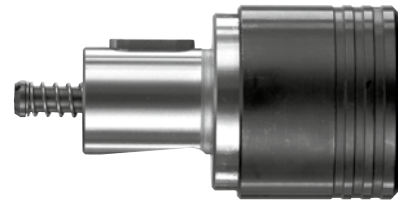
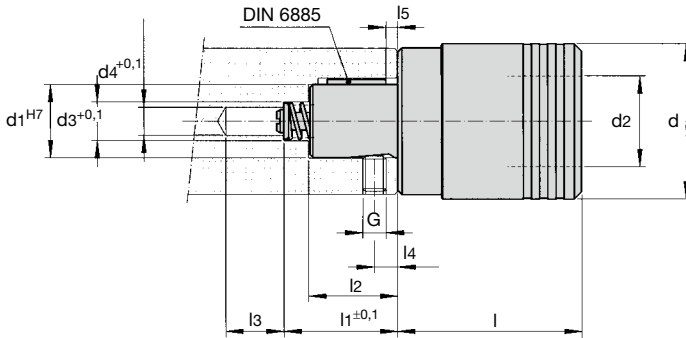

WFLK/A308

Zylinderschaft mit Passfeder DIN 6885 Bl. 2 und 3. Zur Aufnahme in Spindelbohrung nach nebenstehender Zeichnung
 Cylindrical shank with driving key DIN 6885 sheet 2 and 3. Fitting into spindle bore as per drawing

Bezeichnung/Id. Nr. Designation/Id. No.					d	d1	d2	d3	d4	l	l1	l2	l3	l4	l5	G	DIN 6885
WFLK013/A308 6708995	0	M1-M10	6,5	6,5	26	15	13	8,2	6	37	32	18,5	11	6	3	M 5	A5x3x12
WFLK013B/A308 ① 6709026																	
WFLK115/A308 6709159	1	M3-M12	7,5	7,5	36	20	19	11,2	9	39	33	24,5	11	6	3	M 6	A6x4x16
WFLK115B/A308 ① 6709241																	
WFLK225/A308 6709479	2	M8-M20	12,5	12,5	53	25	31	13,2	9,5	63	39	30,5	20	8	4	M 8	A6x6x20
WFLK225B/A308 ① 6709547																	
WFLK340/A308 6709743	3	M14-M33	20,5	20,5	78	36	48	19,3	14	97	64,5	46,5	23	10	5	M10	A10x6x32
WFLK340B/A308 ① -																	

① = WFLK...B ohne Kugelführungsbuchse
 ① = WFLK...B without ball cage sleeve

Passende Schnellwechsel-Einsätze siehe Seite 98 – 132
 Suitable quick change adaptors see page 98 – 132



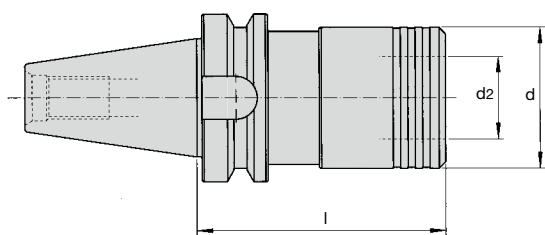

DIN
69871



WFLK/A73/SK... (Alt/Old: MAS403, BT)											
Bezeichnung Designation					d	d2	l	SK30	SK40	SK45	SK50
WFLK013/A73/SK...	0							59	-	-	-
							Id. No.	6709049	-	-	-
WFLK115/A73/SK...	1	M3-M12	7,5	7,5	36	19	l	61,5	67,5	73,5	-
							Id. No.	-	6709115	6709132	-
WFLK115B/A73/SK...							l	61,5	67,5	-	-
							Id. No.	6709317	6709154	-	-
WFLK225/A73/SK...	2	M8-M20	12,5	12,5	53	31	l	95	94,5	97,5	102,5
							Id.No.	6709568	6709418	6709441	6709423
WFLK225B/A73/SK...							l	95	94,5	-	102,5
							Id.No.	6709610	6709460	6709461	6709462
WFLK340/A73/SK...	3	M14-M33	20,0	20,0	78	48	l	-	164	154,5	142,5
							Id.No.	-	6709688	6709721	6709683
WFLK340B/A73/SK...							l	-	164	-	142,5
							Id.No.	-	6709710	-	6709711
WFLK445/A73/SK...	4	M22-M48	22,5	22,5	96	60	l	-	167	-	165,5
							Id.No.	-	6709846	-	6709830
WFLK445B/A73/SK...							l	-	167	172,5	165,5
							Id.No.	-	6709904	6709891	6709842

① = WFLK...B ohne Kugelführungsbuchse
 ② = WFLK...B without ball cage sleeve

Passende Schnellwechsel-Einsätze siehe Seite 98 – 132
 Suitable quick change adaptors see page 98 – 132

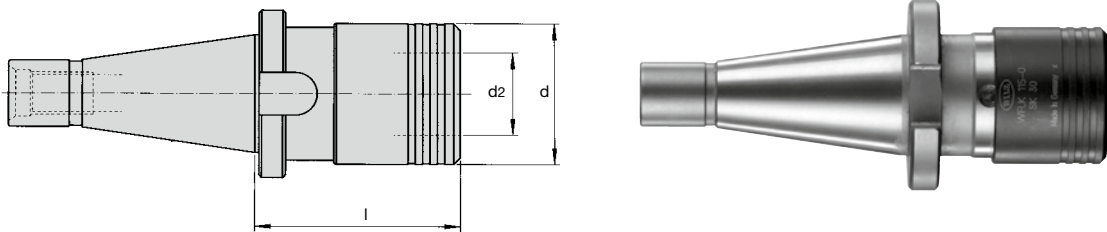

WFLK/SK...											
Bezeichnung Designation					d	d2	l	SK30	SK40*	SK50	SK60
WFLK115/SK...	1	M3-M12	7,5	7,5	36	19	l	59	50	-	-
Id. No.							6710003	6710004	-	-	
WFLK115B/SK... ①							l	59	50	-	-
Id.No.								6710086	6710087	-	-
WFLK225/SK...	2	M8-M20	12,5	12,5	53	31	l	97	78	80	-
Id.No.							6710023	6710024	6710025	-	
WFLK225B/SK... ①							l	97	78	80	-
Id. No.								6710100	6710101	6710102	-
WFLK340/SK...	3	M14-M33	20	20	78	48	l	-	143	130	-
Id. No.							-	6710041	6710042	-	
WFLK340B/SK... ①							l	-	143	130	-
Id. No.								-	6710115	6710116	-
WFLK445/SK...	4	M22-M48	22,5	22,5	96	60	l	-	157	144	127
Id. No.							-	6710055	6710056	6709875	
WFLK445B/SK... ①							l	-	157	144	127
Id. No.								-	6710125	6710126	-

① = WFLK...B ohne Kugelführungsbuchse
① = WFLK...B without ball cage sleeve

* SK40 mit Ott-Spannrille
* SK40 with Ott clamping groove

Passende Schnellwechsel-Einsätze siehe Seite 98 – 132
Suitable quick change adaptors see page 98 – 132



Anwendung: Gewindeschneiden, -formen

Maschinentyp: Bearbeitungszentren, Sondermaschinen

Application: tapping, roll forming

Machine type: machining centres and special purpose machines

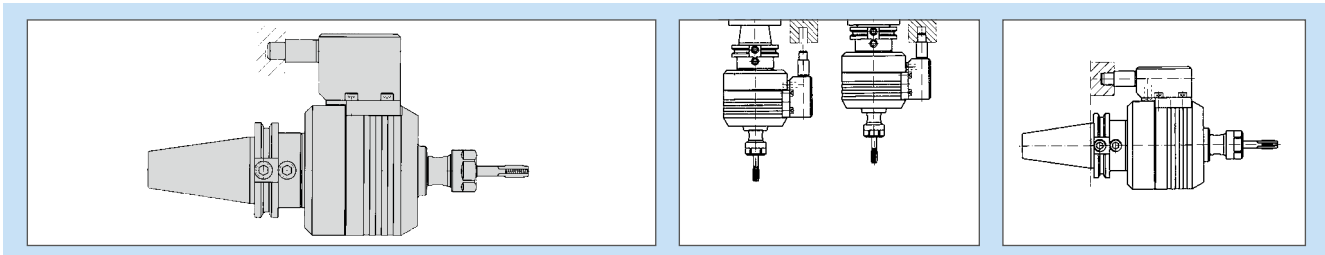

Hochleistungs-Gewindeschneidapparat mit integriertem Wendegetriebe

BILZ-Gewindeschneidapparate sind modular aufgebaut und können dadurch maschinenspezifisch angepasst werden. Sie sind auf Bearbeitungszentren mit automatischem Werkzeugwechsel sowie auf Sondermaschinen einsetzbar.

Durch das integrierte, wartungsfreie Wendegetriebe im GNCN und GNCK entfällt die Drehrichtungsänderung der Maschinenspindel beim Rücklauf.

Der Längenausgleich auf Zug mit Kugelausklintechnik im Rücklauf garantiert Gewindetiefen von $\pm 0,15$ mm bei Drehzahlen bis 4000 min^{-1} . Der GNCK-Gewindeschneidapparat mit Kühlmitteldurchführung ist für Drücke bis max. 50 bar ausgelegt.

Präzisionsspannzangen sorgen für eine sichere Spannung der Werkzeuge. Bei hohen Drehmomenten z. B. beim Gewindeformen ist eine zusätzliche Mitnahme über den Schaft-Vierkant möglich.

Die Drehmomentstütze arretiert die Werkzeugaufnahme spindelbezogen und ermöglicht dadurch den automatischen Werkzeugwechsel. Beim Einsetzen wird die Arretierung gelöst, und der Apparat ist einsatzfähig.

Durch die Wendegetriebetechnik sind hohe Schnittgeschwindigkeiten möglich. Dadurch werden wesentlich kürzere Taktzeiten als beim herkömmlichen Gewindeschneiden erreicht.

Verlängerte Spindeln auf Anfrage.

High performance tapping attachments with integrated reversing gear

BILZ tapping attachments are of modular design and can therefore meet the specific requirements of individual machines. They can be used on machining centres with automatic tool changers and on special purpose machines.

Because of the integrated maintenance free reversing gear, changes in direction of the machine spindle are unnecessary.

The length compensation on extension, with a ball release system which operates when in reverse, guarantees thread depths of $\pm 0,15$ mm up to a speed of 4000 rpm. The GNCK tapping unit with coolant feed, can facilitate pressures up to a maximum of 50 bar.

Precision collets ensure that the tap is securely clamped, and additional square drivers can be utilised where high torque is being generated, for example, when thread forming.

The torque support locks the unit relative to the spindle, thus making automatic tool changing possible. When tool changing takes place, the locking mechanism releases the torque support and allows the tool changing operation to be effected.

Because of the use of the reversing gears, high tapping speeds are possible resulting in significantly shorter cycle times compared to conventional tapping.

Extended spindles on request.

Merkmale:	Vorteile:	Nutzen:
<ul style="list-style-type: none"> ▪ selbstreversierendes Wendegetriebe 	<ul style="list-style-type: none"> ▪ kein Reversieren der Maschinenspindel mehr erforderlich 	<ul style="list-style-type: none"> ▪ kürzeste Bearbeitungszeit möglich ▪ minimale Zeitersparnis 200-400 ms ▪ wesentlich geringere Stromaufnahme
<ul style="list-style-type: none"> ▪ direkte Spannzangenaufnahme 	<ul style="list-style-type: none"> ▪ hohe Rundlaufgenauigkeit 	<ul style="list-style-type: none"> ▪ verbesserte Standzeit, geringere Unwucht, reduzierter Verschleiß
<ul style="list-style-type: none"> ▪ Dämpfungselemente zwischen Passfedern der Spindel und Kupplungshülse 	<ul style="list-style-type: none"> ▪ verhindert vorzeitigen Verschleiß 	<ul style="list-style-type: none"> ▪ weniger wartungsintensiv
<ul style="list-style-type: none"> ▪ Kugel als Kupplungselement 	<ul style="list-style-type: none"> ▪ genauer Ausklinkpunkt 	<ul style="list-style-type: none"> ▪ genaue Gewindetiefen ▪ hohe Wiederholgenauigkeit
<ul style="list-style-type: none"> ▪ hydrostatischer Druckausgleich bei IK 	<ul style="list-style-type: none"> ▪ kein Vorfahren des Längenausgleichs bei verschlossener Bohrung im GWB 	<ul style="list-style-type: none"> ▪ keine Kollisionsgefahr durch länger vorbauendes Werkzeug
<ul style="list-style-type: none"> ▪ Konstante Schnittgeschwindigkeit (durch eingebautes Wendegetriebe) 	<ul style="list-style-type: none"> ▪ optimale Schnittbedingungen 	<ul style="list-style-type: none"> ▪ höhere Werkzeugstandzeiten
<ul style="list-style-type: none"> ▪ auswechselbare Mitnehmer BN17... 	<ul style="list-style-type: none"> ▪ formschlüssige Mitnahme des Gewindebohrers und des Mitnehmers in der Spindel 	<ul style="list-style-type: none"> ▪ kein Verdrehen, Durchrutschen des Gewindebohrers möglich
<ul style="list-style-type: none"> ▪ eingebaute Längennachstellschraube 	<ul style="list-style-type: none"> ▪ Gewindebohrer können auf gewünschte Länge voreingestellt werden 	<ul style="list-style-type: none"> ▪ Fehleingaben von Werkzeuglängen im Offset werden verhindert (keine Kollisionsgefahr)
<ul style="list-style-type: none"> ▪ abgedichtete, stabile Ausführung der Drehmomentstütze 	<ul style="list-style-type: none"> ▪ kein Ausfall durch Verschmutzung oder zuviel Spiel in der Drehmomentstütze 	<ul style="list-style-type: none"> ▪ geringere Stillstandszeiten der Maschine, Verhinderung von Kollision ▪ keine Beschädigungen durch verstellte Drehmomentstütze
Features:	Advantages:	Benefits:
<ul style="list-style-type: none"> ▪ self reversing gear 	<ul style="list-style-type: none"> ▪ reversing of machine spindle not required 	<ul style="list-style-type: none"> ▪ shortest processing time possible ▪ minimum time saving 200 – 400 ms per thread ▪ substantially less electrical power consumption
<ul style="list-style-type: none"> ▪ direct collet location 	<ul style="list-style-type: none"> ▪ high concentricity 	<ul style="list-style-type: none"> ▪ better life time of the tool, reduced wear, ▪ less unbalanced mass
<ul style="list-style-type: none"> ▪ damping elements between drive key in the spindle and the coupling sleeve 	<ul style="list-style-type: none"> ▪ avoiding premature wear 	<ul style="list-style-type: none"> ▪ less maintenance intensive
<ul style="list-style-type: none"> ▪ balls used in the couplings elements 	<ul style="list-style-type: none"> ▪ exact disengaging point 	<ul style="list-style-type: none"> ▪ exact thread depth ▪ high repeat accuracy
<ul style="list-style-type: none"> ▪ hydrostatic pressure compensation for IC version 	<ul style="list-style-type: none"> ▪ no axial movement of the spindle into tension, even when the coolant flow is blocked 	<ul style="list-style-type: none"> ▪ no risk of collision through extended tool
<ul style="list-style-type: none"> ▪ constant tapping speed (through built-in reversing gear) 	<ul style="list-style-type: none"> ▪ ideal cutting conditions 	<ul style="list-style-type: none"> ▪ longer tool life time
<ul style="list-style-type: none"> ▪ exchangeable drivers BN17... 	<ul style="list-style-type: none"> ▪ positive torque transmission of the tap and of the driver in the spindle 	<ul style="list-style-type: none"> ▪ no twisting or slipping of the tap in the collet
<ul style="list-style-type: none"> ▪ built-in length adjustment screw 	<ul style="list-style-type: none"> ▪ taps can be set to the required length 	<ul style="list-style-type: none"> ▪ no input data error of tool length in machine offset (no risk of collision)
<ul style="list-style-type: none"> ▪ sealed, stable version of the stop arm 	<ul style="list-style-type: none"> ▪ no malfunction due to contamination or through too much gap in the stop arm 	<ul style="list-style-type: none"> ▪ reduced down time of the machine, prevention of collision ▪ no damage from displaced stop arm

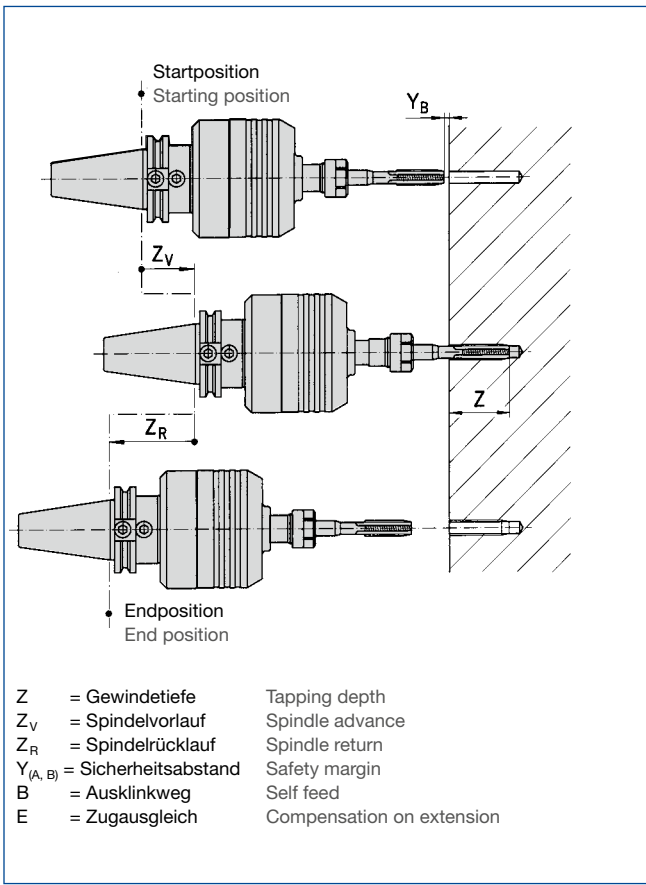
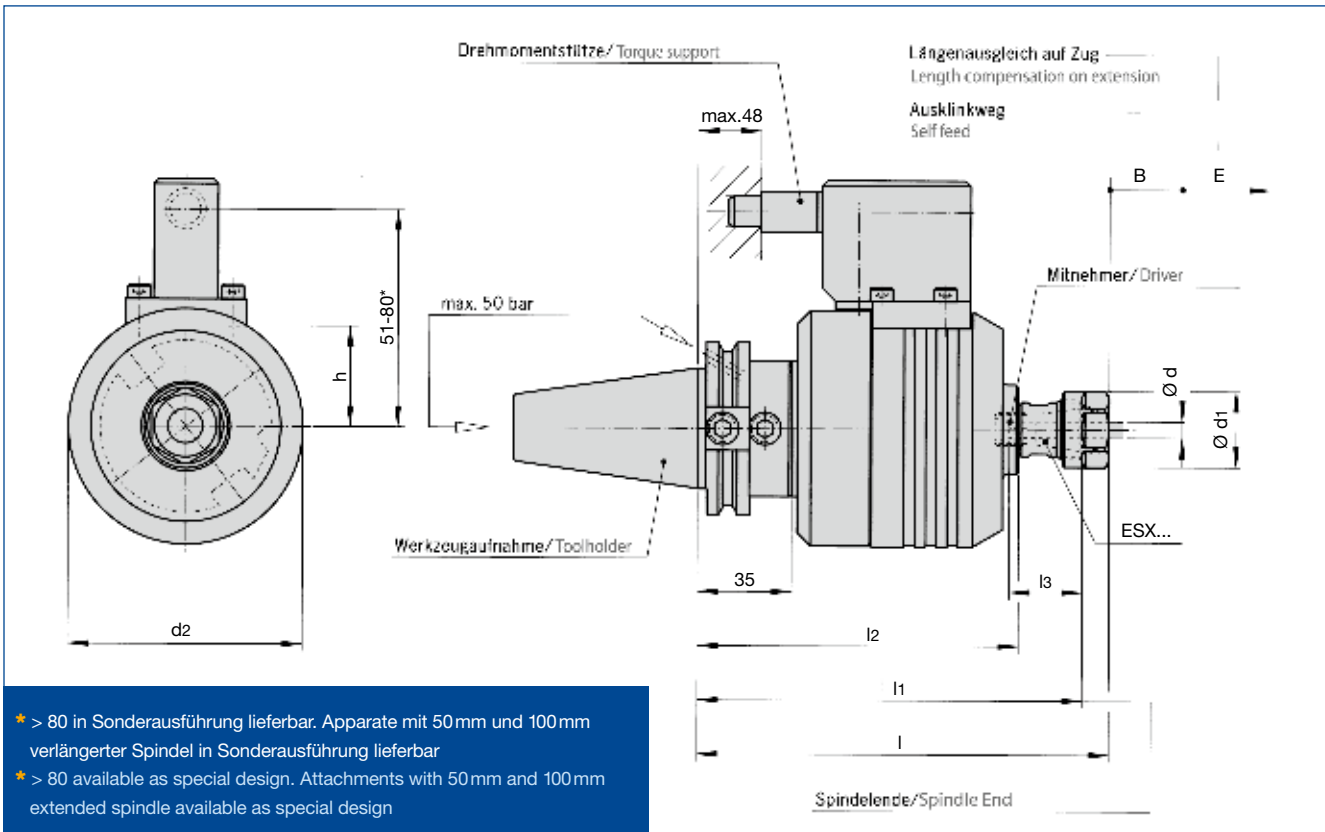

Programmierhilfe

Bei Startposition mit gewähltem Sicherheitsabstand Y_B ergeben sich: $Z_v = Y_B + Z - 0,5 B$
 $Z_r = Z + E + 0,5 B + 1$

Beim Gewindeschneiden auf Bearbeitungszentren mit GNCN/GNCK ist beim Programmieren der Maschine folgendes zu beachten:



- Keine Drehrichtungsänderung der Maschinenspindel, da diese vom GNCN/GNCK erfolgt
- Vorschub = 95% der Gewindesteigung
- Keine Verweilzeit
- Unterschiedliche Anschnittgeometrien der Gewindebohrer
- Ausklinkweg des Gewindeschneidapparates
- Zugausgleich nach dem Ausklinken

Programming example

At the starting position with a selected safety margin Y_B the following equations give: $Z_v = Y_B + Z - 0,5 B$
 $Z_r = Z + E + 0,5 B + 1$

For tapping operations on machining centres using GNCN/GNCK, the following should be taken into account when programming the machine:

- No change in direction of rotation of the machine spindle, as this is carried out by the GNCN/GNCK
- Feed = 95% of thread pitch
- No dwelling time
- Varying cutting geometry of the tap
- Self speed
- Compensation on extension after release

Bezeichnung Designation			$\varnothing d$	n_{max} min ⁻¹	P_{max} bar	B	E	d1	d2	h	l	l1	l2	l3
GNC6-MMS	ESX12	M3-M6	3-7	4000	10	4	6	19	70	27	–	–	106	13/21
GNC12-MMS	ESX16	M4-M12	3-10	2500	10	5	9	28	87	37	–	–	119	25/45
GNC20-MMS	ESX25	M12-M20	7,1-16	1500	10	8	10	42	100	45	187	175	142	29/42
GNCN6C-ESX12/	ESX12	M3-M6	3-7	4000	–	3,5	6,5	19	70	27	132	125	106	13/21
GNCK6C-ESX12/	ESX12	M3-M6	3-7	4000	50	3,5	6,5	19	70	27	132	125	106	13/21
GNCK6V-ESX12/	ESX12	M3-M6	3-7	4000	50	4	6,5	19	70	27	142	135	116	13/21
GNCN12C-ESX16/	ESX16	M4-M12	3-10	2500	–	5	9	28	87	37	153	143	119	25/45
GNCK12C-ESX16/	ESX16	M4-M12	3-10	2500	50	5	9	28	87	37	153	143	119	25/45
GNCK12V-ESX16/	ESX16	M4-M12	3-10	2500	50	5	9	28	87	37	172	162	138	25/45
GNCN20C-ESX25/	ESX25	M12-M20	7,1-16	1500	–	8	10	42	100	45	187	175	142	29/42
GNCK20C-ESX25/	ESX25	M12-M20	7,1-16	1500	50	8	10	42	100	45	187	175	142	29/42

Gewichte Weights

Apparate Unit

GNCK/GNCK 6 C ca. 1,75 kg approx. 1,75 kg

GNCK/GNCK 12 C ca. 3,10 kg approx. 3,10 kg

GNCK/GNCK 20 C ca. 5,15 kg approx. 5,15 kg

Drehmomentstütze Torque Support

je nach Ausführung ca. 0,5 – 1,0 kg Depending on design approx. 0,5 – 1,0 kg

Aufnahme Shank

je nach Ausführung ca. 0,8 – 3,0 kg Depending on design approx. 0,8 – 3,0 kg

Bei Anfragen bitte angeben:

- Maschinenhersteller
- Maschinentyp
- Serien-Nr. Maschine
- Spindelaufnahme/Größe
- mit/ohne IK
- Gewindegröße



For inquiries please add:

- machine manufacturer
- machine type
- serial number machine
- spindle location/ size
- with/without coolant
- thread size

Wichtig! Der Gewindebohrer/Gewindeformer muss für das Material und den Anwendungsfall ausgelegt sein und es sind die Schnittgeschwindigkeiten der Hersteller einzuhalten!

Attention! The tap must be suitable for the material and the process.
 Please respect the recommended speed of the tap manufacturers!

Passende Spannanzgen siehe Seite 33
 Suitable collets see page 33

Bezeichnung Designation		Mitnehmer Driver	Vierkant Square	l ₃		 Set
GNC6-MMS GNCN6C-ESX12 GNCK6C-ESX12	I	–	2,7 - 5	13 - 21	I	GNCK-ESX12
	Id. No.	–	–	–	Id. No.	6831955
	I	–	–	–	I	–
	Id. No.	–	–	–	Id. No.	–
	I	–	–	–	I	–
	Id. No.	–	–	–	Id. No.	–
GNC12-MMS GNCN12C-ESX16 GNCK12C-ESX16	I	BN1716-4	4	27	I	GNCK-ESX16
	Id. No.	6930574			Id. No.	6831954
	I	BN1716-4,5	4,5	28	I	–
	Id. No.	6930575			Id. No.	–
	I	BN1716-5	4,9 - 5	29	I	–
	Id. No.	6930576			Id. No.	–
	I	BN1716-5,6	5,5 - 5,6	29	I	–
	Id. No.	6930577			Id. No.	–
	I	BN1716-6,3	6,2 - 6,3	30	I	–
	Id. No.	6930578			Id. No.	–
	I	BN1716-6,5	6,5	30	I	–
Id. No.	6930579			Id. No.	–	
I	BN1716-6,8	6,8	31	I	–	
Id. No.	6930581			Id. No.	–	
I	–	8	44	I	–	
Id. No.	–			Id. No.	–	
GNC20-MMS GNCN20C-ESX25 GNCK20C-ESX25	I	–	<5	29	I	GNCK-ESX25
	Id. No.	–	–	–	Id. No.	6831956
	I	BN1725-5,6	5 - 5,6	35	I	–
	Id. No.	6943252			Id. No.	–
	I	BN1725-6,5	6,2 - 6,5	36	I	–
	Id. No.	6943253			Id. No.	–
	I	BN1725-7,1	7,1	38	I	–
	Id. No.	6941587			Id. No.	–
	I	BN1725-8	7 - 8	38	I	–
	Id. No.	6931467			Id. No.	–
	I	BN1725-9	8 - 9	40	I	–
	Id. No.	6943834			Id. No.	–
	I	BN1725-10	9 - 10	40	I	–
Id. No.	6931468			Id. No.	–	
I	BN1725-11,2	11,2	42	I	–	
Id. No.	6943835			Id. No.	–	
I	BN1725-12	11 - 12	42	I	–	
Id. No.	6931469	–	–	Id. No.	–	
						

Set-Inhalt: Gabelschlüssel, Inbusschlüssel
 Set contents: wrench, allen key

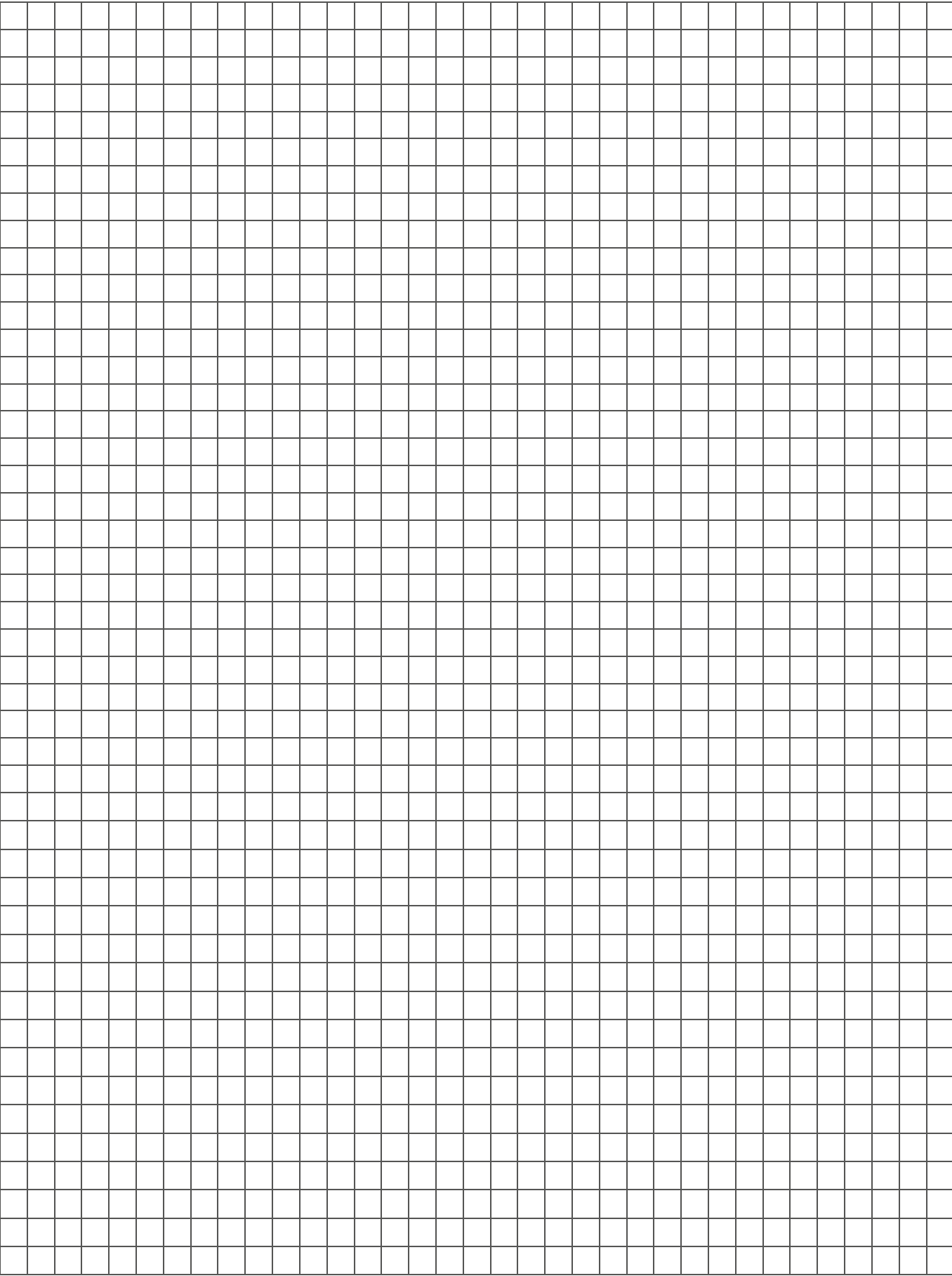

Anwendung: Schneiden von großen Innengewinden im Maschinen-, Motoren-, Turbinen- und Reaktorenbau
Maschinentyp: Bearbeitungszentren, Portalfräsmaschinen, Bohrwerke, Sondermaschinen

Application: tapping of big internal threads in machine, engine, turbine and power station engineering
Machine type: manufacturing centres, portal milling, drilling and special purpose machines

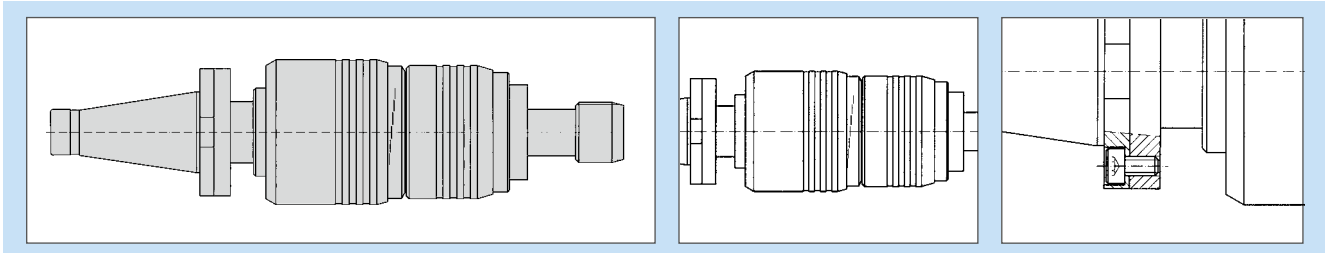

Gewindeschneidfutter und -einsätze zum Schneiden großer Gewinde

Diese Gewindeschneidfutter werden zum Schneiden großer Gewinde im Motoren-, Turbinen- und Reaktorbau auf mechanisch oder numerisch gesteuerten Maschinen eingesetzt. Die Schnellwechseleinsätze werden durch Einführen in die Schnellwechseleinrichtung im Futter automatisch verriegelt.

Der Längenausgleich auf Druck und Zug und die einstellbare Sicherheitskupplung garantieren das Schneiden toleranzhaltiger Gewinde auch unter schwierigsten Einsatzbedingungen.

Durch die auswechselbaren Aufnahmeschäfte können die Gewindeschneidfutter den maschinenspezifischen Anforderungen angepasst werden.

Neben dem Gewindeschneiden mit Einschnitt-Gewindebohrern ist mit diesem System auch das Schneiden mit Satz-Gewindebohrern möglich.

Beim Schneiden mit Satz-Gewindebohrern ist jedoch das exakte Einfinden des Fertigschneiders in das vorgeschchnittene Gewinde nicht möglich. Beim Arbeiten mit dem WFSL-Futter wird der Fertigschneider mit Einsatz in das vorgeschchnittene Gewinde von Hand eingedreht, durch Auffahren des Futters auf den Einsatz unter Drehzahl automatisch gekuppelt und das Gewinde danach fertiggeschnitten.

Gewindeschneidfutter und Einsätze sind auch mit Kühlmitteldurchführung lieferbar.

Tapping chucks and adaptors for the production of larger threads

The WFSL tapping system is used for the production of larger size threads as required in the turbine and reactor industries.

The system can be used on both manual or numerically controlled machines.

The interchangeable flange mounting configuration of the chucks ensures the adaptability to a variety of machine spindle types. Also the length compensation on the chucks, plus the adjustable safety clutch on the adaptors, ensure effective and accurate tapping under the most difficult conditions. In addition to this, the system is designed for rapid and easy adaptor change. The system is also available with coolant feed.

The system is designed to accommodate tapping both with a single tap or series taps.

When tapping with series taps, a narrow thread is produced initially, using the first of the series taps. Prior to the tapping of the full thread form, the plug tap, already locked into the adaptor, must be engaged by hand into the thread in order to prevent double threading. When engaged the spindle drives with rotation against the adaptor which clutches in automatically, then the final tapping can take place.

Tapping chucks and adaptors are also available with internal coolant feed.

Merkmale:	Vorteile:	Nutzen:
<ul style="list-style-type: none"> ▪ Schnellwechselmechanismus für die Einsätze 	<ul style="list-style-type: none"> ▪ schneller Werkzeugwechsel 	<ul style="list-style-type: none"> ▪ Reduzierung der Stillstandzeiten der Maschine, höhere Produktivität
<ul style="list-style-type: none"> ▪ einstellbare Sicherheitskupplung im Futter 	<ul style="list-style-type: none"> ▪ keine Einsätze mit Sicherheitskupplung erforderlich 	<ul style="list-style-type: none"> ▪ geringere Kosten für das System
<ul style="list-style-type: none"> ▪ modulares Schaftsystem 	<ul style="list-style-type: none"> ▪ flexibel in der Anpassung an verschiedene Maschinensysteme durch Tausch der Aufnahmen 	<ul style="list-style-type: none"> ▪ weniger Werkzeuge im Lagerbestand ▪ niedrige Kosten
<ul style="list-style-type: none"> ▪ einstellbarer Längenausgleich auf Druck und Zug 	<ul style="list-style-type: none"> ▪ Kompensation von Steigungsunterschieden zwischen Vorschub und Gewindebohrer 	<ul style="list-style-type: none"> ▪ Schneiden toleranzhaltiger Gewinde auch unter schwierigsten Bedingungen
<ul style="list-style-type: none"> ▪ Längenausgleich auf Druck und Zug, einstellbarer Weg 	<ul style="list-style-type: none"> ▪ kann an die Bearbeitungsfälle angepasst werden 	<ul style="list-style-type: none"> ▪ hohe Flexibilität
<ul style="list-style-type: none"> ▪ Kugelführungsbuchse 	<ul style="list-style-type: none"> ▪ leichtgängiger Längenausgleich auch unter hohen Drehmomenten 	<ul style="list-style-type: none"> ▪ Schneiden toleranzhaltiger Gewinde auch unter schwierigsten Bedingungen
<ul style="list-style-type: none"> ▪ automatisches Einkuppeln der Einsätze (Satzgewindebohrer) 	<ul style="list-style-type: none"> ▪ Satzgewindebohrer kann von Hand angedreht und dann beim Auffahren des Futters auf den Einsatz automatisch gekuppelt werden 	<ul style="list-style-type: none"> ▪ Einsatz von Satzgewindebohrern möglich ▪ einfache Handhabung
Features:	Advantages:	Benefits:
<ul style="list-style-type: none"> ▪ quick change mechanism for tap adaptors 	<ul style="list-style-type: none"> ▪ quick tool change 	<ul style="list-style-type: none"> ▪ reduction of machine down time ▪ higher productivity
<ul style="list-style-type: none"> ▪ adjustable safety clutch in the chuck 	<ul style="list-style-type: none"> ▪ no quick change adaptors with safety clutch required 	<ul style="list-style-type: none"> ▪ cost reduction for the system
<ul style="list-style-type: none"> ▪ modular shank system 	<ul style="list-style-type: none"> ▪ more flexibility by changing the location, chuck can be used on different machines 	<ul style="list-style-type: none"> ▪ smaller number of tools in stock ▪ reduced cost
<ul style="list-style-type: none"> ▪ length compensation on tension and compression 	<ul style="list-style-type: none"> ▪ compensation of pitch differences between tap pitch and feed of the machine 	<ul style="list-style-type: none"> ▪ tapping of threads in tolerance and good quality even under difficult conditions
<ul style="list-style-type: none"> ▪ adjustable length compensation 	<ul style="list-style-type: none"> ▪ can be adjusted acc. to the manufacturing process requirement 	<ul style="list-style-type: none"> ▪ high flexibility
<ul style="list-style-type: none"> ▪ ball cage sleeve 	<ul style="list-style-type: none"> ▪ smooth length compensation even under high torque 	<ul style="list-style-type: none"> ▪ tapping of threads in tolerance and good quality even under difficult conditions
<ul style="list-style-type: none"> ▪ automatic coupling of the adaptors (set of taps e.g. pipe taps) 	<ul style="list-style-type: none"> ▪ set of taps can be screwed in by hand and will be engaged automatically when the chuck contacts the adaptor 	<ul style="list-style-type: none"> ▪ application of tap sets possible ▪ easy handling

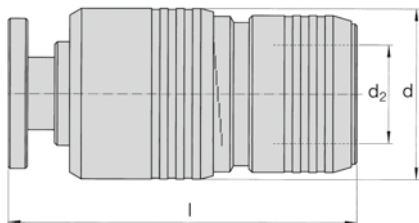

WFSL									
Bezeichnung/Id. Nr. Designation/Id. No.	WEK		max.* Nm			d	d2	l	
WFSL60 6709939	60	M30–M120*	1400	20	20	125	72	257	
WFSL60-IK 6709942	60-IK								X
WFSL60/A4 6709940	60		1800						
WFSL60-IK/A4 6709943	60-IK		X						
WFSL100 6709945	100	M48–M200*	2400	20	20	156	92	323	
WFSL100-IK 6709947	100-IK								X
WFSL100/A4 6709946	100		3000						

Längenausgleich einstellbar von Druck 0 mm/Zug 40 mm bzw. Druck 40 mm/Zug 0 mm. Einstellung ab Werk Druck 20 mm/Zug 20 mm.

Einstellung siehe Seite 78 – 81

Length compensation adjustable from tension 0 mm /compression 40 mm bzw. tension 40 mm /compression 0 mm.

Setting from factory tension 20 mm /compression 20 mm.

Adjustment see page 78 – 81

Passende Schnellwechsel-Einsätze siehe Seite 77

Suitable quick change adaptors see page 77

- * Futterauswahl:
 - max. Gewindgröße/Steigung
 - Drehmoment aus dem Diagramm, Seite 82 – 84 ablesen
 - oder an Hand der Formel „Drehmoment“ berechnen
 - danach das Futter auswählen

- * Chuck selection:
 - max. thread size/pitch
 - check torque in chart page 82 – 84
 - or use formula “torque” for calculation
 - then choose chuck

Beispiel Example

➔ nach Diagramm Seite 83 acc. chart page 83

M 76 x 6 = 1915 Nm

für Material bis 1000 N/mm² for material up to 1000 N/mm²

= WFSL 100 ... notwendig required

➔ nach Formel Seite 84 acc. formula page 84

M 76 x 6 für Material for material 6620, k_C =1600

M_D = $\frac{1600 \times 6^2 \times 76}{8000} \times 2 = 1094$ Nm für for 6620

= WFSL 60 ... ausreichend adequate

	Bezeichnung/Id. Nr. Designation/Id. No.	L1 (mm)	L (mm)	Komplettbezeichnung Futter/Aufnahme Complete Description chuck/location Id. Nr. Id. No.	
	DIN ISO 7388-1				
	WFSL619/A126/SK40 6709965	118,5	49,6		
	WFSL619/A126/SK50 6709958	152,5	50,75	WFSL60/A126/SK50 9078838	
	WFSL619/A126/SK60 5017160	181,9	19,1		
	DIN 2080				
	WFSL619/SK40 6930547	109,5	15,6	WFSL60/SK40 6708984	
	WFSL619/SK50 6930846	144,5	17,2	WFSL60/SK50 6708985	WFSL100/SK50 6708990
	WFSL619/SK60 6709952	217,0	18,0	WFSL60/SK60 6708986	WFSL100/SK60 6708991
	DIN ISO 7388-2				
	WFSL619/A73/SK50 6709961	160,0	58,0	WFSL60/BT50 5042300	
	DIN 228 B				
	WFSL619/MK5 6709948	172,5	23,0	WFSL60/MK5 6708987	WFSL100/MK5 6708992
	WFSL619/MK6 6709949	235,0	25,0	WFSL60/MK6 6708988	WFSL100/MK6 6708993
	DIN 6327				
	WFSL619/TR48-BG 6709962	158,5	14,5		
	KOMET ABS				
	WFSL619/ABS100-BG 5002493	77,5	22,5		
	WFSL619/ABS125 6955004	102,5	32,5		
	DIN 69893, HSK				
	WFSL619-IK/HSK-A100-BG 6709964	109,5	59,5		WFSL100/HSK-A100 5022725
	DIN ISO 7388-1				
	WFSL619/CAT50 5042307	152,5	50,75	WFSL60/CAT50 5042302	

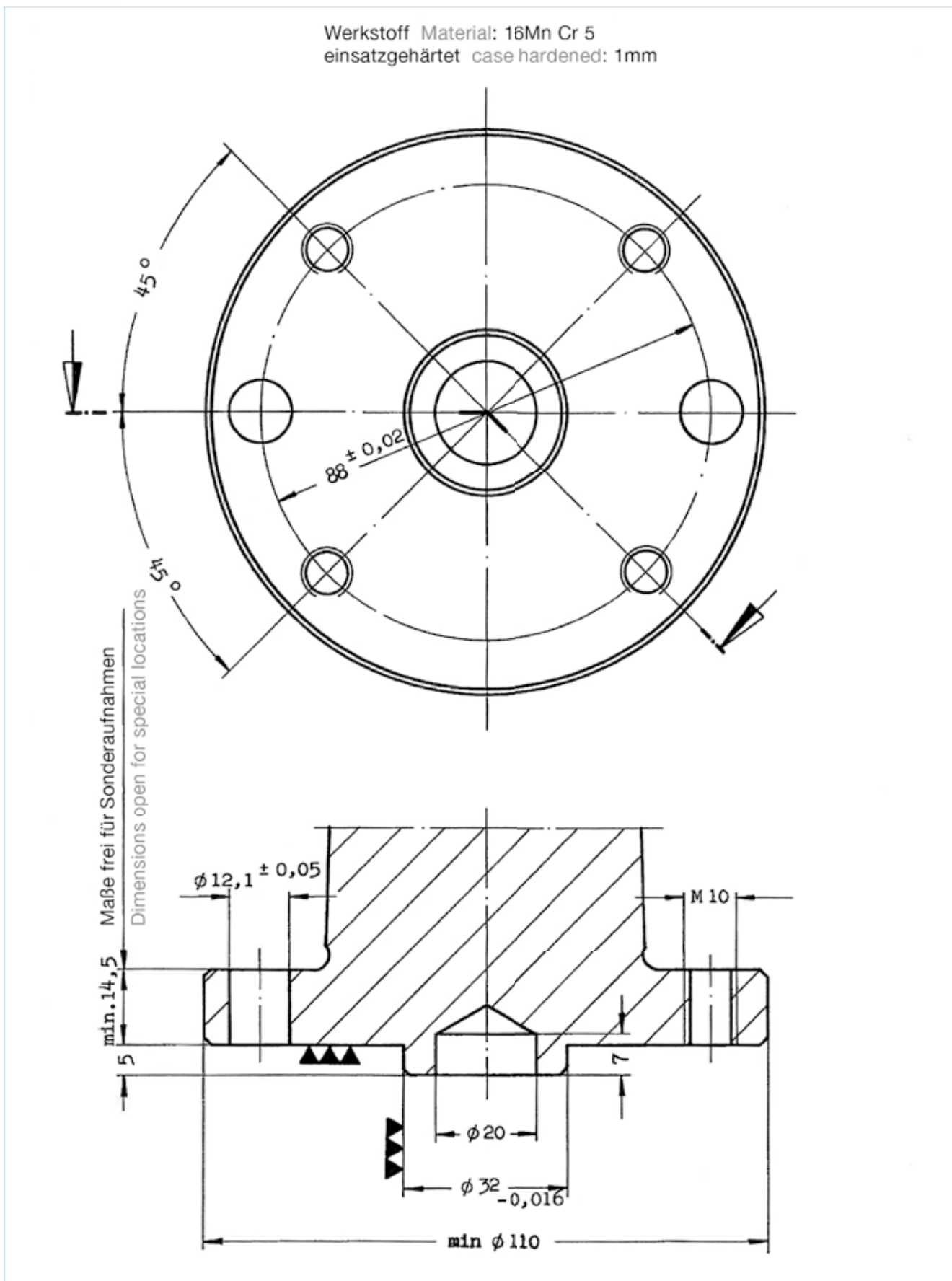

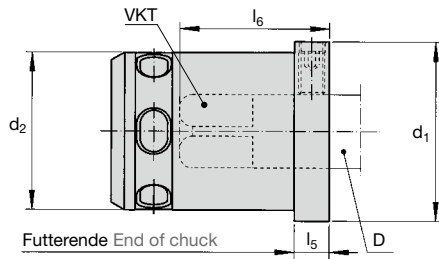

WEK/WEK ... IK			
Bezeichnung Designation		WEK60	WEK100
WEK passend in die Futtertypen WFSL Gewindebohrer mit Gewindestift geklemmt WEK suitable for chuck types WFSL Tap clamped by thread pin		M30-M120 x 4	M48-M200 x 3
		WFSL 60	WFSL 100
	d1	82	110
	d2	72	92
	l5	16	24
	l6	D > 32 mm 88	D > 36 mm 115
	l6	D < 32 mm 76	D < 36 mm 107

Für Gewindebohrer nach DIN
 For taps according to DIN

Bezeichnung Designation	Id. No.	l6	DIN	Bezeichnung Designation	Id. No.	l6
WEK60-22 x18	9157267	76	M30	—	—	—
WEK60-22 x18	5028424	76	M30	—	—	—
WEK60-25 x20	9157268	76	M33	—	—	—
WEK60-28 x22	6721599	76	M36	—	—	—
WEK60-32 x24	9157269	76	M39	—	—	—
WEK60-36 x29	6721598	88	M45 / M48	WEK100-36 x29	9157270	107
WEK60-40 x32	6721575	88	M52	WEK100-40 x32	9157263	107
WEK60-40 x32	6721600	88	M52	—	—	—
WEK60-45 x35	6721576	88	M56	WEK100-45 x35	6721641	107
WEK60-45 x35	6721601	88	M56	—	—	—
WEK60-50 x39	6721578	88	M64	WEK100-50 x39	6721640	115
WEK60-45 x39	6721602	88	M64	—	—	—
WEK60-56 x44	6721580	88	M68	WEK100-56 x44	6721642	115

Für Gewindebohrer nach ISO
 For taps according to ISO

Bezeichnung Designation	Id. No.	l6	ISO	Bezeichnung Designation	Id. No.	l6
WEK60-22,4 x18	—	76	M33	—	—	—
WEK60-25 x20	9157268	76	M36	—	—	—
WEK60-28 x22,4	—	76	M39-M42	—	—	—
WEK60-31,5 x25	—	76	M45-M48	WEK100-31,5 x25	—	102
WEK60-35,5 x28	—	88	M52-M56	WEK100-35,5 x28	—	107
WEK60-40 x31,5	6721574	88	M60-M64	WEK100-40 x31,5	—	107
WEK60-45 x35,5	6721577	88	M68-M75	WEK100-45 x35,5	—	107
WEK60-50 x40	6721579	88	M76 / M80-M90	WEK100-50 x40	—	115
WEK60-56 x45	6721581	88	M92-M100	WEK100-56 x45	6721643	115

Montage und Bedienungsanleitung

WFSL Gewindeschneid-Schnellwechselfutter in Kombination mit Schnellwechsel-Einsätzen Typ WEK...

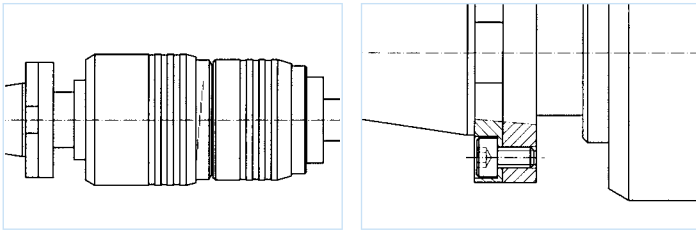

Anwendungsbereich/ Einsatzgebiet

Zum Gewindeschneiden und Formen großer Innengewinde in Großmotoren, im Turbinen-, Reaktor- und Anlagenbau. Auf mechanisch oder numerisch gesteuerten Maschinen z.B. Portalfräs- und Radialbohrmaschinen oder Bohrwerken.

Wir freuen uns, dass Sie sich für ein BILZ Produkt entschieden haben.

Diese Bedienungsanleitung beschreibt die richtige Anwendung und Handhabung des Produktes. Lesen Sie die Bedienungsanleitung vor Gebrauch sorgfältig durch und benutzen Sie das Produkt nur in der von uns angegebenen Art und Weise.

Montageanleitung



Halten Sie die Werkzeugaufnahme in der Maschinenspindel sauber.

Halten Sie das Werkzeug sicher beim Werkzeugwechsel, damit beim Lösen der Werkzeugspannung das Werkzeug nicht in den Maschinenraum fällt und dadurch das Werkzeug und Werkstück beschädigt werden.

Beachten Sie die Werkzeugabmessungen und Angaben des Maschinenherstellers. Die WFSL-Futter sind modular aufgebaut und durch das Auswechseln der Aufnahme-schäfte, somit mit allen gängigen Aufnahmen (DIN69871, MAS-BT, ANSI-CAT, ABS, SK-DIN2080, TR-DIN6327, MK-DIN228A, HSK-DIN69893 u.a.) kombinierbar und auf Maschinen mit verschiedenen Spindelaufnahmen einsetzbar.



Bei kundenspezifischen Spindelausführungen, Futtern mit innerer Kühlmitteldurchführung oder Ausführungen für höhere Drehmomente, wenden Sie sich bitte an die Technische Kundenbetreuung der Fa. BILZ.

Der Längenausgleich ist einstellbar im Bereich von Druck 0 mm / Zug 40 mm oder Druck 40 mm / Zug 0 mm. Einstellung ab Werk Druck 20 mm / Zug 20 mm. Zum Einstellen des Längenausgleichs, die Innensechskantschraube im Zentrum der Aufnahme, mit einem 6 mm Inbusschlüssel rein- oder rausdrehen, aber nur soweit, bis der rote Ring sichtbar wird. (Siehe Bilder)



Wichtige Hinweise!

Um Beschädigungen und Verletzungen zu vermeiden, befolgen Sie bitte genau der Bedienungsanleitung.

Werkzeugwechsel nur bei stehender Spindel!

Demontieren Sie die Produkte nicht und nehmen Sie keine Veränderungen vor. Dies kann zu Beschädigungen und Fehlfunktionen führen!

Verwenden Sie nur Gewindeschneidfutter und Schnellwechsel-Einsätze der Fa. BILZ. Die Kombination mit anderen Produkten kann zu Beschädigungen und Fehlfunktionen führen!

Die Futter sind wartungsfrei, sollten dennoch Störungen auftreten, benutzen Sie die Produkte nicht weiter.

Wenden Sie sich an die Technische Kundenbetreuung der Fa. BILZ.

Reinigung:

In periodischen Abständen empfehlen wir die Futter mit einem Handlappen zu reinigen. Dies ist abhängig vom Verschmutzungsgrad. Keine aggressiven Lösungsmittel verwenden.

Keine fasernden Materialien wie z.B. Putzwolle verwenden.

Ausserbetriebnahme:

Wird das Futter außer Betrieb genommen ist folgendes zu beachten. Futter mit einem Handlappen reinigen.

Futter mit einem Konservierungsschutzöl einsprühen oder einreiben, um die Bildung von Rost zu vermeiden und die Leichtgängigkeit des Futters zu bewahren. Vor dem Einlagern sollten Bearbeitungsrückstände sowie Kühlmittel beseitigt sein.

Benutzen Sie das Produkt nur für die von BILZ empfohlene Anwendung.

Bei Fragen wenden sie sich bitte an BILZ. www.bilz.de

BILZ Werkzeugfabrik GmbH & Co. KG,
73760 Ostfildern, Vogelsangstr. 8

Tel: +49 711 34801 0; E-Mail: info@bilz.de

Bedienungsanleitung

Zum **Auswechseln des Einsatzes** muss die federbelastete Schalthülse nach vorne gezogen werden. Sie wird dann in der Position selbsttätig gehalten. Beim Kuppeln des Einsatzes wird dieser nur in das Futter eingesetzt (Bild1+2), verdreht (Bild 3) und dadurch automatisch verriegelt.



Bild 1



Bild 2



Bild 3

Einstellen Sicherheitskupplung



Schraube rausdrehen



Drehmoment einstellen



Schraube eindrehen

Der Maschinenvorschub sollte bis zu 5% kleiner gewählt werden als die Gewindebohrersteigung, um lehrenhaltige Gewinde zu fertigen.

Bei Vorschubstopp darf der Spindelnachlauf nicht größer sein als der zur Verfügung stehende Zugausgleich, andernfalls erfolgen Gewaltbrüchen der Werkzeuge. (kommt teilweise bei älteren und/oder größeren Maschinen vor).

Für das Einrasten der Kupplung ist Linkslauf erforderlich, wobei der Gewindebohrer wieder herausgedreht wird.

Installation and operating instructions

WFSL quick change tapping chucks in combination with quick change tapping adaptors type WEK...

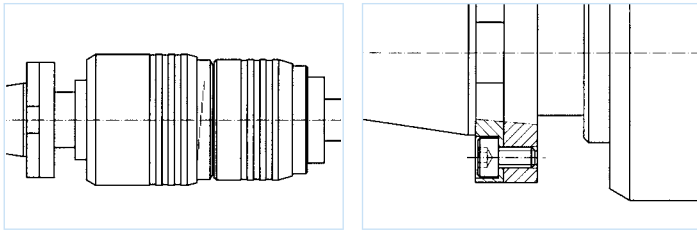

Scope and areas of application

For tapping and roll forming of big internal threads in large engines, turbine, reactor and plant construction. On mechanical or numerically controlled machines e.g. Portal milling and radial drilling machines or jig boring machines

We are pleased that you have decided to purchase a BILZ product. This manual describes the proper use and handling of the product.

Read the instructions carefully before use and use the product only in the manner specified by us.

Installation Instructions



Keep the tool holder location in the machine spindle clean.

Hold the tool securely when changing tools, so when releasing the tool, the tool does not fall into the machine interior and damage the tool and/or work piece.

Note the tool dimensions and the machine manufacturer.

WFSL-chucks have a modular design and by changing the location can be combined with all standard back ends (DIN69871, MAS-BT, ANSI-CAT, ABS, SK-DIN2080, TR-DIN6327, MK-DIN228A, HSK-DIN69893) therefore they can be used on different kinds of machines with different spindle locations.



For customer-specific spindle designs, chucks with internal coolant supply or for higher torque, please contact BILZ Technical Service.

The length compensation is adjustable within the range of tension 0 mm / compression 40 mm bzw. tension 40 mm / compression 0 mm. Setting from factory tension 20 mm / compression 20 mm. To adjust the length compensation, turn in or out the screw with the internal hexagon in the centre of the quick change feature with a 6mm hexagon key, but only until you can see the red ring. (see pictures)



Important information!

To prevent damage or injury, please follow the instructions exactly.

Tool change only with standing spindle!

Do not disassemble the products and do not make any modifications. This may result in damage and malfunction!

Use only BILZ tapping chucks and adaptors.

The combination with other products may cause damage or malfunction!

The tapping chucks are maintenance-free, should there be any faults, please use do not continue using the products. Please contact the BILZ Technical Service.

Cleaning:

We recommend periodically cleaning the chucks with a cleaning rag. This depends on the degree of contamination. Do not use aggressive solvent. Do not use fibrous materials like such as cleaning wool

Out of operation:

If the chuck is taken out of operation, proceed as follows: Clean the chuck with a cleaning rag.

Spray or rub the chuck with a preservation oil to prevent the formation of rust and preserve the smoothness of the chuck. Prior to storage, coolant and processing residues should be removed.

Use the product only for the BILZ recommended application.

If you have any questions please contact BILZ. www.bilz.de
 BILZ Werkzeugfabrik GmbH & Co. KG,
 73760 Ostfildern, Vogelsangstr. 8
 Fon: +49 711 34801 0; Mail: info@bilz.de

Operating Instructions

To release the adaptor, the spring loaded switching sleeve must be pulled forward. It will be automatically held in this position. For coupling the adaptor simply insert it into the quick change feature of the chuck (Picture 1+2), turn (Picture 3) and then it will be locked automatically.



Picture 1



Picture 2



Picture 3

Adjusting safety clutch



turn out screw



adjust torque



turn in screw again

The machine feed should be up to 5% smaller than the pitch of the tap to produce threads in tolerance and good quality.

After spindle stop the over run must not be greater than the available tension compensation otherwise overload breakages of the tools will occur. (this sometimes happens with old and/or large machines).

Reversing the spindle resets the clutch and screws the tap out.

Drehmomente zum Gewindeschneiden und Gewindeformen

Recommended torques for tapping and cold forming operations

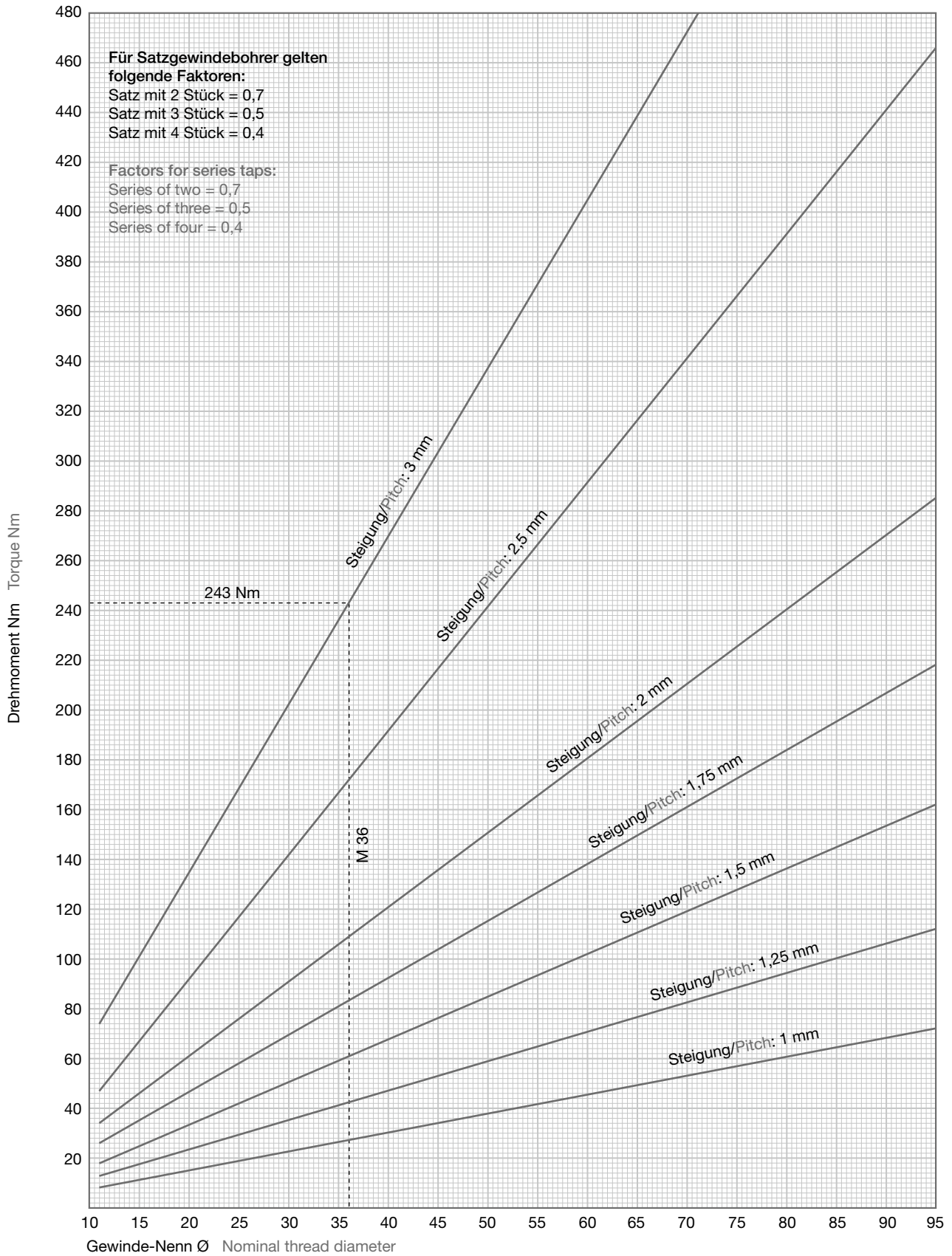

Richtwerte für Werkstoffe bis zu einer Festigkeit von 1000 N/mm²
 For materials with a tensile strength of up to 1000 N/mm²

Drehmomente zum Gewindeschneiden und Gewindeformen

Recommended torques for tapping and cold forming operations

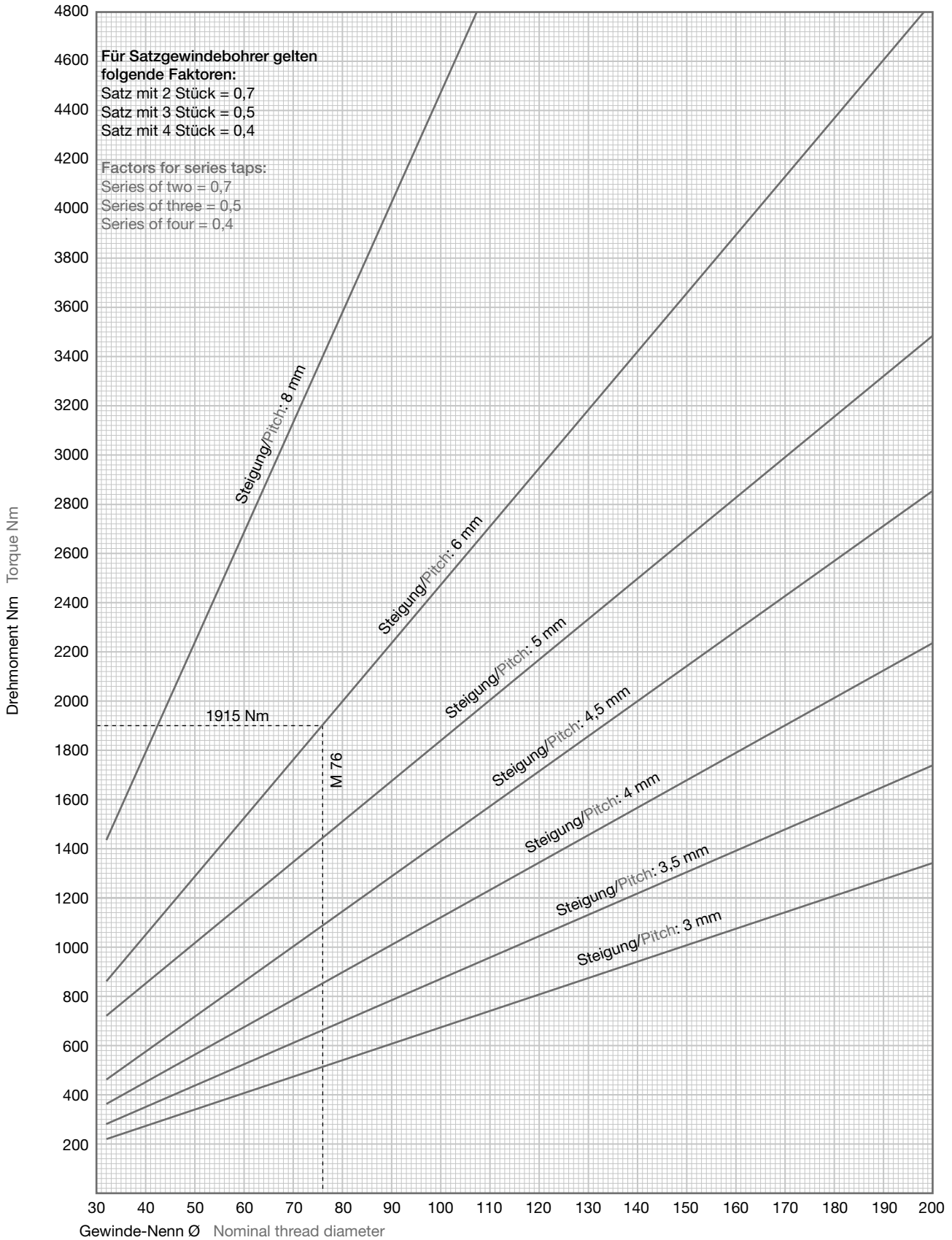

Richtwerte für Werkstoffe bis zu einer Festigkeit von 1000 N/mm²
 For materials with a tensile strength of up to 1000 N/mm²

Drehmoment – Leistungsberechnung beim Gewindeschneiden

Torque – Power consumption calculation tapping

für for: **M, MF, MJ, UNC, UNF, UNEF, UN, G, Rp, NPSM, BSW, W zyl.**



Drehmoment Torque	$M_D = \frac{k_c \cdot h^2 \cdot d_1}{8000} \times 2$	Nm	$k_c \dots$ Spez. Schnittkraft Cutting force (N/mm ²) (Tabelle chart) $h \dots$ Gewindesteigung Thread pitch (mm) $d_1 \dots$ Gewinde-Nenn-Ø Thread size-Ø (mm) 2 Stumpfungszuschlag Gewindebohrer Factor Wornout taps
Leistung am GB Power consumption at tap	$P = \frac{M_D \cdot n}{9500}$	kW	$n \dots$ Drehzahl number of revolutions (Umdr./Minute rpm)
Maschinen-Antriebsleistung Machine drive power	$P_M = \frac{P}{\pi_M}$	kW	$P_M \dots$ erforderliche Maschinen-Antriebsleistung required machine drive power $\pi_M \dots$ Maschinen-Wirkungsgrad $\pi_M < 1$ machine efficiency $\pi_M < 1$

Werkstoff Material	k_c - Wert Value N/mm ²)
Stahl Steel 1000 – 1300 N/mm ²	3200
Stahl Steel 800 – 1000 N/mm ²	2600
Stahl Steel 600 – 850 N/mm ²	2500
Stahl Steel < 600 N/mm ²	2300
Rostfreier Stahl Stainless steel	3200
Gußbronze Cast bronze	1900
GG-20 (HB 170)	1600
GTW hart GTW hard	1250
Kupfer Copper	1100
GTW weich GTW soft	900
Ms Brass	720
Al-Si-Legierung Al-Sialloy	680
Zink-Legierung Zince alloy	440

Berechnungs-Beispiel:

Gewinde M36, Steigung 4 mm,
 zu bearbeitender Werkstoff:
 Stahl 900 N/mm²,
 Drehzahl: 50 Umdr./Minute
 Maschinen-Wirkungsgrad π_M

Calculation example:

Thread M36, Pitch 4 mm,
 Material to be processed:
 Steel 900 N/mm²,
 Speed: 50 rpm
 Machine efficiency π_M

Drehmoment Torque	$M_D = \frac{k_c \cdot h^2 \cdot d_1}{8000}$	$= \frac{2600 \cdot 4^2 \cdot 36}{8000}$	= 187 Nm
Leistung am GB Power consumption at tap	$P = \frac{M_D \cdot n}{9500}$	$= \frac{187 \cdot 50}{9500}$	= 0,98 kW
Maschinen-Antriebsleistung Machine drive power	$P_M = \frac{P}{\pi_M}$	$= \frac{0,98}{0,6}$	= 1,6 kW

Obige Berechnung gilt für neue Gewindebohrer. Bei abgestumpften Werkzeugen kann sich das Drehmoment bis auf das 3 fache erhöhen, wodurch sich auch die erforderliche Maschinenantriebsleistung um denselben Faktor erhöht.

The above calculation is valid for new taps. For worn out taps the torque could be up to 3 times higher, which increases the required machine drive power by the same factor

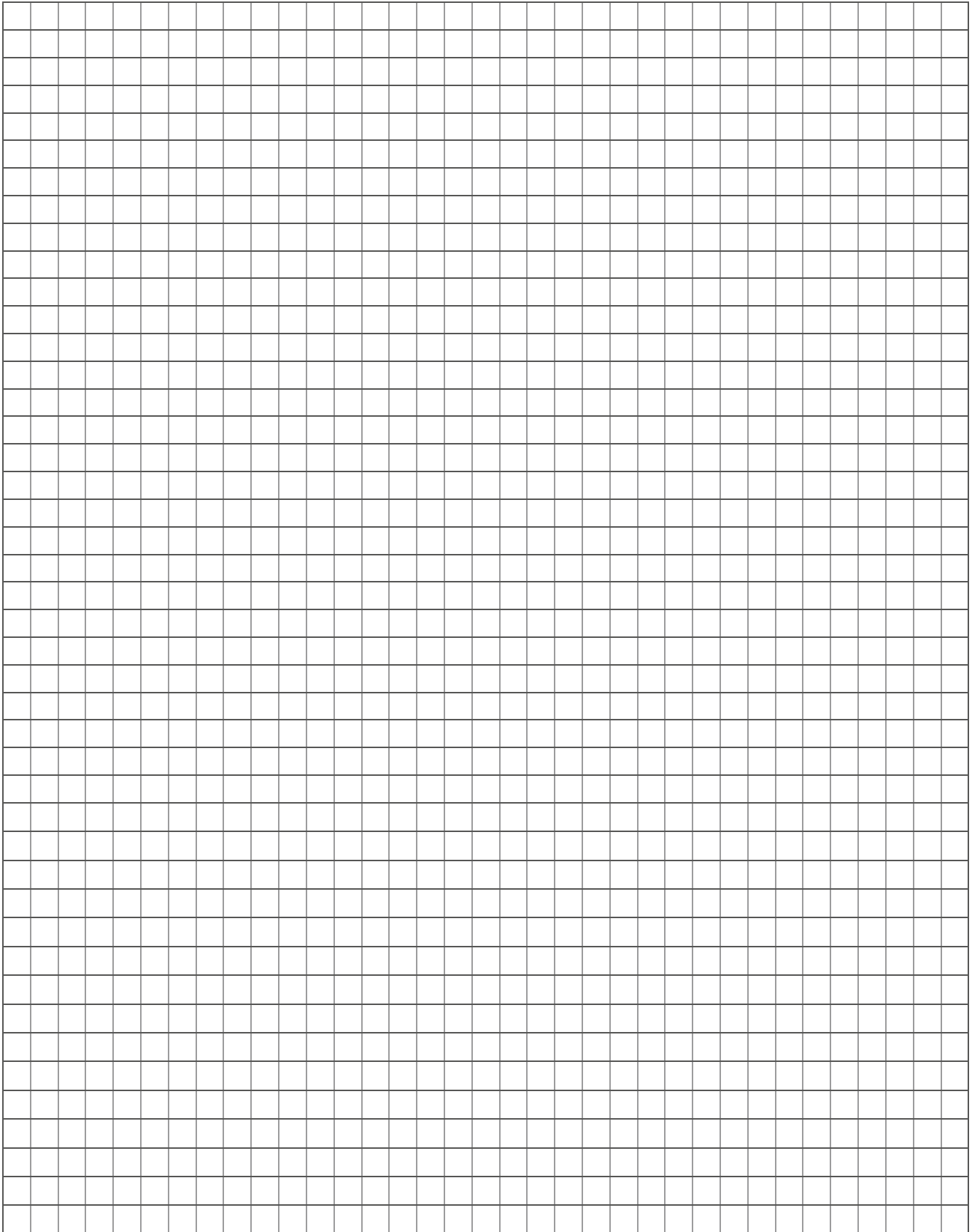

WF – WFLP

Gewindeschneid-Schnellwechselfutter Quick Change Tapping Chuck

bilz

Anwendung: Gewindeschneiden, -formen

Maschinentyp: Transferstraßen, Mehrspindelköpfe und Sondermaschinen

Application: tapping, roll forming

Machine type: transfer lines, multispindle heads and special purpose machines

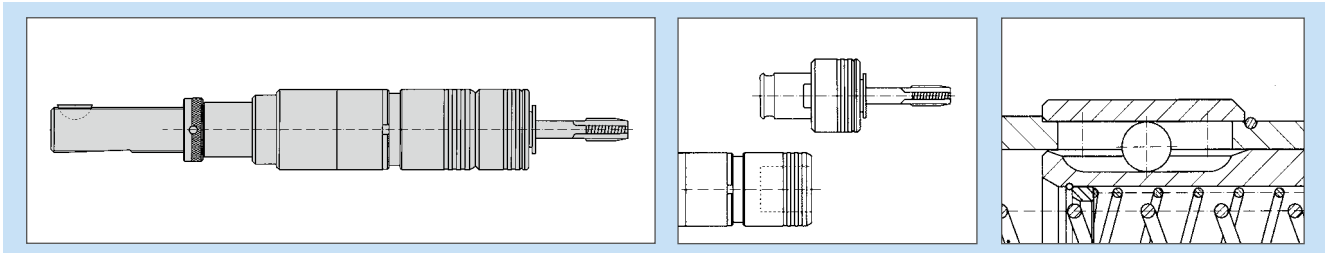

Gewindeschneiden und -formen auf Transferstraßen und Sondermaschinen

BILZ Futter WFLP-WF werden in Verbindung mit den verschiedenen Einsätzen WES-WE speziell für das mehrspindelige Gewindeschneiden eingesetzt. Die Schnellwechsel-Einsätze werden durch Einführen in die Schnellwechseleinrichtung des Futters automatisch verriegelt.

Der Längenausgleich auf Druck und Zug kompensiert Unterschiede zwischen Vorschub und Gewindebohrersteigung. Er nimmt einerseits den Vorschubweg der Maschinenspindel bei Kernlochfehlern auf und ermöglicht andererseits mehrspindeliges Gewindeschneiden mit unterschiedlichen Steigungen ohne exakte Abstimmung von Drehzahl und Vorschub.

Die Druck-Zug-Aufteilung des Längenausgleiches kann den Erfordernissen angepasst werden. Die achsparallele Pendelung mit selbsttätiger Zentrierung ist nur bei Mittenversatz $> 0,2$ mm zwischen Spindelachse und Kernbohrung erforderlich.

WFLP-WF-Futter mit Kühlmitteldurchführung sind auf Anfrage lieferbar.

Tapping and thread forming on transfer lines and special purpose machines

BILZ WFLP-WF chucks are designed for multi-spindle tapping applications and are used in conjunction with the WES-WE adaptors. The system is designed for rapid and easy adaptor change, which are automatically locked by insertion into the chuck.

The length compensation on extension and compression allows any fluctuations which may occur between the spindle feed and the thread pitch, so that multi-spindle tapping with varying pitches is possible, without the need to balance revolutions and feed rates.

The ratio of compression and extension can be chosen to suit varying requirements. The self centring float mechanism only responds when any misalignment is $> 0,2$ mm, between the machine spindle axis and core holes in the component.

WFLP-WF chucks with internal coolant feed are available on request.

Merkmale:	Vorteile:	Nutzen:
<ul style="list-style-type: none"> ▪ Schnellwechselmechanismus 	<ul style="list-style-type: none"> ▪ schneller Werkzeugwechsel, automatisches Verriegeln des Einsatzes 	<ul style="list-style-type: none"> ▪ reduzierte Maschinenstillstandszeit
<ul style="list-style-type: none"> ▪ Längenausgleich auf Druck und/oder Zug, den Erfordernissen angepasst 	<ul style="list-style-type: none"> ▪ Kompensation von Steigungsungenauigkeiten 	<ul style="list-style-type: none"> ▪ Erzeugung von qualitativ einwandfreien Gewinden
<ul style="list-style-type: none"> ▪ Druckbereich mit harter Druckfeder 	<ul style="list-style-type: none"> ▪ Kein Einfedern beim Anschneiden des Gewindebohrers/-formers 	<ul style="list-style-type: none"> ▪ gewünschte, programmierte Gewindetiefe wird erreicht
<ul style="list-style-type: none"> ▪ schlanke Bauform 	<ul style="list-style-type: none"> ▪ besonders geeignet für enge Spindelabstände 	<ul style="list-style-type: none"> ▪ Realisierung enger Bohrbilder, weniger Mehrspindelköpfe
<ul style="list-style-type: none"> ▪ Pendelmechanismus (WFP, WFLP) 	<ul style="list-style-type: none"> ▪ Ausgleichen von Achsversatz zwischen Spindel und Kernlochbohrung 	<ul style="list-style-type: none"> ▪ kein Verschneiden der Gewinde, Gewindequalität in Ordnung
<ul style="list-style-type: none"> ▪ kugelgeführter Längenausgleich 	<ul style="list-style-type: none"> ▪ leichtgängiger Längenausgleich 	<ul style="list-style-type: none"> ▪ gute Gewindequalität
Features:	Advantages:	Benefits:
<ul style="list-style-type: none"> ▪ quick change mechanism for tap adaptors 	<ul style="list-style-type: none"> ▪ quick tool change 	<ul style="list-style-type: none"> ▪ reduction of machine down time ▪ higher productivity
<ul style="list-style-type: none"> ▪ length compensation on tension and/or compression, acc. to the requirements 	<ul style="list-style-type: none"> ▪ compensation of pitch differences between tap pitch and feed of the machine 	<ul style="list-style-type: none"> ▪ tapping of threads in tolerance and good quality even under difficult conditions
<ul style="list-style-type: none"> ▪ compression with strong spring 	<ul style="list-style-type: none"> ▪ not getting into compression while starting the tapping operation 	<ul style="list-style-type: none"> ▪ tapping depth is realised as programmed
<ul style="list-style-type: none"> ▪ slim design 	<ul style="list-style-type: none"> ▪ specially for close centre distance 	<ul style="list-style-type: none"> ▪ realisation of close centre distance, fewer multispindle heads necessary
<ul style="list-style-type: none"> ▪ radial floating mechanism (WFP, WFLP) 	<ul style="list-style-type: none"> ▪ to compensate misalignment/offset between machine spindle and the drill hole in the component 	<ul style="list-style-type: none"> ▪ good thread quality
<ul style="list-style-type: none"> ▪ ball guided length compensation 	<ul style="list-style-type: none"> ▪ smooth length compensation 	<ul style="list-style-type: none"> ▪ good thread quality

WF – Gewindeschneid-Schnellwechselfutter mit innerer Kühlmitteldurchführung
WF – Quick change tapping chucks with internal coolant feed

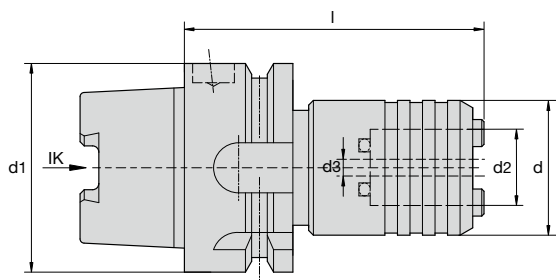

DIN 69 893

50 bar

WF...IKP/HSK-A...								
Bezeichnung Designation	Id. Nr. Id. No.			d	d1	d2	d3	l
WF0-IKP/HSK-A50	–	0	M1-M10*	23	50	13	3	59
WF1-IKP/HSK-A40	5065100	1	M3-M12	32	40	19	4	65
WF1-IKP/HSK-A50	–	1	M3-M12	32	50	19	4	68
WF1-IKP/HSK-A63	6708921	1	M3-M12	32	63	19	4	68
WF1-IKP/HSK-A100	–	1	M3-M12	32	100	19	4	75
WF2-IKP/HSK-A50	–	2	M8-M 20	50	50	31	6	97
WF2-IKP/HSK-A63	6708922	2	M8-M 20	50	63	31	6	90
WF2-IKP/HSK-A100	5048828	2	M8-M 20	50	100	31	6	97
WF3-IKP/HSK-A63	9204793	3	M14-M 33	72	63	48	6	125
WF3-IKP/HSK-A100	6708566	3	M14-M 33	72	100	48	6	130

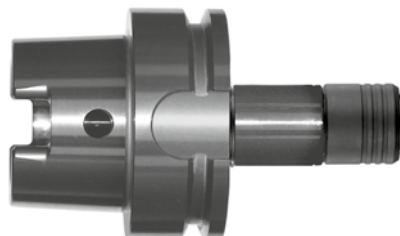
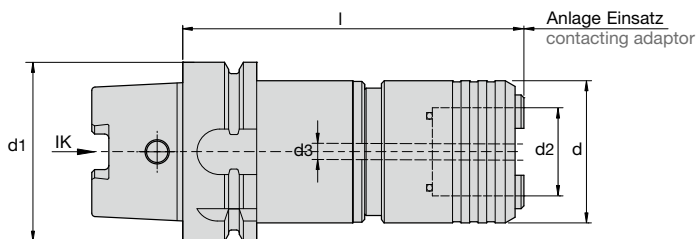

DIN 69 893

20 bar

WFP...IKP/HSK-A... mit achsparalleler Pendelung with radial parallel float									
Bezeichnung Designation	Id. Nr. Id. No.				d	d1	d2	d3	l
WFP1-IKP/HSK-A63	6708380	1	M3-M12	0,5	32	63	19	6	90
WFP2-IKP/HSK-A63	9073903	2	M8-M 20	1	50	63	31	6	120

* > M6 nur für leichte Bearbeitung (max. 5 Nm)
 * > M6 for light machining only (max. 5 Nm)

Passende Schnellwechsel-Einsätze siehe Seite 98 – 117
 Suitable quick change adaptors see page 98 – 117

WF – Gewindeschneid-Schnellwechselfutter mit innerer Kühlmitteldurchführung
WF – Quick change tapping chucks with internal coolant feed

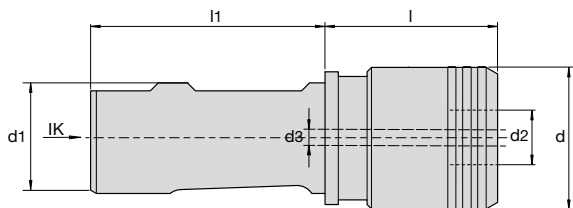

WF KP/MS

mit Bilz-Modular-Schaft MS, ähnlich DIN 1835 zum Kombinieren mit kurzen Fräsespannfutter
 with Bilz modular shank MS, similar DIN 1835 to combine with Weldon chuck

Bezeichnung/Id. Nr. Designation/Id.No.			d	d1	d2	d3	l	l1
WF0-KP/MS16 6708871	0	M1-M10*	23	16	13	2,5	33	48
WF1-KP/MS25 6708872	1	M3-M12	32	25	19	4	39	53
WF2-KP/MS25 6708873	2	M8-M20	50	25	31	6	54	53
WF3-KP/MS32 6708874	3	M14-M33	72	32	48	6	83	60
WF4-KP/MS40 6708870	4	M22-M48	95	40	60	8	102	68

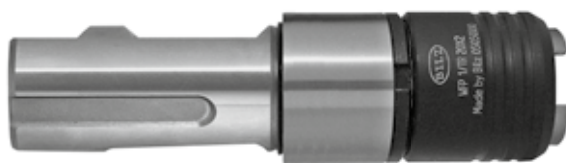
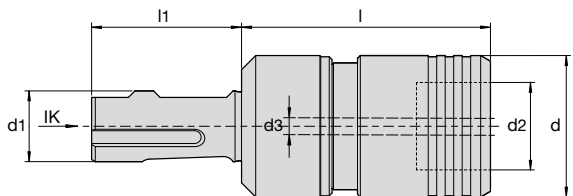

WFP KP/MS

mit Bilz-Modular-Schaft MS, ähnlich DIN 1835, und achsparalleler Pendelung
 with Bilz modular shank MS, similar DIN 1835 and radial parallel float

Bezeichnung/Id. Nr. Designation/Id.No.				d	d1	d2	d3	l	l1
WFP0-KP/MS16 -	0	M1-M10*	0,25	23	16	15	2,5	57	40
WFP1-KP/MS25 6708907	1	M3-M12	0,5	32	25	19	3	62	53
WFP2-KP/MS25 6708925	2	M8-M20	1,0	50	25	31	6	88	53
WFP3-KP/MS32 -	3	M14-M33	1,5	72	32	48	6	128	60



* > M6 nur für leichte Bearbeitung (max. 5 Nm)
 * > M6 for light machining only (max. 5 Nm)

Passende Schnellwechsel-Einsätze siehe Seite 98 – 117
 Suitable quick change adaptors see page 98 – 117

WF – Gewindeschneid-Schnellwechselfutter
WF – Quick change tapping chucks

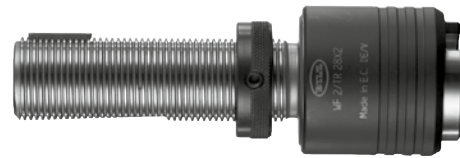
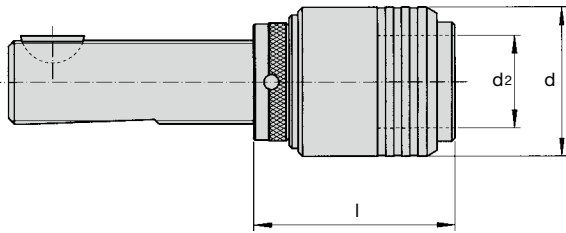

DIN 6327

WF/TR										
Bezeichnung Designation			d	d2		TR16	TR20	TR28	TR36	TR48
WF0/TR...	0	M1-M10*	23	13	l	45	45	–	–	–
					Id. No.	6708463	6708464	–	–	–
WF1/TR...	1	M3-M12	32	19	l	49	49	49	–	–
					Id. No.	6708477	6708478	6708479	–	–
WF2/TR...	2	M8-M20	50	31	l	–	66	66	68	–
					Id. No.	–	6708519	6708520	6708521	–
WF3/TR...	3	M14-M33	72	48	l	–	–	95	97	–
					Id. No.	–	–	6708550	6708553	–
WF4/TR...	4	M22-M48	95	60	l	–	–	–	124	118
					Id. No.	–	–	–	6708570	6708571

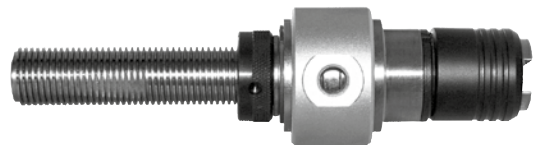
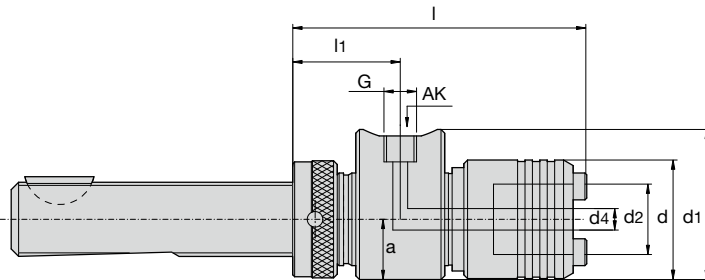

DIN 6327



WF-AKP/TR...											
Bezeichnung/Id. Nr. Designation/Id. No.			d	d1	d2	d4	a	G	l	l1	Drehzahl Speed max. min ⁻¹ max. rpm
WF0-AKP/TR16 6708689	0	M3-M10*	23	35	13	3	13,5	G1/8"	75	47,5	1600
WF1-AKP/TR20 6708690	1	M3-M12	32	40,5	19	3,5	16,2	G1/8"	80	51	1250
WF1-AKP/TR28 6708767				47			19,5		83	52,5	1050
WF2-AKP/TR20 6708908	2	M8-M20	50	47	31	6,0	19,5	G1/8"	99	67,5	1050
WF2-AKP/TR28 6708901				47			19,5		99	67,5	1050
WF2-AKP/TR36 5058993				54			23,5		105	68,5	850
WF3-AKP/TR28 6708564	3	M14-M33	72	80	48	6,0	40	G1/4"	141	99,5	550

* > M6 nur für leichte Bearbeitung (max. 5 Nm)
 * > M6 for light machining only (max. 5 Nm)

Passende Schnellwechsel-Einsätze siehe Seite 98 – 117
 Suitable quick change adaptors see page 98 – 117

WFP – Gewindeschneid-Schnellwechselfutter
WFP – Quick change tapping chucks

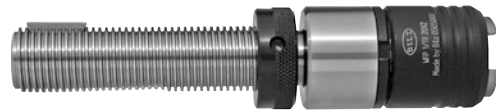
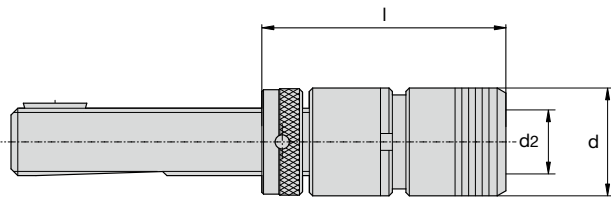

WFP/TR
mit achsparalleler Pendleinrichtung
with radial parallel float

Bezeichnung Designation	Icon 1	Icon 2	Icon 3	d	d2	l	TR16x1,5	TR20x2	TR28x2	TR36x2	TR48x2
							Id. No.	Id. No.	Id. No.	Id. No.	Id. No.
WFP0/TR...	0	M1-M10*	0,25	23	13	65	65	-	-	-	-
WFP1/TR...	1	M3-M12	0,5	32	19	70	70	70	-	-	-
WFP2/TR...	2	M8-M20	1	50	31	-	96	96	98	-	-
WFP3/TR...	3	M14-M33	1,5	72	48	-	-	136	138	-	-
WFP4/TR...	4	M22-M48	2	95	60	-	-	-	167	171	-
WFP40/TR...	40	M6-M18	0,75	40	26	-	89	89	-	-	-

DIN
6327



WFP – Gewindeschneid-Schnellwechselfutter
WFP – Quick change tapping chucks

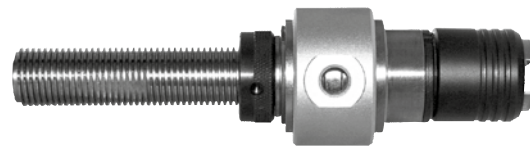
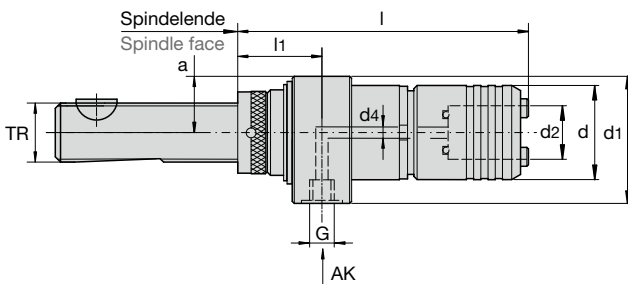

WFP-AKP/TR...
mit achsparalleler Pendelung und äußerer Kühlmittelzufuhr
with radial parallel float and external coolant feed

Bezeichnung Designation	Icon 1	Icon 2	Icon 3	d	d1	d2	d4	a	G	TR 20		TR 28		TR 36		Drehzahl Speed max. min ⁻¹ max. rpm
										l	l ₁ min.	l	l ₁ min.	l	l ₁ min.	
WFP1-AKP/TR...	1	M3-M12	0,5	32	47	19	3	19,5	G1/8"	103	32	103	32	-	-	1250
WFP2-AKP/TR...	2	M8-M20	1	50	62	31	6	27,5	G1/8"	132	36	132	36	134	38	950

DIN
6327



* > M6 nur für leichte Bearbeitung (max. 5 Nm)
* > M6 for light machining only (max. 5 Nm)

Passende Schnellwechsel-Einsätze siehe Seite 98 – 117
Suitable quick change adaptors see page 98 – 117

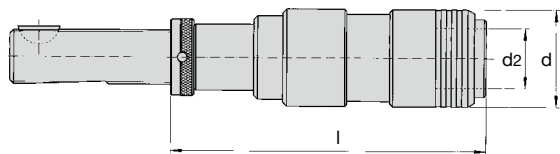

DIN
6327



WFL/TR

mit Längenausgleich auf Druck/Zug
 with length compensation on compression/extension

Bezeichnung Designation					d	d2	l	TR16	TR20	TR28	TR36
								Id. No.	Id. No.	Id. No.	Id. No.
WFL020-20/TR...	0	M1-M10*	20	0	23	13	107	107	–	–	–
							6707969	6707971	–	–	–
WFL030-30/TR...	0	M1-M10*	30	0	23	13	127	127	–	–	–
							6707979	6707980	–	–	–
WFL030-20/TR...	0	M1-M10*	20	10	23	13	117	117	–	–	–
							6707991	6707992	–	–	–
WFL030-15/TR...	0	M1-M10*	15	15	23	13	112	112	–	–	–
							6708002	6708003	–	–	–
WFL030-0/TR...	0	M1-M10*	0	30	23	13	97	97	–	–	–
							6708013	6708014	–	–	–
WFL130-30/TR...	1	M3-M12	30	0	35	19	139	139	139	–	–
							6708036	6708037	6708039	–	–
WFL140-40/TR...	1	M3-M12	40	0	35	19	159	159	159	–	–
							6708057	6708058	6708059	–	–
WFL140-30/TR...	1	M3-M12	30	10	35	19	149	149	149	–	–
							6708084	6708085	6708086	–	–
WFL140-20/TR...	1	M3-M12	20	20	35	19	139	139	139	–	–
							6708099	6708100	6708102	–	–
WFL140-0/TR...	1	M3-M12	0	40	35	19	119	119	119	–	–
							6708122	6708123	6708124	–	–
WFL230-30/TR...	2	M8-M20	30	0	50	31	–	163	163	165	–
							–	6708158	6708159	6708160	–
WFL240-40/TR...	2	M8-M20	40	0	50	31	–	183	183	185	–
							–	6708171	6708172	6708173	–
WFL240-30/TR...	2	M8-M20	30	10	50	31	–	173	173	175	–
							–	6708197	6708198	6708199	–
WFL240-20/TR...	2	M8-M20	20	20	50	31	–	163	163	165	–
							–	6708208	6708209	6708210	–
WFL240-0/TR...	2	M8-M20	0	40	50	31	–	143	143	145	–
							–	6708231	6708232	6708233	–
WFL32.40-40/TR...	1	M3-M12	40	0	32	19	159	159	–	–	–
							6708297	6708298	–	–	–
WFL32.40-30/TR...	1	M3-M12	30	10	32	19	149	149	–	–	–
							6708301	6708302	–	–	–
WFL32.40-20/TR...	1	M3-M12	20	20	32	19	139	139	–	–	–
							6708304	6708305	–	–	–
WFL32.40-0/TR...	1	M3-M12	0	40	32	19	119	119	–	–	–
							6708309	6708310	–	–	–
WFL40.40-40/TR...	40	M6-M18	40	0	40	26	–	176	176	–	–
							–	6708312	6708313	–	–
WFL40.40-30/TR...	40	M6-M18	30	10	40	26	–	166	166	–	–
							–	6708320	6708321	–	–
WFL40.40-20/TR...	40	M6-M18	20	20	40	26	–	156	156	–	–
							–	6708324	6708325	–	–
WFL40.40-0/TR...	40	M6-M18	0	40	40	26	–	136	136	–	–
							–	6708327	6708328	–	–

* > M6 nur für leichte Bearbeitung (max. 5 Nm)
 * > M6 for light machining only (max. 5 Nm)

Passende Schnellwechsel-Einsätze siehe Seite 98 – 132
 Suitable quick change adaptors see page 98 – 132

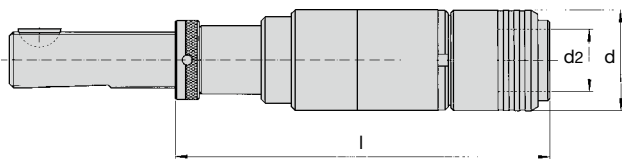

WFLP/TR mit Längenausgleich auf Druck/Zug und achsparalleler Pendleinrichtung with length compensation on compression/extension and radial parallel float												
Bezeichnung Designation						d	d2		TR16	TR20	TR28	TR36
WFLP020-20/TR...	0	M1-M10*	0,25	20	0	23	13	I	129	129	–	–
								Id. No.	6707577	6707579	–	–
WFLP030-30/TR...	0	M1-M10*	0,25	30	0	23	13	I	149	149	–	–
								Id. No.	6707593	6707594	–	–
WFLP030-20/TR...	0	M1-M10*	0,25	20	10	23	13	I	139	139	–	–
								Id. No.	6707610	6707611	–	–
WFLP030-15/TR...	0	M1-M10*	0,25	15	15	23	13	I	134	134	–	–
								Id. No.	6707620	6707621	–	–
WFLP030-0/TR...	0	M1-M10*	0,25	0	30	23	13	I	119	119	–	–
								Id. No.	6707630	6707631	–	–
WFLP130-30/TR...	1	M3-M12	0,5	30	0	35	19	I	154	154	154	–
								Id. No.	6707664	6707666	6707668	–
WFLP140-40/TR...	1	M3-M12	0,5	40	0	35	19	I	174	174	174	174
								Id. No.	6707688	6707689	6707691	–
WFLP140-30/TR...	1	M3-M12	0,5	30	10	35	19	I	164	164	164	–
								Id. No.	6707728	6707729	6707730	–
WFLP140-20/TR...	1	M3-M12	0,5	20	20	35	19	I	154	154	154	–
								Id. No.	6707743	6707744	6707746	–
WFLP140-0/TR...	1	M3-M12	0,5	0	40	35	19	I	134	134	134	–
								Id. No.	6707765	6707766	6707767	–
WFLP230-30/TR...	2	M8-M20	1,0	30	0	50	31	I	–	–	188	190
								Id. No.	–	–	6707799	6707801
WFLP240-40/TR...	2	M8-M20	1,0	40	0	50	31	I	–	208	208	210
								Id. No.	–	6707816	6707817	6707819
WFLP240-30/TR...	2	M8-M20	1,0	30	10	50	31	I	–	198	198	200
								Id. No.	–	6707841	6707842	6707843
WFLP240-20/TR...	2	M8-M20	1,0	20	20	50	31	I	–	188	188	190
								Id. No.	–	6707848	6707849	6707850
WFLP240-0/TR...	2	M8-M20	1,0	0	40	50	31	I	–	168	168	170
								Id. No.	–	6707872	6707873	6707874
WFLP32.40-40/TR...	1	M3-M12	0,5	40	0	32	19	I	174	174	–	–
								Id. No.	–	6707945	–	–
WFLP32.40-30/TR...	1	M3-M12	0,5	30	10	32	19	I	164	164	–	–
								Id. No.	6707946	6707947	–	–
WFLP32.40-20/TR...	1	M3-M12	0,5	20	20	32	19	I	154	154	–	–
								Id. No.	6707948	6707949	–	–
WFLP32.40-0/TR...	1	M3-M12	0,5	0	40	32	19	I	134	134	–	–
								Id. No.	6707950	6707951	–	–
WFLP40.40-40/TR...	40	M6-M18	0,75	40	0	40	26	I	–	201	201	–
								Id. No.	–	6707952	6707953	–
WFLP40.40-30/TR...	40	M6-M18	0,75	30	10	40	26	I	–	191	191	–
								Id. No.	–	6707958	6707959	–
WFLP40.40-20/TR...	40	M6-M18	0,75	20	20	40	26	I	–	181	181	–
								Id. No.	–	6707961	6707962	–
WFLP40.40-0/TR...	40	M6-M18	0,75	0	40	40	26	I	–	161	161	–
								Id. No.	–	6707964	6707965	–

* > M6 nur für leichte Bearbeitung (max. 5 Nm)
 * > M6 for light machining only (max. 5 Nm)

Passende Schnellwechsel-Einsätze siehe Seite 98 – 132
 Suitable quick change adaptors see page 98 – 132



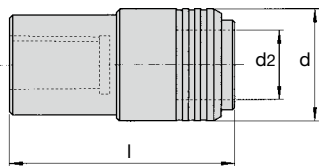

DIN 238

WF/B											
Bezeichnung Designation			d	d2		B10	B12	B16	B18	B22	B24
WF0/B...	0	M1-M10*	23	13	I	51	55	–	–	–	–
					Id. No.	6708469	6708470	–	–	–	–
WF1/B...	1	M3-M12	32	19	I	–	59	65	73	–	–
					Id. No.	–	6708491	6708492	6708493	–	–
WF2/B...	2	M8-M20	50	31	I	–	–	84	92	101	–
					Id. No.	–	–	6708528	6708529	6708530	–
WF3/B...	3	M14-M33	72	48	I	–	–	–	–	126	136
					Id. No.	–	–	–	–	6708560	6708561

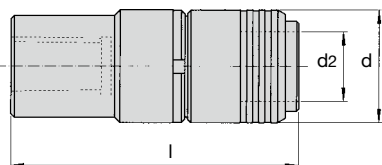

DIN 238



WFP/B mit achsparalleler Pendelung with radial parallel float												
Bezeichnung Designation				d	d2		B10	B12	B16	B18	B22	B24
WFP0/B...	0	M3-M10*	0,25	23	13	I	72	76	83	–	–	–
						Id. No.	6708337	6708338	6708339	–	–	–
WFP1/B...	1	M3-M12	0,5	32	19	I	–	79	85	95	–	–
						Id. No.	–	6708359	6708360	6708361	–	–
WFP2/B...	2	M8-M20	1,0	50	31	I	–	–	112	119	129	–
						Id. No.	–	–	6708414	6708415	6708416	–
WFP3/B...	3	M14-M33	1,5	72	48	I	–	–	–	156	165	175
						Id. No.	–	–	–	6708444	6708445	6708446
WFP4/B...	4	M22-M48	2,0	95	60	I	–	–	–	–	196	206
						Id. No.	–	–	–	–	–	6708455

* > M6 nur für leichte Bearbeitung (max. 5 Nm)
* > M6 for light machining only (max. 5 Nm)

Passende Schnellwechsel-Einsätze siehe Seite 98 – 117
Suitable quick change adaptors see page 98 – 117

WF – Gewindeschneid-Schnellwechselfutter
WF – Quick change tapping chucks

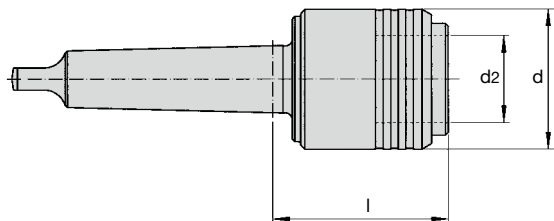

WF/MK										
Bezeichnung Designation										
			d	d2		MK1	MK2	MK3	MK4	MK5
WF0/MK	0	M1-M10*	23	13	l	39	40	-	-	-
					Id. No.	6708467	6708468	-	-	-
WF1/MK	1	M3-M12	32	19	l	43	44	44	-	-
					Id. No.	6708485	6708486	6708488	-	-
WF2/MK	2	M8-M20	50	31	l	-	61	61	62	-
					Id. No.	-	6708525	6708526	6708527	-
WF3/MK	3	M14-M33	72	48	l	-	-	90	91	-
					Id. No.	-	-	6708558	6708559	-
WF4/MK	4	M22-M48	95	60	l	-	-	-	110	109
					Id. No.	-	-	-	6708573	6708574

DIN
228B

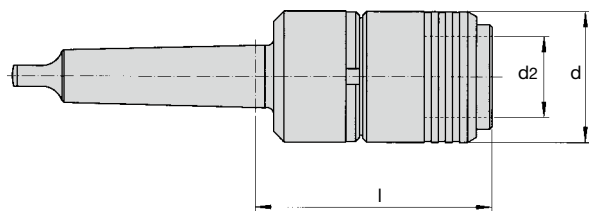

WFP/MK mit achsparalleler Pendelung with radial parallel float										
Bezeichnung Designation										
				d	d2		MK1	MK2	MK3	MK4
WFP0/MK...	0	M3-M10*	0,25	23	13	l	59	60	-	-
						Id. No.	6708335	6708336	-	-
WFP1/MK...	1	M3-M12	0,5	32	19	l	64	65	65	-
						Id. No.	6708356	6708357	6708358	-
WFP2/MK...	2	M8-M20	1	50	31	l	-	91	91	92
						Id. No.	-	6708411	6708412	6708413
WFP3/MK...	3	M14-M33	1,5	72	48	l	-	-	131	132
						Id. No.	-	-	6708442	6708443
WFP4/MK...	4	M22-M48	2	95	60	l	-	-	-	161
						Id. No.	-	-	-	6708453

DIN
228B



* > M6 nur für leichte Bearbeitung (max. 5 Nm)
 * > M6 for light machining only (max. 5 Nm)

Passende Schnellwechsel-Einsätze siehe Seite 98 – 117
 Suitable quick change adaptors see page 98 – 117

Anwendung: spannen von Gewindeschneiden und -formen

Futtertyp: alle Gewindeschneidfutter mit Schnellwechselmechanismus (WF...)

Application: clamping of taps and roll forming taps

Chuck type: all tapping chucks with quick change mechanism style (WF...)

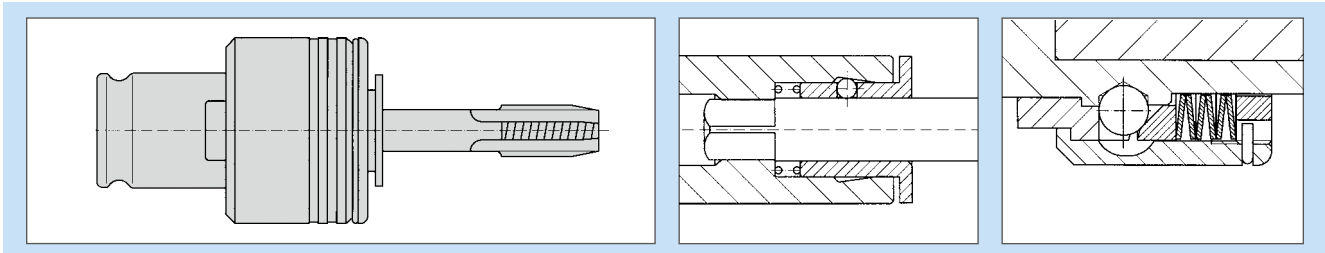

Schnellwechsel-Einsätze zur Aufnahme von Gewindebohrern und Gewindeformern

Durch die Verwendung von Schnellwechsel-Einsätzen in Verbindung mit BILZ-Schnellwechselfuttern können Werkzeugwechselzeiten verkürzt und dadurch Stillstandzeiten der kostenintensiven Fertigung auf Sondermaschinen und Transferstraßen reduziert werden.

Für die unterschiedlichsten Anwendungen stehen Einsätze mit verschiedenen Funktionen zur Verfügung.

Bei den Standardeinsätzen werden die Gewindebohrer über eine Schnellspaneinrichtung gehalten, die Drehmomentübertragung erfolgt über den Schaft-Vierkant. Für unterschiedliche Schaftmaße der Gewindebohrer sind verschiedene Einsätze erforderlich.

Zum Voreinstellen der Werkzeuge außerhalb der Maschine werden Einsätze mit Längennachstellung verwendet.

Einsätze mit einstellbarer Sicherheitskupplung werden zur Vermeidung von Gewindebohrerbruch eingesetzt.

Bei Werkstücken mit Störkanten können verlängerte Einsätze verwendet werden.

Andere Einsätze z.B. mit Spannzangenaufnahme, erweitertem Spannungsbereich, Schneideisenaufnahme für Außengewinde oder Reduziereinsätze ergänzen diese Produktpalette.

Quick change adaptors for tapping and thread forming

By using the combination of Bilz tapping adaptors and Bilz quick change tapping chucks, tool changing times can be minimized. On transfer lines and special application machines where down time costs are high, these efficiencies represent significant savings.

The adaptors are designed for optimum efficiency. Removal and replacement in the chuck is rapid and the location and locking of the tap in the adaptor is simple and effective.

In all cases the drive of the tap is realised by the square. The tap shank is held in position by a quick locking mechanism.

Adaptors with length adjustment are available for setting off the machine, extended length adaptors are available for areas of difficult access, adjustable safety clutch adaptor, facilitates the avoidance of tap breakage.

In all cases, a different adaptor is required for each size of tap shank.

Adaptors for other applications, such as those for accepting collets, and dies for external threads or for increased shank or reduction facility complete this product family.

WE – WES...B

Schnellwechsel-Einsatz Quick Change Adaptors



Merkmale:	Vorteile:	Nutzen:
<ul style="list-style-type: none"> ▪ Schnellwechselsystem für Gewindebohrer/-former 	<ul style="list-style-type: none"> ▪ schneller Wechsel von Gewindebohrern in der Maschine 	<ul style="list-style-type: none"> ▪ reduzierte Stillstandszeiten
<ul style="list-style-type: none"> ▪ Schnellwechselsystem für Einsätze im Futter 	<ul style="list-style-type: none"> ▪ schneller Wechsel von Einsätzen 	<ul style="list-style-type: none"> ▪ reduzierte Stillstandszeiten
<ul style="list-style-type: none"> ▪ Sicherheitskupplung (alle Typen WES...) 	<ul style="list-style-type: none"> ▪ verhindert Gewindebohrerbruch 	<ul style="list-style-type: none"> ▪ weniger Stillstandszeiten, geringere Nacharbeitskosten
<ul style="list-style-type: none"> ▪ Sicherheitskupplung (alle Typen WES...) mit Kugeltechnik 	<ul style="list-style-type: none"> ▪ reibungsarm 	<ul style="list-style-type: none"> ▪ geringer Verschleiß, weniger wartungsanfällig
<ul style="list-style-type: none"> ▪ Längennachstellung (alle Typen WEN...) 	<ul style="list-style-type: none"> ▪ Längenvoreinstellung außerhalb der Maschine 	<ul style="list-style-type: none"> ▪ reduzierte Stillstandszeiten
<ul style="list-style-type: none"> ▪ formschlüssige Mitnahme des Gewindebohrers am Vierkant 	<ul style="list-style-type: none"> ▪ kein Verdrehen des Gewindebohrers im Einsatz 	<ul style="list-style-type: none"> ▪ Vermeidung von Werkzeugbruch
<ul style="list-style-type: none"> ▪ verlängerte Einsätze möglich 	<ul style="list-style-type: none"> ▪ Bearbeitung von tieferliegenden Gewinden oder Störkonturen ohne Sonderwerkzeuge 	<ul style="list-style-type: none"> ▪ Kostenersparnis
Features:	Advantages:	Benefits:
<ul style="list-style-type: none"> ▪ quick change system for taps and roll forming taps 	<ul style="list-style-type: none"> ▪ quick change of taps in the machine 	<ul style="list-style-type: none"> ▪ reduced down time of the machine
<ul style="list-style-type: none"> ▪ quick change system for tap adaptors in the chuck 	<ul style="list-style-type: none"> ▪ quicker tool change of the adaptors/ taps 	<ul style="list-style-type: none"> ▪ reduced down time
<ul style="list-style-type: none"> ▪ safety clutch (all types WES...) 	<ul style="list-style-type: none"> ▪ prevents tap breakage 	<ul style="list-style-type: none"> ▪ less down time reduced remanufacturing costs
<ul style="list-style-type: none"> ▪ safety clutch (all types WES...) with ball mechanism 	<ul style="list-style-type: none"> ▪ low friction 	<ul style="list-style-type: none"> ▪ lower wear, less maintenance required
<ul style="list-style-type: none"> ▪ length adjustment (all types WEN...) 	<ul style="list-style-type: none"> ▪ length adjustment outside of the machine possible 	<ul style="list-style-type: none"> ▪ reduced down time of the machine
<ul style="list-style-type: none"> ▪ positive drive of the tap at the square 	<ul style="list-style-type: none"> ▪ no slipping or twisting of the tap in the adaptor 	<ul style="list-style-type: none"> ▪ prevention of tool breakage
<ul style="list-style-type: none"> ▪ extended adaptors possible 	<ul style="list-style-type: none"> ▪ manufacturing of deep lying threads or contour obstructions without special tools 	<ul style="list-style-type: none"> ▪ cost reduction

WE – Schnellwechsel-Einsatz für Spannzange mit Innenvierkant DIN6499-B
WE – Quick change adaptor for collets with drive square DIN6499-B

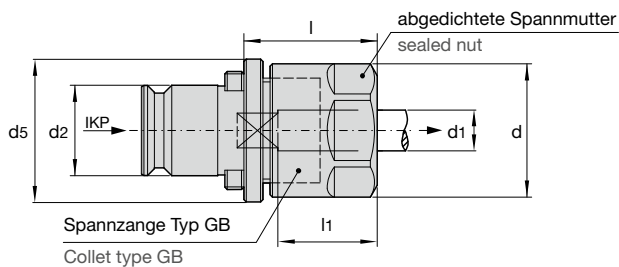

DIN
6499B

50 bar

WE1-IKP/ESX16GB
WE2-IKP/ESX25GB

Bezeichnung/Id. Nr. Designation/Id. No.	Icon 1	Icon 2	d1 x Vkt d1 x Square	Id. Nr. Id. No.	d	d2	d5	l	l1 max	Icon 3	Icon 4	
											d1	Id. Nr. Id. No.
WE1-IKP/ESX16GB 6711424	1	M4-M10	ESX16GB - 4,5x3,4	6951393	28	19	31	28	18	SW30	DS/ER16-5	6952972
			ESX16GB - 5,5x4,3	6954656							DS/ER16-6	6954177
			ESX16GB - 6,0x4,9	6951392							DS/ER16-6	6954177
			ESX16GB - 7,0x5,5	6947340							DS/ER16-7	6940533
			ESX16GB - 8,0x6,2/6,3	6946213							DS/ER16-8	6941539
			ESX16GB - 9,0x7,0/7,1	6947393							DS/ER16-9	6941992
WE2-IKP/ESX25GB 6715360	2	M8-M20	ESX25GB - 4,5x3,4	6951218	42	31	48	33,5	23	E25	DS/ER25-5	6954184
			ESX25GB - 6,0x4,9	6951544							DS/ER25-6	6953215
			ESX25GB - 7,0x5,5	6951797							DS/ER25-7	6943420
			ESX25GB - 8,0x6,2/6,3	6951214							DS/ER25-8	6943419
			ESX25GB - 9,0x7,0/7,1	6951216							DS/ER25-9	6941679
			ESX25GB - 10,0x8,0	6951215							DS/ER25-10	6943423
			ESX25GB - 11,0x9,0	6946167							DS/ER25-11	6943534
			ESX25GB - 12,0x9,0	6950343							DS/ER25-12	6943424
			ESX25GB - 14,0x11,0/11,2	6951559							DS/ER25-14	6943342
ESX25GB - 16,0x12,0/12,5	6951399	DS/ER25-16	6943422									

Dichtscheiben siehe Seite 31
 Sealing discs see page 31

Dichtscheiben und Spannzangen bitte extra bestellen.
 Please order sealing disc and collet separately.

Spannzange siehe Seite 33
 Collet see page 33

Spannschlüssel siehe Seite 27
 Wrench see page 27

Auszugsmoment Spannmuttern siehe Seite 26
 Tightening torque nut see page 26

WE – Schnellwechsel-Einsatz mit ESX-Spannzange
WE – Quick change adaptor with ESX-collet

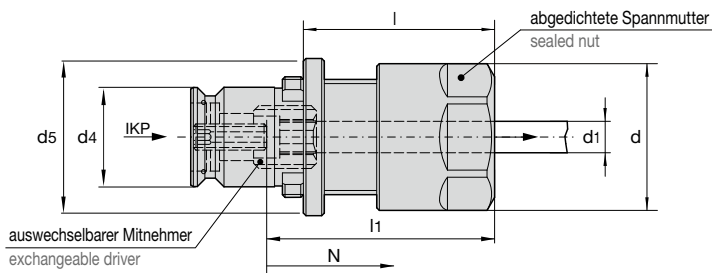

WE1-IKP/ESX 16-... WE2-IKP/ESX 25-...																						
Bezeichnung/Id. Nr. Designation/Id. No.			d	d1	d4	d5	l	l1	N			Mitnehmer Driver										
WE1-IKP/ESX16-5x4 9124567	1	M5-M12	28	5	19	30	36,5	43,5	4			BN1716 -4	EX16-IC 6931372									
WE1-IKP/ESX16-5,6x4,5 -				5,6	DS/ER16-6	BN1716-4,5																
WE1-IKP/ESX16-6x4,9 6711380				6	DS/ER16-6	BN1716-5																
WE1-IKP/ESX16-6,3x5 6711381				6,3	DS/ER16-6,5	BN1716-5																
WE1-IKP/ESX16-7x5,5 6711382				7	DS/ER16-7	BN1716-5,6																
WE1-IKP/ESX16-7,1x5,6 9095125				7,1	DS/ER16-7,5	BN1716-5,6																
WE1-IKP/ESX16-8x6,2 6711383				8	DS/ER16-8	BN1716-6,3																
WE1-IKP/ESX16-8x6,3 5014306				8	DS/ER16-8	BN1716-6,3																
WE1-IKP/ESX16-9x7/7,1 6711384				9	DS/ER16-9	BN1716-7,1																
WE1-IKP/ESX16-9x7,1 6711385				9	DS/ER16-9	BN1716-7,1																
WE1-IKP/ESX16-10x8 6711386				10	DS/ER16-10	-																
WE2-IKP/ESX25-7x5,5 6715339				2	M8-M20	42						7		31	48	48	57,5	4			BN1725-5,6	EX25-IC 6941678
WE2-IKP/ESX25-7,1x5,6 6715340												7,1		DS/ER25-7,5	BN1725-5,6							
WE2-IKP/ESX25-8x6,2/6,3 6715350												8		DS/ER25-8	BN1725-6,5							
WE2-IKP/ESX25-9x7/7,1 6715341	9	DS/ER25-9	BN1725-7,1																			
WE2-IKP/ESX25-10x8 6715342	10	DS/ER25-10	BN1725-8																			
WE2-IKP/ESX25-11x9 6715343	11	DS/ER25-11	BN1725-9																			
Id. No. 6921627	6952972	6930574																				
Id. No. 6921628	6931371	6930575																				
Id. No. 6921628	6931371	6930576																				
Id. No. 6921629	6943060	6930576																				
Id. No. 6921629	6940533	6930577																				
Id. No. 6921630	6952195	6930577																				
Id. No. 6921630	6941539	6930578																				
Id. No. 6921630	6941539	6930578																				
Id. No. 6921631	6941992	6931079																				
Id. No. 6921631	6941992	6931079																				
Id. No. 6921632	6942300	-																				
Id. No. 6921656	6943420	6943252																				
Id. No. 6921657	6943421	6943252																				
Id. No. 6921657	6943419	6943253																				
Id. No. 6921658	6941679	6941587																				
Id. No. 6921659	6943423	6931467																				
Id. No. 6921660	6943534	6943834																				

Der Einsatz wird komplett mit Spannzange, Dichtscheibe, Mitnehmer und Spannmutter geliefert.
 Adaptor includes collet, sealing disc, driver and nut.



Auszugsdrehmoment Spannmuttern siehe Seite 26
 Tightening torque nut see page 26



T...WEN Schrumpfeinsatz für HM-Gewindebohrer
T...WEN Shrink fit adaptor for carbide taps

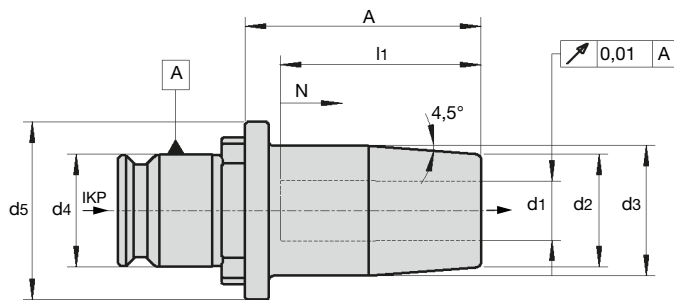

T.../WEN									
Bezeichnung/Id. Nr. Designation/Id. No.		d1	d2	d3	d4	d5	A	l1 max	N
T0600-40/WEN1 6727767	1	6	19	22	19	30	40	31	5
T0700-40/WEN1 6727768	1	7	19	22	19	30	40	31	
T0800-40/WEN1 6727769	1	8	19	22	19	30	40	32	
T0900-40/WEN1 6727783	1	9	19	22	19	30	40	33	
T1000-40/WEN1 6727770	1	10	19	22	19	30	40	34	
T0600-40/WEN2 6727798	2	6	19	22	31	48	40	31	
T0700-40/WEN2 6727799	2	7	19	22	31	48	40	31	
T0800-40/WEN2 6727800	2	8	19	22	31	48	40	32	
T0900-40/WEN2 6727801	2	9	19	22	31	48	40	33	
T1000-40/WEN2 6727779	2	10	19	22	31	48	40	34	
T1100-60/WEN2 6727773	2	11	27	34	31	48	60	46	
T1200-60/WEN2 6727802	2	12	27	34	31	48	60	46	
T1400-60/WEN2 6727772	2	14	27	34	31	48	60	48	
T1600-60/WEN2 6727803	2	16	27	34	31	48	60	49	



Schrumpfeinsatz für Gewindeschneidfutter. Nur für HM-Gewindebohrer mit Schafttoleranz H6 geeignet. Auf den Vierkant am Schaft kann verzichtet werden
 Ausführung für HSS und HM auf Anfrage
 Alle Schrumpfeinsätze sind auch für zentrale Kühlmitteldurchführung geeignet
 Shrink Fit adaptors for tapping chucks. For carbide taps with shank tolerance H6 only. The square at the shank is not required
 For HSS and HM on request
 All shrinking adaptors are suitable for central coolant feed

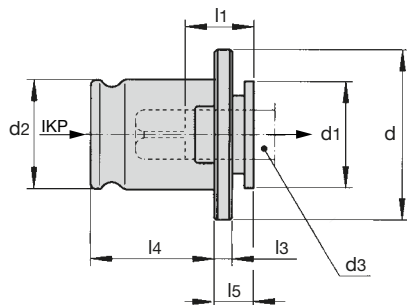

WE..., DIN							
Bezeichnung Designation		WE 0	WE 1	WE 2	WE 3	WE 4	WE 40
		M1-M10	M3-M12	M8-M20	M14-M33	M22-M48	M6-M18
	d3	2,5-8	3,5-11,3	7-18	11-28	18-36	6-14
		0	1 + 32	2	3	4	40
	d	22	30	48	70	92	40
	d1	13	19	30	48	60	25
	d2	13	19	31	48	60	26
	l1	15	17	30	44	71	30
	l3	4	4	5	6	13	5
	l4	19,5	21,5	35	55,5	63	32
	l5	7	7	11	14	42	13

Für Gewindebohrer nach DIN
 For taps according to DIN

D	VKT	DIN 371	DIN 374	DIN 376	Id. No.	Id. No.	Id. No.	Id. No.	Id. No.	Id. No.
2,80	2,10	M1-M2,5	M3,5-M4		6722536					
3,50	2,70	M3	M5		6722546	6711244				
4,00	3,00	M3,5			6722551	6711248				
4,50	3,40	M4	M6		6722556	6711253				6721907
5,50	4,50		M7		6722564	6711313				
6,00	4,90	M4,5			6722568	6711268				6721886
6,00	4,90	M5			6722568	6711268				6721886
6,00	4,90	M6	M8		6722568	6711268	6715185			6721886
7,00	5,50	M7	M9-M10		6722576	6711279	6715189			6721888
8,00	6,20	M8			6722580	6711287	6715196			6721889
9,00	7,00	M9	M12			6711294	6715203			6721892
10,00	8,00	M10				6711302	6715208			6721896
11,00	9,00		M14			6711308	6715211	6718393		6721899
12,00	9,00	M12	M16				6715215	6718395		6721901
14,00	11,00		M18				6715224	6718400		6721903
16,00	12,00		M20				6715232	6718404		
18,00	14,50		M22-M24				6715242	6718411	6720626	
20,00	16,00		M27					6718415	6720627	
22,00	18,00		M30					6718419	6720628	
25,00	20,00		M33					6718425	6720630	
28,00	22,00		M36					6718428	6720632	
32,00	24,00		M39-M42						6720635	
36,00	29,00		M45-M48						6720637	

Auch für zentrale Kühlmitteldurchführung (IKP) geeignet
 Also suitable for central coolant feed (IKP)

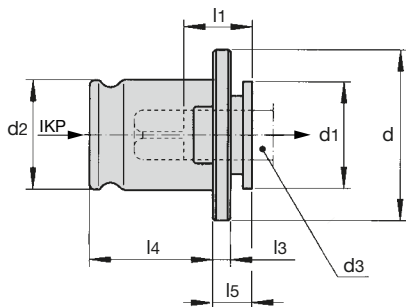

WE..., ISO							
Bezeichnung Designation		WE 0	WE 1	WE 2	WE 3	WE 4	WE 40
		M1-M10	M3-M12	M8-M20	M14-M33	M22-M48	M6-M18
	d3	2,5-8	3,5-11,3	7-18	11-28	18-36	6-14
		0	1 + 32	2	3	4	40
	d	22	30	48	70	92	40
	d1	13	19	30	48	60	25
	d2	13	19	31	48	60	26
	l1	15	17	30	44	71	30
	l3	4	4	5	6	13	5
	l4	19,5	21,5	35	55,5	63	32
	l5	7	7	11	14	42	13

Für Gewindebohrer nach ISO
For taps according to ISO

D	VKT	ISO529	ISO529 verstärkt reinforced	Id. No.	Id. No.	Id. No.	Id. No.	Id. No.	Id. No.
2,24	1,80	M3		6722583	6711235				
2,50	2,00	M3,5	M2	6722533	6711236				
2,80	2,24		M2,2-M2,5	6722537	6711239				
3,15	2,50	M4	M3	6722540	6711242				
3,55	2,80	M4,5	M3,5	6722547	6711245				
4,00	3,15	M5	M4	6722552	6711249				
4,50	3,55	M6		6722557	6711254				
5,00	4,00		M5	6722562	6711260				
5,60	4,50	M7		6722566	6711264	6715183			
6,30	5,00	M8	M6	6722572	6711274				
7,10	5,60	M9	M7	6722577	6711281	6715191			
8,00	6,30	M10	M8	6722581	6711288	6715197			6721890
9,00	7,10	M12			6711295	6715204			6721893
10,00	8,00		M10		6711302	6715208			6721896
11,20	9,00	M14			6711310	6715213	6718394		6721900
12,50	10,00	M16				6715218	6718397		6721902
14,00	11,20	M18				6715225	6718401		6721906
16,00	12,50	M22				6715233	6718405		
18,00	14,00	M24				6715241	6718410	6720641	
20,00	16,00	M27					6718415	6720627	
22,40	18,00	M33					6718420	6720640	
25,00	20,00	M36					6718425	6720630	
28,00	22,40	M39					6718429	6720639	
31,50	25,00	M45-M48						6720642	
35,50	28,00	M52-M56						6720643	

Auch für zentrale Kühlmitteldurchführung (IKP) geeignet
Also suitable for central coolant feed (IKP)



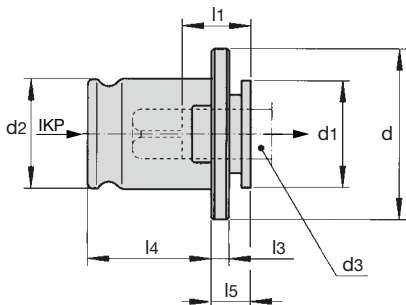

WE...,JIS							
Bezeichnung Designation		WE 0	WE 1	WE 2	WE 3	WE 4	WE 40
		M1-M10	M3-M12	M8-M20	M14-M33	M22-M48	M6-M18
d3		2,5-8	3,5-11,3	7-18	11-28	18-36	6-14
		0	1 + 32	2	3	4	40
d		22	30	48	70	92	40
d1		13	19	30	48	60	25
d2		13	19	31	48	60	26
l1		15	17	30	44	71	30
l3		4	4	5	6	13	5
l4		19,5	21,5	35	55,5	63	32
l5		7	7	11	14	42	13

Für Gewindebohrer nach JIS
 For taps according to JIS

D	VKT	JIS		Id. No.	Id. No.	Id. No.	Id. No.	Id. No.	Id. No.
3,5	2,0	M2,5							
4,0	3,2	M3-M3,5		6722586	6711320				
5,0	4,0	M4-M4,5		6722562	6711260				
5,5	4,5	M5		6722564	6711313				x
6,0	4,5	M6		6722582	6711266	6715184			x
6,2	5,0	M7-M8		6722571	6711317	6715247			6721904
7,0	5,5	M9-M10		6722576	6711279	6715189			6721888
8,0	6,5	M11			6711318	6715246			x
8,5	6,5	M12			6711292	6715248			x
10,5	8,0	M14			6711304	6715209	6718391		6721897
12,5	10,0	M16				6715218	6718397		6721902
13,0	10,0	M17				6715221	6718398		x
14,0	11,0	M18				6715224	6718400		6721903
15,0	12,0	M20				6715230	6718403		
17,0	13,0	M22				6715243	x	6720646	
19,0	15,0	M24					6718434	x	
20,0	15,0	M27					6718414	6720644	
21,0	17,0	M28					x	x	
23,0	17,0	M30					6718435	x	
24,0	19,0	M32					9117836	x	
25,0	19,0	M33					x	x	
26,0	21,0	M34-M35					x	x	
28,0	21,0	M36-M38					6718445	x	
30,0	23,0	M39-M40						x	
32,0	26,0	M42						x	
35,0	26,0	M45						x	
38,0	29,0	M48						x	

Auch für zentrale Kühlmitteldurchführung (IKP) geeignet
 Also suitable for central coolant feed (IKP)

x - auf Anfrage
 x - on request

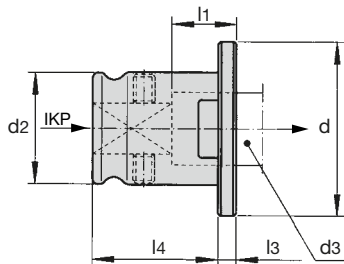

WEK erweiterter Spannbereich mit Klemmschrauben extended clamping range with set screws									
Bezeichnung Designation		WEK1		WEK2		WEK3		WEK4	
				M16		M27 - M30		M39 - M48	
		d3		11,3-12		18-22		28-36	
				1 + 32		2		3	
		d		30		48		70	
		d2		19		31		48	
		l1		17		30		44	
		l3		4		5		6	
		l4		21,5		35		55,5	
		63							
Für Gewindebohrer nach DIN For taps according to DIN									
D	VKT	DIN 371	DIN 374	DIN 376	Id. No.	Id. No.	Id. No.	Id.No.	
11,00	9,00		M14		6711375				
12,00	9,00	M12	M16		6711374				
14,00	11,00		M18						
16,00	12,00		M20			6715315			
18,00	14,50		M22-M24			6715317			
20,00	16,00		M27			6715309			
22,00	18,00		M30			6715310			
25,00	20,00		M33				6718507		
28,00	22,00		M36				6718485		
32,00	24,00		M39-M42				6718479		
36,00	29,00		M45-M48				6718483	6720658	
40,00	32,00		M52					6720651	
45,00	35,00		M56-M60					6720652	



Auch für zentrale Kühlmitteldurchführung (IKP) geeignet
 Also suitable for central coolant feed (IKP)

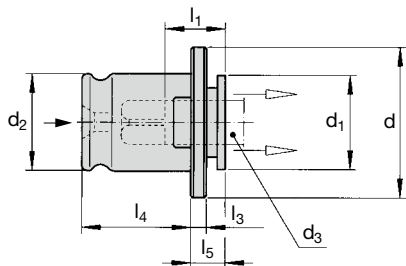



WE...KP, DIN

für Gewindebohrer, -former ohne innere Kühlmittelzufuhr
 for taps, roll former without internal coolant supply

Bezeichnung Designation	WE 1-KP	WE 2-KP	WE 3-KP
	M3-M12	M8-M20	M14-M33
d3	3,5-11,3	7-18	11-28
	1+32	2	3
d	30	48	70
d1	19	30	48
d2	19	31	48
l1	17	30	44
l3	4	5	6
l4	21,5	35	55,5
l5	7	11	14

Für Gewindebohrer nach DIN
 For taps according to DIN

D	VKT	DIN 371	DIN 374	DIN 376	Id. No.	Id. No.	Id. No.
2,80	2,10	M1-M2,5	M3,5-M4		6711520		
3,50	2,70	M3	M5		6711506		
4,00	3,00	M3,5			6711507		
4,50	3,40	M4	M6		6711503		
5,50	4,50		M7		-		
6,00	4,90	M4,5			6711504		
6,00	4,90	M5			6711504		
6,00	4,90	M6	M8		6711504		
7,00	5,50	M7	M9-M10		6711502	6715432	
8,00	6,20	M8			6711495	6715412	
9,00	7,00	M9	M12		6711497	6715414	
10,00	8,00	M10	M10		6711499	6715416	
11,00	9,00		M14		6711500	6715417	6718596
12,00	9,00	M12	M16			6715419	6718598
14,00	11,00		M18			6715421	6718591
16,00	12,00		M20			6715423	6718601
18,00	14,50		M22-M24			6715426	6718589
20,00	16,00		M27				6718594
22,00	18,00		M30				6718592
25,00	20,00		M33				6718595
28,00	22,00		M36				6718596

WRE – Schnellwechsel-Einsatz
WRE – Quick change adaptor

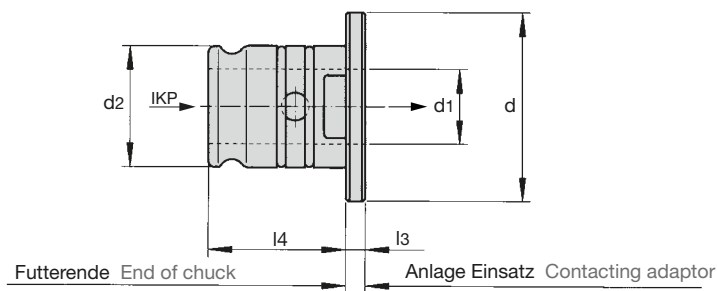

WRE Reduziereinsatz Reducing adaptor								
Bezeichnung Designation			d	d1	d2	l3	l4	Id. No.
WRE1/0	1	0	30	13	19	4	21,5	6711434
WRE2/0	2	0	48	13	31	5	35	6715362
WRE2/1	2	1	48	19	31	5	35	6715363
WRE3/1	3	1	70	19	48	6	55,5	6718562
WRE3/2	3	2	70	31	48	6	55,5	6718563
WRE4/2	4	2	92	31	60	13	63	6720688
WRE4/3	4	3	92	48	60	13	63	6720689

Auch für zentrale Kühlmitteldurchführung (IKP) geeignet
 Also suitable for central coolant feed (IKP)



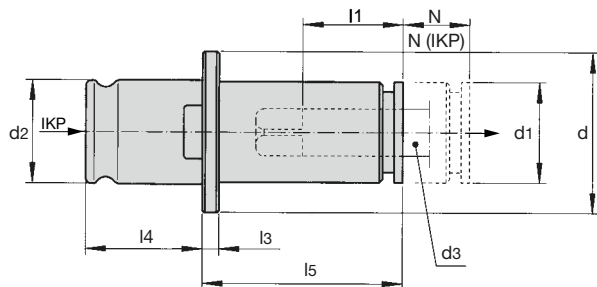

WEN..., DIN							
Bezeichnung Designation		WEN 0	WEN 1*	WEN 2*	WEN 3*	WEN 4*	WEN 40*
		M1-M10	M3-M12	M8-M20	M14-M33	M22-M48	M6-M18
d3		2,5-7,2	3,5-11,3	7-18	11-28	18-36	6-14
		0	1 + 32	2	3	4	40
d		22	30	48	70	92	40
d1		13	19	30	48	60	25
d2		13	19	31	48	60	26
l1		15	17	30	44	71	30
l3		4	4	5	6	13	5
l4		19,5	21,5	35	55,5	63	32
l5		29	34	60	83	137	54
		8	10	15	25	25	15
	(IKP)	-	6,5	14	25	25	10

Für Gewindebohrer nach DIN
For taps according to DIN

D	VKT	DIN 371	DIN 374	DIN 376	Id. No.	Id. No.	Id. No.	Id. No.	Id. No.	Id. No.
2,80	2,10	M1-M2,5	M3,5-M4		6722760					
3,50	2,70	M3	M5		6722763	6711829				
4,00	3,00	M3,5			6722766	6711833				
4,50	3,40	M4	M6		6722769	6711836				6721945
5,50	4,50		M7		6722775	6711877				
6,00	4,90	M4,5			6722778	6711844				
6,00	4,90	M5			6722778	6711844				
6,00	4,90	M6	M8		6722778	6711844	6715688			6721920
7,00	5,50	M7	M9-M10		6722784	6711852	6715691			6721923
8,00	6,20	M8				6711857	6715693			6721925
9,00	7,00	M9	M12			6711863	6715697			6721929
10,00	8,00	M10	M10			6711871	6715701			6721933
11,00	9,00		M14			6711874	6715704	6718774		6721936
12,00	9,00	M12	M16				6715707	6718776		6721938
14,00	11,00		M18				6715712	6718780		6721940
16,00	12,00		M20				6715719	6718783		
18,00	14,50		M22-M24				6715725	6718788	6720728	
20,00	16,00		M27					6718790	6720729	
22,00	18,00		M30					6718792	6720730	
25,00	20,00		M33					6718795	6720731	
28,00	22,00		M36					6718797	6720733	
32,00	24,00		M39-M42						6720736	
36,00	29,00		M45-M48						6720738	

* Auch für zentrale Kühlmitteldurchführung (IKP) geeignet
* Also suitable for central coolant feed (IKP)

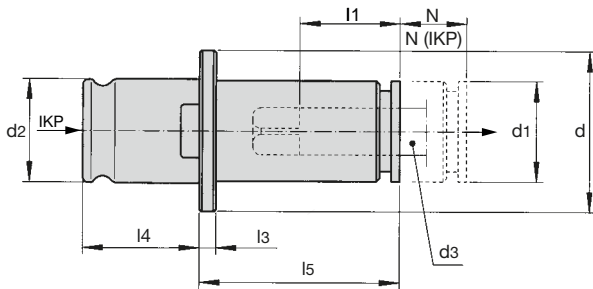

WEN..., ISO							
Bezeichnung Designation		WEN 0	WEN 1*	WEN 2*	WEN 3*	WEN 4*	WEN 40*
		M1-M10	M3-M12	M8-M20	M14-M33	M22-M48	M6-M18
	d3	2,5-7,2	3,5-11,3	7-18	11-28	18-36	6-14
		0	1+32	2	3	4	40
	d	22	30	48	70	92	40
	d1	13	19	30	48	60	25
	d2	13	19	31	48	60	26
	l1	15	17	30	44	71	30
	l3	4	4	5	6	13	5
	l4	19,5	21,5	35	55,5	63	32
	l5	29	34	60	83	137	54
	N	8	10	15	25	25	15
	(IKP)	-	6,5	14	25	25	10

Für Gewindebohrer nach ISO
For taps according to ISO

D	VKT	ISO529	ISO529 verstärkt reinforced	Id. No.	Id. No.	Id. No.	Id. No.	Id. No.	Id. No.
2,24	1,80	M3		6722789	6711823				
2,50	2,00	M3,5	M2	6722758	6711824				
2,80	2,24		M2,2-M2,5	6722761	6711827				
3,15	2,50	M4	M3	6722762	6711828				
3,55	2,80	M4,5	M3,5	6722764	6711830				
4,00	3,15	M5	M4	6722767	6711834				
4,50	3,55	M6		6722770	6711837				
5,00	4,00		M5	6722772	6711839				
5,60	4,50	M7		6722777	6711842				
6,30	5,00	M8	M6	6722782	6711847	6715689			6721921
7,10	5,60	M9	M7	6722785	6711853				
8,00	6,30	M10	M8		6711858	6715694			6721926
9,00	7,10	M12			6711864	6715698			6721930
10,00	8,00		M10		6711871	6715701			6721933
11,20	9,00	M14			6711876	6715706	6718775		6721937
12,50	10,00	M16				6715709	6718777		6721939
14,00	11,20	M18				6715713	6718781		6721944
16,00	12,50	M22				6715720	6718784		
18,00	14,00	M24				6715724	6718787	6720742	
20,00	16,00	M27					6718790	6720729	
22,40	18,00	M33					6718793	6720741	
25,00	20,00	M36					6718795	6720731	
28,00	22,40	M39						6720740	
31,50	25,00	M45-M48						6720743	

* Auch für zentrale Kühlmitteldurchführung (IKP) geeignet
* Also suitable for central coolant feed (IKP)

WEN – Schnellwechsel-Einsatz
WEN – Quick change adaptor

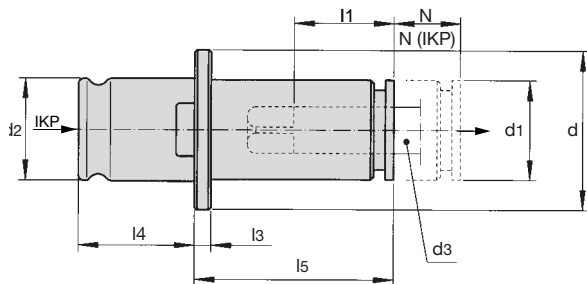

WEN..., JIS							
Bezeichnung Designation		WEN 0	WEN 1*	WEN 2*	WEN 3*	WEN 4*	WEN 40*
		M1-M10	M3-M12	M8-M20	M14-M33	M22-M48	M6-M18
d3		2,5-7,2	3,5-11,3	7-18	11-28	18-36	6-14
		0	1 + 32	2	3	4	40
d		22	30	48	70	92	40
d1		13	19	30	48	60	25
d2		13	19	31	48	60	26
l1		15	17	30	44	71	30
l3		4	4	5	6	13	5
l4		19,5	21,5	35	55,5	63	32
l5		29	34	60	83	137	54
		8	10	15	25	25	15
(IKP)		-	6,5	14	25	25	10

Für Gewindebohrer nach JIS
 For taps according to JIS

D	VKT	JIS	Id. No.	Id. No.	Id. No.	Id. No.	Id. No.	Id. No.
3,5	2,0	M2,5	x					
4,0	3,2	M3 – M3,5	x	x				
5,0	4,0	M4 – M4,5	6722772	6711839				
5,5	4,5	M5	6722775	6711877				
6,0	4,5	M6	6722788	6711843				6721919
6,2	5,0	M7 – M8	6722781	6711878				6721941
7,0	5,5	M9 – M10	6722784	6711852	6715691			6721923
8,0	6,5	M11		x	6715727			x
8,5	6,5	M12		6711862	6715728			6721943
10,5	8,0	M14		6711872	6715702			6721934
12,5	10,0	M16			6715709	6718777		6721939
13,0	10,0	M17			6715710	6718778		x
14,0	11,0	M18			6715712	6718780		6721940
15,0	12,0	M20			6715718	6718782		
17,0	13,0	M22			6715726	x		
19,0	15,0	M24				x	x	
20,0	15,0	M27				x	x	
21,0	17,0	M28				x	x	
23,0	17,0	M30				x	x	
24,0	19,0	M32				x	x	
25,0	19,0	M33				x	x	
26,0	21,0	M34 – M35				x	x	
28,0	21,0	M36 – M38				x	x	
30,0	23,0	M39 – M40					x	
32,0	26,0	M42					x	
35,0	26,0	M45					x	
38,0	29,0	M48						

* Auch für zentrale Kühlmitteldurchführung (IKP) geeignet
 * Also suitable for central coolant feed (IKP)

x - auf Anfrage
 x - on request

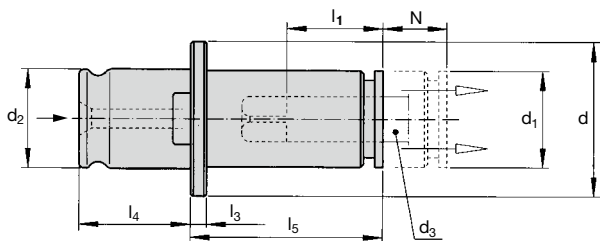

WEN...-KP, DIN

für Gewindebohrer, -former ohne innere Kühlmittelzufuhr
for taps, roll former without internal coolant supply

Bezeichnung Designation		WEN 1-KP	WEN 2-KP	WEN 3-KP
		M3-M12	M8-M20	M14-M33
	d3	3,5-11,3	7-18	11-28
		1	2	3
	d	30	48	70
	d1	19	30	48
	d2	19	31	48
	l1	17	30	44
	l3	4	5	6
	l4	21,5	35	55,5
	l5	34	60	83
		6,5	14	25

Für Gewindebohrer nach DIN
For taps according to DIN

D	VKT	DIN 371	DIN 374	DIN 376	Id. No.	Id. No.	Id. No.
3,50	2,70	M3	M5		6713054		
4,00	3,00	M3,5			6713055		
4,50	3,40	M4	M6		6713051		
5,50	4,50		M7		-		
6,00	4,90	M4,5			6713052		
6,00	4,90	M5			6713052		
6,00	4,90	M6	M8		6713052		
7,00	5,50	M7	M9-M10		6713050	6716477	
8,00	6,20	M8			6713042	6716456	
9,00	7,00	M9	M12		6713044	6716458	
10,00	8,00	M10	M10		6713046	6716460	
11,00	9,00		M14		6713047	6716461	6719217
12,00	9,00	M12	M16			6716463	6719225
14,00	11,00		M18			6716465	6719218
16,00	12,00		M20			6716467	6719228
18,00	14,50		M22-M24			6716470	6719216
20,00	16,00		M27				6719221
22,00	18,00		M30				6719219
25,00	20,00		M33				6719222
28,00	22,00		M36				6719223



WEN – Schnellwechsel-Einsatz
WEN – Quick change adaptor

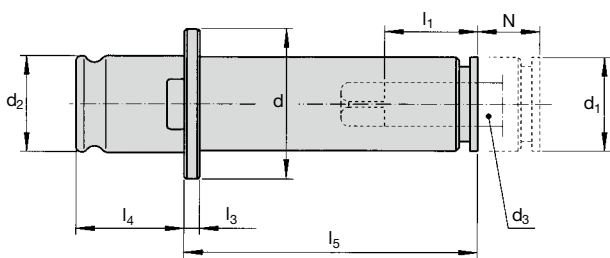

WEN-...																							
Bezeichnung Designation		d3			d	d1	d2	l1	l3	l4	l5												
WEN0-...	M 1 – M 10	2,5 - 7,2	0	8	22	13	13	15	4	19,5	40	50	60	70	80	90	100	110	120				
WEN1-...	M 3 – M 12	3,5 - 11,3	1 + 32	10	30	19	19	17	4	21,5	40	50	60	70	80	90	100	110	120	130	140		
WEN2-...	M 8 – M 20	7,0 - 18	2	15	48	31	31	30	5	35	70	80	90	100	110	120	130	140	150	160			
WEN3-...	M14 – M 33	11 - 28	3	25	70	48	48	44	6	55,5	100	120	140	160	180								
WEN40-...	M 6 – M 18	6,0 - 14	40	15	40	25	26	30	5	32	60	70	80	90	100	110	120	130	140	150			

Bestellbeispiel Example for ordering
 Bilz WEN 1-90-7x5,5

WEN – Schnellwechsel-Einsatz
WEN – Quick change adaptor

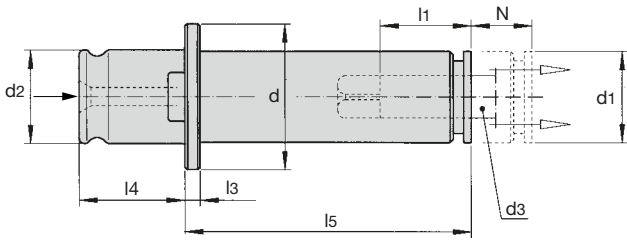

WEN...-KP...

für Gewindebohrer, -former ohne innere Kühlmittelzufuhr
 for taps, roll former without internal coolant supply

Bezeichnung Designation		d3		N +	d	d1	d2	l1	l3	l4	l5																
											40	50	60	70	80	90	100	110	120	130	140	150	160	170	180		
WEN1-KP...	M 3 - M 12	3,5 - 11,3	1	6,5	30	19	19	17	4	21,5	40	50	60	70	80	90	100	110	120	130	140						
WEN2-KP...	M 8 - M 20	7,0 - 18	2	14	48	30	31	30	5	35	70	80	90	100	110	120	130	140	150	160							
WEN3-KP...	M14 - M 33	11 - 28	3	25	70	48	48	44	6	55,5	100	120	140	160	180												

Bestellbeispiel Example for ordering
 Bilz WEN2-KP-70-11x9

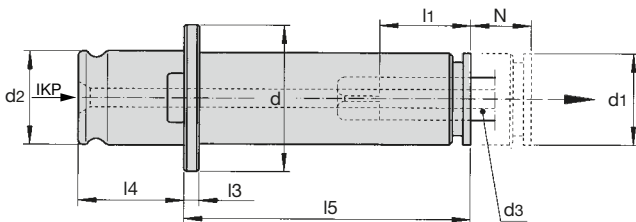

WEN...-IKP...

für Gewindebohrer, -former mit innere Kühlmittelzufuhr
 for taps, roll former with internal coolant supply

Bezeichnung Designation		d3		N +	d	d1	d2	l1	l3	l4	l5															
											40	50	60	70	80	90	100	110	120	130	140	150	160	170	180	
WEN1-IKP...	M 3 - M 12	3,5 - 11,3	1	6,5	30	19	19	17	4	21,5	40	50	60	70	80	90	100	110	120	130	140					
WEN2-IKP...	M 8 - M 20	7,0 - 18	2	14	48	30	31	30	5	35	70	80	90	100	110	120	130	140	150	160						
WEN3-IKP...	M14 - M 33	11 - 28	3	25	70	48	48	44	6	55,5	100	120	140	160	180											

Auch für zentrale Kühlmitteldurchführung (IKP) geeignet
 Also suitable for central coolant feed (IKP)

Bestellbeispiel Example for ordering
 Bilz WEN1-IKP-100-6x4,9



WENE – Schnellwechsel-Einsatz
WENE – Quick change adaptor

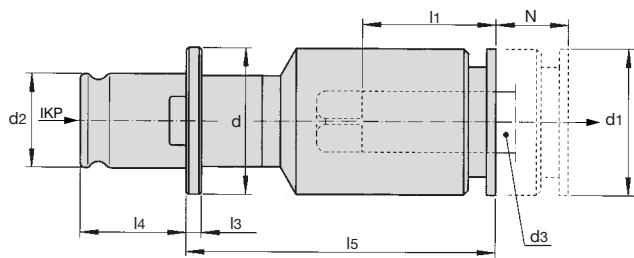

WENE..., DIN

erweiterter Spannbereich
 extended clamping range



Bezeichnung Designation		WENE 0	WENE 1	WENE 2
		M12-M14	M16-M18	M27-M30
d3		7,2-11	11,3-14	18-22
		0	1-32	2
d		22	30	48
d1		19	30	48
d2		13	19	31
l1		17	30	44
l3		4	4	5
l4		19,5	21,5	35
l5		48	62	102
		8	10	15

Für Gewindebohrer nach DIN
 For taps according to DIN

D	VKT	DIN 371	DIN 374	DIN 376	Id. No.	Id. No.	Id. No.
8,00	6,20	M8			6722797		
9,00	7,00	M9	M12		6722801		
10,00	8,00	M10	M10		6722807		
11,00	9,00		M14		6722808		
12,00	9,00	M12	M16			6711920	
14,00	11,00		M18			6711924	
18,00	14,50		M22-M24				6715777
20,00	16,00		M27				6715771
22,00	18,00		M30				6715774

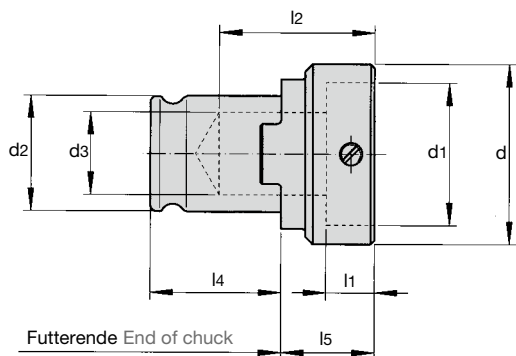
Auch für zentrale Kühlmitteldurchführung (IKP) geeignet
 Also suitable for central coolant feed (IKP)



WE/SCH										
Zur Aufnahme von Schneideisen DIN-EN 22568										
For dies DIN-EN 22568										
Bezeichnung Designation					WE1	WE2	WE3			
 d3  d d2 l1 l2 l4 l5					M1 – M15	M3 – M20	M10 – M36			
					12,5 – 14,2	18 – 22	25 – 37			
					1 + 32	2	3			
					25 – 48	30 – 57	60 – 82			
					19	31	48			
					4,8 – 13	4,8 – 17	10 – 23			
					28 – 38	55 – 64	85 – 93			
					21,5	35	55,5			
14 – 24	20 – 29	30 – 38								
SCH	M...	M... fein/fine	Whitworth	Whitworth G	Id. No.	l2	Id. No.	l2	Id. No.	l2
16 x 5	M 1 - M 2,6	M 1 - M 2,6			6711408	28				
20 x 5	M 3 - M 4	M 3 - M 6			6711409	28	6774094	55		
20 x 7	M 5 + M 6		1/4"		6711410	30	6715354	56		
25 x 9	M 7 - M 9	M 7 - M 9	5/16"		6711411	33	6774096	55		
30 x 11	M10 + M11	M10 + M11	3/8" + 7/16"		6711412	35	6715355	57	6718541	85
38 x 10		M12 - M15		G 1/8" + G 1/4"	6711413	34	6774100	56	6718542	83
38 x 14	M12 + M14		1/2"		6711414	38	6774102	60	6718543	87
45 x 14		M16 - M20		G 3/8" + G 1/2"			6774104	60	6718544	87
45 x 18	M16 - M20		5/8" + 3/4"				6774106	64	6718546	91
55 x 16		M22 - M26	7/8" + 1"	G 5/8"			6774108	62	6718547	85
55 x 22	M22 + M24								6718549	90
65 x 18		M27 - M36		G 3/4" + G 1"					6718550	87
65 x 25	M27 - M36		1 1/8" + 1 3/8"						6718551	93

WES – Schnellwechsel-Einsatz mit Sicherheitskupplung
WES – Quick change adaptor with safety clutch

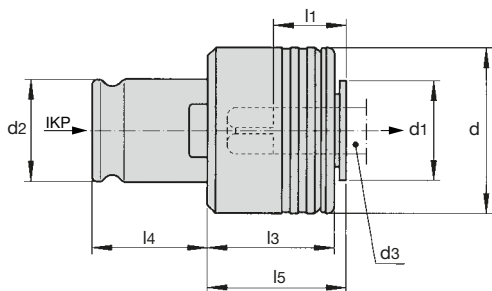

WES...B, DIN							
Bezeichnung Designation		WES 0 B	WES 1 B	WES 2 B	WES 3 B	WES 4 B	WES 40 B
		M1-M10	M3-M12	M8-M20	M14-M33	M22-M48	M6-M18
	d3	2,5-8	3,5-11,3	7-18	11-28	18-36	6-14
		0	1+32	2	3	4	40
	d	23	32	50	72	95	40
	d1	13	19	30	48	60	25
	d2	13	19	31	48	60	26
	l1	15	17	30	44	71	30
	l3	20	25	31	41	61	27
	l4	19,5	21,5	35	55,5	63	32
	l5	21	25	34	45	68	30

Für Gewindebohrer nach DIN
 For taps according to DIN

D	VKT	DIN 371	DIN 374	DIN 376	Id. No.	Id. No.	Id. No.	Id. No.	Id. No.	Id. No.
2,50	2,10	M1			6722736					
2,50	2,10	M1,1								
2,50	2,10	M1,2								
2,50	2,10	M1,4			9075774					
2,50	2,10	M1,6			9075781					
2,50	2,10	M1,8								
2,80	2,10	M2			6722737					
2,80	2,10	M2,2								
2,80	2,10	M2,5			9070010					
2,80	2,10		M3,5							
2,80	2,10		M4		6722648	6711571				
3,50	2,70	M3			6722739	6711785				
3,50	2,70		M5		6722747	6711796				
4,00	3,00	M3,5			6722740	6711786				
4,50	3,40	M4			6722742	6711788				
4,50	3,40		M6		6722749	6711798				6722161
5,50	4,50		M7		6722681	6711655				
6,00	4,90	M4,5								
6,00	4,90	M5			6722743	6711790				
6,00	4,90	M6			6722750	6711799				6722146
6,00	4,90		M8		6722753	6711804	6715677			6721915
7,00	5,50	M7				6711801				
7,00	5,50		M9							
7,00	5,50		M10		6722692	6711614	6715492			6722148
8,00	6,20	M8			6722696	6711624	6715498			6722149
9,00	7,00	M9								
9,00	7,00		M12			6711633	6715503			6722151
10,00	8,00	M10				6711646	6715511			6722153

Auch für zentrale Kühlmitteldurchführung (IKP) geeignet
 Also suitable for central coolant feed (IKP)



WES – Schnellwechsel-Einsatz mit Sicherheitskupplung
WES – Quick change adaptor with safety clutch

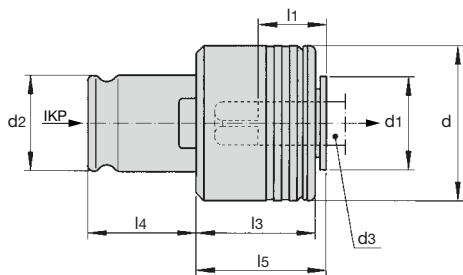

WES...B, DIN							
Bezeichnung Designation		WES 0 B	WES 1 B	WES 2 B	WES 3 B	WES 4 B	WES 40 B
		M1-M10	M3-M12	M8-M20	M14-M33	M22-M48	M6-M18
	d3	2,5-8	3,5-11,3	7-18	11-28	18-36	6-14
		0	1+32	2	3	4	40
	d	23	32	50	72	95	40
	d1	13	19	30	48	60	25
	d2	13	19	31	48	60	26
	l1	15	17	30	44	71	30
	l3	20	25	31	41	61	27
	l4	19,5	21,5	35	55,5	63	32
	l5	21	25	34	45	68	30

Für Gewindebohrer nach DIN
 For taps according to DIN

D	VKT	DIN 371	DIN 374	DIN 376	Id. No.	Id. No.	Id. No.	Id. No.	Id. No.	Id. No.
11,00	9,00			M14		6711793	6715514	6718671		6722154
12,00	9,00	M12					6715672			
12,00	9,00			M16			6715521	6718673		6722157
14,00	11,00			M18			6715532	6718677		6722159
16,00	12,00			M20			6715543	6718680		
18,00	14,50			M22			6715676	6718764	6720713	
18,00	14,50			M24			6715680	6718770	6720720	
20,00	16,00			M27				6718689	6720714	
22,00	18,00			M30				6718766	6720930	
25,00	20,00			M33				6718767	6720715	
28,00	22,00			M36				6718768	6720933	
32,00	24,00			M39					6720716	
32,00	24,00			M42					6720723	
36,00	29,00			M45					6720717	
36,00	29,00			M48					6720724	

Auch für zentrale Kühlmitteldurchführung (IKP) geeignet
 Also suitable for central coolant feed (IKP)



WES – Schnellwechsel-Einsatz mit Sicherheitskupplung
WES – Quick change adaptor with safety clutch

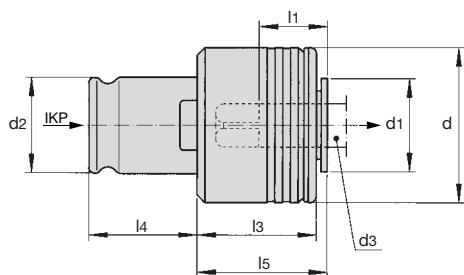

WES...B, ISO

Bezeichnung Designation		WES 0 B	WES 1 B	WES 2 B	WES 3 B	WES 4 B	WES 40 B
		M1-M10	M3-M12	M8-M20	M14-M33	M22-M48	M6-M18
	d3	2,5-8	3,5-11,3	7-18	11-28	18-36	6-14
		0	1+32	2	3	4	40
	d	23	32	50	72	95	40
	d1	13	19	30	48	60	25
	d2	13	19	31	48	60	26
	l1	15	17	30	44	71	30
	l3	20	25	31	41	61	27
	l4	19,5	21,5	35	55,5	63	32
	l5	21	25	34	45	68	30

Für Gewindebohrer nach ISO For taps according to ISO

D	VKT	ISO 529	ISO 529 verstärkt reinforced	Id. No.	Id. No.	Id. No.	Id. No.	Id. No.
2,24	1,80	M3		6722703	6711568			
2,50	2,00		M2	6722645	6711569			
2,50	2,00	M3,5		6722645	6711569			
2,80	2,24		M2,2	6722649	6711572			
2,80	2,24		M2,5	6722649	6711784			
3,15	2,50	M4		6722746	6711795			
3,15	2,50		M3	6722738	6711576			
3,55	2,80	M4,5		6722660				
3,55	2,80		M3,5	6722660	6711581			
4,00	3,15	M5		6722748	6711797			
4,00	3,15		M4	6722741	6711787			
4,50	3,55	M6		6722671	6711588			
5,00	4,00		M5	6722676	6711596			
5,60	4,50	M7		6722683	6711600			
6,30	5,00	M8		6722751	6711800	6715489		6722147
6,30	5,00		M6	6722744	6711791	6715669		
7,10	5,60	M9	M7	6722693	6711615			
8,00	6,30	M10		6722752	6711802	6715678		6721916
8,00	6,30		M8	6722745	6711792	6715670		6722150
9,00	7,10	M12			6711634	6715504		6722152
10,00	8,00		M10		6711646	6715511		6722153
11,20	9,00	M14			6711653	6715517	6718672	6722156
12,50	10,00	M16				6715524	6718675	6722158
14,00	11,20	M18				6715673	6718763	6722160
14,00	11,20	M20				6715679	6718769	
16,00	12,50	M22				6715674	6718681	
18,00	14,00	M24				6715675	6718685	6720944
20,00	16,00	M27					6718689	6720714
20,00	16,00	M30					6718771	6720721
22,40	18,00	M33					6718693	6720943
25,00	20,00	M36					6718772	6720722
28,00	22,40	M39					6718702	6720718
28,00	22,40	M42						6720725
31,50	25,00	M45						6720719
31,50	25,00	M48						6720726
35,50	28,00	M52-M56						6720946

Auch für zentrale Kühlmitteldurchführung (IKP) geeignet
 Also suitable for central coolant feed (IKP)

WES – Schnellwechsel-Einsatz mit Sicherheitskupplung
WES – Quick change adaptor with safety clutch

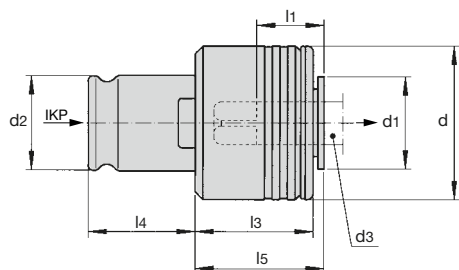

WES...B, JIS							
Bezeichnung Designation		WES 0 B	WES 1 B	WES 2 B	WES 3 B	WES 4 B	WES 40 B
		M1-M10	M3-M12	M8-M20	M14-M33	M22-M48	M6-M18
	d3	2,5-8	3,5-11,3	7-18	11-28	18-36	6-14
		0	1+32	2	3	4	40
	d	23	32	50	72	95	40
	d1	13	19	30	48	60	25
	d2	13	19	31	48	60	26
	l1	15	17	30	44	71	30
	l3	20	25	31	41	61	27
	l4	19,5	21,5	35	55,5	63	32
	l5	21	25	34	45	68	30

Für Gewindebohrer nach JIS
 For taps according to JIS

D	VKT	JIS	Id. No.	Id. No.	Id. No.	Id. No.	Id. No.	Id. No.
3,5	2,0	M2,5						
4,0	3,2	M3-M3,5	6722720	6711663				
5,0	4,0	M4-M4,5	6722676	6711596				
5,5	4,5	M5	6722681	6711655				
6,0	4,5	M6	6722697	6711602				
6,2	5,0	M7-M8	6722687	6711659	6715558			x
7,0	5,5	M9-M10	6722692	6711614	6715492			6722148
8,0	6,5	M11		6711660	6715557			x
8,5	6,5	M12		6711631	6715559			x
10,5	8,0	M14		6711648	6715512	6718669		x
12,5	10,0	M16			6715524	6718675		6722158
13,0	10,0	M17			6715527	6718676		x
14,0	11,0	M18			6715532	6718677		6722159
15,0	12,0	M20			6715538	6718679		
17,0	13,0	M22			6715553	6718713		
19,0	15,0	M24				6718707	x	
20,0	15,0	M27				6718688	x	
21,0	17,0	M28					x	
23,0	17,0	M30				6718708	6720949	
24,0	19,0	M32				6718697	x	
25,0	19,0	M33				6718710	x	
26,0	21,0	M34-M35				6718706	x	
28,0	21,0	M36-M38				6718718	6720953	
30,0	23,0	M39-M40					6720955	
32,0	26,0	M42					6720947	
35,0	26,0	M45					6720950	
38,0	29,0	M48					6720958	

Auch für zentrale Kühlmitteldurchführung (IKP) geeignet
 Also suitable for central coolant feed (IKP)

x - auf Anfrage
 x - on request



WESN – Schnellwechsel-Einsatz mit Sicherheitskupplung
WESN – Quick change adaptor with safety clutch

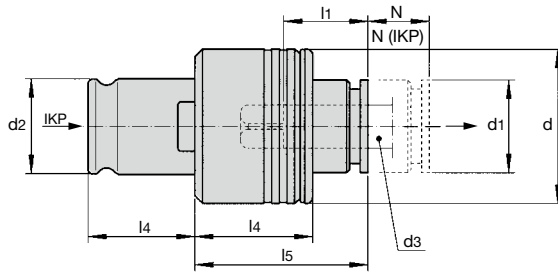

WESN...B, DIN							
Bezeichnung Designation		WESN 0 B	WESN 1 B*	WESN 2 B*	WESN 3 B*	WESN 4 B*	WESN 40 B*
		M1-M10	M3-M12	M8-M20	M14-M33	M22-M48	M6-M18
	d3	2,5-7,2	3,5-11,3	7-18	11-28	18-36	6-14
		0	1+32	2	3	4	40
	d	23	32	50	72	95	40
	d1	13	19	30	48	60	25
	d2	13	19	31	48	60	26
	l1	15	17	30	44	71	30
	l3	20	25	31	41	61	27
	l4	19,5	21,5	35	55,5	63	32
	l5	29	34	60	83	137	54
	N	8	10	15	25	25	15
	(IKP)	-	6,5	14	25	25	10

Für Gewindebohrer nach DIN
 For taps according to DIN

D	VKT	DIN 371	DIN 374	DIN 376	Id. No.	Id. No.	Id. No.	Id. No.	Id. No.	Id. No.
2,80	2,10	M1								
2,80	2,10	M1,1								
2,80	2,10	M1,2								
2,80	2,10	M1,4								
2,80	2,10	M1,6								
2,80	2,10	M1,8								
2,80	2,10	M2								
2,80	2,10	M2,2								
2,80	2,10	M2,5								
2,80	2,10		M3,5							
2,80	2,10		M4		6723018	6713762				
3,50	2,70	M3			6723067	6713858				
3,50	2,70		M5		6723074	6713867				
4,00	3,00	M3,5			6723025	6713768				
4,50	3,40	M4			6723069	6713860				
4,50	3,40		M6		6723076	6713869				
5,50	4,50		M7							
6,00	4,90	M4,5				6713780				
6,00	4,90	M5			6723070	6713861				
6,00	4,90	M6			6723077	6713870				6722169
6,00	4,90		M8		6723079	6713874	6717142			6722191
7,00	5,50	M7			6723072	6713872				
7,00	5,50		M9							
7,00	5,50		M10		6723041	6713786	6717017			6722171
8,00	6,20	M8				6713792	6717019			6722173
9,00	7,00	M9					6717140			
9,00	7,00		M12			6713797	6717024			6722175
10,00	8,00	M10				6713803	6717029			6722178

* Auch für zentrale Kühlmitteldurchführung (IKP) geeignet
 * Also suitable for central coolant feed (IKP)



WESN – Schnellwechsel-Einsatz mit Sicherheitskupplung
WESN – Quick change adaptor with safety clutch

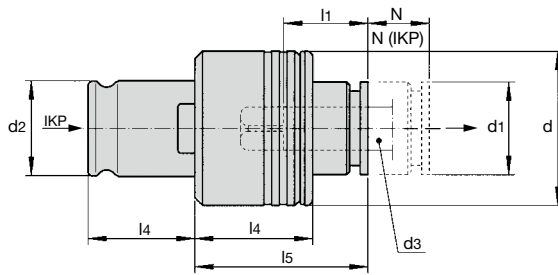

WESN...B, DIN							
Bezeichnung Designation		WESN 0 B	WESN 1 B*	WESN 2 B*	WESN 3 B*	WESN 4 B*	WESN 40 B*
		M1-M10	M3-M12	M8-M20	M14-M33	M22-M48	M6-M18
	d3	2,5-7,2	3,5-11,3	7-18	11-28	18-36	6-14
		0	1 + 32	2	3	4	40
	d	23	32	50	72	95	40
	d1	13	19	30	48	60	25
	d2	13	19	31	48	60	26
	l1	15	17	30	44	71	30
	l3	20	25	31	41	61	27
	l4	19,5	21,5	35	55,5	63	32
	l5	29	34	60	83	137	54
		8	10	15	25	25	15
	(IKP)	-	6,5	14	25	25	10

Für Gewindebohrer nach DIN
 For taps according to DIN

D	VKT	DIN 371	DIN 374	DIN 376	Id. No.	Id. No.	Id. No.	Id. No.	Id. No.	Id. No.
11,00	9,00			M14			6717032	6719568		6722180
12,00	9,00	M12								
12,00	9,00			M16			6717035	6719570		6722182
14,00	11,00			M18			6717042	6719572		6722184
16,00	12,00			M20			6717047	6719575		
18,00	14,50			M22			6717053	6719619	6721123	
18,00	14,50			M24			5098862	6719623	6721139	
20,00	16,00			M27				6719620	6721124	
22,00	18,00			M30				6719586	6721125	
25,00	20,00			M33				6719621	6721126	
28,00	22,00			M36				6719592	6721127	
32,00	24,00			M39					6721129	
32,00	24,00			M42					6721142	
36,00	29,00			M45					6721131	
36,00	29,00			M48					6721143	

* Auch für zentrale Kühlmitteldurchführung (IKP) geeignet
 * Also suitable for central coolant feed (IKP)



WESN – Schnellwechsel-Einsatz mit Sicherheitskupplung und Längennachstellung
WESN – Quick change adaptor with safety clutch and length adjustment

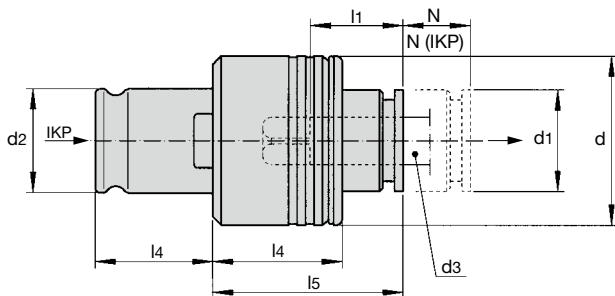

WESN...B, ISO

Bezeichnung Designation	WESN 0 B	WESN 1 B*	WESN 2 B*	WESN 3 B*	WESN 4 B*	WESN 40 B*
IKP	M1-M10	M3-M12	M8-M20	M14-M33	M22-M48	M6-M18
d3	2,5-7,2	3,5-11,3	7-18	11-28	18-36	6-14
N	0	1+32	2	3	4	40
d	23	32	50	72	95	40
d1	13	19	30	48	60	25
d2	13	19	31	48	60	26
l1	15	17	30	44	71	30
l3	20	25	31	41	61	27
l4	19,5	21,5	35	55,5	63	32
l5	29	34	60	83	137	54
N (IKP)	8	10	15	25	25	15
	-	6,5	14	25	25	10

Für Gewindebohrer nach ISO
 For taps according to ISO

D	VKT	ISO 529	ISO 529 verstärkt reinforced	Id. No.	Id. No.	Id. No.	Id. No.	Id. No.	Id. No.
2,24	1,80	M3		6723045	6713759				
2,50	2,00		M2	6723016	6713760				
2,50	2,00	M3,5		6723016	6713760				
2,80	2,24		M2,2	6723019					
2,80	2,24		M2,5	6723019					
3,15	2,50	M4		6723073	6713866				
3,15	2,50		M3	6723066	6713857				
3,55	2,80	M4,5		6723023	6713765				
3,55	2,80		M3,5	6723023	6713765				
4,00	3,15	M5		6723075	6713868				
4,00	3,15		M4	6723068	6713859				
4,50	3,55	M6		6723029	6713772				
5,00	4,00		M5	6723031	6713774				
5,60	4,50	M7		6723034	6713778				6722168
6,30	5,00	M8		6723078	6713871	6717016			6722170
6,30	5,00		M6	6723071	6713862				
7,10	5,60	M9	M7	6723042	6713787	6717018			6722172
8,00	6,30	M10			6713873	6717143			6722192
8,00	6,30		M8		6713864	6717139			6722174
9,00	7,10	M12			6713798	6717025			6722176
10,00	8,00		M10		6713803	6717029			6722178

* Auch für zentrale Kühlmitteldurchführung (IKP) geeignet
 * Also suitable for central coolant feed (IKP)



WESN – Schnellwechsel-Einsatz mit Sicherheitskupplung und Längennachstellung
WESN – Quick change adaptor with safety clutch and length adjustment

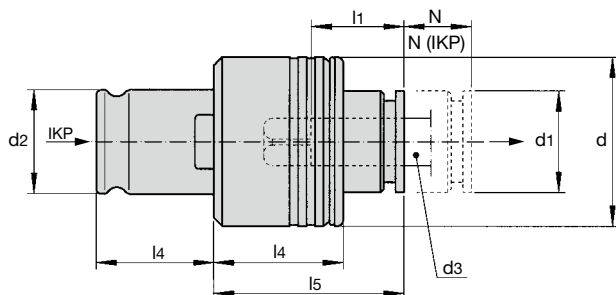

WESN...B, ISO							
Bezeichnung Designation		WESN 0 B	WESN 1 B*	WESN 2 B*	WESN 3 B*	WESN 4 B*	WESN 40 B*
		M1-M10	M3-M12	M8-M20	M14-M33	M22-M48	M6-M18
	d3	2,5-7,2	3,5-11,3	7-18	11-28	18-36	6-14
		0	1+32	2	3	4	40
	d	23	32	50	72	95	40
	d1	13	19	30	48	60	25
	d2	13	19	31	48	60	26
	l1	15	17	30	44	71	30
	l3	20	25	31	41	61	27
	l4	19,5	21,5	35	55,5	63	32
	l5	29	34	60	83	137	54
		8	10	15	25	25	15
	(IKP)	-	6,5	14	25	25	10

Für Gewindebohrer nach ISO
 For taps according to ISO

D	VKT	ISO 529	ISO 529 verstärkt reinforce	Id. No.	Id. No.	Id. No.	Id. No.	Id. No.	Id. No.
11,20	9,00	M14				6717034	6719569		6722181
12,50	10,00	M16				6717038	6719571		6722183
14,00	11,20	M18				6717141	6719618		6722185
14,00	11,20	M20				6717144	6719622		
16,00	12,50	M22				6417048	6719576		
18,00	14,00	M24				6717052	6719580	6721134	
20,00	16,00	M27					6719620	6721124	
20,00	16,00	M30					6719624	6721140	
22,40	18,00	M33					6719587	6721133	
25,00	20,00	M36					6719590	6721141	
28,00	22,40	M39					6719593	6721132	
28,00	22,40	M42						6721144	
31,50	25,00	M45						6721135	
31,50	25,00	M48						6721145	
35,50	28,00	M52-M56						6721136	

* Auch für zentrale Kühlmitteldurchführung (IKP) geeignet
 * Also suitable for central coolant feed (IKP)



WESN – Schnellwechsel-Einsatz mit Sicherheitskupplung
WESN – Quick change adaptor with safety clutch

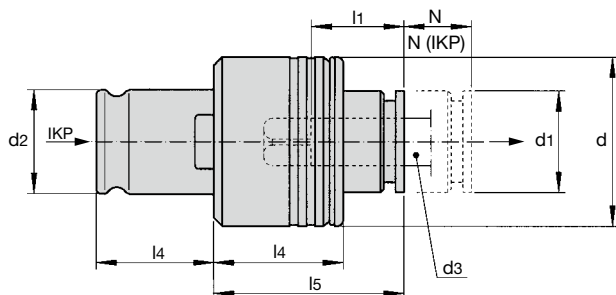

WESN...B, JIS

Bezeichnung Designation	WESN 0 B	WESN 1 B*	WESN 2 B*	WESN 3 B*	WESN 4 B*	WESN 40 B*
	M1-M10	M3-M12	M8-M20	M14-M33	M22-M48	M6-M18
d3	2,5-7,2	3,5-11,3	7-18	11-28	18-36	6-14
	0	1 + 32	2	3	4	40
d	23	32	50	72	95	40
d1	13	19	30	48	60	25
d2	13	19	31	48	60	26
l1	15	17	30	44	71	30
l3	20	25	31	41	61	27
l4	19,5	21,5	35	55,5	63	32
l5	29	34	60	83	137	54
	8	10	15	25	25	15
(IKP)	-	6,5	14	25	25	10

Für Gewindebohrer nach JIS
 For taps according to JIS

D	VKT	JIS	Id. No.	Id. No.	Id. No.	Id. No.	Id. No.	Id. No.
3,5	2,0	M2,5	x	x				
4,0	3,2	M3 – M3,5	x	x				
5,0	4,0	M4 – M4,5	6723031	6713774				
5,5	4,5	M5	x	x				
6,0	4,5	M6	6723044	6713779				x
6,2	5,0	M7 – M8	6723037	6713809				x
7,0	5,5	M9 – M10	6723041	6713786	6717017			6722171
8,0	6,5	M11		6713810	x			x
8,5	6,5	M12		6713796	x			x
10,5	8,0	M14		x	6717030			x
12,5	10,0	M16			6717038	6719571		6722183
13,0	10,0	M17			6717039	x		x
14,0	11,0	M18			6717042	6719572		6722184
15,0	12,0	M20			6717046	x		
17,0	13,0	M22			x	x		
19,0	15,0	M24				x	x	
20,0	15,0	M27				x	x	
21,0	17,0	M28				x	x	
23,0	17,0	M30				x	x	
24,0	19,0	M32				x	x	
25,0	19,0	M33				x	x	
26,0	21,0	M34 – M35				x	x	
28,0	21,0	M36 – M38				x	x	
30,0	23,0	M39 – M40					x	
32,0	26,0	M42					x	
35,0	26,0	M45					x	
38,0	29,0	M48					x	

* Auch für zentrale Kühlmitteldurchführung (IKP) geeignet
 * Also suitable for central coolant feed (IKP)

x - auf Anfrage
 x - on request



WESK – Schnellwechsel-Einsatz mit Sicherheitskupplung
WESK – Quick change adaptor with safety clutch

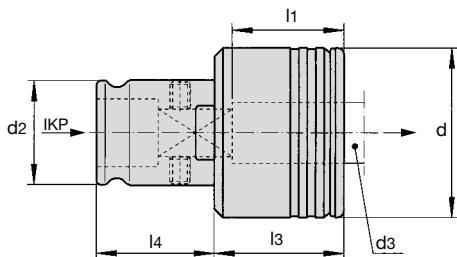

WESK...B, DIN erweiterter Spannbereich mit Klemmschrauben extended clamping range with set screws								
Bezeichnung Designation		WESK 1	WESK 2	WESK 3	WESK 4			
		M16	M27 - M30	M39 - M48	M52 - M60			
	d3	11,2-12	18-22	28-36	36-45			
		1	2	3	4			
	d	32	50	72	95			
	d2	19	31	48	60			
	l1	27,5	32,5	40	54			
	l3	25	31	41	61			
	l4	21,5	35	55,5	63			
Für Gewindebohrer nach DIN For taps according to DIN								
D	VKT	DIN 371	DIN 374	DIN 376	Id. No.	Id. No.	Id. No.	Id. No.
12,00	9,00	M12	M16		6713642			
18,00	14,50		M22-M24			6716808		
20,00	16,00		M27			6716800		
22,00	18,00		M30			6716801		
28,00	22,00		M36				6719421	
32,00	24,00		M39-M42				6719417	
36,00	29,00		M45-M48				6719420	6720992
40,00	32,00		M52					6720983
45,00	35,00		M56-M60					6720984
Nur für leichte Bearbeitung! For light machining only!			max. Nm	40 M 14	160 M 24	630 M 42	900 M 48	

Auch für zentrale Kühlmitteldurchführung (IKP) geeignet
 Also suitable for central coolant feed (IKP)



WESR – Schnellwechsel-Einsatz mit Sicherheitskupplung
WESR – Quick change adaptor with safety clutch

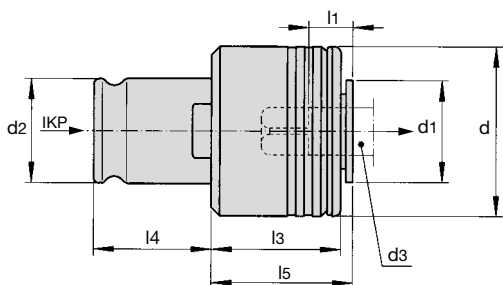

WESR...B, DIN

mit reduzierter Einstecktiefe
 with reduced inserting depth

Bezeichnung Designation		WESR2B	WESR3B	WESR4B
		M8-M20	M14-M33	M22-M48
	d3	7-18	11-28	18-36
		2	3	4
	d	50	72	95
	d1	30	48	60
	d2	31	48	61
	l1	21	25	46
	l3	31	41	61
	l4	35	55,5	63
	l5	34	45	68

Für Gewindebohrer nach DIN
 For taps according to DIN

D	VKT	DIN 371	DIN 374	DIN 376	Id. No.	Id. No.	Id. No.
7,00	5,5				6716840		
8,00	6,20	M8			6716846		
9,00	7,00	M9	M12		6716847		
11,00	9,00		M14		6716825	6719444	
12,00	9,00	M12			6716829	6719445	
12,00	9,00		M16		6716829	6719445	
14,00	11,00		M18		6716817	6719442	
16,00	12,00		M20		6716827	6719446	
18,00	14,50		M22		6716842	6719440	6721031
20,00	16,00		M27			6719449	6721013
22,00	18,00		M30			6719453	6721029
25,00	20,00		M33			6719439	6721010
28,00	22,00		M36			-	6721004
32,00	24,00		M39				6721003
32,00	24,00		M42				6721003
36,00	29,00		M45				6721014
36,00	29,00		M48				6721014

Auch für zentrale Kühlmitteldurchführung (IKP) geeignet
 Also suitable for central coolant feed (IKP)

WES – Schnellwechsel-Einsatz mit Sicherheitskupplung
WES – Quick change adaptor with safety clutch

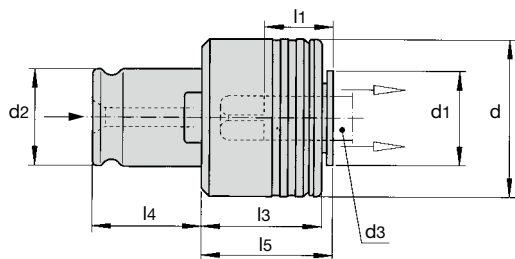

WES...B-KP

für Gewindebohrer, -former ohne innere Kühlmittelzufuhr
 for taps, roll former without internal coolant supply

Bezeichnung Designation		WES1B-KP	WES2B-KP	WES3B-KP
		M3-M12	M8-M20	M14-M33
	d3	3,5-11,3	7-18	11-28
		1	2	3
	d	32	50	72
	d1	19	30	48
	d2	19	31	48
	l1	17	30	44
	l3	25	31	41
	l4	21,5	35	55,5
	l5	25	34	45

Für Gewindebohrer nach DIN
 For taps according to DIN

D	VKT	DIN 371	DIN 374	DIN 376	Id. No.	Id. No.	Id. No.
3,50	2,70	M3	M5		6713704		
4,00	3,00	M3,5			6713705		
4,50	3,40	M4	M6		6713701		
5,50	4,50		M7		6713717		
6,00	4,90	M4,5			-		
6,00	4,90	M5			6713702		
6,00	4,90	M6	M8		6713758	6716921	
7,00	5,50	M7	M9-M10		6713700	6716923	
8,00	6,20	M8			6713692	6716902	
9,00	7,00	M9	M12		6713694	6716904	
10,00	8,00	M10	M10		6713696	6716906	
11,00	9,00		M14		6713697	6716907	6719513
12,00	9,00	M12	M16			6716909	6719521
14,00	11,00		M18			6716911	6719514
16,00	12,00		M20			6716913	6719524
18,00	14,50		M22-M24			6716916	6719512
20,00	16,00		M27				6719517
22,00	18,00		M30				6719515
25,00	20,00		M33				6719518
28,00	22,00		M36				6719519



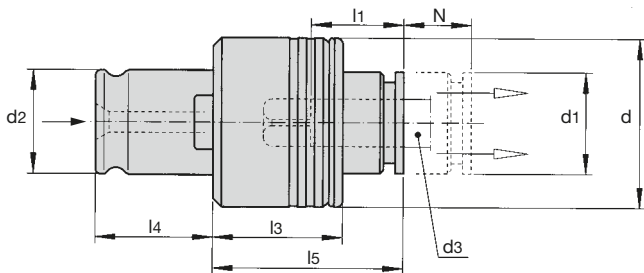

WESN – Schnellwechsel-Einsatz mit Sicherheitskupplung
WESN – Quick change adaptor with safety clutch



WESN...B-KP

für Gewindebohrer, -former ohne innere Kühlmittelzufuhr
 for taps, roll former without internal coolant supply

Bezeichnung Designation	WESN1B-KP	WESN2B-KP	WESN3B-KP
 M3-M12	M3-M12	M8-M20	M14-M33
d3	3,5-11,3	7-18	11-28
 1	1	2	3
d	32	50	72
d1	19	30	48
d2	19	31	48
l1	17	30	44
l3	25	31	41
l4	21,5	35	55,5
l5	34	60	83
 6,5	6,5	14	25

Für Gewindebohrer nach DIN
 For taps according to DIN

D	VKT	DIN 371	DIN 374	DIN 376	Id. No.	Id. No.	Id. No.
3,50	2,70	M3	M5		6714437		
4,00	3,00	M3,5			6714438		
4,50	3,40	M4	M6		6714434		
5,50	4,50		M7		–		
6,00	4,90	M4,5			6714435		
6,00	4,90	M5			6714435		
6,00	4,90	M6	M8		6714435		
7,00	5,50	M7	M9-M10		6714433	6717600	
8,00	6,20	M8			6714425	6717579	
9,00	7,00	M9	M12		6714427	6717581	
10,00	8,00	M10	M10		6714429	6717583	
11,00	9,00		M14		6714430	6717584	6720033
12,00	9,00	M12	M16			6717586	6720041
14,00	11,00		M18			6717588	6720034
16,00	12,00		M20			6717590	6720044
18,00	14,50		M22-M24			6717593	6720032
20,00	16,00		M27				6720037
22,00	18,00		M30				6720035
25,00	20,00		M33				6720038
28,00	22,00		M36				6720039

WESN – Schnellwechsel-Einsatz mit Sicherheitskupplung
WESN – Quick change adaptor with safety clutch

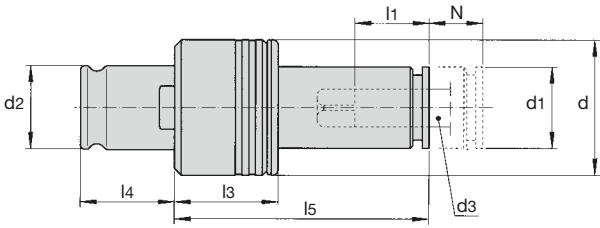

WESN...B-...																							
Bezeichnung Designation		d3		N	d	d1	d2	l1	l3	l4	l5												
WESN0B-...	M 1 - M 10	2,5 - 7,2	0	8	23	13	13	15	20	19,5	40	50	60	70	80	90	100	110	120				
WESN1B-...	M 3 - M 12	3,5 - 11,3	1 + 32	10	32	19	19	17	25	21,5	40	50	60	70	80	90	100	110	120	130	140		
WESN2B-...	M 8 - M 20	7,0 - 18,0	2	15	50	30	31	30	31	35	70	80	90	100	110	120	130	140	150	160			
WESN3B-...	M14 - M 33	11,0 - 28,0	3	25	72	48	48	44	41	55,5	100	120	140	160	180								
WESN40B-...	M 6 - M 18	6,0 - 14,0	40	15	40	25	26	30	27	32	60	70	80	90	100	110	120	130	140	150			

Bestellbeispiel Example for ordering
 Bilz WESN1B-80-M8 DIN 371

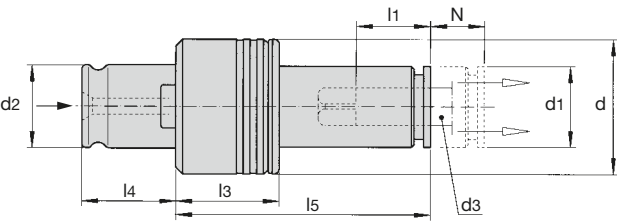

WESN...B-KP-...																							
Bezeichnung Designation		d3		N	d	d1	d2	l1	l3	l4	l5												
WESN1B-KP...	M 3 - M 12	3,5 - 11,3	1	6,5	32	19	19	17	25	21,5	40	50	60	70	80	90	100	110	120	130	140		
WESN2B-KP...	M 8 - M 20	7,0 - 18	2	14	50	30	31	30	31	35	70	80	90	100	110	120	130	140	150	160			
WESN3B-KP...	M14 - M 33	11 - 28	3	25	72	48	48	44	41	55,5	100	120	140	160	180								

Bestellbeispiel Example for ordering
 Bilz WESN1B-KP-80-M8 DIN 371

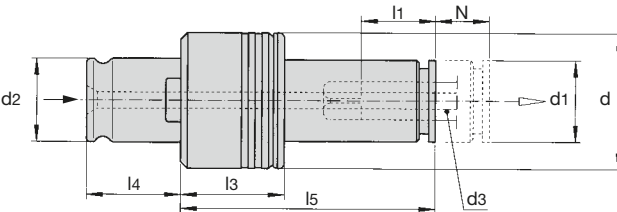

WESN...-IKP-...																							
Bezeichnung Designation		d3		N	d	d1	d2	l1	l3	l4	l5												
WESN1B-IKP...	M 3 - M 12	3,5 - 11,3	1	6,5	32	19	19	17	25	21,5	40	50	60	70	80	90	100	110	120	130	140		
WESN2B-IKP...	M 8 - M 20	7,0 - 18	2	14	50	30	31	30	31	35	70	80	90	100	110	120	130	140	150	160			
WESN3B-IKP...	M14 - M 33	11 - 28	3	25	72	48	48	44	41	55,5	100	120	140	160	180								

Auch für zentrale Kühlmitteldurchführung (IKP) geeignet
 Also suitable for central coolant feed (IKP)

Bestellbeispiel Example for ordering
 Bilz WESN1B-IKP-80-M8 DIN 371



Einstellwerkzeuge für WES Einsätze Adjustment tools for WES adaptors

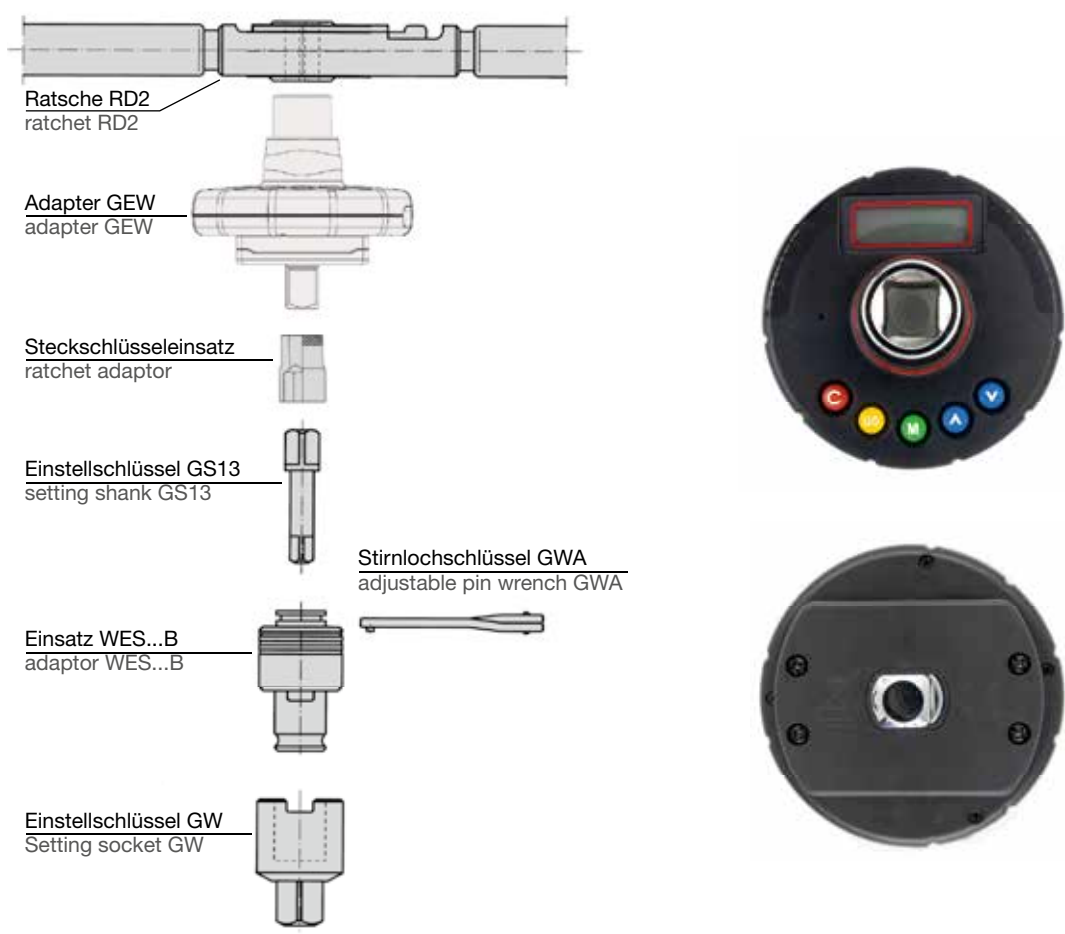

GEW-1,5-30, 5146739, Einstellwerkzeug / Adjusting tool
GEW-7-135, 5145157, Einstellwerkzeug / Adjusting tool
GEW-17-340, 5145158, Einstellwerkzeug / Adjusting tool

beinhaltet / includes:

Ratsche / ratchet RD2

Adapter / adaptor GEW

Steckschlüsseinsatz / ratchet adaptor

Ausführung kann von Abbildung abweichen!
Execution may differ from illustration!

Zubehör Accessories

Einstellwerkzeug Adjust- ment tool GEW	Mt max. Nm GEW	Bereich Range GEW	GS13	GWA	GW	WES-WESK	max. Nm
GEW-1,5-30 5146739	1,5 - 30	M4 - M12	2,8 - 11,2	GWA0 6721800	GW0 6721790	0	22
GEW-1,5-30 5146739	1,5 - 30	M4 - M12	2,8 - 12	GWA1 6721801	GW1 6721791	1	30
GEW-7-135 5145157	7 - 135	M8 - M22	6 - 18	GWA1 6721801	GW1 6721791	1	40
GEW-7-135 5145157	7 - 135	M8 - M22	6 - 18	GWA40 6721803	GW40 6721794	40	80
GEW-7-135 5145157	7 - 135	M8 - M22	6 - 18	GWA40 6721803	GW2 6721792	2	135
GEW-17-340 5145158	17 - 340	M10 - M33	7 - 25	GWA40 6721803	GW2 6721792	2	160
GEW-17-340 5145158	17 - 340	M10 - M33	7 - 25	GWA3 6721804	GW3 6721795	3	340

Bei Bestellung der Einstellschlüssel GS bitte Schaft-Ø und Vierkant oder Gewinde und DIN des in den Einsatz passenden Gewindebohrers angeben.

When ordering setting shanks Type GS, please state shank Ø and square, or thread and DIN of tap used in the adaptor.

Id. Nr. Id. No.	Ø x □	Ø x □	Ø x □	Gr. Size					DIN	ISO	JIS	Bezeichnung Designation
				0	1	40	2	3				
6721697	2,8 x 2,1			x					x			GS13-POS.004-2,5X2,1
6721698	2,8 x 2,24			x						x		GS13-POS.005-2,8X2,3
6721751	3,15 x 2,5			x						x		GS13-POS.063-3,1X2,5
6721696	3,5 x 2,0			x							x	GS13-POS.003-2,4X2,0
6721700	3,5 x 2,7			x					x			GS13-POS.007-3,5X2,5
6721699	3,55 x 2,8			x						x		GS13-POS.006-3,25X2,6
6721702	4,0 x 3,0			x					x			GS13-POS.009-3,8X3
6721703	4,0 x 3,2	4,0 x 3,15		x						x	x	GS13-POS.010-4,0X3,2
6721704	4,5 x 3,4	4,5 x 3,55		x					x	x		GS13-POS.011-4,4X3,4
6721752	5,0 x 4,0			x						x	x	GS13-POS.065-5X3,8
6721709	5,5 x 4,3	5,5 x 4,5		x					x		x	GS13-POS.016-5X4,2
6721760	5,6 x 4,5	6,0 x 4,5		x						x	x	GS13-POS.075-5,5X4,5
6721711	6,0 x 4,9	6,2 x 5,0	6,3 x 5,0	x	x	x			x	x	x	GS13-POS.018-5,9X4,8
6721715	7,0 x 5,5	7,1 x 5,6		x	x	x	x		x	x	x	GS13-POS.022-7X5,4
6721718	8,0 x 6,2	8,0 x 6,3		x	x	x	x		x	x		GS13-POS.027-7,9X6
6721720	8,5 x 6,5			(x)	x	x	x				x	GS13-POS.029-8,5X6,2
6721722	9,0 x 7,0	9,0 x 7,1		(x)	x	x	x		x	x		GS13-POS.031-9X7
6721725	10,0 x 8,0			(x)	x	x	x		x	x		GS13-POS.034-9,8X7,75
6721762	10,5 x 8,0			(x)	x	x	x				x	GS13-POS.077-10,5X8
6721728	11,0 x 9,0	11,2 x 9,0		(x)	x	x	x	x	x	x		GS13-POS.037-10,9X9
6721729	12,0 x 9,0				(x)	x	x	x	x			GS13-POS.038-11,8X9
6721730	12,5 x 10,0				(x)	x	x	x		x	x	GS13-POS.039-11,8X10
6721733	13,0 x 10,0				(x)	x	x	x			x	GS13-POS.042-13X10
6721736	14,0 x 11,0	14,0 x 11,2			(x)	x	x	x	x	x	x	GS13-POS.045-14X11
6721739	15,0 x 12,0					(x)	x	x			x	GS13-POS.048-15X12
6721741	16,0 x 12,0	16,0 x 12,5				(x)	x	x	x	x		GS13-POS.050-16X12
6721743	17,0 x 13,0					(x)	x	x		x	x	GS13-POS.052-17X13
6721745	18,0 x 14,5					(x)	x	x	x			GS13-POS.055-18X14
6721746	20,0 x 15,0	20,0 x 16,0					(x)	x	x	x	x	GS13-POS.056-20X15
6721754	21,0 x 17,0						(x)	x			x	GS13-POS.067-21X17
6721755	22,0 x 18,0	22,4 x 18,0					(x)	x	x	x		GS13-POS.068-22X18
6721754	23,0 x 17,0							x			x	GS13-POS.067-21X17
6721748	24,0 x 19,0	25,0 x 19,0						x			x	GS13-POS.058-24X18
6721756	25,0 x 20,0	28,0 x 21,0	26,0 x 21,0					x	x	x	x	GS13-POS.069-25X20
6721757	28,0 x 22,0	28,0 x 22,4						(x)	x	x		GS13-POS.070-27,5X22
6721758	32,0 x 24,0							(x)	x			GS13-POS.071-32X24
6721759	36,0 x 29,0							(x)	x			GS13-POS.073-36X29
Max. einstellbares Drehmoment bei Gr._! Max. possible torque setting for size _!				22Nm	40Nm	80Nm	160Nm	630Nm*				

* GEW-17-340 max. 340Nm

Hinweis:

(x) Einsätze mit erweitertem Spannbereich wie WESK und WESNE.
Nur für leichte Bearbeitung, max. einstellbares Drehmoment eingestellt!

Attention:

(x) Adaptors with extended clamping range WESK and WESNE.
For light machining only. Max. possible torque setting!

Einstellwerkzeuge Größe 0 Adjustment tools size 0

Einstellwerkzeuge Größe 0 / Adjustment tools size 0 / M4-M10		0
GEW-1,5-30; (1,5-30Nm)		5146739
GW0		6721790
GWA0		6721800
GS13-POS.		Seite / Page 133

Einstellwerkzeuge Größe 1 Adjustment tools size 1

Einstellwerkzeuge Größe 1 / Adjustment tools size 1 / M4-M10		1
GEW-1,5-30; (1,5-30Nm)		5146739
GW0		6721790
GWA0		6721800
GS13-POS.		Seite / Page 133

Einstellwerkzeuge Größe 1 / Adjustment tools size 1 / M8-M14		1
GEW-7-135; (7-135Nm)		5145157
GW1		6721791
GWA1		6721801
GS13-POS.		Seite / Page 133

Einstellwerkzeuge Größe 2 Adjustment tools size 2

Einstellwerkzeuge Größe 2 / Adjustment tools size 2 / M6-M12		2
GEW-1,5-30; (1,5-30Nm)		5146739
GW2		6721792
GWA2		6721802
GS13-POS.		Seite / Page 133

Einstellwerkzeuge Größe 2 / Adjustment tools size 2 / M10-M22		2
GEW-17-340; (17-340Nm)		5145158
GW2		6721792
GWA2		6721802
GS13-POS.		Seite / Page 133

Einstellwerkzeuge Größe 3 Adjustment tools size 3

Einstellwerkzeuge Größe 3 / Adjustment tools size 3 / M10-M33		3
GEW-17-340; (17-340Nm)		5145158
GW3		6721795
GWA3		6721804
GS13-POS.		Seite / Page 133

Einstellwerkzeuge Größe 40 Adjustment tools size 40

Einstellwerkzeuge Größe 40 / Adjustment tools size 40 / M6-M12		40
GEW-1,5-30; (1,5-30Nm)		5146739
GW40		6721792
GWA40		6721802
GS13-POS.		Seite / Page 133

Einstellwerkzeuge Größe 40 / Adjustment tools size 40 / M8-M18		40
GEW-7-135; (7-135Nm)		5145157
GW40		6721792
GWA40		6721802
GS13-POS.		Seite / Page 133

Anwendung: Gewindeschneiden
Maschinentyp: auf allen Arten von Maschinen

Application: tapping
Machine type: on all types of machines

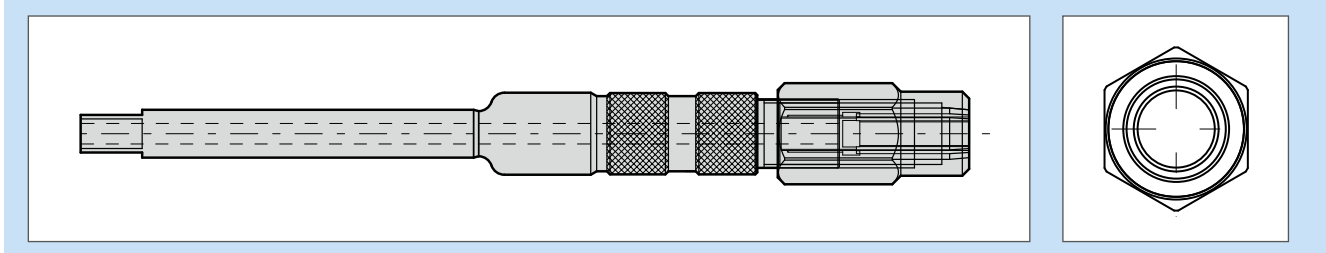

Gewindebohrer mit verlängertem Schaft werden zum Gewindeschneiden in Werkstücke mit tiefliegenden Innengewinden oder zum Gewindeschneiden unmittelbar an Gusswänden, Absätzen, Störkanten von Vorrichtungen usw. benötigt. Um dies zu vermeiden setzt man Gewindebohrer-Verlängerungen ein.

For tapping operations in work pieces with extremely deep internal threads or for tapping close to cast iron walls, interference edges or shoulders of fixtures there is the need of taps with an extended shank. To avoid special taps extensions are useful.

Merkmale:	Vorteile:	Nutzen:
<ul style="list-style-type: none"> ▪ Schafttoleranz h6 	<ul style="list-style-type: none"> ▪ Höhere Rundlaufgenauigkeit ▪ Der Schaft kann in Schrumpffutter oder Hydrodehnspannfuttern gespannt werden 	<ul style="list-style-type: none"> ▪ Erhöhte Standzeit ▪ Höhere Rundlaufgenauigkeit
<ul style="list-style-type: none"> ▪ Innere Kühlmitteldurchführung bis 50 bar 	<ul style="list-style-type: none"> ▪ Bessere Späneabfuhr ▪ Spülen der Grundlochbohrung 	<ul style="list-style-type: none"> ▪ Längere Standzeit des Gewindebohrers ▪ Keine extra Reinigung notwendig
<ul style="list-style-type: none"> ▪ Schlanke Bauform 	<ul style="list-style-type: none"> ▪ Engere Abstände zur Störkontur möglich 	<ul style="list-style-type: none"> ▪ Keine Sondergewindebohrer erforderlich. ▪ Kostenersparnis. Einmalige Anschaffung
<ul style="list-style-type: none"> ▪ Schaft mit Vierkant 	<ul style="list-style-type: none"> ▪ Verlängerungen können wie Gewindebohrer in Schnellwechsel-Einsätzen gespannt werden ▪ Problemlose Kraftübertragung 	<ul style="list-style-type: none"> ▪ Reduzierte Stillstandszeit der Maschine beim Werkzeugwechsel ▪ Kein Durchdrehen des Gewindebohrers
<ul style="list-style-type: none"> ▪ Spannmutter mit Aussensechskant 	<ul style="list-style-type: none"> ▪ Sicheres Spannen des Gewindebohrers 	<ul style="list-style-type: none"> ▪ Erhöhte Prozesssicherheit
Features:	Advantages:	Benefits:
<ul style="list-style-type: none"> ▪ Shank tolerance h6 	<ul style="list-style-type: none"> ▪ Better run out accuracy ▪ Shank can be clamped in shrinking chucks or hydraulic chucks. 	<ul style="list-style-type: none"> ▪ Longer tool life ▪ Better run out accuracy
<ul style="list-style-type: none"> ▪ Coolant pressure max. 50 bar 	<ul style="list-style-type: none"> ▪ Better chip removal ▪ Rinsing of the base hole 	<ul style="list-style-type: none"> ▪ Extended tool life of the tap ▪ No additional cleaning required
<ul style="list-style-type: none"> ▪ Slim design 	<ul style="list-style-type: none"> ▪ Closer distances to the interfering contour possible 	<ul style="list-style-type: none"> ▪ No special taps required. Cost saving. ▪ One off purchase.
<ul style="list-style-type: none"> ▪ Shank with square 	<ul style="list-style-type: none"> ▪ Extensions can be fixed such as taps in quick-change inserts ▪ Easy power transmission 	<ul style="list-style-type: none"> ▪ Reduced down time of the machine during tool change. ▪ No twisting of the tap
<ul style="list-style-type: none"> ▪ Clamping nut with hexagon 	<ul style="list-style-type: none"> ▪ Safe clamping of the tap. 	<ul style="list-style-type: none"> ▪ Increased process safety

GBV – Gewindebohrer-Verlängerungen (nur zum Gewindeschneiden)
GBV – Tap extension (for tapping only)

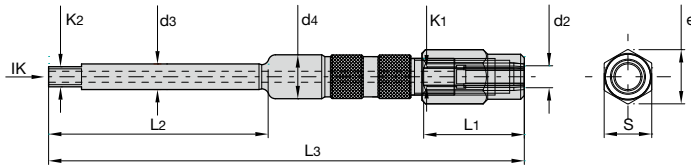

Bezeichnung Designation	DIN 371	DIN 374 376	Ø d2	□ K1	L1	Ø d3	□ K2	Ø d4	e	S	L2	L3	Id. No.
GBV2x35x27x130	M3	M4,5 / M5	3,5	2,7	24,0	6	4,9	7,5	9,0	8	60	130	5063404
GBV3x45x34x130	M4	M6	4,5	3,4	24,0	6	4,9	8,4	10,2	9	60	130	5063407
GBV4x60x49x130	M4,5 / M6	M8	6,0	4,9	27,5	7	5,5	12,0	14,8	13	60	130	5062047
GBV4x60x49x230			6,0	4,9	27,5	7	5,5	12,0	14,8	13	60	230	5062048
GBV4x60x49-80x62x130	M4,5 / M6	M8	6,0	4,9	27,5	8	6,2	12,0	14,8	13	60	130	5062049
GBV4x60x49-80x62x230			6,0	4,9	27,5	8	6,2	12,0	14,8	13	60	230	5062050
GBV5x70x55x130	M7	M9 / M10	7,0	5,5	27,5	7	5,5	12,0	14,8	13	60	130	5062051
GBV5x70x55x230			7,0	5,5	27,5	7	5,5	12,0	14,8	13	60	230	5062052
GBV5x70x55-80x62x130	M7	M9 / M10	7,0	5,5	27,5	8	6,2	12,0	14,8	13	60	130	5062053
GBV5x70x55-80x62x230			7,0	5,5	27,5	8	6,2	12,0	14,8	13	60	230	5062054
GBV6x80x62x130	M8	M11	8,0	6,2	30,0	8	6,2	13,0	15,6	14	60	130	5062055
GBV6x80x62x230			8,0	6,2	30,0	8	6,2	13,0	15,6	14	80	230	5062056
GBV7x90x70x130	M9	M12	9,0	7,0	31,0	9	7,0	15,0	17,9	16	60	130	5062057
GBV7x90x70x230			9,0	7,0	31,0	9	7,0	15,0	17,9	16	80	230	5062058
GBV7x90x70-100x80x130	M9	M12	9,0	7,0	31,0	10	8,0	15,0	17,9	16	60	130	5062059
GBV7x90x70-100x80x230			9,0	7,0	31,0	10	8,0	15,0	17,9	16	80	230	5062060
GBV8x100x80x130	M10		10,0	8,0	33,0	10	8,0	15,0	17,9	16	60	130	5062061
GBV8x100x80x230			10,0	8,0	33,0	10	8,0	15,0	17,9	16	80	230	5062062
GBV9x110x90x130		M14	11,0	9,0	36,0	11	9,0	18,0	21,4	19	90	130	5062063
GBV9x110x90x230			11,0	9,0	36,0	11	9,0	18,0	21,4	19	90	230	5062064
GBV9x110x90-120x90x130		M14	11,0	9,0	36,0	12	9,0	18,0	21,4	19	90	130	5062065
GBV9x110x90-120x90x230			11,0	9,0	36,0	12	9,0	18,0	21,4	19	90	230	5062066
GBV10x120x90x130		M16	12,0	9,0	36,0	12	9,0	19,0	21,4	19	90	130	5062067
GBV10x120x90x230			12,0	9,0	36,0	12	9,0	19,0	21,4	19	90	230	5062068
GBV11x140x110x200		M18	14,0	11,0	46,0	14	11,0	22,0	26,0	23	100	200	5062069
GBV11x140x110x330			14,0	11,0	46,0	14	11,0	22,0	26,0	23	100	330	5062070
GBV12x160x120x200		M20	16,0	12,0	46,0	16	12,0	22,0	26,0	23	100	200	5062072
GBV12x160x120x330			16,0	12,0	46,0	16	12,0	22,0	26,0	23	100	330	5062073
GBV13x180x145x200		M22 / M24	18,0	14,5	47,0	18	14,5	26,0	30,5	27	100	200	5062074
GBV13x180x145x330			18,0	14,5	47,0	18	14,5	26,0	30,5	27	100	330	5062075
GBV14x200x160x200		M27	20	16,0	52,0	20	16,0	28,0	33,5	30	100	200	5062076
GBV14x200x160x330			20	16,0	52,0	20	16,0	28,0	33,5	30	100	330	5062077
GBV15x220x180x200		M30	22	18,0	55,0	22	18,0	30,0	40,5	36	100	200	5062078
GBV15x220x180x330			22	18,0	55,0	22	18,0	30,0	40,5	36	100	330	5062079
GBV16x250x200x200		M33	25	20,0	56,0	25	20,0	35,0	40,5	36	100	200	5062080
GBV16x250x200x330			25	20,0	56,0	25	20,0	35,0	40,5	36	100	330	5062081
GBV17x280x220x200		M36	28	22,0	58,0	28	22,0	40,0	52,0	46	100	200	5062082
GBV17x280x220x330			28	22,0	58,0	28	22,0	40,0	52,0	46	100	330	5062083
GBV18x320x240x200		M39 / M42	32	24,0	60,0	32	24,0	44,0	52,0	46	100	200	5062084
GBV18x320x240x330			32	24,0	60,0	32	24,0	44,0	52,0	46	100	330	5062085

Rändelmutter auf Anfrage
 Knurled nut on request

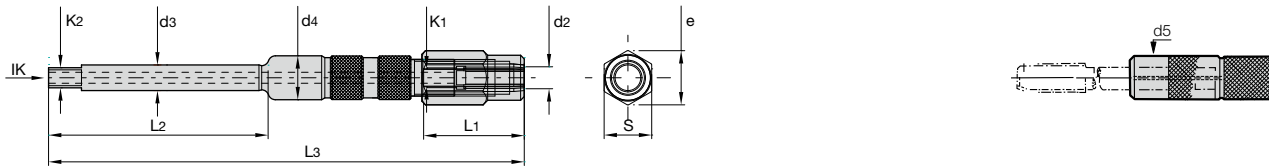

Bezeichnung Designation	S/Mutter S/Nut	e mm	Skt. - Mutter/Id. Nr. Hex. - Nut/Id. Nr.	Nm	Bez./Id. Nr. Des/Id. Nr.	TORCO-FIX Aufsteckschlüssel Fitting key	Rändelmutter Knurled nut	Ø d5 mm
GBV 2	8	9,0	GBVM2-SKT	3	16Z-SW8		GBVM2-RD	7,5
			5088694		5091123		5070238	
GBV 3	9	10,2	GBVM3-SKT	5	16Z-SW9		GBVM3-RD	8,4
			5088695		5091125		5070239	
GBV 4	13	14,8	GBVM4-SKT	6	16Z-SW13		GBVM4-RD	12,1
			5088696		5091126		5070240	
GBV 5	13	14,8	GBVM5-SKT	7	16Z-SW13		GBVM5-RD	12,1
			5088697		5091126		5070241	
GBV 6	14	15,6	GBVM6-SKT	9	16Z-SW14		GBVM6-RD	13,0
			5088698		5091129		5070242	
GBV 7	16	17,9	GBVM7-SKT	12	16Z-SW16		GBVM7-RD	15,0
			5088699		5091134		5070243	
GBV 8	16	17,9	GBVM8-SKT	14	16Z-SW16		GBVM7/8-RD	15,0
			5088700		5091134		5070244	
GBV 9	19	21,4	GBVM9-SKT	16	16Z-SW19		GBVM9-RD	18,0
			5088701		5091137		5070245	
GBV 10	19	21,4	GBVM10-SKT	18	16Z-SW19		GBVM10-RD	18,0
			5088702		5091137		5070246	
GBV 11	23	26,0	GBVM11-SKT	20	16Z-SW23	GBVM11-RD	22,0	
			5088703		5056896	5070247		
GBV 12	23	26,0	GBVM12-SKT	22	16Z-SW23	GBVM12-RD	22,0	
			5088704		5056896	5070248		
GBV 13	27	30,5	GBVM13-SKT	30	16Z-SW27	GBVM13-RD	26,0	
			5093668		5091140	5091146		
GBV 14	30	33,5	GBVM14-SKT	35	16Z-SW30	GBVM14-RD	28,0	
			5093669		5056897	5091147		
GBV 15	36	40,5	GBVM15-SKT	40	16Z-SW36	GBVM15-RD	30,0	
			5093670		5091143	5091148		
GBV 16	36	40,5	GBVM16-SKT	45	16Z-SW36	GBVM16-RD	35,0	
			5093671		5091143	5091149		
GBV 17	46	52,0	GBVM17-SKT	50		GBVM17-RD	40,0	
			5093672			5091150		
GBV 18	46	52,0	GBVM18-SKT	50		GBVM18-RD	44,0	
			5093673			5091151		

Hinweis: Rändelmutter auf Anfrage, wenn der Aussendurchmesser der SKT-Mutter zu groß ist!
Please note: Knurled nut on request if the diameter of the hex. nut is too big

Drehmomentschlüssel TORCO-FIX Torque wrench TORCO-FIX				
	Bezeichnung Designation	Id.No.	I 1	Drehmoment Nm Torque Nm
	TORCO-FIX 0	5093674	290	2 – 25
	TORCO-FIX I	6734177	335	5 – 50

D – DSPL

Gewindeschneidfutter Tapping Chuck

bilz

Anwendung: Gewindeschneiden, -formen

bei häufig wechselnden Gewindegrößen z.B. Kleinbetrieben, Reparaturabteilungen, etc.

Maschinentyp: umschaltbare Bohr- und Gewindeschneidmaschinen | Ausleger-, Schwenk-, Radialbohrmaschinen | Sonder-, Dreh-, NC-Maschinen

Application: tapping and roll forming

with frequently changing thread sizes, e.g. small firms, repair departments etc. etc.

Machine type: reversible drilling and tapping machines | radial, horizontal boring machines | special purpose, turning and NC-machines

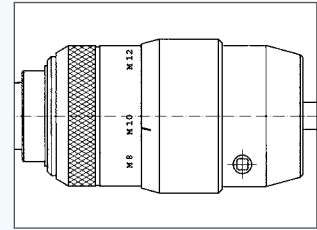
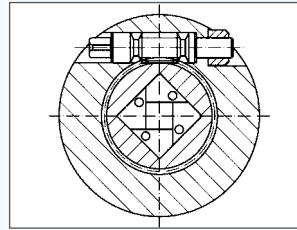
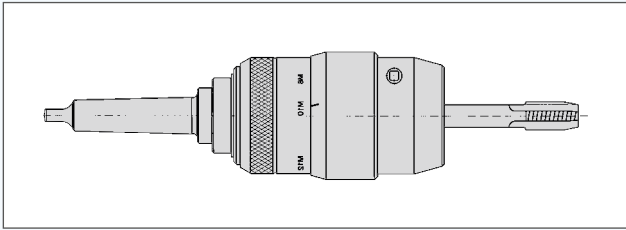

Gewindeschneidfutter zur Verwendung auf Bohr- und Gewindeschneidmaschinen

Mit dem Doppelspannsystem werden die Gewindebohrer am Schaft und Vierkant gleichermaßen fest und verdrehsicher gespannt. Der große Spannbereich ist ein weiteres Merkmal dieser Spanntechnik, die mit einem Vierkantschlüssel betätigt wird.

Die einstellbare Sicherheitskupplung verhindert weitestgehend einen möglichen Werkzeugbruch. Durch das minimale Restdrehmoment nach dem Auslösen unterliegt die Kupplung nahezu keinem Verschleiß. Die Mitnahme des Gewindebohrers im Rücklauf erfolgt zwangsweise.

Eventueller Achsversatz zwischen Maschinenspindel und Werkstückachse wird von einer kugelgelagerten Pendleinrichtung ausgeglichen.

Ein Längenausgleich auf Druck und Zug verhindert das Verschneiden der Gewinde bei nicht steigungsgenauem Vorschub z. B. Handvorschub. Er ist in Nulllage positioniert, kann gleichermaßen auf Maschinen mit manuellem oder automatischem Vorschub eingesetzt werden.

Tapping chuck for use on drilling and tapping machines

The tap is securely clamped on both the shank and square using a double clamping system. The wide clamping range of this unit is operated by using a key on the rectangular head adjustment screw within the body of the unit.

The adjustable safety clutch prevents tap breakage and the torque system ensures minimum wear on the clutch. The tap is automatically locked on return after the clutch has slipped.

The floating system employed compensates for any misalignment that may occur between the tap and the hole in the workpiece.

The length compensation acts on tension and compression to compensate for any pitch variation between the machine and the tapping chuck, the unit can be used on machines with both manual and automatic feed, built-in exact zero-position.

D – DSPL

Gewindeschneidfutter Tapping Chuck



Merkmale:	Vorteile:	Nutzen:
<ul style="list-style-type: none"> ▪ Doppelspannung mit großem Spannbereich 	<ul style="list-style-type: none"> ▪ direkte Aufnahme der Gewindebohrer 	<ul style="list-style-type: none"> ▪ keine Schnellwechseleinsätze erforderlich
<ul style="list-style-type: none"> ▪ einstellbare Sicherheitskupplung 	<ul style="list-style-type: none"> ▪ zur Verhinderung von Gewindebohrerbruch 	<ul style="list-style-type: none"> ▪ geringere Werkzeugkosten und Nacharbeitskosten
<ul style="list-style-type: none"> ▪ Längenausgleich auf Druck und Zug 	<ul style="list-style-type: none"> ▪ gleicht Unterschiede zwischen Gewindebohrersteigung und Vorschub aus 	<ul style="list-style-type: none"> ▪ einwandfreie Gewinde in guter Qualität, geringerer Gewindebohrerverschleiß
<ul style="list-style-type: none"> ▪ Pendelung 	<ul style="list-style-type: none"> ▪ Ausgleichen von Achsversatz zwischen Kernlochbohrung und Spindel 	<ul style="list-style-type: none"> ▪ kein Verschneiden der Gewinde, Gewindequalität in Ordnung
Features:	Advantages:	Benefits:
<ul style="list-style-type: none"> ▪ double chucking with big clamping range 	<ul style="list-style-type: none"> ▪ direct clamping of the taps 	<ul style="list-style-type: none"> ▪ no quick change adaptors required
<ul style="list-style-type: none"> ▪ adjustable safety clutch 	<ul style="list-style-type: none"> ▪ to avoid tap breakage 	<ul style="list-style-type: none"> ▪ less tooling and refinishing costs
<ul style="list-style-type: none"> ▪ length compensation on tension and compression 	<ul style="list-style-type: none"> ▪ to compensate the difference between tap pitch and feed rate of the machine 	<ul style="list-style-type: none"> ▪ correct threads in a good quality, less tap wear
<ul style="list-style-type: none"> ▪ float function 	<ul style="list-style-type: none"> ▪ to compensate misalignment between core drill hole and spindle 	<ul style="list-style-type: none"> ▪ good thread quality

DSPL – Gewindeschneidfutter
DSPL – Tapping chucks

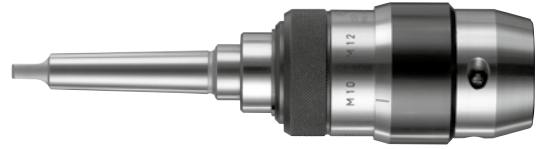
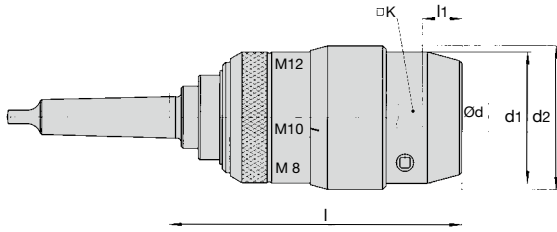

DIN 228 B



DSPL/MK													
Bezeichnung/Id. Nr. Designation/Id. No.	Ø d	□ K			max Nm				d1	d2	l	l1	
DSPL12/MK2 6707468	2,5-10	0-8	M3-M12	1/8"-1/2" 1/8"	28	1	10	20	53	58	135	18-20	V 12-SW 4,5 6707459
DSPL12/MK3 6707469	2,5-10	0-8	M3-M12	1/8"-1/2" 1/8"									1
DSPL20/MK3* 6707489	6-16	4,7-12	M8-M20	1/4"-13/16" 1/8"-1/2"	90	1,5	10	20	76	83	170	23-28	V 20-SW 6 6707460
DSPL20/MK4* 6707490	6-16	4,7-12	M8-M20	1/4"-13/16" 1/8"-1/2"									1,5
DSPL30/MK4* 6707508	11-23	0-18	M14-M30	9/16"-1.1/8" 1/4"-7/8"	280	2	10	30	100	106	230	25-34	V 30-SW 9 6707466
DSPL30/MK5* 6707509	11-23	0-18	M14-M30	9/16"-1.1/8" 1/4"-7/8"									2
DSPL42/MK5* 6707526	14-32	11-24	M18-M42	11/16"-1.5/8" 1/2"-1.1/4"	630	2	10	30	120	125	269	41-48	V 42-SW 10 6707467
DSPL42/MK6* 6707527	14-32	11-24	M18-M42	11/16"-1.5/8" 1/2"-1.1/4"									2

* DIN 1806

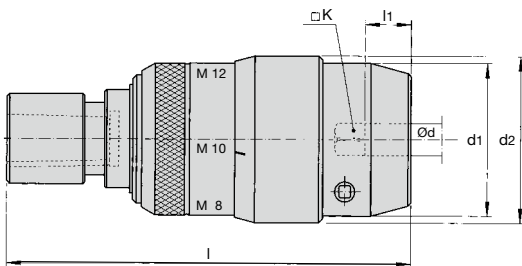

DIN 238



DSPL/B													
Bezeichnung/Id. Nr. Designation/Id. No.	Ø d	□ K			max Nm				d1	d2	l	l1	
DSPL12/B16 6707473	2,5-10	0-8	M3-M12	1/8"-1/2" 1/8"	28	1	10	20	53	58	148	18-20	V 12-SW 4,5 6707459
DSPL20/B22 6707493	6-16	4,7-12	M8-M20	1/4"-13/16" 1/8"-1/2"									1,5
DSPL30/B24 6707513	11-23	0-18	M14-M30	9/16"-1.1/8" 1/4"-7/8"	280	2	10	30	100	106	257	25-34	V 30-SW 9 6707466

DSP-D – Gewindeschneidfutter
DSP-D – Tapping chucks

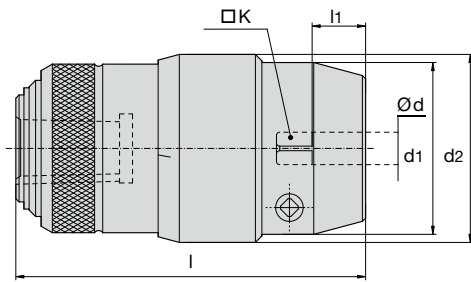

DSP/B											
Bezeichnung/Id. Nr. Designation/Id. No.	Ø d	□ K			max Nm		d1	d2	l	l1	
DSP12/B16 6707479	2,5-10	0-8	M3-M12	1/8"-1/2" 1/8"	28	1	53	58	108	18-20	V 12-SW 4,5 6707459
DSP20/B18 6707498	6-16	4,7-12	M8-M20	1/4"-13/16" 1/8"-1/2"	90	1,5	76	83	142	23-28	V 20-SW 6 6707460
DSP20/B22 6707499	6-16	4,7-12	M8-M20	1/4"-13/16" 1/8"-1/2"	90	1,5	76	83	142	23-28	V 20-SW 6 6707460
DSP30/B24 6707516	11-23	0-18	M14-M30	9/16"-11/8" 1/4"-7/8"	280	2	100	106	204	25-34	V 30-SW 9 6707466

DIN 238

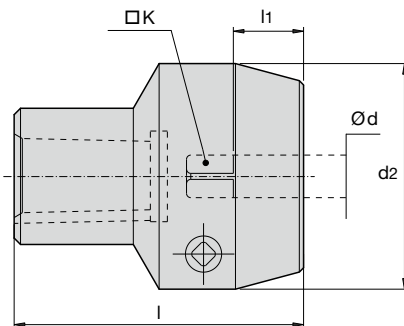

D/B									
Bezeichnung/Id. Nr. Designation/Id. No.	Ø d	□ K			max Nm	d2	l	l1	
D12/B16 6707482	2,5-10	0-8	M3-M12	1/8"-1/2" 1/8"	28	53	60	18-20	V 12-SW 4,5 6707459
D20/B18 6707501	6-16	4,7-12	M8-M20	1/4"-13/16" 1/8"-1/2"	90	76	79	23-28	V 20-SW 6 6707460
D20/B22 6707502	6-16	4,7-12	M8-M20	1/4"-13/16" 1/8"-1/2"		76	88	23-28	V 20-SW 6 6707460
D30/B24 6707517	11-23	0-18	M14-M30	9/16"-11/8" 1/4"-7/8"	280	100	123	25-34	V 30-SW 9 6707466
D42/B24 6707530	14-32	11-24	M18-M42	11/16"-15/8" 1/2"-11/4"	620	120	152	41-48	V 42-SW 10 6707467

DIN 238

Kegeldorne siehe Seite 142
 Arbor see page 142

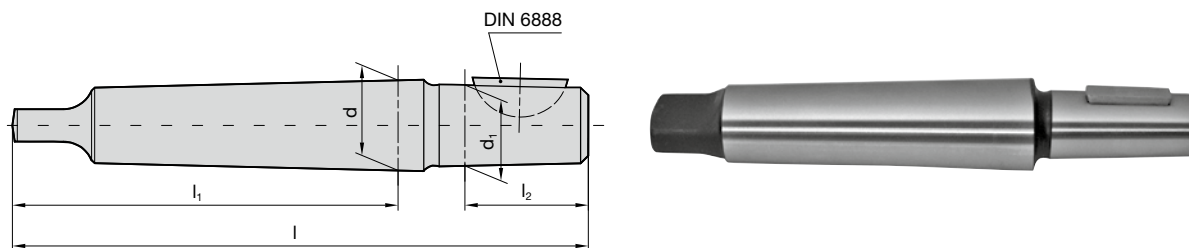

Kegeldorn DIN 238 mit Scheibenfeder DIN 6888
Arbor DIN 238 with woodruff key DIN 6888

Bezeichnung / Id. Nr. Designation / Id. No.		Ø d	Ø d1	l	l1	l2	DIN6888
B16xMK2 6816002	DSP12/B16	17,780	15,733	112	75	24	4 x 7,5
B16xMK3 6816003	D12/B16	23,825	15,733	134	94	24	4 x 7,5
B18xMK3 6818003	DSP20/B18	23,825	17,780	140	94	32	5 x 9
B18xMK4 6818004	D20/B18	31,267	17,780	165	117,5	32	5 x 9
B22xMK3 6822003	DSP20/B22	23,825	21,793	147	94	40,5	5 x 9
B22xMK4 6822004	D20/B22	31,267	21,793	176	117,5	40,5	5 x 9
B24xMK4 6824004	DSP30/B24	31,267	23,825	186	117,5	50,5	6 x 9
B24xMK5 6824005	D30/B24	44,399	23,825	221	149,5	50,5	6 x 9
B24xMK5 6824005	D42/B24	44,399	23,825	221	149,5	50,5	6 x 9



V-SW

Bezeichnung Designation	Id. Nr. Id. No.	für for	D, DSPL, DSP
V 12 - SW 4,5	6707459	12	
V 20 - SW 6	6707460	20	
V 30 - SW 9	6707466	30	
V 42 - SW 10	6707467	42	

Montageanleitung

Halten Sie die Werkzeugaufnahme in der Maschinenspindel sauber.

Halten Sie das Werkzeug sicher beim Werkzeugwechsel, damit beim Lösen der Werkzeugspannung das Werkzeug nicht in den Maschinenraum fällt und dadurch das Werkzeug und Werkstück beschädigt werden.

Beachten Sie die Werkzeugabmessungen und Angaben des Maschinenherstellers.

Doppelspannung (Drei- und Vierkantbackensatz)

** Siehe Hinweis in "Einspannen Gewindebohrer" in Bedienungsanleitung

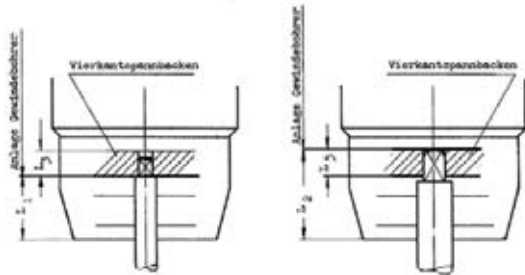

Durch die Doppelspannung wird eine hohe Spannkraft erreicht. Es genügt deshalb ein leichtes Spannen mit dem Vierkantschlüssel.

Bevorzugte Aufnahmen: Morsekegel MK-DIN228A und Bohrfutterkegel B-DIN238

Bei kundenspezifischen Spindelausführungen, wenden Sie sich bitte an die Technische Kundenbetreuung der Fa. BILZ.

Bedienungsanleitung

Einspannen Gewindebohrer:

Bei Einspannen des Werkzeuges ist darauf zu achten, dass der Vierkantbackensatz am Vierkant des Gewindebohrers anliegt. Der Vierkant darf also nicht über Eck eingespannt werden.

Dies prüft man besten, wenn man das Futter wieder leicht öffnet und probiert ob sich das Werkzeug noch drehen lässt.

Wenn die Mitnahme nicht einwandfrei ist, muss das Werkzeug ein wenig verdreht und bei kleineren Gewindebohrern, deren Vierkant kürzer sein kann als die Höhe des Vierkantbackensatzes, muss der Gewindebohrer etwas vorgezogen werden.**

Einstellen Sicherheitskupplung:

Zum Einstellen des Drehmomentes wird die gerändelte Einstellhülse axial in Richtung des Spannkopfes verschoben und danach die Skala verdreht bis die gewünschte Gewindegröße über der horizontalen Markierung sichtbar ist.

Im Linkslauf rastet die Kupplung wieder ein und der Gewindebohrer wird zwangsläufig herausgedreht

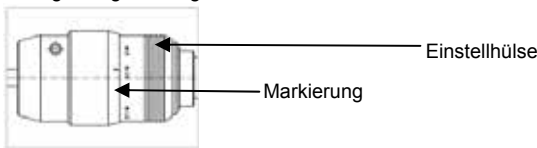

Achspanparallele Pendelung:

Damit werden Achsversatz zwischen Gewindebohrer und Werkstück ausgeglichen, so dass trotzdem toleranzhaltige Gewinde erzielt werden können und außerdem der Gewindebohrer weitgehend geschont wird.

Längenausgleich:

Der Längenausgleich gleicht Unterschiede zwischen der Gewindebohrersteinigung und dem maschinellen Vorschub aus. Es sollte nach Möglichkeit immer leicht im Zugbereich gearbeitet werden, d.h. der Vorschub sollte ca. 5% kleiner sein.

Erläuterung der Bezeichnung:

D nur Doppelspannung
 DSP Doppelspannung, Sicherheitskupplung und Pendelung
 DSPL Doppelspannung, Sicherheitskupplung, Pendelung, Längenausgleich

Installation Instruction

Keep clean the tool holder location in the machine spindle.

Hold the tool safe when changing tools, so when releasing the tool, the tool does not fall into the engine room and damaging the tool and / or work piece.

Note the tool dimensions and the machine manufacturer.

Double chucking (three- und four set of jaws)

** See note at "clamping taps" in operating manual

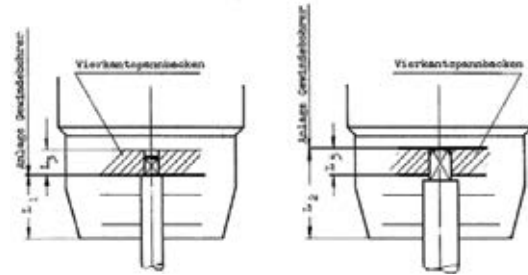

By the double chucking fixture a high clamping force is reached. It suffices therefore a little tension with the square key.

Favorite locations are: Morse taper MT-DIN228A and bore taper B-DIN238

For customer-specific spindle designs, please contact the Technical Service of the company BILZ.

Operating Manual

Clamping of taps:

When clamping of the tool is to make sure that the square jaw set rests on the square of the tap. The square should not be clamped around the corner.

This is best checked when the jaws slightly open and tried to turn the tool. If the tool can not be turned it is correct. When the driving is not working properly, the tool must be rotated a little, and at smaller taps whose square may be shorter than the height of the square jaw set, the taps should be pulled out a little.

Adjusting of the safety clutch:

For adjusting the torque is the knurled sleeve. Move axially in the direction of the clamping head, and then the scale twisted until the desired thread size to the horizontal mark visible.

Reversing the spindle re-engages the clutch and the tap is automatically turned out of the thread.

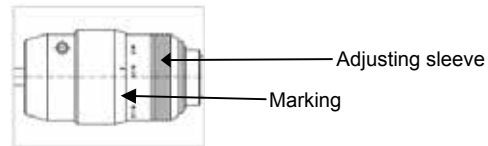

Axial floating (parallel):

Thus offset between tap and work piece are compensated, so that nevertheless tolerance-thread can be achieved and also the tap is largely protected.

Length compensation (tension and compression):

The tension and compression compensates differences between the thread pitch and the feed. It should be possible, always worked easily in the tensile zone. The feed should be about 5% less.

Explanation of the term:

D only double chucking feature
 DSP double chucking, safety clutch and parallel float
 DSPL double chucking, safety clutch and parallel float, length compensation

Anwendung: Gewindeschneiden, -formen auf Maschinen mit angetriebener Spindel und manuellem Vorschub
Maschinentyp: Ständer-/Auslegerbohrmaschinen, Maschinen mit angetriebener Spindel

Application: tapping, roll forming on machines with a driven spindle and manual feed
Machine type: drilling machines, machines with driven spindle

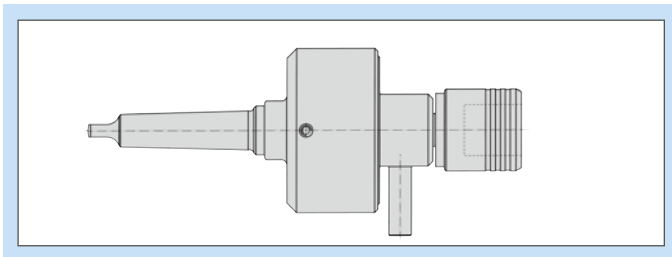

Diese Apparate sind für das Gewindeschneiden auf Bohrmaschinen mit Handvorschub und ohne Spindelreversierung ausgelegt.

Beim Einsetzen in die Maschine muss der Stopparm gegen Verdrehen gesichert werden, damit die Funktion des Apparates gewährleistet ist.

Die Apparate sind wartungsfrei und für Rechts- und Linksgewinde einsetzbar.

Durch das integrierte Wendegetriebe ist Gewindeschneiden ohne Spindelreversierung möglich.

Durch Zurücknehmen der Maschinenspindel nach Erreichen der Gewindetiefe schaltet der Apparat selbsttätig um. Der Umschaltvorgang erfolgt über ein verschleißarmes Kugelsystem.

Die Gewindebohrer werden in Bilz-WE... bzw. WES Einsätzen gespannt und über ein Schnellwechselsystem im Apparat aufgenommen. Für die unterschiedlichen Gewindebohrer ist je ein Einsatz erforderlich. Einsätze WES mit einstellbarer Drehmomentkupplung schützen den Gewindebohrer vor Bruch.

This self reversing tapping attachment is designed for use on drilling machines which have only manual feed facilities and which do not have a reversible spindle.

The tool design is simple, effective, and is virtually maintenance free. The unit is fitted into the machine spindle by virtue of its morse taper shank, with the stop arm located against the column of the drilling machine to ensure effective and positive action. The design of the units is such that it can be used for either right or left handed tapping operations.

The design of the unit is such that tapping and reversing is possible without changing the direction of the machine spindle.

The unit automatically changes direction when the required thread depth has been achieved.

The unit accepts both Bilz WE and WES tap adaptors which facilitate quick tap change, a separate tap adaptor is required for each size of tap shank.

The use of WES tap adaptors gives additional security against tap breakage by means of the clutch mechanism.

Merkmale:	Vorteile:	Nutzen:
<ul style="list-style-type: none"> ▪ Gewindebohrer-Schnellwechselsystem 	<ul style="list-style-type: none"> ▪ schneller Werkzeugwechsel 	<ul style="list-style-type: none"> ▪ keine zusätzlichen Werkzeuge/ Schlüssel zum Werkzeugwechsel erforderlich
<ul style="list-style-type: none"> ▪ auswechselbarer, eingeschraubter Schaft 	<ul style="list-style-type: none"> ▪ höhere Flexibilität 	<ul style="list-style-type: none"> ▪ durch Tausch des Schaftes auf Maschinen mit verschiedenen Spindelaufnahmen einsetzbar
<ul style="list-style-type: none"> ▪ doppelter Vorschub im Rücklauf 	<ul style="list-style-type: none"> ▪ kürzere Bearbeitungszeiten durch höhere Rücklaufgeschwindigkeit 	<ul style="list-style-type: none"> ▪ Reduzierung der Bearbeitungszeit
<ul style="list-style-type: none"> ▪ keine Sicherheitskupplung im Apparat 	<ul style="list-style-type: none"> ▪ kostengünstiger 	<ul style="list-style-type: none"> ▪ Verwendung von Einsätzen mit Sicherheitskupplung nur wenn notwendig, z.B. Grundloch
<ul style="list-style-type: none"> ▪ wartungsfrei 	<ul style="list-style-type: none"> ▪ keine Ausfallzeiten durch Wartungen 	<ul style="list-style-type: none"> ▪ Reduzierung der Stillstandzeiten bzw. keine Ersatzgeräte erforderlich
<ul style="list-style-type: none"> ▪ Apparat ist einsetzbar für Links- und Rechtsgewinde 	<ul style="list-style-type: none"> ▪ nur ein Apparat erforderlich 	<ul style="list-style-type: none"> ▪ Reduzierung der Werkzeuganzahl
<ul style="list-style-type: none"> ▪ integriertes Wendegetriebe 	<ul style="list-style-type: none"> ▪ selbstreversierend durch Betätigung des Längenausgleichs 	<ul style="list-style-type: none"> ▪ Zeitersparnis durch Wegfall der Drehrichtungsumkehr der Maschine und Maschinenschonung wegen entfallendem Abbremsen und Beschleunigen. Energieeinsparung!
Features:	Advantages:	Benefits:
<ul style="list-style-type: none"> ▪ quick change system for tap adaptors 	<ul style="list-style-type: none"> ▪ quick tool change 	<ul style="list-style-type: none"> ▪ no additional tools required for the tool change
<ul style="list-style-type: none"> ▪ exchangeable, screwed-in shank 	<ul style="list-style-type: none"> ▪ higher flexibility 	<ul style="list-style-type: none"> ▪ by changing the shank, the unit can be used on different machines with other spindle locations
<ul style="list-style-type: none"> ▪ double feed rate on reverse motion 	<ul style="list-style-type: none"> ▪ shorter processing time due to higher feed rate on reverse motion 	<ul style="list-style-type: none"> ▪ shorter processing time
<ul style="list-style-type: none"> ▪ no built-in safety clutch in the unit 	<ul style="list-style-type: none"> ▪ unit price is cheaper 	<ul style="list-style-type: none"> ▪ application adaptors with safety clutch only when it is necessary e.g. ground holes
<ul style="list-style-type: none"> ▪ free of maintenance 	<ul style="list-style-type: none"> ▪ no down time due to service of the unit 	<ul style="list-style-type: none"> ▪ reduction of the down time, no spare units required
<ul style="list-style-type: none"> ▪ unit can be used for right and left handed threads 	<ul style="list-style-type: none"> ▪ just one unit required 	<ul style="list-style-type: none"> ▪ reduction of the number of tools
<ul style="list-style-type: none"> ▪ integrated reversible gear 	<ul style="list-style-type: none"> ▪ self reversing by using the length compensation of the unit 	<ul style="list-style-type: none"> ▪ time reduction due to not reversing the machine spindle, machine protection due to not slowing down and speeding up the machine. Energy saving!

TA – Gewindeschneid-Apparat
TA – Tapping attachment

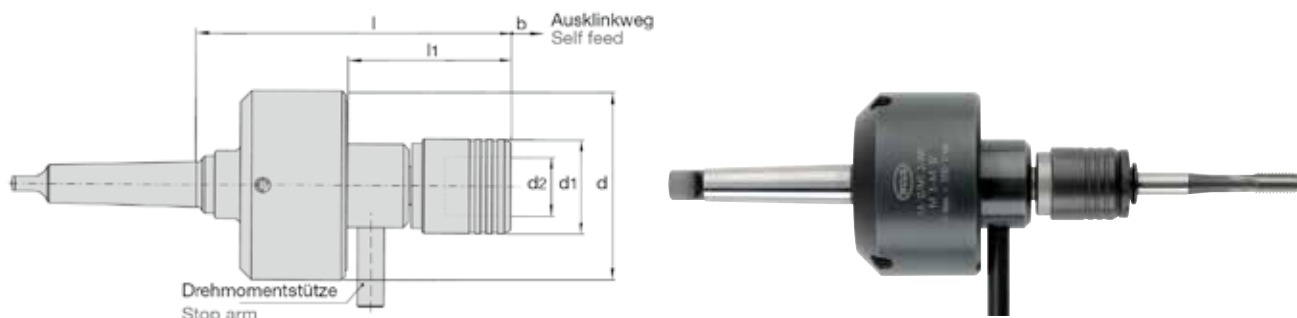

DIN
228 B



TA/MK-WF											
Bezeichnung/Id. Nr. Designation/Id. No.			$n_{max.}$ [min ⁻¹] [rpm]	b	d	d1	d2	l	l1		i
TA12/MK2-WF 6705096	1	M3-M12	1200	6	80	32	19	140	60	12,5	1,73
TA12/MK3-WF 6705099	1	M3-M12	1200	6	80	32	19	140	60	12,5	1,73
TA20/MK3-WF 6705097	2	M8-M20	500	8	100	50	31	170	86	16,5	1,88
TA20/MK4-WF 6705100	2	M8-M20	500	8	100	50	31	170	86	16,5	1,88

i = Übersetzungsverhältnis Linkslauf
i = gear ratio anti clockwise

Passende Schnellwechsel-Einsätze siehe Seite 98 – 132
Suitable quick change adaptors see page 98 – 132

Anwendung:

Der Gewindeschneid-Apparat ist für den Einsatz auf Säulenbohrmaschinen mit Morsekegel-Spindelaufnahme, ohne Drehrichtungsänderung der Spindel geeignet.

Application:

The tapping attachment is designed for use on vertical drilling machines which use a morse taper spindle location, the attachment is designed to be used without any change in the spindle direction.

Bedienung:

Vor Inbetriebnahme muss die Anschlagstange am Gehäuse montiert und an der Maschine ein entsprechender Gegenhalter angebracht werden.

Beim Gewindeschneiden erfolgt die Umschaltung der Drehrichtung durch Zurückziehen der Maschinenspindel mit etwa doppelter Vorschubgeschwindigkeit.

Operation:

Before operation, the stop arm should be located in the tapped hole on the main body of the tapping attachment and screwed into position. The other end of the stop arm should then be in contact with either the main pillar of the drilling machine or an appropriate stop device mounted on the machine, the purpose of this is to prevent the tapping attachment rotating. On the way out use approximately double feed rate.

Wartung:

Der Gewindeschneid-Apparat ist wartungsfrei.

Maintenance:

The tapping attachment is maintenance free.

Sicherheitshinweis:

Beim Einwechseln der Schnellwechsel-Einsätze in den Futterkopf ist darauf zu achten, dass diese richtig einrasten.

Die Anschlagstange darf nicht von Hand gehalten werden und der Sicherheitsabstand des Bedieners zur Maschine soll größer als die Länge der Anschlagstange sein.

Die max. Drehzahl der App. Typ TA 12 beträgt 1200 min⁻¹.

Die max. Drehzahl der App. Typ TA 20 beträgt 500 min⁻¹.

Der Schneidbereich der Größe TA 12 ist von M 3 bis M 12.

Der Schneidbereich der Größe TA 20 ist von M 8 bis M 20.

Bei der Bearbeitung von Grundlöchern müssen Schnellwechsel-Einsätze mit Sicherheitskupplung verwendet werden.

Safety precautions:

When changing adaptors in the chuck head, care should be taken to ensure that the adaptor is correctly located in the chuck of the attachment. The stop arm must not be held in the hand and a safe distance between the operator and the machine should be greater than the length of the stop arm.

Max. RPM for TA 12 is 1200 per minute

Max. RPM for TA 20 is 500 per minute

The tapping range for TA 12 is M 3 - M 12

The tapping range for TA 20 is M 8 - M 20.

Quick change adaptors with safety clutch must be used when tapping blind holes.

Bei Nichtbeachten obiger Punkte besteht Verletzungsgefahr für den Bediener!

Risk of injury to the operator if the above precautions are not followed!

Anwendung: Gewindeschneiden, -formen, Bohren, Senken, Fasen, Reiben,
Maschinentyp: Bohr-, Radialbohrmaschinen, Sondermaschinen, NC-Maschinen

Application: tapping, roll forming, drilling, counterboring, chamfering, reaming,
Machine type: machining centres and special purpose machines

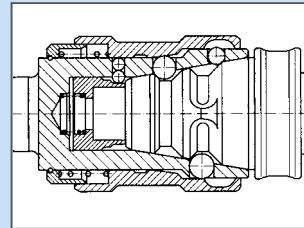
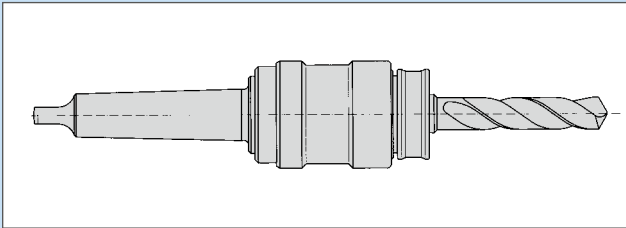

Schnellwechsel-Bohrfutter und -einsätze für Bohr-, Reib-, Senk- und Gewindeschneidwerkzeuge

Mit diesem Schnellwechselsystem können auf Bohr- und Radialbohrmaschinen sowie auf NC-gesteuerten Bohrmaschinen verschiedene Arbeitsgänge in einer Werkstückaufspannung durchgeführt werden.

Das Doppelkugelspannsystem gewährleistet eine sichere Drehmomentübertragung und einen spielfreien Sitz der Einsätze im Futter.

Die Einsätze sind ohne Hilfswerkzeug schnell wechselbar und werden beim Einstoßen in das Futter automatisch verriegelt. Durch axiales Verschieben der Schalthülse werden die Einsätze entriegelt.

Der Werkzeugwechsel muss bei stehender Spindel erfolgen. Durch kurze Ein- und Ausfahrwege der Einsätze ist sekunden-schneller Werkzeugwechsel möglich.

Das Schnellwechselsystem ist horizontal und vertikal sowie für Rechts- und Linkslauf verwendbar.

SBK-Futter und SEK-Einsätze für innere Kühlmitteldurchführung sind auf Anfrage lieferbar.

In Sonderausführung ist das Schnellwechselsystem auch für den vollautomatischen Werkzeugwechsel in Verbindung mit Sondermaschinen einsetzbar.

Hinweis:

Nicht geeignet für radiale Belastung z.B. Fräsen und Zugbelastung z.B. Rückwärtssenken.

Quick change drilling chucks and adaptors for drilling, reaming, and tapping tools

The SBK quick change system is for use on drilling machines, either manual, radial or NC controlled. The system is designed to enable numerous functions to be carried out whilst utilising a single toolholder.

The unique double ball clamping gives a positive drive and allows the precise location of the SEK adaptor in the chuck. The adaptors, which take drills, reamers, counterbores or tapping equipment, can be changed quickly without the use of additional tools, and are automatically located in the chuck. They are released by retracting the outer sleeve of the chuck axially, which then allows the adaptor to be removed with ease.

The changing of tools can take place either when the machine spindle is stopped.

The steep location taper of the unit allows a rapid tool change and the system is designed that the unit can operate in both the vertical or horizontal plane, and for left or right hand rotation.

SBK holders and SEK adaptors can be supplied with internal coolant feed on request.

A custom design of this quick change system is available for fully automatic tool change units on special machines.

Note:

Not suitable for operations with radial forces. E.g. milling and tension forcer e.g. back spotfacing.

Merkmale:	Vorteile:	Nutzen:
<ul style="list-style-type: none"> ▪ Schnellwechseleinrichtung mit automatischer Verriegelung der Einsätze im Futter 	<ul style="list-style-type: none"> ▪ keine zusätzlichen Werkzeuge/ Hilfsmittel erforderlich beim Werkzeugwechsel 	<ul style="list-style-type: none"> ▪ Suche nach Hilfswerkzeugen entfällt ▪ Stillstandszeiten werden reduziert
<ul style="list-style-type: none"> ▪ hohe Rundlaufgenauigkeit der Einsätze im Futter (3/100) 	<ul style="list-style-type: none"> ▪ höhere Bearbeitungsgenauigkeit ▪ geringerer Werkzeugverschleiß 	<ul style="list-style-type: none"> ▪ bessere Werkstückqualität, Kosteneinsparung Werkzeugbeschaffung
<ul style="list-style-type: none"> ▪ axiale und radiale Spielfreiheit 	<ul style="list-style-type: none"> ▪ höhere Rundlaufgenauigkeit 	<ul style="list-style-type: none"> ▪ bessere Werkstückqualität, Kosteneinsparung Werkzeugbeschaffung
<ul style="list-style-type: none"> ▪ konische Aufnahme zwischen Futter und Einsatz 	<ul style="list-style-type: none"> ▪ axiale und radiale Spielfreiheit 	<ul style="list-style-type: none"> ▪ kurze Wechselwege durch konische Aufnahme
<ul style="list-style-type: none"> ▪ kurze Wechselwege durch konische Aufnahme im Futter 	<ul style="list-style-type: none"> ▪ kürzere Verfahwege 	<ul style="list-style-type: none"> ▪ Zeitersparnis
<ul style="list-style-type: none"> ▪ vertikal und horizontal einsetzbar 	<ul style="list-style-type: none"> ▪ höhere Flexibilität 	<ul style="list-style-type: none"> ▪ weniger Spannmittel erforderlich
<ul style="list-style-type: none"> ▪ für Rechts- und Linkslauf verwendbar 	<ul style="list-style-type: none"> ▪ höhere Flexibilität 	<ul style="list-style-type: none"> ▪ höhere Flexibilität
<ul style="list-style-type: none"> ▪ Futter verbleibt ständig in der Maschinenspinde 	<ul style="list-style-type: none"> ▪ nur die Einsätze werden gewechselt über das Schnellwechselsystem 	<ul style="list-style-type: none"> ▪ kein umständlicher Wechsel der Werkzeuge mit Morsekegel ▪ weniger Verschleiß an der Spindel
Features:	Advantages:	Benefits:
<ul style="list-style-type: none"> ▪ quick change feature with automatic locking of the adaptors in the chuck 	<ul style="list-style-type: none"> ▪ no additional tools/accessories required for the tool change 	<ul style="list-style-type: none"> ▪ Search for accessories not applicable ▪ Reduced down time of the machine
<ul style="list-style-type: none"> ▪ high concentricity of the adaptors in the chuck (3/100) 	<ul style="list-style-type: none"> ▪ higher accuracy, less tool wear 	<ul style="list-style-type: none"> ▪ better work piece quality, cost reduction for tooling
<ul style="list-style-type: none"> ▪ free of axial and radial play 	<ul style="list-style-type: none"> ▪ high concentricity 	<ul style="list-style-type: none"> ▪ better work piece quality, cost reduction for tooling
<ul style="list-style-type: none"> ▪ conical location between chuck and adaptor 	<ul style="list-style-type: none"> ▪ axial and radial free of gap 	<ul style="list-style-type: none"> ▪ short tool changing ways through conical location
<ul style="list-style-type: none"> ▪ short tool changing ways through conical location 	<ul style="list-style-type: none"> ▪ reduced travels, spindle movements 	<ul style="list-style-type: none"> ▪ time reduction
<ul style="list-style-type: none"> ▪ can be used horizontally or vertically 	<ul style="list-style-type: none"> ▪ higher flexibility 	<ul style="list-style-type: none"> ▪ less clamping tools required
<ul style="list-style-type: none"> ▪ suitable for right and left hand rotation 	<ul style="list-style-type: none"> ▪ higher flexibility 	<ul style="list-style-type: none"> ▪ less clamping tools required
<ul style="list-style-type: none"> ▪ chuck always stays in the machine spindle 	<ul style="list-style-type: none"> ▪ only the adaptors will be changed by the quick change system 	<ul style="list-style-type: none"> ▪ no laborious tool change of the tools with morse taper any more ▪ less wear at the machine spindle

SBK – Schnellwechsel-Bohrfutter
SBK – Quick change drilling chucks

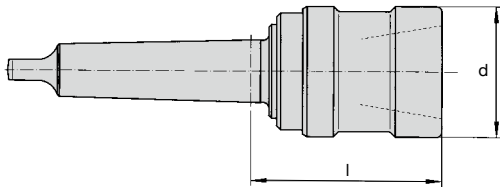

DIN
238

SBK/MK

Morsekegel DIN 228 B
Morse taper DIN 228 B

Bezeichnung Designation		d		MK2	MK3	MK4	MK5
SBK2/MK...	2	50	l	75	75	–	–
			Id. No.	6723619	6723620	–	–
SBK3/MK...	3	60	l	–	88	89	–
			Id. No.	–	6723648	6723649	–
SBK4/MK...	4	72	l	–	–	102	102
			Id. No.	–	–	6723668	6723669

Ab MK3 mit Querkeilnut
From MK3 with cross wedge groove

SEK – Schnellwechsel-Einsatz
SEK – Quick change adaptor

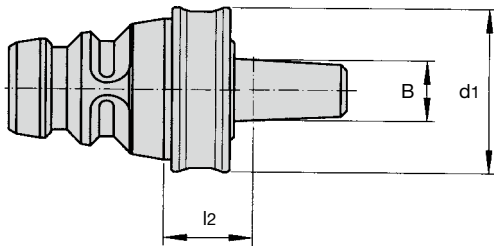

DIN
238

SEK/B

Mit Bohrfutterkegel DIN 238. Zur Aufnahme von Spannfuttern mit Bohrfutterkegel
With stub taper DIN 238. For tools with stub taper

Bezeichnung Designation		d1		B12	B16
SEK2/B...	SBK2	42	l2	21,5	23
			Id. No.	6723632	6723633
SEK3/B...	SBK3	50	l2	–	25,5
			Id. No.	–	6723657
SEK4/B...	SBK4	60	l2	–	38,5
			Id. No.	–	6723680

SEK – Schnellwechsel-Einsatz
SEK – Quick change adaptor

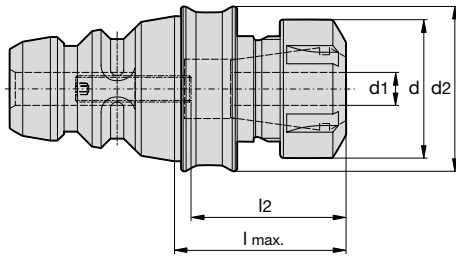

SEK/ESX

Für Spannzangen Typ ER/ESX, DIN 6499
 For collets type ER/ESX, DIN 6499

Bezeichnung/Id. Nr. Designation/Id. No.			d1	l2		d	d2	l
				min	max			
SEK2/ESX16 6723783	SBK2/...	ESX 16	1-3	21	33	32	42	40
			> 3-10	31	43			
SEK2/ESX20 6723640	SBK2/...	ESX 20	1-6,5	22	34	34	42	46
			> 6,5-13	35	47			
SEK3/ESX25 6723744	SBK3/...	ESX 25	2-5	24	36	42	50	52
			> 5-16	31	51			
SEK3/ESX32 6723790	SBK3/...	ESX 32	3-6	29	41	50	50	53
			> 6-20	44	56			
SEK3/ESX40 6723780	SBK3/...	ESX 40	4-6	35	47	63	60	73
			> 6-26	42	62			
SEK4/ESX32 5071653	SBK4/...	ESX 32	3-6	29	41	50	60	63
			> 6-20	44	56			
SEK4/ESX40 6723686	SBK4/...	ESX 40	4-6	35	47	63	60	70
			> 6-26	42	62			

ESX-Spannzangen siehe Seite 34
 ESX-collets see page 34

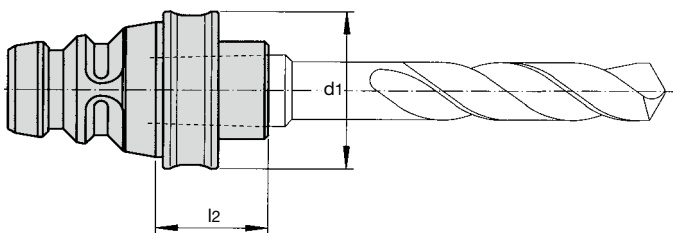

SEK/MK

Mit Morsekegel DIN 228 B. Zur Aufnahme von Morsekegelschäften mit Austreibblappen
 With internal morse taper DIN 228 B. For morse taper shanks with flat tang

Bezeichnung Designation		d1					
			MK1	MK2	MK3	MK4	
SEK2/MK...	SBK2	42	l2	18	30,5	-	-
			Id. No.	6723630	6723631	-	-
SEK3/MK...	SBK3	50	l2	20,5	20,5	38,5	-
			Id. No.	6723653	6723654	6723655	-
SEK4/MK...	SBK4	60	l2	33,5	33,5	33,5	56
			Id. No.	6723674	6723675	6723676	6723677

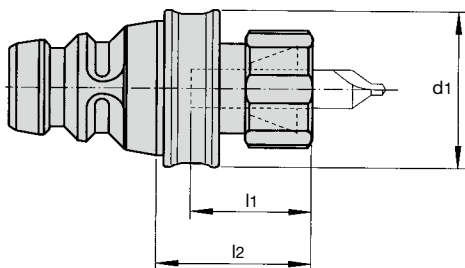

SEK – Schnellwechsel-Einsatz
SEK – Quick change adaptor



DIN
6343

SEK/RF

Für Rubber-Flex®-Spannzangen. Zur Aufnahme von Werkzeugen mit zylindrischem Schaft
 For Rubber-Flex®-collets. For tools with cylindrical shank

Bezeichnung/Id. Nr. Designation/Id. No.		d1	l1		l2	Rubber-Flex® 423	Rubber-Flex® 420	Rubber-Flex® 422	Rubber-Flex® 443	Rubber-Flex® 440	
			min.	max.		Ø 2 – 4,5	Ø 4,5 – 8	Ø 6,5 – 10	Ø 2,8 – 7	Ø 7 – 13	
SEK2/RF42 6723641	SBK 2	42	30	50	l2	42	42	42	–	–	RF42
					Id.No.	6909312	6909309	6909311	–	–	6910200
SEK3/RF44 6723659	SBK 3	50	40	60	l2	–	–	–	51	51	RF44
					Id. No.	–	–	–	6909314	6909313	6910201
SEK4/RF44 6723688	SBK 4	60	40	60	l2	–	–	–	63	63	RF44
					Id. No.	–	–	–	6909314	6909313	6910201

Rubber-Flex® Spannzangen und Spannschlüssel bitte separat bestellen
 Please order Rubber-Flex® collets and wrench separately

SELK – Schnellwechsel-Einsatz
SELK – Quick change adaptor

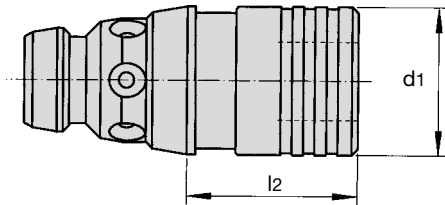

SELK							
Mit integriertem Längenausgleich. Zur Aufnahme von Gewindeschneid-Schnellwechsel-Einsätzen mit Sicherheitskupplung Typ WES							
With integrated length compensation. For tapping adaptors with safety clutch type WES							
Bezeichnung/Id. Nr. Designation/Id. No.							
						d1	l2
SELK2/1 6723643	SBK2/...	WES1 B	M3 – M12	7,5	7,5	36	42
SELK2/2 6723644		WES2 B	M8 – M20	12,5	12,5	53	72
SELK3/1 6723661	SBK3/...	WES1 B	M3 – M12	7,5	7,5	36	42
SELK3/2 6723662		WES2 B	M8 – M20	12,5	12,5	53	66
SELK3/3 6723663		WES3 B	M14 – M33	20	20	78	126
SELK4/1 6723691	SBK4/...	WES1 B	M3 – M12	7,5	7,5	36	42
SELK4/2 6723692		WES2 B	M8 – M20	12,5	12,5	53	66
SELK4/3 6723693		WES3 B	M14 – M33	20	20	78	121
SELK4/4 6723694		WES4 B	M22 – M48	22,5	22,5	96	135

Passende Schnellwechsel-Einsätze siehe Seite 98 – 132
 Suitable quick change adaptors see page 98 – 132



Anwendung: Bohren, Tieflochbohren

Maschinentyp: Tieflochbohr-, Sondermaschinen, Transferstrassen, Mehrspindelköpfe

Application: drilling, deep gun drilling operations

Machine type: deep gun drilling, special purpose machines, transfer lines, multi spindle heads

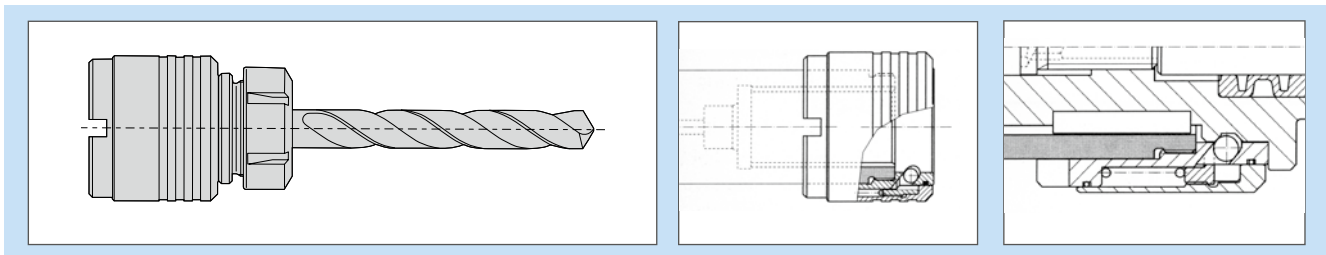

Kurzbohrspannsystem für HSS- und HM-Kurzbohrer und für Sonderbohrwerkzeuge

Das Kurzbohrspannsystem, bestehend aus Schnellwechsel-Bohrfutter und Werkzeughalter wird auf Sondermaschinen und Transferstraßen eingesetzt.

Die kurze Ausraglänge des Kurzbohrspannsystems sorgt für eine hohe Steifigkeit und eignet sich daher besonders für Bohroperationen mit Kurzbohrern ohne maschinenseitige Bohrerführung.

Die Bohrfutter werden direkt auf die Maschinenspindel aufgeschraubt. Eine Gewindegewindestift sorgt für eine gute aber wieder lösbare Verbindung.

Die automatische Verriegelung der Werkzeughalter im Futter garantiert axial spielfreies Halten durch eine neuentwickelte Rollenspanntechnik.

Gute Rundlaufeigenschaften durch enge Passungstoleranzen und eine sichere Drehmomentübertragung sind weitere Merkmale, die das Kurzbohrspannsystem auszeichnen.

Die Werkzeughalter sind mit ESX-Spannzangen oder mit zylindrischer Aufnahme nach DIN 1835 lieferbar.

Längeneinstellung der Werkzeuge außerhalb der Maschine ist durch einen verdrehsicheren Gewindestift möglich.

Das Kurzbohrspannsystem ist auch für innere Kühlmitteldurchführung lieferbar und für Rechts- und Linkslauf geeignet.

Sonderausführung auf Anfrage.

Stub drill system for HSS and Carbide stub drills and special drill applications

The Bilz stub drilling system consists of the ASR drill chuck used in conjunction with a WZHR toolholder.

It is designed for use on transfer lines and special purpose machines, the short projection length of the unit ensures rigidity and accuracy and is ideal for drilling applications without the need for bushing.

The ASR chuck is screwed directly onto the machine spindle, and is locked in position using a micro-encapsulated adhesive which provides a secure bond and can be easily cracked when the chuck is required to be removed.

The WZHR toolholder is automatically locked into the chuck and axial play is eliminated by means of a newly developed roller mechanism. The close manufacturing tolerances and positive drive combine to ensure rigidity and concentricity.

The tools can be set off the machine and the internal adjusting screw allows for easy length setting.

WZHR has versions which accept ESX collets and DIN 1835 shanks.

The system is suitable for both right and left hand operation, and it can also be supplied with a coolant feed facility if required.

Special versions of this range of tooling can be supplied on request.

Merkmale:	Vorteile:	Nutzen:
<ul style="list-style-type: none"> ▪ aufsetzbares Schnellwechselfutter 	<ul style="list-style-type: none"> ▪ Schnellwechselsystem, schneller Werkzeughalterwechsel 	<ul style="list-style-type: none"> ▪ reduzierte Stillstandszeiten der Maschine
<ul style="list-style-type: none"> ▪ kurze Auskraglänge 	<ul style="list-style-type: none"> ▪ hohe Steifigkeit ▪ keine Führungsbuchsen erforderlich 	<ul style="list-style-type: none"> ▪ hohe Rundlaufgenauigkeit ▪ längere Standzeiten
<ul style="list-style-type: none"> ▪ enge Passungstoleranzen der Spindel (h4) und der Werkzeughalter (-0.002 bis -0.005) 	<ul style="list-style-type: none"> ▪ hohe Rundlaufgenauigkeit 	<ul style="list-style-type: none"> ▪ für Hartmetallwerkzeuge geeignet ▪ längere Standzeiten ▪ weniger Werkzeugwechsel
<ul style="list-style-type: none"> ▪ Werkzeughalter mit Längennachstellung (WZHR) 	<ul style="list-style-type: none"> ▪ Längenvoreinstellung außerhalb der Maschine möglich 	<ul style="list-style-type: none"> ▪ reduzierte Stillstandszeiten der Maschine
<ul style="list-style-type: none"> ▪ Rollenspanntechnik 	<ul style="list-style-type: none"> ▪ axialspielfreies Halten 	<ul style="list-style-type: none"> ▪ weniger Werkzeugbruchgefahr
<ul style="list-style-type: none"> ▪ Schnellwechselsystem ▪ automatische Verriegelung der Werkzeughalter im Futter ▪ sehr kurze Schaltwege 	<ul style="list-style-type: none"> ▪ schneller Werkzeughalterwechsel 	<ul style="list-style-type: none"> ▪ reduzierte Stillstandszeiten der Maschine
Features:	Advantages:	Benefits:
<ul style="list-style-type: none"> ▪ over spindle quick change chuck 	<ul style="list-style-type: none"> ▪ quick change system, ▪ quick change of the tool holders 	<ul style="list-style-type: none"> ▪ reduced down time of the machine
<ul style="list-style-type: none"> ▪ short projection length 	<ul style="list-style-type: none"> ▪ high rigidity ▪ no guide bushing required 	<ul style="list-style-type: none"> ▪ high concentricity ▪ longer tool life ▪ less tool changes
<ul style="list-style-type: none"> ▪ tight tolerance in the spindle bore (h4) ▪ and at the tool holder shank ▪ (-0.002 to -0.005) 	<ul style="list-style-type: none"> ▪ high concentricity 	<ul style="list-style-type: none"> ▪ applicable for carbide tools ▪ longer tool life ▪ less tool changes
<ul style="list-style-type: none"> ▪ tool holder with built-in length ▪ adjustment (WZHR) 	<ul style="list-style-type: none"> ▪ length adjustment outside of the machine possible 	<ul style="list-style-type: none"> ▪ reduced down time of the machine
<ul style="list-style-type: none"> ▪ roller design 	<ul style="list-style-type: none"> ▪ free of axial play 	<ul style="list-style-type: none"> ▪ less risk of tool breakage
<ul style="list-style-type: none"> ▪ quick change system ▪ automatic locking of the tool holders ▪ in the chuck 	<ul style="list-style-type: none"> ▪ quick change of the tool holder 	<ul style="list-style-type: none"> ▪ reduced down time of the machine

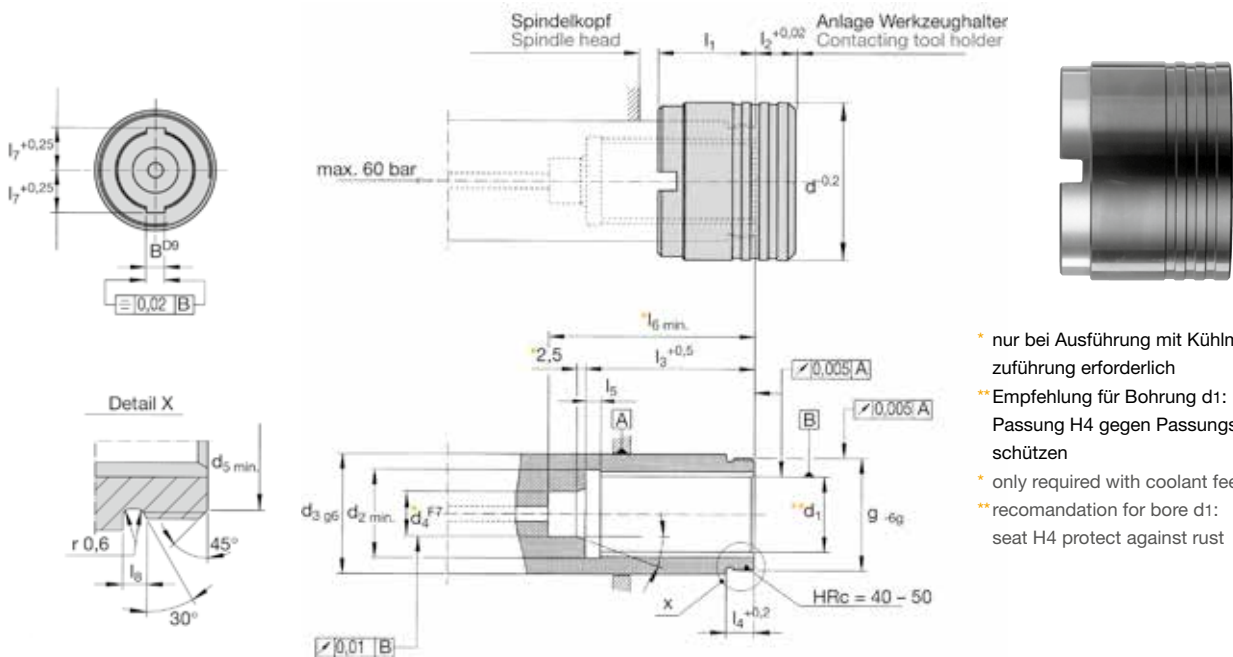

- * nur bei Ausführung mit Kühlmittel-zuführung erforderlich
- ** Empfehlung für Bohrung d1: Passung H4 gegen Passungsrost schützen
- * only required with coolant feed
- ** recommendation for bore d1: seat H4 protect against rust



ASR

Für Bohrspindelköpfe nach vorgegebener Zeichnung
For spindle heads according to drawing

Bezeichnung Designation	d	d1 H4	d2 min.	d3	d4	d5 min.	l1	l2	l3	l4	l5	l6	l7	l8	B D9	g	Id. No.
ASR 16-35	35	16	20	25	10	22,5	26	10,5	35	6,5	5	45	9,3	1,6	5	M24 x 1	6725266
ASR 20-42	42	20	24	32	12	28,5	26	11	45	7,5	5	55	11,3	1,6	5	M30 x 1	6725267
ASR 25-50	50	25	30	37	12	34,5	29	13	55	7,5	5	65	14,2	1,6	6	M36 x 1	6725268
ASR 28-52	52	28	33	40	16	36,5	29	13	61	7,5	7	73	15,7	1,6	6	M38 x 1	6725269
ASR 32-60	60	32	37	45	16	40	33	14	69,5	8,0	7	81,5	17,7	2,5	8	M42 x 1,5	6725270
ASR 36-68	68	36	41	50	16	46	37	16	80	8,5	7	92	19,7	2,5	8	M48 x 1,5	6725271
ASR20/A1-42	42	20	24	32	12	28,5	26	11	45	7,5	5	55	11,3	1,6	5	M30 x 1	6725377
ASR25/A1-50	50	25	30	37	12	34,5	29	13	55	7,5	5	65	14,2	1,6	6	M36 x 1	6725427
ASR28/A1-52	52	28	33	40	16	36,5	29	13	61	7,5	7	73	15,7	1,6	6	M38 x 1	6725378
ASR32/A1-60	60	32	37	45	16	40	33	14	69,5	8,0	7	81,5	17,7	2,5	8	M42 x 1,5	6725415
ASR36/A1-68	68	36	41	50	16	46	37	16	80	8,5	7	92	19,7	2,5	8	M48 x 1,5	6725428
ASR20/A5-42	42	20		32		28,5	26	10,9		7,5			11,3	1,6	5	M30 x 1	6725616
ASR25/A5-50	50	25		37		34,5	29	12,9		7,5			14,2	1,6	6	M36 x 1	9117359
ASR28/A5-52	52	28		40		36,5	29	12,9		7,5			15,7	1,6	6	M38 x 1	6725572
ASR32/A5-60	60	32		45		40	33	13,9		8,0			17,7	2,5	8	M42 x 1,5	6725554
ASR36/A5-68	68	36		50		46	37	15,9		8,5			19,7	2,5	8	M48 x 1,5	6725555

Standard: < 5000 min-1 + < 50 bar, passende Werkzeughalter WZHR suitable tool holders WZHR

A1-Version: > 5000 min-1 + > 50 bar, passende Werkzeughalter WZHR suitable tool holders WZHR

A5-Version: für Stellhülsen, immer SSM...M Mutter benutzen siehe Seite 168 for adjustable adaptor, always use SSM...M nut see page 168

ASR

Montageanleitung

Das Gewinde an Spindel entfetten, an drei Punkten den Kleber auftragen. Dann das ASR Futter aufschrauben und mit dem angegebenen Drehmoment anziehen.

Den Schraubensicherungskleber aushärten lassen. (ca. 8Std.)

Futter-Groesse	Anzugmoment max.
ASR16-35	10 Nm
ASR20-42	15 Nm
ASR25-50	20 Nm
ASR28-52	25 Nm
ASR32-60	35 Nm
ASR36-68	50 Nm
ASR48-95	65 Nm

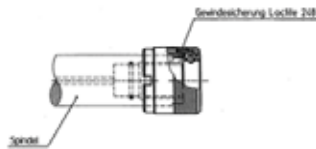

Achtung!

Benutzen Sie nur die von BILZ angegebenen Kleber LOCTITE 248 oder vergleichbare Produkte, um das Futter auf der Maschinenspindel gegen selbsttätiges Lösen zu sichern.

Die Maschinenspindel muss nach unseren Zeichnungsvorgaben ausgeführt sein. (siehe Katalog).

Wir empfehlen die H4 Passung in der Spindel gegen Passungsrost zu schützen.

Am besten vorher antikorrosiv beschichten lassen.

Benötigen Sie Futter für andere Spindelabmessungen, höhere Kühlmitteldrücke oder in Kombination Stellhülse / SSM-Mutter wenden sie sich bitte an die Technische Kundenbetreuung der Fa. BILZ.

Bedienungsanleitung

Drehen sie den Werkzeughalter so, dass die Passfeder in Richtung der in der Spindel befindlichen Nut weist. Zum Einführen des WZHR-Halters in die Maschinenspindel muss beim ASR-Futter die Schalthülse zurückgezogen werden.

Durch die beiden Zylinderrollen und die V-Rille in dem WZHR-Halter wird dieser automatisch verriegelt.

Zum Entfernen des WZHR-Halters drücken Sie die Schalthülse zurück und entnehmen sie den Halter aus der Spindel.

Schalthülse ← zurück drücken Werkzeughalter → herausziehen

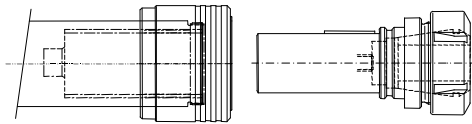

Installation Instruction

Degrease the threaded spindle, apply the adhesive at three points. Then screw the ASR on the thread at the spindle and tighten with the specified torque.

The screw lock will be harden after approx. 8 hours.

Chuck size Tightening torque

Futter-Groesse	Anzugmoment max.
ASR16-35	10 Nm
ASR20-42	15 Nm
ASR25-50	20 Nm
ASR28-52	25 Nm
ASR32-60	35 Nm
ASR36-68	50 Nm
ASR48-95	65 Nm

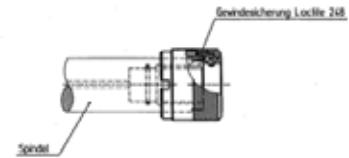

Attention!

Use only the specified BILZ adhesive LOCTITE 248 or comparable products in order to secure the chuck on the machine spindle against loosening.

The machine spindle must be executed according to our drawing specifications. (see catalog).

We recommend the H4 adaptation in the spindle to protect against rust. The best way is advanced anti-corrosive coating.

Need food for other spindle dimensions, higher coolant pressures or in combination with adjustable adaptors / SSM nuts you should contact the Technical Service of the BILZ company.

Operating Manual

Rotate the tool holder so that the key points in the direction of the spindle located in the groove. To introduce the WZHR holder in the machine spindle the shifting sleeve of the ASR has to be withdrawn.

By the two cylindrical rollers, and the V-groove in the holder WZHR this is automatically locked.

To remove the WZHR holder push back the sleeve and take out the holder from the spindle.

Switching sleeve ← push back tool holder → pull out

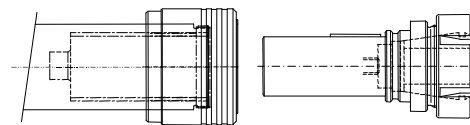

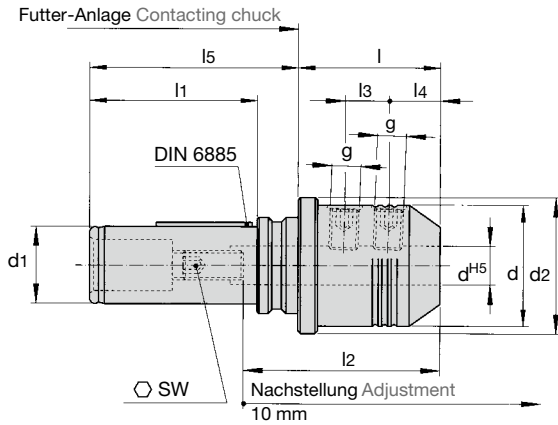

WZHR N/E

Für Werkzeuge mit Zylinderschaft DIN 1835 Form E
For tools with cylindrical shank DIN 1835 form E

Bezeichnung Designation	ASR	DIN 1835	ØdH5 Bilz- Standard	l2 max.	d	d1	d2	l	l1	l3	l4	l5	SW	g
WZHR16 N/E...	16	6	6,1- 7,9	35	25	16	28	25	35	-	18	44,5	2,5	M6
		8	8,1- 9,9	35	28	16	28	25	35	-	18	44,5	3	M8
WZHR20 N/E...	20	8	8,1- 9,9	35	28	20	35	31	44	-	18	55	3	M8
		10	10,1-11,9	39	35	20	35	31	44	-	20	55	4	M10
		12		44	38	20	38	31	44	-	22,5	55	4	M12
WZHR25 N/E...	25	8	8,1- 9,9	35	28	25	42	34	55	-	18	67	3	M8
		10	10,1-11,9	39	35	25	42	34	55	-	20	67	4	M10
		12	12,1-15,9	44	42	25	42	34	55	-	22,5	67	4	M12
		16		47	45	25	45	34	55	-	24	67	4	M14
WZHR28 N/E...	28	10	10,1-11,9	39	35	28	44	36	60	-	20	72	4	M10
		12	12,1-15,9	44	42	28	44	36	60	-	22,5	72	4	M12
		16	16,1-19,9	47	48	28	48	36	60	-	24	72	4	M14
		20		49	48	28	48	36	60	-	25	72	5	M16
WZHR32 N/E...	32	12	12,1-15,9	44	42	32	48	37	68	-	22,5	81,5	4	M12
		16	16,1-19,9	47	48	32	48	37	68	-	24	81,5	4	M14
		20		49	52	32	52	37	68	-	25	81,5	5	M16
WZHR36 N/E...	36	16	16,1-19,9	47	48	36	55	60	78	-	24	94	4	M14
		20	20,1-24,9	49	52	36	55	60	78	-	25	94	5	M16
		25		54	60	36	60	60	78	22	24	94	6	M18x2

Bestellbeispiel WZHR 16N/E6,5
Example for ordering WZHR 16N/E6,5

WZHR NK/E – Werkzeughalter mit Kühlmitteldurchführung
WZHR NK/E – Toolholders with coolant feed

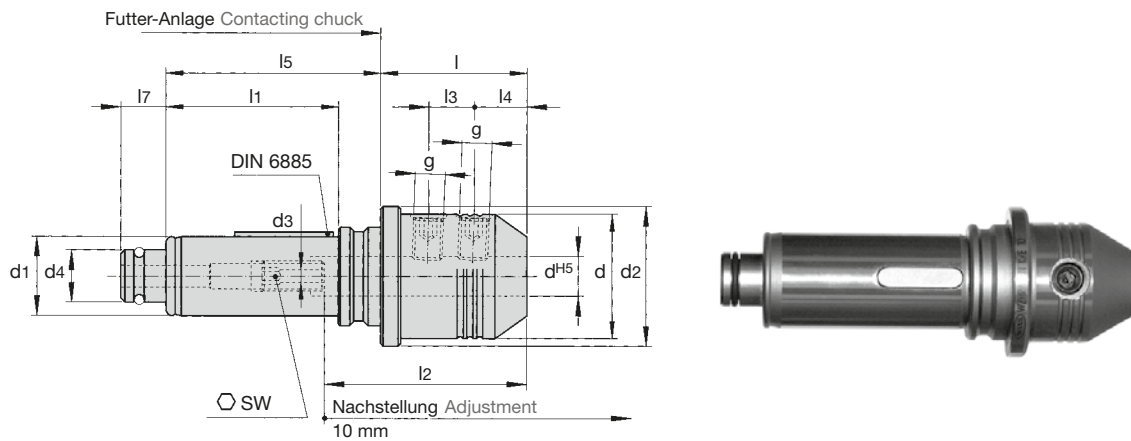

WZHR NK/E Für Werkzeuge mit Zylinderschaft DIN 1835 Form E For tools with cylindrical shank DIN 1835 form E																	
Bezeichnung Designation	ASR	DIN 1835	Ød ^{H5} Bilz- Standard	l ₂ max.	d	d ₁	d ₂	d ₃	d ₄	l	l ₁	l ₃	l ₄	l ₅	l ₇	SW	g
WZHR16 N K/E...	16	6	6,1- 7,9	35	25	16	28	2,5	10	25	35	-	18	44,5	10	2,5	M6
		8	8,1- 9,9	35	28	16	28	3	10	25	35	-	18	44,5	10	3	M8
WZHR20 N K/E...	20	8	8,1- 9,9	35	28	20	35	3	12	31	44	-	18	55	10	3	M8
		10	10,1-11,9	39	35	20	35	4	12	31	44	-	20	55	10	4	M10
		12		44	38	20	38	4	12	31	44	-	22,5	55	10	4	M12
WZHR25 N K/E...	25	8	8,1- 9,9	35	28	25	42	3	12	34	55	-	18	67	10	3	M8
		10	10,1-11,9	39	35	25	42	4	12	34	55	-	20	67	10	4	M10
		12	12,1-15,9	44	42	25	42	4	12	34	55	-	22,5	67	10	4	M12
		16		47	45	25	45	4	12	34	55	-	24	67	10	4	M14
WZHR28 N K/E...	28	10	10,1-11,9	39	35	28	44	4	16	36	60	-	20	72	12	4	M10
		12	12,1-15,9	44	42	28	44	4	16	36	60	-	22,5	72	12	4	M12
		16	16,1-19,9	47	48	28	48	4	16	36	60	-	24	72	12	4	M14
		20		49	48	28	48	5	16	36	60	-	25	72	12	5	M16
WZHR32 N K/E...	32	12	12,1-15,9	44	42	32	48	4	16	37	68	-	22,5	81,5	12	4	M12
		16	16,1-19,9	47	48	32	48	4	16	37	68	-	24	81,5	12	4	M14
		20		49	52	32	52	5	16	37	68	-	25	81,5	12	5	M16
WZHR36 N K/E...	36	16	16,1-19,9	47	48	36	55	4	16	60	78	-	24	94	12	4	M14
		20	20,1-24,9	49	52	36	55	5	16	60	78	-	25	94	12	5	M16
		25		54	60	36	60	6	16	60	78	22	24	94	12	6	M18x2

Bestellbeispiel WZHR 16N-K/E6,5
 Example for ordering WZHR 16N-K/E6,5



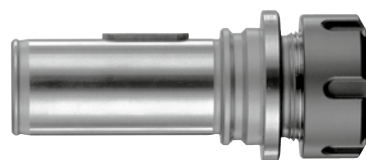
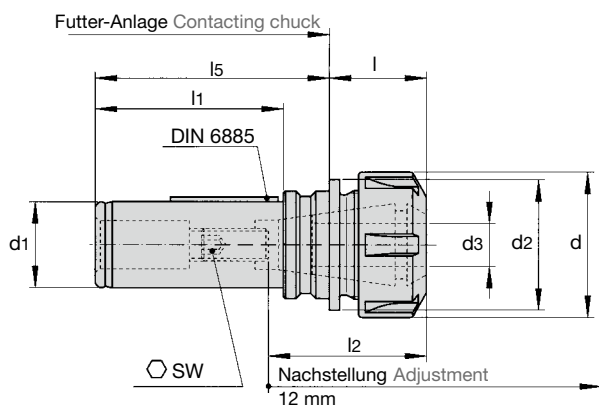

WZHR/ESX

Für Spannzangen Typ ER/ESX DIN 6499 B

For collets type ER/ESX DIN 6499 B

Bezeichnung/Id. Nr. Designation/Id. No.	ASR/ ASBRA	ESX	d3	l2 max.	d	d1	d2	l	l1	l5	SW	Id. No.
WZHR16 /ESX12 6724639	16	ESX12	1,0 - 2,5	24	19	16	28	21	35	44,5	3	DIN 894-17
>2,5 - 7,0			32	6927729								
WZHR16 /ESX16 6724640	16	ESX16	1,0 - 3,0	33	28	16	28	27	35	44,5	3	DIN 894-25
>3,0 - 10,0			43	6927733								
WZHR20 /ESX16 6724644	20	ESX16	1,0 - 3,0	33	28	20	35	27	44	55	3	DIN 894-25
>3,0 - 10,0			43	6927733								
WZHR20 /ESX20 6724646	20	ESX20	2,0 - 5,0	34	34	20	35	29	44	55	4	DIN 894-30
>5,0 - 13,0			47	6934034								
WZHR25 /ESX20 6724649	25	ESX20	2,0 - 5,0	34	34	25	42	29	55	67	4	DIN 894-30
>5,0 - 13,0			47	6934034								
WZHR25 /ESX25 6724650	25	ESX25	2,0 - 5,0	36	42	25	42	30,5	55	67	4	E 25
>5,0 - 16,0			51	6921608								
WZHR28 /ESX25 6724654	28	ESX25	2,0 - 5,0	36	42	28	44	30,5	60	72	4	E 25
>5,0 - 16,0			51	6921608								
WZHR28 /ESX32 6724656	28	ESX32	3,0 - 6,0	41	50	28	44	38	60	72	5	E 32
>6,0 - 20,0			56	6921609								
WZHR32 /ESX25 6724658	32	ESX25	2,0 - 5,0	36	42	32	48	30,5	68	81,5	4	E 25
>5,0 - 16,0			51	6921608								
WZHR32 /ESX32 6724659	32	ESX32	3,0 - 6,0	41	50	32	48	32,5	68	81,5	5	E 32
>6,0 - 20,0			53	6921609								
WZHR36 /ESX32 6724662	36	ESX32	3,0 - 6,0	41	50	36	55	32,5	78	94	5	E 32
>6,0 - 20,0			56	6921609								
WZHR36 /ESX40 6724663	36	ESX40	4,0 - 6,0	47	63	36	55	42	78	94	5	E 40
>6,0 - 25,0			62	6921610								

ESX12 lieferbar in Stufen von 0,5 mm, alle anderen Größen lieferbar in Stufen von 1 mm siehe Seite 34
ESX12 available in steps of 0,5 mm, all other sizes available in steps of 1 mm see page 34

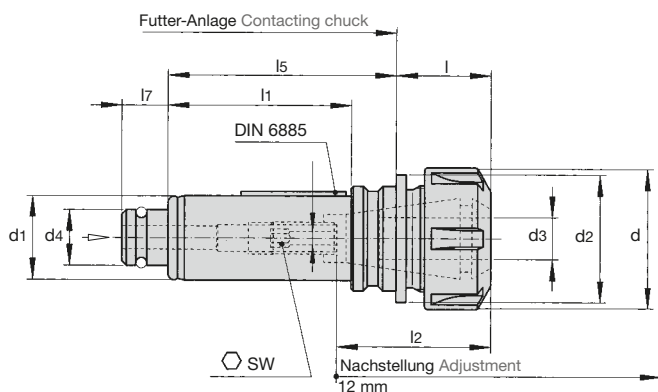

WZHR K/ESX

Für Spannzangen Typ ER/ESX DIN 6499 B

For collets type ER/ESX DIN 6499 B

Bezeichnung/Id. Nr. Designation/Id. No.	ASR/ ASBRA		d3	l2 max.	d	d1	d2	d4	l	l1	l5	l7	SW	Id. No.
WZHR16 - K/ESX12 6725245	16	ESX12	1,0 - 2,5 >2,5 - 7,0	24 32	19	16	28	10	21	35	44,5	10	3	DIN 894-17 6927729
WZHR16 - K/ESX16 6725030	16	ESX16	1,0 - 3,0 >3,0 - 10,0	33 43	28	16	28	10	27	35	44,5	10	3	DIN 894-25 6927733
WZHR20 - K/ESX16 6725178	20	ESX16	1,0 - 3,0 >3,0 - 10,0	33 43	28	20	35	12	27	44	55	10	3	DIN 894-25 6927733
WZHR20 - K/ESX20 6725010	20	ESX20	2,0 - 5,0 >5,0 - 13,0	34 47	34	20	35	12	29	44	55	10	4	DIN 894-30 6934034
WZHR25 - K/ESX20 6725049	25	ESX20	2,0 - 5,0 >5,0 - 13,0	34 47	34	25	42	12	29	55	67	10	4	DIN 894-30 6934034
WZHR25 - K/ESX25 6724958	25	ESX25	2,0 - 5,0 >5,0 - 16,0	36 51	42	25	42	12	30,5	55	67	10	4	E 25 6921608
WZHR28 - K/ESX25 6724972	28	ESX25	2,0 - 5,0 >5,0 - 16,0	36 51	42	28	44	16	30,5	60	72	12	4	E 25 6921608
WZHR28 - K/ESX32 6725016	28	ESX32	3,0 - 6,0 >6,0 - 20,0	41 56	50	28	44	16	38	60	72	12	5	E 32 6921609
WZHR32 - K/ESX25 -	32	ESX25	2,0 - 5,0 >5,0 - 16,0	36 51	42	32	48	16	30,5	68	81,5	12	4	E 25 6921608
WZHR32 - K/ESX32 6725264	32	ESX32	>3,0 - 6,0 >6,0 - 20,0	41 53	50	32	48	16	32,5	68	81,5	12	5	E 32 6921609
WZHR36 - K/ESX32 -	36	ESX32	3,0 - 6,0 >6,0 - 20,0	41 56	50	36	55	16	32,5	78	94	12	5	E 32 6921609
WZHR36 - K/ESX40 6725017	36	ESX40	4,0 - 6,0 >6,0 - 26,0	47 62	63	36	55	16	42	78	94	12	5	E 40 6921610

ESX12 lieferbar in Stufen von 0,5 mm, alle anderen Größen lieferbar in Stufen von 1 mm siehe Seite 34
ESX12 available in steps of 0,5 mm, all other sizes available in steps of 1 mm see page 34

Hinweis: Spannmutter ohne Dichtscheibe
Please note: Clamping nut with out sealing disc



ASB – ASBA

Aufsetzbares Schnellwechsel-Bohrfutter
Over Spindle Quick Change Drilling Chuck



Anwendung: Bohren, Senken, Reiben, Fasen, Honen
Maschinentyp: Transferstraßen, Mehrspindelbohrmaschinen, Sondermaschinen

Application: drilling, counterboring, chamfering, reaming, honing
Machine type: transfer lines, multispindle drilling, special purpose machines

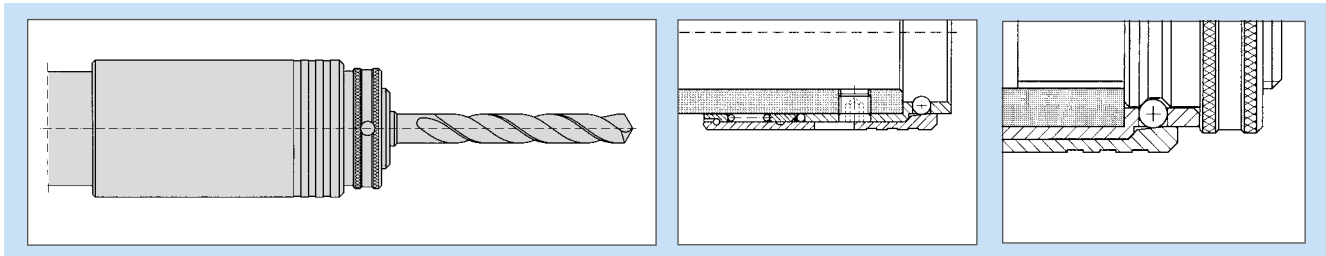

Aufsetzbare Schnellwechsel-Bohrfutter für Bohr-, Reib- und Senkwerkzeuge

Diese Schnellwechsel-Bohrfutter können auf Bohrspindelköpfen nach DIN 55058 aufgesetzt und mit einem speziellen Gewindestift in der vorhandenen Gewindebohrung der Spindel befestigt werden.

Zur spielfreien Befestigung sind im Futter 6 axial versetzt angeordnete Befestigungsbohrungen angebracht.

Diese Bohrfutter ergeben in Verbindung mit BILZ SSM Stellmuttern ein ideales Schnellwechselsystem für Stellhülsen und Werkzeughalter mit Trapezgewindeschaft nach DIN 6327. Sie können auf Mehrspindelmaschinen, Transferstraßen und Sondermaschinen eingesetzt werden.

Die Stellhülsen bzw. Werkzeughalter sind ohne Hilfswerkzeuge schnell wechselbar und werden durch Einstoßen in die Spindel automatisch verriegelt. Die Entriegelung erfolgt durch axiales Verschieben der Schalthülse.

Das Schnellwechsel-Bohrfutter garantiert axial spielfreies Halten der Werkzeuge in der Spindel.

Der Werkzeugwechsel erfolgt bei stehender Spindel und ist auch bei Mehrspindelköpfen mit engsten Spindelabständen schnell und sicher durchführbar.

Verlängerte Spindeln auf Anfrage.

Over spindle quick change chucks for drilling, reaming and counterboring tools

The over spindle quick change drilling chucks can be fixed to the noses of machine spindles in conformity with DIN 55058. They are located on the spindle by means of a special screw which locks the chuck on to the spindle nose. This screw locates in a tapped hole in the spindle. The inner sleeve of the chuck has six holes which accommodate the positional tolerance of the tapped hole in the spindle and ensure free of play positioning.

These chucks, combined with the Bilz SSM adjustable lock nuts provide a rapid and effective quick change system for adjustable adaptors and toolholders with DIN 6327 trapezoidal shanks. They can be used on multi-spindle machines, transfer lines and special purpose machines.

Tools can be changed quickly and easily, the tools are automatically locked into the unit.

The tools are released by pulling forward the outer sleeve of the chuck and removing the tool from the spindle.

This quick change system ensures the safe, play-free clamping in the spindle. Tool change is carried out only when the spindle is stopped and the tools are easily handled even in restricted locations on equipment such as multi-spindle heads.

ASB – ASBA

Aufsetzbares Schnellwechsel-Bohrfutter Over Spindle Quick Change Drilling Chuck



Merkmale:	Vorteile:	Nutzen:
<ul style="list-style-type: none"> Bohrfutter können auf Spindeln nach DIN55058 eingesetzt werden oder nach BS 1935: 1972 (ACME) 	<ul style="list-style-type: none"> Mehrspindelköpfe können nach- bzw. umgerüstet werden auf ein Schnellwechselsystem 	<ul style="list-style-type: none"> Reduzierung der Stillstandzeiten der Maschine Transferstraße wird reduziert und die Produktivität erhöht
<ul style="list-style-type: none"> Schnellwechselsystem (auch bei engsten Spindelabständen) 	<ul style="list-style-type: none"> schneller Werkzeugwechsel bei stehender Spindel ohne Hilfswerkzeuge 	<ul style="list-style-type: none"> kurze Werkzeugwechselzeiten
<ul style="list-style-type: none"> SSM-Mutter ersetzt die vorhandene SM-Mutter 	<ul style="list-style-type: none"> selbsttätiges Verriegeln der Stellmutter SSM beim Einstoßen in das Futter Längenvoreinstellung der Werkzeuge außerhalb der Maschine möglich axialspielfreies Halten der Stellhülsen/ Werkzeuge im Futter 	<ul style="list-style-type: none"> kurze Werkzeugwechselzeiten Reduzierung der Maschinenstillstandszeiten weniger Gefahr von Werkzeugbruch
Features:	Advantages:	Benefits:
<ul style="list-style-type: none"> drilling chucks can be used on spindles acc. to DIN55058 or acc. to BS 1935: 1972 (ACME) 	<ul style="list-style-type: none"> multi spindle heads can be retrofitted easily 	<ul style="list-style-type: none"> down time of the transfer line/ machine will be reduced and the productivity increased
<ul style="list-style-type: none"> quick change system (also for close center distances) 	<ul style="list-style-type: none"> quick tool change without additional tool and while the spindle is not rotating 	<ul style="list-style-type: none"> short tool changing time
<ul style="list-style-type: none"> SSM-nut replaces the existing SM-nut 	<ul style="list-style-type: none"> automatic locking of the SSM nut when inserting the adaptor into the chuck possible length adjustment outside of the machine adjustable adaptors are hold in the chuck without axial play 	<ul style="list-style-type: none"> short tool changing time reduction of the machine down time less danger of tool breakage

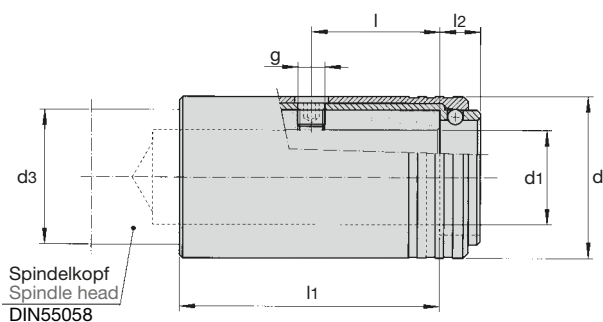

ASB											
Bezeichnung Designation	Id. No.		d	d1	d3	l	l1	l2	g		Id. No.
ASB12	6724516	SSM 12	24	12	20	22	42	9	M5	BN138-62	6917761
ASB16	6724526	SSM 16	30	16	25	34	65	9,5	M6	BN138-25	6920256
ASB20	6724543	SSM 20	38	20	32	34	67	11	M6	BN138- 2	6907012
ASB25	6724562	SSM 25	45	25	37	38	76	12	M8	BN138- 4	6907014
ASB28	6724576	SSM 28	48	28	40	38	78	12	M8	BN138- 4	6907014
ASB36	6724607	SSM 36	60	36	50	45	98	16	M8	BN138- 5	6907015

Zwei – Handbedienung
 Two – hand operation

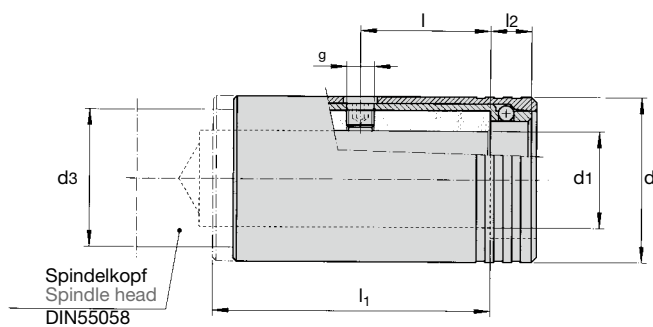

ASBA											
Bezeichnung Designation	Id. No.		d	d1	d3	l	l1	l2	g		Id. No.
ASBA12	6724515	SSM 12	24	12	20	22	52	9	M5	BN 138-62	6917761
ASBA16	6724523	SSM 16	30	16	25	34	67	9,5	M6	BN 138-25	6920256
ASBA20	6724540	SSM 20	38	20	32	34	72	11	M6	BN 138- 2	6907012
ASBA25	6724561	SSM 25	45	25	37	38	79	12	M8	BN 138- 4	6907014
ASBA28	6724573	SSM 28	48	28	40	38	81	12	M8	BN 138- 4	6907014
ASBA36	6724605	SSM 36	60	36	50	45	100	16	M8	BN 138- 5	6907015

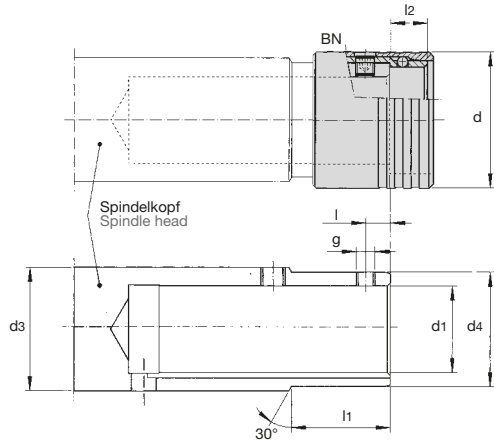

Ein – Handbedienung
 One – hand operation

ASBV-ASBVA – Schnellwechsel-Bohrfutter
ASBV-ASBVA – Quick change drilling chucks



ASBV

Mit reduziertem Außendurchmesser. Bohrspindelkopf DIN 55058 abgeändert
 With reduced outer diameter Spindle head DIN 55058 modified

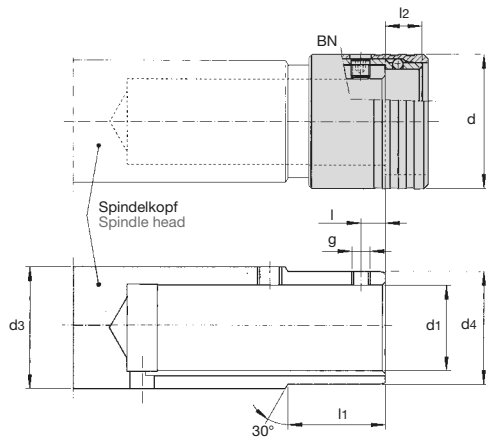

Bezeichnung Designation	Id. No.		d	d1	d3	d4	l	l1	l2	g		Id. No.
ASBV16	6724532	SSM 16	27	16	25	22	8	30	9,5	M5	BN 138 - 11	6907017
ASBV20	6724552	SSM 20	34	20	32	28	8	30	11	M5	BN 138 - 11	6907017
ASBV25	6724567	SSM 25	41	25	37	34,5	8	32	12	M6	BN 138 - 2	6907012
ASBV28	6724586	SSM 28	44	28	40	37	8	32	12	M6	BN 138 - 25	6920256
ASBV32	6724601	SSM 32	49	32	45	41	9	39	13,5	M6	BN 138 - 2	6907012
ASBV36	6724617	SSM 36	55	36	50	46	9	39	16	M6	BN 138 - 2	6907012
ASBV48	6724631	SSM 48	73	48	67	61	11	51	20	M8	BN 138 - 5	6907015

Zwei – Handbedienung
 Two – hand operation



ASBVA

Mit reduziertem Außendurchmesser. Bohrspindelkopf DIN 55058 abgeändert
 With reduced outer diameter. Spindle head DIN 55058 modified

Bezeichnung Designation	Id. No.		d	d1	d3	d4	l	l1	l2	g		Id. No.
ASBVA 16	6724533	SSM 16	27	16	25	22	8	30	9,5	M5	BN 138 - 11	6907017
ASBVA20	6724553	SSM 20	34	20	32	28	8	30	11	M5	BN 138 - 11	6907017
ASBVA25	6724568	SSM 25	41	25	37	34,5	8	32	12	M6	BN 138 - 2	6907012
ASBVA28	6724587	SSM 28	44	28	40	37	8	32	12	M6	BN 138 - 25	6920256
ASBVA32	6724602	SSM 32	49	32	45	41	9	39	13,5	M6	BN 138 - 2	6907012
ASBVA36	6724618	SSM 36	55	36	50	46	9	39	16	M6	BN 138 - 2	6907012
ASBVA48	6724632	SSM 48	73	48	67	61	11	51	20	M8	BN 138 - 5	6907015

Ein – Handbedienung
 One – hand operation

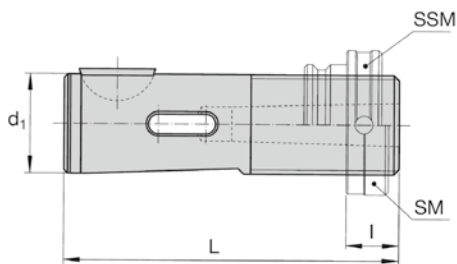

DIN 6327

N
- +

Type D									
Bezeichnung Designation	MK...	d1	SSM l min	SSM l max	SM l min	SM l max	L	Id. No.	
DIN6327- D 12 x ME6	Metr. 6	12	9	25	12	28	62	6724665	
DIN6327- D 16 x 0	MK0	16	9	37	12	40	85	6724670	
DIN6327- D 16 x 1	MK1	16	9	37	12	40	85	6724671	
DIN6327- D 20 x 1	MK1	20	9	37	12	40	88	6724676	
DIN6327- D 25 x 1	MK1	25	10	38	12	42	95	6724685	
DIN6327- D 25 x 2	MK2	25	10	38	12	42	95	6724686	
DIN6327- D 28 x 1	MK1	28	10	38	12	42	95	6724694	
DIN6327- D 28 x 2	MK2	28	10	38	12	42	95	6724695	
DIN6327- D 32 x 2	MK2	32	10	46	12	48	116	6724700	
DIN6327- D 32 x 3	MK3	32	10	46	12	48	116	6724701	
DIN6327- D 36 x 2	MK2	36	10	46	14	50	118	6724708	
DIN6327- D 36 x 3	MK3	36	10	46	14	50	118	6724709	
DIN6327- D 48 x 3	MK3	48	14	61	18	65	144	6724721	
DIN6327- D 48 x 4	MK4	48	14	61	18	65	144	6724722	

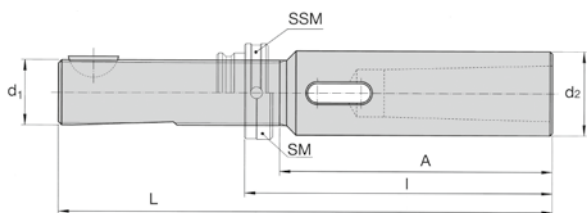

DIN 6327

N
- +

Type H										
Bezeichnung Designation	MK...	A	d1	d2	SSM l min	SSM l max	SM l min	SM l max	L	Id. No.
DIN6327- H12 x 0	MK0	73	12	18	82	100	85	103	135	6724897
DIN6327- H16 x 1	MK1	79	16	20	88	116	91	119	164	6724908
DIN6327- H16 x 2	MK2	94	16	25	103	131	106	134	179	6724917
DIN6327- H20 x 2	MK2	94	20	28	103	131	106	134	182	6724911
DIN6327- H25 x 3	MK3	117	25	36	127	157	129	159	212	6724975
DIN6327- H28 x 3	MK3	117	28	36	127	157	129	159	212	6724885
DIN6327- H36 x 4	MK4	146	36	48	156	192	160	196	264	6724913

Stellhülsen Type F
Adjustable adaptors Type F

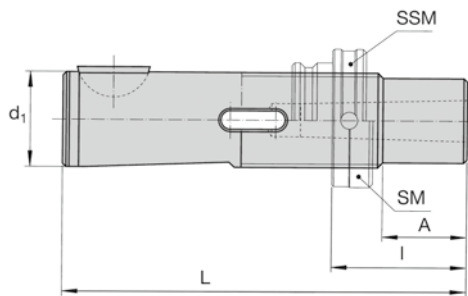

Type F									
Bezeichnung Designation	MK...	A	d1	SSM l min	SSM l max	SM l min	SM l max	L	Id. No.
DIN6327- F 12 x ME6 x 20	Metr.6	20	12	29	45	32	48	82	6724726
DIN6327- F 16 x 0x 25	MK0	25	16	34	62	37	65	110	6724732
DIN6327- F 16 x 0x 50	MK0	50	16	59	87	62	90	135	6724733
DIN6327- F 16 x 0x 75	MK0	75	16	84	112	87	115	160	6724734
DIN6327- F 16 x 0x 100	MK0	100	16	109	137	112	140	185	6724735
DIN6327- F 16 x 1x 25	MK1	25	16	34	62	37	65	110	6724736
DIN6327- F 16 x 1x 50	MK1	50	16	59	87	62	90	135	6724737
DIN6327- F 16 x 1x 75	MK1	75	16	84	112	87	115	160	6724738
DIN6327- F 16 x 1x 100	MK1	100	16	109	137	112	140	185	6724739
DIN6327- F 20 x 1 x 25	MK1	25	20	34	62	37	65	113	6724754
DIN6327- F 20 x 1 x 50	MK1	50	20	59	87	62	90	138	6724755
DIN6327- F 20 x 1 x 75	MK1	75	20	84	112	87	115	163	6724756
DIN6327- F 20 x 1 x 100	MK1	100	20	109	137	112	140	188	6724757
DIN6327- F 28 x 1x 25	MK1	25	28	35	63	37	67	120	6724793
DIN6327- F 28 x 1x 50	MK1	50	28	60	88	62	92	145	6724794
DIN6327- F 28 x 1x 75	MK1	75	28	85	113	87	117	170	6724795
DIN6327- F 28 x 1x 100	MK1	100	28	110	138	112	142	195	6724796
DIN6327- F 28 x 2x 25	MK2	25	28	35	63	37	67	120	6724797
DIN6327- F 28 x 2x 50	MK2	50	28	60	88	62	92	145	6724798
DIN6327- F 28 x 2x 75	MK2	75	28	85	113	87	117	170	6724799
DIN6327- F 28 x 2x 100	MK2	100	28	110	138	112	142	195	6724800
DIN6327- F 36 x 2x 30	MK2	30	36	40	76	44	80	148	6724838
DIN6327- F 36 x 2x 60	MK2	60	36	70	106	74	110	178	6724839
DIN6327- F 36 x 2x 90	MK2	90	36	100	136	104	140	208	6724840
DIN6327- F 36 x 2x 120	MK2	120	36	130	166	134	170	238	6724841
DIN6327- F 36 x 3x 30	MK3	30	36	40	76	44	80	148	6724843
DIN6327- F 36 x 3x 60	MK3	60	36	70	106	74	110	178	6724844
DIN6327- F 36 x 3x 90	MK3	90	36	100	136	104	140	208	6724845
DIN6327- F 36 x 3x 120	MK3	120	36	130	166	134	170	238	6724846

Längenverstellung Length adjustment	
SM	l
TR16	28
TR20	28
TR28	30
TR36	36
TR48	47

DIN
6327



Stellmutter Typ SSM für Bohrfutter mit Schnellwechseleinrichtung
 Adjusting nut type SSM for drilling chucks with quick change system

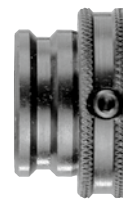
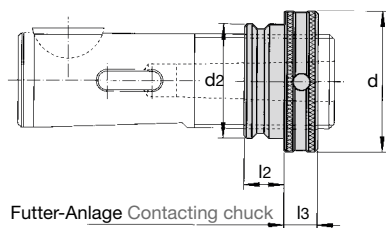

SSM

Mit doppelter Führung für genaue Bohr- und Senktiefen. Passend auf Stellhülsen DIN 6327

Adjusting nuts with double guidance surface, for accurate drilling and counterboring depths. For adjustable adaptors DIN 6327

Bezeichnung Designation	d	d2	l2	l3	Id. No.
SSM 12	22	16,4	9	9	6724517
SSM 16	26	19,9	9,5	9	6724527
SSM 20	33	25,4	11	9	6724544
SSM 25	40	31,9	12	10	6724563
SSM 28	42	33,9	12	10	6724577
SSM 32	47	37,9	13,5	10	6724595
SSM 36	54	43,4	16	10	6724608
SSM 48	72	57,9	20	14	6724627

Stellmutter Typ SM
 Adjusting nut type SM

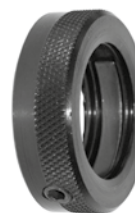
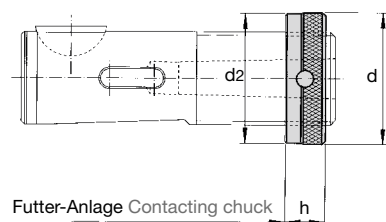

SM

Passend für Stellhülsen DIN 6327

Adjusting nuts for adjustable adaptors DIN 6327

Bezeichnung Designation	d	d2	h	Id. No.
SM 12	19,7	19	12	6805012
SM 16	24,6	24	12	6805016
SM 20	31,6	31	12	6805020
SM 25	36,6	36	12	6805025
SM 28	39,6	39	12	6805028
SM 32	44,6	44	12	6805032
SM 36	49,6	49	14	6805036
SM 48	66,6	66	18	6805048

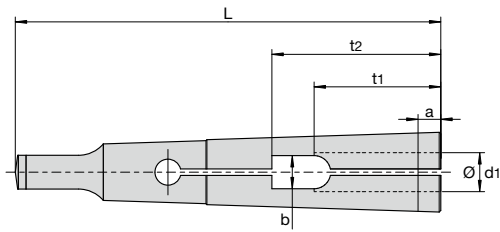

DIN 6328 Für Werkzeuge mit zyl. Schaft und Vierkant For tools with cylindrical shank and square													(Gewindebohrer Tap)		
		MK 0			MK 1			MK 2			MK 3				
d1 ^{H7}	L	59,5			65,5			80			99				
	a	3			3,5			5,0			5,0				
Ø		b	t1	t2	b	t1	t2	b	t1	t2	b	t1	t2		
2,47 - 2,83		2,2	15	19	2,2	15	19								
2,83 - 3,20		2,5	15	19	2,5	15	19								
3,20 - 3,60		2,8	16	21	2,8	16	21								
3,60 - 4,01		3,1	16	21	3,1	16	21								
4,01 - 4,53		3,5	16	21	3,5	16	21								
4,53 - 5,08					4,0	18	24	4,0	18,0	24					
5,08 - 5,79					4,5	18	24	4,5	18,0	24					
5,79 - 6,53					5,1	19,5	26	5,1	19,5	26					
6,53 - 7,33					5,7	19,5	26	5,7	19,5	26					
7,33 - 8,27					6,4	19,5	27	6,4	19,5	27					
8,27 - 9,46								7,3	22,0	30	7,3	22	30		
9,46 - 10,67								8,3	23,0	32	8,3	23	32		
10,67 - 12,00								9,3	24,0	34	9,3	24	34		
12,00 - 13,33											10,3	25	36		
13,33 - 14,67											11,3	26	38		
14,67 - 16,00											12,3	27	40		
16,00 - 17,33											13,3	30	44		

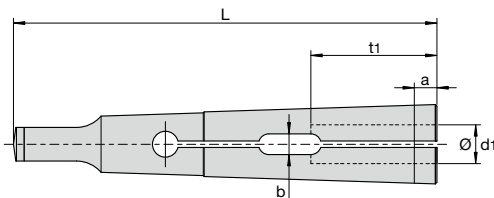

DIN 6329 Für Werkzeuge mit zyl. Schaft und Mitnehmer For tools with cylindrical shank and driver										(Spiralbohrer Drill)		
		MK 0		MK 1		MK 2		MK 3				
d1 ^{H7}	L	59,5		65,5		80		99				
	a	3		3,5		5,0		5,0				
Ø		b	t1	b	t1	b	t1	b	t1			
1,6 - 2,9			16									
2,9 - 3,5		1,8	20	1,8	20							
3,5 - 4,0		2,2	20	2,2	20							
4,0 - 4,5		2,4	20	2,4	20							
4,5 - 5,5		2,7	20	2,7	20							
5,5 - 6,5				3,2	22	3,2	22					
6,5 - 8,0				3,8	22	3,8	22					
8,0 - 9,5						4,8	25	4,8	25			
9,5 - 11,0						5,3	28	5,3	28			
11,0 - 13,0						6,3	28	6,3	28			
13,0 - 15,0								7,4	32			
15,0 - 18,0								8,4	32			

ASB, ASBV, ASBA, ASBVA

Montageanleitung

Schieben Sie das Schnellwechselbohrfutter auf die Maschinenspindel (DIN55058). Verdrehen Sie die innere Hülse, so dass eine der 6 Bohrung genau über dem Gewinde steht (die Bohrungen sind um 0,1 mm versetzt, die Mittellage mit einem Punkt markiert). Drehen Sie die mitgelieferte Schaftschraube ein.

Nach der Montage verdrehen Sie die äußere Hülse um 90°, so dass die Schaftschraube abgedeckt ist. Dann prüfen Sie, die Leichtgängigkeit der Hülse.

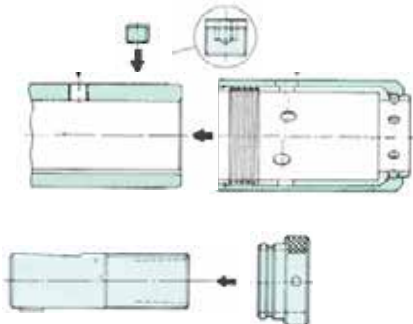

Achtung!

Benutzen Sie nur die von BILZ mitgelieferten Schaftschrauben, keine Norm-Gewindestifte, da dies zu Beschädigungen und Fehlfunktionen führt.

Die Maschinenspindel muss nach DIN 55058 ausgeführt sein.

Bei anderen Spindelabmessungen wenden Sie sich bitte an die Technische Kundenbetreuung der Fa. BILZ.

Bedienungsanleitung

Drehen Sie den Werkzeughalter so, dass die Passfeder in Richtung der in der Spindel befindlichen Nut weist. Zum Einführen des Halters in die Maschinenspindel muss bei ASB / ASBV die Schalhülse zurückgezogen werden.

Bei ASBA / ASBVA Futter reicht es, den Halter in die Spindel einzu- stoßen. Durch den Spannmechanismus und die V-Rille in der SSM Mutter wird der Halter automatisch verriegelt.

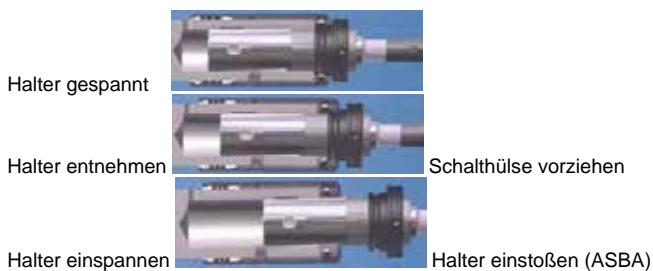

Zum Herausnehmen des Halters aus der Spindel ziehen Sie die Schalhülse zurück. Die Kugeln geben den Halter frei und er kann entnommen werden.

Der Werkzeughalterwechsel erfolgt im Fall von ASB, durch Zurückziehen der Schalhülse mit einer Hand und dem Entnehmen des Halters mit der anderen Hand.

Bei ASBA (Einhandbedienung) reicht es die Schalhülse nach hinten zu schieben, die dort verriegelt wird und dann den Halter mit der gleichen Hand zu entnehmen.

ASBV Schnellwechselbohrfutter haben einen verkleinerten Außendurchmesser (schlanke Ausführung) um engere Spindelabstände realisieren zu können. ASBVA Schnellwechselbohrfutter sind gleich schlank und für automatische Verriegelung ausgelegt (Einhandbedienung).

Installation Instruction

Push the quick change on the machine spindle (DIN55058). Twist the inner sleeve so that one of the bore 6 is above the thread in the correct position (the holes are offset by 0,1 mm, the centre position marked with a dot). Turn in the included set screw.

After assembly, rotate the outer sleeve by 90°, so that the screw shaft is covered. Then check the smooth movement of the sleeve.

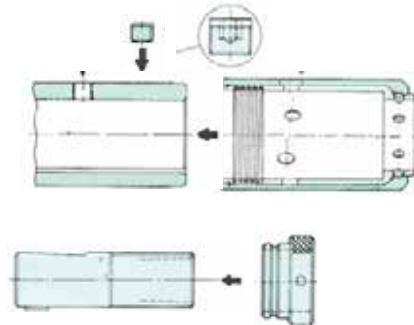

Attention!

Use only the supplied set screws of BILZ, no standard set screws, as this will cause damage and malfunction.

The machine spindle must be designed according to DIN 55058.

For other spindle sizes please contact the Technical Service of the company BILZ.

Operating Manual

Rotate the tool holder so that the key points in the direction of the groove located in the spindle. For insertion of the holder in the machine spindle at the ASB / ASBV must shift the sleeve to be withdrawn. At ASBA / ASBVA chucks it is enough to push the holder into the spindle. By the clamping mechanism, and the V-groove in the nut of the SSM holder is automatically locked.

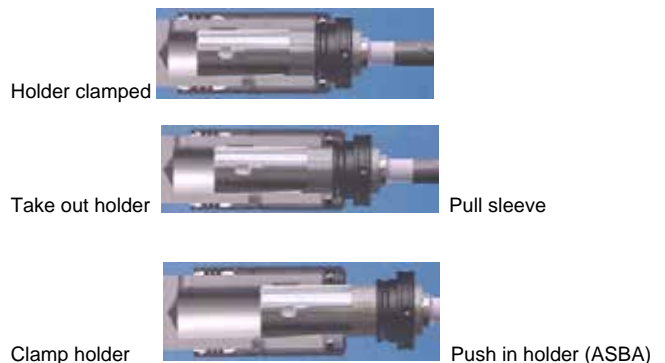

To remove the holder from the spindle, pull back the black sleeve. The balls release the holder and it can be freely removed. The tool holder exchange is in the case of ASB, by retraction of the switching sleeve with one hand and the removal of the holder with the other hand. In ASBA (hand operation), it is sufficient to shift sleeve to slide back, which is locked there, and then remove the holder with the same hand.

ASBV quick change have to be able to realize a reduced outer diameter (slim version) at distances closer spindle. ASBVA quick change are equally slim and designed for automatic lock (one hand operation).

172	Drehmomente zum Gewindeschneiden und Gewindeformen Recommended torques for tapping and cold forming operations
174	Gewindebohrerschaftmaße nach DIN/JIS Tap shank dimensions to DIN/JIS
178	Aufnahmegrößen und -abmessungen Adaptor sizes and dimensions
187	Ausstattungsmerkmale Features
188	Fragebogen: Fehler/Probleme Gewindebearbeitung Questionnaire: Errors/Problems tapping operations
189	BILZ Reparatur Service mit Qualität und Effizienz BILZ Repair Service with quality and efficiency
190	Wichtige Bestellhinweise Important Hints

Drehmomente zum Gewindeschneiden und Gewindeformen

Recommended torques for tapping and cold forming operations

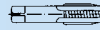

Nm	M	Whitworth BSW	Whitworth G BSP parallel	BSF	BSP	BA	PG	NPT	UNC	UNF	ft.lbs
0,3	M 2					Nr. 9				Nr. 2	0,22
0,4	M 2,5					Nr. 8				Nr. 3	0,29
0,5	M 3					Nr. 7					0,36
0,6						Nr. 6			Nr. 3	Nr.4	0,43
0,8	M 3,5					Nr. 5			Nr. 4	Nr. 5	0,58
1		1/8"				Nr. 4			Nr. 5		0,72
1,2						Nr. 4				Nr. 6	0,87
1,6	M 4								Nr. 6	Nr. 8	1,16
2		5/32"				Nr. 3			Nr. 8		1,45
2,5	M 5			3/16"		Nr. 2				Nr. 10	1,81
3										Nr. 12	2,17
4		3/16"		7/32"		Nr. 1			Nr. 10	1/4"	2,89
5	M 6	7/32"		1/4"		Nr. 0			Nr. 12		3,62
6			G 1/8"	9/32"						5/16"	4,34
8		1/4"		5/16"					1/4"	3/8"	5,79
10	M 8										7,23
12		5/16"		3/8"			PG 7		5/16"	7/16"	8,68
16										1/2"	11,58
18	M 10	3/8"	G 1/4"	7/16"	1/8"				3/8"		13,02
20							PG 9	1/8"			14,47
22							PG 11			9/16"	15,91
25				1/2"			PG 13,5			5/8"	18,08
28	M 12	7/16"	G 3/8"				PG 16		7/16"		20,25
32				9/16"							23,15
36										3/4"	26,04
40				5/8"					1/2"		28,93
45	M 14	1/2"		11/16"			PG 21				32,55
50	M 16		G 1/2"		1/4"				9/16"		36,17
56			G 5/8"					1/4"		7/8"	40,51
63		5/8"		3/8"			PG 29		5/8"		45,57
70			G 3/4"	3/4"				3/8"			50,63
80	M 18		G 7/8"	13/16"			PG 36				57,86
90	M 20	3/4"		7/8"			PG 42		3/4"	1"	65,10

Die angegebenen Drehmomente gelten für Gewindeschneiden und Gewindeformen.

Sie haben Gültigkeit für Werkstoffe mit einer Festigkeit von σ_B 1000 N/mm².

Die Drehmomentwerte zum Gewindeschneiden enthalten einen Stumpfungszuschlag von 100 %.

Bei Bedarf können diese Werte für Gewindeschneiden um bis zu 20 % und für Gewindeformen um bis zu 50 % erhöht werden.



The given torques are for tapping and cold forming operations.

They pertain to material with a tensile strength of σ_B 1000 N/mm².

The torque values for tapping include a wear factor of 100 %.

If necessary, these values can be increased by up to 20 % for tapping and by up to 50 % for cold forming operations.

Drehmomente zum Gewindeschneiden und Gewindeformen

Recommended torques for tapping and cold forming operations

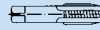

Nm	M	Whitworth BSW	Whitworth G BSP parallel	BSF	BSP	BA	PG	NPT	UNC	UNF	ft.lbs
100	M 22	7/8"					PG 48			1 1/8"	72,33
110										1 1/4"	79,56
125				1"					7/8"	1 3/8"	90,41
140			G 1"							1 1/2"	101,26
160	M 24	1"	G 1 1/8"		1/2"			1/2"			115,73
180	M 27		G 1 1/4"	1 1/8"							130,19
200			G 1 3/8"	1 1/4"	3/4"			3/4"	1"		144,66
220			G 1 1/2"								159,13
240		1 1/8"	G 1 3/4"								173,59
260			G 2"	1 3/8"							188,06
280	M 30	1 1/4"							1 1/8"		202,53
300			G 2 1/4"	1 1/2"							216,99
320	M 33			1 5/8"					1 1/4"		231,46
340			G 2 1/2"		1"			1"			245,92
360			G 2 3/4"								260,37
400			G 3"								289,32
420	M 36	1 3/8"	G 3 1/4"								303,79
450		1 1/2"	G 3 1/2"	1 3/4"	1 1/4"			1 1/4"			325,49
480	M 39		G 3 3/4"						1 3/8"		347,19
500			G 4"	2"					1 1/2"		361,65
560					1 1/2"			1 1/2"			405,04
630	M 42	1 5/8"									455,68
710	M 45	1 3/4"		2 1/4"	2"			2"			513,55
800				2 1/2"							578,64
900	M 48			2 3/4"					1 3/4"		650,97
1000	M 52	2"			2 1/2"						723,30
1100											795,63
1250	M 56	2 1/4"							2"		904,13
1400		2 1/2"		3"	3"			2 1/2"			1012,62
2000								3"			1446,61
2200											1591,27

Die angegebenen Drehmomente gelten für Gewindeschneiden und Gewindeformen.

Sie haben Gültigkeit für Werkstoffe mit einer Festigkeit von σ_B 1000 N/mm².

Die Drehmomentwerte zum Gewindeschneiden enthalten einen Stumpfungszuschlag von 100 %.

Bei Bedarf können diese Werte für Gewindeschneiden um bis zu 20 % und für Gewindeformen um bis zu 50 % erhöht werden.

The given torques are for tapping and cold forming operations.

They pertain to material with a tensile strength of σ_B 1000 N/mm².

The torque values for tapping include a wear factor of 100 %.

If necessary, these values can be increased by up to 20 % for tapping and by up to 50 % for cold forming operations.

Gewindebohrerschaftmaße nach DIN/JIS

Tap shank dimensions to DIN/JIS

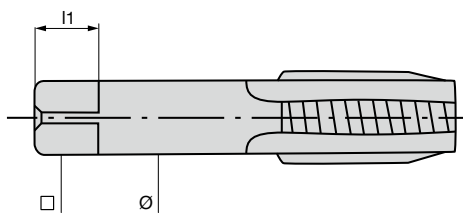

Ø x □	□ l1	DIN 371	DIN 374	DIN 376	JIS B 4430 1988	DIN 2182 BSW	DIN 2183 BSW	DIN 5156 DIN 5157	DIN 371 UNF	DIN 371 UNC	DIN 374 UNF	DIN 376 UNC	
2,5 x 2,1	5	M1		M3,5		1/16"							
		M1,1	M3,5										
		M1,2											
		M1,4											
		M1,6								Nr. 2 – 64			Nr. 6 – 32
		M1,8								Nr. 3 – 56		Nr. 6 – 40	Nr. 8 – 32
2,8 x 2,1	5	M2	M4	M4		3/32"	5/32"						
		M2,2								Nr. 2 – 56			
		M2,5								Nr. 3 – 48	Nr. 8 – 36		
3,0 x 2,5	5				M1,0–M1,2								
					M1,4–M1,7								
					M1,8–M2,2								
					M2,3–M2,6								
3,5 x 2,7	6	M3	M5	M4,5+M5		1/8"			Nr. 5 – 44	Nr. 5 – 40			
4,0 x 3,0	6	M3,5	M5,5			7/32"			Nr. 6 – 40	Nr. 6 – 32	Nr. 12 – 28	Nr. 12 – 24	
4,0 x 3,2	6				M3								
					M3,5								
4,5 x 3,4	6	M4	M6	M6		5/32"	1/4"		Nr. 8 – 36	Nr. 8 – 32	1/4" – 28	1/4" – 20	
5,0 x 4,0	7				M4								
					M4,5								
5,5 x 4,3	7		M7	M7									
5,5 x 4,5	7				M5								
6,0 x 4,5	7				M6								
6,0 x 4,9	8	M4,5						G 1/16"	Nr. 10 – 32			5/16" – 18	
		M5							Nr. 12 – 28	Nr. 10 – 24			
		M6	M8	M8						Nr. 12 – 28			
6,2 x 5,0	8				M7								
					M8								
7,0 x 5,5	8	M7	M9,M10	M9,M10	M9	1/4"	3/8"	G 1/8"	1/4" – 28	1/4" – 20	3/8" – 24	3/8" – 16	
					M10								
8,0 x 6,2	9	M8	M11			5/16"	7/16"		5/16" – 24	5/16" – 18			
8,0 x 6,5	9				M11								
8,5 x 6,5	9				M12								
9,0 x 7,0	10	M9	M12	M12		3/8"	1/4"		3/8" – 24	3/8" – 16	1/2" – 20	1/2" – 13	
10,0 x 8,0	11	M10											
10,5 x 8,0	11				M14								
11,0 x 9,0	12		M14	M14		9/16"		G 1/4"			5/8" – 18	5/8" – 11	
12,0 x 9,0	12	M12	M16	M16			5/8"	G 3/8"					
12,5 x 10,0	13				M16								
13,0 x 10,0	13				M17						3/4" – 16	3/4" – 10	

■ Schaft verstärkt
 ■ Shank diameter reinforced



Gewindebohrerschaftmaße nach DIN/JIS

Tap shank dimensions to DIN/JIS

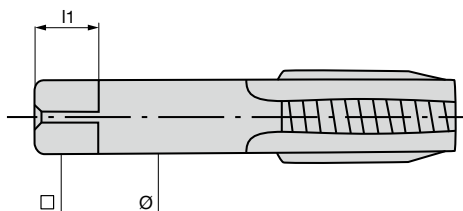

Ø x □	□ l ₁	· DIN 371	· DIN 374	· DIN 376	· JIS B 4430 1988	· DIN 2182 BSW	· DIN 2183 BSW	· DIN 5156 DIN 5157	· DIN 371 UNF	· DIN 371 UNC	· DIN 374 UNF	· DIN 376 UNC
14,0 x 11,0	14		M18	M18	M18, M19		1 ¹ / ₁₆ "					
15,0 x 12,0	15				M20							
16,0 x 12,0	15		M20	M20	M21		1 ³ / ₁₆ "	G 1 ¹ / ₂ "				
17,0 x 13,0	16				M22							
18,0 x 14,0	17				M23							
18,0 x 14,5	17		M22	M22			7 ⁷ / ₈ "	G 5 ⁵ / ₈ "				
			M24	M24			1 ⁵ / ₁₆ "					
19,0 x 15,0	18				M24, M25							
20,0 x 15,0	18				M26, M27							
20,0 x 16,0	19		M27	M27			1"	G 3 ³ / ₄ "				
21,0 x 17,0	20				M28							
22,0 x 18,0	21		M30	M30			1 ¹ / ₈ "	G 7 ⁷ / ₈ "				
23,0 x 17,0	20				M30							
24,0 x 19,0	22				M32							
25,0 x 19,0	22				M33							
25,0 x 20,0	23		M33	M33			1 ¹ / ₄ "	G 1"				
26,0 x 21,0	24				M34, M35							
28,0 x 21,0	24				M36–M38							
28,0 x 22,0	25		M36	M36			1 ³ / ₈ "	G 1 ¹ / ₈ "				
30,0 x 23,0	26				M39							
32,0 x 24,0	27		M39	M39			1 ¹ / ₂ "	G 1 ¹ / ₄ "				
			M42	M42			1 ⁵ / ₈ "					
32,0 x 26,0	30				M42							
35,0 x 26,0	30				M45							
36,0 x 29,0	32		M45	M45			1 ³ / ₄ "	G 1 ³ / ₈ "				
			M48	M48			1 ⁷ / ₈ "	G 1 ¹ / ₂ "				
							2"	G 1 ³ / ₄ "				
							2 ¹ / ₄ "	G 2"				
38,0 x 29,0	32				M48							
40,0 x 32,0	35		M52	M52	M50			G 2 ¹ / ₄ "				
42,0 x 32	35				M52							
44,0 x 35	38				M55, M56							
45,0 x 35,0	38			M56				G 2 ¹ / ₂ "				
				M60								
46,0 x 35,0	38				M58, M60							
48,0 x 38,0	42				M62, M64							
50,0 x 39,0	42			M64				G 2 ³ / ₄ "				
				M68				G 3"				
56,0 x 44,0	47						2 ³ / ₄ "	G 3 ¹ / ₄ "				
							3"					

- Schaft verstärkt
- Shank diameter reinforced

Gewindebohrerschaftmaße nach ISO

Tap shank dimensions to ISO

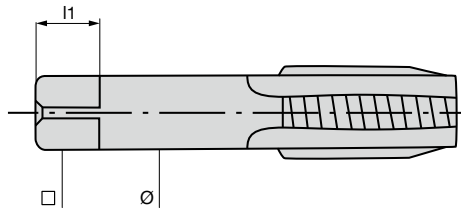

Ø x □	□ l1	M		UNC		ISO 529 – 1975				BSF		BA		
						UNF	BSW							
2,24 x 1,8	4	M3		Nr. 5-40		Nr.5-44		1/8"-40					Nr.5	
2,5 x 2,0	4	M3,5	M2	Nr. 6-32	Nr.1-64	Nr.6-40	Nr.0-80							Nr.11
							Nr.1-72							Nr.10
2,8 x 2,24	5		M2,2		Nr.2-56		Nr.2-64							Nr.8
			M2,5		Nr.3-48		Nr.3-56							Nr.7
3,15 x 2,5	5	M4	M3		Nr.4-40		Nr.4-48							Nr.5
				Nr.8-32	Nr.5-40	Nr.8-36	Nr.5-44						Nr.3	
3,55 x 2,8	5	M4,5	M3,5	Nr.10-24	Nr.6-32	Nr.10-32	Nr.6-40	3/16"-24		3/16"-32			Nr.2	Nr.4
4,0 x 3,15	6	M5	M4	Nr.12-24		Nr.12-28				7/32"-24			Nr.1	
4,5 x 3,55	6	M6		1/4"-20	Nr.8-32	1/4"-28	Nr.3-36	1/4"-20		1/4"-26			Nr.0	Nr.3
5,0 x 4,0	7		M5		Nr.10-24		Nr.10-32		3/16"-24		3/16"-32			Nr.2
5,6 x 4,5	7				Nr.12-24		Nr.12-28			9/32"-26	7/32"-28			Nr.1
6,3 x 5,0	8	M8	M6	5/16"-18	1/4"-20	5/16"-24	1/4"-28	5/16"-18	1/4"-20	5/16"-32	1/4"-26			Nr.0
7,1 x 5,6	8			3/8"-16		3/8"-24		3/8"-16		3/8"-20	9/32"-26			
8,0 x 6,3	9	M10	M8	7/16"-14	5/16"-18	7/16"-20		3/8"-16	5/16"-18	7/16"-18	5/16"-22			
9,0 x 7,1	10	M12		1/2"-13		1/2"-20		1/2"-13		1/2"-12				
10,0 x 8,0	11		M10		3/8"-16		3/8"-24		3/8"-16		3/8"-20			
11,2 x 9,0	12	M14		9/16"-12		9/16"-18		9/16"-12		9/16"-16				
12,5 x 10,0	13	M16		5/8"-11		5/8"-18		5/8"-11		3/8"-14				
14,0 x 11,2	14	M18		3/4"-10		3/4"-16		11/16"-14		11/16"-14				
		M20						3/4"-10		3/4"-12				
16,0 x 12,5	16	M22		7/8"-9		7/8"-14		7/8"-9		7/8"-11				
18,0 x 14,0	18	M24		1"-8		1"-12		1"-8		1"-10				
20,0 x 16,0	20	M27		1 1/8"-7		1 1/8"-12		1 1/8"-7		1 1/8"-9				
		M30												
22,4 x 18,0	22	M33		1 1/4"-7		1 1/4"-12		1 1/4"-7		1 1/4"-9				
25,0 x 20,0	24	M36		1 3/8"-6		1 3/8"-12				1 3/8"-8				
28,0 x 22,4	26	M39		1 1/2"-6		1 1/2"-12		1 1/2"-6		1 1/2"-8				
		M42								1 5/8"-8				
31,5 x 25,0	28	M45		1 3/4"-5				1 3/4"-5		1 3/4"-7				
		M48												
35,5 x 28,0	31	M52		2"-4 1/2				2"-4 1/2		2"-7				
		M56												
40,0 x 31,5	34	M60		2 1/4"-4 1/2				2 1/4"-4		2 1/4"-6				
		M64		2 1/2"-4				2 1/2"-4		2 1/2"-6				
45,0 x 35,5	38	M68		2 3/4"-4				2 3/4"-3 1/2		2 3/4"-6				
50,0 x 40,0	42			3"-4				3"-3 1/2		3"-5				
				3 1/4"-4				3 1/4"-3 1/4		3 1/4"-5				
				3 1/2"-4				3 1/2"-3 1/4		3 1/2"-4 1/2				
56,0 x 45,0	46			3 3/4"-4				3 3/4"-3		3 3/4"-4 1/2				
				4"-4				4"-3		4"-4 1/2				

- Schaft verstärkt
- Shank diameter reinforced

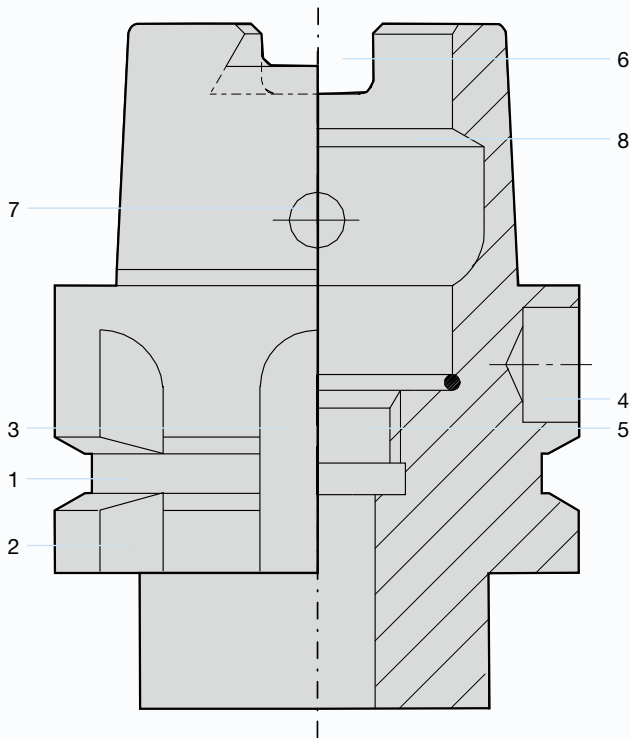

- 1 Greiferrille – umlaufende Nut
 - 2 Deutsches Eck – sichelförmige Kerbe quer zur Greiferrille (dient der Indexierung)
 - 3 Mitnehmernut am Bund – zur Indexierung oder zur Aufnahme in einem Werkzeugmagazin oder Greifer. Bei HSK-B/D gleichzeitig zur formschlüssigen Drehmomentübertragung zur Spindel
 - 4 Codierbohrung – zur Aufnahme eines Datenträgers (Codierchip) im Bund
 - 5 Anschlussgewinde für Kühlmittelübergabeeinheit – zur Aufnahme des Kühlmittelrohrs
 - 6 Mitnehmernut am Kegelschaft – formschlüssige Drehmomentübertragung zur Spindel
 - 7 Radiale Zugriffsbohrung im Kegelschaft – zur Betätigung manueller Spannsysteme
 - 8 Spannschulter – Ringfläche, an der das Werkzeug eingezogen wird
-
- 1 Gripper groove – circular groove
 - 2 Index notch – sickle-shaped notch across gripper groove
 - 3 Keyway on collar – index notch e.g. for tool magazines. Form closed torque transmission to spindle for HSK-B/D
 - 4 Coding/identification – hole in collar for attachment of identification system (code chip)
 - 5 Thread for coolant tube – for attachment of coolant tube
 - 6 Keyway on taper shank – form closed torque transmission to spindle
 - 7 Radial bore in taper shank – necessary for manual clamping systems
 - 8 Clamping shoulder – circular chamfer for clamping

Aufnahmegrößen und -abmessungen

Location sizes and dimensions



Form A
Shape A

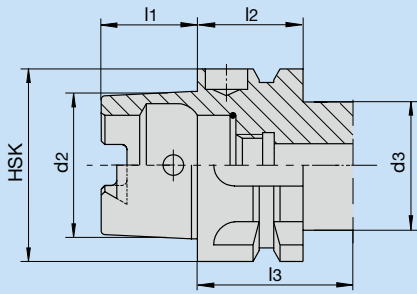

Der Hohlchaftkegel für automatischen Werkzeugwechsel mit Greif- und Indexiernut. Manuelle Betätigung durch Zugriffsbohrung im Kegel möglich. Das Drehmoment wird kraft- und formschlüssig übertragen.

Form B
Shape B

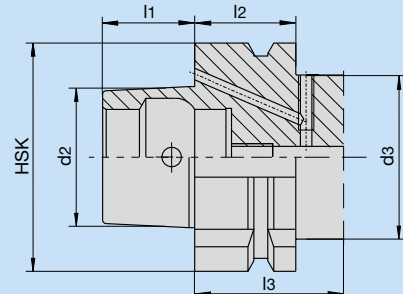

Hollow-shank taper for automatic tool changing with gripping and locating groove. Manual operation is possible through the access hole in the taper. Torque is transmitted both positively and non-positively.

Form C
Shape C

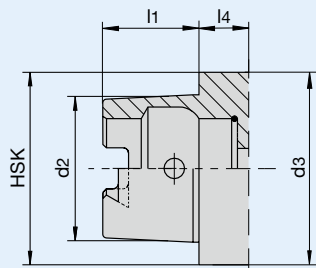

Der Hohlchaftkegel für manuellen Werkzeugwechsel. Betätigung durch Zugriffsbohrung im Kegel. Das Drehmoment wird kraft- und formschlüssig übertragen.

Form D
Shape D

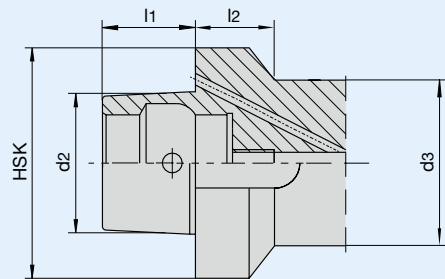

Hollow-shank taper for manual tool changing. Operation is possible through the access hole in the taper. Torque is transmitted both positively and non-positively.

Form E
Shape E

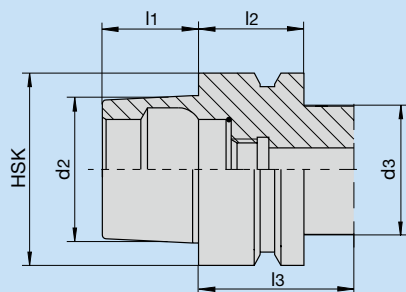

Der Hohlchaftkegel für automatischen Werkzeugwechsel. Das Drehmoment wird kraftschlüssig übertragen.

Form F
Shape F

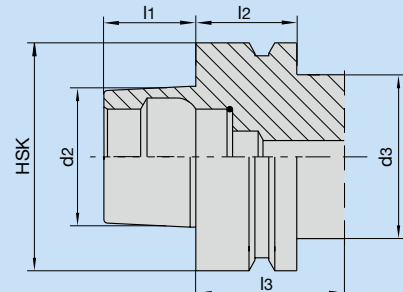

Hollow-shank taper for automatic tool changing. Torque is transmitted non-positively.

HSK-A + C	d2	d3	l1	l2	l3	l4	HSK-B + D	d2	d3	l1	l2	l3
25	19	20	13	19	20	8	40	24	34	16	20	35
32	24	26	16	20	35	10	50	30	42	20	26	42
40	30	34	20	20	35	10	63	38	53	25	26	42
50	38	42	25	26	42	12,5	80	48	68	32	26	42
63	48	53	32	26	42	12,5	100	60	68	40	29	45
80	60	68	40	26	42	16						
100	75	68	50	29	45	16						
125	95	111	63	29	45	-						
160	120	144	80	31	47	-						
HSK-E	d2	d3	l1	l2	l3		HSK-F	d2	d3	l1	l2	l3
25	19	20	13	10	20		50	30	42	20	26	42
32	24	26	16	20	35		63	38	53	25	26	42
40	30	34	20	20	35		80	48	68	32	26	42
50	38	42	25	26	42							
63	48	53	32	26	42							

Aufnahmegrößen und -abmessungen

Location sizes and dimensions



Hohlschaftkegel mit Plananlage (HSK) für automatischen Werkzeugwechsel nach DIN 69893 – Teil 1 (Form A)

Der Kegel-Hohlschaft weist aufgrund des kegeligen Schaftes und der Plananlage eine große Positioniergenauigkeit und hohe Steifigkeit auf. Außerdem ist er für rotierende und stehende Werkzeuge sowie Messzeuge geeignet.

Der Kegel-Hohlschaft nach DIN 69893 soll den Steilkegel für automatischen Werkzeugwechsel nach DIN 69871 Teil 1 ergänzen bzw. ersetzen. Gegenseitige Austauschbarkeit besteht nicht.

Hollow tapered shanks with face contact (HSK) for automatic tool change to DIN 69893 – Part 1 (Form A)

Due to the tapered shank and face contact, a high positioning accuracy, and high grade of rigidity is suited for use with rotary and stationary tools including measuring instruments.

The taper hollow shank to DIN 69893 supplements the steep taper for automatic tool changes to DIN 69871 Part 1. Reciprocal interchangeability is not given.

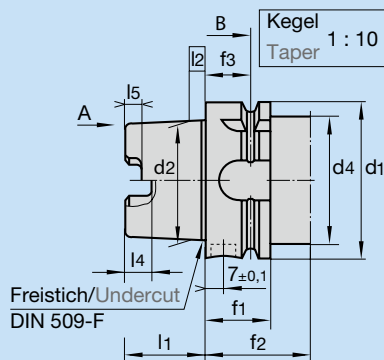

Ansicht View "A"

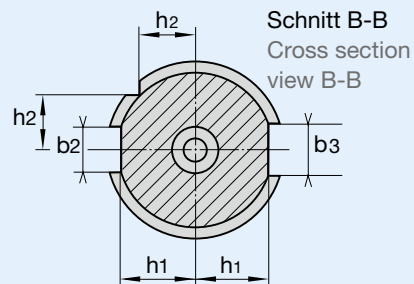
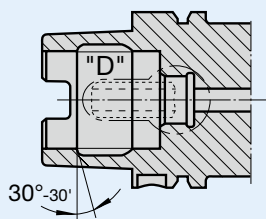
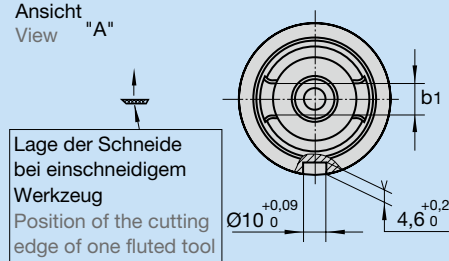

Nenngröße Nominal size d_1 H10	b1 H10	b2 H10	b3 H10	d2 max.	d4 max.	f1 0 -0,1	f2 min.	f3 $\pm 0,1$	h1 -0,2	h2 0 -0,3	l1 0 -0,2	l2	l4 $+0,2$ 0	l5 $+0,2$ 0
25	6	6	7	19	20	19	20	4,5	10	7,5	13	2,5	4	2
32	7	7	9	24	26	20	35	16	13	9,5	16	3,2	5	3
40	8	9	11	30	34		35	16	17	12	20	4	6	3,5
50	10,5	12	14	38	42	26	42	18	21	15,5	25	5	7,5	4,5
63	12,5	16	18	48	53	25	42	18	26,5	20	32	6,3	10	6
80	16	18	20	60	67	26	42	18	34	25	40	8	12	8
100	20	20	22	75	85	29	45	20	44	31,5	50	10	15	10
125	25	25	28	95	105		45	20	55,5	39,5	63	12,5	19	12
160	30	32	36	120	130	31	47	22	72	50	80	16	23	16

DIN ISO 7388-1 (DIN 69871 A)

Steilkegelschäfte für automatischen Werkzeugwechsel 7/24 step taper for automatic tool change

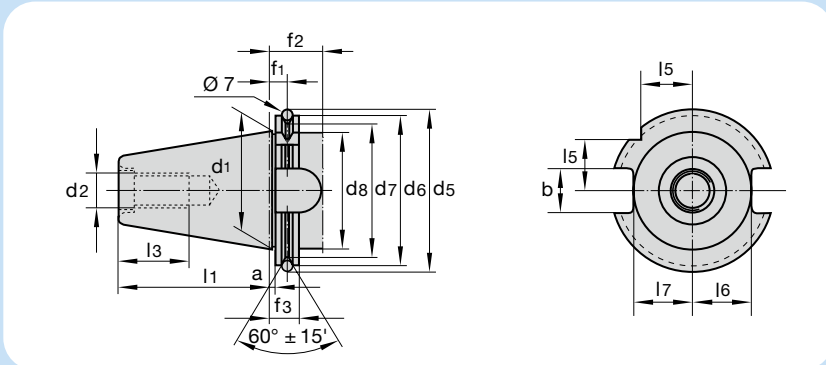

DIN ISO 7388-1

SK	a ± 0,1	b 0/ +0,2	d1	d2	d5 ± 0,05	d6 0 - 0,1	d7 0 - 0,5	d8 max.	f1 ± 0,1	f2 min.	f3 0 - 0,1	l1 0 - 0,3	l3 min.	l5 0 - 0,3	l6 0 - 0,4	l7 0 - 0,4
30	3,2	16,1	31,75	M 12	59,30	50,00	44,30	45	11,1	35	19,1	47,80	24	15	16,3	18,8
40	3,2	16,1	44,45	M 16	72,30	63,55	56,25	50	11,1	35	19,1	68,40	32	18,5	22,7	25,0
45	3,2	19,3	57,15	M 20	91,35	82,55	75,25	63	11,1	35	19,1	82,70	40	24	29,1	31,3
50	3,2	25,7	69,85	M 24	107,25	97,50	91,25	80	11,1	35	19,1	101,75	47	30	35,5	37,7
60	3,2	25,7	107,95	M30	164,75	155,00	147,70	130	11,1	35	19,1	161,90	59	49	64,5	59,3

DIN ISO 7388-1 (DIN 69871 B)

Steilkegelschäfte Kühlmittelzufuhr über Bund, AF 7/24 step taper with coolant supply via flange, AF

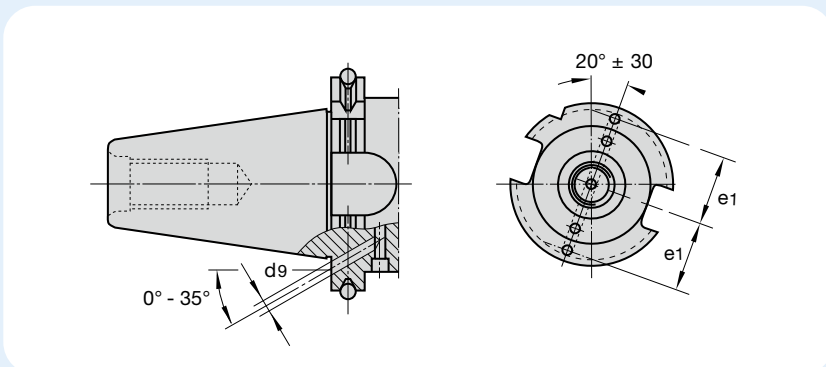

Die übrigen Maße wie Steilkegelschäfte nach ISO 7388-1.

All other dimensions such as for 7/24 taper shanks to ISO 7388-1.

DIN ISO 7388-1

SK	d9	e1 ± 0,1
30	4	21
40	4	27
45	5	35
50	6	42
60	8	66

Kegelwinkel-Toleranzqualität des Steilkegelschaftes AT 4 nach DIN 2080 Teil 1.

Included taper angle tolerance quality of the 7/24 taper shank AT 4 to DIN 2080 Part 1.

DIN 2080

Steilkegelschäfte für manuellen Werkzeugwechsel 7/24 step taper for manual tool change

SK 40 mit Maho-Ringnut
SK 40 with Maho Ring Groove

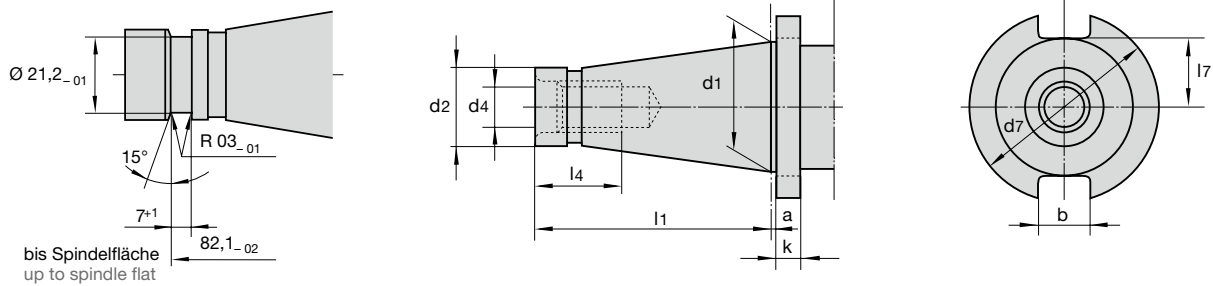

DIN 2080

SK	a ± 0,2	b H 12	d1	d2 a10	d4	d7 - 0,4	k ± 0,15	l1 0	l4 - 0,3	l7 max.
30	1,6	16,1	31,75	17,4	M 12	50	8	68,4	24	16,2
40	1,6	16,1	44,45	25,3	M 16	63	10	93,4	32	22,5
45	3,2	19,3	57,15	32,4	M 20	80	12	106,8	40	29
50	3,2	25,7	69,85	39,6	M 24	97,5	12	126,8	47	35,3
60	3,2	25,7	107,95	60,2	M 30	156	16	206,8	59	60

DIN ISO 7388-2 (MAS 403)

BT-Steilschäfte für automatischen Werkzeugwechsel BT-step taper for automatic tool change

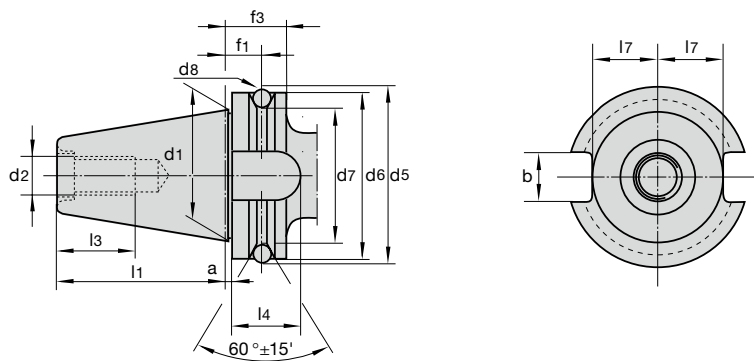

DIN ISO 7388-2 (für JMTBA-Standard MAS 403-1975 to JMTBA-Standard MAS 403-1975) (JMTBA = Japan Machine Tool Builders Association)

BT	a ± 0,4	b	d1	d2 6 H	d5 ± 0,05	d6 h8	d7 0-0,05	d8 ± 0,1	f1 ± 0,01	f3 min.	l1 ± 0,2	l3 min.	l4 min.	l7
BT 30	1,6	2	31,75	M 12	56,03	46	38	8	13,6	22	48,4	24	17	16,3
BT 40	1,6	2	44,45	M 16	75,56	63	53	10	16,6	27	65,4	30	21	22,6
BT 45	3,2	3	57,15	M 20	100,09	85	73	12	21,2	33	82,8	36	26	29,1
BT 50	3,2	3	69,85	M 24	118,89	100	85	15	23,2	38	101,8	45	31	35,4

DIN ISO 7388-1 (ANSI B5.50/CAT) Steilkegel für automatischen Werkzeugwechsel
DIN ISO 7388-1 (ANSI B5.50/CAT) Step taper for automatic tool change

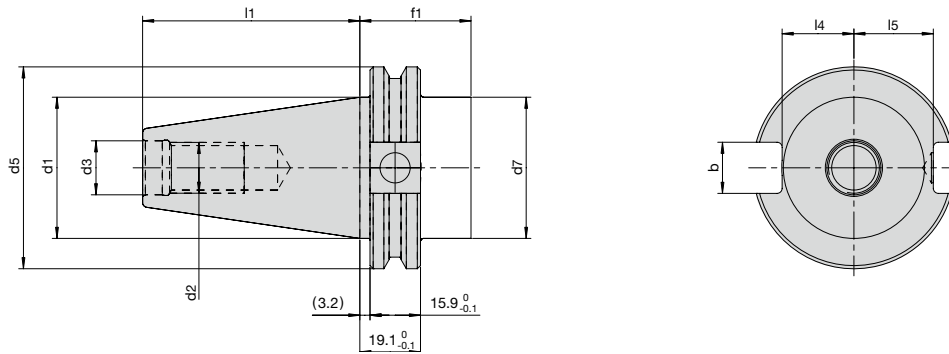

DIN ISO 7388-1 (ANSI B5.50/CAT, Metrisch)

	40	45	50
b $^{+0,2}_0$	16,1	19,3	25,7
d1	44,45	57,15	69,95
d2	M 16	M 20	M 24
d3 _{H7}	17	21	25
d4 $^{+0,05}_0$	72,3	91,35	108,25
d5 $^{+0,01}_0$	63,55	82,55	98,5
d6 $^{+0,05}_0$	56,25	75,25	91,25
d7 $^{+0,25}_0$	44,45	57,15	69,95
f1 $^{+0,25}_0$	35	35	35
l1 $^{+0,03}_0$	68,4	82,7	101,75
l4 $^{+0,04}_0$	22,7	29,10	35,50
l5 $^{+0,04}_0$	25	31,3	37,7

ANSI B5.50/CAT Inch

	40	45	50
d2	UNC 5/8-11	UNC 3/4-10	UNC 1-8
d3 $^{+0,4}_0$	16,3	19,45	26,2

Morsekegelschäfte mit Austreibblappen

Morse taper shanks with tang

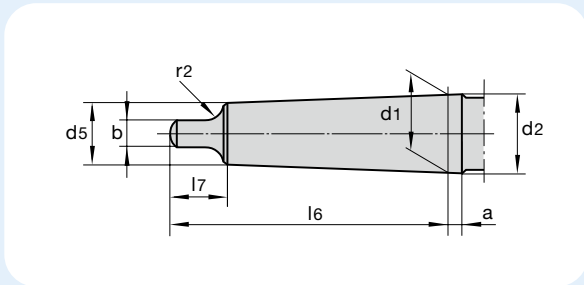

DIN 228 B

MK	a	b	d1	d2	d5	l6 0 -1	l7 max	r2
0	3,0 ^{+1,2}	3,9	9,045	9,2	6,1	56,5	10,5	4
1	3,5 ^{+1,4}	5,2	12,065	12,2	9,0	62,0	13,5	5
2	5,0 ^{+1,4}	6,3	17,780	18,0	14,0	75,0	16	6
3	5,0 ^{+1,7}	7,9	23,825	24,1	19,1	94,0	20	7
4	6,5 ^{+1,9}	11,9	31,267	31,6	25,2	117,5	24	8
5	6,5 ^{+1,9}	15,9	44,399	44,7	36,5	149,5	29	10
6	8,0 ^{+2,3}	19,0	63,348	63,8	52,4	210,0	40	13

Morsekegelschäfte mit Anzugsgewinde

Morse taper shanks with draw-bar thread

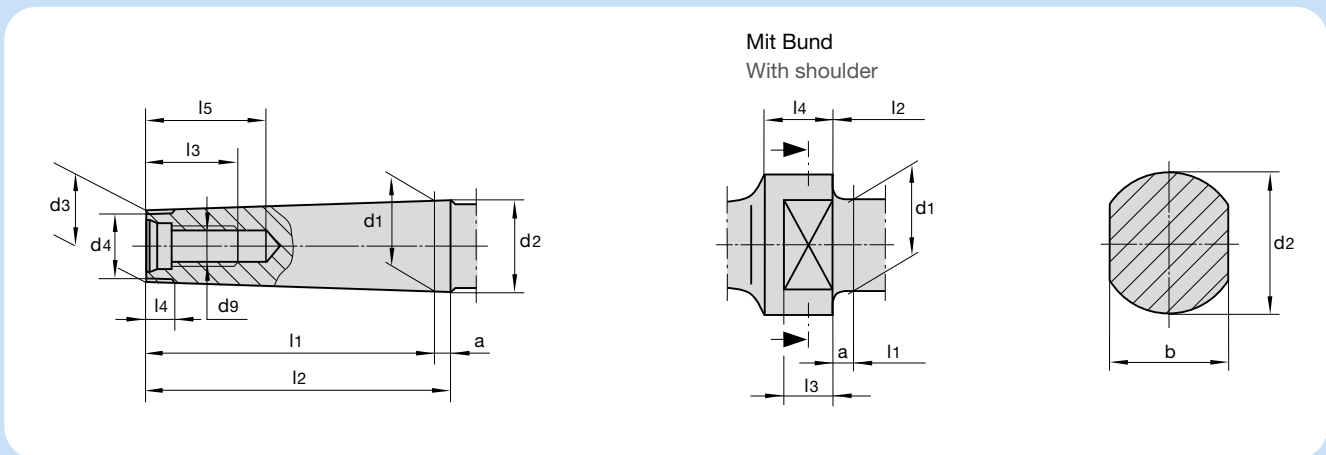

DIN 228 A

DIN 2207

MK	a	d1	d2 ≈	d3 ≈	d4 max.	d9	l1 max.	l2 max.	l3 min.	l4	l5 min.	Mit Bund With shoulder			
												b d9	d2	l3	l4
0	3,0 ^{+1,2}	9,045	9,2	6,4	6	–	50	53	–	4	–				
1	3,5 ^{+1,4}	12,065	12,2	9,4	9	M 6	53,5	57	16	5	22				
2	5,0 ^{+1,4}	17,780	18,0	14,6	14	M 10	64	69	24	5	31,5				
3	5,0 ^{+1,7}	23,825	24,1	19,8	19	M 12	81	86	24	7	33,5	24	24	12	18
4	6,5 ^{+1,9}	31,267	31,6	25,9	25	M 16	102,5	109	32	9	42,5	32	32	15	23
5	6,5 ^{+1,9}	44,399	44,7	37,6	35,7	M 20	129,5	136	40	10	52,5	45	45	18	28
6	8,0 ^{+2,3}	63,348	63,8	53,9	51	M 24	182	190	47	16	61,5	65	65	25	39

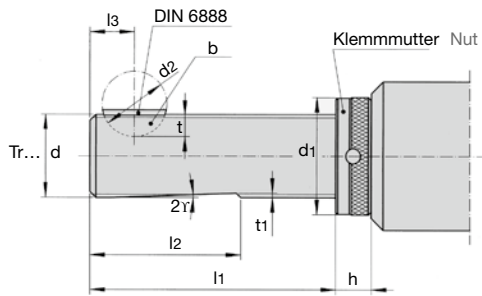

TR...

Trapezgewindeschaft DIN 6327 mit Klemmmutter

Trapezoidal threaded shank DIN 6327 with adjustment nut

Bezeichnung Designation	dg5	d1	d2	dp9	t	t1	l1	l2	l3	h	DIN 6888
TR 6 x 1*	6	12	7	2	1,8	1	30	20	8	8	2 x 2,6
TR 8 x 1	8	13,5	10	2	2,9	1	40	26	10	10	2 x 3,7
TR 10 x 1,5	10	18	13	3	4,1	1	50	32	10	12	3 x 5
TR 12 x 1,5	12	19	13	3	4,1	1	50	32	10	12	3 x 5
TR 16 x 1,5	16	25	16	5	5,4	1,3	73	43	11	12	5 x 6,5
TR 20 x 2	20	32	19	5	6,4	1,3	76	46	13	12	5 x 7,5
TR 25 x 2	25	37	22	6	7,5	1,5	83	51	15	12	6 x 9
TR 28 x 2	28	40	22	6	7,5	1,5	83	51	15	12	6 x 9
TR 32 x 23	32	45	28	8	9,5	1,7	106	68	20	12	8 x 11
TR 36 x 2	36	50	28	8	9,5	1,7	104	65	20	14	8 x 11
TR 40 x 2*	40	58	28	10	9,1	2,2	128	76	24	16	10 x 11
TR 48 x 2	48	67	32	10	11,1	2,2	126	76	24	18	10 x 13
TR 55 x 2*	55	74	45	10	14,1	2,7	162	93	28	18	10 x 16

* Bilz-Standard

ASME/ANSI B1.5-1988

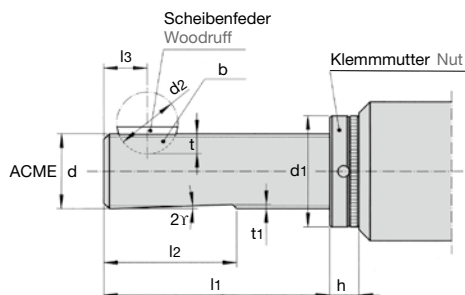

ACME...

Trapezgewindeschaft mit AMERICAN NATIONAL ACME-Gewinde Entspricht den Werksnormen von Ford-Motor-Company und General Motors

Trapezoidal threaded shank with AMERICAN NATIONAL ACME-thread Corresponds to standard of Ford-Motor-Company and General Motors

ACME...	d-0,01	d1	d2	b	t	t1	l1	l2	l3	h	Scheibenfeder woodruff-key
3/8" - 20*	9,51	16	12,7	2,357	3,84	1,2	55,5	35	10	8	3/8" x 1/2"
1/2" - 16	12,69	22	15,88	3,149	4,76	1,5	65,5	38	11,2	10,5	1/8" x 5/8"
5/8" - 16	15,85	25	15,88	3,945	4,37	1,5	65,5	38	12,7	10,5	5/32" x 5/8"
3/4" - 12	19,03	29	15,88	3,945	4,37	1,5	65,5	38	12,7	10,5	5/32" x 5/8"
7/8" - 12	22,21	32	19,05	4,732	5,57	1,5	81,5	47,5	12,7	10,5	3/16" x 3/4"
1" - 12	25,38	38	22,23	4,732	7,15	1,5	81,5	47,5	15,7	10,5	3/16" x 7/8"
1 1/16" - 12	26,96	40	22,23	4,732	7,15	1,5	81,5	47,5	15,7	10,5	3/16" x 7/8"
1 3/8" - 12	34,9	48	25,4	6,317	7,95	1,5	106,5	66,5	19	10,5	1/4" x 1"
1 7/8" - 12	74,6	66	31,75	7,902	9,93	1,5	132,5	76	24	10,5	5/16" x 1 1/4"

* Bilz-Standard

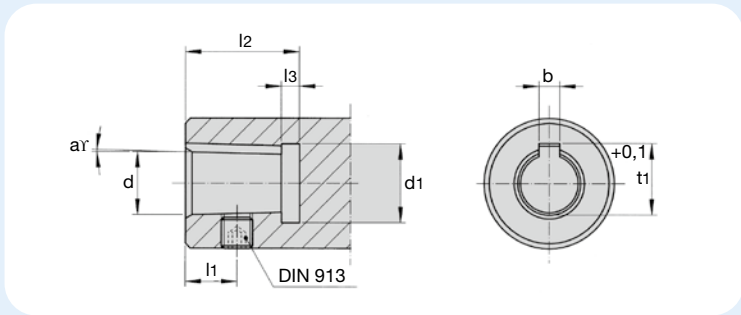

B...
Bohrfutter-Kegel DIN 238, zusätzlich mit Keilnut und Klemmschraube
Taper bore DIN 238 additionally with key way and grub screw

Bezeichnung Designation	d	d1	l1	l2	l3	bc11	t1	a°	DIN913
B 10	10,094	12,4	8	18	3,5	3	11,4	1°25'43"	M5 x 5
B 12	12,065	15,1	10	22	3,5	4	13,7	1°25'43"	M6 x 5
B 16	15,733	18,4	12	28	4	4	17,4	1°25'50"	M6 x 5
B 18	17,780	21,3	15	36	4	5	19,9	1°25'50"	M6 x 8
B 22	21,793	24,5	18	45	4,5	5	23,9	1°26'16"	M8 x 10
B 24	23,825	27,5	20	55	4,5	6	26,4	1°26'16"	M8 x 12

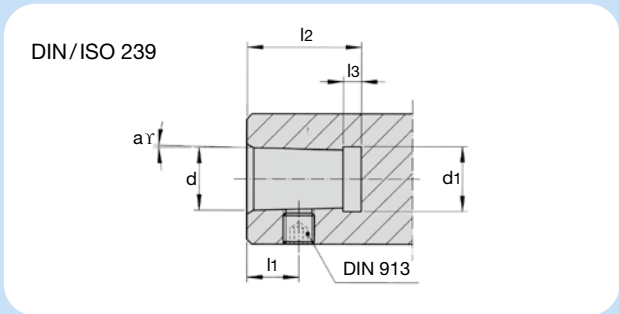

J...
Jacobs-Kegel mit Klemmschraube
Jacobs-taper with grub screw

Bezeichnung Designation	d	d1	l1	l2	l3	a°	DIN913
J 0	6,350	6,2	6	13	3	1°24'43"	M4 x 4
J 1	9,754	9,0	8	18	3,5	2°12'26"	M5 x 5
J 2	14,199	13,0	11	24	3,5	2°20' 8"	M6 x 6
J 2K	13,940	13,0	9	21	3,5	2°20' 8"	M6 x 6
J 3	20,599	19,5	14	34	4	1°31'31"	M8 x 10
J 4	28,550	27,0	18	45	4,5	1°30' 4"	M8 x 10
J 5	35,890	34,0	20	51	5	1°28'48"	M8 x 12
J 6	17,170	16,5	12	28	4	1°29' 9"	M6 x 8
J 33	15,850	14,8	12	28	4	1°49' 6"	M6 x 6
J E	20,030	19,5	10	23	3,5	1°29'19"	M8 x 10

Aufnahmegrößen und -abmessungen

Location sizes and dimensions

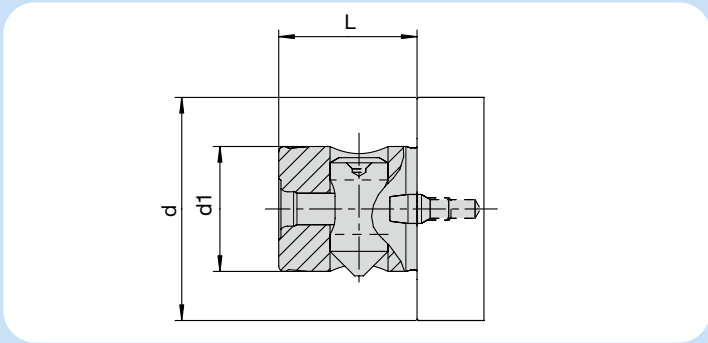

ABS Aufnahmen ABS Adaptors

Bezeichnung Designation	ABS-N	d	d1	L
ABS25	ABS 25 N	25	13	20
ABS32	ABS 32 N	32	16	23
ABS40	ABS 40 N	40	20	26
ABS50	ABS 50 N	50	28	31
ABS63	ABS 63 N	63	34	38
ABS80	ABS 80 N	80	46	43
ABS 100	ABS 100 N	100	56	55
ABS 125	ABS 125 N	125	70	70
ABS 160	ABS 160 N	160	90	90

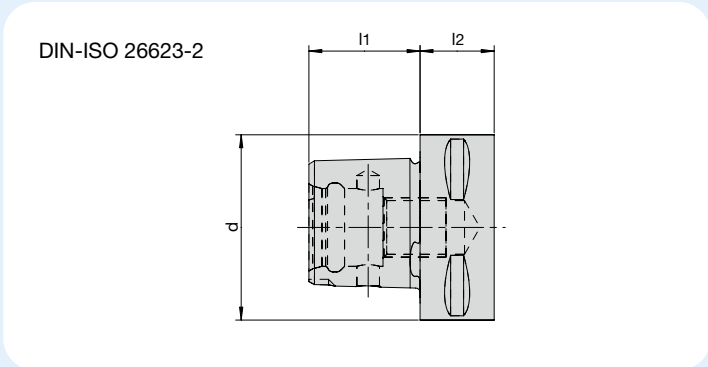

Polygon Hohlschaftkegel Aufnahmen Polygon taper Adaptors

Nenngröße Size	d	l1	l2 min.
C3	32	19	15
C4	40	24	20
C5	50	30	20
C6	63	38	22
C8	80	48	30

Maschine Machine
Hersteller
machine manufacturer
Typ
machine type
Aufnahme/Größe
spindle location/size
Vorschubart: Leitpatrone, manuell, hydr./pneum., NC
type of feed: lead screw, manual, hydr./pneum., NC
Synchronisierter Vorschub, ja/nein
synchronized feed, yes/no
Futter/Einsätze vorhanden Chuck/adaptor in use
Futter, Hersteller, Bezeichnung
chuck, manufacturer, description
Einsatz, Hersteller, Bezeichnung
adaptor, manufacturer, description
Gewindedaten Thread data
Gewindeart/Größe
thread/size
Schaftmaße GWB, DIN, ISO
shank dimensions tap, DIN, ISO
Schneiden/Formen
tapping/roll forming
Material, Härte
material, hardness
Grund-/Durchgangsbohrung
through/blind hole
Gewindetiefe
thread depth
Bohrung angesenkt, ja/nein
hole chamfered, yes/no
Vorbohrdurchmesser
pre-drilled diameter
Vorbohrtiefe
drilling depth
Form GWB, Anschnittform
type of tap
Qualität
tap quality
HM, HSS...
HM, HSS...
Prozessdaten Process dat
Drehzahl
speed
Vorschub
feed
Sicherheitsabstand
clearance
Schmiermittel
lubricant
Kühlmitteldruck
coolant pressure
Zusatzinformationen Additional information
Achsversatz vorhanden
misalignment
Störkonturen
obstructing edges
Problem Problem
Beschreibung
please describe



Wir halten, was wir versprechen

Unser qualifiziertes Fachpersonal repariert defekte Induktionsgeräte, Gewindeschneidfutter, Bohrfutter und viele weitere Produkte von BILZ.

Wir bieten einen schnellen und zuverlässigen Service.

Sie erhalten innerhalb von 2 bis 5 Werktagen einen unverbindlichen Kostenvoranschlag, nach Anlieferung Ihres Werkzeuges oder Induktionsgerätes bei BILZ.

fair • schnell • transparent

- Begutachtung Ihres Werkzeuges nach fairen Gesichtspunkten hinsichtlich des Verschleißzustandes
- Sie entscheiden mit – nach Erhalt des Kostenvoranschlags – ob eine Aufbereitung oder Erneuerung sinnvoll ist
- Wenn eine Reparatur aus Kostengründen nicht mehr lohnenswert sein sollte, erhalten Sie ein unverbindliches Angebot für ein neues Produkt
- Schnellstmögliche Reparatur und Rückversand
- Teilen Sie uns Ihre Sonderwünsche mit

Kontaktdaten Service unter:

www.bilz.de/service/service-team/

Contact details service:

www.bilz.de/en/service/service-team/

We hold our promises

Our qualified experts repair defective shrink machines, tapping chucks, drill chucks and many other BILZ products. We offer a fast and reliable service.

You will receive our non-binding cost estimate for the repair within 2 to 5 working days after receipt of your tool or machine at BILZ.

fair • fast • transparent

- fair assessment of your tool's condition
- you decide whether to go ahead with a repair
- or renewal after receiving our cost estimate
- if the repair is no longer economical, you will receive
- an non-binding quote for a new product
- repair and return will be carried out as quickly as possible
- please communicate any special requests to us



Programmaktualität

Im Rahmen der kontinuierlichen Aktualisierung unseres Produktprogrammes nehmen wir nicht nur neue und damit technisch bessere Produkte im Programm auf, sondern führen auch eine intensive Programmbereinigung durch. Es kann also im Einzelfall passieren, dass wir einen von Ihnen bestellten Artikel nicht mehr lagermäßig führen. Sie erhalten dann von uns in der Regel ein technologisch besseres Produkt, mindestens aber eine gleichwertige Alternative. In Zweifelsfällen wird sich unser Verkaufsteam mit Ihnen in Verbindung setzen, um eine für Sie optimale Ausführung zu bestimmen. Durch diese Vorgehensweise ist sichergestellt, dass Sie stets mit Produkten beliefert werden, die technisch auf dem neuesten Stand sind.

Eine Verpflichtung zur Lieferung von noch im Katalog oder in der Preisliste abgebildeten Produkten, die intern aber bereits programmbereinigt wurden, übernehmen wir deshalb nicht.

Preise

Dieser Katalog enthält keine Preise. Diese entnehmen Sie bitte der jeweils gültigen Preisliste.

Mindestauftragswert

Wir bitten um Verständnis, dass wir Aufträge bis zu einem Gesamtwert unter € 50,- nur gegen eine zusätzliche Bearbeitungsgebühr in Höhe von € 20,- ausführen können.

Die Mindestbestellmenge bei Sonderartikeln beträgt 3 Stück.

Sonderformen

Sollten Sie eines Ihrer Bearbeitungsprobleme nicht mit einem unserer lagergängigen Produkte lösen können, bieten wir Ihnen Sonderformen oder zeichnungsgebundene Werkzeuge auf Anfrage an.

Unsere Anwendungstechniker beraten Sie gern.

Updating of our product range

In the course of updating our product range, we are not only constantly adding new and technically improved products to our programme, but at the same time we are also continually reassessing the product range. In exceptional cases, it is possible that we no longer have the product you order on stock.

You will then receive a technically improved product or an equivalent alternative. In any case of doubt, our sales team will contact you in order to determine the optimal version for you. We ensure that you will always get the most updated products.

We therefore do not assume any obligation to supply products appearing in the catalogue and/or in the price list which have already been adjusted out of the system internally.

Bilz and its partners shall have no liability for indirect, incidental or consequential errors in this catalog.

Prices

For prices, please refer to the current price list.

Minimum order value

An additional handling fee of EUR 20.00 will be charged for orders with a total value of less than EUR 50.00.

The minimum order quantity for special tools is 3 pcs.

Special designs

If you find that your specific machining problems cannot be resolved with any of our permanently stocked products, then we can supply special designs or tools made according to drawings. Our application technicians will be glad to help you.

Nachdruck, auch auszugsweise, ist nur mit unserer Zustimmung gestattet. Alle Rechte vorbehalten. Irrtümer, Satz- oder Druckfehler berechtigen nicht zu irgendwelchen Ansprüchen. Abbildungen, Ausführungen und Maße entsprechen dem neuesten Stand bei Herausgabe dieser Druckschrift. Technische Änderungen müssen vorbehalten sein. Die bildliche Darstellung der Produkte muss nicht in jedem Falle und in allen Einzelheiten dem tatsächlichen Aussehen entsprechen.

This publication may not be reprinted in whole or part without our permission. All rights reserved. No rights may be derived from any errors in content or from typographical or typesetting errors. Diagrams, features, and dimensions represent the current status of the date of issue on this catalog. We reserve the right to make technical changes. The visual appearance of the products may not necessarily correspond to the actual appearance in all cases or in every detail.

Weitere BILZ Produktkataloge Further BILZ product catalogues



Fordern Sie heute noch kostenlos per E-Mail oder unter info@bilz.de unsere Kataloge an.
Order our catalogues free of charge by email or at info@bilz.de today!

Unser **ThermoGrip Schrumpfgeräte** Katalog
Our **ThermoGrip Shrink Machine** Catalogue
Kat. Nr.: 5053455



Unser **ThermoGrip Schrumpffutter** Katalog
Our **ThermoGrip Shrink Chucks** Catalogue
Kat. Nr.: 5053454



Unser **CNC Grip Werkzeugaufnahmen** Katalog
Our **CNC Grip Tool Holders** Catalogue
Kat. Nr.: 5061452

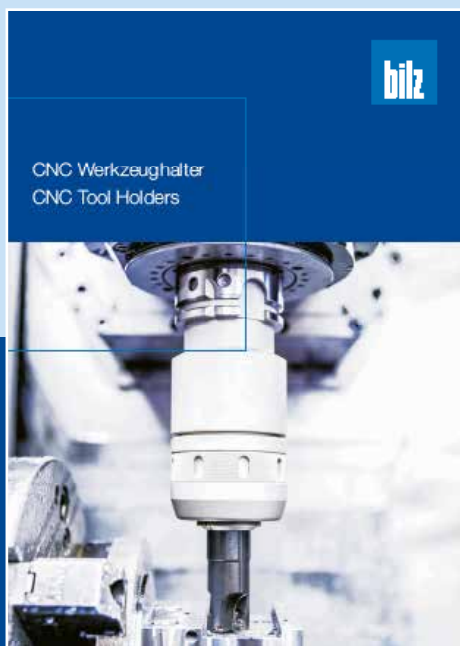

Unser **Druckluft und Ratschen** Katalog
Our **Air Pressure and Ratchets** Catalogue
Kat. Nr. 9078368

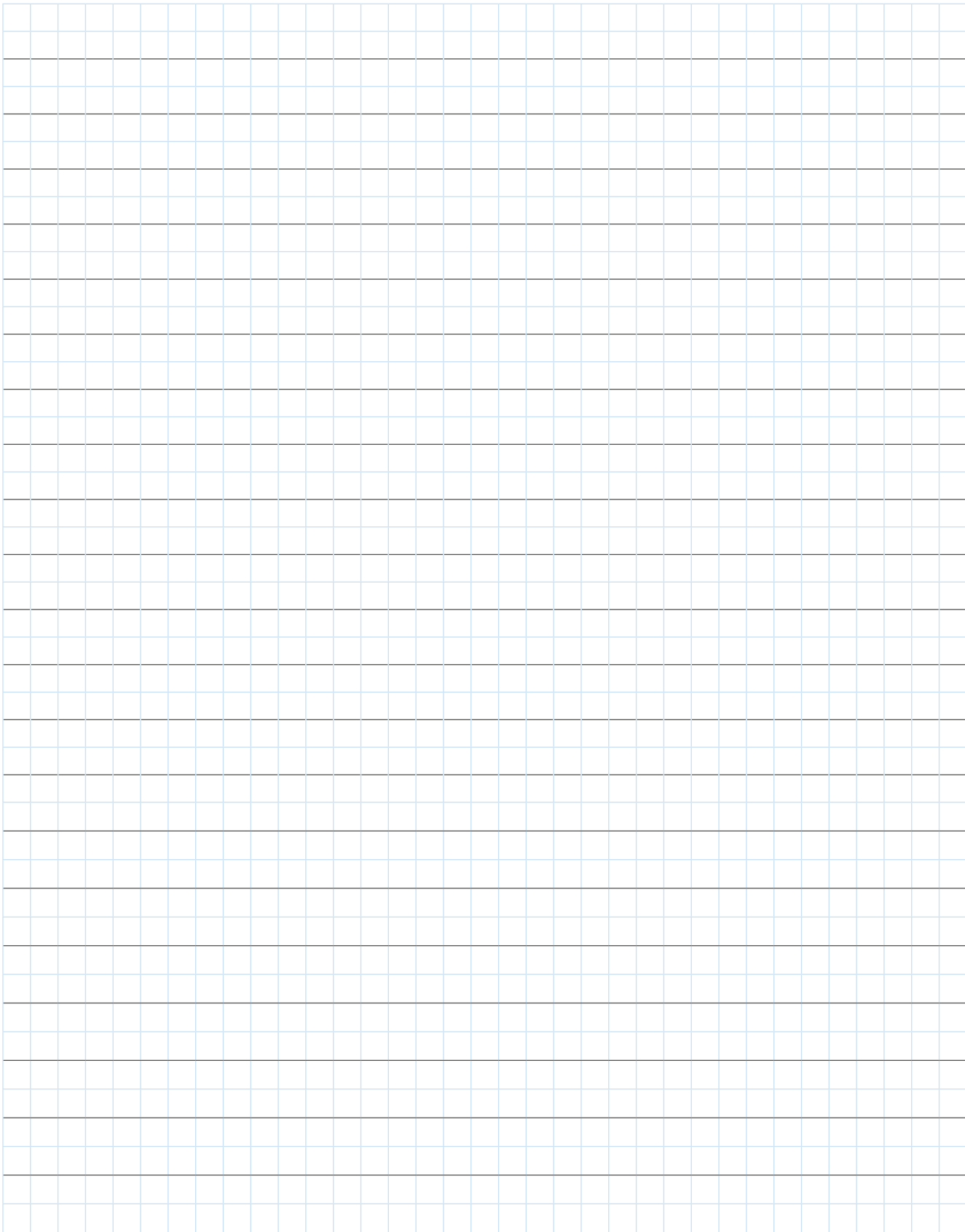

A large grid area for taking notes, consisting of a light blue grid pattern overlaid on a white background. The grid is composed of small squares, with a larger margin at the top for writing.



**BILZ WERKZEUGFABRIK
GmbH & Co. KG**
Vogelsangstr. 8
73760 Ostfildern
Deutschland/Germany
Telefon +49 711 348 01 -0
Telefax +49 711 348 12 56
info@bilz.de
www.bilz.de



*Produktions- und Vertriebsstandorte der LEITZ-Group
Production and sales locations of the LEITZ Group*

- **Bilz**
- **Boehlerit**
- **Leitz**