

Global Partner. Local Friend.

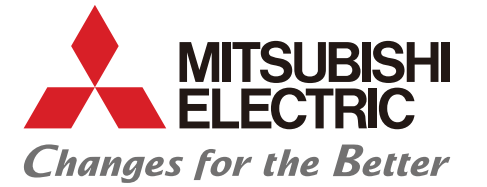
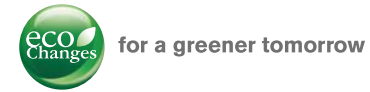

FACTORY AUTOMATION

MV Series

Wire-cut EDM Systems MV Series

MV series

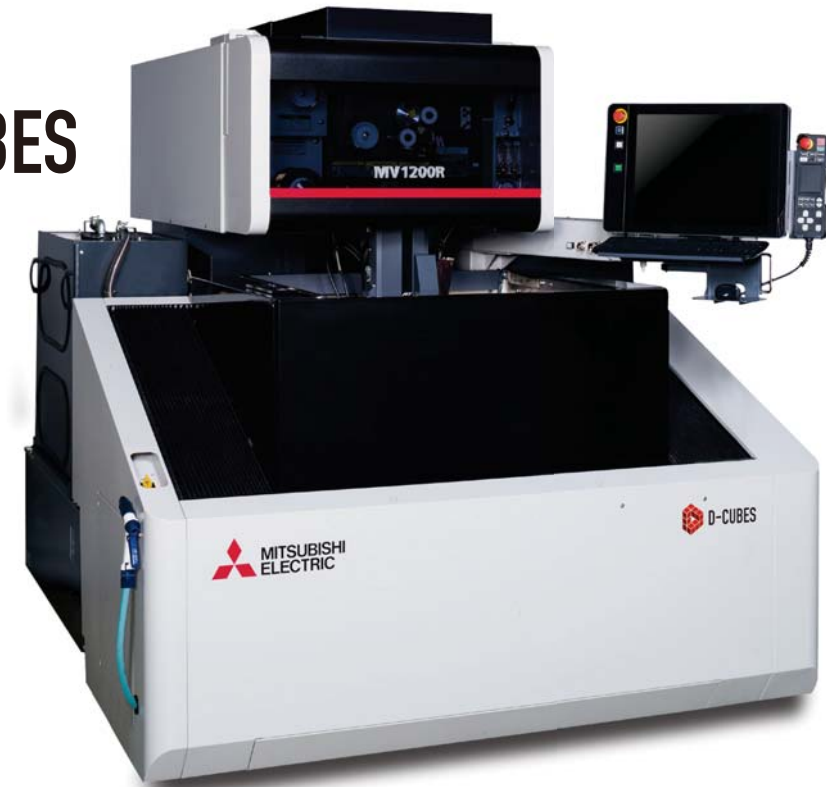

[YouTube] [YouTube logo] is a trademark or registered trademark of Google Inc.

Mitsubishi Electric Corporation Nagoya Works is a factory certified for ISO14001 (standards for environmental management systems) and ISO9001 (standards for quality assurance management systems)

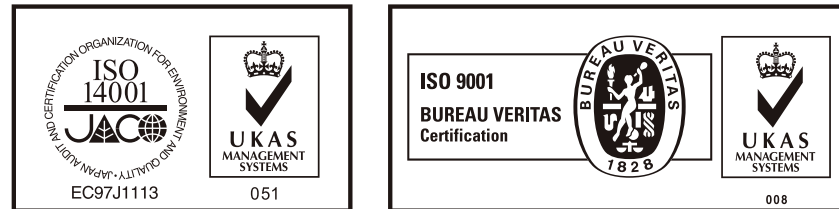

MITSUBISHI ELECTRIC CORPORATION HEAD OFFICE: TOKYO BLDG., 2-7-3 MARUNOUCHI, CHIYODA-KU, TOKYO 100-8310, JAPAN



▶ MV Series

GLOBAL IMPACT OF MITSUBISHI ELECTRIC



Through Mitsubishi Electric's vision, "Changes for the Better" are possible for a brighter future.

Changes for the Better

We bring together the best minds to create the best technologies. At Mitsubishi Electric, we understand that technology is the driving force of change in our lives. By bringing greater comfort to daily life, maximizing the efficiency of businesses and keeping things running across society, we integrate technology and innovation to bring changes for the better.

Mitsubishi Electric is involved in many areas including the following

- Energy and Electric Systems**
A wide range of power and electrical products from generators to large-scale displays.
- Electronic Devices**
A wide portfolio of cutting-edge semiconductor devices for systems and products.
- Home Appliance**
Dependable consumer products like air conditioners and home entertainment systems.
- Information and Communication Systems**
Commercial and consumer-centric equipment, products and systems.
- Industrial Automation Systems**
Maximizing productivity and efficiency with cutting-edge automation technology.

Mitsubishi Electric continues the challenge to be the only one FA machine and systems supplier delivering total customer satisfaction.

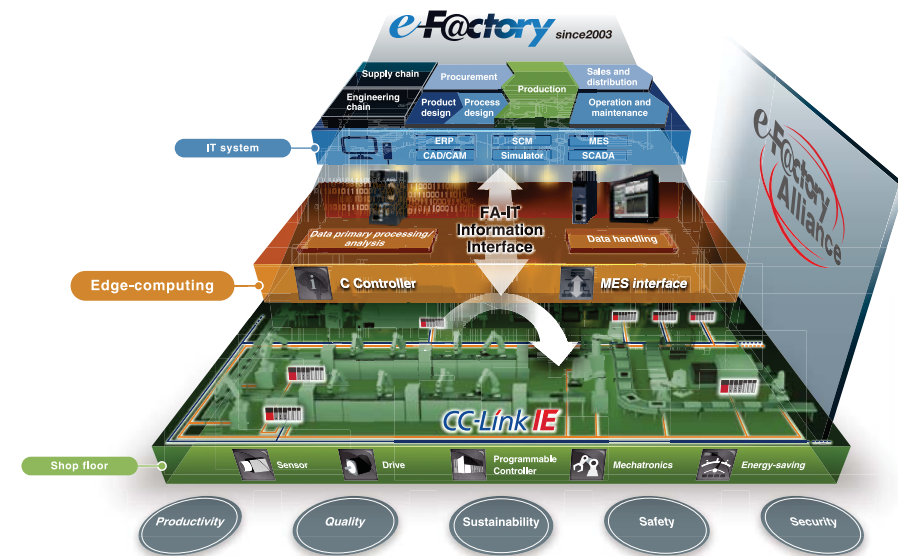

Mitsubishi Electric is a world-leading general electrical and electronic products manufacturer with wide-ranging business reach, from appliances for the home to systems used in outer space. Global-scale business development is in five business domains: heavy electrical machinery and systems, industrial automation, information and communication systems, electronic devices, and home appliances. Producing general electrical machinery for over 90 years, as Mitsubishi Electric's Factory Automation Systems Business Group, we have supported manufacturing in Japan, China, and Asia, and around the globe. In doing so, we have accumulated and refined technologies for FA control, drive control, automation, and manufacturing that are utilized to expand and improve a vast product lineup, such as controllers, drives, and automation and power distribution control products. In addition to product components like those listed above, we are quick to propose systems such as e-F@ctory and iQ Platform as solutions for production site innovation. As a comprehensive supplier of FA products and systems, Mitsubishi Electric will continue to respond to the voice of customers and deliver products of the utmost quality throughout the world.

INDEX

1. History of Wire-cut EDMs	3	10. Workability / Operability	25
2. Wire-cut EDM Systems	5	11. Energy Savings, Low Operating Cost	29
3. D-CUBES	7	12. Revolution	31
4. Product Line Up	9	13. Options	33
5. Functions and Features	15	14. Power Supply, Control Specifications / Machine Installation	35
6. Sample	17	15. Solutions	37
7. Automatic Wire Threading	19		
8. Machining Accuracy	21		
9. Productivity	23		

New generation makes it's mark in a continuously updated lineage.

1972



Line tracer type wire-cut EDM
DWC50S-LT1



DWC50H-DNC2



Taper machining unit
DWC100H-CNC2



Max. machining speed 60mm²/min
DWC90-CNC1

1980



DWC110N-CNC1



Max. machining speed 110mm²/min
Optimum surface roughness of Rz2µm
DWC90FSK-CNC1



DWC90G



Max. machining speed 250mm²/min
DWC90H



DWC90PH



DWC110PH



DWC90C



Ultrahigh accuracy wire-cut EDM (Full-cabin)
PX05



FX10



DWC90PA



CX20



SX20



Anti-electrolysis power supply (AE power supply)
DWC400HA



DWC110SA



Automatic wire threading unit "AF2"
DWC110SZ

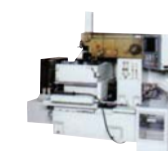

Automatic wire threading unit (water jet type)
DWC90SB



32 bit CNC
DWC90HA

1990



FX20K



64 bit CNC
QA20



RA90AT

2000



Max. machining speed 325mm²/min
Automatic wire threading unit "AT"
FA20



FA20P

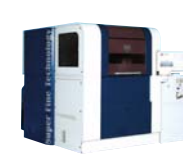

PA20



World's fastest "V500" power supply
FA30V



PA05S



FA20S



Super fine finishing power supply "Digital-FS"
FA10PS

FA10PS

2016



MV1200R

2014



MP1200

2013



Oil wire-cut EDM
MX600



PA10 ADVANCE

2012



MV1200R



Linear Shaft motor
NA2400P



BA8



Digital-AE power supply
FA20S Advance

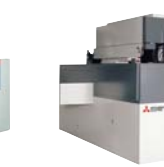

Large-sized wire-cut EDM
FA50V

MITSUBISHI ELECTRIC Wire-cut EDM Systems

MV Series

Innovated basic performance for Wire cut EDM

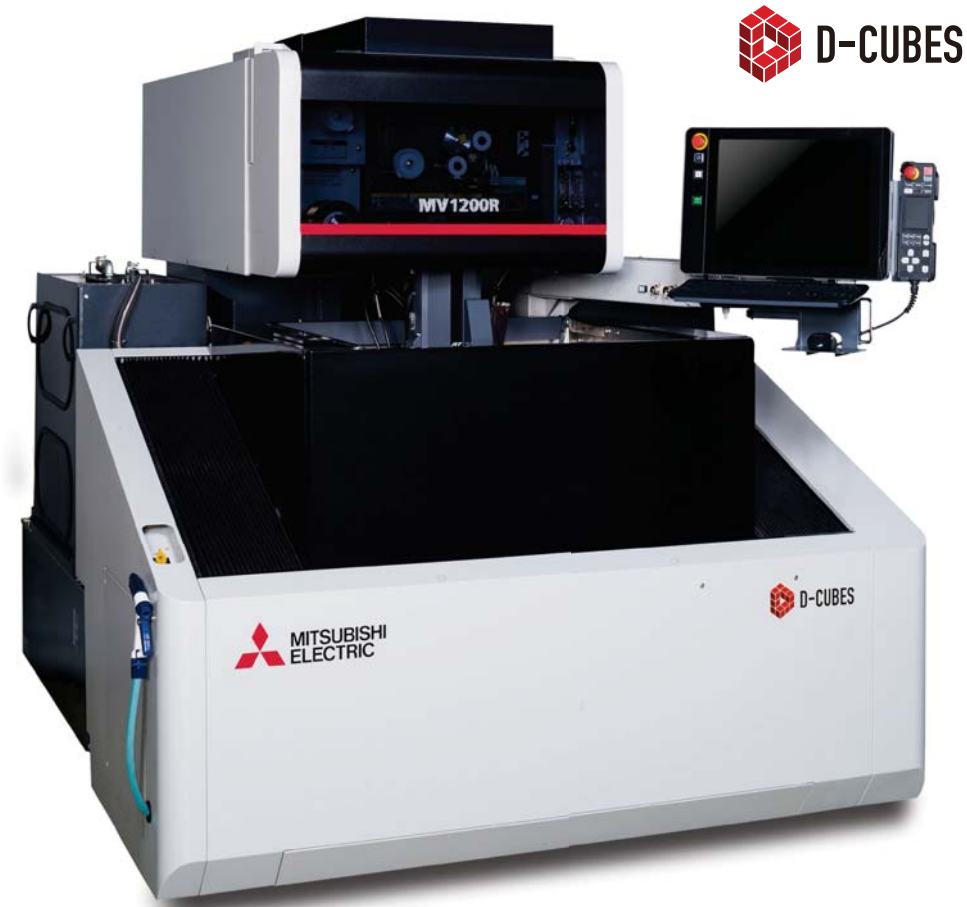

MV Series

Wire-cut EDM Systems Line up

Model line-up covers your machining needs from parts production machining to super-accurate mold making

Ultra-high accuracy machines

MX 600 Oil

Flagship model incorporating extreme precision machining



MP Series *SERIES MP Water Technology*

High-class model incorporating a ultra-high accuracy machining



PA05S ADVANCE

Flagship model incorporating extreme precision machining



High-performance machine D-CUBES

MV-R Series

High-performance model innovating the next-generation of high-performance machines



High-productivity machine D-CUBES

MV-S Series

Standard model pursuing a cost performance machining system

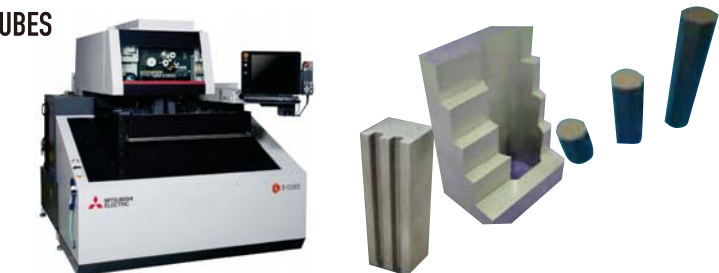

Opening the door to IoT New type control unit “D-CUBES”

MV series with new controller **D-CUBES**
By improving machining accuracy and utilizing IoT technology, we will support customer productivity improvement, with innovation technology, manufacturing will be on the next stage



3
D-CUBES



Connect

- MTConnect (open)

Universal

- Multilingual support
- Rotating / tilting mechanism
- Thin manual control box

Brain

- Adaptive control automatic setting
- Consumables check

Evolution

- For productivity IoT compatible NC

Smooth

- 19inch touch screen
- Navigation
- Easy shape (CAD/CAM)

Product Line-up

High quality machining is the "MV-R" series.



D-CUBES MV1200R

- 4-axis LSM (XYUV linear shaft motor)
- Four-sided hardened table

<Automatic vertical Front door>

D-CUBES MV2400R

- 4-axis LSM (XYUV linear shaft motor)
- Four-sided hardened table



<Automatic vertical Front door>

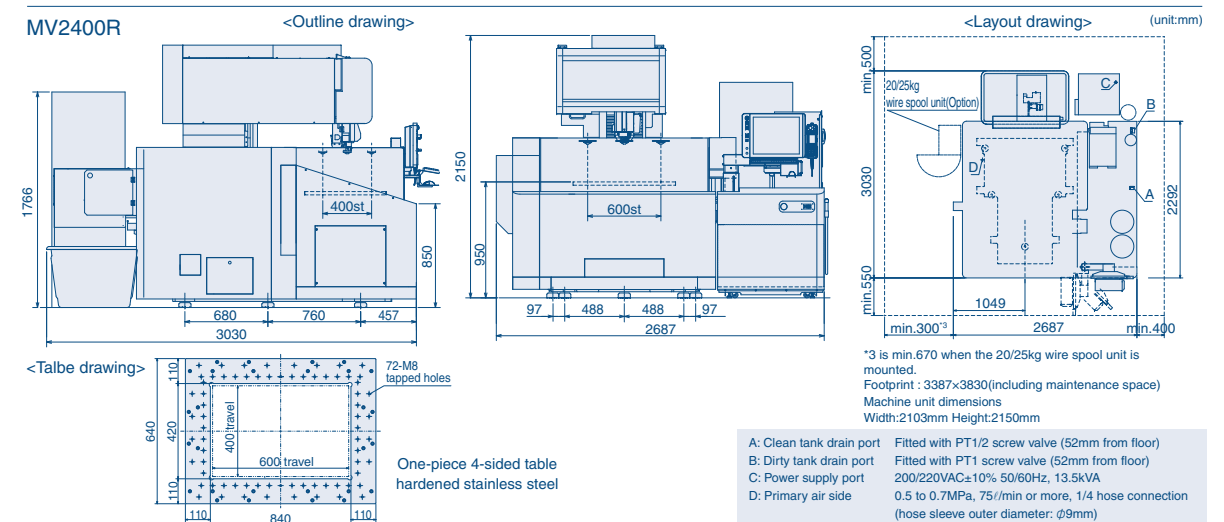
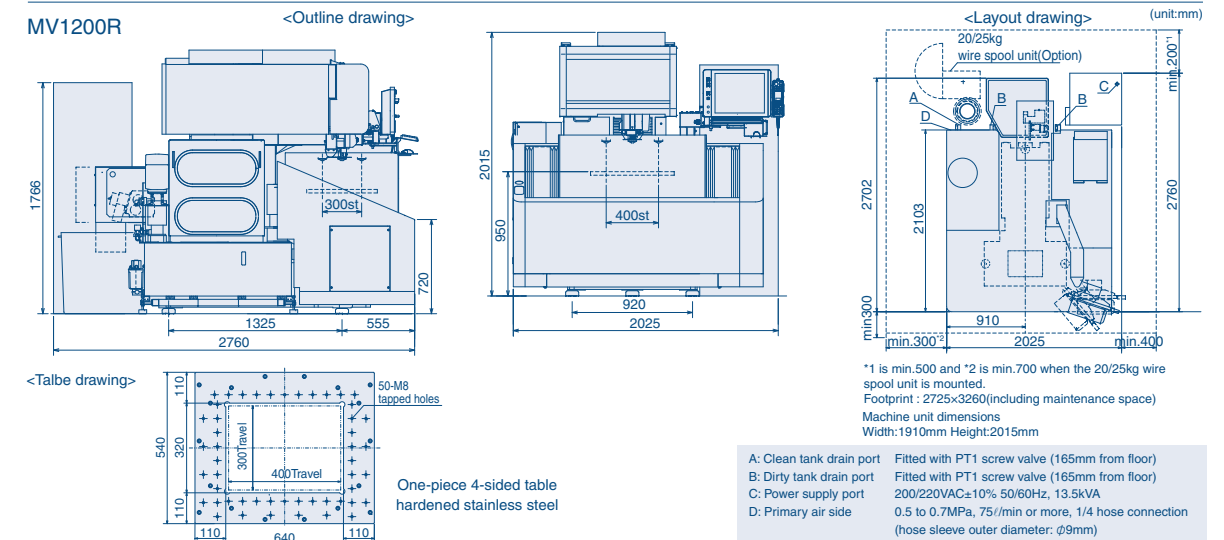

Standard machine specifications			
	Model	MV1200R	MV2400R
Machine unit	Max. workpiece dimensions [mm]	810×700×215	1050×820×305
	Max. workpiece weight [kg]	500	1500
	Table dimensions [mm]	640×540 (4-sided)	840×640 (4-sided)
	Machine travels (XxYxZ) [mm]	400×300×220 (XY axis LSM drive)	600×400×310 (XY axis LSM drive)
	Machine travels (UxV) [mm]	±60×±60 (LSM drive)	±75×±75 (LSM drive)
	Max. taper angle [°]	15°(max. 200mm)	15°(max. 260mm)
	Wire diameter [mm]	0.1 ~ 0.3 ¹	
Dielectric fluid reservoir	Weight [kg]	2700 (including dielectric fluid reservoir)	3500
	Tank capacity [l]	550	860
	Filtration method	Paper filter (2)	
	Filtered particle size [μm]	3	
	Water purifier (ion exchange resin) [l]	10	
	Dielectric fluid chiller unit	Unit cooler	
Weight (dry) [kg]	— (included in the machine unit weight)		
			350

¹ φ0.2 DD guides and φ1.5 jet nozzle are standard equipment.

General input		[kVA]	13.5
	Required air rate	Air pressure [Mpa]	0.5 ~ 0.7
		Air rate [l/min]	75 or more

Standard functions	Options
<ul style="list-style-type: none"> Automatic wire threading Digital-AEII power supply LAN/W (Ethernet) Angle Master (S/W) Anti-virus protection Option box 	<ul style="list-style-type: none"> Sleep mode Filter pressure sensor DNC (S/W) FTP (S/W) φ0.05, 0.07 automatic wire threading Angle Master ADVANCE (S/W) Digital-FS power supply COREHOLD LED light Angle Mater guide kit φ0.2 Angle Mater guide kit φ0.25 External signal output 4-piece filter system Filter automatic switching (4-piece filter system)

Product Line-up

Standard Wire-cut EDMs



D-CUBES
MV1200S

2-axis LSM (XY linear shaft motor)
U-shaped hardened table

<manual vertical front door>

D-CUBES
MV2400S

2-axis LSM (XY linear shaft motor)
U-shaped hardened table



<Automatic vertical Front door>

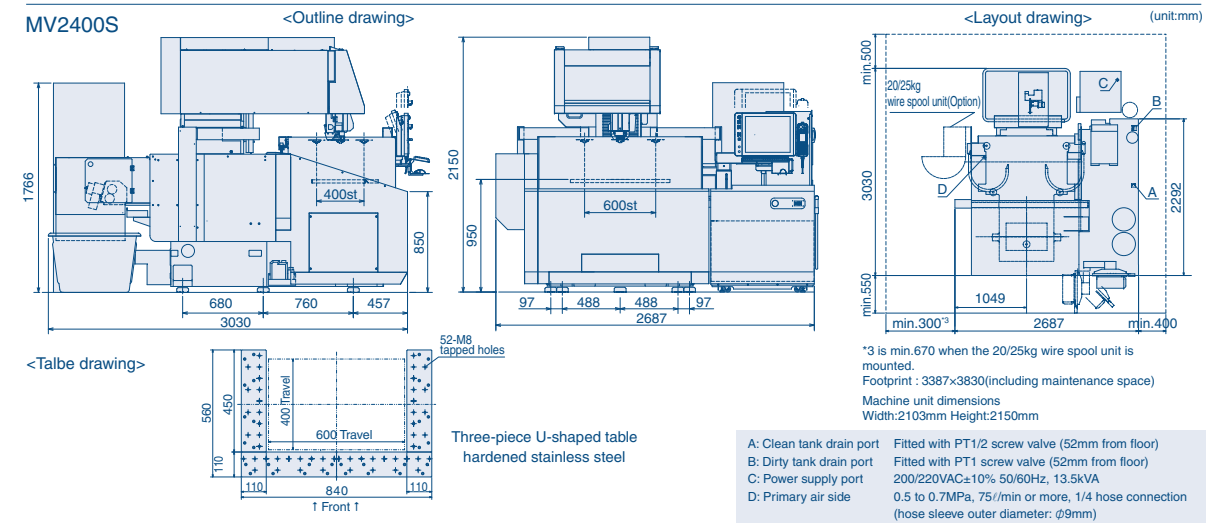
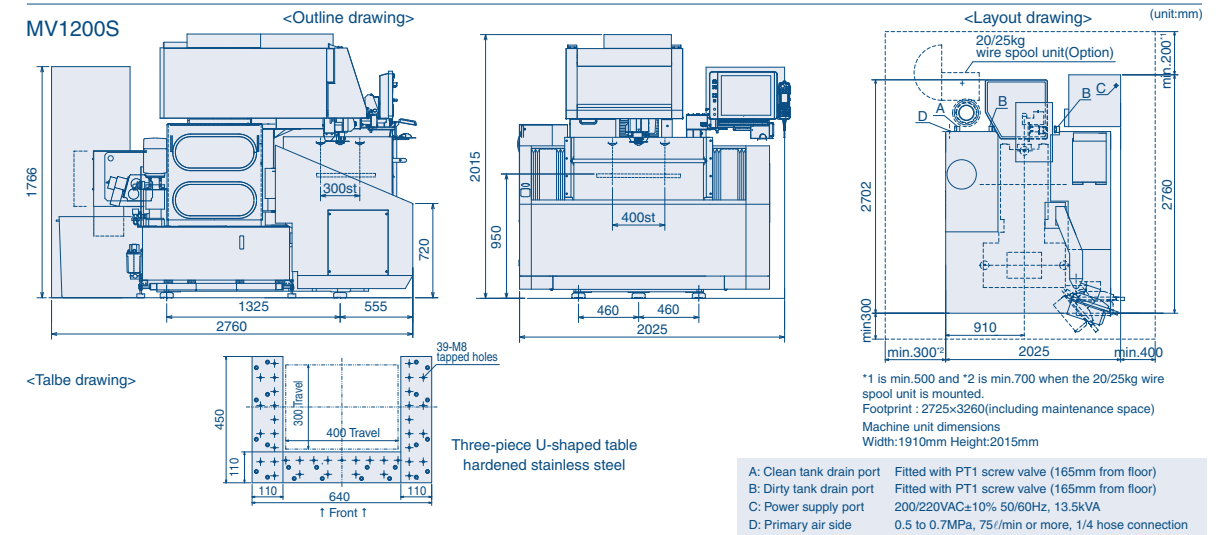

Standard machine specifications			
	Model	MV1200S	MV2400S
Machine unit	Max. workpiece dimensions [mm]	810x700x215	1050x820x305
	Max. workpiece weight [kg]	500	1500
	Table dimensions [mm]	640x540 (4-sided)	840x640 (4-sided)
	Machine travels (XxYxZ) [mm]	400x300x220 (XY axis LSM drive)	600x400x310 (XY axis LSM drive)
	Machine travels (UxV) [mm]	±60x±60 (Ball Screw drive)	±75x±75 (Ball Screw drive)
	Max. taper angle [°]	15°(max. 200mm)	15°(max. 260mm)
	Wire diameter [mm]	0.1 ~ 0.3 ¹	
Dielectric fluid reservoir	Weight [kg]	2700 (including dielectric fluid reservoir)	3500
	Tank capacity [l]	550	860
	Filtration method	Paper filter (2)	
	Filtered particle size [μm]	3	
	Water purifier (ion exchange resin) [l]	10	
	Dielectric fluid chiller unit	Unit cooler	
Weight (dry) [kg]	— (included in the machine unit weight)		
			350

¹ φ0.2 DD guides and φ1.5 jet nozzle are standard equipment.

General input	[kVA]	13.5
	Air pressure [MPa]	0.5 ~ 0.7
	Air rate [l/min]	75 or more

Standard functions	Options
<ul style="list-style-type: none"> Automatic wire threading Digital-AEII power supply LAN/W (Ethernet) Angle Master (S/W) 	<ul style="list-style-type: none"> 20/25kg wire spool unit Angle Mater guide kit φ0.2 Angle Mater guide kit φ0.25 External signal output Option box Run timer LED light 4-piece filter system

- Filter automatic switching (4-piece filter system)
- Anti-virus protection

Product Line-up

MV2400S column up specification



<automatic vertical front door>

ADVANCE TYPE 3
2-axis LSM (XY linear shaft motor)
Four-sided hardened table

MV2400S (column up specification) <Outline drawing>

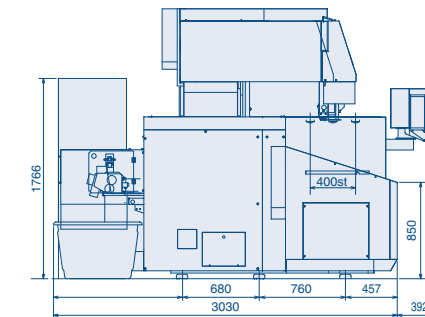

<Table drawing>

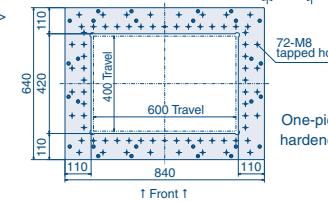

One-piece 4-sided table
hardened stainless steel

1 Front 1

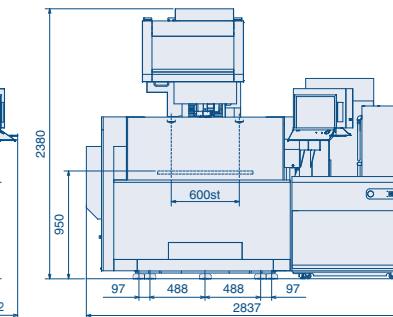

<Layout drawing> (unit:mm)

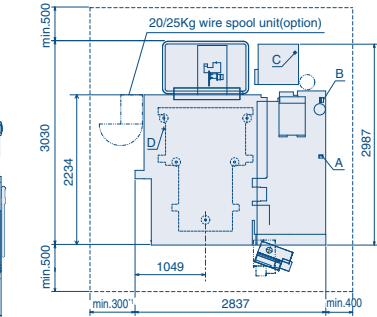

*1 is min.670 when the 20/25kg wire spool unit is mounted.
Footprint : 3537x4222(including maintenance space)
Machine unit dimensions
Width:2085mm Height:2380mm

A: Clean tank drain port Fitted with PT1/2 screw valve (52mm from floor)
B: Dirty tank drain port Fitted with PT1 screw valve (52mm from floor)
C: Power supply port 200/220VAC±10% 50/60Hz, 13.5kVA
D: Primary air side 0.5 to 0.7MPa, 75/min or more, 1/4 hose connection (hose sleeve outer diameter: φ9mm)

MV4800 / MV4800 Z310 specification



Standard
<automatic vertical front door>



Z310 specification
<automatic vertical front door>

ADVANCE TYPE 3
2-axis LSM (XY linear shaft motor)
U-shaped hardened table

MV4800

<Outline drawing>

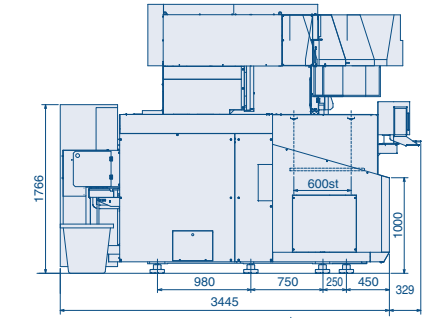

<Table drawing>

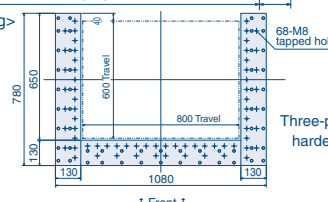

Three-piece U-shaped table
hardened stainless steel

1 Front 1

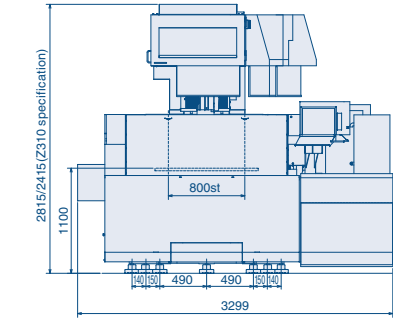

<Layout drawing> (unit:mm)

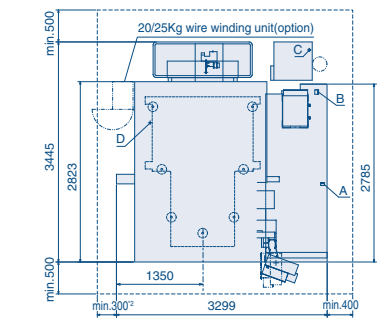

*2 is min.570 when the 20/25kg wire spool unit is mounted.
Footprint : 3999x4445(including maintenance space)
Machine unit dimensions
Width:2587mm Height:2815mm

A: Clean tank drain port Fitted with PT1/2 screw valve (52mm from floor)
B: Dirty tank drain port Fitted with PT1 screw valve (52mm from floor)
C: Power supply port 200/220VAC±10% 50/60Hz, 13.5kVA
D: Primary air side 0.5 to 0.7MPa, 75/min or more, 1/4 hose connection (hose sleeve outer diameter: φ9mm)

Standard machine specifications				
	Model	MV2400S (column up specification)	MV4800	MV4800 Z310 specification
Machine unit	Max. workpiece dimensions [mm]	1050x820x420	1250x1020x505	1250x1020x305
	Max. workpiece weight [kg]	1500	3000	3000
	Table dimensions [mm]	840x640 (4-sided)	1080x780 (U-shaped)	1080x780 (U-shaped)
	Machine travels (XxYxZ) [mm]	600x400x425 (XY axis LSM drive)	800x600x510 (XY axis LSM drive)	800x600x310 (XY axis LSM drive)
	Machine travels (UxV) [mm]	±75x±75 (Ball screw drive)	±100x±100 (Ball screw drive)	±75x±75 (Ball screw drive)
	Max. taper angle [°]	15°(max. 260mm)	15°(max. 355mm)	15°(max. 260mm)
	Wire diameter [mm]	0.1 ~ 0.3 ¹	0.1 ~ 0.3 ¹	0.15 ~ 0.3 ¹
Dielectric fluid reservoir	Weight [kg]	3650	5700	5450
	Tank capacity [l]	980	1480	1480
	Filtration method	Paper filter (2)	Paper filter (4)	Paper filter (4)
	Filtered particle size [μm]		3	3
	Water purifier (ion exchange resin) [l]		10	10
	Dielectric fluid chiller unit		Unit cooler	Unit cooler
	Weight (dry) [kg]	390	450	450
General input	[kVA]		13.5	
	Air pressure [Mpa]		0.5 ~ 0.7	
	Air rate [l/min]		75 or more	

¹ φ0.2 DD guides and φ1.5 jet nozzle are standard equipment.

Standard functions	Options
<ul style="list-style-type: none"> Automatic wire threading Digital-AEII power supply LAN/W (Ethernet) Angle Master (S/W) Sleep mode (MV4800) 	<ul style="list-style-type: none"> 20/25Kg wire spool unit 50kg wire spool unit Angle Mater guide kit φ0.2 Angle Mater guide kit φ0.25 Angle Master ADVANCE (S/W) (MV4800) Advanced manual control box External signal output 3-color warning light Run timer Option box LED light 4-piece filter system Anti-virus protection

Functions and Features

The MV series is fully equipped with enhanced functions that satisfy the requirements of the manufacturing site, such as sophisticated style, high performance, energy-saving, operability and workability, abundant processing knowhow, etc.

MV1200R
MV2400R
MV1200S
MV2400S

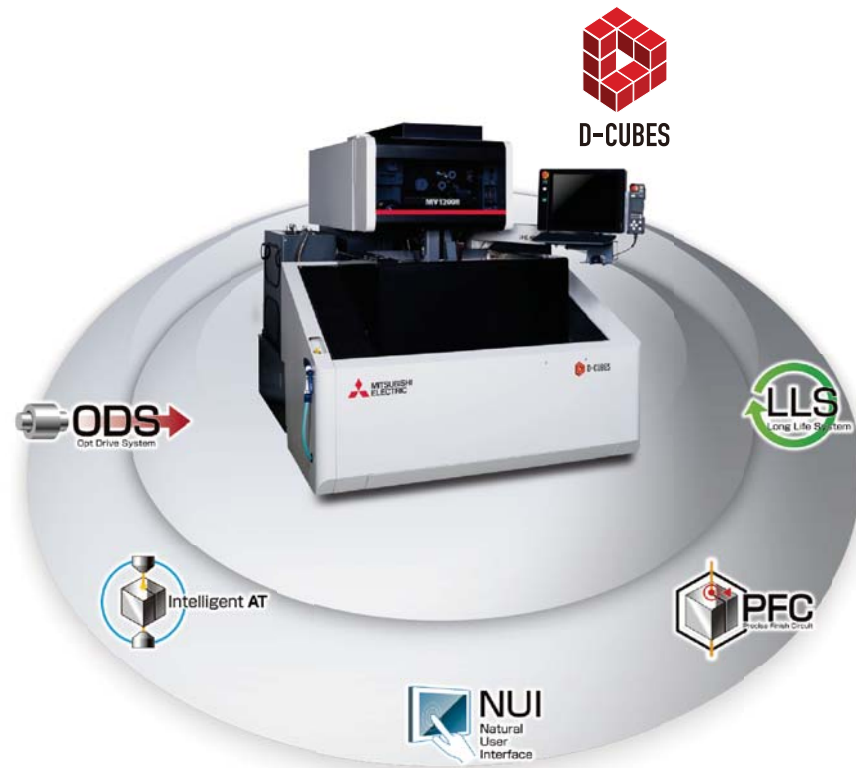

MV2400S Column up specification
MV4800
MV4800 Z310 specification



Automatic wire threading

Intelligent AT Refer to page19-20

- New annealing system greatly improves wire threading with a curl ratio of less than 10%
- Wire break point insertion is greatly improved for thick workpieces
- Wire threading suitable for workpiece shape (jet stream on, jet stream off and submerged dbreak point insertion)

▲Video of automatic wire threading

Machining accuracy

ODS (Opt Drive System) Refer to page21-22

- Equipped with a linear shaft motor(LSM)
- Circular accuracy within 1μm is realized using optical drive system(ODS)

Improved productivity

PFC (Precision Finish Circuit) Refer to page23-24

- Surface roughness improvements are realized through enhanced power supply performance for high speed machining.

Conventional MV	Rz1.6μm(Ra0.2μm)	33% improvement as compared to the past
MV-R	An R _z value of 1.6 μm is achieved!	Best surface roughness

Workpiece : Steel/60mmt
Electrode : φ0.20mm BS
Accuracy : ±0.003mm

- Surface finish reduced by 50% by machining with only 2 cuts.

Conventional model	Rz13~15μm	Approx. 1/2 as compared to the past
MV-R/S	Rz6.4μm	

Surface Roughness

- Machining time comparison for Rz 3.5 μm/Ra 0.45 μm with 3 cuts

MV-S	9% OFF
MV-R	17% OFF
Conventional model	100(%)

Compared to conventional Mitsubishi Electric Wire-cut EDM (FA Series), with to the same machining amounts

Operability

NUI (Natural User Interface) Refer to page25-28

- Information is displayed on a large 19-inch screen
- Functions to be viewed or used are called by one touch from the HOME screen
- The number of operations performed on the Navigation menu from setup to machining is reduced by almost 40% (as compared to the past)
- Setup performance is improved by a thin hand pendant box with LED.

Energy savings, low operating cost

LLS (Long Life System) Refer to page29-30

- The operating cost of the machine can be viewed on the cost management screen. This is useful for budget planning.

Power monitor

Machining results monitor

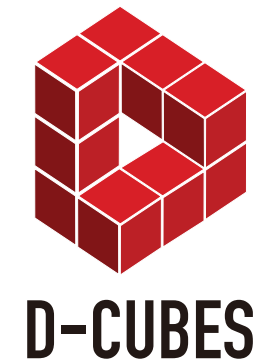

Sample

Revolutionize manufacturing with next generation high performance machining



	<p>Step</p> <table border="1"> <tr><td>Model</td><td>MV2400R</td></tr> <tr><td>Electrode material</td><td>φ0.25/BS</td></tr> <tr><td>Workpiece</td><td>Steel (SKD11)</td></tr> <tr><td>Workpiece thickness</td><td>20-200mm</td></tr> <tr><td>Surface roughness</td><td>Rz4.3μm/Ra0.55μm</td></tr> <tr><td>Machining accuracy</td><td>±15μm</td></tr> </table>	Model	MV2400R	Electrode material	φ0.25/BS	Workpiece	Steel (SKD11)	Workpiece thickness	20-200mm	Surface roughness	Rz4.3μm/Ra0.55μm	Machining accuracy	±15μm	<ul style="list-style-type: none"> Highly accurate machining is possible using ODS Due to D-CUBES SL, the occurrence of wire lines is prevented even with parts having varying workpiece thickness
Model	MV2400R													
Electrode material	φ0.25/BS													
Workpiece	Steel (SKD11)													
Workpiece thickness	20-200mm													
Surface roughness	Rz4.3μm/Ra0.55μm													
Machining accuracy	±15μm													
	<p>Conecter</p> <table border="1"> <tr><td>Model</td><td>MV1200R</td></tr> <tr><td>Electrode material</td><td>φ0.2/BS</td></tr> <tr><td>Workpiece</td><td>Steel (SKD11)</td></tr> <tr><td>Workpiece thickness</td><td>4~25mm</td></tr> <tr><td>Surface roughness</td><td>Rz3.1μm/Ra0.38μm</td></tr> <tr><td>Machining accuracy</td><td>±3μm</td></tr> </table>	Model	MV1200R	Electrode material	φ0.2/BS	Workpiece	Steel (SKD11)	Workpiece thickness	4~25mm	Surface roughness	Rz3.1μm/Ra0.38μm	Machining accuracy	±3μm	<ul style="list-style-type: none"> Highly accurate machining is possible using ODS A machining accuracy of ±3μm is realized for high L/D machining of pin widths from 1.0 to 4.5mm and a length of 40mm
Model	MV1200R													
Electrode material	φ0.2/BS													
Workpiece	Steel (SKD11)													
Workpiece thickness	4~25mm													
Surface roughness	Rz3.1μm/Ra0.38μm													
Machining accuracy	±3μm													
	<p>Gear</p> <table border="1"> <tr><td>Model</td><td>MV1200R</td></tr> <tr><td>Electrode material</td><td>φ0.2/BS</td></tr> <tr><td>Workpiece</td><td>Steel (SKD11)</td></tr> <tr><td>Workpiece thickness</td><td>4~25mm</td></tr> <tr><td>Surface roughness</td><td>Rz3.1μm/Ra0.38μm</td></tr> <tr><td>Machining accuracy</td><td>±3μm</td></tr> </table>	Model	MV1200R	Electrode material	φ0.2/BS	Workpiece	Steel (SKD11)	Workpiece thickness	4~25mm	Surface roughness	Rz3.1μm/Ra0.38μm	Machining accuracy	±3μm	<ul style="list-style-type: none"> Highly accurate machining is possible using ODS New corner machining control (CM3) improves shape accuracy to within ±2μm under nozzle release conditions
Model	MV1200R													
Electrode material	φ0.2/BS													
Workpiece	Steel (SKD11)													
Workpiece thickness	4~25mm													
Surface roughness	Rz3.1μm/Ra0.38μm													
Machining accuracy	±3μm													
	<p>Taper</p> <table border="1"> <tr><td>Model</td><td>MV2400R</td></tr> <tr><td>Electrode material</td><td>φ0.2/BS</td></tr> <tr><td>Workpiece</td><td>Steel (SKD11)</td></tr> <tr><td>Workpiece thickness</td><td>D:60mm, P:70mm Angle10°</td></tr> <tr><td>Surface roughness</td><td>Rz2.8μm/Ra0.35μm</td></tr> <tr><td>Machining accuracy</td><td>±5μm</td></tr> </table>	Model	MV2400R	Electrode material	φ0.2/BS	Workpiece	Steel (SKD11)	Workpiece thickness	D:60mm, P:70mm Angle10°	Surface roughness	Rz2.8μm/Ra0.35μm	Machining accuracy	±5μm	<ul style="list-style-type: none"> Taper accuracy is improved regardless of wire angle direction using Angle Master ADVANCE ODS provides high accuracy when cutting a U-V independent tapered shape
Model	MV2400R													
Electrode material	φ0.2/BS													
Workpiece	Steel (SKD11)													
Workpiece thickness	D:60mm, P:70mm Angle10°													
Surface roughness	Rz2.8μm/Ra0.35μm													
Machining accuracy	±5μm													
	<p>High thickness</p> <table border="1"> <tr><td>Model</td><td>MV2400S</td></tr> <tr><td>Electrode material</td><td>φ0.25/BS</td></tr> <tr><td>Workpiece</td><td>Steel (SKD11)</td></tr> <tr><td>Workpiece thickness</td><td>200mm</td></tr> <tr><td>Surface roughness</td><td>Rz4.8μm/Ra0.71μm</td></tr> <tr><td>Machining accuracy</td><td>±3μm</td></tr> </table>	Model	MV2400S	Electrode material	φ0.25/BS	Workpiece	Steel (SKD11)	Workpiece thickness	200mm	Surface roughness	Rz4.8μm/Ra0.71μm	Machining accuracy	±3μm	<ul style="list-style-type: none"> High-speed and highly accurate machining are possible using PFC High-speed and highly accurate machining are possible using PFC with thickness of 200mm
Model	MV2400S													
Electrode material	φ0.25/BS													
Workpiece	Steel (SKD11)													
Workpiece thickness	200mm													
Surface roughness	Rz4.8μm/Ra0.71μm													
Machining accuracy	±3μm													
	<p>Pitch</p> <table border="1"> <tr><td>Model</td><td>MV2400R High accuracy specification</td></tr> <tr><td>Electrode material</td><td>φ0.2mm BS</td></tr> <tr><td>Workpiece</td><td>Steel (SKD11)</td></tr> <tr><td>Workpiece thickness</td><td>30mm</td></tr> <tr><td>Surface roughness</td><td>Rz1.6μm/Ra0.2μm</td></tr> <tr><td>Machining accuracy</td><td>Pitch±1.5μm</td></tr> </table>	Model	MV2400R High accuracy specification	Electrode material	φ0.2mm BS	Workpiece	Steel (SKD11)	Workpiece thickness	30mm	Surface roughness	Rz1.6μm/Ra0.2μm	Machining accuracy	Pitch±1.5μm	<ul style="list-style-type: none"> Stable automatic wire threading is realized by Intelligent AT even in multi-shape machining. Stable high accuracy machining is realized by ODS, improvement of axis movement accuracy and dielectric fluid control.
Model	MV2400R High accuracy specification													
Electrode material	φ0.2mm BS													
Workpiece	Steel (SKD11)													
Workpiece thickness	30mm													
Surface roughness	Rz1.6μm/Ra0.2μm													
Machining accuracy	Pitch±1.5μm													

*The listed machining results are all based on in-house conditions and measurements.

Innovative Automatic Wire Threading

Advanced technology for greatly improved productivity

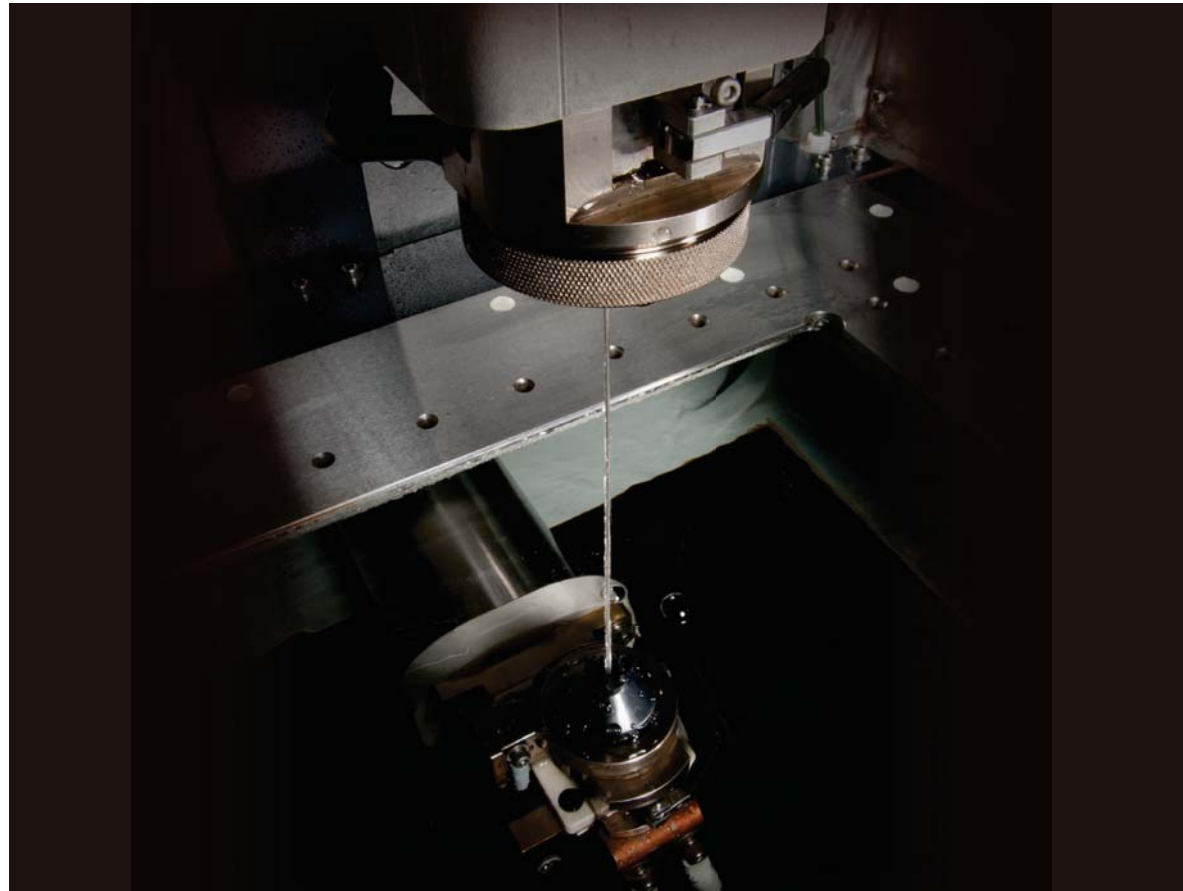
Improved automatic wire threading

- New annealing system greatly improves wire threading with a curl ratio of less than 10%
- Wire break point insertion is greatly improved for thick workpieces
- Wire threading mode can be selected to match the workpiece shape (i.e., jet stream on, jet stream off and submerged break point insertion)
- Automatic threading time is reduced by up to 35% when using AT high-speed mode (includes one wire cut and insertion cycle)



Video of Automatic wire threading



Multiple level wire threading is possible even without a jet stream. Highly dependable automatic threading for multi-opening applications

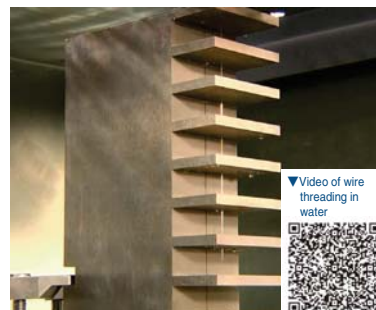

Video of wire threading in water



Submerged automatic wire threading/re-threading drastically reduces total machining time in multiple level workpieces.

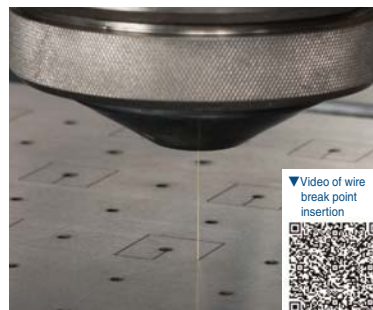

Video of wire break point insertion



Wire break point insertion is possible

Wire electrode annealing structure

- Improved wire annealing power supply and tension control enhance wire threading (reducing the curl ratio down to 10% or less), which straightens the natural curl caused by spooling
 - The greatly increased length distance of annealed wire improves automatic wire threading for thick workpieces
- *Wire with a curl ratio of no more than 3% is required for the conventional model (FA Series)

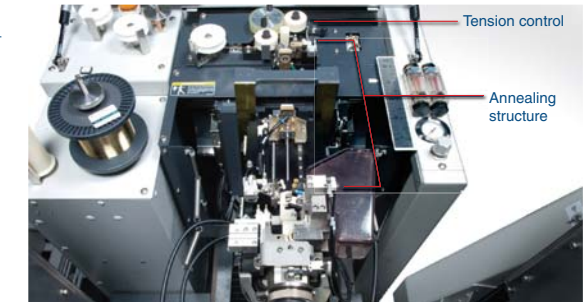

New jet stream flow mechanism

- Flow analysis simulation has been used to optimize the water flow mechanism for straightening the jet stream, which improves wire threading for thick workpieces

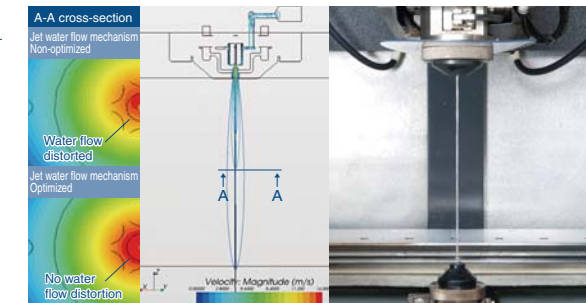

Wire collection unit

- Broken wire collection, which clears the upper guide after a wire break, has been improved so it handles even highly curled wire



Maintenance management

- The AT maintenance screen displays each section of the AT unit and records any miss-feed locations. This quick reference makes it easy to maintain the effected area.

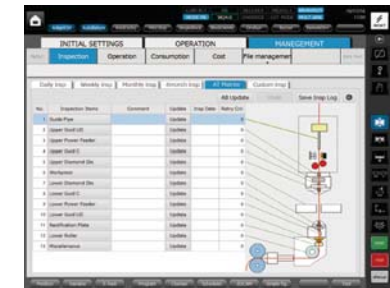

One-touch lever clamp mechanism

- New one-touch lever clamping system provides quick, easy and accurate power feed indexing
- The clamp lever accurately locates the power feeder with repeatable torque, unlike systems that use the set-screw method



Diamond guide

- A round diamond guide is used to provide the best accuracy for both straight and taper cutting applications
- Both upper and lower guides can be replaced by simply unscrewing the flush caps



Machining Accuracy



Next-generation drive system and optimum machine structure

Optical Drive System

- High-speed fiber-optic communications and a linear shaft motor synergistically improve machining accuracy
- A servo amplifier and control unit developed by Mitsubishi Electric contribute to system optimization

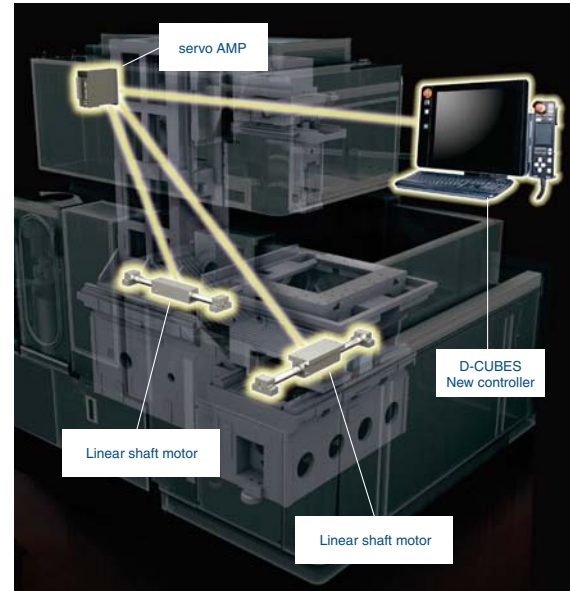

Linear Shaft Motor (LSM)

- Power consumption is reduced by utilizing a full 360° magnetic flux as the effective driving force
- Highly accurate axis movement is possible without any backlash
- Non contact power transmission ensures stable and accurate axis movement for many years

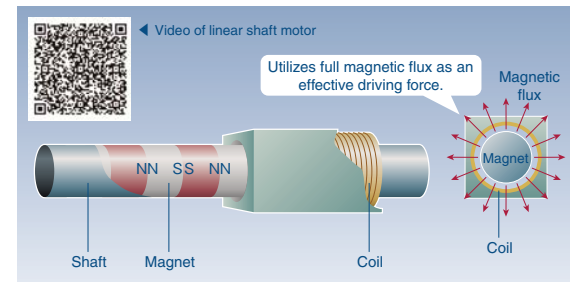

Shape control power supply (Digital-AE II)

- Wire straightness is digitally controlled with the world's only electrical-discharge position control (As of Mar. '12)
- Total machining time is reduced by improving straightness accuracy during rough, intermediate and finishing processes

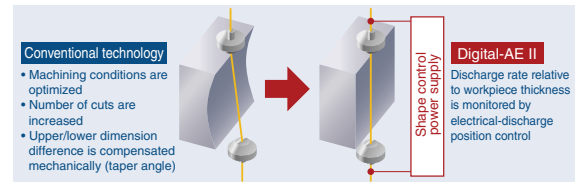

Comparison of straightness accuracy during finish machining

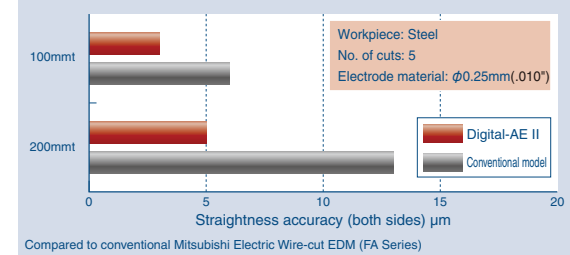

Fully-automatic rough machining control (D-CUBES)



- Approach control adjustment parameters (CM level selection, EM wire path correction)
- CM-R expansion (corner control, approach control) can be set individually (control ON/OFF, parameters)
- Adaptive control switches such as EM are set automatically by the E pack command depending on the shape (die, punch) or workpiece thickness. The optimum machine processing values are set even if the operator forgets to enter them

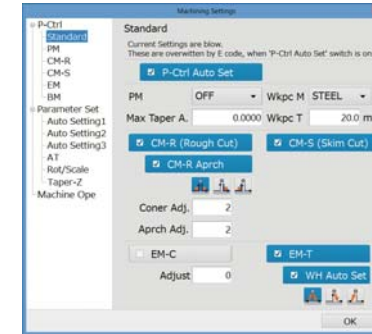

Examples of PM machining applications

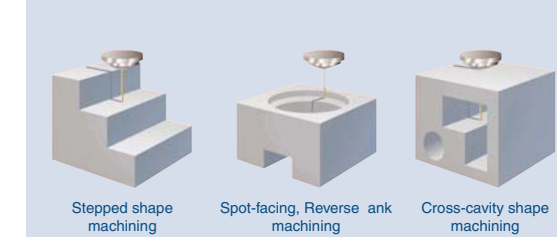

Under-cut (dimple) reduction control (EM control: Entrance Master)

- Reduces dimples at the approach section
- Allows shape adjustment from convex to concave
- Greatly reduces polishing time

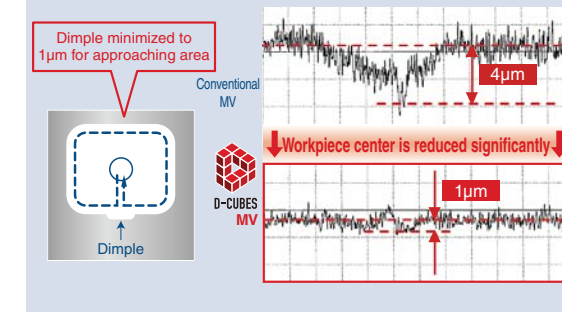

Corner machining control (CM3control: Corner Master3)

- Improves machining accuracy at extremely small in-corners and out-corners
- Realizes highly accurate shape machining even for complicated geometries with several types and sizes of corners
- Corner accuracy is easily controlled by the operator
- The dimensional errors of not only the corners, but also "circle" and "square" is improved

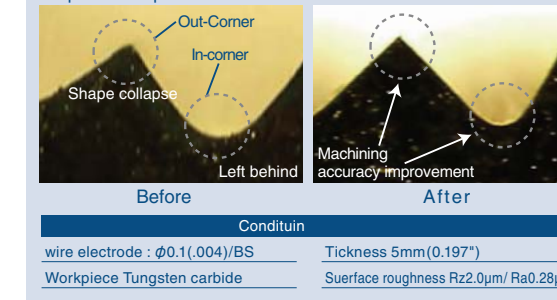

Machining surface step/straightness control (D-CUBES SL Control : Stepless control)

- The straightness deviation is reduced significantly in workpieces with variable thickness,
- A maximum step height of 300mm(11.8") is now possible by using the enhanced step profile conditions for large-size materials.
- High speed machining of stepped profiles is now possible.
- Best suited for machining materials with a large variation in workpiece thickness

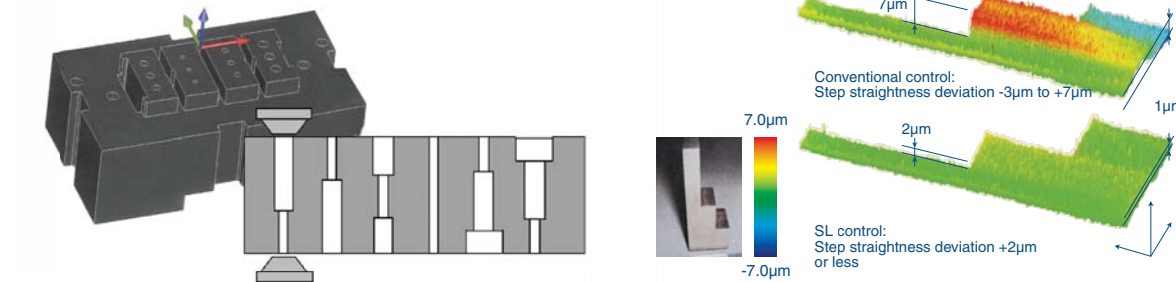

Productivity

Advanced Productivity



Table insulation(MV1200R/S, 2400R/S)

- Insulated worktable ensures improved surface finishing
- Stable machining realized when using short-pulse and low-voltage machining conditions

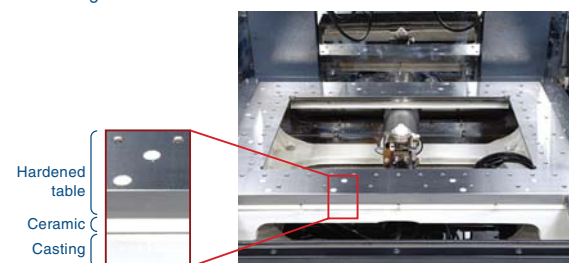

New jet stream flow mechanism

- Flow analysis simulation has been used to optimize the water flow mechanism for straightening the jet stream, which improves wire threading for thick workpieces

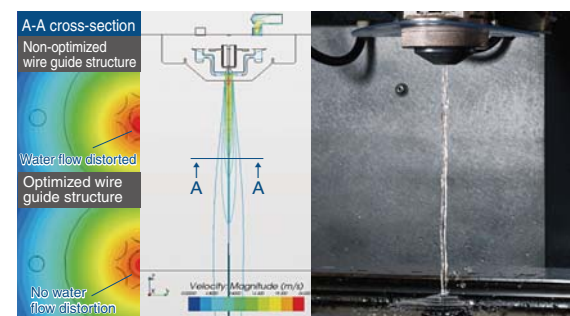

High-accuracy taper machining using round dies

- Highly accurate machining of extremely small tapered sections is now possible
- Uniform die edge land cuts are possible
- Angle Master Function realizes highly accurate machining of large tapered sections
- * Angle Master guide kit is optional
- * Max. taper angle is 45° (at max. 40mm)

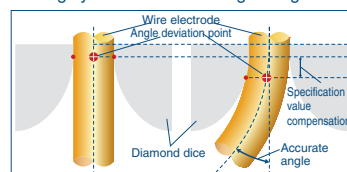

Pursuit of fine surface finish with standard power supply

New fine finish circuit (H-FS circuit)

Ra0.2 μm achieved without optional power supply (D-FS)

Workpiece: Steel/60mmt
Wire: φ0.20mm BS
Surface Finish: Ra0.20μm
Accuracy: ±0.003mm

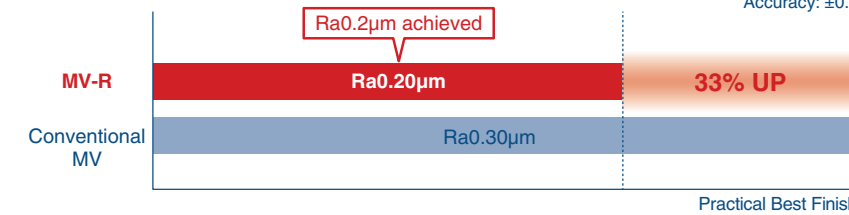

The finished surface roughness has been reduced by 50% with 2 cuts by using the new machining servo "D-CUBES NL Control"

Comparison of surface roughness with 2 cuts

Workpiece: Steel/60mmt
Electrode: φ0.30mm

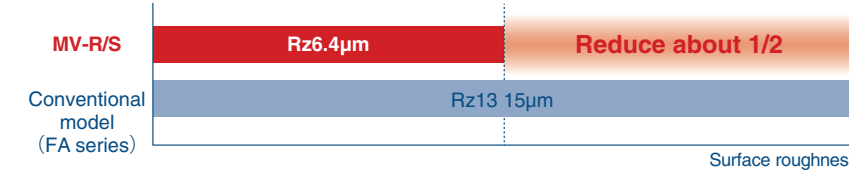

High-speed machining has been enhanced by newly improved power-supply performance for range of multiple cuts type jobs.

Machining time comparison for Rz3.5μm/Ra0.45μm with 3 cuts

Machining time comparison for Rz2.0μm/Ra0.28μm with 4 cuts

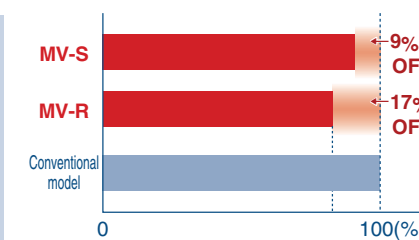
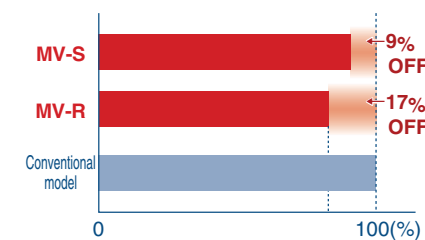

Workpiece: Steel,60mm Electrode: φ0.2/BS

Workpiece: Steel,60mm Electrode: φ0.2/BS

Compared to conventional Mitsubishi Electric Wire-cut EDM (FA Series), compared to the same machining amounts

High speed machining condition

Fastest rough machining in the industry *φ0.30mm wire

Steel/60mmt φ0.30mm Topas® plus D (Berkenhoff)

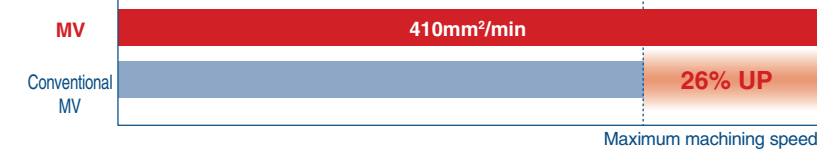

Increased finish machining productivity

This will differ according to country and region of sales; please contact a Mitsubishi Electric representative for details.

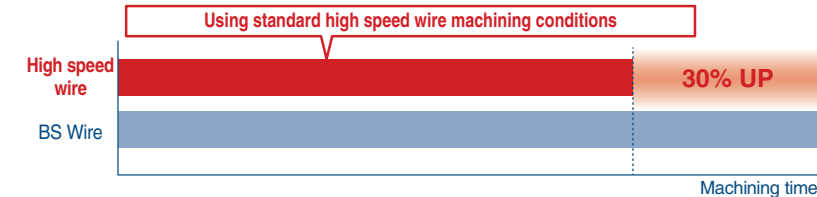

Workability / Operability

Control unit

- Information is displayed on a new large 19-inch touch screen
- Keyboard and mouse are standard
- Intuitive operation is performed by gestures from a multi-touch supporting panel

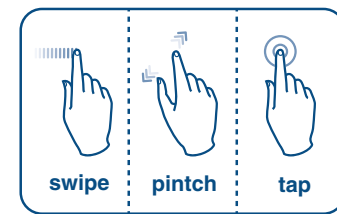

Screen tilt mechanism

- The new tilt mounting system allows adjust ability to fit operators of varying heights.

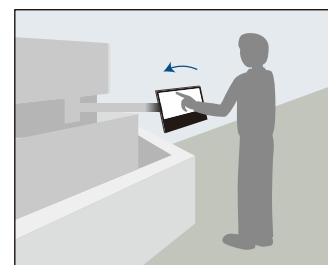
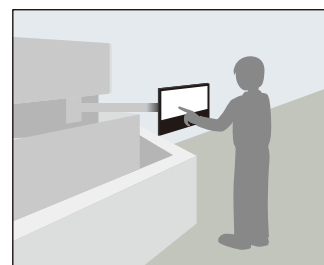

Thin liquid-crystal hand-held pendant box

- The new design of the thin liquid crystal manual pendant box improves workpiece setup and saves time.
- The hand-held operation box is equipped with an LED flash light mounted on the back.

PRG. POS.	POSIT.	ALARM
CONTACT	EDGE	
X	300.0000	100%
Y	-200.0000	G54
Z	-150.0000	
OVERRIDE 100%		
DOOR	BACK	

• Magnified view of coordinates

PRG. POS.	POSIT.	ALARM
CONTACT	EDGE	
X	300.0000	100%
Y	-200.0000	G54
Z	-150.0000	
SET UP	A T	Auxiliary Operation
Z LIMIT	POS. SELLECT	SET ZERO
	CENTER POS.	EDGE POS.
		MIDPT. POS.
DOOR	1/2	

• Various setup functions
• Screen customization

PRG. POS.	POSIT.	ALARM
CONTACT	EDGE	
X	300.0000	POS SELECT
Y	-200.0000	W00
Z	-150.0000	
SET ZERO	W00	
DOOR	BACK	

• Teaching function

Hardened table and all stainless steel structure

- Equipped with a hardened table
- The working tank and dielectric supply unit are made of stainless steel
- Resistant to deterioration by dielectric fluid and sludge

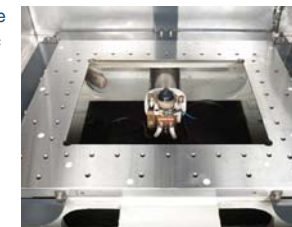

Wire alignment

- Highly accurate wire alignment is easy using the wire-alignment device (option)
- Taper parameter set-up is simple using the wire-alignment device



Cleaning mechanism <2400, 4800 type>

- A forced-flush self-cleaning mechanism prevents sludge from sticking to the stainless-steel seal plate

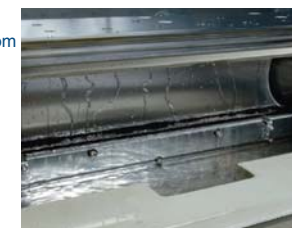

High-accuracy edge positioning

- Highly accurate workpiece edge positioning is possible with water flow on or when the workpiece is submerged.
- The edge positioning tolerance can be adjusted to match workpiece accuracy requirements.
- Wire electrode consumption is reduced by 70% during edge positioning. (wire must be 0.1mm or larger)



Wire travel system

- The stability of the wire tensioning system is improved by a felt wiper and felt keeper pads that eliminate the chance of the wire jumping off the rollers



Dielectric fluid flow meter and jet flow adjustment valve

- Dielectric flow meters are easy to read
- The adjustable jet flow valve increases the range of work that can be done



Filter pressure gauge and jet cleaning nozzle

- Easily read the filter pressure
- The convenient location of the jet cleaning nozzle makes tank clean-up easy



Broken wire collection box

- Conveniently located at the front for easy maintenance

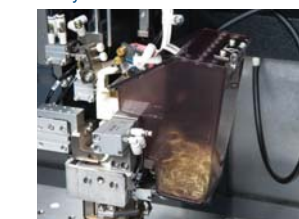

Chiller unit fill

- Conveniently located for easy cleaning



Operability



"Fast" and "Economical!" operation

Excellent performance with "Easy operation", "human error reduction" and "connect ability" supporting productivity improvement for customers.

Operation

Pre-machining preparation
Daily inspection and wire/workpiece mounting
Maintenance inspection tools

- The maintenance manual as well as maintenance history are supported
- Reduction in machine down time from insufficient maintenance

Workpiece setup
Reference positioning, Z parameter (Z1, Z2, Z5) setting
Z-axis limit setting

- The Z-axis limit can be set easily after mounting the workpiece
- Collisions caused by erroneous operations are prevented

Program
Simple creation of machining program
Standard shape library

- Simple standard shapes can be easily programmed by entering a few key dimensions into variables.

Consumables check

- The remaining amount of consumables is checked in accordance with the machining estimate
- It prevents a machine stop caused by insufficient consumables, such as an empty wire spool

Dry run
Programs can be checked for possible interference.
Override

- The dry run speed can be set at the pendant box to shorten the required run time.

Check list
All necessary operations to be performed before machining can be checked
Check list

- The pre machining checklist is displayed
- The machine cannot be started if any checklist item has been skipped
- Errors by operators who are not accustomed to using the machine are prevented

Monitoring machining
The start of machining and the machining status can be checked
Automatic setting of adaptive control

- Our EDM knowhow is used to optimize machining through automatic control settings.

Resuming machining

- A machining task that has been aborted by resetting the machine can be selected from the list and resumed

Initial setting

Once the processing machine has been started, the items that do not change during the daily operation are set
Calculation tool (vertical correction and taper function adjustment)

- Even calculations specific to the machine can be performed only by entering the measurement results, and do not require any manual calculations
- Reduces operator's labor and also errors by operation setting

Main menu

To enable the necessary information to be set and referred at the required time, aggregated on three screens.
This enables easy usage of information by anyone without being getting confused by operating procedures and operation methods.

History management

The operation history, inspection and maintenance history, consumables, and cost can be managed

- Consumables management**
- The consumables screen manages usage time and replacement history of all consumables

- Operating cost**
- The operating cost of the machine can be viewed on the cost management screen. This is useful for budget planning.

Energy Savings, Low Operating Cost



Consideration for the environment and cost reduction

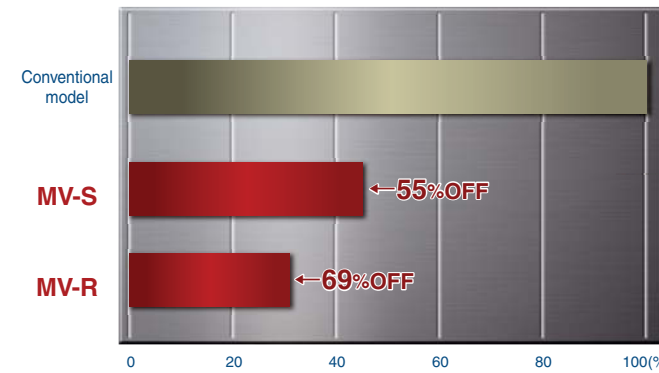

Power consumption reduced up to 69%

Power consumption reduced by ODS

Filter cost reduced up to 45%

Filter cost is reduced by changing the filtration flow rate between the rough cut and finishing processes

MV-R/S

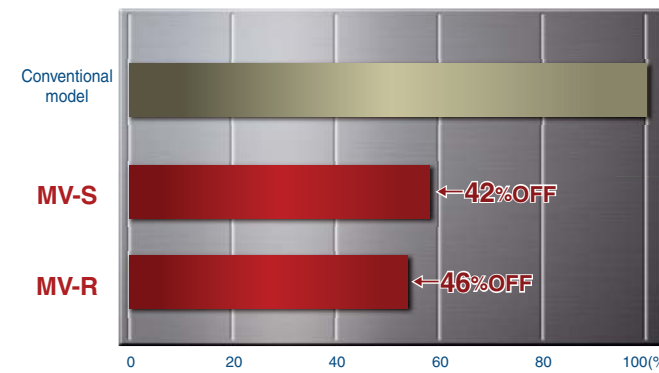
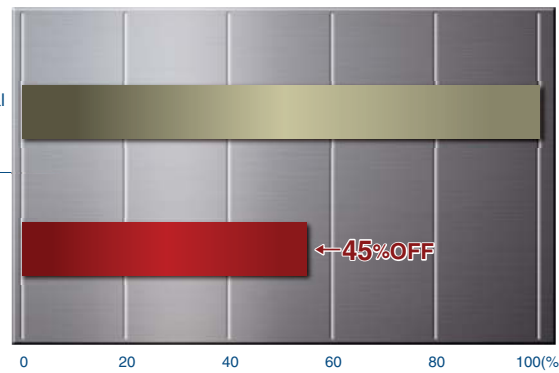

Wire consumption reduced up to 46%

Increased power-supply efficiency reduces the wear on the wire allowing the wire spooling rate to be reduced by PFC

Ion exchange resin cost reduced up to 25%

Enhanced power-supply conditions can be used with a lower fluid resistivity setting by PFC

MV-R/S

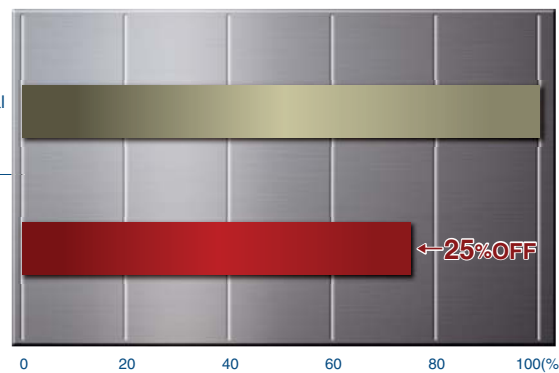

Compared to conventional Mitsubishi Electric Wire-cut EDM (FA Series), compared to the same machining amounts

New energy-saving mode (Sleep Mode)

- The new energy-saving mode can be scheduled according to the current job ending time and start time the next day
- In Sleep Mode, the amount of energy consumed is greatly reduced as the result of using an automated pump-shut-off system.
- Once the scheduled start time is reached, the system restarts the fluid system thermally, stabilizing the machine for work the next day.

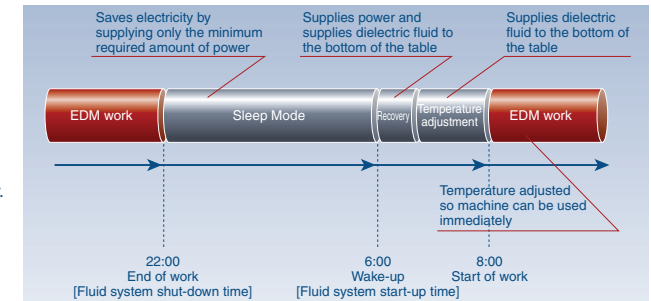

Operating cost

- Total operating cost reduced by up to 38%, which is accounted for filter, ion exchange resin and power consumption

Electrode material : $\phi 0.2/BS$
 Workpiece : SKD11, 160mm
 Surface roughness : Rz3.5 μm /Ra0.45 μm

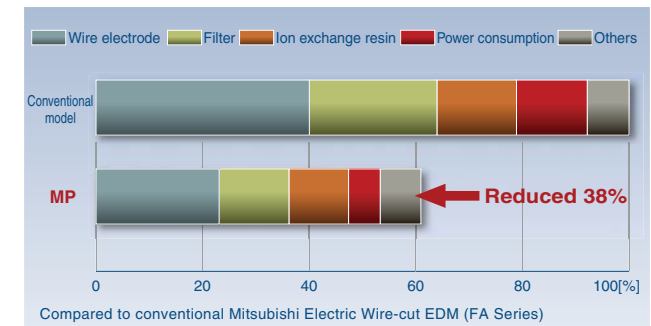

Flat power feed terminal

The flat shape makes it easy to index to the next location

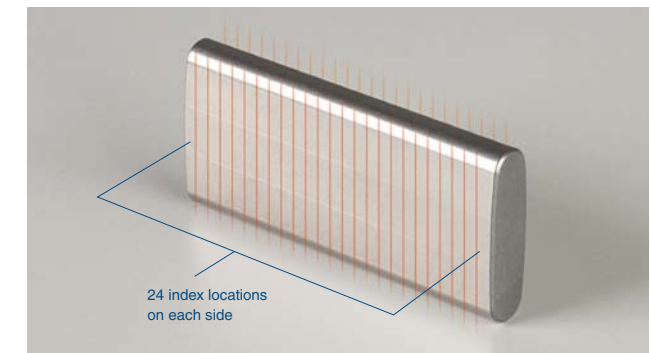

A total of 48 index locations can be used (24 on each side)

Main tension roller

Multiple indexing locations greatly reduce operating costs

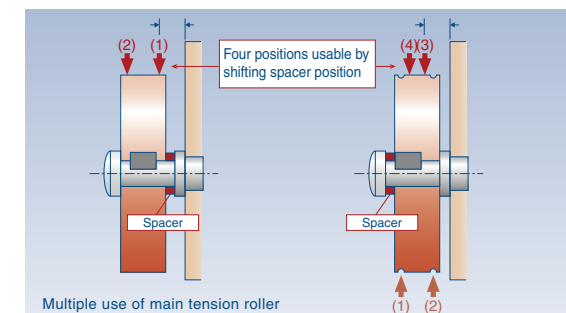

Large-diameter collection roller

Large collection roller with multiple index locations greatly reduces operating cost

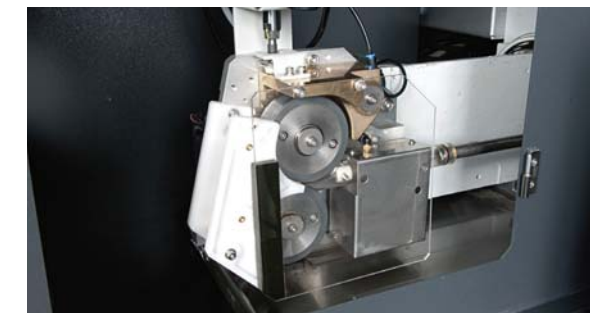

Revolution (MV-R)

Realizing high-value-added machining with a top ranking technology

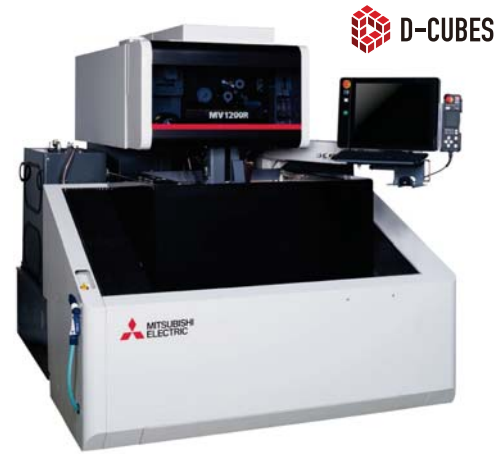

MV1200R



MV2400R

High-value-added functions are available on the MV1200R/2400R (option)

φ0.05, φ0.07 automatic wire threading



- φ0.05 wire electrode available
Minimum in-corner R 30μm
- Improved design reduces maintenance

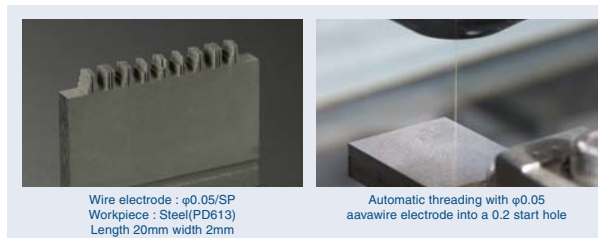

Digital-FS power supply



- Optimum surface roughness of Ra0.05μm/2μ"Ra(tungsten carbide)
- Optimum surface roughness of Ra0.12μm/5μ"Ra(steel)
- Machining with the workpiece set directly on the table (insulation jig not required)
- Machining range not limited (entire XY stroke area)

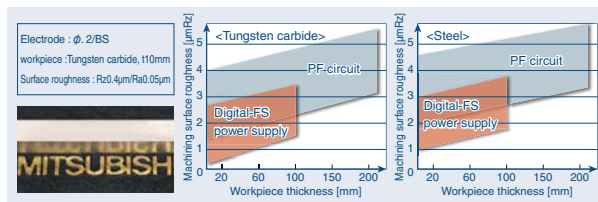

Angle Master ADVANCE II



- Taper accuracy of ±0.01° and dimensional accuracy of ±5μm are realized
- Taper angle accuracy is more consistent in all taper directions.

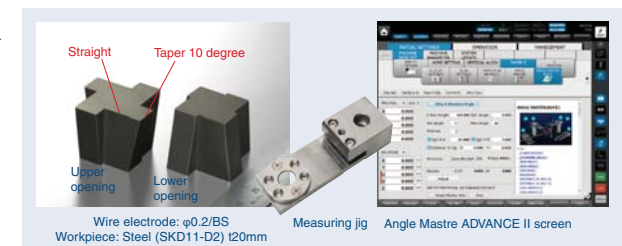

Consumables management



- Similar to periodic inspection, the consumables are also managed by the machine
- The replacement period is recorded so as to estimate the next date of replacement.



Operating cost



- The operating cost for each machine/job and the associated expenses for that period can be visualized.



Security improvement

- Anti-virus protection is provided as standard by one of the world leaders in security control
- Pattern file can be used semi-permanently without renewal



McAfee is a registered trademark of McAfee, Inc. in the United States and other countries © 2016 Intel Cooperation. All rights reserved.

Defends machines against the threat of computer viruses (LAN, USB)



Options



Advanced manual control box / Standard manual control box
The advanced manual control box has an LCD display, and can be used for positioning, zero set and AT operations

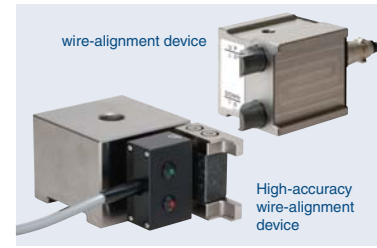

High-accuracy wire-alignment device / wire-alignment device
This device aligns the wire electrode with the table

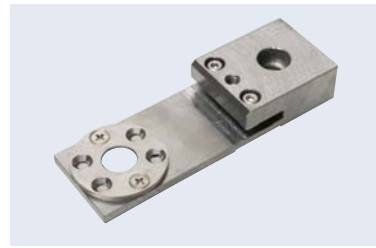

Angle Master ADVANCE II (jig)
Measuring jig to be used for Angle Master ADVANCE II (S/W)
Use for taper degree calculation in UV axis directions



Angle Master guide kit
Max. 45° tapered machining possible using dedicated diamond guide



20/25kg wire spool unit
Long-time continuous machining is possible



Wire processing unit
The wire is chopped after the collection roller



3-color warning light
Indicates machine operating status



4-piece filter system
4-piece filter specifications reduce filter replacement frequency

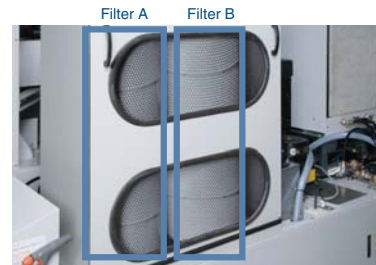

Filter automatic switching
Switching the filters to be used automatically according to the filter pressure.(4-piece filter specification is necessary)

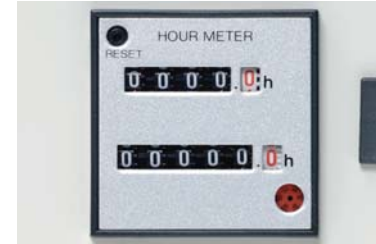

Run timer
Indicates accumulated machining time



LED light
High-brightness LED lighting



Workpiece clamp set
Clamp jigs dedicated for use in holding workpieces

Options and retrofit specifications differ according to country and region; please contact a Mitsubishi Electric representative for details.

○ : Standard equipment ○ : Can be retrofitted ● : Factory installation only × : Not available

Option name	D-CUBES		MV2400S	MV4800	MV4800
	MV-R	MV-S	column up specification		Z310specification
Machine unit	UV OPT-drive system specifications	○	×	×	×
	φ0.05, φ0.07 automatic wire threading ¹	●	×	×	×
	Wire processing unit ¹	○	○	○	○
	20/25kg wire spool unit	○	○	○	○
	50kg wire spool unit	×	×	×	○
	Thin liquid-crystal hand-held pendant box	○	○	×	×
	Advanced manual control box (with axis display) auxiliary table	×	×	○	○
Power supply	Digital-FS power supply	●	×	×	×
	H-FS power supply	○	×	×	×
Dielectric fluid system	Ion exchange resin 20L specifications (Organo)	○	○	○	○
	4-piece filter system	○	○	○	○
	Filter pressure sensor	○	●	×	×
	Filter automatic switching ⁷	●	●	×	×
Communications	External signal output	○	○ ³	○ ³	○ ³
	LAN/W ⁴	○	○	○	○
	DNC	○	○	○	○
	FTP(S/W)	○	○	○	○
Taper Machining	Operation status data output function	○	○	○	○
	Angle Master guide kit φ0.2 (±30°) ⁵	○	○	○	○
	Angle Master guide kit φ0.2 (±45°) ⁵	○	○	○	○
	Angle Master guide kit φ0.25 (±30°) ⁵	○	○	○	○
	Angle Master guide kit φ0.25 (±45°) ⁵	○	○	○	○
	Angle Master (S/W) ⁵	○	○	○	○
	Angle Master ADVANCE (S/W) ²	○	×	×	×
Software	Angle Master ADVANCE (measuring jig) ²	○	×	×	×
	Anti-virus protection	○	○	○	○
	Sleep mode	○	○	×	○
	COREHOLD	○	×	×	×
Display	3D Data import (Parasolid)	○	○	○	○
	LED light	○	○	○	○
	3-color warning light ³	○	○ ³	○ ³	○ ³
	Run timer ³	○	○	○	○
Others	Optionbox ⁶	○	○	○	○
	Mannual (Booklet)	○	○	○	○
	High-accuracy wire-alignment device	○	○	○	○
	Workpiece clamp set	○	○	○	○

¹ The φ0.05 to φ0.15 wire electrodes cannot be used with the wire processing unit. (These sizes can be used with the continuous wire feeder after removing the wire processing unit.)

² Angle Master ADVANCE (measuring jig) is needed for using Angle Master ADVANCE (S/W).

³ Option box is needed

⁴ LAN cable should be all straight wiring type with shielding connector, category 5 (100BASE-TX compliant), STP (four shielded twist pair). A switchable hub that can ground the shielded LAN cable should be used.

⁵ Standard diamond guide and nozzle (φ7) is used for taper machining of 15 degrees or less. Angle Master guide kit (H/W) is needed for taper machining of 15 degrees or more

⁶ Necessary for mounting external signal output, 3-color warning light and run timer.

⁷ Equipped with four filters.

Wire-cut EDM automation system

- Accumulates workpiece measurement data
 - Compatible for external set-up using a coordinate measuring machine
 - Enables automatic measurement when measuring on an EDM
- Creates processes offline
- Automatically exchanges workpieces using a robot

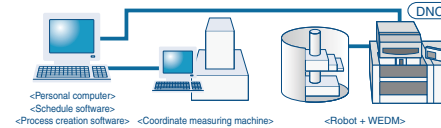

* Please contact a Mitsubishi Electric representative for details.

Network connection specifications (DNC, FTP)

Data, such as NC programs, machining conditions and variables can be exchanged between a personal computer and EDM. The required options differ according to the models and purpose, and can be confirmed using the following table. One IP address must be prepared for each EDM within the user's in-house network.

Required specifications	Image drawing	Required option	Supplement
Operate on the EDM side and receive data from personal computer.		LAN/W (standard)	Use EDM's Explorer and receive data in the common HDD on the EDM side. After that, data I/O operations are required.
Operate on the EDM side and send data directly to the EDM's NC data area.		FTP	Data can be received only using data I/O operation.
Operate on the personal computer side and send data to the EDM.		LAN/W (standard)	The personal computer's Explorer and the EDM's common HDD are used. After that, data I/O operations are required for the EDM.
Operate on the personal computer side and send data directly to the EDM's NC data area.		DNC	Commercially available DNC software must be installed on the personal computer side. Refer to DNC specifications operation for details.
Automatically send data from machining machine to FTP server		Operating status Output data	Customer should prepare FTP server

Power Supply, Control Specifications/Machine Installation

Power supply/Control unit specifications

Compatible model		MV-R	MV-S	MV2400S column up specification	MV4800	MV4800 Z310specification
Power supply unit specifications						
Power supply unit	Model	WMV(R)	WMV(S)	WMV(S)	WMV48(S)	WMV48(S)
	Power supply circuit	Regenerative transistor pulse type				
	Cooling method	Completely sealed/Indirect cooling				
	Anti-electrolytic power supply	All modes				
	Maximum output current	50A				
	Power supply mode	10 types : Anti-electrolysis power supply				
	Machine voltage selection	16 types				
	Machining setting	44 types				
	OFF time	36 types				
	Stabilization circuit A	10 types				
	Stabilization circuit B	20 types				
	Stabilization circuit C	7 types				
	Stabilization circuit E	5 types				
	FM circuit (LA, LC)	2 types				
	PM control	3 notches (changeable with M code or screen) Workpiece material: Steel, tungsten carbide, copper, aluminum Applicable only for rough-cut conditions				
	AVR	Built-in				
	Unit dimensions (mm)	600x600x1765				
Unit weight (kg)	220					
Control unit specifications						
Control unit	Model	W41MV-2 R	W41MV-2 S	W31MV-2 S	W31MV-2 S	W31MV-2 S
	NC program input method	Keyboard, USB flash memory, Ethernet				
	Pointing device	Touch panel, mouse				
	Display	19"color TFT		15"color TFT		
	Display characters	Alphanumeric characters				
	Control method	CNC closed loop				
	Number of control axes	Max. 4 axes simultaneously				
	Setting unit	X, Y, U, V, Z ... 1/0.1μm				
	Minimum driving unit (mm)	10nm		50nm		
	Max. command value	±99999.999mm				
	Position command format	Combined use of increment/absolute values				
	Interpolation function	Linear, circular, and spiral				
	Scale magnification	0.0001 ~ 99.99999 (G code)		0.001 ~ 9999.999 (S code)		
	Optimum feed control	Automatic selection of machining speed according to gap voltage sensing				
	Path-retrace control	Reverse path retrace during short-circuit				
	Z axis limit setting	Z axis limit setting		-		
	Wire offset	±99999.999mm Offset numbers: 1 to 900 (intersection point calculation)				
	Basic screen menu	3 types (Initial setting, operation, history management)		5 types (file, setup, machining support, monitor, maintenance)		
	Simple shape	28 shapes (Plotting not required)				
	Calculation tool	Wire alignment and taper specification adjustment				
	Check tool	Daily/periodic inspection, consumables check list				
	Manual input positioning	Input on screen				
	Manual operation box	High-speed, medium-speed, low-speed, ultra-slow speed, inching (0.0001mm/0.0005mm/0.0001mm) Positioning function, AT function				
		Touch panel screen operation, override function, teaching		Inching (0.005mm/0.001mm/0.0001mm)		
	Graphics	XY plane, XY-XZ plane, solid, table scaling, 3D model display, background drawing, automatic machining path drawing				
User memory capacity	Gestures, graphic link		-			
Maintenance function	Management of consumable parts (time display)					
Adaptive control	CM, EM, PM, BM, SL		CM, EM, PM, OM, BM, SL			
External dimensions (mm)	518x97x363		494 × 175 × 346 (excluding keyboard and mouse pad)			
Weight (kg)	15		20			

Machine installation checklist

Determining the machining details

Check each item, and make sure that no item or order is overlooked.

- Determine the workpiece
- Determine the machining site
- Determine the pre-processing site
- Determine the post-processing site

Preparation of installation fixtures

- Plan the installation fixtures
- Prepare or manufacture the fixtures

Preparation of consumable parts

- Purchase consumable parts such as wire electrodes

Training of programmers and operators

- Select the programmers and operators
- Apply for training seminars

Confirmation of foundation and power-supply work

If there is any possibility of radio disturbance, investigate it prior to starting work.

- Confirmation of floor area
- Confirmation of environment (constant-temperature dust-proof room, measure for radio disturbance, prevention of external noise)
- Confirmation of foundation floor
- Foundation work
- Primary wiring for power lead-in
- Grounding work
- Construction of dielectric fluid (city water) supply/drainage facilities
- Air piping work

Confirmation of delivery path

Check the path inside and outside the factory to avoid any trouble during delivery.

- Traffic restrictions to factory
- Road width
- Entry road
- Factory entrance and width of gate in factory (m)
- Factory building entrance dimensions (height x width) (m)
- Constant-temperature dust-proof room entrance dimensions (height x width) (m)

Cautions

The standard delivery entrance dimensions for standard shipment delivery are given on the product line-up page. If the entrance is smaller than the standard delivery entrance, a machine with different dimensions can be shipped. * Please contact a Mitsubishi Electric representative for details (a separate estimate will be issued). Note that delivery may not be possible in some cases depending on the dimensions.

Installation conditions

1. Installation site

- Constant-temperature dust-proof room
 - Recommended room temperature 20±1°C
 - Usable temperature range 5 to 35°C
 - Temperature fluctuation will directly affect machine accuracy. To maintain performance accuracy, select a place with minimal temperature fluctuation.
- Install the EDM in a constant-temperature room when performing high precision machining, even when using skim cuts. Note that an environment where the temperature fluctuates by 3°C or more within 24 hours, or 1°C or more within one hour can adversely affect machining accuracy. Make sure that the machine body is not subject to direct wind from air-conditioners or to direct sunlight.
- Dust-free location is recommended. Install a wire-cut EDM in an environment with no corrosive gases, such as acid or salt, or mist, and with low levels of dust. Grinding dust can adversely affect the machine's linear scales and ball screws. Pay special attention to installation location to avoid this hazard (separate from grinding machine, or install in separate room, etc.).
- Humidity Within 30 to 75%RH (with no dew condensation).
- Temperature range during transportation and storage -25 to 55°C (when power is not connected).

- Tolerable vibration of floor
 - Select a floor where vibration or impact will not be conveyed.
 - As a reference, the vibration level should have a max. amplitude of 2μm or less at a 10 to 20Hz frequency.
 - Consult with the contractor or vibration measuring instrument manufacturer for details on the measuring method.

③ Foundation

- The floor should be concrete with a thickness of 400mm or more so it can sufficiently withstand the system's weight.
- The floor inclination (step) must be within 6/1000 (floor inclination 6mm per 1m) (MP2400 Series).

2. Machining heating value

Use the equipment capacity to calculate the wire-cut EDM's heating value required for designing a constant-temperature room.

$$\begin{aligned} \text{Heating value (kW)} &= \text{Equipment capacity (kVA)} \times 0.6 \\ &= 13.5\text{kVA} \times 0.6 \\ &= 8.1\text{kW} \end{aligned}$$

The above value is a guideline. Consult with the constant-temperature room manufacturer for details.

3. Power-supply equipment

- Primary wiring 3-phase 200/220VAC±10% 60Hz, 3-phase 200VAC±10% 50Hz
- Power capacity 10.0kVA (during normal use) (when using φ0.2mm wire electrode) 13.5kVA (when using the maximum)
- * Use a 14mm² or thicker cable for the primary connection.

4. Grounding work

- Wire-cut EDMs must always be grounded to prevent external noise, radio disturbance and earth leakage. Install a wire-cut EDM in an environment with no corrosive gases, such as acid or salt, or mist, and with low levels of dust.
- Common grounding can be used if noise from other devices will not enter through the common grounding; the grounding cable must be connected independently to the grounding location (Fig. 2).
- Use a 14mm² grounding wire.

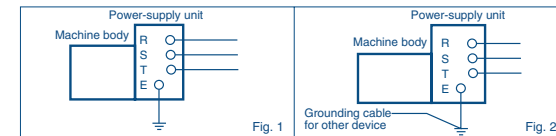

Fig. 1

Fig. 2

5. Primary air equipment

- Hose diameter : 1/4 hose (hose sleeve outer diameter: φ9.0)
- Pressure : 0.5 to 0.7MPa
- Flow rate : 75 ℓ /min or more
- Air (compressed air) is used to operate the automatic wire feeder and work tank door, etc. Air supplied from a normal compressor contains various impurities that could cause operation faults if they get into the pneumatic devices such as the solenoid valve. Install an air filter with a drainage discharge mechanism, etc., in the air source (primary source) piping to prevent impurities from entering the pneumatic devices.

6. Shield room

- Install a shield room if a wire-cut EDM affects televisions or other communication facilities in the area. Observe the following points when installing the wire-cut EDM in the shield room.
- Ground the wire-cut EDM in the shield room (Fig. 3).
- If the wire-cut EDM cannot be grounded in the shield room, connect the wire-cut EDM's grounding cable to the shield room's grounding terminal (through bolt) as shown in Fig. 4.
- Consult with a Mitsubishi Electric representative for details on installing a shield room.

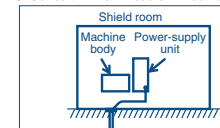

Fig. 3

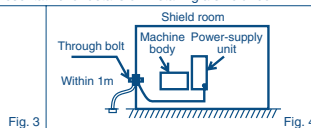

Fig. 4

Precautions for selecting earth-leakage breaker

To prevent malfunctions caused by the external noise from control units, etc., a filter is installed for the power-supply input. By grounding one end of this filter, an earth-leakage current of approx. 30 to 40mA passes through the filter. A highly sensitive earth-leakage breaker (sensitivity current 30mA) could malfunction. Thus, a medium-sensitivity earth-leakage breaker (sensitivity current 100 to 200mA) is recommended for the wire-cut EDM. Class C grounding (grounding resistance of 10Ω or less) is recommended for the wire-cut EDM. Even if the sensitivity current is 200mA, the contact voltage will be 2V or less, and no problems will occur in preventing electric shock (application of tolerable contact current Class 2, 25V or less).

Refrigerant for dielectric fluid chiller

The dielectric fluid chiller unit includes a fluorinated greenhouse gas R410A. Please use only the specified refrigerant (R410A), when servicing the dielectric fluid chiller unit. The use of any refrigerant other than that specified will cause mechanical failure, system malfunction or unit breakdown. In the worst case, this could lead to a serious impediment to securing product safety.

Disposal

The dielectric fluid, dielectric fluid filter, ion exchange resin, wire, etc., are industrial waste. These must be disposed of following national and local laws and ordinances.

Harmonic distortion

If there is harmonic distortion in the power supply, the machine operation could be affected even if the voltage does not fluctuate. In addition, the harmonic current could flow from the wire-cut EDM to the power system and adversely affect peripheral devices. If the effect of the harmonic distortion causes problems, install a harmonic suppression filter or take other measures.

Wire electrodes

Use the following wire electrodes

Wire electrode	Manufacturer
OB-PN (φ0.1/BS - φ0.3/BS)	Oki Electric Cable
HBZ-U(N) (φ0.1/BS - φ0.3/BS)	Hitachi Metals
SBS-HN (φ0.1/BS - φ0.3/BS)	Sumiden Fine Conductors
SWP-SP (φ0.05/SP - φ0.07/SP)	Nippon Steel & Sumikin Wire

*The wire electrodes shown above do not guarantee performance

Recommended sliding surface lubricants

Use one of the following lubricants for sliding surface As of June 2016

Manufacturer	Product name
Exxon Mobil	Mobil DTE26
Idemitsu Kosan	Super Hydro 68A
Showa Shell	Terrace Oil 68
JX Nippon Oil & Energy Corporation	Super Mulpas DX68

Terms of warranty

1. Terms of warranty

This will differ according to country and region of sale; please contact a Mitsubishi Electric representative for details.

2. Coverage

- (1) Terms of repairment free of charge
 - Parts labor and travel are included free of charge when the failure occurs during normal use for the stated Terms of the warranty (based on proper usage and maintenance as described in the operations manual and sales agreement).
 - Coverage exceptions:
 - When a failure occurs that was caused by a machine modification that directly affects the machine's functioning or accuracy.
 - When a failure occurs caused by the use of non-standard parts, consumables or lubricants.
 - When a failure occurs caused by a natural disaster such as lightning, earthquake or storms and flooding.
 - When the use of non-recommended consumables or aftermarket parts are used such as filters or flushing nozzles.
 - (2) Exclusion of loss in opportunity and secondary loss from warranty liability
 - Regardless of the gratis warranty term, Mitsubishi shall not be liable for compensation to:
 - ① Damages caused by any cause found not to be the responsibility of Mitsubishi.
 - ② Loss in opportunity, lost profits incurred to the user by Failures of Mitsubishi products.
 - ③ Special damages and secondary damages whether foreseeable or not, compensation for accidents, and compensation for damages to products other than Mitsubishi products.
 - ④ Replacement by the user, maintenance of on-site equipment, start-up test run and other tasks.

3. Post Warranty / Expected Service Life

After the warranty period expires, all standard service rates and travel expenses will apply. Normal service life expectancy is 11 years after installation, but there may be some cases where discontinued electrical parts such as semiconductors and motors will reduce this period.

