

Notes on Ezekiel

2014 Edition

Dr. Thomas L. Constable

Introduction

TITLE AND WRITER

The title of this book comes from its writer, Ezekiel, the son of Buzi (1:3). "Ezekiel" means "God strengthens (or hardens)" or "God will strengthen (harden)" or "May God strengthen (harden)." The name "Hezekiah" is similar, meaning "May Yahweh strengthen."

"It expresses the prayerful wish of his parents that God would care for the newborn child by endowing him with strength, so that he could face life's vicissitudes with confidence."¹

The Lord strengthened Ezekiel in the face of cynicism and rejection by his fellow Jews. His name appears in only two verses (1:3; 24:24). His hometown is unknown, and no other biblical writer referred to him.

Ezekiel was a Judean priest of Yahweh as well as His prophet, as were Jeremiah (Jer. 1:1), Zechariah (Zech. 1:1), and John the Baptist (Luke 1:5). Ezekiel, Jeremiah, and Zechariah were the only writing prophets who were also priests, and they all ministered during or after the Babylonian exile. Like Jeremiah, there is no evidence that Ezekiel ever served as a priest in the Jerusalem temple. Ezekiel's priestly background may account in part for the interest in priestly things that his book reflects: the actions of the priests in Jerusalem, the Jerusalem temple, the glory of the Lord, and the future temple yet to be built. It probably also explains Ezekiel's familiarity with things connected with priestly ministry, such as cherubim. His wife died during the course of his ministry (24:2, 15-18), but there is no mention in the book that they had children. There are no records of Ezekiel's life outside this book, so we have no information about when, where, or how he died.²

". . . he combined in a unique way the priest's sense of the holiness of God, the prophet's sense of the message that had been entrusted to him, and the pastor's sense of responsibility for his people."³

¹Leslie C. Allen, *Ezekiel 1—19*, p. 23. See also J. D. Fowler, *The Theophoric Divine Names in Hebrew*, pp. 98, 100.

²For a sketch of Ezekiel the man, see Leon J. Wood, *The Prophets of Israel*, pp. 358-60.

³John B. Taylor, *Ezekiel: An Introduction and Commentary*, p. 29.

Until the second quarter of the twentieth century almost all biblical scholars viewed the entire book as the product of Ezekiel. In 1930, C. C. Torrey advanced the view that a fictitious pseudo-author wrote the book around 230 B.C.⁴ This view drew a few supporters, but by 1962 almost all scholars had abandoned it.⁵ Today most commentators view Ezekiel as the source of the prophecies in this book.⁶

DATE

The book records the date of the beginning of Ezekiel's ministry as 593 B.C. (1:2-3). The last dated prophecy came to the prophet in 571 B.C. (29:17). He began ministering when he was 30 years old (1:1), and he gave his last prophecy when he was about 52. Ezekiel's whole ministry transpired during the reign of King Nebuchadnezzar of Babylon (605-562 B.C.).

"One of the most complete chronological systems in any book of the Old Testament is found in this prophecy, demonstrating that Ezekiel's ministry covered at least the span of 593 to 571 B.C."⁷

HISTORICAL BACKGROUND

Since Ezekiel began ministering in 593 B.C., when he was 30 years old, he would have been born about 623 B.C. and would have grown up in Judah during King Josiah's reforms (622-609 B.C.). The date of Jeremiah's birth was about 643 B.C., 20 years before Ezekiel's. Jeremiah began ministering in Judah about 627 B.C., so Ezekiel would have been familiar with him and his preaching.⁸ There are some indications in this book that he was, though Ezekiel never referred to Jeremiah.

"Both of them seemed to be taking a lone stand for the truth, one in Jerusalem and the other in Babylon: they both insisted that the future of Israel lay with the exiles and not with those left behind in Jerusalem; they both rejected the fatalism of those who quoted the proverb about the fathers eating sour grapes and the children's teeth being set on edge; they both inveighed against the shepherds of Israel who failed to care for the flock; they both emphasized the principle of individual retribution and the need for individual repentance; they both looked forward to a lengthy exile, followed by a restoration under godly leadership; they both spoke in terms of a new covenant which would be inwardly and personally

⁴C. C. Torrey, *Pseudo-Ezekiel and the Original Prophecy*, p. 99.

⁵See *The New Bible Dictionary*, 1962 ed., s.v. "Ezekiel, Book of," by H. L. Ellison. For arguments defending Ezekiel's authorship, see R. K. Harrison, *Introduction to the Old Testament*, pp. 823-32; Gleason L. Archer Jr., *A Survey of Old Testament Introduction*, pp. 368-76; Ralph H. Alexander, "Ezekiel," in *Isaiah-Ezekiel*, vol. 6 of *The Expositor's Bible Commentary*, pp. 739-40; L. E. Cooper Sr., *Ezekiel*, pp. 31-32; and Taylor, pp. 14-17.

⁶See Tremper Longman III and Raymond B. Dillard, *An Introduction to the Old Testament*, pp. 358-62, for discussion of the history of criticism.

⁷Ralph H. Alexander, *Ezekiel*, p. 5.

⁸See the historical background section in the Introduction to my notes on Jeremiah for further information about this period.

appropriated; and they both spoke against the false prophets who prophesied peace when there was no peace."⁹

Daniel went into captivity in 605 B.C. and was only a teenager then, so his birth year may have been close to 620 B.C. Ezekiel, then, may have been only a few years older than Daniel. Daniel's ministry continued for about 70 years until about 536 B.C. (Dan. 10:1), much longer, apparently, than Ezekiel's.

Jeremiah	<u>early life</u>		<u>ministry</u>		
	b. ca. 643	627			560 ? d. ?
Ezekiel		<u>early life</u>		<u>ministry</u>	
	b. 623	593	571		d. ?
Daniel	<u>early life</u>		<u>ministry</u>		
	b. ca. 620	605			536 d. ?

Ezekiel went to Babylon as a captive during Nebuchadnezzar's second deportation of Jerusalemites in 597 B.C. along with King Jehoiachin, his household, his officials, and many of the leading men of Judah (2 Kings 24:12-17). Ten thousand captives went to Babylon then with much confiscated treasure from the temple and the royal palaces. Nebuchadnezzar also took most of the craftsmen and smiths to Babylon, and only the poorest of the people remained in the land. The Babylonian king set Zedekiah up as his puppet in Jerusalem, but Jehoiachin remained the recognized king of Judah in Babylon.¹⁰

Ezekiel ministered "in the midst" of the Jewish exiles who had settled at Tel-abib (or Tel Aviv) beside the Chebar (or Kebar) River (3:15). One of Ezekiel's favorite words was *betok*, "among" or "in the midst." He used it 116 times, more than all the other Old Testament books combined. It reveals the prophet's perspective of himself as someone living in the midst of a people with a ministry that would impact history for generations to come. The Chebar River was the "grand canal" (Aram. *naru kabaru*) that began at the Euphrates River north of Babylon, bypassed the city to the east, proceeded through the site of Nippur, and rejoined the Euphrates south of Babylon near Uruk (biblical Erech). This site is where most of the Jewish exiles in Babylonia lived. Jews lived in three principle locations during Ezekiel's ministry: Egypt, Judah, and Babylon. Ezekiel evidently ministered among the Chebar community entirely; there is no evidence that he ever visited Jerusalem after the Babylonians took him captive.

⁹Taylor, p. 35.

¹⁰See James B. Pritchard, ed., *Ancient Near Eastern Texts*, p. 308.

Life among the Jewish exiles was not a physically difficult existence, certainly not like living in a concentration camp. The exiles enjoyed considerable freedom and even traveled within Babylonia (cf. 33:21; Jer. 29). They were able to own their own homes, to pursue their own businesses and personal interests, and to organize their own communities. Babylon was infamous for its luxurious wealth and its excessive idolatry. Life became so comfortable in Babylon that after Cyrus allowed the Jews to return to their homeland in 538 B.C. most of them chose to remain where they were.¹¹

AUDIENCE AND PURPOSE

Ezekiel ministered to the Jews in exile. He probably wrote this book for the benefit of the exiles and the other Jewish communities of his day and beyond his day. In some of his visions (e.g. chs. 8 and 11) the Lord carried the prophet to Jerusalem in his spirit, but his messages were not exclusively for the Jews in Jerusalem.

"Ezekiel ministered to all twelve tribes and his purpose was twofold: (1) to remind them of the sins which had brought judgment and exile upon them; (2) to encourage and strengthen their faith by prophecies of future restoration and glory."¹²

The Jews were in exile because they had proved unfaithful to the Mosaic Covenant that their God had made with them. That covenant had warned the Israelites that if they proved unfaithful they could expect the divine discipline of their sovereign Lord who might even drive them from the land He had given them (Lev. 26; Deut. 28). The covenant also promised restoration to the land eventually. God would not cast His people off permanently no matter how far they departed from Him and His will.

". . . his aim is to convince the people of their utter unworthiness of any consideration from God, in order to shame them into true repentance."¹³

Ezekiel reminded the exiles of their covenant unfaithfulness and of the faithfulness, holiness, and glory of Yahweh, their God. The Lord would judge, cleanse, and ultimately bless His people so that they and all people might come to appreciate His uniqueness and greatness. The purpose of the Exile was to turn God's people away from their sins and back to their Sovereign. The discipline they experienced was an evidence of God's love. When it was over, a glorious future lay in store for them. A righteous ruler would eventually lead them back to a radically renovated land where they would enjoy peace, prosperity, and renewed worship.

"Ezekiel, as a watchman for Israel, warned her of the judgment that was imminent and stressed the need for individual responsibility as well as national accountability before God. Each Israelite was personally to turn to the Lord. Likewise, the whole nation must ultimately return to him."¹⁴

¹¹For further discussion of Babylonian conditions during the exile, see Peter R. Ackroyd, *Exile and Restoration*, pp. 31-38.

¹²Charles Lee Feinberg, *The Prophecy of Ezekiel: The Glory of the Lord*, p. 13.

¹³Taylor, p. 42.

¹⁴Alexander, "Ezekiel," p. 744.

The first part of Ezekiel's ministry consisted of predicting the fall of Jerusalem from Babylon (chs. 1—24). When it fell in 586 B.C., he then began predicting God's judgment on the Gentile nations (chs. 25—32) and the restoration of Israel (chs. 33—48).

"The author's purpose throughout the entire prophecy was to keep before the exiles the sins of the nation which were the grounds for her punishment, and to sustain and encourage the faithful remnant concerning future restoration and blessing (cf. 14:21-23)."¹⁵

STRUCTURE

There are two major structural peculiarities that set Ezekiel off as distinctive.

First, the book is a collection of prophecies arranged in almost consistent chronological order. No other prophetic book is as consistently chronological as Ezekiel, except Habakkuk and Haggai, and Zechariah comes close. Jonah is also chronological, but it is more a book of history than a collection of prophecies. Furthermore, Ezekiel dated his oracles with unusual precision: usually by year, month, and day of the month. The post-exilic prophets Zechariah (1:7; 7:1) and Haggai (1:1, 15; 2:1, 10, 20) also demonstrated this precision, perhaps following Ezekiel's lead. He may have done this to stress the certainty of the predictions so that when they came to pass there would be no question as to their authenticity. A chart of the prophecies and their dates follows.

EZEKIEL'S DATED PROPHECIES			
Groups of Dated Messages	Passages	Ezekiel's Calendar Month/Day/Year	Modern Calendar Month/Day/Year
First	1:1—3:15	4/5/5	July 31, 593
Second	3:16—7:27	4/12/5	Aug. 7, 593
Third	8:1—19:14	6/5/6	Sept. 17, 592
Fourth	20:1—23:49	5/10/7	Aug. 14, 591
Fifth	24:1—25:17	10/10/9	Jan. 15, 588
Sixth	26:1—28:26	?/1/11	? 1, 587 or 586
Seventh	29:1-16	10/12/10	Jan. 5, 587
Eighth	29:17—30:19	1/1/27	Apr. 26, 571
Ninth	30:20-26	1/7/11	Apr. 29, 587
Tenth	31:1-18	3/1/11	June 21, 587
Eleventh	32:1-16	12/1/12	Mar. 3, 585
Twelfth	32:17—33:20	?/15/12	? (Mar.) 17, 585
Thirteenth	33:21—39:29	10/5/12	Jan. 9, 585
Fourteenth	40:1—48:35	1/10/25	Apr. 28 (or Oct. 22), 573

¹⁵Hobart E. Freeman, *An Introduction to the Old Testament Prophets*, p. 297.

In the table above, the prophecies are in the order in which they appear in the text. For the most part, this is also the chronological order in which Ezekiel delivered them.¹⁶ However, you will note that the seventh and eighth groups of messages (beginning with 29:1 and 17) are not in chronological order. These messages are grouped topically with other prophecies against Egypt in chapters 29—32. Ezekiel's calendar, in the table, dates from the year of King Jehoiachin's (and Ezekiel's) exile (i.e., 598 B.C.; cf. 1:2). Scholars vary somewhat in their understanding of the modern equivalents of these dates.¹⁷

A second structural characteristic of the book is that it is logically organized as well as chronologically organized. First we read the call and preparation of the prophet (chs. 1—3). Then come prophecies announcing God's judgment on Judah culminating in the fall of Jerusalem (chs. 4—24). Next we find prophecies against foreign nations that opposed Israel (chs. 25—32). A section of prophecies on the coming restoration of Israel concludes the book (chs. 33-48).

"Apart from these obvious major divisions, this book is one of the easiest in the entire canon to outline, thanks to the clear demarcation of individual oracles. The book consists of fifty literary units, forty-eight of which are introduced either by a date notice or the word-event (also called prophetic word) formula, 'The word of Yahweh came to me saying.'"¹⁸

The exceptions are 19:1-14 and 37:1-14, but other literary signs identify them as distinct units. Ezekiel saw God's glory departing from the temple in judgment (9:3; 10:4, 18-19; 11:22-25), and then he saw it returning to the temple for blessing (43:1-5). These major events tie the book together. Ezekiel initially received a commission to deliver messages of judgment (chs. 2—3), but later he received another commission to deliver messages of deliverance (ch. 33). These two commissions identify the two major parts of the book that had particular relevance to Israel.

STYLE

One stylistic characteristic is Ezekiel's autobiographical perspective. Almost all of his oracles (except 1:2-3; 24:24) appear in the first person giving the impression that they are memoirs of a true prophet of Yahweh. However, Ezekiel did not share his personal struggles or reactions with the reader as often as Jeremiah did (except 4:14; 9:8; 11:13; 20:49; 24:20; 37:3).

"There are only two voices in Ezekiel's book, the prophet's and God's. Those who consult and oppose Yahweh and Ezekiel never speak. The words of the latter are doubly framed; Ezekiel quotes Yahweh quoting them in refutation."¹⁹

¹⁶See also the table of chronological notes in Ezekiel in Longman and Dillard, p. 357.

¹⁷The recognized authority on these dates is Richard A. Parker and Waldo H. Dubberstein, *Babylonian Chronology 626 B.C. – A.D. 75*.

¹⁸Daniel I. Block, *The Book of Ezekiel: Chapters 1—24*, p. 23.

¹⁹Jerome Murphy O'Connor, "The Weight of God's Name: Ezekiel in Context and Canon," *The Bible Today* 18 (1980):28.

Two other features mark the oracles in Ezekiel. One is the "halving" of oracles in which the writer first propounded a theme and then pursued a different theme only to end with a coda that links elements from both parts.²⁰ The second characteristic is the use of an earlier text or tradition, the interpretation of it in the light of current circumstances, and the application of it to new situations.²¹

Another stylistic characteristic is the formulaic expressions Ezekiel used, some of which are unique to him and others shared with other prophets. Ezekiel usually referred to Yahweh as '*adonay yhwh*, "the Lord Yahweh" (217 times). This title emphasized Yahweh's authority as His people's divine master. The name by which Yahweh addressed the prophet (93 times) is consistently *ben 'adam*, "son of man"; He never used Ezekiel's personal name. This title, *ben 'adam*, appears only in Ezekiel and in Daniel 8:17, which Ezekiel 2:1 may have influenced. This title stresses the prophet's humanity and the distance between God and the human. Ezekiel's favorite title for the Israelites (in the former Northern Kingdom, in Jerusalem, or in exile) is *bet yisra'el*, "house (or family) of Israel" (83 times or 57 percent of its 146 uses in the Old Testament). This title expresses the solidarity of the Israelites.

Ezekiel almost always carefully distinguished whether he or Yahweh was speaking in contrast to some other prophets who sometimes leave the reader with a question about the speaker's identity. Other formulae of expression common in this book are "the word of the Lord came to me saying," "thus has the Lord Yahweh said," and "the declaration of the Lord Yahweh." "Set your face toward" is also common and means to face the person or persons addressed so they get the full impact of what is said. "The hand of the Lord came upon me" reflects God's control of His prophet as does "the Spirit of Yahweh fell upon me." "I am Yahweh" and "they will know that I am Yahweh" are also distinctive theological formulae.

"Much of Ezekiel's language is repetitive. This sometimes makes for tiresome reading, but it helps to highlight his recurrent themes."²²

GENRE

Ezekiel contains a combination of several types of literature. These include proverbs, visions, parables, symbolic acts, fables, allegories, quotations, oaths, rhetorical questions, disputation oracles, legal sayings, dreams, dramas, funeral dirges, historical narratives, ritual and priestly regulations, and apocalyptic revelations.

"The concentration of so many bizarre features in one individual is without precedent: his muteness; lying bound and naked; digging holes in the walls of houses; emotional paralysis in the face of his wife's death; 'spiritual' travels; images of strange creatures, of eyes, and of creeping things; hearing voices and the sounds of water; withdrawal symptoms, fascination with feces and blood; wild literary imagination; pornographic

²⁰See M. Greenberg, *Ezekiel 1—20*, pp. 25-26.

²¹See M. Fishbane, *Biblical Interpretation in Ancient Israel*.

²²Taylor, p. 40.

imagery; unreal if not surreal understanding of Israel's past; and the list goes on."²³

". . . Ezekiel is the great mystic among the inspired writers. Because of the difficulty in interpreting his figurative and visionary prophecies, he is the most neglected of all the prophets."²⁴

"For most Bible readers Ezekiel is almost a closed book. Their knowledge of him extends little further than his mysterious vision of God's chariot-throne [*merkabah*], with its wheels within wheels, and the vision of the valley of dry bones. Otherwise his book is as forbidding in its size as the prophet himself is in the complexity of his make-up."²⁵

Ezekiel was a most dramatic and forceful communicator of the messages that God gave him. He used more symbolism and allegory than any other Old Testament prophet.²⁶ Evidently God directed him to use such colorful methods to get the attention of his hearers, who were very discouraged and disinterested in what God had to say to them. Most of the book is prose, but some of it is poetry.

". . . not a colourful, descriptive prose, but a somber, prophetic prose with a cadence but no discernible metre."²⁷

"Visions figure more prominently in Ezekiel than in any other Old Testament prophet except Daniel. They are recounted in detail in chaps. 1—3; 8—11; 37; 40—48. These he received in what must have appeared to be a semiconscious state and then reported to his audience once the vision was over (11:25)."²⁸

"Dream-visions were common in Mesopotamia in the seventh and sixth centuries B.C.²⁹ This literary form had two major parts: (1) the setting of the vision, declaring the time, recipient, place of reception, and general circumstances; and (2) the description of the vision just as it was seen by the recipient. Ezekiel used this common type of literature in his book and also developed (along with Daniel and Zechariah in the OT) apocalyptic literature in the dream-vision format. This may be defined as 'symbolic visionary prophetic literature, composed during oppressive conditions, consisting of visions whose events are recorded exactly as they were seen by the author and explained through a divine interpreter, and whose

²³Block, p. 10.

²⁴Feinberg, p. 13.

²⁵Taylor, p. 13.

²⁶Feinberg, p. 13.

²⁷Taylor, p. 28.

²⁸Cooper, p. 29. See Douglas Stuart, *Ezekiel*, pp. 27-28.

²⁹See A. Leo Oppenheim, *The Interpretation of Dreams in the Ancient Near East with a Translation of an Assyrian Dream-Book*, pp. 186-225.

theological content is primarily eschatological.³⁰ Twice Ezekiel used this genre, which would be well known to the exiles, to encourage them during their time of oppression. Both apocalyptic visions contained messages of restoration and blessing."³¹

". . . the biblical books that could qualify as apocalyptic include Ezekiel, Daniel, Zechariah, and Revelation. Many other passages express apocalyptic eschatology, but these four books alone qualify in content and form as apocalyptic literature."³²

There is much disagreement among the scholars, however, as to the extent of apocalyptic in Scripture.

"Several features characterize apocalyptic literature: (1) It focuses on the end of the ages. (2) Its method of revelation is dynamic (i.e. through an angelic interpreter; don't tell anyone but keep the message among the wise that judgment is coming on the wicked). (3) It presents several dualisms [the wicked and the righteous, the present age and the age to come, heaven and the world, etc]. . . . (4) It is addressed to the oppressed as a means of resolving Israel's stark political realities with the promise of blessing in the Land. (5) It uses bizarre and/or cosmic images, not the terms of plain history. . . . (6) Its purpose is to bring repentance. In apocalyptic the temporal and spatial categories of blessing in the new age are expressed in more cosmic dimension."³³

"Whether one is preaching, teaching, writing, or counseling, getting a message across effectively involves communication in a way that will allow people to form mental images. Unless what we say is clear and vivid enough that people can somehow 'see' what we're saying, they are not as likely to remember it long enough for it to do any good."³⁴

THEOLOGY

Several theological concepts receive considerable attention in Ezekiel. Alexander identified five central ones: the nature of God, the purpose and nature of God's judgment, individual responsibility, the ethical, religious, and moral history of Israel, and the nature of Israel's restoration and future worship.³⁵ Cooper mentioned six significant theological themes: the holiness and transcendence of God, the sinfulness of humanity, the

³⁰Ralph H. Alexander, "Hermeneutics of Old Testament Apocalyptic Literature" (Th.D. dissertation, Dallas Theological Seminary, 1968), p. 45. See also Cooper, pp. 37-38; and D. S. Russell, *The Method and Message of Jewish Apocalyptic*, pp. 89-90, 104-39.

³¹Alexander, "Ezekiel," p. 745.

³²Elliott E. Johnson, "Apoclyptic Genre in Literary Interpretation," in *Essays in Honor of J. Dwight Pentecost*, p. 200.

³³Bruce K. Waltke, *An Old Testament Theology*, p. 550.

³⁴Stuart, pp. 27-28.

³⁵Alexander, "Ezekiel," pp. 745-46.

inevitability of judgment, individual responsibility, hope of restoration, and God's redemptive purpose.³⁶ Stuart listed seven major themes: the reliability of God's word, the glory of God, individual responsibility, Israel's long history of sin, the power of national leadership for good or bad, God's holiness and our responsibility for obedience, and God's transcendence.³⁷

God's glory is the theme that runs throughout this book, from the prophet's call when that glory first impressed him, to the demonstration of that glory in the eschatological future. References to God's glory keep popping up throughout the book (1:28; 3:12, 23; 8:4; 9:3; 10:4, 18-19; 11:22-23; 39:11, 21; 43:2-5; 44:4). God's glory is an aspect of His character, and His glorious character determines His conduct throughout history and this revelation. Without an appreciation of the glory of God's character the Israelites could not make sense of His dealings with them. Fifteen times God said He acted to keep His name glorious (20:9, 14, 22, 39, 44; 36:20-23; 39:7, 25; 43:7-8). Over 60 times the Lord said He had acted so the people would know that He was Yahweh.³⁸

"... the phrase 'you will know that I am the Lord' or 'they will know that I am the Lord' or the like may well be the central theological theme of the book."³⁹

Ezekiel presented God as the God of Israel. By comparison, Isaiah pictured Him as the God of the entire world. Ezekiel had a great appreciation of the holiness (otherness) of God, as did Isaiah, but He did not use the title "Holy One of Israel" that is so common in Isaiah.

"The vision of the Lord riding upon His chariot-throne (1—3) typified this sense of otherness and majesty. It was unutterably splendid, mysteriously intricate, superhuman and supernatural, infinitely mobile but never earth-bound, all-seeing and all-knowing. This is how God revealed Himself to Ezekiel, not by propositions regarding His character but in personal encounter."⁴⁰

"The vision Ezekiel had at the time of his call never left him but influenced his thought continually."⁴¹

Ezekiel stressed God's relationship to His covenants with Israel, which Ezekiel viewed positively. Yahweh, for Ezekiel, was a God who acts. The Spirit of God features more prominently in Ezekiel than in any other prophetic book. The prophet also emphasized the fact that God's will for Israel was blessing more than punishment.

³⁶Cooper, pp. 40-44.

³⁷Stuart, pp. 19-20.

³⁸Charles H. Dyer, "Ezekiel," in *The Bible Knowledge Commentary: Old Testament*, p. 1226.

³⁹Eugene H. Merrill, "A Theology of Ezekiel and Daniel," in *A Biblical Theology of the Old Testament*, p. 367.

⁴⁰Taylor, p. 41.

⁴¹Feinberg, p. 13.

Ezekiel viewed Israel as the people of God. He paid little attention to Israel's pre-Egyptian history. He divided Israel's history into seven eras, each of which is characterized by Yahweh's gracious acts on Israel's behalf and Israel's rejection of her covenant (ch. 20). God's relationship with Israel was pure grace from beginning to end. Yahweh sovereignly chose and redeemed Israel. Israel therefore needed to respond to such grace with devotion and obedience to her Lord. The wellbeing of the Israelites reflected on God's reputation in the world.

"Ezekiel, perhaps more than any other prophet, forcefully exposed idolatry as the root problem of the heart. For God's people, faith had become largely externalized. But the 'unthinkable' Exile forced the issue when God confronted and conscripted Ezekiel to deliver His message of both bitter judgment and sweet hope."⁴²

Ezekiel looked beyond the present condition of Israel to the time when she would experience restoration and prosperity in the Promised Land. God would bring His chosen people back in a new Exodus cleansed from their former sins and revitalized with a new heart and His Spirit under a new covenant. "David" would be God's agent of salvation and a symbol of unity for the nation. Israel would then enjoy unprecedented prosperity and security in her own land. God would establish residence among the Israelites and reorganize their worship.

"Ezekiel provides much of the evidence for the pronounced Jewish tone of the millennium and the sequence of eschatological events recognized especially by dispensationalist premillenarians."⁴³

There are few overt references to Messiah in Ezekiel. The major passages are 34:23-24 and 37:22-25. Minor references appear in 17:22 and 29:21.

"Fundamentally the theology of Ezekiel revolves around the bipolar themes of judgment and restoration. . . .

"Restoration will take two forms or will occur in two phases, however. It will come to pass in history under the beneficent policy of Cyrus the Persian, but that is only a type, a foretaste, of complete renewal and reconstitution that must await the eschaton."⁴⁴

TEXT

The Hebrew text of Ezekiel has suffered more than most Old Testament books in the process of transmission. This is due to the large number of technical expressions, including dates and measurements, that occur only once in the Hebrew Bible. Unknown and difficult words resulted in many copyist errors. Consequently there are many interpretive difficulties in Ezekiel.

⁴²John N. Day, "Ezekiel and the Heart of Idolatry," *Bibliotheca Sacra* 164:653 (January-March 2007):33.

⁴³Block, p. 56. See Cooper, pp. 45-52, for discussion of Ezekiel's concepts of the millennium and the kingdom of God.

⁴⁴Merrill, pp. 386, 387.

OUTLINE

- I. Ezekiel's calling and commission chs. 1—3
 - A. The vision of God's glory ch. 1
 - 1. The setting of the vision 1:1-3
 - 2. The vision proper 1:4-28
 - B. The Lord's charge to Ezekiel chs. 2—3
 - 1. The recipients of Ezekiel's ministry 2:1-5
 - 2. The encouragement in Ezekiel's ministry 2:6-7
 - 3. The nature of Ezekiel's ministry 2:8—3:11
 - 4. The conclusion of the vision 3:12-15
 - 5. Ezekiel's role in Israel 3:16-21
 - 6. Ezekiel's muteness 3:22-27
- II. Oracles of judgment on Judah and Jerusalem for sin chs. 4—24
 - A. Ezekiel's initial warnings chs. 4—7
 - 1. Dramatizations of the siege of Jerusalem chs. 4—5
 - 2. The judgment coming on Judah chs. 6—7
 - B. The vision of the departure of Yahweh's glory chs. 8—11
 - 1. The idolatry of the house of Israel ch. 8
 - 2. The coming slaughter of the wicked Jerusalemites ch. 9
 - 3. The departure of God's glory from the temple ch. 10
 - 4. The condemnation of Jerusalem's leaders ch. 11
 - C. Yahweh's reply to the invalid hopes of the Israelites chs. 12—19
 - 1. The dramatic tragedy of exile 12:1-20
 - 2. The present judgment as evidence of divine faithfulness 12:21-28
 - 3. The condemnation of contemporary false prophets ch. 13
 - 4. The effect of false prophets on Israel's leaders 14:1-11
 - 5. The need of personal righteousness for deliverance 14:12-23
 - 6. The unprofitable vine of Jerusalem ch. 15
 - 7. Jerusalem's history as a prostitute ch. 16
 - 8. The riddle and parable of the two eagles ch. 17
 - 9. The importance of individual righteousness ch. 18
 - 10. A lament for the kings of Israel ch. 19
 - D. Israel's defective leadership chs. 20—23
 - 1. The history of Israel's rebellion and Yahweh's grace 20:1-44
 - 2. Judgment on Judah's contemporary leaders 20:45—21:32
 - 3. The idolatrous rulers of Judah ch. 22
 - 4. The parable of the two sisters ch. 23
 - E. The execution of Jerusalem's judgment ch. 24
 - 1. The parable of the cooking pot 24:1-14
 - 2. Signs to the exiles 24:15-27

- III. Oracles against foreign nations chs. 25—32
 - A. Oracles against Judah's closest neighbors ch. 25
 - 1. Judgment on Ammon 25:1-7
 - 2. Judgment on Moab 25:8-11
 - 3. Judgment on Edom 25:12-14
 - 4. Judgment on Philistia 25:15-17
 - B. Judgment on Tyre 26:1—28:19
 - 1. Judgment by Babylonia and other enemies ch. 26
 - 2. A funeral dirge over Tyre ch. 27
 - 3. A judgment speech against the ruler of Tyre 28:1-10
 - 4. A funeral dirge for the king of Tyre 28:11-19
 - C. Judgment on Sidon 28:20-24
 - D. Israel's restoration from the nations 28:25-26
 - E. Judgment on Egypt chs. 29—32
 - 1. An introductory prophecy of judgment on Egypt 29:1-16
 - 2. The consummation of Egypt's judgment 29:17-21
 - 3. The destruction of Egypt and her allies 30:1-19
 - 4. Pharaoh's broken arms 30:20-26
 - 5. Egypt's fall compared to Assyria's fall ch. 31
 - 6. A funeral dirge for Egypt 32:1-16
 - 7. A summary lament over Egypt 32:17-32
- IV. Future blessings for Israel chs. 33—48
 - A. A warning to the exiles 33:1-20
 - 1. An exhortation to heed the watchman 33:1-9
 - 2. An exhortation to turn from evil 33:10-20
 - B. Restoration to the Promised Land 33:21—39:29
 - 1. Israel and the Promised Land 33:21-33
 - 2. False and true shepherds ch. 34
 - 3. Preparation of the Promised Land 35:1—36:15
 - 4. Restoration to the Promised Land 36:16—37:14
 - 5. Reunification in the Promised Land 37:15-28
 - 6. Future invasion of the Promised Land chs. 38—39
 - C. Ezekiel's vision of the return of God's glory chs. 40—48
 - 1. The setting of the vision of the return of God's glory 40:1-4
 - 2. The millennial temple 40:5—42:20
 - 3. The return of God's glory to the temple 43:1-12
 - 4. Temple ordinances 43:13—46:24
 - 5. Topographical aspects of the Millennium chs. 47—48

MESSAGE

Ezekiel began prophesying when he was 30 years old. He had gone into captivity five years before that. So Ezekiel was familiar with Jeremiah's preaching and ministry. Ezekiel shows quite a bit of similarity to Jeremiah in his book. Ezekiel was a priest, as was Jeremiah. However, neither of them served as priests, Jeremiah, evidently because he chose not, to in view of the corruption in the priesthood, and Ezekiel, because he went into captivity before he was old enough to serve. In captivity, there was no temple, so Ezekiel could not minister as a priest there, even if he wanted to. Besides, God gave both men a calling to a prophetic ministry.

There are indications in the Book of Ezekiel that Jeremiah had an influence on Ezekiel. They both had the same outlook on the corruption of the Israelites, on the judgment of God, and on the hope that held out promise for a brighter day ahead. Ezekiel was equally as explicit as Jeremiah about the corruption of the people and the inevitability of coming judgment. But it is his vision of the future for which Ezekiel has become famous, and in this he surpassed his older contemporary. He was able to see beyond the Israelites in exile, and so spoke to all Israel, and he was able to see beyond Israel, and so spoke to all humanity.

We might say that Ezekiel saw the dirt on the glass of his window to the world, but he also saw through the glass far into the future. He saw the reasons for Israel's present misery, but he also saw the reason for her future restoration, namely: the faithfulness of Israel's glorious God. Perhaps it is this long view that saved Ezekiel from becoming another weeping prophet like Jeremiah. He had a grip on the big picture that lay ahead of Israel and the nations like few other prophets did. Daniel saw the future too, but he did not say as much about the present as Ezekiel did. Actually, Ezekiel gives us more revelation concerning the eschaton—the far distant future—than Daniel does. Ezekiel's concerns were spiritual; Daniel's were mainly political. Ezekiel spoke of a future covenant of peace and future worship, but Daniel talked about future kings and kingdoms.

The permanent value of the Book of Ezekiel is its revelation of the reason for hope. Whereas Jeremiah sometimes despaired and lost sight of his hope, Ezekiel never did. It is somewhat surprising that Ezekiel was so full of hope when he was in a worse situation than Jeremiah. For most of Jeremiah's ministry, the exile was ahead, but Ezekiel spent his whole ministry *in exile*, ministering among Israelites who were more thoroughly discouraged than Jeremiah's audiences. The exiles were an even harder audience to minister to than the former Judahites who had anticipated exile, as the Book of Ezekiel makes clear. Nonetheless, Ezekiel remained hopeful. His perspective is the key to anyone remaining hopeful in the midst of very discouraging circumstances, even us.

The thing that filled Ezekiel's heart with hope was his understanding of the Lord. That understanding came to him from a vision of God. As soon as many Christians hear that some prophet had a vision of God, they say to themselves, "Well, that lets me out. Maybe if I could have a vision of God like Ezekiel did, I could have the ministry that he did and not lose hope." We fail to appreciate that we have a far greater "vision" of God in Scripture than any Old Testament prophet ever did. We need to get past the vision idea to

the content of the vision. Ezekiel's vision of God's glory in chapter 1 just gave him a certain understanding of God, the same understanding of God that we can obtain by reading about Ezekiel's vision, plus the other revelations of God in the Bible.

Ezekiel's vision of God's glory was mysterious—full of strange images and symbols—but it was a manifestation. In this vision, God allowed the prophet to see likenesses of Himself and His celestial throne room. A likeness reveals something else. A photographic likeness reveals the person in the picture. A likeness is a comparison, a parable, if you will. A parable is a story placed alongside to explain something else. It is a word picture designed to interpret something. That is what Ezekiel's vision of God was, and what his other visions were. He did not really see God *Himself*. "No man has seen God at any time" (John 1:18; 1 John 4:12). He saw images of God that reveal what God is like. That is really what the whole Bible is: images of what God is like (cf. Christ; Heb. 1:1-2). Ezekiel's vision of God in chapter 1, which so many of the readers of this book never get past when they read the book, was the reason for his hope that shines forth in the rest of the book.

Isaiah reveals the salvation of God; it is the Romans of the Old Testament. Jeremiah reveals the judgment of God, and Lamentations is judgment's outcome. Ezekiel reveals the glory of God.

As the book opens, Ezekiel sees God in all His glory (i.e., sees representations of God's glory). Then, in another vision, he sees the glory of God departing from the temple in Jerusalem, when the city fell to King Nebuchadnezzar (ch. 10). Then at the end of the book and at the end of his writing ministry, he saw in another vision the glory of God returning to the temple (ch. 43). The temple to which God returned was not the same temple from which His glory had departed. It was a future temple in a restored Promised Land, where the Israelites had come to live in peace, having repented of their sins, and having experienced God's regathering from the ends of the earth.

These three visions of the glory of God provide the framework and rationale for the book, as well as the hope of Israel and the world. God is the center of this unfolding drama. References to the glory of God frame the first major section of the book (chs. 1—3). It was out of this glorious revelation that God called Ezekiel to his ministry. The oracles of judgment on Judah and Jerusalem that follow (chs. 4—24) make sense because God is full of glory, as do the oracles of judgment on the nations (chs. 25—32). When Ezekiel received word that Jerusalem had fallen (ch. 33), he left the past behind and turned to the future. He began proclaiming future blessings for Israel, blessings assured by the character of Yahweh, a glorious God who would fulfill His covenant promises to His chosen people, even though they had been unfaithful to Him. God allowed the prophet to see another vision of His glory returning to the temple in the future. All of chapters 40—48 deal with the setting and accompaniments of that return of God to His people. And the book closes with the Lord being there, among His people—forever (48:35).

What is the glory of God? It is the expression, or the outshining, of His person. It is the beauty, radiance, splendor, and magnificence of God's person. When we say that Ezekiel is a revelation of the glory of God, we mean that it is an unveiling of God Himself, in unusual clarity and relevance. The Book of Revelation is the same kind of unveiling, but

of Jesus Christ; it is the climax of biblical Christology. Ezekiel reveals very important characteristics of God. It does this at times by using pictures, dramas, and symbolic acts, as well as straightforward explanations. It often does it in apocalyptic images: pictures of God at work doing things in the end times. Much of the imagery has its roots in Ezekiel's culture, both Israelite and ancient Near Eastern, particularly Babylonian. For example, cherubim, or cherubs, were well known in the ancient Near East. The word translated "cherub" means "great" or "mighty" in Hebrew.

The secret of Ezekiel's optimism about the future, even though he lived in a situation that led most of the other Israelites to abandon their commitment to God, was his personal acquaintance with God Himself. This book reveals the very nature of God Himself to a degree no other book in the Bible does.

As we read this book and get to know what it reveals, we need to ask God to help us understand Him better, above everything else, because understanding God is the very foundation for hope. Where there is hope, there is joy, there is peace, there is love, there is faith, and there is ministry. In the times in which we live, a commitment to ministry by itself will not preserve a Christian from all the pitfalls that surround us. Only ministry grounded in and growing out of our personal understanding and appreciation of the character of God will do that. That is the practical value of studying this intimidating book.

A phrase that marks this book and that occurs over 60 times in it is, "Then they will know that I am the LORD." This phrase almost becomes boring because Ezekiel repeated it so often. God used the events of Ezekiel's life to teach His people—and all people—that He is the only true God. In the future, He will bring things to pass that will teach people that *only He* is God. We can learn that even now, as we gain God's viewpoint on life from this great book. Then we can help others make sense out of what is happening, because we understand the One who is creating history.

Another key phrase in Ezekiel is "son of man." This was God's favorite title for Ezekiel. It should remind us every time we read it that Ezekiel was not, and we are not, God. This book presents God as different from anyone else, that is, He is holy. Whenever God spoke to Ezekiel using this title, He was reminding the prophet of Yahweh's uniqueness. Hopefully study of the book will also teach us and impress us with God's differentness. That is an aspect of His glory.

The knowledge of God is a perennial spring of joy and hope to the Christian and to the church. When we get to know Him we will be able to see sin, and we will hate it. We will also be able to proclaim judgment fearlessly. But most of all, we will be able to rejoice in the hope of the glory of God. The future is bright. We just need to be able to see through our dirty windows to the Morning Star rising in the east.⁴⁵

⁴⁵Adapted from G. Campbell Morgan, *Living Messages of the Books of the Bible*, 1:2:127-43

Exposition

I. EZEKIEL'S CALLING AND COMMISSION CHS. 1—3

Four elements that mark the commission narratives in the prophets are all present in this account of Ezekiel's calling. These include a divine confrontation, an explanation of the prophet's task and its importance, objections that the prophet might offer, and divine reassurance answering these objections and assuring the prophet of the Lord's enabling presence.⁴⁶ The record of God's commissioning of Ezekiel constitutes the longest prophetic call in the Bible (cf. Isa. 6; Jer. 1). God first confronted Ezekiel with Himself. Then He explained the prophet's task and its importance, next He dealt with objections that the prophet might offer, and finally He reassured Ezekiel by promising His enabling presence (cf. Josh. 1).

The passage has a chiasmic structure that focuses attention on the importance of Ezekiel receiving revelations from the Lord (2:8b—3:3).⁴⁷

- A Circumstances of the vision (1:1-3)
 - B Divine confrontation: the chariot's approach (1:4-28)
 - C Introductory word (2:1-2)
 - D First commission and reassurance (2:3-8a)
 - E Confirmatory sign (2:8b—3:3)
 - D' Second commission (3:4-11)
 - C' Introductory word (3:12)
 - B' Divine confrontation: the chariot's departure (3:13)
- A' Circumstances of the vision (3:14-15)

A. THE VISION OF GOD'S GLORY CH. 1

"In chapter 1 God has brought together in one vision the essence of all that was to occupy Ezekiel, just as is found in the initial vision of the Apostle John in Revelation."⁴⁸

It is important to bear four principles of normal historical-grammatical hermeneutics in mind when interpreting visionary literature such as what we have in this chapter.

1. Seek to understand the major idea presented through the vision and do not dwell on minutiae. This guideline is underscored in the second principle.

⁴⁶See N. Habel, "The Form and Significance of the Call Narrative," *Zeitschrift für die Alttestamentliche Wissenschaft* 77 (1965):297-323.

⁴⁷Henry van Dyke Parunak, "The Literary Architecture of Ezekiel's *mar'ot 'elohim*," *Journal of Biblical Literature* 99 (1980):61-74.

⁴⁸Feinberg, p. 20.

"2. Follow the divine interpretations normally accompanying the visions. These divine interpretations concentrate on the overall concept rather than on details."⁴⁹

"3. Be keenly aware of parallel passages and the harmony of Scripture, since the prophets normally sought to apply past revelations of God to their contemporary situations. The general prophetic message among the prophets is essentially the same.

"4. Use the same approach with the symbols and imagery of visionary literature as used with figurative language. Thus symbols and imagery are properly understood as figures and are not to be taken literally."⁵⁰

1. The setting of the vision 1:1-3

"The setting of the Mesopotamian dream-visions—which occurred in both the Assyrian period and the Babylonian period . . . —consisted of four elements: (1) the date, (2) the place of reception, (3) the recipient, and (4) the circumstances. Ezekiel included all four aspects in his vision."⁵¹

1:1 The book begins with an introductory formula that is typical of narrative literature: "Now it came about" (Heb. *wayhi*; cf. Josh. 1:1; Judg. 1:1; Ruth 1:1; 1 Sam. 1:1; Esth. 1:1; Jon. 1:1). Ezekiel is essentially a narrative that contains other types of literature.

Ezekiel dated his vision of God that follows as coming to him on the fifth day of the fourth month (the equivalent of July 31) and in the thirtieth year. The thirtieth year evidently refers to the prophet's thirtieth year, when he was 30 years old.⁵² Other views are that this was the thirtieth year following the discovery of the Law and Josiah's reforms, the thirtieth year since the Exile began in 605 B.C., the thirtieth year of Nabopolassar's reign, the thirtieth year of Jehoiachin (the date of compilation of the book), or the thirtieth year after the last observed year of jubilee.⁵³ Frequently when someone recorded personal reminiscences he gave the person's age (cf. Gen. 8:13). Thirty was the age at which priests entered into their ministry in Israel (Num. 4:3, 23, 30, 39, 43; 1 Chron. 23:3), and Ezekiel was a priest (v. 3).

These visions came to Ezekiel while he was among the Jewish exiles who settled by the Chebar River in Babylonia. The Chebar River was a large, navigable canal that tied into the Euphrates River north and south of Babylon. It made a semicircular loop around the city.

⁴⁹The commentators often speculate on the meaning of various details of a vision, but sometimes these are no more than guesses. I have given my own interpretations of some of these details, sometimes following other expositors. But where I am doubtful I have either expressed my uncertainty or not speculated.

⁵⁰Alexander, "Ezekiel," p. 756.

⁵¹Ibid., p. 754. See Oppenheim, pp. 186-87.

⁵²Allen, pp. 20-21.

⁵³See Anthony D. York, "Ezekiel I: Inaugural and Restoration Visions?" *Vetus Testamentum* 27 (1977):82-98.

"It was part of a complex network of canals that came into being in the Mesopotamian heartland to provide artificial irrigation from the Euphrates and, to a lesser extent, the Tigris for the grain crops and date orchards, and also, in the case of larger watercourses, transportation of these and other goods."⁵⁴

Ezekiel saw the heavens opened, and he beheld the heavenly throne room of God (cf. Matt. 3:16; Mark 1:10; Luke 3:21; John 1:32, 51; Acts 7:56; 10:11; Rev. 4:1; 19:11).⁵⁵

1:2-3

Perhaps a later inspired scribe added the information in these verses to clarify exactly who Ezekiel was and when he saw this vision. King Jehoiachin's fifth year of exile was 593 B.C. Both Ezekiel and Jehoiachin went into captivity at the same time, in the second deportation of Judean prisoners in 597 B.C. This is the reference year from which all the prophecies in Ezekiel date.

Ezekiel was a priest as well as a prophet. His father was Buzi, evidently of Zadok's branch of Aaron's family (cf. 1 Kings 1:32-35). As a priest, Ezekiel was familiar with the Mosaic Covenant and the priestly functions and paraphernalia of the temple, which becomes clear in this book. The Chaldeans were the rulers of the Babylonian Empire at the time of Israel's captivity.

The hand of the Lord that came upon Ezekiel is an anthropomorphism expressing the direct control and divine empowerment that Yahweh exercised over Ezekiel ("God strengthens") as He gave him these visions (3:14; cf. Isa. 25:10; 41:10, 20).

"The 'hand of the Lord' is always a metaphor for His power."⁵⁶

"The word of the Lord came to Ezekiel" and "The hand of the Lord was upon him" are phrases that typically introduce revelations from God in this book (3:22; 8:1; 33:22; 37:1; 40:1; cf. 2 Kings 3:15). The hand reference especially distinguishes Ezekiel as being under the controlling influence of God's Spirit, compared to other prophets.⁵⁷ Perhaps this was important in this book since Ezekiel's visions and actions have called his sanity into question. Several psychoanalytical studies have been done on Ezekiel.⁵⁸

⁵⁴Allen, p. 22.

⁵⁵See Allan J. McNicol, "The Heavenly Sanctuary in Judaism: A Model for Tracing the Origin of an Apocalypse," *Journal of Religious Studies* 13:2 (1987):66-94.

⁵⁶Merrill, p. 368.

⁵⁷See Daniel I. Block, "The Prophet of the Spirit: The Use of *rwh* in Ezekiel," *Journal of the Evangelical Theological Society* 32 (1989):33.

⁵⁸See idem, *The Book . . .*, pp. 10-12.

"These three elements—vision [v. 1], word [v. 3], and power (or hand) [v. 3]—appear pervasively in Ezekiel's descriptions of his call and of Yahweh's self-revelation. The vision is the abstract message itself, the word is its interpretation, and the power is the means by which the message is effectually communicated. For the hand of the Lord to come on the prophet is to assure him of the Lord's affirmation and enablement."⁵⁹

The "visions of God" referred to in 1:1 receive fuller exposition in 1:4—2:7. Likewise the "word of the LORD" in 1:3 gets more attention in 2:8—3:11 as does the "hand of the LORD," also in 1:3, in 3:12-27.⁶⁰

2. The vision proper 1:4-28

Ezekiel saw three things in this vision: living beings (vv. 4-14), wheels in motion (vv. 15-21), and a great expanse (vv. 22-28).

The living beings 1:4-14

1:4 Ezekiel saw within the opened heavens a great cloud blown toward him by the north wind with lightning flashing from it almost constantly (cf. 1 Kings 19:11-13; Job 38:1; 40:6; Ps. 29:3-5). Israel's enemies had invaded from the north, so the implication was that an invasion was coming. He also saw a bright light around this cloud and something like hot glowing metal shining in its midst, evidently God Himself (cf. Exod. 13:17-22; 19:16-18; Deut. 4:24; Heb. 12:28-29). The biblical writers sometimes described God's abode as in the north (e.g., Ps. 48:2; Isa. 14:13; cf. Matt. 24:30; 26:32; 1 Thess. 4:17), and they often associated storms and clouds with theophanies (e.g., Job 38:1; Ps. 29:3-9; 104:3; Isa. 29:6; cf. Exod. 13:21; Lev. 16:2).

As God had riveted the attention of Moses by showing him a bush that was burning but not burning up (Exod. 3:1-15), so God captured Ezekiel's attention with this vision of a burning cloud.

1:5-7 Within the cloud the prophet saw four figures that resembled living beings (cf. Rev. 4). They had human form, but each of them had four faces and four wings.⁶¹ Each face represents the highest form of animal life in a general category, probably showing that God is lord of all creation.⁶² Their legs did not have knee joints, which made them very stable. Their feet looked like the hoofs of calves, but they shone like they were polished bronze. Calves' feet suggest nimbleness (cf. Ps. 29:6; Mal. 4:2), and their sheen may represent their strength.

⁵⁹Merrill, p. 367.

⁶⁰Charles H. Dyer, in *The Old Testament Explorer*, p. 660.

⁶¹See Allen, pp. 27-30, for some illustrations reproduced from a German work by O. Keel, which is "a lavishly illustrated study of ancient Near Eastern and Anatolian royal and religious iconography that sheds light on the particular throne imagery reflected here." (Ibid., p. 27.)

⁶²Cooper, p. 65; Dyer, "Ezekiel," p. 1228; Taylor, p. 55.

These living creatures were cherubim (cf. 10:15, 20; Gen. 3:22-24). Appearances of cherubim sometime accompany references to God's glory and holiness in the Old Testament, but their specific function remains a mystery. Ezekiel would have been familiar with cherubim because they were represented on the ark and in the curtains of the temple (Exod. 25:17-22; 26:31; Num. 7:89; 1 Sam. 4:4; 2 Sam. 6:2; 1 Chron. 28:18; Ps. 80:1; 99:1; Isa. 37:16). The Mesopotamians also pictured spirit beings guarding their temples in their artwork.⁶³

1:8-9 There were four wings on each of the cherubim, one on each of their four sides, and under each wing Ezekiel could see a human hand. The wings of each creature touched each other, and these creatures also had a face on each of their four sides. This enabled them to move in any direction without having to turn their faces. They enjoyed maximum mobility and awareness.

1:10-11 The forward face on each creature looked like a man, another like a lion, another like a bull, and the fourth like an eagle (cf. Rev. 4:7). These were traditionally the four most impressive animals, man being the chief over all, the lion chief of the wild animals, the ox chief of the domesticated animals, and the eagle chief of the birds.⁶⁴ Their faces may represent the intelligence, majesty (or strength), strength (or ferocity), and speed (or freedom) of these creatures. Their wings spread out above them, evidently to support the platform above (vv. 22-23). Another view is that the cherubim were the wheels in the sense that the life spirit of the creatures was in the wheels.⁶⁵ Two wings of each creature touched the wings of another of the creatures uniting them in action, and two of them covered the bodies of each creature, probably demonstrating humility.

The church fathers connected the lion with Matthew, the ox with Mark, the man with Luke, and the eagle with John. They believed that these writers stressed a prominent characteristic of Jesus Christ represented by each of these creatures in their Gospels, namely, royalty, service, humanity, and godlikeness.

1:12 Each creature moved straight forward without deviating, in the direction of the front of each body. Each one followed the lead of the Spirit without twisting as it went. In this context, the Spirit in view is probably the Holy Spirit of God. Other possibilities are the wind that brought the cloud, the spirit of the creatures themselves, or the "vital energy or impulse by which God from His throne acted upon them"⁶⁶

⁶³Greenberg, p. 55.

⁶⁴Stuart, p. 32.

⁶⁵Merrill, p. 368.

⁶⁶G. A. Cooke, *A Critical and Exegetical Commentary on the Book of Ezekiel*, p. 15.

- 1:13 In the center of this group of four living beings was something that looked to Ezekiel like a fire of burning coals that sent out sparks toward the creatures (cf. 2 Sam. 22:9, 13; Ps. 18:8). This fire was very bright, and what appeared to be lightning as well as sparks flashed forth from it (cf. Ps. 18:12; 77:17-18; 97:4).
- 1:14 The four living beings themselves darted about in Ezekiel's vision like bolts of lightning. Perhaps this presages the prophet's message of God's burning judgment on Judah.⁶⁷

"These spiritual beings who were part angel, part human, and part animal were fitting representatives of the whole created order. Their activity affirmed the relationship of God to his creation as Lord of all things. This idea was vital in helping Ezekiel and the captives in exile and the people in Judah understand that in the midst of the storms of life, God was still on his throne. He was not oblivious to their circumstances."⁶⁸

The wheels and their movement 1:15-21

- 1:15 Ezekiel also saw a prominent wheel standing upright on the ground beside each of the four living creatures.

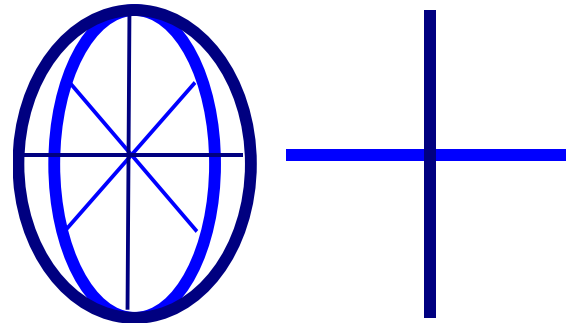

Side View

Top View

- 1:16 These wheels appeared to have been skillfully made of some valuable material, the exact identity of which is unknown today. They all looked alike, and each wheel appeared to have another wheel, which seems to have been the same size, within it (attached to it). Another interpretation is that the wheels' rims were concentric, a smaller one within a larger one. Evidently the axis of these wheels was the same and was vertical, forming a somewhat globe-like structure.⁶⁹ Chariot wheels seem to be what Ezekiel saw with other equally large chariot wheels intersecting the main wheels. These second wheels would have enabled the previously mentioned wheels to rotate left and right as well as forward and backward, as modern spherical casters do.
- 1:17 These wheels moved in every direction, but they did not appear to rotate when they moved. Ease of movement seems to be the point. They did,

⁶⁷Dyer, "Ezekiel," p. 1228.

⁶⁸Cooper, p. 67.

⁶⁹Allen, pp. 33-34.

however, make rumbling sounds when they moved, as large wheels would do (cf. v. 24; 3:12-13; 10:5, 13).

- 1:18 The rims around these wheels had eyes all around them (cf. Rev. 4:6). This gave the wheels an even more awesome appearance. Many eyes elsewhere in figurative language represent great intelligence and perception (cf. 2 Chron. 16:9; Prov. 15:3; Zech. 3:9; 4:10; Rev. 4:6).
- 1:19 There was some coordination between the living beings and these wheels because whenever one of the living creatures moved, its corresponding wheel moved with it. The creatures and wheels could move vertically above the ground as well as horizontally along the ground.
- 1:20-21 Just as the creatures moved at the impulse of the Spirit (v. 12), so their corresponding wheels also moved at its impulse. The creatures and the wheels always moved or rested together regardless of the direction in which they moved because the Spirit controlled them.

Most expositors view these cherubim as forming, supporting, or pulling a throne-chariot on which Ezekiel saw God riding (cf. Exod. 25:10-22; 2 Sam. 22:11; 1 Chron. 28:18; Ps. 18:11; Dan. 7:9; Heb. 8:5; Rev. 4). I think this makes sense. Perhaps the mobility of the wheels suggests God's omnipresence, the eyes His omniscience, and the elevated position His omnipotence.⁷⁰

"God had wheels! He was not limited. He could go anywhere anytime. . . .

"Thus ultimately the chariot vision is a vision of hope for a people who needed encouragement to hope once again. A vision of God's mobility was for them a message not to despair but to anticipate: in what way was God on the move and how did it concern them? The following passages provided the answer."⁷¹

The expanse 1:22-28

- 1:22 Ezekiel also saw something like a clear expanse (Heb. *raqia'*, firmament, Gen. 1:6; Ps. 19:1; 150:1; Dan. 12:3) of ice (Heb. *qerah*, crystal) over the heads of these four living creatures. Rather than being empty space this expanse appeared to be a firm, level surface or platform.
- 1:23 As the creatures stood under this transparent expanse, Ezekiel saw two of the wings of each creature stretched out straight from their bodies and the other two wings of each one covering either side of their bodies.

⁷⁰Greenberg, pp. 46-47; J. W. Wevers, *Ezekiel*, p. 48; Cooper, p. 69.

⁷¹Stuart, pp. 34-35.

- 1:24 The prophet also heard a sound that the movement of the creatures' wings produced, a sound like a white-water torrent, or like the voice of Almighty God, or like an army on the move. When the creatures did not move, they dropped their wings.
- 1:25 Ezekiel also heard a voice coming from above the expanse over the creatures. It was evidently the voice of God (cf. Job 37:4-5; 40:9; Ps. 18:13; 104:7).
- 1:26 Over the heads of the creatures was also something like a throne that was dark blue and very beautiful, like lapis lazuli. Lapis lazuli is a dark blue semiprecious stone that the ancients valued greatly. Sitting on the throne high above the expanse was a figure that looked like a man (cf. Exod. 24:10; Rev. 4:2).
- 1:27 Above his waist he seemed similar to hot metal glowing with heat (cf. v. 4), and below his waist he seemed to resemble fire (cf. 8:2; Dan. 10:6; Rev. 4:3, 5). All around him there appeared to be a radiance, like the glow that surrounds red-hot metal and fire.
- 1:28 This radiance resembled a rainbow; it encircled the person on the throne. This radiance represents the glory that surrounds Yahweh as He sits on this heavenly throne (cf. Exod. 19; 1 Kings 8; Isa. 6; Dan. 10; Rev. 4).

"Noah saw the rainbow *after the storm* (Gen. 9:13-16), the Apostle John saw it *before the storm* (Rev. 4:3), but Ezekiel saw it *over the storm and in control of the storm*."⁷²

Ezekiel realized that what he was seeing was a representation of Yahweh, perhaps the preincarnate Christ, and he fell prostrate on the ground (cf. 3:23; Isa. 6:5; Dan. 8:17; 10:8-9; Rev. 1:17). Then he heard a voice speaking.

"It was a deeply-held tenet of Israelite religion from Moses onwards that God could not be visibly expressed, and for that very reason idolatry was out. But given the possibility of a theophany, no form but the human form could conceivably have been used to represent the Deity. It was, however, no mere human that Ezekiel saw: His radiance was surrounded by the glory of a rainbow, and the prophet could show his awe in no other way than by falling on his face in the dust before his God (28)."⁷³

⁷²Warren W. Wiersbe, "Ezekiel," in *The Bible Exposition Commentary/Prophets*, p. 166.

⁷³Taylor, p. 59.

Ezekiel realized that he was in the presence of the glorious, holy God who could judge sin and uncleanness instantaneously and finally. His only appropriate response was humble prostration, throwing himself on God's mercy (cf. Isa. 6:5).

"The opening vision of Ezekiel's ministry affirmed three significant truths about God that are summarized in v. 28. First, the vision was a reaffirmation of the nature of God as holy, powerful, and majestic. Second, the rainbow was a reminder of God's promise-making and promise-keeping character (Gen 9:16). It was a rekindler of hope that God could and would help. Third, it was an assurance that nothing, including geographic location, separated one from God (cf. Rom 8:38-39)."⁷⁴

The awesome holiness (otherness, difference, purity, perfection) of God overwhelmed Ezekiel. He undoubtedly associated the revelation in this vision with other similar manifestations that God had given of Himself in Israel's past: at Mount Sinai, in the wilderness wanderings, at the dedications of the tabernacle and temple, and in Isaiah's commission. As a priest Ezekiel would have been familiar with these former revelations, as the modern reader of the Old Testament is. Consequently he would have understood much that he saw. It provided a backdrop against which he understood Israel's sinfulness and God's judgment of sinful nations.⁷⁵

"Jacob saw God at Peniel and his life was transformed from that hour. Moses went up to Mount Sinai and communed with God face to face and thereafter was marked for the rest of his life. Isaiah saw the glory of the Lord in the sanctuary and his entire ministry was suffused with the beauty of the holiness of the Lord. Paul saw the risen and glorified Redeemer on the Damascus road and was blinded from that day on to all the allurements of the world. John saw visions of the glorious unfolding of God's program for Christ, the church and all the redeemed, and as a result was unmoved by the adverse circumstances that surrounded him. Ezekiel saw visions of the glory of the Lord God of Israel and his ministry never lost the impress of it."⁷⁶

Every servant of the Lord must appreciate the glory of God to serve Him effectively. One may not see a vision of God's glory or have a strongly emotional experience that devastates him or her, as Ezekiel did. Nevertheless the Holy Spirit will impress the glory of God on the servant's heart as that person views God in His Word. Appreciating the glory of God humbles a person and affects how one views other people and all of life.

"Let us hope that the majesty of God would always cause us, similarly, to respect and honor Him."⁷⁷

⁷⁴Cooper, p. 72. See also Peter C. Craigie, *Ezekiel*, pp. 12-14.

⁷⁵On the problem of textual corruptions in verses 4-28, see Daniel C. Fredericks, "Diglossia, Revelation, and Ezekiel's Inaugural Rite," *Journal of the Evangelical Theological Society* 41:2 (June 1998):189-99.

⁷⁶Feinberg, p. 17.

⁷⁷Stuart, p. 36.

B. THE LORD'S CHARGE TO EZEKIEL CHS. 2—3

Having seen a vision of God's glory, Ezekiel was now ready to receive his commission as the Lord's servant.

"The essential coherence between the vision and the ensuing commission is that the God who has revealed himself in a theophany of judgment turns Ezekiel into a prophet of judgment."⁷⁸

1. The recipients of Ezekiel's ministry 2:1-5

2:1 Yahweh instructed Ezekiel to stand on his feet because the Lord wanted to speak with him.

"Not paralysis before him is desired by God, but reasonable service. . . . It is man erect, man in his manhood, with whom God will have fellowship and with whom he will speak."⁷⁹

"The expression "son of man" [Heb. *ben 'ish*] is a common Semitic way of indicating an individual man (Ps. 4:2; 57:4; 58:1; 144:3; Jer. 49:18, 33; 50:40; 51:43)."⁸⁰

"Son of man" (Heb. *ben 'adam*) is a distinctive title in this prophecy and stresses the humanity of the prophet in contrast to the supernatural creatures and the deity of the glorious Lord. The Hebrew title appears 93 times in Ezekiel and only once elsewhere in the Old Testament (Dan. 8:17). In Daniel 8:17, this title, *ben 'adam*, describes Daniel. In the New Testament, "son of man" describes a person who is both God and man (cf. Dan. 7:13, *ben 'ish*). This was the favorite title that Jesus used of Himself in the Gospels (Matt. 8:20; 9:6; 11:19; Mark 2:28; 10:45; Luke 19:10; et al.). In view of its use in the Old Testament, "son of man" stressed Jesus' true humanity and His dependence on the Spirit of God as well as His deity.⁸¹ "Son of" indicates a close relationship even when it does not describe literal son-ship (e.g., "son of peace," i.e., a person associated with peace, Luke 10:6).

"By this title Ezekiel would be reminded continually that he was dependent on the Spirit's power, which enabled him to receive the message of God (v. 2) and to deliver it in the power and authority of the Lord—"This is what the Sovereign LORD says' (v. 4)."⁸²

⁷⁸Allen, p. 38.

⁷⁹A. B. Davidson, *The Book of the Prophet Ezekiel*, p. 15.

⁸⁰*The New Scofield Reference Bible*, p. 840.

⁸¹ See F. F. Bruce, "The Background to the Son of Man Sayings," in *Christ the Lord: Studies in Christology Presented to Donald Guthrie*, pp. 50-70.

⁸²Alexander, "Ezekiel," p. 761.

2:2 The Holy Spirit, or perhaps a wind sent from God,⁸³ entered Ezekiel as the Lord spoke to him and enabled him to stand up and hear what the Lord was saying (cf. 3:24; Exod. 4:10-15; 31:1-11; 1 Sam. 10:9-11; Ps. 51:11; Jer. 1:4-19; Dan. 8:18; Acts 2:4; Eph. 5:18; et al.).

2:3 The Lord explained that He was sending Ezekiel to the Israelites who were rebellious and had rebelled against Him. The current generation and their forefathers had transgressed against the Lord to the present day by violating the Mosaic Covenant. The history of Israel had been "one unbroken apostasy."⁸⁴

"The word 'rebellious' can be understood as the key to the attitude of Israel throughout the book."⁸⁵

"Though the technical language of covenant is sparse in Ezekiel, the notion of covenant is everywhere presupposed."⁸⁶

2:4 The people to whom God was sending Ezekiel were stubborn and obstinate (lit. hard-faced and hard-hearted), as children often are. The prophet was to announce to them what their master Yahweh said. Ezekiel used the title "Lord God" (Heb. *'adonay Yahweh*, Sovereign Yahweh) 217 times. It emphasizes both God's sovereign authority and His covenant-keeping faithfulness.⁸⁷

2:5 As a result of Ezekiel's ministry these people would know that a prophet had been among them, that God had sent a messenger to them, whether they chose to listen or not. They might not listen because they were a rebellious "house" (nation), but Ezekiel was not to change his message to accommodate his hearers.

2. The encouragement in Ezekiel's ministry 2:6-7

2:6 Ezekiel was not to fear the Israelites to whom he was to minister even though their reactions to him might be as uncomfortable as pricking thorns or stinging scorpions (cf. Josh. 1:9). Their words and actions would not be able to harm him even though they were a rebellious people (cf. Isa. 6:9-10; Jer. 1:18-19).

2:7 Whether these rebels listened or not, Ezekiel was to announce God's messages to them.

⁸³Robert B. Chisholm Jr., *Handbook on the Prophets*, p. 233.

⁸⁴C. H. Toy, *The Book of the Prophet Ezekiel*, p. 97.

⁸⁵Feinberg, p. 23.

⁸⁶Merrill, p. 369.

⁸⁷Dyer, "Ezekiel," p. 1230.

"The measure of success in God's work is not always in terms of the amount and frequency of visible response. Success is to be measured in terms of our obedience to the words, commands, and will of God regardless of the visible results [cf. Matt. 25:21, 23; 1 Cor. 4:2]."⁸⁸

"Rare is the person who can set out on a task knowing that people will hate him or her for doing it. But this is exactly what Ezekiel was called to do. His faithfulness stands as a challenge to ours."⁸⁹

3. The nature of Ezekiel's ministry 2:8—3:11

This pericope contains 10 commands, and it is the center of the chiasm in chapters 1—3.

"The Lord's charge to Ezekiel emphasized the absolute necessity of hearing, understanding, and assimilating God's message prior to going forth as a spokesman for the Lord."⁹⁰

All the Lord's representatives must do the same (cf. Ezra 7:10).

2:8 The Lord warned Ezekiel not to be rebellious like the people of Israel but to listen to Him and to receive the messages that God would feed him (cf. Deut. 8:3; Jer. 15:16; Matt. 4:4; John 6:53-58).

2:9-10 Ezekiel then saw a hand extending a scroll to him. The Lord spread it out before the prophet and he saw that it was full of lamentations, mourning, and woes (i.e., bad news; chs. 4—32). Normally scrolls had writing on only one side, but this one had writing on both sides; it was full of revelation (cf. Rev. 5:1).

"This accurately summarizes the contents of Ezekiel 4—32. It does not, however, reflect the latter part of the book in which the prophet spoke of Israel's restoration. This could explain, in part, why Ezekiel was recommissioned (chapter 33)—the content of his message was substantially changed after his message of woe was fulfilled."⁹¹

3:1-3 The Lord told Ezekiel to eat the scroll, a symbolic way of telling him to consume mentally and assimilate emotionally its contents.⁹² After he did this he was to go and speak to the Israelites, to tell them what the Lord had revealed. So the prophet consumed the contents of the scroll as the Lord fed it to him. The words of the Lord were sweet to Ezekiel's taste as he

⁸⁸Cooper, p. 77.

⁸⁹Stuart, p. 39.

⁹⁰Alexander, "Ezekiel," p. 763.

⁹¹Dyer, in *The Old . . .*, pp. 661-62.

⁹²E. W. Bullinger, *Figures of Speech Used in the Bible*, p. 826.

took them in (cf. Rev. 10:9-10). The word of God has an intrinsically pleasing and satisfying quality to those who, like Ezekiel, receive it gladly (cf. Ps. 19:10; 119:103; Prov. 16:24; 24:13-14; Jer. 15:16).

"No matter how painful the labor, there is satisfaction in finding and doing the will of God and in realizing service in fellowship with the living God."⁹³

3:4-6 Ezekiel was to go to the Israelites and tell them exactly what the Lord had revealed to him. They would be able to understand him because they spoke the same language as the prophet. God was not sending him to people who could not comprehend what he would tell them. The Israelites should listen to him because they could understand him.

3:7 Nevertheless the Israelites would not listen to Ezekiel since they refused to listen to the Lord who sent him (cf. Num. 14:1-12; 1 Sam. 8:4-7). All of them were very stubborn and obstinate. The Lord had similarly told Isaiah and Jeremiah not to expect dramatic positive response to their ministries (Isa. 6:8-13; Jer. 1:11-19).

"There is none so deaf as the person who does not want to hear."⁹⁴

"The difficulties of cross-cultural communication are nothing compared to the obstacle of spiritual blindness."⁹⁵

3:8-9 The Lord had made Ezekiel as hard-nosed as the Israelites; he would not give up speaking to them any more than they would refuse to listen to him. Therefore the prophet should not fear his audience. The meaning of Ezekiel's name, "God strengthens (or hardens)," reminded the prophet and others that the Lord would strengthen him and harden him against the attacks of his critical enemies.

3:10-11 The Lord Yahweh instructed Ezekiel further to take to heart all that He would tell him and to listen closely to Him. He was to go to the Jewish exiles and relay God's messages whether they paid attention or not.

God's word must become a part of the messenger before he or she can go and speak to others about it (cf. v. 1; Ezra 7:10).

"The most difficult task of a prophet is to change people's minds. This means pulling up the weeds of false theology and planting the good seed of the Word of God. It also means tearing down the flimsy thought

⁹³Feinberg, p. 27.

⁹⁴Allen, p. 42.

⁹⁵Cooper, p. 80.

structures that false prophets build and constructing in their place lasting buildings on solid foundations of truth (. . . 2 Cor. 10:3-6)."⁹⁶

4. The conclusion of the vision 3:12-15

"Ezekiel's vision of God's glory had provided the needed *perspective* for his task (1:4—2:7). The *message* he was to deliver was provided by God (2:8—3:11). Then he needed *motivation* to direct him to the task. That motivation was provided by the 'hand of the LORD' (cf. 1:3). He was first guided by the Spirit to his place of ministry (3:12-15); he was then formally appointed as God's watchman to Israel (vv. 16-21); then the Lord imposed several physical restraints on Ezekiel (vv. 22-27)."⁹⁷

3:12-13 The Lord's Spirit next lifted Ezekiel up and he heard a loud rumbling sound behind him. The sound was the sound of voices that blessed God for His glory (cf. Rev. 4—5). He also heard the sound of the cherubims' wings and the sound of the wheels rumbling. He was having another vision.⁹⁸

"This was no psychic levitation, but a subjective experience of feeling airborne . . ."⁹⁹

3:14 The Spirit lifted Ezekiel up and took him away from where he had been in his vision. He did not want to go and carry out the ministry that God had given him. His would not be a "successful" ministry in the eyes of people. But the Lord influenced him so strongly that he felt he had to obey (cf. Jer. 20:9; Jon. 1).

"The prophet was lifted up into sympathy with God and shared his righteous indignation against Israel."¹⁰⁰

Scholars of a more liberal persuasion often believe that references to the Spirit in the Old Testament indicate the power or influence of God, not the third person of the Trinity. Some conservative scholars believe that, though the Spirit was really the third person of the Trinity, people living during the Old Testament period did not associate the Spirit with God Himself. They thought of the Spirit as a power or influence of God. However there are several indications in the Old Testament that informed Israelites identified the Spirit with God (cf. Gen. 1:2; 2 Kings 2:9; Ps. 104:30; Ezek. 3:12-14; 11:1; Zech. 4:6).¹⁰¹

⁹⁶Wiersbe, p. 164.

⁹⁷Dyer, "Ezekiel," p. 1232.

⁹⁸See Edward J. Young, *My Servants, the Prophets*, pp. 182-87.

⁹⁹Taylor, p. 66.

¹⁰⁰Davidson, p. 21.

¹⁰¹See Leon J. Wood, *The Holy Spirit in the Old Testament*, and idem, *The Prophets . . .*, pp. 85-87.

3:15 Ezekiel physically traveled to the Jewish exiles who were living by the Chebar River at the Tel-abib settlement (lit. "hill of ears"). Since "Tel" can mean "ruined mound," it is possible that the Jewish exiles lived at the site of a destroyed or abandoned city. The Babylonians may have situated them there to rebuild and repopulate the site and to reclaim its land.¹⁰²

When Ezekiel arrived, he sat for seven days among the exiles, and his presence disturbed them. Seven days was the length of time that the Jews usually mourned for their dead (Gen. 50:10; Num. 19:11; Job 2:13), and it was the time it took to consecrate a priest (Lev. 8:33).

"Ezekiel was being consecrated for the priesthood on his thirtieth birthday and commissioned to proclaim Judah's funeral dirge."¹⁰³

"For a week he struggles inwardly with Yahweh, with his calling, and with the message he is charged to proclaim. Whatever the prophet's relationship to the rest of the exiles in the past, when he finally submits, he is a man set apart, under orders from God. Hereafter his people could expect no more idle or mundane chatter from him. His call to prophetic ministry was not only an invitation to be the spokesman for the glorious God of Israel; it also involved a sentence to a life of loneliness, alienation, and desolation. Physically he lived among his own people, but spiritually he would operate in another realm, a zone governed by divine realities."¹⁰⁴

5. Ezekiel's role in Israel 3:16-21

This section describes God's formal induction of Ezekiel into the prophetic office in legal language designed to impress his pastoral accountability on him (cf. Jer. 6:16-21).

3:16 At the end of these seven days the Lord's word came to Ezekiel. "The word of the Lord came to me" is a key phrase in Ezekiel occurring in 41 verses. It appears in Jeremiah nine times and in Zechariah twice.

"For no other prophet is there a record of such sustained contact with the divine word, the very essence of prophecy."¹⁰⁵

3:17 Yahweh told Ezekiel that He had appointed him to a ministry that was similar to that of a watchman who stood sentry and watched for any threat

¹⁰²Stuart, p. 29.

¹⁰³Alexander, "Ezekiel," p. 764.

¹⁰⁴Block, *The Book . . .*, p. 138.

¹⁰⁵Craigie, p. 22.

to his city (cf. 2 Sam. 18:24-27; 2 Kings 9:17-20; Jer. 6:17). Whenever Ezekiel received a word from the Lord he was to pass it along to the Israelites (cf. Isa. 56:10; Jer. 6:17; Hos. 9:8).

3:18 If Ezekiel failed to pass along a message of warning to the Israelites, warning them to repent or die, the Lord would hold Ezekiel personally responsible for their fate (cf. ch. 18; 33:1-20).

3:19 If, however, Ezekiel did warn the people and they refused to repent, they would die, but the Lord would not hold Ezekiel responsible.

3:20 Similarly if a righteous person turned to sin and Ezekiel failed to warn him of its consequences, even though the Lord would put him to death, the Lord would hold Ezekiel responsible for not warning him. The obstacle that the Lord promised to put in the path of the righteous man who had turned aside to sin was the warning that Ezekiel should provide.

"The saint needs the watchman's warnings as much as the sinner does."¹⁰⁶

3:21 On the other hand, if Ezekiel warned a righteous person and he heeded the warning, he would live, and Ezekiel would be free of any guilt before the Lord.

"The duties of Habakkuk (Hab. 2:1), Jeremiah (Jer. 6:17), and Isaiah (Isa. 56:10) were far more national and corporate than individual. Ezekiel realized that from that time on his would be a mission mainly to individuals."¹⁰⁷

"The responsibility of a believer in Christ today to share the word of life, salvation, and forgiveness is no less awesome. Once the message of salvation is entrusted to us, we are responsible and accountable to share with those who are lost."¹⁰⁸

The Mosaic Law promised life for obedience and death for disobedience. This was physical life and physical death, not eternal life and death. The Lord gave the Mosaic Law to a people who had already entered into relationship with Himself by faith (cf. Lev. 18:5; Deut. 4:37-40; 6; 7:6-11; 10:15-17; 30:15-20; see also Exod. 19:8; 24:3, 7; Deut. 5:27). The possibility here is premature physical death or extended physical life. Eternal life and eternal security are not the issues.¹⁰⁹

¹⁰⁶Taylor, p. 69.

¹⁰⁷Feinberg, p. 29.

¹⁰⁸Cooper, p. 86.

¹⁰⁹See Alexander, "Ezekiel," p. 766; M. Tsevat, "Studies in the Book of Samuel I," *Hebrew Union College Annual* 32 (1961):191-216; Dyer, "Ezekiel," p. 1233.

6. Ezekiel's muteness 3:22-27

3:22 While Ezekiel was among the exiles in Tel-abib, the Lord directed him to go out to the nearby plain where the Lord promised to speak with him (cf. ch. 1; Acts 9:6; Gal. 1:16-17).

3:23 Ezekiel obeyed the Lord. While he was standing on the plain, he saw another vision of God's glory and again prostrated himself on the ground (cf. 1:28; Acts 7:55).

3:24 The Spirit then strengthened Ezekiel to stand up, and the Lord instructed him to go back to his house and shut himself up in it.

"For a sovereign to invite a suppliant to stand meant that he at least was willing to do business with him."¹¹⁰

3:25 The Jews were going to bind Ezekiel with ropes so he would not be able to circulate among them. There is no further mention in the book of Ezekiel's being bound in his house with ropes. Consequently this may be a contingent statement: if the prophet would not restrict himself to his house, God would use others to confine him there.¹¹¹ Another explanation, which I prefer, is that binding with ropes here is a figurative expression meaning confining; God would keep him at home, though not necessarily by using physical ropes (cf. 4:8).¹¹²

"The Jewish people 'bound' Ezekiel in the sense that their sins made it necessary for him to remain home in silence until God gave him a message."¹¹³

Perhaps some Israelites bound him for a while even though the text made no further reference to it.¹¹⁴

3:26 The Lord would make Ezekiel unable to speak or to rebuke the people because they were rebellious against the Lord. The prophet's silence would be their punishment; he would not be able to warn them of judgment that the Lord would bring on them.¹¹⁵ Ezekiel could have given them many more warnings than he did.

Some of the more radical commentators believed that Ezekiel suffered from catalepsy or some other serious nervous disorder, but the text does not require this. Catalepsy is a condition in which consciousness and

¹¹⁰Stuart, p. 50.

¹¹¹Dyer, "Ezekiel," p. 1233.

¹¹²C. F. Keil, *Biblical Commentary on the Prophecies of Ezekiel*, 1:65; Feinberg, p. 30.

¹¹³Wiersbe, p. 170.

¹¹⁴Greenberg, p. 102; Wevers, p. 58; Allen, p. 61, Alexander, *Ezekiel*, p. 18.

¹¹⁵See Allen A. MacRae, "The Key to Ezekiel's First Thirty Chapters," *Bibliotheca Sacra* 122:487 (July 1965):227-33.

feeling are suddenly and temporarily lost, and the muscles become rigid. It may occur in epilepsy, schizophrenia, and some other diseases. The prophet's unusual experiences were the result of spiritual factors, not because he was psychologically unbalanced.

3:27 Finally the Lord would enable Ezekiel to speak again. He would announce a message from the Lord. Some of his hearers would listen, but others of them would refuse to listen because they were rebels against the Lord. Nevertheless, regardless of their response, the hearers would be personally responsible for their response (cf. Matt. 11:15; 13:10-17; Rev. 2:7; 13:9; 22:11; et al.).

Evidently Ezekiel's muteness lasted for several years, until the fall of Jerusalem (cf. 1:1-3; 24:25-27; 33:21-22).¹¹⁶ He was not entirely silent during this several-year period, from the present until Jerusalem fell, but he only spoke to the people when God gave him special messages to deliver (cf. 11:25; 14:1; 20:1). Rather than speaking publicly from time to time as he lived among the people, as other prophets normally did, Ezekiel remained at home except to deliver special messages from the Lord (cf. chs. 4—5). Thus Ezekiel spoke less publicly and led a more reclusive life than the Lord's other prophetic spokesmen. Another view is that Ezekiel's period of silence ended with the conclusion of his commissioning.¹¹⁷

"From that moment onwards, Ezekiel was to be known as nothing but the mouthpiece of Yahweh. When he spoke, it was because God had something to say; when he was silent, it was because God was silent."¹¹⁸

"His speech is to be intermittent and limited to judgment oracles."¹¹⁹

"Ezekiel . . . has to experience the inability to speak . . . as a forceful experiential reminder of the fact that he has no authority to make up on his own what he says to his fellow Israelites. Rather, only God can, as it were, loose his tongue. He must let God speak through him, and not invent anything himself or take his message from anyone else. Originality is usually prized among writers and speakers. Yet there was to be no originality in Ezekiel's doctrine. In all five commissions [2:1—3:27] he is reminded that his job is to convey and not to create."¹²⁰

Christians have the same duty (Matt. 28:19-20).

¹¹⁶Block, *The Book . . .*, p. 151.

¹¹⁷Chisholm, p. 235.

¹¹⁸Taylor, p. 74.

¹¹⁹Allen, p. 63.

¹²⁰Stuart, p. 37.

II. ORACLES OF JUDGMENT ON JUDAH AND JERUSALEM FOR SIN CHS.

4—24

This section of the book contains prophecies that Ezekiel delivered from the beginning of his ministry (in 593 B.C.) to the fall of Jerusalem (586 B.C.). All of these prophecies deal with the coming destruction of the city and related calamities.

"Here begin Ezekiel's prophecies directed toward others than himself."¹²¹

". . . Ezekiel's messages of doom are evidently intended to dismantle official Jerusalemite theology by systematically undermining the four pillars upon which Judah's (false) sense of security was built: 1. Yahweh's covenant with Israel . . . (cf. 12:17—16:63; 18:1-32; 20:1-44; 22:1—24:14). 2. Yahweh's commitment to his land . . . (6:1—7:27; 21:1-23 [Eng. 20:45—21:17]). 3. Yahweh's commitment to Jerusalem . . . (4:1—5:17 . . . 8:1—11:25). 4. Yahweh's covenant with David . . . (12:1-16; 17:1-24; 19:1-14)."¹²²

A. EZEKIEL'S INITIAL WARNINGS CHS. 4—7

In this section, Ezekiel grouped several symbolic acts that pictured the destruction of Jerusalem (4:1—5:4) and several discourses that he delivered on the subject of Jerusalem's destruction (5:5—7:27). Most of the exiles believed that the Jews who had gone into captivity would return to the Promised Land soon and that God would not allow the Babylonians to destroy Jerusalem and the temple. Ezekiel presented a very different picture of the future.

1. Dramatizations of the siege of Jerusalem chs. 4—5

The Lord had shut Ezekiel's mouth (3:26), so the first prophecies he delivered were not spoken messages but acted-out parables (cf. 1 Kings 11:30; 22:11; 2 Kings 13:17; Isa. 20:2-4; Jer. 13:1-14; 19:1-10; Acts 21:10-11). Ezekiel evidently appeared somewhat like a mime doing street theater as he dramatized a message without speaking a word.

"The symbolic actions during the prophet's inability to speak were testimonies to the past wickedness and chastisement of the house of Israel (the whole nation), and prophetic of a coming siege. They are therefore intermediate between the siege of 2 Ki. 24:10-16, at which time Ezekiel was carried to Babylon, and the siege of 2 Ki. 25:1-11, eleven years later."¹²³

The brick and the plate 4:1-3

4:1-2 The Lord instructed Ezekiel to construct a model of Jerusalem under siege. He was to build a model of the city using a clay brick (Heb. *lebenah*) to represent Jerusalem. The Hebrew word for "brick" describes both clay

¹²¹Ibid., p. 53.

¹²²Block, *The Book . . .*, pp. 162-63. See also p. 8.

¹²³*The New Scofield . . .*, p. 841.

tablets on which people wrote private correspondence, official documents, and other data, as well as common building bricks (cf. Gen. 11:3). It is not clear exactly which type Ezekiel used. In either case, he built a model of the siege of Jerusalem with enemy siege-works, an earth ramp, camps of soldiers, and battering rams, much like a small boy uses toy soldiers and models of tanks and buildings to play war today. It is not clear either whether the whole model fit on the brick or whether the brick just represented the city of Jerusalem. I tend to think the brick represented Jerusalem and Ezekiel built other models that he placed around it. The outline of Jerusalem would have been distinctive and easily recognizable by Ezekiel's audience, and he may even have labeled the brick as Jerusalem.

- 4:3 Then Ezekiel was to place an iron plate between himself and his model of the city and to lay siege to Jerusalem. This was to be a sign to the people of Israel of what God would do to the real Jerusalem (cf. Deut. 28:52-57). The meaning of the iron plate or pan is also debatable, though it appears to have been a common cooking griddle (Heb. *mahabhath*). It may have signified the Babylonian army that made escape from the city impossible,¹²⁴ God's determined hostility against Jerusalem,¹²⁵ the barrier of sin that the Jews had raised between themselves and God,¹²⁶ or Ezekiel's protection as he acted out his drama.¹²⁷ I favor the view that it represented a barrier that existed between the people and God, whom Ezekiel represented, that their sin had erected and that their prayers could not penetrate (cf. Isa. 58:2; Lam. 3:44).

Evidently Ezekiel built this model scene without speaking to his audience or explaining what he was doing, and he probably did it just outside his house (cf. 3:24-25).

"The purpose of God in this prophetic act was hardly limited to letting Ezekiel and his countrymen in on the future. More important was their need to see that God was not about to let the sins of the city He had chosen go unpunished."¹²⁸

Lying on the side 4:4-8

- 4:4-5 Then Ezekiel was to recline in public on his left side for 390 days. This was to represent the number of years that Israel would have to bear punishment for her sins. Evidently when Ezekiel lay on his left side he faced north, the Northern Kingdom. This meant that his body would have been pointing west, toward Jerusalem.

¹²⁴Alexander, "Ezekiel," p. 769; Feinberg, p. 33; Cooper, p. 94.

¹²⁵Ibid.; Taylor, p. 76.

¹²⁶Dyer, "Ezekiel," p. 1235.

¹²⁷Alexander, "Ezekiel," p. 769.

¹²⁸Stuart, p. 55.

4:6-7 After the 390 days had expired, he was to lie on his right side for an additional 40 days. This was to represent the number of additional years the Southern Kingdom of Judah would have to suffer punishment for her sins. He was to face Jerusalem with his arm bared signifying Yahweh's hostility toward His people. The prophesying that he was to do against Jerusalem (v. 7) was by means of this skit. The Septuagint has Ezekiel lying on his left side for 190 days and on his right side for 150 days, but the reason for these periods is unknown.

That these days represented years of divine punishment seems clear (v. 6), but what years are in view is a problem. Were they literal or figurative years, and were these years in the past or in the future? Unless they were literal years we have no way of knowing what they represented. If they were future years and began with the year of Jehoiachin's deportation (597 B.C.), which is the date of reference that Ezekiel used throughout his book, the total 430 years would have ended about 167 B.C. This was the year of the Maccabean rebellion when the Jews began to throw off their foreign oppressors, the Syrians, and took control of their own affairs once again.¹²⁹ But why God divided these years into two such unusual segments remains a mystery. I think the 430 days may have been the total length of the siege of Jerusalem, which God viewed as punishment for 390 years of the Northern Kingdom's sins and 40 more years of the Southern Kingdom's sins. The fact that the length of time the Israelites were in Egypt was 430 years (Exod. 12:40) may have reminded Ezekiel's audience of that former captivity. Likewise Israel's 40 years in the wilderness has a parallel in this prophecy. In this case the years of sin would have been in the past.¹³⁰ Other views are that the 430 days represented the years of the monarchy, or the years Solomon's temple stood. It still remains difficult, however, to explain exactly which 390 and 40 years God had in mind.¹³¹ Perhaps they were the worst years of sin. In some way the length of the siege corresponded to the past years of Israel and Judah's sin.

4:8 The Lord promised to help Ezekiel lie on his sides by restraining his movements, as though ropes bound him in his positions. Some interpreters believed that God had someone bind Ezekiel with ropes each day, but I do not think the text requires this. Again, it appears that the prophet acted out his drama for only a few hours each day, and it was during this time that God enabled him to lie quietly.

"God's judgment of sin is inevitable. He is longsuffering (4:1-8) and may wait for years, but ultimately he will dispense judgment. This judgment will include his people."¹³²

¹²⁹Alexander, "Ezekiel," p. 770; Cooper, p. 95.

¹³⁰Dyer, "Ezekiel," pp. 1235-36.

¹³¹See Allen, p. 66.

¹³²Cooper, p. 95.

"God's servants may have to undertake tasks involving a lot of tedium, patiently carrying out responsibilities less than entirely pleasant, regularly doing things they would much rather not have to be involved in. Preparing for a Sunday school class week after week, leading a Bible study year by year, visiting shut-ins steadily as time goes by, patiently shaping the behavior of and caring for children as the years come and go, laboring to bring about social change; these sorts of things are hardly always enjoyable. Faithfulness involves sticking to tasks where the reward cannot necessarily be experienced right away. Loyal Christian servants may not see in this life the rewards of their steady labors, but we carry on because God's work is never done in vain, no matter how hard it may be (1 Cor. 15:58)."¹³³

The food 4:9-17

This second dramatization took place while Ezekiel was acting out the first 390 days of the siege of Jerusalem with the brick and the plate (vv. 1-8). Whereas the main drama pictured the siege as a judgment from God, this aspect of it stressed the severe conditions that would exist in the city during the siege.

4:9-11 The prophet was also to make provisions so that he would have adequate food to eat and water to drink as he lay on his side for the first 390 days. The Lord prescribed just what and how much he should consume each day: one and one-third pints of water and eight ounces of bread. These were famine rations. His bread was to be a combination of six grains rather than just one, similar to how people during a siege would have to make their bread. They would mix small amounts of whatever they could find rather than using larger quantities of a single grain.

In a grocery store where I shop, I can buy "Ezekiel Bread" that is made of the ingredients mentioned in verse 9.

Ezekiel may have eaten at other times of the day when he was not acting out his drama, but during his dramatic presentation each day he only ate and drank as people under siege in Jerusalem would do.

4:12-15 Ezekiel was to bake his food over a fire made with human excrement, as the Jews under siege in Jerusalem would have to do. The uncleanness of their food did not represent the type of food they would have to eat but the fact that they would have to eat their food among defiled people (in captivity, v. 13). The prophet complained that he had never eaten unclean food (cf. 44:31; Lev. 22:8; Deut. 12:15-19; 14:21; 23:9-14), so the Lord graciously allowed him to prepare his food over a fire made with cow's dung rather than human feces.

¹³³Stuart, p. 59.

Ezekiel could not have been lying on his side continuously all day because he prepared meals during some of this time. In parts of the Middle East today, some people still use dried animal dung as fuel due to the scarcity of wood.¹³⁴ God acceded to Ezekiel's request to substitute animal dung for human feces because the prophet wished to preserve his own purity and because the use of human waste, though more realistic, was not essential to the lesson Ezekiel was to teach the people (cf. Acts 10:14-15).

". . . God was not so much trying to get Ezekiel to violate his own priestly responsibilities as to be reminded of how many compromises of what is usual and normal would have to be made by those cooped up in Jerusalem under overwhelming enemy pressure."¹³⁵

4:16-17 All these conditions were to symbolize how people back in Jerusalem were going to have to eat to live during the siege. They would have to eat sparingly because the famine caused by the siege would be severe.

The hair 5:1-4

Ezekiel was also to do something else during the time he was dramatizing the siege of Jerusalem with his model (ch. 4).

"After Ezekiel represented the *fact* of the siege (first sign [4:1-3]), the *length* of the siege (second sign [4:4-8]), and its *severity* (third sign [4:9-17]), he demonstrated the *results* of the siege (fourth sign [5:1-4])."¹³⁶

5:1-2 The prophet was to shave the hair of his head and beard with a sword symbolizing the defilement and humiliation that would come on Jerusalem because of her sin. Shaving the head and beard was forbidden for Israelites in their law (Deut. 14:1). It was a pagan practice that expressed great grief and humiliation (cf. 9:3; 27:31; 2 Sam. 10:4-5; Isa. 15:2; 22:12; Jer. 16:6; 41:5-6; 48:37; Amos 8:10). If an Israelite priest shaved his head, he was defiled and no longer holy to the Lord (Lev. 21:5-6). Thus Ezekiel's action pictured the unclean condition of Israel before the Lord as well as its removal in judgment by Babylon's king (cf. Isa. 7:20).

Then Ezekiel was to divide his cut hair using a scale to measure it in three equal piles. Weighing symbolized discriminating evaluation and impending judgment (cf. Prov. 21:2; Jer. 15:2; Dan. 5:27). When the days of the siege were over, after 430 days (4:5-6), he was to burn one-third of the hair in the center of the model of Jerusalem that he had built with the brick (4:1). He should chop up another third of the hair with his sword

¹³⁴S. Fisch, *Ezekiel*, pp. 22-23; D. M. G. Stalker, *Ezekiel*, p. 67.

¹³⁵Stuart, p. 61.

¹³⁶Dyer, "Ezekiel," p. 1236.

outside the model city. The remaining third he was to throw up into the air so the wind would blow it away. This represented the fate of the Jews in Jerusalem during the siege. One third would die in the burning and destruction of the city (cf. 2 Kings 25:9), another third would die at the hand of the Babylonian soldiers outside the city (cf. 2 Kings 25:18-21; 2 Chron. 36:17), and one third would go into captivity (cf. 2 Kings 25:11, 21) driven by soldiers that Yahweh would send after them.

5:3-4 Ezekiel was also to take a few hairs from the last group and hide them in the edge of his robe symbolizing the remnant that the Lord would preserve in captivity. Still other hairs he was to throw into the fire representing the fact that the Lord would judge the whole house of Israel. The fire of judgment that would burn in Jerusalem would spread to judge the whole population of Jews.

The interpretation of these acts 5:5-17

Evidently Ezekiel's verbal explanation of this drama came at the very end of the drama, at the time of the real destruction of Jerusalem. Ezekiel was no longer silent then.

5:5-6 The Lord explained that the center of the drama was Jerusalem that He had set at the center of many nations and lands. Some in Ezekiel's audience undoubtedly hoped that the city under symbolic destruction was Babylon, but it was indeed Jerusalem. It was at the center of civilization geographically and theologically. Some rabbinic writers, early church fathers, and medieval cartographers concluded from this passage that Jerusalem was the "navel of the earth" (cf. 38:12).¹³⁷

"God intended for Israel to be the great monotheistic missionary to the nations of the ancient world . . ." ¹³⁸

But this blessed city had rebelled against Yahweh by being unfaithful to the Mosaic Covenant.

"Although others could freely interchange the name of Zion with Jerusalem, this is impossible for Ezekiel, who avoids the theologically charged designation altogether. As chs. 8—11 demonstrate, for this prophet Jerusalem has ceased to be the residence of God; Zion was no more. The city's privileged status among the nations had been forfeited." ¹³⁹

5:7-8 The Lord promised to judge Jerusalem in the sight of the other nations because she had been so unfaithful and rebellious. She had not even observed the common laws that her neighbors obeyed.

¹³⁷See Taylor, p. 86, n. 1.

¹³⁸Feinberg, p. 37.

¹³⁹Block, *The Book . . .*, p. 198.

- 5:9-10 The Lord would punish Jerusalem uniquely for her sins. Father's would eat their own sons, and sons their fathers, in the siege (cf. Lev. 26:29; Deut. 28:53; 2 Kings 6:28-29; Jer. 19:9; Lam. 4:10). Yahweh would scatter most of the surviving remnant from the Promised Land.
- 5:11-12 The Lord affirmed that He would withdraw His presence from His people because they had defiled His temple with idols (cf. ch. 8; 10:4; 11:22-23). The clause "as I live" expresses a very solemn oath. It appears 14 times in Ezekiel, more often than in any other prophetic book. God would not have pity on them. One third of the residents would die by plague or famine, another third by the sword, and another third would scatter from the land driven by enemy soldiers.
- 5:13 These judgments would satisfy the Lord's anger against His people and would convince them of His wrath because of their sins.
- "The final statement in v. 13 is the key to the chapter, if not to Ezekiel's prophetic ministry as a whole."¹⁴⁰
- 5:14-15 The Lord would desolate the people and make them an abhorrence to the observing nations. They would revile the Jews and use them as a warning of the consequences of covenant unfaithfulness, Yahweh promised.
- 5:16-17 The Lord would send famine-like arrows against His people to destroy them. Also wild beasts, plague, hemorrhage (associated with disease) or possibly cannibalism,¹⁴¹ and war would be His instruments to judge them (cf. Lev. 26:21-26). These are standard curses for covenant unfaithfulness referred to frequently in the Mosaic Law (e.g., Lev. 26:22, 26, 29; Deut. 28:21, 53-56; 32:23-25, 42; cf. Lam. 1:7-14; 2:20-22; 4:4—10). All this Yahweh solemnly promised to do.

"The categorical imperative that rested on Ezekiel to carry out this task of watchman is reminiscent of that of Paul to 'warn everyone and teach everyone' (Col 1:24-29, esp. v 28). This imperative, both prophetic and apostolic, underscores the need for God's people to covet a strong sense of his will in matters of their own hearts and habits."¹⁴²

2. The judgment coming on Judah chs. 6—7

The Lord commanded Ezekiel to announce prophetic messages to the Jews in captivity after his time of imposed silence ended (cf. 3:26-27). In these messages the prophet elaborated some of the symbols he introduced in chapter 5. The first message dealt with the cause of the judgment, namely, idolatry (ch. 6), and the second with the nature of the judgment (ch. 7).

¹⁴⁰Ibid., p. 211.

¹⁴¹Ibid., p. 215.

¹⁴²Allen, p. 80.

The destruction of pagan shrines ch. 6

". . . the focus of chap. 6 is on the individual responsibility of the people and prepares the way for the subsequent spoken messages."¹⁴³

6:1-2 The Lord directed Ezekiel to pronounce an oracle of judgment against "the mountains of Israel." This phrase occurs 17 times in Ezekiel and nowhere else in the Old Testament. In 36:1-15 Ezekiel prophesied a message of restoration to these mountains. The mountains of Israel, which run the entire length of the country from north to south, represent the whole land of Israel, especially Jerusalem, which sits on the central watershed ridge. By contrast, Babylonia was very flat. Specifically, the mountains of Israel also stand for the centers of pagan worship where the Israelites practiced idolatry. The expression "set your face toward" always means to turn toward something with hostile intentions in all 14 of its occurrences in Ezekiel.

"If the practice of turning to Jerusalem for prayer was already catching on among the exiles (*cf.* Dn. 6:10), there would be particular irony in his [Ezekiel's] doing this in an act of condemnation."¹⁴⁴

6:3-7 Ezekiel was to announce to his audience of exiles that God would bring warriors against Israel's mountains, hills, ravines, and valleys, namely, the places where the people worshipped at pagan shrines (*cf.* 2 Kings 23:10). The object of His judgment would be the high places of worship that stood throughout the land.¹⁴⁵ God would destroy the altars, and the people who worshipped before them would fall slain around them. The idols would not be able to defend their worshippers. The Lord would defile these altars with the bones of the Israelites who died before them (*cf.* Lev. 26:30; 2 Kings 23:20; Ps. 53:5; 141:7; Jer. 8:1-2). Scattered animal bones often marked these places of sacrifice, but human bones would pollute them in the future. Pagan altars of all types that the people had built would be broken down throughout the country along with the cities. Many people would die, and God's people would know that He had judged them.

"Judgment is a pervasive theme of all the prophets of Israel, but none exceeds Ezekiel in the abundance and intensity of his messages of divine retribution. Moreover, none reiterates as much as Ezekiel the pedagogical purposes of the visitations of the Lord: 'that they [Israel and the nations] might know Yahweh.' Judgment, then, is not only

¹⁴³Cooper, p. 106. Allen, pp. 92-96, provided an excursus on and a chart of the parallels between Leviticus 26 and Ezekiel 4—6.

¹⁴⁴Taylor, p. 89.

¹⁴⁵See Dyer, "Ezekiel," p. 1238, for a brief history of the high places in Canaan.

retributive but redemptive. God's purpose in judgment is not to destroy the peoples He has created but to bring them back into harmony with His creation purposes for them."¹⁴⁶

6:8-10 The Lord would leave a remnant alive, however, when He brought this judgment and scattered His people in captivity. They would despise themselves when they remembered how their adulterous hearts and lustful eyes had hurt their Lord. The Hebrew word *gillulim*, translated "idols," literally means "dung-gods." This word occurs 38 times in Ezekiel and only nine times elsewhere in the Old Testament. The remnant would remember that the Lord's promised judgments for their sins were not vain (cf. v. 7).

"What idolatry most reveals about the people who practice it is not merely another faith, but also an actual lack of faith. Modern idolatry, like the ancient Israelite-Near Eastern kind, is essentially materialistic (1 John 2:15-17; 5:21). Instead of full reliance on God, while we may not deny His existence, we don't trust Him to take care of us materially. Thus we do everything we can to gain worldly possessions, to secure our future, to have a 'comfortable' retirement, to succeed in a competitive world. With this comes the danger of 'losing our own souls' because we cannot serve God and money (Matt. 6:24). When we fail to trust God for our needs, we go far beyond the bounds of providing for our basic requirements and can thus trap ourselves in modern idolatry, which is nothing other than materialism (1 Tim. 6:6-10)."¹⁴⁷

6:11-14 The people and Ezekiel were to express derision that the sword, famine, and plague (cf. 5:1-3, 12; Rev. 6:4-8) would come and judge these evil abominations (cf. 21:14-17; 22:13; 25:6; Lam. 2:15; Nah. 3:19). These three instruments of judgment, summarizing the full range of divine punishment (cf. 2 Sam. 24:13; Jer. 27:13; 29:17), would affect various parts of the people and touch them all. The people would recognize Yahweh at work in judgment when they observed so many Judahites slain beside their pagan places of worship. He would make the land of Judah more desolate than the wilderness near Diblah. "Diblah" appears only here in the Old Testament. It may be a variation of "Riblah," the border town near Hamath where the Babylonian soldiers took King Zedekiah (2 Kings 25:5-7; Jer. 39:6-7; 52:8-11, 26-27). The Hebrew letters for "d" and "r" are very similar in shape. The purpose of God's judgment was to restore the people to their proper relationship with Him (vv. 7, 10, 13, 14). The expression "they will know that I am Yahweh" appears about 65 times in Ezekiel and was one of the major purposes of God for His apostate people.

¹⁴⁶Merrill, p. 372.

¹⁴⁷Stuart, p. 72.

"In every generation God's judgment and discipline is misunderstood by most people. God's chief desire is to bring people to himself—or back to himself. When mankind willfully refuses to turn to him, God mercifully uses discipline and judgment to cause the people to recognize that *he is the only true God*, always faithful to what he has said in his word!"¹⁴⁸

The destruction of the whole land ch. 7

This chapter, like the previous one, probably contains several separate oracles. Together they make up a lamentation. Here the nature of the coming judgment of Jerusalem and Judah receives primary emphasis.

"There are six parts to this summary message. First, God's determination to bring judgment is announced (7:1-4). Second is the repeated call for judgment to come (7:5-9). Third, the imminence and certainty of judgment is announced (7:10-13). Fourth, the total destruction of the nation is announced (7:14-18). Fifth, the uselessness of all physical resources is declared (7:19-22). Sixth, the fall of Jerusalem is announced (7:23-27)."¹⁴⁹

- 7:1 The Lord's word came to Ezekiel again (cf. 6:1). This verse serves as a heading for the oracles that make up the rest of the chapter.
- 7:2-4 Yahweh announced that He was bringing an end on the whole land of Israel and that it was coming soon. This judgment would come because the Lord was angry with His people for their abominable sins. He would not restrain His punishment but would bring the consequences of their sins on them. They would go into a land where the abominations they had lusted after would make them sick. Then they would know that Yahweh was the true God (cf. vv. 9, 27; 6:7, 10, 13, 14). The recurrence of several identical words emphasizes the certainty of this coming judgment as well as its extent and basis.

"The fact that the message needed so much reiteration can only be understood against the background of popular belief in the inviolability of Jerusalem. Its destruction was inconceivable to the Israelite mind. As long as God was God, God's Temple and God's city would stand. This had been the message of Isaiah when kings of Judah had feared for the city's safety and were toying with the idea of turning to heathen armies for assistance. But now the situation was different. Isaiah's confidence could no longer be justified after 150 years of increasing apostasy. The people were

¹⁴⁸Alexander, "Ezekiel," p. 775.

¹⁴⁹Cooper, p. 110.

living in the past, but God was judging the present. His verdict was that the end was imminent."¹⁵⁰

7:5-9 The Lord again revealed that a unique disaster was coming. It would be an end for the Israelites, and it was near. Their doom would soon arrive as a tumult on the mountains, not as a joyful sound. The Lord was about to judge His people for all their abominations. He would show no pity. They would then know that He was the Lord. This oracle stresses the horror and surprise of the coming judgment as well as the person judging. The last phrase is a new name for God: *Yahweh makkeh*, "the Lord who strikes."

"To hearers and readers who were used to names of God like 'Jehovah-jireh' and 'Jehovah-nissi' (Gn. 22:14; Ex. 17:15), it must have come home with tremendous force to have Him described as 'Jehovah-makkeh'. The Lord who had provided and protected was about to strike."¹⁵¹

7:10-13 The Lord announced that the day of Israel's doom was coming. Judgment was about to break forth as buds on a branch (cf. Num. 17:8; Jer. 1:11-12). The people's violence had grown from a small shoot into a stout branch of wickedness. Nebuchadnezzar would prove to be the rod of God's judgment. No eminent individuals and nothing of much value would remain. The time of judgment was so near that both buyers and sellers should refrain from their usual pursuits.

"The buyer who normally rejoiced over a good business deal should not be happy because he would not be able to possess the land he had purchased. And one forced to sell his land should not grieve because he would have lost it anyway."¹⁵²

It would be impossible for sellers to regain (by redemption or in a sabbatical or jubilee year) what they sold because everything would be swept away before a change could be made (cf. 1 Cor. 7:29-31). Even iniquity would not change the prospect of coming judgment.

"Hardening oneself in sin would not accomplish immunity from punishment."¹⁵³

This pericope may be one or two oracles (vv. 10-11, 12-13). The first two verses stress the imminence, comprehensiveness, and readiness of the judgment, and the last two its permanence and suddenness.

¹⁵⁰Taylor, p. 92.

¹⁵¹Ibid., p. 93.

¹⁵²Dyer, "Ezekiel," p. 1241.

¹⁵³Feinberg, p. 46.

"It is amazing how easily messages of judgment are forgotten. These messages constantly must be reinforced."¹⁵⁴

The last half of this chapter emphasizes the Judeans' reactions to the coming judgment.

7:14-18 The Israelites had prepared to fight the Babylonians, but they would not be successful because the Lord Himself would fight against His people. The sword would devour those outside Jerusalem, and plague and famine would consume those within. Even the few survivors who escaped would mourn their desperate condition. Everyone would lose heart, and traditional signs of mourning would be everywhere. Ancient Near Easterners wore rough camel's hair clothing (sackcloth) to make themselves miserable and so keep thoughts of selfish enjoyment aside.

"The prophet is hereby [v. 17] referring to the loss of bladder control that occurs in a moment of extreme crisis [when he says, literally, "All knees will run with water"]."¹⁵⁵

7:19-22 Valuables and food would mean very little then because all that would concern the people would be remaining alive. Money cannot buy food when food is not there. The people had become proud over the glorious splendor of Jerusalem and the temple and, as the height of arrogance, had used some of the temple treasures to make idols. Therefore the Lord would make the temple an abhorrent thing to them and would turn it over to their enemies who would profane it (cf. Dan. 5:3-4).

"Since Israel had already profaned the temple of God, He saw no further purpose in keeping it from the desecration of the enemy."¹⁵⁶

The Lord would turn away from His people then.

7:23-27 It was time to make the chain that would bind the Israelites and carry them off to captivity because Judah and Jerusalem had become places of violent crime. Some interpreters believed God commanded Ezekiel to make a literal chain and that this was another symbolic act.¹⁵⁷ The Lord would bring the worst of nations against His people, and they would take over the Judahites' homes (cf. Lev. 26:31-32; Deut. 28:49-57). The pride of the powerful Judahites would end, and their enemies would profane their holy places. They would not be able to escape anguish, and things would go

¹⁵⁴Cooper, p. 112.

¹⁵⁵Block, *The Book . . .*, p. 261.

¹⁵⁶Feinberg, p. 47.

¹⁵⁷Ibid.

from bad to worse for them. No one would be able to obtain guidance from the Lord—the prophets by receiving revelations, the priests by studying the law, or the elders by appealing to history. Everyone from king to common citizen would shake with terror. The Lord would punish His people in keeping with how they had sinned, and they would know that He was the Lord.

"This is a frightening chapter. It consists of a group of poetic oracles intended to convince Ezekiel's fellow hostages in the Babylonian heartland that their hopes of returning soon to their homes and families in far-off Judah would not materialize."¹⁵⁸

B. THE VISION OF THE DEPARTURE OF YAHWEH'S GLORY CHS. 8—11

These chapters all concern one vision that Ezekiel received, which the chiasmic structure of this section reinforces.¹⁵⁹ Chapter 8 exposes the abominable idolatry of the people of Jerusalem, and chapters 9—11 describe God's judgment on this idolatry.

"Ezekiel was first confronted with the wickedness of the people in the temple (chap. 8); then he was shown the slaughter of the people of Jerusalem (chap. 9). Jerusalem was so wicked that God's glory departed from the temple (chap. 10), and as it left the city, judgment was pronounced on her rulers (chap. 11)."¹⁶⁰

1. The idolatry of the house of Israel ch. 8

This chapter contrasts the glory of God with the idolatry of Judah's leadership and citizens back in Jerusalem.

"The purpose of the visions of chapter 8 was twofold: to show the Jews in Babylon the righteous judgment of God upon His people for their sins and to forewarn that continuance in these outrages would result in a final and complete exile of Israel from the promised land. The present chapter amplifies the reason for the threatenings found in 7:20-22."¹⁶¹

The image of jealousy 8:1-6

8:1 The following prophecy came to Ezekiel on September 17 or 18, 592 B.C. as he was sitting in his house with the elders of Israel.¹⁶² This would have been during the time when he was lying on his right side for part of the

¹⁵⁸Allen, p. 112.

¹⁵⁹See Block, *The Book . . .*, p. 272, for a diagram of the chiasm.

¹⁶⁰Dyer, "Ezekiel," p. 1242.

¹⁶¹Feinberg, p. 49.

¹⁶²Parker and Dubberstein, p. 28, dated it on September 17, 592 B.C. Taylor, p. 36; W. Zimmerli, *Ezekiel I*, p. 236; and Greenberg, p. 166, dated it on September 18.

day dramatizing God's judgment on Judah for her iniquity (cf. 1:1-3; 3:16; 4:4-8). The elders were the leaders of the Judean exiles in Babylonia who had been deported in 605 and 597 B.C. This verse describes the single vision that Ezekiel wrote about in chapters 8—11.

- 8:2 Ezekiel had another vision of God. The description of God is the same as what the prophet wrote that he saw by the river Chebar (1:27). The description of God stresses His holiness.
- 8:3 In his vision Ezekiel saw God reach out and pick him up by his hair and transport him to Jerusalem by the Spirit. The Lord placed him down at the north gate of the inner court of the temple where there was an image of an idol (cf. Deut. 4:16). King Jotham (750-732 B.C.) had built this gate, which apparently did not exist when Solomon first constructed the temple (2 Kings 15:35). Other names for it were the upper Benjamin gate (Jer. 20:2), the new gate (Jer. 26:10; 36:10), the altar gate (Ezek. 8:5), and the upper gate (2 Kings 15:35; Ezek. 9:2). This idol provoked the Lord to jealousy.

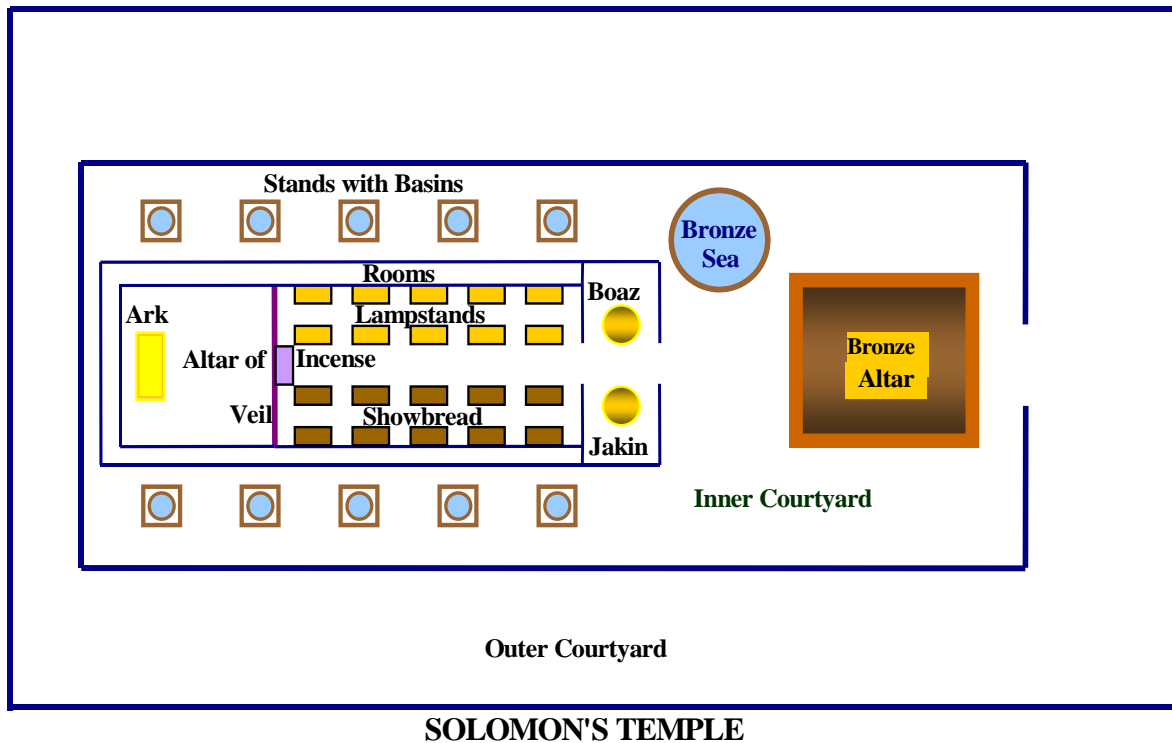

- 8:4 The prophet also saw the glory of the Lord manifested there, as he had seen it in his initial vision of God (1:28). The glory of God sets the idolatry of the people, which Ezekiel next saw in more detail, in striking contrast.

- 8:5 At the Lord's command, Ezekiel looked north from where he was in his vision and saw the idol that provoked the Lord to jealousy north of the north entrance into the inner court of the temple near the bronze altar of burnt offerings. Many expositors believe that this may have been an image of Asherah because King Manasseh had erected such an idol and then destroyed it (2 Kings 21:3, 7; 2 Chron. 33:15), and King Josiah had destroyed a later rebuilt version of it (2 Kings 23:6). The people could have raised it up again after Josiah's death. Any idol provoked the Lord to jealousy because He is the only true God (cf. Exod. 20:1-4; Deut. 4:23-24). God is jealous in the sense that He does not want people to pursue idols because idols divert people from the true God and destroy them eventually (cf. Deut. 4:16; 32:16; 1 Kings 14:22; Ps. 78:58).
- 8:6 The Lord asked Ezekiel if he saw the great abominations that the people were practicing in Jerusalem by worshipping this image. It was so bad that the Lord had removed Himself from His temple. Yet He told the prophet that he would see worse abominations than this one.

The idolatry of the elders 8:7-13

- 8:7-8 The Lord then brought Ezekiel, in his vision, to some entrance to the temple courtyard. There Ezekiel saw a hole in the wall. At the Lord's command, Ezekiel dug in the wall and discovered an entrance.
- There are no other references to a solid wall between the outer and inner courtyards of Solomon's temple much less to a room or rooms within that wall. Visionary experiences frequently did not correspond to reality in every particular, and this may be one example of this phenomenon. Perhaps what Ezekiel saw was a wall of the temple proper.
- 8:9-10 Also following the Lord's instructions, Ezekiel went through the entrance and found himself in a chamber full of images carved on the wall that the Judahites were worshipping. There were pictures of many types of insects, animals, and other detestable things (cf. Lev. 11:40-42; Deut. 4:16-19).
- 8:11 Ezekiel also saw 70 of the elders of Israel (cf. Num. 11:16-17), including Jaazaniah (lit. "Yahweh hears") the son of Shaphan, with censers containing burning incense in their hands worshipping these images (cf. Rom. 1:23). These "laymen" were acting like priests. Jaazaniah appears to have been the son of Josiah's godly Secretary of State, Shaphan (cf. 2 Kings 22:8-14; 2 Chron. 34:15-21; Jer. 26:24; 29:3; 36:10; 40:5, 9, 11; 41:2; 43:6). If so, this would indicate the spiritual deterioration of leadership in Judah. Another of Shaphan's sons, Ahikam, was a defender of Jeremiah (Jer. 26:24).¹⁶³ Some commentators believed that the gods

¹⁶³See the diagram of Shaphan's descendants near my comments on Jeremiah 26:24 in my notes on Jeremiah.

they were worshipping were Egyptian in view of what these gods were and since the men were worshipping in secret.¹⁶⁴ Some of Judah's leaders advocated reliance on Egypt. If they were Egyptian gods, it was ironic that 70 elders of Israel had earlier confirmed the Mosaic Covenant after God delivered them from bondage to the gods of Egypt (Exod. 24:1, 9). Now Israel's leaders appear to have been appealing to those same gods for help against the Babylonians.

8:12-13 The Lord explained that the elders were secretly worshipping idols believing that the Lord did not see them because He had forsaken the land. The terminology used suggests that they were worshipping idols in their homes as well as in the temple precincts.¹⁶⁵

"What people do when they think no one else can see them reveals their true character."¹⁶⁶

Yet the prophet would see even greater abominations than these.

The idolatry of the women 8:14-15

8:14 The Lord then brought Ezekiel to the north entrance to the inner temple courtyard, in his vision (cf. vv. 3, 5). There the prophet saw women weeping for Tammuz (cf. Isa. 17:10-11). Tammuz was an ancient Sumerian and then Akkadian fertility deity, the husband and brother of Ishtar. The Sumerian and Akkadian civilizations preceded the Babylonian civilization in Mesopotamia. Tammuz had ties to the Canaanite Baal and the Greek Adonis and Aphrodite gods.¹⁶⁷ Since Ezekiel saw this vision in September (v. 1), these women may have been weeping for Tammuz because he was thought to die at the end of the summer but to rise again each spring.¹⁶⁸ Another view is that "Tammuz" denotes a special genre of lament.¹⁶⁹

"After the exile the Hebrew calendar included a month called Tammuz, the fourth month (June-July). This was the time for grapes to be harvested. The preservation of the name Tammuz in the calendar suggests the impact this form of pagan worship had on Jewish life and worship, both during and after the exile."¹⁷⁰

¹⁶⁴E.g., Craigie, p. 61; Feinberg, p. 50.

¹⁶⁵Ibid., p. 51; Taylor, p. 99.

¹⁶⁶Cooper, p. 122.

¹⁶⁷See Edwin Yamauchi, "Tammuz and the Bible," *Journal of Biblical Literature* 84 (1965):283-90.

¹⁶⁸See T. Jacobsen, *The Treasures of Darkness*, pp. 25-73.

¹⁶⁹Block, *The Book . . .*, pp. 294-96.

¹⁷⁰Cooper, p. 123.

8:15 The Lord made sure Ezekiel saw the women, but He also assured him that he would see even greater abominations than these things.

The idolatry of the priests 8:16-18

8:16 The Lord next took Ezekiel to the main entrance into the temple, to a place between the altar of burnt offerings and the temple porch. There Ezekiel saw about 25 men bowing down to the ground with their backs to the temple facing east worshipping the sun. The Mosaic Law forbade sun worship (Deut. 4:19), but King Manasseh had promoted it in Judah (2 Kings 21:5).¹⁷¹ Many interpreters assume that these men were priests, perhaps the high priest and a representative of each of the 24 courses of priests (1 Chron. 23), because of their number and where they were standing. Normally only priests went into the inner court of the temple (2 Chron. 4:9; Joel 2:17). This seems likely.

"Worship of the sun was widespread in the ancient Near East and was deeply rooted in Canaan. In Israelite thought the sun was a member of the 'host of heaven,' which was viewed as the Lord's heavenly assembly (compare Deut. 4:19; 17:3; 2 Kings 23:5 with 1 Kings 22:19). This may explain why these men could worship the sun in the Lord's temple."¹⁷²

"The sun would thus have to be considered part of the host of heaven, subordinate to Yahweh. As such one might argue that the worship of the sun in Yahweh's temple would have been seen by those who participated in it as, so to speak, all 'part of the package', just as Catholics would regard veneration (not worship) of Mary as not being incompatible with worship of Christ."¹⁷³

8:17 The Lord explained that not only had the Judahites committed all these abominations but they had also filled the land with violence and provoked Him repeatedly. Putting a twig to the nose was evidently part of the ritual practice of sun worship.¹⁷⁴ Another interpretation views this expression as describing some gross insult against God, something like creating a stench in God's nose.¹⁷⁵ Perhaps both meanings are correct.

¹⁷¹See H. G. May, "Some Aspects of Solar Worship at Jerusalem," *Zeitschrift für die Alttestamentliche Wissenschaft* 55 (1937):269-81.

¹⁷²Chisholm, p. 240. See also Helmer Ringgren, *Religions of the Ancient Near East*, pp. 64-66; Greenberg, p. 171; and Block, *The Book . . .*, pp. 294-96.

¹⁷³John Day, *Yahweh and the Gods and Goddesses of Canaan*, p. 158.

¹⁷⁴See H. W. F. Saggs, "Notes and Studies: The Branch to the Nose," *Journal of Theological Studies* NS11 (October 1960):318-29.

¹⁷⁵Taylor, p. 100. See also Greenberg, pp. 172-73; Zimmerli, pp. 244-45; R. Gordis, "The Branch in the Nose," *Journal of Theological Studies* 37 (1936):284-85; and Block, *The Book . . .*, p. 299.

"The Akkadian expression *appa labana* denotes a gesture of worship involving both hand and nose. Sometimes the hand holds an object to the nose, as in the Bavian sculpture of Sennacherib worshipping the Assyrian gods, in which the object held by the king is perhaps a branch . . ."176

8:18 The Lord promised to deal with the Jerusalemites in His wrath and not to pity or spare them even though they would cry to Him loudly for mercy. He would not listen to them.

We must remember that what Ezekiel saw he saw in a vision (v. 3). Therefore it may not be that the abominations he saw were really taking place in Jerusalem just as he saw them in his vision. The practices he saw represented to him the rampant idolatry of all the people, the civic leaders, the women, and the priests. The exclusive worship of Yahweh had broken down completely in the "holy" city.

"The principle crime of the human race, the highest guilt charged upon the world, the whole procuring cause of judgment, is idolatry."177

2. The coming slaughter of the wicked Jerusalemites ch. 9

9:1 In his vision Ezekiel heard the Lord (cf. v. 4) cry out loudly for the executioners (guards), who would punish the people of Jerusalem, to draw near to Him with their weapons in hand. The Lord had predicted that the people would cry out to Him for mercy with a loud voice (8:18), but first He cried out against them in judgment with a loud voice. Though these executioners looked like men, they appear to have been angels in view of what they proceeded to do. Evidently Ezekiel's position at this time was in the inner temple courtyard, and the Lord spoke from inside the temple structure (cf. v. 3).

9:2 Six men entered the inner courtyard from the north (upper; 8:3, 5, 14) gate each with a lethal weapon in his hand (cf. Jer. 51:20). A seventh man dressed in linen also approached with them, and he had a writing kit of the type that scribes used attached to his waist.

"This writing kit usually was made from an animal horn. It had a palette with a slot for pens and a hollow place for two kinds of ink, usually black and red. Professional scribes usually carried this kind of equipment."178

In other passages people who were divine messengers wore linen (cf. Dan. 10:5; 12:6-7; Rev. 15:6), and this was the role of these men. Priests also wore linen (Exod. 28:39-42; 1 Sam. 2:18; 22:18), and they too were divine

¹⁷⁶Allen, p. 146.

¹⁷⁷Tertullian, "on Idolatry," in *The Ante-Nicene Fathers*, 3:61.

¹⁷⁸Cooper, pp. 126-27. Cf. Allen, p. 147.

messengers. They entered the inner courtyard and stood by the brazen altar. Their number, seven, often signified a complete work of God to the Jews, as in the seven days of creation. These seven would carry out God's work of judgment completely.

- 9:3 Ezekiel then saw the glory of God (probably personified, cf. 8:2) move from the cherub (probably a collective singular for cherubim, the cherubim in the courtyard, 10:3) to the threshold (main entrance) of the temple building.

"The departure of the glory of the Lord from Israel is one of the basic disclosures of this prophetic book, so Ezekiel traces it very carefully in its different stages (cf. 9:3; 10:18-19; [11:23;] 43:2-5)."¹⁷⁹

Ezekiel also heard the Lord call to the man with the scribe's inkhorn.

- 9:4 The Lord instructed this man to go through Jerusalem and put a mark on everyone who expressed grief over the abominations that existed in Jerusalem (cf. Rev. 7:3; 9:4; 14:1). The mark distinguished the godly from the wicked (cf. Exod. 12:7, 13; Josh. 2). Some expositors believed that this individual was the Angel of the Lord, the preincarnate Christ, because of his prominence among these messengers and because of what he did (cf. 10:2, 6-7).¹⁸⁰ There is no way to prove or disprove this theory. Most interpreters believe he was an angel.

"There was special significance to the 'mark' used for the purpose. The word 'mark' is the Hebrew word *taw*, which is the name of the last letter in the Hebrew alphabet. It may have been understood as an abbreviation for *tam*, 'blameless.' In the seventh and sixth centuries B.C. the *taw* of Paleo-Hebrew script was written like an X or sloped cross."¹⁸¹

"Ezekiel, of course, could not have thought of Christian symbolism nor is the passage a direct prediction of Christ's cross. It is a remarkable coincidence, however."¹⁸²

"This is one of the many examples where the Hebrew prophets spoke better than they knew."¹⁸³

¹⁷⁹Feinberg, p. 55.

¹⁸⁰Ibid.

¹⁸¹Cooper, p. 127.

¹⁸²Feinberg, p. 56.

¹⁸³H. L. Ellison, *Ezekiel: The Man and His Message*, p. 44. See Block, *The Book . . .*, pp. 310-14, for an extensive discussion of the *taw* on the forehead.

- 9:5-6 Ezekiel also heard the Lord instruct the six other men to go through the city after the man with the writing case and slay everyone who did not have the special mark on him or her. They were to start from the temple and show no mercy to any individual who lacked the mark. So these six men began their assignment with the elders of Jerusalem who were in front of the temple (cf. 8:11). Judgment started with those closest to God, as it typically must (1 Pet. 4:17; cf. Matt. 18:6; Mark 9:42; Luke 17:2; Heb. 13:17).
- 9:7 The Lord directed these executioners to go out into the city. They were even to slay people in the temple courtyards, though by doing so they defiled the temple (made it ritually unclean; cf. Num. 19:11; 1 Kings 13:2; 2 Kings 23:16). Justice was more important than ritual cleanliness. The six men proceeded to carry out their duty (cf. 2 Chron. 36:17-19).
- 9:8 Ezekiel saw that these men were slaying everyone in the temple area and that he alone remained alive. So he prostrated himself before the Lord and prayed earnestly for mercy. Would the Lord destroy even the faithful remnant of Israel in His devastating judgment of the city (cf. Gen. 18:22-33; Amos 7:1-6)? Clearly Ezekiel felt deeply for his people, sinful though they were.
- 9:9 The Lord replied that the wickedness of the Israelites was extremely great (cf. Exod. 23:2). Bloodshed and perversion filled the land because the people had concluded that the Lord had abandoned them and would not see and take action regardless of what they did. Awareness that God sees us restrains people from sinning, but belief that He does not see us leads to flagrant sinning.
- 9:10 Yahweh promised to have no pity and to spare none of them from destruction but to bring the consequences of their actions back on their own heads. He had not abandoned His people, but He knew their wickedness and would punish them for it (cf. 8:18). They thought He did not see (v. 9), but His eye was upon them.
- 9:11 The man with the inkhorn returned to the Lord and reported that he had carried out his assignment as instructed. There were some that he was able to mark, and they remained alive. This was the faithful remnant that was a very small group at this time (cf. Rom. 9:27-29; 11:4-5).

3. The departure of God's glory from the temple ch. 10

There are many connections between this chapter and chapter 1, the vision of God's glory.¹⁸⁴

¹⁸⁴Cooper, pp. 135-38, presented a chart comparing the visions in chapters 1 and 8—10.

"The basic truth of the chapter is that God controls all the forces of judgment that He employs."¹⁸⁵

God's preparations to judge the city 10:1-8

- 10:1 Ezekiel next saw in his vision the cherubim that he had seen by the river Chebar (1:22, 26). "Cherubim" probably comes from the Akkadian *karabu*, meaning "intercede," "be gracious," or "bless."¹⁸⁶ Over their heads he again saw the throne-chariot that resembled a sapphire in its color and beauty. In 1:26 the throne-chariot resembled lapis lazuli, another expensive blue stone. Perhaps the blue color represented the heavenly origin of this throne.
- 10:2 Ezekiel saw the Lord instruct the man in linen (9:2-4, 11) to go among the whirling wheels under the cherubim (1:15-21) and to collect coals of fire from between them (1:13). He was then to scatter the coals over the city symbolizing its judgment and cleansing (Gen. 19:24; Ps. 18:10-15; Isa. 6:6; 33:14; Rev. 8:5). The man obeyed as the prophet watched.
- 10:3 Ezekiel explained that in his vision the cherubim were positioned on the right or south side of the temple building, looking east. The south side of the temple was closest to the city. A cloud, symbolizing God's presence (cf. Exod. 33:9-10; 1 Kings 8:10-11; Isa. 6:1-4), covered the inner courtyard of the temple where the cherubim stood.
- ". . . the presence of the Lord was as glorious in His departure as it was in His entrance (Exodus 40:34-35; 1 Kings 8:10-11)."¹⁸⁷
- 10:4-5 The prophet saw the glory of the Lord, perhaps personified, move from among the cherubim to the doorway of the temple building a second time (cf. 9:3). As God moved, the cloud representing His glory filled the temple and illuminated the courtyard (cf. Exod. 13:21-22). The sound of the cherubim's wings (1:6-9) also filled the whole temple area as far as the outer courtyard. That sound was like the voice of Almighty God, the sovereign of all creation, when He speaks (cf. 1:24; Ps. 29:3).
- 10:6-8 The man dressed in linen entered among the wheels of the cherubim to collect coals of fire. He stood beside one of the wheels. One of the cherubim then put some coals of fire that it had taken from between the cherubim and placed them in the man's hands. The man then went out of the cherubim's presence with the coals in his hands (cf. 2 Kings 23:4-9).

¹⁸⁵Feinberg, p. 59.

¹⁸⁶See Cooke, pp. 112-14, for an extended note on cherubim; and *The New Bible Dictionary*, 1962 ed., s.v. "Cherubim," by R. K. Harrison, especially figures 56, 167, and 205.

¹⁸⁷Feinberg, p. 60.

Ezekiel saw again that the cherubim had what looked like human hands under their wings (1:8). Perhaps he mentioned this to clarify how the cherub could pick up coals and place them in the man's hand.

God's preparations to depart from the temple 10:9-22

"God would not share His dwelling place with other 'gods,' and the sanctuary had been polluted with idolatry. God's worship center at Shiloh was removed shortly after His glory had departed from it (1 Sam. 4:1-4, 10-11, 19-23; Jer. 7:12-14); and the same fate awaited the Jerusalem temple."¹⁸⁸

"Ezekiel 10:9-22 provides one of the most obvious illustrations of echo literary strategy in Scripture, the affinities between these verses and 1:6-21 being apparent even to the casual reader."¹⁸⁹

10:9-11 Ezekiel again saw the wheels beside the cherubim, one wheel beside each of the four cherubim. This time he compared the wheels to Tarshish (lit. refinery) stones in appearance (cf. 1:16). Again, the exact identity of the stones that Ezekiel saw is impossible to determine with certainty today, but they were obviously expensive and beautiful. Tarshish was probably modern Spain or part of it, so this description identifies the stones by their quality or place of origin. Secondary vertical wheels evidently intersected the primary wheels and made it possible for these wheels to move in any direction horizontally (cf. 1:16-17).

10:12-14 Eyes covered the cherubim and the wheels symbolizing the great perception and knowledge of these beings (1:18; cf. Gen. 16:13; Zech. 4:10; Rev. 4:6). Ezekiel heard the wheels called whirling (Heb. *galgal*, "rotating," "rolling," or "revolving") wheels, described in terms of their function. Each of the cherubim had four faces—the faces of a cherub, a man, a lion, and an eagle (cf. 1:10).

In 1:10 the faces were of a man, a lion, a bull, and an eagle. Evidently the cherubim appeared more like bulls than anything else. This conclusion harmonizes with ancient Near Eastern art that pictured winged bulls and lions with human or bird heads guarding palaces. Probably the ancients chose these symbols of combined human and animal creatures to represent characteristics of those beings that they respected. Evidently God represented the cherubim in similar terms to communicate that His angelic servants possessed these same characteristics.

10:15-17 Then Ezekiel saw these same cherubim, which he had seen in his vision by the river Chebar, rise up. As they moved, the wheels beside them stayed right with them. Likewise when they stood still the wheels also stood still

¹⁸⁸Dyer, "Ezekiel," p. 1246.

¹⁸⁹Block, *The Book . . .*, pp. 315-16.

beside them. The spirit of the cherubim extended to the wheels so that whatever one did the other did. Perhaps the mobility of these creatures to do whatever God commanded them to do is what the wheels represent.

10:18-19 Ezekiel then saw God move from the front door of the temple (v. 4) to a position above the cherubim. In the former vision, the cherubim supported a platform on which the throne rested (1:22-26). The Lord was mounting his throne-chariot, which the cherubim would carry, to ride out of the temple and the city. The cherubim taxied God in His throne-chariot up to a position above the east gate of the temple (cf. 1 Sam. 4:4; 2 Sam. 6:2; 2 Kings 19:15; 1 Chron. 13:6; 28:18; Ps. 18:10; 80:1; 99:1). This was the main entrance into the temple courtyards from the outside world. The Lord in His glory and the cherubim then hovered above this gate.

God had warned His people that He would remove the glory of His presence from them if they departed from His will (cf. Deut. 31:17; 1 Sam. 4:21; Hos. 9:12). One of the greatest blessings that Christians enjoy is that God has promised never to withdraw His indwelling presence from our bodies, His present temples (Matt. 28:20; cf. John 14:17; 1 Cor. 6:19).

10:20-22 Ezekiel explained that the cherubim were the same creatures that he had formerly called living beings in his description of his earlier vision (1:5). Why did Ezekiel not call them cherubim in chapter 1? Perhaps this vision of Solomon's temple, which contained representations of cherubim (Exod. 25:18-20; 1 Kings 6:29, 35; 7:29, 36), helped Ezekiel identify the living creatures that he had seen before. Each one had four faces, four wings, and human-like hands under their wings (1:6, 8). The faces of the cherubim were the same as the faces of the living creatures in the previous vision. Each cherub moved straight forward, in the direction of the front of its body (1:9, 12). This description may stress the purposefulness with which the cherubim moved to carry out God's will.

"Once God passed from the gate, the name Ichabod ("the glory has departed") could have been applied to Jerusalem just as it had been applied earlier to Shiloh (1 Sam. 4:21-22)."¹⁹⁰

". . . the departure of the glory signals the end of a relationship that had existed for almost four centuries. The divine king has abandoned his residence."¹⁹¹

4. The condemnation of Jerusalem's leaders ch. 11

Ezekiel's vision of the departure of Yahweh's glory (chs. 8—11) now reached its climactic conclusion.

¹⁹⁰Dyer, in *The Old . . .*, p. 667.

¹⁹¹Block, *The Book . . .*, pp. 326-27.

The assurance of judgment on the people of Jerusalem 11:1-13

- 11:1 The Spirit next lifted Ezekiel up in his vision and transported him to the east (main) gate of the temple courtyards where God's glory had moved (cf. 10:19). There the prophet saw 25 of the governing leaders of the people of Jerusalem, including Jaazaniah the son of Azzur and Pelatiah the son of Benaiah.¹⁹² These 25 civic leaders were not the same individuals as the 25 sun-worshipping priests whom Ezekiel had seen earlier (8:16). Jaazaniah the son of Azzur does not seem to be the same man as Jaazaniah the son of Shaphan in 8:11. The name was evidently common at this time (cf. 2 Kings 25:23; Jer. 35:3). Gates were the traditional places where city elders administered justice and conducted legal matters.
- 11:2-3 The Lord told Ezekiel that these men were those who were planning wickedness and giving bad advice to the residents of Jerusalem. They were encouraging the people either to feel secure by advising them to build homes and plan on living long in Jerusalem (cf. 28:26) or to prepare for battle rather than submitting to the Babylonians. Either interpretation is possible because the unbelieving leadership of Jerusalem was advising both courses of action. The true prophets, like Jeremiah, however, were telling them to submit to the Babylonians (Jer. 21:8-10). Jeremiah wrote the exiles advising them to build homes and settle down in captivity (Jer. 29:5). These wicked leaders were comparing the people of Jerusalem to meat in a clay cooking pot. They were saying that the people were as secure in the city, even though they were uncomfortably "hot," as meat inside a kettle is safe from the fire outside it. The walls and fortifications of the city, and God Himself, they said, would amply protect the people from the fiery hostility of the Babylonian army.
- 11:4-6 Ezekiel was to prophesy against these leaders. The Spirit came upon him and instructed him to tell them that the Lord knew what they were thinking (cf. 2:2; 3:24; 13:1-3; 2 Pet. 1:21). God always knows what His people are thinking (cf. Ps. 139:1-6; Dan. 2:30; Acts 1:24). In this case their thinking was in rebellion against what He, through Jeremiah, had told them to do. Furthermore, they had slain many innocent people in Jerusalem by perverting justice and taking advantage of the weak.
- 11:7-9 Jerusalem had become like a cooking pot in that these slain people were like meat in it (cf. Mic. 3:1-3). It was a secure place only for those who had already died there. Nevertheless the Lord would remove the living from the "pot." Jerusalem would provide no refuge for the living. The Lord would bring the sword of the invader down on them. He would bring them out of the city into the hands of the invading enemy soldiers who would kill and capture them.

¹⁹²See Cooper, p. 139, for archaeological confirmation of the existence of these men in Jerusalem at this time.

"Those who perceive themselves as the cream that has risen to the top are nothing but scum in God's eyes."¹⁹³

11:10-12 The Jerusalemites would die violently at the hands of their enemy all the way to the borders of Israel (cf. 2 Kings 25:18-21; Jer. 52:8-11, 24-27), not just in the city. The walls of the city would not defend them from the fires of Babylonian invasion (cf. v. 3). Then they would know that the Lord was God. This punishment would come on the people because they had been unfaithful to the Mosaic Covenant but had followed the laws of their surrounding neighbor nations.

"This message was exactly the opposite of what Jerusalem's leaders considered appropriate. They saw the exiles as unfortunate victims of their own bad luck and poor judgment for having somehow gotten exiled instead of having been spared as the present leaders had been."¹⁹⁴

11:13 In his vision Ezekiel saw Pelatiah ("Yahweh rescues" or "Yahweh provides escape") die (cf. v. 1). Evidently Pelatiah really did die in Jerusalem when Ezekiel saw this vision or shortly after that. Ezekiel was able to see this real event happening in Jerusalem. This was a sign that God would judge the people as He had said.

"Because Pelatiah's name means 'the Lord rescues,' perhaps Ezekiel saw his death as an ironic and bad omen."¹⁹⁵

Pelatiah's death greatly affected Ezekiel (cf. Acts 5:5). He wondered if God would deliver anyone in Jerusalem. He fell on his face before the Lord and asked Him if He was going to destroy the godly remnant of the nation as well as the wicked (cf. 9:8). The compassion of Ezekiel came out again as he saw God judging the sinful Jews of Jerusalem.

"Perhaps Ezekiel felt that Pelatiah's sudden death signaled a decision by God that there would be no remnant, hence his cry, 'Will you completely destroy the remnant of Israel?' (v. 13)."¹⁹⁶

All societies tend to put in leadership or allow to rise to leadership individuals who reflect, appeal to, and will carry out the expectations and values of the majority. These judgments on Israel's leaders view them as reflections of and manifestations of a corrupt society. Ezekiel saw in the death of its leaders the death of all the people, whom the leaders represented.

¹⁹³Block, *The Book . . .*, p. 337.

¹⁹⁴Stuart, p. 100.

¹⁹⁵Chisholm, p. 245. See also Allen, p. 163.

¹⁹⁶Cooper, p. 141.

The assurance of restoration in the future 11:14-21

Block entitled this modified disputation speech "The Gospel according to Ezekiel."¹⁹⁷

11:14-15 The Lord then replied that many of the Jews in Jerusalem were saying that the Judahites who had gone into captivity were the ones that God was judging. They believed that the Jews left in Jerusalem were the remnant that God would preserve and bless. They incorrectly believed that Israel's future lay with the Jews in Jerusalem rather than with the Jews in exile.

11:16 Ezekiel was to respond to these Jerusalem Jews by saying that though God had driven the exiles from their land He would be with them and would provide a refuge for them in Babylon. He Himself would be a sanctuary for them even though they were far from the temple sanctuary in Jerusalem. Israel's future did not lie with the Jews still in Jerusalem but with those in Babylon.

"Even in drastic judgment, as in the case of the dispersion of Israel, God provides for His people a place of refuge. This refuge, called here 'a little sanctuary [AV],' is the LORD Himself (cp. Ps. 90:1; 91:9; Isa. 4:6). So with all of God's own, Gentile as well as Jew, in the midst of deserved judgment there is still a sanctuary of refuge and peace in Him."¹⁹⁸

11:17-18 The Lord also promised to assemble the Jews in exile from the various places where they had scattered from the Promised Land and to give them that land again. This is the first mention of Israel's future restoration in Ezekiel. When they came back into the land they would purify it of all the things that made it detestable and abominable to the Lord (cf. 5:11; 7:20).

"Such words have a Mosaic ring about them, as if the promised land of Canaan is being held out to the wilderness wanderers once again. The desert experience would not last for ever: one day they would possess the land—not by arrogant claim (as in verse 15), but by a gracious gift of God—and their worship would be purified of all the foreign, corrupting influences that had beset the Israelites since Joshua's day."¹⁹⁹

"The promise of restoration to the land, though declared in the blessings of the Mosaic covenant (Lev 26:40-45; Deut 30:1-10), was based on the eternal covenants to Abraham (Gen 12:1-3), David (2 Sam 7:12-16), and Jeremiah (Jer 31:31-34)."²⁰⁰

¹⁹⁷Block, *The Book . . .*, p. 341.

¹⁹⁸*The New Scofield . . .*, p. 848.

¹⁹⁹Taylor, p. 111.

²⁰⁰Alexander, "Ezekiel," p. 793.

11:19-20 The Lord also promised to give His people a united desire and commitment (cf. 36:26; Exod. 14:5; 1 Sam. 14:7; 27:1; 2 Sam. 7:3; Jer. 32:39). He would put a new attitude within them (cf. Ps. 51:10). This "spirit" would enter into them when God would pour out His Spirit on them (36:26-27; Deut. 30:6; Jer. 31:33; Joel 2:28-29). He would remove their hard hearts and give them hearts that were responsive to Him so they would obey His commands and do His will. Then they would enjoy an intimate relationship with God and He with them. On the individual level this change takes place through a new birth (cf. John 3:3-10). On the national level it will happen when the nation of Israel experiences a new birth (cf. Rom. 11:25-27).

". . . all the righteousness of the pious rests upon God's grace."²⁰¹

"The term *berit* [covenant] is absent, but in the declaration *They will become my people, and I will become their God*, the reader is introduced for the first time to what is generally known as 'the covenant formula.' Derived from ancient legal terminology, specifically the marriage ceremony, this formula expresses a relationship of commitment and intimacy. It's prominence in both Ezekiel and Jeremiah is based on a long history, beginning with Yahweh's commitment to be the God of Abraham and his descendants (Gen. 17:7-8)."²⁰²

"After the exile when many Jews returned to a restored province of Judah in fulfillment of prophecy (Ezra 1:1), they were careful to avoid idolatry (Ezra 4:1-3; 6:19-21; Neh 8—10). Nevertheless, their obedience was not complete (Ezra 9:1-2, 10-15; 10:15, 44; Neh 5:1-9; 13:7-29), nor was their experience of promised blessings (Ezra 9:8-9; Neh 9:32-37). Thus the radical spiritual transformation of the people and the associated physical blessings promised in this and other prophecies of the new covenant (Jer 31:31-34; Ezek 34:20-31; 36:24-38; 37:15-28) await fulfillment in a future messianic age."²⁰³

Many amillennialists take the fulfillment as happening on the day of Pentecost (Acts 2).²⁰⁴ Single-minded devotion to God is what He always requires and what His grace makes possible (cf. Matt. 4:10; 6:24-34; Eph. 6:5; Col. 3:22).

²⁰¹John Calvin, *Institutes of the Christian Religion*, 2:5:5.

²⁰²Block, *The Book . . .*, p. 354.

²⁰³Cooper, p. 144. See also Feinberg, p. 66; and Dyer, "Ezekiel," p. 1248.

²⁰⁴See Taylor, p. 112.

11:21 In the present, the Lord promised to bring judgment down on those who pursued the detestable and abominable idolatries that had polluted His people.

The departure of God's glory from Jerusalem and the end of Ezekiel's vision 11:22-25

11:22-23 Ezekiel then saw in his vision the glory of God depart from the temple gate and from the city of Jerusalem. He saw the cherubim under Yahweh's throne-chariot bear the Lord east from the entrance of the temple to the Mount of Olives outside Jerusalem. This was the eastern horizon from the perspective of someone in Jerusalem. The removal of God's blessing signaled the end of His longsuffering with His sinful people, and it opened the way for His judgment to fall on them (cf. Rom. 1:18-32). From this point on in Ezekiel—until 43:1-4, in which the prophet saw in another vision the glory of God returning to the city—the prophet saw the Lord's presence and glory removed from Jerusalem.

"The departure of the divine glory (the visible symbol of God's presence) from the Temple, marks the end of the theocratic kingdom in O.T. history. On the mount of transfiguration the glory of God was manifested to our Lord's disciples (Mt. 17:1-5; cp. also Jn. 1:14; 2 Cor. 4:6; Jas. 2:1; 2 Pet. 1:16-18). The visible glory will return when the kingdom is restored to Israel (Ezek. 43:1-7; Rev. 21:22-24)."²⁰⁵

"There is an interesting Midrash (commentary) which reads: 'Rabbi Jonathan said, Three years and a half the Shekinah stayed upon the Mount of Olives, in the hope that Israel would do penance; but they did none.' All readers of the New Testament know this was the length of the earthly ministry of our Lord to the lost sheep of the house of Israel. Sadly enough, they did not repent and He did depart from them (cf. Hosea 5:15 with Matt. 23:37-39). . . . From this very place the Lord Jesus Christ left the earth (Acts 1) and to it He will return (Zech. 14; cf. also Luke 21:20 with Matt. 24:3; Luke 24:50-51; Acts 1:11-12)."²⁰⁶

Perhaps the Lord's presence stood over the Mount of Olives, rather than departing from it (v. 23), because the Lord was waiting to execute His judgment on the city (cf. Zech. 14:4; Luke 19:41).²⁰⁷

²⁰⁵*The New Scofield . . .*, p. 848. See also Alva J. McClain, *The Greatness of the Kingdom*, pp. 120-29: "The End of the Mediatorial Kingdom in Old Testament History"; and Samuel J. Andrews, *God's Revelations of Himself to Men*, pp. 112-13.

²⁰⁶Feinberg, p. 67.

²⁰⁷Keil, 1:154.

11:24-25 The Spirit then returned Ezekiel in his vision to Babylon. The vision was over, and the prophet related everything God had shown him to his fellow exiles.

C. YAHWEH'S REPLY TO THE INVALID HOPES OF THE ISRAELITES CHS. 12—19

"The exiles had not grasped the serious consequences of Ezekiel's warnings. They still hoped for an early return to Palestine, for they viewed the continued preservation of Jerusalem and Judah as signs of security. After all, Jerusalem was the eternal city. They presented several reasons for their hope and security—as well as their objections to Ezekiel's warning—in chapters 12—19.

"First, if judgment was to come, it would not be in their lifetime, as Ezekiel had declared (ch. 12). Second, Ezekiel was only one of many prophets. Most prophets and prophetesses announced hope and reasons for optimism. Why should the people listen to Ezekiel (ch. 13)? Third, the leaders in Judah were ultimately responsible. If there were to be any judgment, it would be on them, not the exiles (ch. 14). Fourth, if real danger of judgment should exist, then they would only have to find some righteous man to intercede for them before God. Thus they would be delivered (ch. 14). Fifth, how could Ezekiel possibly believe that God would judge his own chosen people? He would not do that (chs. 15—16). Sixth, it would not be fair for God to judge anyone for his forefathers' sins. The people thought Ezekiel was saying that God did judge one for his forefather's sins (ch. 17). Seventh, if judgment was really coming, then there was nothing they could do to stop it; for they would be paying for their fathers' sins. It would not make any difference if they repented (ch. 18). Eighth, Zedekiah, the contemporary ruler of Judah, could be trusted. He would throw off the yoke of Babylonia (ch. 19).

"Ezekiel patiently, systematically, and adamantly (cf. 3:8-9) challenged the naive reasoning of the exiles, undermining each source of their optimistic rejection to his warnings of judgment. When Ezekiel had finished his challenges, no excuses remained."²⁰⁸

This series of messages expands and develops the concepts presented in the preceding vision (chs. 8—11). Similarly the messages of judgment on Judah and Jerusalem (chs. 4—7) expounded elements in the vision of Ezekiel's commission (chs. 1—3). This pattern continues through the book.

"Chapters 4—11 have repeatedly shown the certainty of Jerusalem's destruction; chapters 12—19 present the necessity for it. The emphasis in these chapters is the moral cause of the exile."²⁰⁹

²⁰⁸Alexander, "Ezekiel," p. 795.

²⁰⁹Feinberg, p. 68.

The Judahites had trusted in the remnant in Jerusalem (12:1-20), parables (12:21-28), other prophets (ch. 13), idols (14:1-11), religious intercessors (14:12-23), their position as God's vine (ch. 15), the holy city of Jerusalem (ch. 16), Zedekiah (ch. 17), and God's justice (ch. 18).²¹⁰

1. The dramatic tragedy of exile 12:1-20

This section contains three messages from the Lord all of which deal with the inevitability of another deportation of Jews from Jerusalem and Judah (vv. 1-7, 8-16, 17-20). Jerusalem would be overthrown and the Jews still there would be taken to Babylon in the very near future. The prophet's perspective now broadened from the temple (chs. 8—11) to the city (ch. 12).

The sign of the departing deportee 12:1-7

"It is characteristic of the book to follow a vision report, in this case chaps. 8—11, with an account of sign-acts and their interpretation within an oracular setting."²¹¹

12:1-2 The Lord came to Ezekiel with another message. Because it is not dated, and because the book follows a chronological sequence of events, most commentators believed that this word from the Lord came to Ezekiel shortly after he received the vision in chapters 8—11. God told His servant that the people among whom he lived, the house of Israel, were rebellious against Him (cf. 2:3-8). Their blindness to the things that they saw and their deafness to His words, after over a year of Ezekiel's ministry, were the result of their rebellious condition (cf. Deut. 29:1-4; Isa. 6:9-10; Jer. 5:21; Matt. 13:13-15; Mark 8:18; John 12:39-40; Acts 28:26-27).

"Sin blinds the heart and mind. Like Samson, who could not see that his chosen path was leading to the loss of his ministry, the sinner does not see the ultimate consequences of sin that produces death and destruction (Judg 13—16; cf. . . . Isa 6:9-13; Rom 6:23)."²¹²

12:3-4 The Lord instructed Ezekiel to perform another symbolic act. He was to pack his bags during the daylight hours as though he were going into exile. Thus he would probably have packed only the barest necessities.²¹³ He was then to leave his present home and depart for another place in the evening, when the other exiles could observe what he was doing. Perhaps this would teach them how rebellious they were.²¹⁴

²¹⁰Dyer, in *The Old . . .*, p. 669.

²¹¹Allen, p. 183.

²¹²Cooper, p. 148.

²¹³Greenberg, p. 209.

²¹⁴For ancient pictures of deportees going into exile, see James B. Pritchard, ed., *The Ancient Near East in Pictures*, plates 10, 311, 363-64, 366, and 373.

"Perhaps' is God's sigh, rather than a threat."²¹⁵

- 12:5-6 He was to dig a hole in the sun-dried mud brick wall of his house (Heb. *qir*), perhaps the wall around the courtyard of his house, as the people watched, and pass through it. This unusual method of departure pictured desperation and secrecy. He should load his baggage on his shoulder and carry it away as night set in. He was also to cover his face so he could not see the land. This may represent the inability of the exiles to see their land any more or his shame at having to depart or his attempt to conceal himself from the enemy. He was to do all this because God was using him as a lesson to the Jews.
- 12:7 Ezekiel did all that the Lord had commanded him. During the day he assembled the few things that a person would take into exile and bound them up for carrying. That evening he dug a hole through his wall with his hands. As night fell, he went out through the hole in the wall as the people watched. Zedekiah and many other Jerusalemites tried to escape from the city at night (Jer. 52:7). The fact that Ezekiel went out at night may also represent the dark conditions that would exist for Israel when the final exiles departed from Jerusalem (cf. John 13:30).

The explanation of the sign of the departing deportee 12:8-16

- 12:8-9 The morning after Ezekiel had performed this little drama the Lord spoke to him again. He reminded His servant that the Jews had asked him to interpret his symbolic acts.
- 12:10 Ezekiel was to explain to them that the oracle that he had delivered by his acted parable concerned King Zedekiah and the Jews who were in Jerusalem. Ezekiel regarded King Jehoiachin as the legitimate king of Judah, and he referred to Zedekiah as only a prince (Heb. *nasi'*, leader) because Nebuchadnezzar had set him on the throne. "Prince," however, was one of Ezekiel's titles for Judah's kings. Many of the Jews and the Babylonians also continued to view Jehoiachin as the true king of Judah.
- 12:11-12 Ezekiel was to explain to his audience that he was a sign to them of others who would go into captivity. He was not representing his fellow exiles who would leave Babylon and return to Judea. He represented what Zedekiah and the people of Jerusalem would do. Zedekiah would try to escape under cover of darkness through a hole in a wall with his face covered to make himself unrecognizable (cf. 2 Kings 25:4-6; Jer. 39:4-5; 52:7-8).
- 12:13 Nevertheless the Lord would snare Zedekiah like a bird in a net and would bring him to Babylon. Ancient art pictured deities as hunting and snaring

²¹⁵Allen, p. 178.

their enemies.²¹⁶ Yet Zedekiah would not see the land of Babylon even though he would die there (cf. 2 Kings 25:5, 7; Jer. 39:6-7; 52:8, 10-11).

Josephus wrote that Zedekiah heard about this prophecy by Ezekiel but did not believe it because it seemed to contradict Jeremiah's prophecy about what would happen to him.²¹⁷ This apparent contradiction was the reason Zedekiah gave for rejecting both prophecies. Both prophecies proved true: the Chaldeans took Zedekiah to Babylon, but he never saw the country because Nebuchadnezzar blinded him at Riblah.

12:14-15 The Lord would also scatter the Jews who accompanied, assisted, and tried to defend Zedekiah in his escape and would pursue them with a sword as they fled to other nations.

12:16 Yahweh would allow a few of them to escape so they could tell what had happened, including their sinfulness and God's dealings with them as a nation.

"The deportations were designed to show the deportees that the Lord was the faithful, loving, and powerful God over Israel they should return to. Lest the foreign nations misunderstand Judah's dispersion, God had the exiles testify that their abominations precipitated the deportations. In this way the nations would realize that the Lord was holy, righteous, and cared for his people, Israel. He was not one who allowed them to be conquered because he did not care. This latter notion was very common in the ancient Near East. Each nation was uniquely related to its patron deity. If a nation was defeated in battle or decimated by famine and disease, this meant its god was weak and incapable of protecting and caring for its people. To prevent such a misconception, the Lord would send a remnant of Jews among the nations to witness that they were in exile only because of their own iniquity, not because of the Lord's failure."²¹⁸

"What men fail to appreciate in prosperity, they will occasionally learn through adversity."²¹⁹

The sign of the anxious eater 12:17-20

12:17-18 The Lord also instructed Ezekiel to eat his bread and drink his water while trembling and visibly anxious. The prophet appears to have been eating still the symbolic rations that God had prescribed for him earlier (4:9-17).

²¹⁶See Pritchard, plate 298.

²¹⁷Flavius Josephus, *Antiquities of the Jews*, 10:7:2.

²¹⁸Alexander, "Ezekiel," p. 797.

²¹⁹Taylor, p. 116.

12:19-20 He was then to explain to his audience that the Jews in Jerusalem would eat and drink like he had done. The Lord would strip their land of its abundance because the people had committed so much violence contrary to His law. He would also desolate the inhabited cities and the countryside of Judah. Then His people would know that He was the Lord. He loved them enough to discipline them (cf. Heb. 12:5-11).

2. The present judgment as evidence of divine faithfulness 12:21-28

This section contains two prophecies (vv. 21-25 and 26-28). The first one deals with the objection of some of the exiles that the prophecies of Jerusalem's overthrow would never come to pass. The second addresses the view of some that destruction would come but not for a very long time.

The validity of prophecies about Jerusalem's destruction 12:21-25

12:21-22 The Lord asked Ezekiel about a proverb that the Jews were reciting among themselves. They were saying that the days were long and that every vision failed. They meant that the captivity that the true prophets (including Isaiah, Micah, Jeremiah, and Ezekiel) had predicted was a long way off and that the visions they claimed to have would turn out to be unreliable.

12:23-24 The Lord promised that the people would no longer say such things because He would prove them wrong. Ezekiel was to contradict this proverb and give the people another one that the days of the coming captivity were not far off and that the prophets' visions would come to pass. The Lord would frustrate the false prophecies and predictions of the future that only flattered the people.

12:25 Yahweh promised to bring to pass what He had spoken without delay. What He had said He would do in the days of Ezekiel's hearers. His word of judgment would go forth, and judgment would follow immediately.

The imminent fulfillment of prophecies of Jerusalem's destruction 12:26-28

12:26-27 Some of the people were saying that the prophecies about coming judgment were true, but they would not come to pass for a long time.

"Rebelliousness (v. 25) can take many forms, some of them even quite pious ('How do I know which preacher to believe, which church is right?'). In Ezekiel's day it was 'How do I know which prophet is correct (v. 24), which prophecy applies to me (v. 27)?'"²²⁰

²²⁰Stuart, p. 116.

12:28 Nevertheless the Lord promised not to delay His promises of coming judgment any longer. He would perform all that He had promised (cf. 2 Pet. 3:2-13).

3. The condemnation of contemporary false prophets ch. 13

This chapter follows quite naturally from the previous one. There God corrected the mistaken views of His people, and here He rebuked those who were responsible for those views. In this section God pronounced judgment on the false prophets who were responsible for the Jews' false sense of security (cf. 12:21-28; Jer. 14:14; 23). He dealt with two groups of false prophets in this chapter: the males (vv. 1-16) and the females (vv. 17-23).

"The Prophet Ezekiel has already pronounced the judgment of God on the city of Jerusalem, the princes and the king. Now he rebukes the false prophets. . . . This chapter, one of the most important in the Old Testament on the abuses of the phenomenon of prophecy, may be considered an elaboration of the truth in 12:24."²²¹

Condemnation of the male false prophets 13:1-16

Ezekiel first confronted the male false prophets, and then he explained the reasons that God would judge them.

The characteristics of these prophets 13:1-7

13:1-3 The Lord gave Ezekiel a message for the prophets who were devising messages for the Jews from their own hearts and calling them prophecies from Yahweh. He was using the word "prophet" ironically; these were not true prophets, but they claimed to be such. Ezekiel was to announce judgment on these false prophets. They were foolish (Heb. *nabal*) because they disregarded God's word and relied on themselves. This is the essential mark of this type of fool in the Old Testament (cf. 1 Sam. 25; 2 Sam. 13:13; Ps. 14:1; 74:18).

It is not clear in this chapter whether the Lord was speaking primarily of the false prophets in Jerusalem or in exile. Probably He meant false prophets in both places.

"In the same way that impersonating a police officer is a crime in modern society, because it harmfully defrauds people who trust and obey the police, impersonating a true prophet of the Lord was, by God's law, a fraudulent misleading of Israelites in Ezekiel's day."²²²

²²¹Feinberg, p. 73.

²²²Stuart, p. 120.

- 13:4-5 The Lord compared these false prophets to foxes or jackals (Heb. *shu'alim*) that prowled around among ruins looking for holes in which to hide (cf. Neh. 4:3; Lam. 5:18). The same Hebrew word refers to both animals. They had not tried to repair conditions that had resulted in Israel's weakness and vulnerability nor had they strengthened the nation spiritually (cf. 22:30). Building the wall around the house of Israel so it could stand in the battle of the day of the Lord refers to preparing the people for the invasion and siege of Jerusalem by Nebuchadnezzar. The only concern of foxes and these prophets was their own welfare and self-interests. They contributed nothing to the welfare of other needy people.
- 13:6-7 When these prophets claimed to speak a message from the Lord they were only uttering falsehood and presenting the results of deceptive pagan divination. The Lord had not sent them, yet they expected their prophecies to come to pass. Yahweh asked them if their claimed revelations from Him were not really just false visions and lying divinations.

"Today there are also many 'false prophets' ministering in religious places, leading people into judgment rather than turning them to Christ and the security of a life of peace with God and eternity with him (cf. 2 Cor 11:13-15)."²²³

The reasons for their judgment 13:8-16

- 13:8-9 The Lord told these false prophets that He opposed them for what they had done. He would act against them by removing them from positions of influence among His people, depriving them of the rights of citizenship in Israel (cf. Ezra 2:62; Luke 10:20; Rev. 3:5; 20:15), and preventing them from returning to the Promised Land. They had failed as "watchmen" over the house of Israel (cf. 3:16-21). The fulfillment of these judgments would prove to them that Yahweh was Lord (cf. Exod. 7:5).
- 13:10-11 Judgment would come on them for misleading the Lord's people by falsely predicting peace when no peace was coming.

There are two interpretations of the references to whitewashing, the literal and the metaphorical. The literal interpretation understands God to be saying that when the residents of Jerusalem built their walls (Heb. *hayis*, a flimsy partition) and houses, believing that they were secure, the false prophets supported their efforts by adding the whitewash. They should have warned them to prepare for coming judgment rather than helping them beautify the walls of their homes. The coming divine judgment would descend on Jerusalem like a rainstorm with hailstones and violent winds and destroy their beautifully whitewashed walls.²²⁴

²²³Alexander, "Ezekiel," p. 801.

²²⁴See *ibid.*, pp. 801-2.

The metaphorical interpretation, which most commentators took and which I prefer, understands God to be saying that these false prophets were putting a good front on the situation in Jerusalem, saying peace rather than judgment was coming. They were compounding Israel's difficulties by hiding problems that needed to be exposed and corrected. Ezekiel was to tell them that invasion would come, like a rainstorm with hailstones and violent winds, and that their facade of a future for the people would then come crashing down (cf. Matt. 7:24-29).

"The false prophets were compared to those who build an unsafe wall and cover up its defects. The untempered mortar [AV] was actually whitewash, which is useless for strengthening insecure walls. Smooth words of false messengers hid from the people the actual seriousness of their spiritual condition. To daub with untempered mortar [or plaster with whitewash], in the metaphorical sense, is to flatter, to use hypocrisy. When the false prophets confirmed the people in their evil ways, by their approval they were whitewashing the flimsy spiritual structure of Israel."²²⁵

13:12 When the walls, or the picture of the future that the false prophets had painted, had collapsed, the people would ask a question. They would question the materials out of which they constructed the wall, either the literal wall or the wall of false speculation. It had proved inadequate and unreliable.

"An attractive external appearance is no substitute for intrinsic soundness."²²⁶

13:13-14 The Lord promised to send a violent storm of judgment on His people in Jerusalem because of His anger against them and to destroy the people's homes and the false prophets' vision of the future. Then the foundations of their homes and the false prophets' vision would lie exposed for all to see, and the false prophets themselves would perish in the judgment. Then they would know that the Lord was God.

13:15-16 The Lord would destroy both the people's homes, or the false vision of the future that these prophets painted, as well as the prophets themselves, those who promised peace to Jerusalem when no peace was coming (cf. Matt. 18:7).

"It is a common failing for preachers to want to speak pleasing and appeasing words to their people, but if they are to be true to their calling they must be sure to receive and to impart nothing but God's clear word, irrespective of the consequences. When church leaders encourage their

²²⁵Feinberg, p. 75.

²²⁶Block, *The Book . . .*, p. 408.

people in sub-Christian standards or unbiblical ways they make themselves doubly guilty."²²⁷

Condemnation of the female false prophets 13:17-23

There were female as well as male prophets in Israel (Exod. 15:20; Judg. 4:4; 2 Kings 22:14; Neh. 6:14; Luke 2:36) and in the early church (Acts 21:9; 1 Cor. 11:5). However there were far fewer female than male prophets, and there was no formal order or class of female prophets. God raised up female prophets according to His sovereign purposes occasionally, but He usually used males for this ministry. Females who were not true prophets sometimes claimed to be such, just as males did.

"Although a limited number of oracles directed at women are found in the OT, the present prophecy against female false prophets has no equal."²²⁸

Their practices 13:17-19

13:17 The Lord also directed Ezekiel to speak judgment to the female false prophets who were concocting their own messages and passing them off as divine revelations (cf. Isa. 3:16—4:1; 32:9-13; Amos 4:1-3; Mic. 3:5).

13:18 He was to announce Yahweh's judgment on these women who sewed cloth bands to place on the wrists and floor-length veils on the heads of themselves or the objects of their "prophesying." They used these aids to impress people and to cast spells on (to influence) people to bring them under their power (cf. Jer. 7:18; 44:17, 19).

"The activities attributed to these women suggest that they were more like witches or sorcerers than prophets [cf. 1 Sam. 28:7]."²²⁹

13:19 Ezekiel was to announce judgment on those who indulged in these occult practices and perverted justice for only a little food or as a means of divination.

"In some cultures barley was used in occult practices either as an offering to the spirits or as a means of trying to determine the future."²³⁰

These women had been willing to put some to death who did not deserve to die and to save others from death who did deserve to die. This was the result of their lying to God's people, who loved to listen to their lies.

²²⁷Taylor, p. 122.

²²⁸Block, *The Book . . .*, p. 412.

²²⁹Cooper, p. 157. See also H. W. F. Saggs, "External Souls in the Old Testament [Ezk 13:17-21]," *Journal of Semitic Studies* (1974):1-12.

²³⁰Dyer, "Ezekiel," p. 1252.

Their judgment 13:20-23

- 13:20-21 The Lord promised to oppose their practice of using magic bands to hunt down innocent lives. He would tear these bands from their arms and release the people that these false prophetesses had snared like birds. He would also tear off the veils they used to hunt the innocent and free those whom they had hunted down. These women were using some sort of magic to control people. Then these false prophetesses would know that the Lord was God.
- 13:22-23 Because these false prophetesses discouraged the righteous with falsehood without divine authorization and encouraged the wicked to continue in their wickedness, they would no longer see false visions or practice divination. They would die. The Lord would deliver His people from their deadly hands, and they would know that He was the Lord.²³¹

"Modern-day fortune tellers are rather similar to the women described in this passage. Fortune tellers, interestingly, are usually women, and they tend to dress in a rather elaborate manner, often wearing clothing or jewelry associated with the occult arts, comparable to the 'muffs' on the prophetesses in ancient Israel (v. 18). They tend to give their advice in darkened rooms, where the attitude of the inquirer is influenced in an eerie way, and this corresponds to the veil put over the inquirer in Ezekiel's description (v. 18). They are paid for what they do, just as the ancient women were (v. 19), and their advice is always dangerous (v. 19) because it leads people astray from the truth of God, that truth being the only way to live and not die eternally. They are frauds, who envision 'lies' (NKJV, 'futility,' v. 23) because their predictions are fabrications made up from their own minds (v. 17), just as was done in Ezekiel's time."²³²

4. The effect of false prophets on Israel's leaders 14:1-11

This prophecy carries on the thought of the one in chapter 13 about false prophets. Those who resorted to false prophets would share their fate, namely, judgment by God.

"Idolatry was the standard method of religion in ancient times. Ancient peoples believed that any depiction of a thing somehow partook of the essence of that thing, no matter how crude or artificial the depiction might be. A picture of a tree contained part of the essence of the tree; a statue of a god contained part of the essence of that god. Where that statue was, the god was of necessity at least partly present. Anything offered to a god's statue was offered directly to the god."²³³

²³¹For another study of this passage, see W. H. Brownlee, "Exorcising the Souls from Ezekiel xiii, 17-23," *Journal of Biblical Literature* 69 (1950):367-73.

²³²Stuart, p. 124.

²³³Ibid., p. 126.

This attitude persists even today in some parts of the world as seen, for example, in some people's unwillingness to allow someone else to photograph them. They believe that the image of themselves on the photograph is a part of their essence that the taking of a photo removes from them.

A warning to the elders of God's people 14:1-5

14:1-2 Some of the elders of the Jewish community in exile came to visit Ezekiel. While these men sat with the prophet, a word from the Lord came to him.

14:3 The Lord revealed to His servant that these elders (along with the elders in Jerusalem, cf. 8:7-12) had been nursing idolatry in their hearts. The word translated "idols" in this passage is *gillulim*, Ezekiel's favorite term for idols. It means pellets of dung literally (cf. 6:4-6, 9, 13; et al.). These elders had put right in front of them the very thing that caused them to stumble in sin. That is, instead of trying to avoid temptation (cf. 2 Tim. 2:22) they cherished the worship of other deities. In view of what follows, this appears to have included seeking false prophets and prophetesses to obtain guidance (vv. 4, 7, 9; cf. ch. 13). In the following verses it becomes clear that the prophets these elders consulted were false prophets (cf. vv. 9-10). Yahweh asked rhetorically whether He should respond to their requests in view of their trust in other gods (cf. Ps. 66:18; 1 Kings 18:21; James 1:8).

"This verse is important for those who come to Scripture seeking guidance. No true direction can be given to those who have erected idols in their hearts [cf. Ps. 66:18]."²³⁴

14:4-5 Ezekiel was to tell these elders a message from the Lord. The Lord promised that any person in Israel, not just these elders, who was an idolater at heart and set a stumbling block in his own path by consulting a false prophet for divine guidance would receive an answer from Yahweh, not from the idol. That answer would come in the form of divine judgment, not words (cf. vv. 7-10). The judgment of God on those who pursued idolatry was allowing them to continue in it until it destroyed them (cf. Lev. 20:3, 5-6; Deut. 28:37; Hos. 4:17; Rom. 1:18-32; 2 Thess. 2:11).

"This happens only to those who willingly take deceit into their hearts."²³⁵

Taylor titled this section "Condemnation of those who are set on idolatry."²³⁶ It is not the *practice* of these idolaters that drew the judgment

²³⁴Alexander, "Ezekiel," p. 805.

²³⁵Feinberg, p. 80.

²³⁶Taylor, p. 125.

of God, as bad as that was, but their *commitment* to it that drew the punishment explained here. Yahweh would judge these elders because of the multitude of His people's idols and to bring their hearts back to Himself. The desire of these elders for a word from the Lord was only hypocritical; they wanted to appear pious but were really idolaters at heart.

A warning to all God's people 14:6-11

14:6 The Lord called His people to change their minds (repent, Heb. *shub*), turn away from the idols in their hearts, and abandon them.

14:7-8 Anyone in Israel, including immigrants (Heb. *ger*, sojourners, resident aliens), who did not repent but continued to do what these elders had done and approached a false prophet for a message would receive judgment from the Lord. Note the emphasis on personal responsibility for sin throughout this passage (cf. v. 4). The Lord would oppose all such people making them object lessons to others of what happens when God's people pursue idolatry. He would put them to death (cf. Lev. 17:4, 10, 14; et al.). Then His people would know that He was God.

"In the Book of Ezekiel Israel's idolatry was seen as the major cause for God's judgment on His people."²³⁷

14:9 If the idolater prevailed on the false prophet to speak, it was Yahweh in His sovereignty who allowed that prophet to speak (cf. Deut. 13:1-5; 1 Kings 22:23).²³⁸

"Such a statement is only intelligible when we remember that ancient habits of thought [frequently] overlooked secondary causes, and attributed events directly to the action of God."²³⁹

The Lord would also judge the false prophet with death.

14:10-11 Both the idolatrous Israelite and the false prophet would bear punishment for their sins, but this would be punishment with a purpose. Then the rest of God's people might learn and not apostatize and defile themselves with transgressions but enjoy an intimate relationship with Yahweh and He with them (cf. 11:20; 37:28; Exod. 19:5-6; Lev. 26:16; Jer. 7:23; 31:33).

5. The need of personal righteousness for deliverance 14:12-23

This prophecy continues the emphasis on judgment from the previous one and stresses the irrevocability of Jerusalem's destruction (cf. Jer. 7:16; 15:1-4).

²³⁷Dyer, "Ezekiel," pp. 1252-53.

²³⁸See Robert B. Chisholm Jr., "Does God Deceive?" *Bibliotheca Sacra* 155:617 (January-March 1998):23-25.

²³⁹Cooke, p. 151.

14:12-14 The Lord spoke to Ezekiel again. He revealed that Jerusalem's great sins had made deliverance from divine punishment impossible. Evidently some of the exiled Jews were remembering God's promise to Abraham that He would deliver Sodom if there were enough righteous people in it (Gen. 18:22-33). Surely, they thought, there were enough righteous people in Jerusalem that God would not destroy it.

"This attitude is nothing less than using the saints as an insurance policy to cover the sinners. It has been a human failing in every generation. A community is a trifle embarrassed to have a saint among its number, but it derives a sense of security from his presence, rather like the possession of a religious lucky charm. A family with no pretensions to spirituality is often glad to have a minister of religion in one of its branches, however far removed."²⁴⁰

When sin had gone so far that Yahweh stretched out His hand in severe judgment by famine, even the righteousness of a Noah, a Daniel, and a Job could not save the nation. Noah was the only righteous man of his day, but his righteousness did not avert God's judgment on the rest of humanity. Daniel was righteous, but his presence in Jerusalem had not precluded the deportation of many Judahites. Job's righteousness could not even prevent judgment that touched his family members and possessions. All three men were righteous men who lived amidst unrighteousness—Noah, a pre-Israelite, Daniel, an Israelite now living in Gentile Babylon, and Job, a non-Israelite. Some scholars believed the Daniel in view was not the Daniel of the Book of Daniel, Ezekiel's contemporary, but a character in a Canaanite epic.²⁴¹ Most conservative commentators have rejected this view.²⁴² If these three men lived in Jerusalem, the Lord would deliver them for their own righteousness, but He would deliver no others for their sake. God had, in fact, delivered Daniel from the coming destruction of Jerusalem by removing him safely to Babylon. God would have spared Sodom if only 10 righteous people lived there (Gen. 18:33), but He would not spare Jerusalem if three of the most righteous people in history lived there. Jerusalem's guilt was greater than Sodom's.

"Noah, Job, and Daniel—each one of them faces a distinct challenge that demands a profound level of faith. The issues that confronted them: faith in the word of God amid prevailing scientific skepticism, faith in God in spite of acute suffering; faith in God displayed in a situation of sophisticated pluralism, choosing to accept death rather than dishonor God."²⁴³

²⁴⁰Taylor, p. 128.

²⁴¹E.g., *ibid.*, p. 129; Stuart, p. 130; and Allen, p. 218.

²⁴²For a rebuttal of it, see Cooper, pp. 163-64.

²⁴³Jo Ann Davidson, "'Even if Noah, Daniel, and Job' (Ezekiel 14:14, 20)—Why These Three?" *Journal of the Adventist Theological Society* 12:2 (Autumn 2001):143-44.

"All of them were tested and proved faithful, Noah by the Flood, Daniel in the lions' den, and Job by painful trials from Satan."²⁴⁴

The Lord said that this principle of judgment applied to "a country" (v. 13), any country that acted treacherously against the Lord.

"It probably is sufficient simply to note that the hypothetical situation has both a general character (note that Noah, Daniel, and Job are all associated with non-Israelite contexts) and a specific application to Israel. The point of the passage is that Israel was under a divine judgment that was irreversible in its very nature."²⁴⁵

14:15-16 If God's judgment by wild beasts resulted in the depopulation of the land, including the children (cf. Lev. 26:22; Deut. 32:24), the righteousness of Noah (cf. Gen. 6:9), Daniel (cf. Dan. 6:4-5, 22), and Job (cf. Job 1:1, 8; 2:3) would not deliver even their own family members from divine judgment. God would spare just these men alone. God had spared Noah's family for his sake (Gen. 6:18), and he had spared Daniel's friends for his sake (Dan. 1:6-20; 2:17-18; 3) and Job's friends for his sake (Job 42:7-10), but he had not spared Job's children. Probably the order of these names is climactic. It is not chronological.

14:17-20 The presence of these three men would not save the city if the Lord brought an invading army against it (vv. 17-18). The same would be true if God judged His people with disease, the effect of siege warfare (vv. 19-20; cf. Rev. 6:1-8). The Lord confirmed the certainty of each of the last three forms of judgment with His oath (vv. 16, 18, 20).

14:21 The Lord promised to send judgment by these four agents against Jerusalem: war, famine, wild animals, and disease (cf. Lev. 26:22-26). Four agents of divine judgment would overcome even the influence of three extremely righteous individuals, super-saints.

"The number four conveys the idea of completeness with an allusion to the four quarters of the earth. The logic is this: If there would be no sparing in one judgment, how much more certain would the universal judgment be in the case of four devastating judgments?"²⁴⁶

14:22-23 In spite of this severe judgment on Jerusalem, some of the inhabitants would survive and would join the Jews already in exile (i.e., a remnant, but this time an apostate remnant, cf. Jer. 44:27-30; Amos 9:8, 11-15). The

²⁴⁴Wiersbe, p. 188.

²⁴⁵Cooper, p. 162.

²⁴⁶Feinberg, p. 82. Cf. Rev. 6:1-8.

formerly exiled Jews would see their conduct and actions (Heb. *'alilah*, evil actions) and feel some comfort in view of the calamity that had overtaken Jerusalem. They would then see that what the Lord had done to Jerusalem was fair because these Jerusalemites' actions deserved judgment (cf. Gen. 18:25). They would also see that God's preservation of some of them was pure grace.

The presence of godly people living in an ungodly society will not necessarily preclude divine judgment on that society. There must be repentance by many people in that society for God to withhold judgment.

"A vicarious deliverance from individual sin, however, is impossible, except for the singular *eternal* vicarious deliverance provided by Jesus the Messiah in his substitutionary death for all sins (cf. John 14:6; Acts 4:12; 2 Cor 5:21). He alone can deliver others because of his death for their sin and his resurrection from the dead."²⁴⁷

6. The unprofitable vine of Jerusalem ch. 15

This is the first in a series of three parables designed to impress on the overly optimistic exiles that there was no possibility that Jerusalem would escape destruction (cf. chs. 16—17).

15:1-2 The Lord asked Ezekiel how the wood of a vine was superior to the wood of other trees.

15:3-5 Vine wood was not good for making much of anything because it was too soft, weak, and crooked. It was not even good for making a peg on which to hang a vessel because it was so weak. It was only good for producing grapes. If vine wood was naturally of so little value, it was of even less value when charred by fire.

15:6-7 The Lord compared the inhabitants of Jerusalem to a piece of vine wood that He had used for fuel. Vine wood is not even good for fuel since it is so soft and burns so quickly. The vine was one of the most common symbols of Israel (Gen. 49:22; Deut. 32:32; Ps. 80:8-16; Isa. 5:1-7; Jer. 2:21; Hos. 10:1; Matt. 21:33-41; John 15:1-6). Clusters of grapes decorated Herod's temple as national symbols.²⁴⁸ Israel's purpose was to bless the nations with fruitfulness; she was to be a source of blessing to the world (Gen. 12:1-3). If she failed to do that, she was of very little value.

"John Wesley, the founder of the Methodist church, prayed,
'Lord, let me not live to be useless!'"²⁴⁹

²⁴⁷Alexander, "Ezekiel," p. 807.

²⁴⁸Flavius Josephus, *Wars of the Jews*, 15:11:3.

²⁴⁹Wiersbe, p. 190.

The Lord had set His face against His people in judgment twice already (cf. Ps. 66:12). They had experienced two invasions and deportations, in 605 and 597 B.C. Even though some of them had escaped complete destruction, they were still not bearing fruit and would end up completely burned (cf. John 15:6; Heb. 12:28-29). This would happen when the Chaldeans destroyed the city and deported the rest of the Judahites in 586 B.C. (2 Chron. 36:10; cf. Josh. 6:24; 8:19; 11:11). It will happen again in the Tribulation (Rev. 14:18).

15:8 Yahweh would desolate the land of Judah because His people had not been faithful to the Mosaic Covenant. The exiles could still be fruitful, but only if they remained faithful to the Lord.

"It is clear from Matthew 21:33-41 and other passages that God desires fruit. This is spiritual fruit, fruit of the spiritual life. Instead, God finds sour grapes or none at all. Unless men come into vital relationship with the true vine [cf. John 15:1], there can be no fruit. The vital link must be formed by faith."²⁵⁰

"This parable implies that the exiles had asked about God's consistency. They understood that they were his chosen people, his choice vine. How could he destroy them? They had been through the fire of two invasions and deportations by the Babylonians, but each time they had endured and sprouted up again. They did not believe that God's judgments would destroy Judah as Ezekiel had proclaimed."²⁵¹

7. Jerusalem's history as a prostitute ch. 16

This chapter is by far the longest prophetic message in the Book of Ezekiel, the longest single oracle in the Old Testament, and the longest single allegory in the entire Bible. It carries forward the guilt of Jerusalem described in the preceding chapter. In form it is a *rib* (lawsuit) oracle. God's chosen people were not only a vine that was good for nothing (ch. 15), but they had produced disgusting fruit (ch. 16). The Lord compared Jerusalem (a synecdoche for Israel) to a despised orphan who had become the beautiful wife of a king but had abandoned her privileges to become an insatiable prostitute (cf. Hos. 1—3). This chapter is also an elaborate personification.

"No one presses the margins of literary propriety as severely as Ezekiel. . . . But the semipornographic style is a deliberate rhetorical device designed to produce a strong emotional response."²⁵²

²⁵⁰Feinberg, p. 84.

²⁵¹Alexander, "Ezekiel," p. 808.

²⁵²Block, *The Book . . .*, pp. 466-67. On the problem of Ezekiel's portrayal of God's actions in this oracle, see *ibid.*, pp. 467-70.

"A sad parallel to this narrative is the course of Christendom in its departure from the purity of God's Word and the life of godliness."²⁵³

The birth of Jerusalem 16:1-5

16:1-2 The Lord instructed Ezekiel to make the detestable practices of the people of Jerusalem known to them. He prophesied to the exiles, but his message presented the people of Jerusalem as the primary object of his attention.

16:3-4 Yahweh personified Jerusalem as a woman (cf. Isa. 1:21), and he related her history as a parable (allegory). In this parable Jerusalem represents the people of Jerusalem (a metonymy), but it is the people of Jerusalem throughout Israel's history that are particularly in view. Some interpreters take Jerusalem as representing Israel as a nation.²⁵⁴ Others believe Jerusalem identifies the city that is only similar to the nation in its history and conduct.²⁵⁵ I think it is best to take Jerusalem as describing the city for three reasons. First, the Lord compared Jerusalem to two other cities, Samaria and Sodom (vv. 44-56, 61). Second, everything the prophet said about Jerusalem fits the city, its history and inhabitants. Third, the purpose of the parable was to convince the Jews in exile that the city of Jerusalem, specifically, would experience destruction because of the sins of its people. The purpose of the story was to show the exiles that the destruction of Jerusalem that Ezekiel predicted was well deserved so they would believe that God would destroy it.

Canaan was the place of Jerusalem's origin and birth, a land notorious for its depravity. Thus it was understandable that the Israelites would tend toward idolatry. Jerusalem's founders, in pre-patriarchal days, were Amorites and Hittites, not Hebrews. Amorites and Hittites were two of the Canaanite peoples, and they often represent all the Canaanites in the Old Testament (Gen. 10:15-16; 15:16; Num. 13:29; Josh. 1:4; 5:1; 7:7; 24:15, 18; Amos 2:10). The Jebusites, who occupied Jerusalem from its earliest mention in Scripture, were another Canaanite tribe. The Table of Nations lists the Jebusites between the Hittites and the Amorites (Gen. 10:15-16). When Jerusalem came into existence, she received no special treatment, not even normal care.

"It was the custom in the ancient Near East to wash a newborn child, rub it with salt for antiseptic reasons, and wrap it in cloths, changing these twice by the fortieth day after the umbilical cord was cut."²⁵⁶

²⁵³Feinberg, p. 85.

²⁵⁴E.g., Cooper, p. 167; Feinberg, p. 86; and Taylor, p. 133.

²⁵⁵E.g., Alexander, "Ezekiel," p. 810; and Dyer, "Ezekiel," p. 1255.

²⁵⁶Alexander, "Ezekiel," p. 811. See also Fisch, p. 84; Greenberg, p. 274; and Cooke, p. 162.

Jerusalem was not an outstanding city from its founding. Many other cities in Canaan had better situations geographically, had better physical resources, and were more easily defensible militarily.

- 16:5 No one had compassion on Jerusalem but abandoned her because she was an unwanted child. A common method of disposing of unwanted children in the ancient Near East, especially girls, was to abandon them to the elements.²⁵⁷ When the Israelites entered the land in Joshua's day, they did not take Jerusalem (Josh. 15:63).

The youth of Jerusalem 16:6-14

- 16:6 The Lord had compassion on Jerusalem in her helpless and undesirable condition and took care of her so she survived.²⁵⁸ The city remained as an unwanted child until, at the Lord's direction, David captured it from the Jebusites and made it the capital of his kingdom (2 Sam. 5:6-10).
- 16:7 The Lord enabled Jerusalem to thrive. Her inhabitants became numerous. She eventually developed into a fine city even though she had gotten a bad start in life. During the reigns of David and Solomon, Jerusalem was one of the most highly respected cities in the ancient Near East.
- 16:8 When she was mature enough, the Lord made a commitment to take care of her forever (cf. Ps. 132:13-17). Spreading a skirt over someone was a customary way of committing to marry and to provide for someone in that culture (Ruth 3:9).²⁵⁹
- 16:9-12 The Lord also prepared her for a special relationship with Himself. He cleansed and anointed her and clothed her with beautiful, expensive clothing including fine shoes. He also gave her jewelry to make her even more beautiful with bracelets, a necklace, a ring, earrings, and a crown (cf. Gen. 24:53; Ps. 45:13-15; Isa. 61:10). These were Jerusalem's glory days under Solomon's rule (cf. 1 Kings 10:4-5).
- 16:13-14 She had the best jewelry and clothes. She also ate the best food. In other words, the love of her husband knew no bounds. She became very beautiful and even qualified as royalty; she became a royal city that was home to the Davidic dynasty of kings. Other nations even commented on her beauty since it was so extraordinary because of the grace the Lord had bestowed on her (1 Kings 10; 1 Chron. 14:17; Lam. 2:15).

²⁵⁷See Pritchard, ed., *Ancient Near . . .*, p. 119; Zimmerli, p. 338; Wevers, p. 121; and Greenberg, p. 275.

²⁵⁸See Block, *The Book . . .*, p. 472, for the chiastic structure of verses 6-22.

²⁵⁹See P. A. Kruger, "The Hem of the Garment in Marriage: The Meaning of the Symbolic Gesture in Ruth 3:9 and Ezek 16:8," *Journal of Northwest Semitic Languages* 12 (1984):84-85.

The prostitution of Jerusalem 16:15-34

- 16:15 However, Jerusalem became self-centered and unfaithful to the Lord; she forgot Him when she became preoccupied with His blessings (cf. Deut. 6:10-12; 8). She went after every people that passed by rather than remaining faithful to Yahweh. Under King Solomon, Jerusalem became the greatest city of her day, but Solomon led the Jerusalemites into spiritual adultery by making alliances (covenants) with other nations and by establishing idolatry in the land (1 Kings. 11:1-13; cf. Deut. 17:14-20).
- 16:16-19 Jerusalem used the gifts that God had given her to make idols and to worship them rather than her Lord (2 Kings 23:7; Jer. 10:9). The people made phallic images out of God's gifts with which they engaged in sex (v. 17; cf. Isa 57:8), or perhaps full human figures are in view.
- 16:20-21 Jerusalem went so far as slaying her own children as sacrifices to idols disregarding the fact that they were also the Lord's children (2 Kings 16:3; 21:6; 23:10; 2 Chron. 28:3; Jer. 32:35; cf. Lev. 18:21; 20:1-5; Deut. 12:30-32). Evidently the idolaters first slew the children and then burned their dead bodies as sacrifices.
- 16:22 Furthermore, Jerusalem forgot about her humble origins and that she owed her very existence to Yahweh.
- "Many believers today tend to forget what Christ has done for them on the cross and all the blessings he has poured out on them (Eph 1:3)."²⁶⁰
- 16:23-25 On top of all this wickedness, Jerusalem multiplied shrines to idols everywhere. For this Yahweh pronounced a lament of horror on her (cf. 1 Sam. 4:8; Prov. 23:29; Isa. 3:9). She became a militant advocate of idolatry, not just a practitioner of it. She also made her beauty abominable by prostituting herself to every passerby. She pursued foreign alliances as well as foreign gods.
- 16:26-27 She committed adultery with her lustful neighbor, the Egyptians, and multiplied the instances of her harlotry thus angering the Lord further (2 Kings 17:4; 18:21; Isa. 30:7; 36:1). As punishment, the Lord diminished her support. He also gave her into the hands of the Philistines, pagan people who nonetheless were repulsed by her lewd behavior (2 Chron. 21:16-17; 28:16-19; Isa. 1:7-8).
- 16:28-29 She committed adultery with the distant Assyrians as well, but they did not satisfy her lust (2 Kings 15:19-20; 16:7-18). Neither did adultery with the merchant Chaldeans or the Egyptians satiate her (2 Kings 20:12-19; Isa. 20:5-6; 30:1-5; 31:1).

²⁶⁰Alexander, "Ezekiel," pp. 813-14.

"Jerusalem was a spiritual nymphomaniac."²⁶¹

Political alliances normally involved the weaker party taking the gods of the stronger ally into its religious system. This is how much idolatry entered Jerusalem.

16:30-34 All her brazen adulteries had left Jerusalem with a sick heart; she could no longer feel true love. She was worse than a common prostitute in that she practiced adultery not because she needed money from her lovers but simply because it made her feel good. She took strangers to bed with her instead of her husband. She even gave gifts to her lovers to bribe them to come to her (paying tribute to make alliances) rather than giving them what they wanted in payment for the bribes they would normally have offered her. Her adulteries were worse than those of common prostitutes in that she paid her lovers rather than receiving payment from them (cf. Hos. 8:9).

"Ezekiel enumerated at least eight reasons for the exile: pride (v. 15a), spiritual prostitution (vv. 15b-19), materialistic idolatry (vv. 16-19), human sacrifices (vv. 20-21), forgetting God (v. 22), propagating her prostitution (vv. 23-25), trusting relations with pagan nations (vv. 26-29), and a weak will that cast off all moral restraints (vv. 30-34)."²⁶²

The judgment of Jerusalem 16:35-43

16:35-37 Yahweh announced the judgment that He would mete out to Jerusalem because of all her unnatural and rebellious unfaithfulness, idolatry, and bloodshed. He would bring all the nations that Jerusalem had opened her legs to against her, and they would abuse and destroy her.

16:38-41 The Lord would deal with Jerusalem as people dealt with adulteresses and murderers. The punishment that the Mosaic Law prescribed for a city that practiced idolatry (spiritual adultery) was the sword (Deut. 13:15), and the punishment for adultery was stoning (Lev. 20:10; cf. John 8:4-5). Yahweh would punish Jerusalem severely in His wrath and jealousy. He would turn her over to her lovers who would take from her everything she had leaving her naked and bare, her original condition (cf. vv. 7, 22; Hos. 2:12; Nah. 3:5). "Naked" and "exile" are basically the same word in Hebrew. Exile meant for the Judahites collectively what nakedness meant to them personally. Thus the idea of nakedness became an apt description of the exile.

"The public exposure of the naked body was a symbolic act of legal punishment for adulterers . . .: it reversed the

²⁶¹Dyer, "Ezekiel," p. 1257.

²⁶²Cooper, p. 171.

husband's provision of clothing (v 10) and took away the wife's married identity [cf. Jer. 13:26; Hos. 2:10; Nah. 3:5]."²⁶³

Jerusalem's lovers would also incite other nations to attack and wage war against her. Her enemies would burn her houses and punish her in the sight of even more nations. This would end her prostitution.

- 16:42-43 This punishment would satisfy the Lord's anger against Jerusalem. She had enraged Him by not remembering His goodness to her and by her lewd conduct. Now He would punish her for that conduct so she would not practice it on top of all her other sins.

The depravity of Jerusalem 16:44-59

- 16:44-47 Other people would quote the proverb, "Like mother, like daughter," in regard to Jerusalem. She was like her Hittite "mother" who was also idolatrous and selfish. And she was like her older (larger) sister, Samaria, and its dependent villages, and her younger (smaller) sister, Sodom, and its dependent villages, both of which despised their husbands and children. The Hebrew text describes Samaria and Sodom as on Jerusalem's left (north) and right (south) respectively, reflecting the customary eastern orientation of the Old Testament. However, Jerusalem acted even worse than they. The depraved worship of the Canaanites had affected all three of these cities, but Jerusalem had become the worst of the lot.
- 16:48-50 The people of Sodom were not as bad as the people of Jerusalem (cf. 22:15; 2 Kings 15:37; 16:6; 24:2; 2 Chron. 28:18-19; Isa. 3:9; Jer. 23:14). The Sodomites were arrogant, affluent, selfish, and great sinners. Material abundance and physical security fostered sexual perversion (Gen. 13:13; 18:20; 19:4-5). The Lord removed them when He saw their sins (cf. Lam. 4:6; Matt. 11:23-24).
- 16:51-52 Samaria was bad, but not half as bad as Jerusalem. In fact, Jerusalem made her wicked sister cities look good by comparison. This was a disgrace to Jerusalem, that she had made other wicked cities look righteous (cf. Matt. 11:23-24).
- 16:53-55 Jerusalem would experience captivity as Sodom and Samaria had. Evidently the Lord meant that the people of Sodom had experienced captivity in the sense that He had taken them away. Jerusalem's captivity would bring humiliation and shame to her people when they realized that their judgment had been a comfort to the people of Sodom and Samaria. Obviously these people were now dead, but the parabolic form of this message allows for some unusual details. Jerusalem's captivity had

²⁶³Allen, p. 242. Cf. Kruger, p. 82.

showed them that Jerusalem was worse than these towns. Yet the Lord would end the captivity of all these towns; their descendants would have a future (cf. Deut. 30:3).

"The main point seems to be that God's willingness to restore Jerusalem, despite the magnitude of her sin, offers hope for other sinful nations, even those who violate his moral standards in blatant ways."²⁶⁴

16:56-57 Many people of Jerusalem did not even speak of the Sodomites because they were such great sinners. Yet in the future the people of Edom and the Philistines, Israel's ancient enemies, would not speak of the Jerusalemites because they were such great sinners.

16:58-59 The Jerusalemites were bearing the penalty of their lewdness and abominations; the Babylonians were threatening to destroy them completely. The Lord promised to deal with them as they had dealt with Him. They had despised His covenant, and now He would despise them.

The restoration of Jerusalem 16:60-63

16:60-61 Yet the Lord promised to remember and stand by His promises in the Abrahamic Covenant (Gen. 12:1-3). He would establish a new, everlasting covenant with His people in the future (cf. 11:18-20; 36: 26-28; 37:26-28; Isa. 59:21; 61:8; Jer. 31:31-34). The New Covenant is an organic outgrowth of the Abrahamic Covenant in that it explains further the blessing aspect of that covenant. It does not have the same relationship to the Mosaic Covenant, which it eventually replaced. In the (far distant) future, when the other cities of Canaan would come under Israel's authority (ch. 48; Gen. 17:7-8; Lev. 26:42), the Israelites would remember their sinful ways and feel ashamed (cf. 20:43; 36:31; Zech. 12:10-14). Other nations would come under Israel's authority, not because of her faithfulness to the Mosaic Covenant, but because of God's grace.²⁶⁵

"God can no more help being gracious than He can cease being God. He is the God of all grace, and He always finds a covenant basis on which He can exercise His grace."²⁶⁶

16:62-63 The Lord promised to establish His new covenant with His people, and then they would know that He was Yahweh. He would do this to humble His people and to stimulate them to obey Him by demonstrating forgiveness (cf. 2 Tim. 2:13).

²⁶⁴Chisholm, *Handbook on . . .*, p. 252.

²⁶⁵See Martin H. Woudstra, "The Everlasting Covenant in Ezekiel 16:59-63," *Calvin Theological Journal* 6 (1971):22-48.

²⁶⁶Feinberg, p. 92.

8. The riddle and parable of the two eagles ch. 17

This message addressed another objection to the destruction of Jerusalem that the exiles entertained. The preceding parable placed much emphasis on Jerusalem's long history of unfaithfulness to the Lord's marriage covenant with her. Was the Lord fair in destroying Jerusalem now since former generations of Judahites had been unfaithful? The present fable clarified that Judah's recent leaders were also unfaithful and worthy of divine judgment. See 2 Kings 24:6-20; 2 Chronicles 36:8-16; and Jeremiah 37 and 52:1-7 for the historical background of the events described in this riddle.

". . . what Ezekiel's pantomime [the sign of the departing deportee, 12:1-16] was to drama, this figure is to rhetoric. Both involve caricature—the first in the form of a dramatic presentation, the second as a literary cartoon—and both require interpretation."²⁶⁷

"There is obvious logic in the movement of the theme through four distinct stages, each involving a new plane of action: (1) an imaginative fabulous image [vv. 1-10]; (2) a historical interpretation of the fable (vv. 11-18); (3) a theological interpretation of the historical events (vv. 19-21); (4) a theological portrayal of the future (vv. 22-24)."²⁶⁸

The riddle 17:1-10

17:1-2 The Lord directed Ezekiel to present a riddle (Heb. *hidah*, allegory, enigmatic saying) and a parable (Heb. *mashal*, proverb, comparison) to his audience of Jewish exiles. This is the longest *mashal* in the Old Testament and quite a detailed one.

"It is a riddle in that its meaning needs to be explained; there is a deeper meaning which underlies the figurative form, for something in its presentation is obscure. It is a parable in that it is an allegory."²⁶⁹

"Riddles excite the curiosity and leave the baffled listeners keen for an answer. What follows is not a true riddle but a fable or theological cartoon that is equally intended to whet the hearers' appetites for the plain oracle that follows."²⁷⁰

"A 'riddle' . . . was commonly used in international politics between kings . . . If one failed to answer the riddle of the other, he might be called on to submit to him as a vassal. In some cases he might even be put to death."²⁷¹

²⁶⁷Block, *The Book . . .*, p. 523.

²⁶⁸Ibid., p. 526.

²⁶⁹Feinberg, p. 94.

²⁷⁰Allen, p. 256.

²⁷¹Alexander, "Ezekiel," p. 820. See Harry Torczyner, "The Riddle in the Bible," *Hebrew Union College Annual* 1 (1924):125-49.

The purpose for using riddles was apparently to test the intelligence or cleverness of the hearer (cf. Judg. 14:12-19; 1 Kings 10:1; 2 Chron. 9:1; Matt. 13).²⁷²

"This allegory differs from others Ezekiel was commanded to tell his audience because of its opaqueness, so he was to tell it as a riddle (v. 2)."²⁷³

17:3-6 In this riddle, a powerful and impressive eagle came to Lebanon, cropped off the top of one of its famous cedar trees, and carried these twigs to a land of merchants and a city of traders. This eagle also took some of the seed from Lebanon and planted it in fertile soil near a body of water so it would flourish, like a willow tree (cf. Isa. 44:4). This seed sprouted and became a low, spreading vine (cf. 15:1-8) that sent out branches upward toward the eagle and roots downward.

Lebanon was an alternative name for the land of Canaan that emphasized its great beauty and fruitfulness (cf. Josh. 1:4; 2 Kings 14:9). The Lord evidently used it here because He wanted to develop the idea of a bird plucking the top off a tree, and this was more typical in Lebanon than in Israel because of Lebanon's many cedar trees.

17:7-8 Another large eagle, not quite as glorious as the first, came along. The vine reached out with its branches and roots toward it so this eagle might water it. The vine did this even though it was growing in good soil with abundant water nearby, enough to make it a luxuriant and fruitful plant.

17:9-10 The Lord rhetorically asked if the owner of such a vine would not pull it out of its soil and cause it to wither and become unfruitful. Nothing that anyone could do could cause such a vine to recover its original health and fruitfulness after such treatment (cf. vv. 22-24). Even though its roots were still in the ground it would not thrive. The hot east wind would easily wither it where it grew (cf. 19:12; Job 27:21; Isa. 27:8; Hos. 13:15).

The explanation of the riddle 17:11-21

Ezekiel first interpreted his fable historically, and then he interpreted the historical events theologically for his audience.

The historical interpretation of the riddle 17:11-18

17:11-12 Ezekiel was now to tell his rebellious hearers what this story represented. This interpretation is a typical example of a prophetic judgment speech to

²⁷²See C. Hassell Bullock, *An Introduction to the Old Testament Poetic Books*, p. 22; and T. Polk, "Paradigms, Parables, and *Meshalim*: On Reading the *Mashal* in Scripture," *Catholic Biblical Quarterly* 45 (1983):578.

²⁷³Stuart, p. 148.

an individual, many of which appear in the prophetic books of the Old Testament. It contains a summons to listen (vv. 11-12a), charges (vv. 12b-18), and assurance of judgment (vv. 19-21).²⁷⁴

The first eagle stood for the king of Babylon, Nebuchadnezzar (cf. Jer. 48:40; 49:22; Dan. 7:4). His invasion of Jerusalem (the specific identity of the Lebanon in the riddle, v. 3) devastated the land like a hot east wind (v. 10).

In Scripture the eagle is often a figure used to describe God as a powerful being that comes swiftly to judge, as an eagle swoops down quickly to snatch in flight an unsuspecting mouse or fish (cf. Deut. 28:49; Isa. 46:11; Jer. 48:40; 49:22). In this case the eagle represented God's instrument of judgment, Nebuchadnezzar, who had invaded Jerusalem, cropped off the Judean king, Jehoiachin (the top of the cedar tree, v. 3), and his advisers (the topmost of its young twigs, v. 4) and carried them off to Babylon in 597 B.C. (cf. Dan. 7:4). Babylon was a city of traders in a land of merchants (v. 4; cf. 16:29; 1 Kings 10:27; 2 Kings 24:10-12; Jer. 22:15, 23). Elsewhere in Scripture the cedar tree (v. 3) is a figure used to describe the Davidic line of kings culminating in Messiah (Isa. 10:33—11:1). Cedar trees were beautiful and very hardy, an appropriate figure of the Davidic dynasty.

17:13-14 Nebuchadnezzar set up another king as his vassal, Zedekiah, one of the royal seed whom he planted in the fertile soil of Canaan (cf. v. 5). He deported the leaders of Judah to Babylon so Judah would be a docile servant and continue to exist with a measure of independence under his control (cf. 2 Kings 24:17; Jer. 37:1). Nebuchadnezzar made a binding covenant with Zedekiah obligating him to serve Babylon, and Zedekiah flourished for a time. The vine's roots remained under it, but it grew low and spreading rather than upward and fruitful, and it extended its branches toward the eagle, Nebuchadnezzar (cf. v. 6).

17:15-16 However, the vine rebelled against the eagle. Zedekiah rebelled against Nebuchadnezzar and sent to Egypt for arms and troops to resist the Babylonians. Pharaoh Hophra (Gr. Apries, 589-570 B.C.) is the second strong eagle in the riddle to which the vine sent out its roots and branches for sustenance, probably in 588 B.C. (v. 7). If this prophecy is in chronological order, as seems likely, Ezekiel gave it between 592 (8:1) and 591 B.C. (20:1). This means that he predicted Zedekiah's revolt about three years before it happened. For years the pro-Egyptian faction in Jerusalem had advocated seeking help from that direction. Obviously Zedekiah could not escape Nebuchadnezzar's wrath since he had broken the covenant under which he served him, a covenant that he had sworn in God's name (cf. 5:7; 2 Chron. 36:13).

²⁷⁴See Claus Westermann, *Basic Forms of Prophetic Speech*, pp. 169-94.

"When Zedekiah made his oath of allegiance to Nebuchadnezzar, the Lord's name was invoked as a guarantor of the treaty (see 2 Chron 36:13). Consequently when Zedekiah broke his oath to Nebuchadnezzar, he in effect broke a treaty with God."²⁷⁵

An oath was a sacred thing in the ancient Near East, and even oaths made by fraud were normally honored (cf. Josh. 9; 2 Sam. 21:1-2). The Lord swore that Zedekiah would die in Babylon for breaking his covenant with Nebuchadnezzar (cf. v. 19).

"After judgment became inevitable, God's will for Judah was submission to their foreign conquerors as a sign of their submission to him (Jer 38:17-23)."²⁷⁶

17:17-18 Pharaoh would not come to Zedekiah's aid when Nebuchadnezzar invaded and besieged Jerusalem and slew many of the people. There was no way that Zedekiah could escape Nebuchadnezzar's wrath since he had broken the covenant in which he had pledged his allegiance to the Babylonian king.

The theological interpretation of the historical events 17:19-21

17:19-21 The Lord also promised that because Zedekiah had broken Israel's covenant with Yahweh he would pay the penalty. The Lord would capture him like an animal in a net, bring him to Babylon, and judge him there for his covenant unfaithfulness to Yahweh. His best soldiers would die, and the survivors of the siege would scatter. When this happened everyone would know that Yahweh had ordained Jerusalem's destruction.

The theological epilogue to the riddle 17:22-24

Like the preceding parable, this one also ends with a promise of hope (cf. 16:60-63).

17:22-23 The Lord Himself would also snip a tender twig from the top of the tall cedar tree that represented the Davidic line of kings. (The eagle is no longer Nebuchadnezzar but Yahweh in this parable.) Yahweh would plant this twig on a high mountain in Israel so that it would grow there, produce sheltering boughs, and bear fruit. Birds of every kind would come and take refuge in its shady branches. People would dwell securely under the protection of this great kingdom (cf. Hos. 14:5-7; Dan. 4:12, 21; Matt. 13:32; Mark 4:32).²⁷⁷

²⁷⁵Chisholm, *Handbook on . . .*, p. 253.

²⁷⁶Cooper, p. 182.

²⁷⁷For discussion of the ancient mythological "cosmic tree," of which Ezekiel's tree is a variation, see Block, *The Book . . .*, p. 551.

"Israel will protect surrounding nations rather than being their pawn. . . .

"Ezekiel compared God's future actions to those of the two eagles (Babylon and Egypt) already mentioned. Neither of those eagles had been able to provide the security and prosperity Israel desperately longed for, but God would succeed where they had failed."²⁷⁸

The tender twig seems clearly to be a messianic reference (cf. Isa. 11:1; Jer. 23:5-6; 33:14-16; Zech. 3:8; 6:12-13). The high mountain is probably Mount Zion, the place where Messiah will set up His throne in the Millennium (cf. Ps. 2:6). Then the cedar tree (messianic kingdom) will be very stately and fruitful.

17:24 At that time the other nations (trees) would know that the one who had done this was Israel's God. He would cut down the high tree (Babylon?) and exalt the low tree (Israel). He would dry up the presently green tree (Egypt?) and make the presently dry tree (Israel) flourish. The one who promised this was Yahweh, and He would also perform it.

"Although some have understood it to have been fulfilled in the restoration of Judah under Zerubbabel, Ezra, and Nehemiah, the language goes beyond such limited scope (cf. Ezra 9:8-9) to a time yet future when Israel will have its perfect King, the Messiah, reigning on the earth in righteousness."²⁷⁹

"These concluding verses without question introduce a Messianic prophecy (cf. Isa. 2:2-4; Micah 4:1-4)."²⁸⁰

9. The importance of individual righteousness ch. 18

This chapter, like 12:21-28, corrected a common proverb. This one dealt with the people's false view of the reason for their judgment by God. In form it is a complex disputation speech.

"This doctrine of transgenerational accountability was widespread in the ancient Near East."²⁸¹

"In Chapters 18 and 33 are contained some of the most thorough, carefully expressed, and absolutely clear discourses on the topic of the responsibility of the individual for his or her own sins found anywhere in

²⁷⁸Dyer, "Ezekiel," p. 1259.

²⁷⁹Cooper, p. 184. See also Merrill, p. 381.

²⁸⁰Feinberg, p. 97.

²⁸¹Block, *The Book . . .*, pp. 558-59.

the Bible. These passages provide a valuable correction to the potential errors of fatalism, rigid determinism, and blame-avoidant judgmentalism."²⁸²

The principle 18:1-4

18:1-2 The Lord told Ezekiel to ask the people what they meant when they used a proverb that implied that the present generation of Israelites was suffering because of the sins of their forefathers (cf. Jer. 31:29). They were claiming to be the innocent victims of the actions of others, blaming others for their condition. In this they sounded just like many in our own day who refuse to take personal responsibility for their actions.

"The problem that the proverb poses for Ezekiel is not with punishment that children are bearing for the sins of the fathers, or even the issue of theodicy [i.e., the justice of God]. On the contrary, it reflects a materialistic fatalism, a resignation to immutable cosmic rules of cause and effect, an embittered paralysis of the soul, that has left the exiles without hope and without God. To the extent that the charge concerns God at all, it accuses him of disinterest or impotence in the face of the exiles' current crisis. All these years they have put their trust in their divine patron, only to discover that they are victims of an immutable law of the universe: the fate of one generation is inexorably determined by the actions of the previous. Their theology and their God have betrayed them.

"Ezekiel will have none of this. In fact, the proverb becomes the point of departure for an extended lecture on a universe with unlimited room for movement, and for divine grace open to all who will listen."²⁸³

Earlier the Lord had told this same audience that other people would quote the proverb, "Like mother, like daughter" (16:44). This proverb expressed the fact that the Israelites were behaving as the Canaanites did. Ezekiel himself had said that the sufferings of the Exile were traceable to the persistent rebellion, idolatry, and unfaithfulness of former generations of Israelites (ch. 16). Now Ezekiel's hearers concluded that God was being unfair in punishing them for their ancestors' sins. They may have cited what they thought was biblical support for this conclusion because even earlier the Lord had said that He would visit the iniquity of the fathers on the children to the third and fourth generations of those who hated Him (Exod. 20:5; 34:6-7; Deut. 5:9).

²⁸²Stuart, p. 19; cf. p. 150.

²⁸³Block, *The Book . . .*, p. 561.

It is true that the sins of parents result in consequences for their children, grandchildren, and even great-grandchildren that we might call the "fallout" of the parents' sins. But it is not correct to say that God "punishes" children because their parents have sinned. This is the conclusion that the Israelites in exile had drawn and that this chapter refutes (cf. Jer. 31:27-30; Lam. 5:7). True, some of what Ezekiel's hearers were experiencing were the consequences of the sins of former generations. But God was judging them personally because they were personally responsible for their actions that were sinful (cf. 3:16-21; 14:12-20; 33:1-20). God had revealed this principle of individual responsibility long ago (cf. Gen. 2:17; 4:7; Deut. 24:16; 2 Kings 14:6).²⁸⁴

An illustration of this important distinction may help. Suppose a child grew up in a home in which the parents had no respect for God and, therefore, set a very bad example for their child. The child would naturally follow their lead and learn some sinful attitudes and actions. His parents' influence would adversely taint the child's life. However, God would not take out His wrath on that child because of his parents' sins. He would rather deal with that child on the basis of his or her own attitudes and actions.

Parental influence extends beyond their actions to their characters and even perhaps to their genes. Children of an addicted parent, for example, often have a predisposition to the same or a similar addiction. Parents who have indulged their temptations to sexual promiscuity not infrequently see their own children grow up unusually vulnerable to this temptation. Parents with certain character flaws often note the same weaknesses in their children. Yet the child's will to follow God, enabled by His grace and Spirit, can overcome "hereditary sin."

18:3 The Lord instructed the people not to use this proverb in Israel any more. It implied something about God's dealings with them that was not true. No one can excuse his or her sinfulness on the basis of his or her ancestors. Human beings are free to make their own decisions, and we are responsible for the consequences of those decisions.

"The implication is clear that man has the ability to determine his final condition."²⁸⁵

Other passages stress the sovereignty of God and may appear to contradict this clear revelation of human responsibility (e.g., Rom. 9; Eph. 1). Nevertheless both are true even though we cannot understand how both can be true. Their truthfulness lies in the truthfulness of the One who

²⁸⁴See further, Robert B. Chisholm Jr., "How a Hermeneutical Virus Can Corrupt Theological Systems," *Bibliotheca Sacra* 166:663 (July-September 2009):263-64.

²⁸⁵Feinberg, pp. 102-3.

revealed them, not in our ability to comprehend them, which is limited by our humanity and obscured by our sinfulness.

18:4 The true principle, in contrast to their proverb, was that everyone is personally responsible to God, the present generation and former generations. We bear the guilt of our own sinfulness, which results in our death, not the guilt of someone else (cf. 3:18-21). "Souls" (Heb. *nephesh*) means "lives" (cf. 13:20), not disembodied spirits.

"The story of Achan in Josh 7:1-26 is a classic example of corporate responsibility. Achan sinned, but his whole family suffered for his sin. Such a passage is difficult to understand unless we see the biblical distinction between guilt and consequences. In Achan's case he was the guilty party (7:21), but his family, who may have shared guilt by remaining silent about his misdeed, shared at least the consequences of his guilt, which was death by stoning. This was the point made in Exod 20:5 and 34:6-7. Individually each person is responsible for his or her own guilt of sin. But we must always be aware that the consequences of sin will affect others who may be innocent of the guilt for that particular sin. This is true even when the sin is forgiven. God promised to remove the guilt of sin, but most often the consequences remain. David is a good example. Though he was forgiven of his sins of adultery and murder, he still suffered the consequences (2 Sam 12:11-20)."²⁸⁶

The illustrations 18:5-18

Three cases illustrate this principle: a father doing right (vv. 5-9), his son doing evil (vv. 10-13), and his grandson doing right (vv. 14-18). In each case Ezekiel described the individual's actions and the Lord's responses.

The case of the righteous father 18:5-9

18:5-6 If a person behaved righteously and obeyed the Mosaic Law, that person would live. This is the basic point. Evidence of righteousness before God was typically obedience to specific commands in the Law. The Lord cited five types of behavior that manifested departure from the will of God under the Mosaic Law.

First, eating ceremonial meals at idol shrines and trusting in idols were forbidden but practiced by the Jews in Ezekiel's day (cf. Deut. 12:2-4). This was a violation of the first four commandments in the Decalogue that required exclusive allegiance to Yahweh.

²⁸⁶Cooper, pp. 189-90.

Second, committing adultery and having sex with a woman during her menstrual period were practiced even though God prohibited them (Exod. 20:14; Lev. 15:24; 18:19; 20:10, 18; Deut. 22:22). The prohibition against having intercourse with one's wife during her period was clear in the Mosaic Law, but when Jesus terminated that code as the basis for believers' conduct this law no longer remained binding on believers (Heb. 7:11-12). The New Covenant teaching of believers' present duties says nothing about this practice. It is now a matter of choice (liberty) for believers.

This and the following three cases are examples of the fifth through the tenth commandments that specify how one should treat other people. With regard to himself, the righteous man maintained his moral and ceremonial purity even in the privacy of his marital life.

18:7 Third, oppressing others and not returning something given as collateral when someone returned what he had borrowed were violations of the covenant (Exod. 22:26-27; Deut. 24:6). This is an example of life within the covenant community but outside the marriage relationship.

Fourth, not robbing but instead providing food and clothing to the needy were commanded (Deut. 15:11; 24:19-22; cf. Isa. 58:7). Both of the examples in this verse deal with one's relationships to the neighbor inside and outside Israel. Both examples also specify the correct action in contrast to the incorrect.

18:8 Fifth, not charging interest of other Israelites or practicing iniquity but providing true justice and faithfully doing all that God required of His people further represented doing God's will. The selfishness of the Jewish usurers cut to the very heart of their sinfulness. Again, God specified correct conduct as well as condemning sin (cf. v. 7).

18:9 In sum, the Israelite who lived by the Mosaic standards was righteous in behavior and could anticipate a long life of blessing from God (Lev. 18:1-5; Deut. 11; 26:16-19; 30:15-20; cf. Phil. 3:6). Clearly one's attitudes and actions toward other people demonstrate his or her attitudes and actions toward God.

The case of the wicked son 18:10-13

Such a righteous person might have an unrighteous son who violently shed the blood of others. This son might do all the bad things that his father avoided doing and might fail to do all the good things that his father did. He would die for his own sins; the responsibility for his death would be his own.

The case of the righteous grandson 18:14-18

This sinful son might have a son who observed his father's behavior and chose to follow the example of his righteous grandfather rather than that of his unrighteous father. He

refrained from the same evil practices and engaged in the same forms of goodness. That man would surely live for his righteousness whereas his father would die for his wickedness. Wicked parents do not necessarily produce wicked children because the children can choose to do right. The Israelites had illustrations of this alternation of good and evil individuals in succeeding generations even in the royal family. King Hezekiah, for example, was good, his son Manasseh was bad, and Manasseh's grandson Josiah was good.

". . . in this world God does indeed punish entire *groups* for the sins that they *as groups* commit, even when some members of the group may be innocent. Such groups are often nations, cities, or other political entities, but they may also be societal groups such as priests or prophets, or economic groups such as businesses or trade guilds, or such voluntary associations as churches."²⁸⁷

The first objection: God's conduct 18:19-23

God proceeded to adopt a dialogical teaching style in which He both asked and answered questions about individual responsibility. This style is quite similar to the Greek diatribe, which Paul used frequently in his writings (e.g., in Romans).

18:19-20 The Israelites were claiming that a righteous son (themselves) would die for his father's (their ancestors') wickedness. But this was not true. Individuals who practiced righteousness would experience God's covenant promise of blessing on their lives even though their fathers practiced wickedness. People die for their own sins, not for the sins of their fathers or the sins of their sons. Likewise people who behave righteously experience the consequences of their personal conduct just as people who behave unrighteously do. Jeremiah, for example, did not die in the Babylonian invasion of Jerusalem.

It is true that we are sinners not only because we practice sin personally (Rom. 3:23; 6:23) but also because we were born with a sinful human nature that we inherited from our parents (Ps. 51:5; Eph. 2:3; Gal. 5:17) and because God imputed the sin of Adam to us (Rom. 5:12-21). However here the point is that people do not die for the sins of their parents, grandparents, children, or grandchildren but for their own sins.

18:21-22 If a wicked person repented of his wickedness and pursued righteous behavior, he would live and not die. God would pardon his sins because he had turned from them and practiced righteousness. For the Jews still in Jerusalem this might mean deliverance from death at the hands of Babylon's invading soldiers.

²⁸⁷Stuart, p. 155.

This did not mean that doing good works would atone for past sins eternally. It meant that doing good works could preclude God's judgment of premature physical death, a judgment promised under the Mosaic Law for those who practiced wickedness. This whole chapter deals with the consequences of good and bad conduct *in this life* under the Mosaic Covenant. It does not deal with the subject of eternal life. Eternal life has always come to a person by faith alone (Gen. 15:6; Rom. 4:5; Eph. 2:8-9).

"The stipulations of the Mosaic covenant were given to a people who were already in a trusting relationship with God. These stipulations provided a concrete, practical outworking of faith in the God who redeemed Israel from Egypt and gave the people his law. . . . If they obeyed these commands, they would show their righteousness, receive God's blessings, and live. But if they failed to live according to God's ways as revealed in the law, the Mosaic covenant declared that even those who had believed . . . would die physically (cf. Deut 28:58-66; 30:15-20)."²⁸⁸

18:23 "Why would God allow a sinner who repented to avoid judgment? The answer lies in God's character."²⁸⁹

God explained that He took no delight in people dying because of their sins. What gave Him pleasure was their turning from their sinful conduct and so continuing to live.

"Such a longing should be shared by every preacher who ventures to speak about the judgment of God."²⁹⁰

The second objection: God's justice 18:24-29

The Jews to whom Ezekiel ministered went beyond questioning God's conduct. They also questioned His justice.

18:24 A turn in the other direction would have the same result. If a person turned from righteous conduct and pursued a life of sin, God would punish him with premature death for his sins even though he had formerly done right.

"An individual's relationship with God when the judgment arrives determines whether he will live or die."²⁹¹

²⁸⁸Alexander, "Ezekiel," p. 824.

²⁸⁹Dyer, "Ezekiel," p. 1261.

²⁹⁰Taylor, p. 151.

²⁹¹Dyer, "Ezekiel," p. 1261. Cf. *The New Scofield* . . . , p. 857.

"A generation is not predetermined for judgment or for blessing by the previous one. Even within a generation, or within an individual life, the past does not necessarily determine the present or the future."²⁹²

"Ezekiel has hereby repudiated the notion of a 'treasury of merit or demerit' on two counts. First, one generation cannot build up such a treasure [*sic*] for another; each individual determines his or her own destiny by his or her own conduct. Second, an individual cannot build up such a treasury in one phase of his or her life and count on this to balance off a deficit later."²⁹³

18:25 In spite of God's righteous dealings with people on the basis of their conduct, the Israelites were accusing Him of not doing right. The Lord asked if it was their ways rather than His that were not right.

18:26-28 The Lord repeated for clarification that turning to sin results in death but turning from sin (obeying God's covenant stipulations) results in life (cf. vv. 21-22, 24; Rom. 6:23). Clearly He meant that a final turning is in view rather than a superficial or temporary turning. If a person abandons God to pursue a life without God (i.e., apostasy), or vice versa, the result will be death or life respectively.

"The reference is not to a temporary lapse, but to a persistent choice of evil which changes the course of a man's life."²⁹⁴

18:29 Nevertheless the Israelites were claiming that God's ways were not right. It was really their ways that were not right (cf. v. 25).

The appeal 18:30-32

18:30 In closing, God promised to judge each Israelite according to his or her own conduct. He urged His people to turn from their transgressions of His law so their sins would not prove to be what tripped them up as they journeyed through life.

18:31 They needed to adopt a new heart attitude, a new spirit, a spirit of compliance to God's will. It was unnecessary that they die prematurely for their sins when they could turn from them and continue to live (cf. Rom. 13:14).

²⁹²Cooper, p. 191.

²⁹³Block, *The Book . . .*, p. 583.

²⁹⁴Taylor, p. 151.

18:32 This death among His people gave the Lord no pleasure (cf. v. 23; Isa. 28:21; John 5:40; 1 Tim. 2:4; 2 Pet. 3:9). He called them to change their attitude, to practice obedience to the covenant, and to live. Repentance was possible for the generation of Jews to whom Ezekiel ministered in Babylon.

God still deals with people in the same righteous manner under the New Covenant as He did under the Old. Whereas our responsibilities under the New Covenant are somewhat different from Israel's under the Old, the Lord still holds His people personally responsible for our obedience to His will. Personal failure to obey still affects our present lives negatively, and personal obedience still affects our lives positively. As Christians we are personally responsible for our actions, just as the Israelites were. Our personal actions will affect our lives just as was true in Israel. For Christians, who live under the New Covenant, premature death may be God's judgment for sin (e.g. Acts 5:1-11; 1 Cor. 11:30; 1 John 5:16). However, under the New Covenant what we do in this life also has eternal consequences, not that we will lose our salvation, but we will suffer the loss of some eternal rewards (Rom. 14:10-12; 1 Cor. 3:8-15; 2 Cor. 5:10).²⁹⁵ The Lord normally gave Old Testament saints the hope that their reward would come before they died (but see Dan. 12:2-3, 13), but He has given Christians the hope that our reward will come mainly after we die. God has always justified people for their trust in Him, and He has always rewarded them for their works.

"The Church in every generation must be alerted to a future judgment seat that is to be a sober constraint and incentive in present living (Rom 14:10, 12; 2 Cor 5:10; Gal 6:7-8). The necessity of continuance in the faith and in a lifestyle that commends it is backed by grave provisos from which no believer is exempt (Rom 11:22; 1 Cor 15:2; Col 1:23; Heb. 3:14)."²⁹⁶

"Few units in Ezekiel match ch. 18 for the transparency and permanent relevance of their message."²⁹⁷

10. A lament for the kings of Israel ch. 19

This prophecy shows that there were no more rulers left in Judah who could restore the nation to its former glory. Evidently the exiles hoped that some Davidic descendant would prove successful in overcoming the Babylonians and restoring Israel's sovereignty. This was their last hope, and it is the last prophecy in this section of the book that shows that such a hope was futile.

²⁹⁵For an exegetical study of believers' rewards under the New Covenant, see Joseph C. Dillow, *The Reign of the Servant Kings: A Study of Eternal Security and the Final Significance of Man*, pp. 515-32. For a more popular treatment of the same subject, I recommend Joe L. Wall, *Going for the Gold*. See also the Doctrinal Statement of Dallas Theological Seminary, Article XVI: The Christian's Service, par. 2.

²⁹⁶Allen, p. 281.

²⁹⁷Block, *The Book . . .*, p. 589.

The prophecy contains two parts. The first part (vv. 1-9) uses the figure of a lion and her cubs to describe the Davidic line and two of its kings. The second part (vv. 10-14) uses the figure of a vine to describe Israel including its final strong branch or king.

The lion and her cubs 19:1-9

19:1 Ezekiel was to lament (Heb. *qinah*) for the princes of Israel. This is the first of five laments in Ezekiel (cf. 26:17-18; 27; 28:12-19; 32:1-16). Laments usually utilize the *qinah* or limping form of rhythm in Hebrew, and this one does. The *qinah* form consists normally of three accented words followed by two accented words in a couplet. For example in verse 2 in the NASB this rhythm is discernible: "She lay down among young lions; she reared her cubs." Usually translations cannot capture the rhythm of the Hebrew text. This rhythm gives a sorrowful feeling to the composition as it is read in Hebrew. The form is quite common in the Old Testament, especially in Lamentations, Psalms, and some of the prophetic books.²⁹⁸

"A dirge was normally sung or chanted, by professional mourners after the death of the deceased and during his funeral. Ezekiel expressed the Lord's sadness over the Judean leadership's failure by chanting this elegy over her final rulers prior to their deaths . . ." ²⁹⁹

However this dirge is also a riddle (cf. 17:1-10). Ezekiel used the term "princes" to describe Judah's kings (7:27; 12:10, 19; et al.).

19:2 The prophet compared the former Davidic kings of Judah to a lioness. This was a common symbol of rulers in the ancient Near East, and the Israelites used the figure for the Davidic kings (Gen. 49:9; Num. 23:24; 1 Kings 10:19-20; Mic. 5:8; cf. Rev. 5:5).³⁰⁰ This lioness was responsible for producing and nurturing young lion cubs, the kings that followed in the Davidic line.

19:3-4 One particular ruler in the Davidic line became lion-like. He tore his prey and devoured people. When his neighbors heard about him, someone captured him and brought him as a prisoner to Egypt.

This describes the character and fate of King Jehoahaz who did evil in the Lord's sight by devouring people in his own kingdom through oppression and injustice (2 Kings 23:31-34). Even though his reign lasted only three months (in 609 B.C.) it was a violent and brutal period in Israel's history. Pharaoh Neco placed Jehoahaz on Judah's throne after Neco killed his

²⁹⁸For other characteristics of the *qinah* genre, see Block, *The Book . . .*, pp. 592-93.

²⁹⁹Alexander, "Ezekiel," p. 830.

³⁰⁰See Pritchard, ed., *Ancient Near . . .*, p. 300; and *ibid.*, ed., *The Ancient . . .*, plate 447.

father, Josiah, at Megiddo thereby gaining sovereignty over Judah. However, Jehoahaz proved to be unmanageable, so Pharaoh took him to Egypt where he finally died (2 Kings 23:31-34; 2 Chron. 36:1-4; Jer. 22:10-12). The Judeans had hoped that Jehoahaz would return from Egypt and rule again in Judah, but that was not to be the case (cf. Jer. 22:10-12).

19:5-9 With the death of this cub the lioness took another of her offspring and made him dominant. He gained his position among the other rulers of the area and also became violent and destructive, like the first cub. He so devastated his own land that the people in it despaired. His neighbors also trapped this lion and took him captive to Babylon thus ending his reign.

This describes the career of King Jehoiachin, who also ruled over Judah for only three months (in 598-597 B.C.). Probably the writer omitted referring to King Jehoiakim, the intervening king, because he was not taken into exile like Jehoahaz and Jehoiachin. Other interpreters believe King Jehoiakim is the person in view.³⁰¹ The Babylonians captured Jehoiachin and took him into exile in 597 B.C. Later he enjoyed a measure of freedom, but he never returned to rule over Judah (2 Kings 24:8-17; 25:27-30; 2 Chron. 36:8-10).

The Last Five Kings of Judah

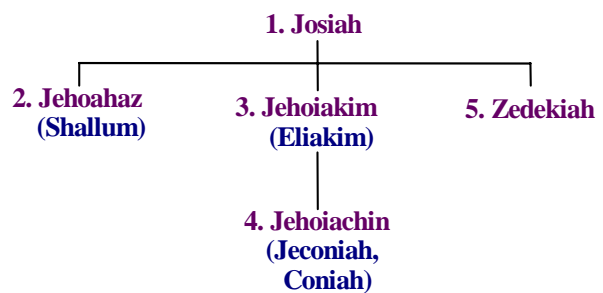

The vine and its branch 19:10-14

19:10-11 Ezekiel changed the figure of the Davidic dynasty to that of a fruitful vine in a vineyard. This vine was fruitful and it flourished because it enjoyed abundant resources. The Davidic dynasty was like a fruitful vine among the other nations because God blessed it (15:1-6; 17:1-10; Deut. 8:7-8; Ps. 80:8-16; Isa. 5:1-7; 24:7; 27:2-6; Jer. 2:21; 6:9; cf. Matt. 21:33-41; John 15:1-8). Its branches were so strong that they proved usable as scepters for rulers. The vine became exceedingly large in the season of its greatest glory, the days of David and Solomon.

19:12-14 However, others uprooted this vine in their fury, trod it underfoot, and cut off its fruitfulness as with a hot east wind (from Babylon; cf. 17:6-10, 15; Ps. 89:30-37). Its strong branch, King Zedekiah, was cut off so it withered and burned up. This was a prediction of Zedekiah's future. Assuming the chronological order of the prophecies in this book, Ezekiel evidently gave

³⁰¹E.g., Chisholm, *Handbook on . . .*, p. 256; and Block, *The Book . . .*, pp. 604-7.

this one between 592 and 591 B.C., which was after the reigns of Jehoahaz and Jehoiachin and during the reign of Zedekiah (597-586 B.C.). Zedekiah went into captivity in 586 B.C. He had been responsible for much of the destruction that had overtaken Judah. Perhaps one reason for the change in the figures describing Israel's kings, from lions to a vine, was that Zedekiah, the branch (v. 12), was not a king approved by the Judeans but a puppet of the Babylonians, though he was in the Davidic line. Scripture gives us little information about Zedekiah's domestic policies. The vine was now in the wilderness, a place of limited resources. It had burned up so there were no more strong shoots or fruit left in it. No scepter was in it now; there was no Davidic king who could rule over Israel. The vine was not completely destroyed, but it languished having been transplanted to a hostile environment. Another view sees Zedekiah as the fire that consumed the shoots and fruit of the Davidic line.³⁰²

The writer identified this piece again as a lamentation, a funeral dirge or elegy that the Jews used to describe their sorrow over the fate of the Davidic rulers of their nation.

It is appropriate that this last section in the part of the book that consists of Yahweh's reply to the invalid hopes of the Israelites (chs. 12—19) should be a lament. Judah's doom was certain, so a funeral dirge was fitting. All the exiles could do was mourn the divine judgment on their nation that was to reach its climax very soon.

"Jerusalem's fall was so certain that Ezekiel considered it inevitable. . . . The dirge was not over one individual; it was being sung for the Davidic dynasty and the 'death' of its rule."³⁰³

Not until Jesus Christ returns to the earth to reign will a strong branch and the ruler's scepter arise in the line of David again (cf. Gen. 49:10; Isa. 11:1; Jer. 23:5; 33:15).

D. ISRAEL'S DEFECTIVE LEADERSHIP CHS. 20—23

This section of the book is the final collection of prophecies that deal with the fall of Judah and Jerusalem. In these messages the prophet clarified further Yahweh's motivation in bringing this judgment.

"One of the hardest tasks of Christian leaders today is to keep our churches true to the Word of God so that people don't follow every religious celebrity whose ideas run contrary to Scripture."³⁰⁴

1. The history of Israel's rebellion and Yahweh's grace 20:1-44

The structure of this passage is quite clear. It consists of a review of Israel's history with an introduction and a concluding application.

³⁰²E.g., Stuart, p. 170.

³⁰³Dyer, "Ezekiel," p. 1262.

³⁰⁴Wiersbe, p. 198.

"The chapter is remarkable in that it shows a uniform moral plane sustained by the nation throughout its history."³⁰⁵

Other important themes in this chapter include God's faithful grace in spite of Israel's persistent rebelliousness, the repetition of a wilderness experience for Israel for her disobedience, and Yahweh's concern for His own reputation (name).

The introduction to a history lesson 20:1-4

20:1 Certain elders of the Jewish exiles came to Ezekiel to inquire of the Lord (cf. 14:1-11). Inquiring of the Lord meant securing a divine revelation concerning a particular event (cf. 1 Kings 14:5-18; 22:7-28; 2 Kings 8:8-15; 22:13-20; Jer. 21:2-14; 37:7-10). In view of the historical context of their request, the event that they wanted information about was probably King Zedekiah's attempt to secure Egypt's help in defeating the Babylonians.

"In the late summer of 591 B.C., the news of Egypt's victory in the Sudan reached the remnant of Judeans at Tel Abib. Rumors also indicated that [Pharaoh] Psammetik II would make a triumphal conquest of Palestine. The exiles' expectations were most certainly heightened as they hoped that Egypt would prove to be the redeemer to free them from Nebuchadnezzar. Zedekiah had foolishly shared the same dream when he revolted from Babylonian rule and placed his confidence in Egypt's strength somewhere between the end of 591 and 589 B.C. Such a move was ill-timed; for the Pharaoh soon became ill, and the potential might of Egypt never materialized."³⁰⁶

These elders probably wanted to know if Zedekiah's overtures to Egypt would be successful, if the Egyptians would help them defeat the Babylonians, and if the exiles could expect to return home soon.

This event happened in the seventh year of Jehoiachin's captivity, namely, 591 B.C. The tenth day of the fifth month would have been August 14.³⁰⁷ Eleven months had passed since Ezekiel began the preceding series of messages (cf. 8:1). The dating of the prophecy indicates a new section of the book and a new series of messages.

20:2-4 In response to the request of these elders, God gave His prophet a message for them. He told Ezekiel to say that He would not satisfy their curiosity about the matters that concerned them. However, Ezekiel was to

³⁰⁵Feinberg, p. 108.

³⁰⁶Alexander, "Ezekiel," p. 832.

³⁰⁷Parker and Dubberstein, p. 28.

communicate another message to these elders, a message that included judgment because of the Israelites' abominable idolatry throughout their history. The Lord's repeated question has the effect of an emotional imperative: you must pass judgment on them.

Israel's rebellion in Egypt and God's grace 20:5-9

The Lord's history lesson for these elders described Israel in four successive periods: in Egypt (vv. 5-9), in the wilderness (vv. 10-26), in the Promised Land (vv. 27-29), and in the present time (vv. 30-38). What the Lord said about Israel's history in each of these four periods is quite similar. God had been good to His people, but they had rebelled against Him. Consequently judgment followed, but God had also extended His grace. The Lord then repeated the last two points in His summary of each historical period. Psalm 106 contains a similar review of Israel's history, and Ezekiel 16 and 23 describe Israel's history metaphorically.

20:5-6 The Lord reminded these elders that He had chosen the Israelites, made Himself known to them, and made promises to them when they were slaves in Egypt (Exod. 6:2-8; Deut. 7:6-11). Leslie Allen observed that this is Ezekiel's only reference to God's election of Israel (cf. Deut. 7:7; 14:2).³⁰⁸ The prophet began this historical review with Israel's history as a nation in Exodus, not with her earlier history as the family of Abraham in Genesis. Yahweh had promised to be the Israelites' God and to bring them out of Egypt and into the very best of lands, which He had selected for them to occupy (Gen. 12:7; Exod. 3:8, 13-18).

20:7-9 The Lord had told the Israelites to abandon the detestable, defiling gods of Egypt because He was their God, but they rebelled against Him and refused to do so (cf. Exod. 5:19-21; 6:9; Lev. 17:7; 18:3; 26:30; Deut. 29:16-17; Josh. 24:14). He purposed to judge His people in Egypt for their rebellion, and their enslavement there was partially a judgment for their idolatry. Some expositors believed that this is a reference to God judging the Israelites at Mt. Sinai because of the Golden Calf incident.³⁰⁹ However it seems clear that the Lord was referring to Israel's idolatry in Egypt before the Exodus, which is not revealed as explicitly elsewhere in Scripture. Then He chose to bring them out of Egypt for the sake of His reputation among the other nations (cf. Gen. 15:13-16).

"Though Israel had failed to sanctify the name of the Lord among the nations, the Lord himself would do so by his deliverance of Israel from Egypt [cf. Exod. 7:5; Ps. 106:8-12]."³¹⁰

³⁰⁸Leslie C. Allen, *Ezekiel 20—48*, p. 9.

³⁰⁹E.g., Greenberg, pp. 365-66; and Cooper, p. 201-2.

³¹⁰Alexander, "Ezekiel," p. 834.

Israel's rebellion in the wilderness and God's grace 20:10-26

- 20:10-12 So the Lord led the Israelites out of Egypt and into the wilderness. At Mount Sinai He gave them statutes and ordinances that would result in their welfare if they obeyed them, namely, the Mosaic Law. He also gave them the Sabbath Day as a sign of the special relationship and blessing that they enjoyed because He had chosen them. By observing the Sabbath the Israelites demonstrated their uniqueness among the nations, their sanctification unto Yahweh (Exod. 20:8-11; 31:13-17). The Sabbath was a dual sign to the Israelites. It reminded them of Yahweh's creation of the cosmos (Exod. 20:11) and of His creation of their nation (Deut. 5:14-15). It was the central sign of the Old Covenant (Isa. 56:2, 4).
- 20:13 Nevertheless the Israelites rebelled against their God in the wilderness by disobeying His commands, which God intended to result in their blessing (Lev. 18:5). They also made the Sabbath common by failing to observe it as a special day of the week even though God intended it to be a day of rest and remembrance for them. Consequently, Yahweh decided to annihilate them in the wilderness.
- 20:14 However again His reputation as Israel's God moved Him to have mercy on them. Annihilating them would have made it appear to the other nations that He was unable to sustain them and to fulfill His promises to them.
- "For my name's sake' expresses one of God's motives in dealing with humanity. Although it means so little to most men, the name of the LORD is infinitely precious to Him. See 36:20, where the LORD says of unfaithful Israel, 'they profaned my holy name,' and the following verse, where He says of Himself, 'I had pity for my holy name.' Consistent with His holiness God is concerned to vindicate the honor of His name."³¹¹
- 20:15-16 Notwithstanding, He swore to the Israelites that He would not bring that generation of them into the Promised Land because they had rebelled against Him and had worshipped idols. For Ezekiel, "idolatry is the quintessential cause of the Babylonian exile."³¹²
- 20:17 So the Lord spared His people. He did this in response to Moses' intercession for the people (cf. Num. 14:13-19; Deut. 1:26-40; Ps. 106:23-25).
- 20:18-20 The Lord then instructed the children of the generation that He had liberated from Egyptian bondage not to follow the bad example of their

³¹¹*The New Scofield . . .*, p. 858.

³¹²John F. Kutsko, *Between Heaven and Earth*, p. 25.

fathers. Since He was Yahweh their God they should remain faithful to the terms of the (Mosaic) covenant that He had made with their nation.

- 20:21 However, they also rebelled against the Lord, as their fathers had done, so He resolved to punish them in the wilderness.
- 20:22-24 Again the Lord withheld punishment for the sake of His reputation (cf. Num. 16:21-22; 25:1-9), but He swore to them that He would scatter them among the other nations and disperse them in other lands because of their covenant unfaithfulness (Lev. 26:33; Deut. 28:64; Ps. 106:26-27).
- 20:25-26 The Lord also gave them statutes that were not good for them in the sense that He allowed them to choose to live by worldly rules that caused them misery and death (cf. Lev. 26; Deut. 28:15—29:19; 2 Kings 17:26-41). He also gave them ordinances that were too difficult for them to keep in that He did not lighten the burden of responsibility that the Mosaic Law imposed. When the people offered their children as burnt offerings to the idols, the loss of their children was God's punishment for this sin (cf. Lev. 18:21; Deut. 18:10; 2 Kings 21:6; 2 Chron. 28:3; Rom. 1:24, 26, 28). He had commanded that they offer their first-born to Him or redeem those children (Exod. 13:12; 22:29; Num. 18:15-19), but He had not told them to offer their children to Him as burnt offerings. Ezekiel seems to have been countering the people's claim that because God had commanded them to dedicate their first-born to Him, He was authorizing child sacrifice. Verse 25 may reflect a statement of the people that Ezekiel quoted and then rebutted in verse 26.³¹³

"A sacrifice as understood by Israel's pagan neighbors was a way of giving desirable things to the gods. . . . How about really impressing a god with your dedication and sincerity by sending that god something more precious to you than anything else—your own firstborn child? Thinking themselves likely to gain the lifetime favor of the gods in this way, the Israelites borrowed child sacrifice, too, from their neighbors and began killing their firstborn infants and burning them on altars as a means of sending them to the false gods they were worshiping. It is evident that such people really wanted the gods to love them and were willing to 'give their all' to gain such love."³¹⁴

Israel's rebellion in the Promised Land and God's grace 20:27-29

- 20:27-28 The Lord instructed Ezekiel to continue speaking for Him. The Israelites' forefathers had blasphemed (slandered) the Lord with further covenant

³¹³See Allen, *Ezekiel 20—48*, p. 12.

³¹⁴Stuart, p. 182.

unfaithfulness (cf. Num. 15:30-31). After He had brought them into the Promised Land, they used that good land to practice idolatry.

20:29 The Lord had confronted His people with their use of the high places on hilltops for idolatry. The name of the high places, Bamah, had a double significance. It meant "high place," but it also meant literally "go where" or "go what" (Heb. *ba mah*). Thus Bamah became a contemptuous pun. When the people went to the high places to worship idols, where were they going? They were going nowhere of any significance to do nothing of any importance since these idols were nonentities and could not help them. The name Bamah said more about these places than just identifying them as high places of worship, and the Lord had perpetuated the name Bamah for this reason.

"In the world of the Old Testament, everyone worshiped by using idols. It was unthinkable not to. Idols were thought to be absolutely necessary for proper worship in the same way that wings are thought necessary for an airplane today. The practice of idolatry was based on what is sometimes called 'sympathetic magic,' that is, the ability to influence reality by manipulating an image of that reality."³¹⁵

Israel's rebellion in Ezekiel's day and God's grace 20:30-38

20:30 Ezekiel was to ask his hearers if they planned to defile themselves and to prostitute themselves to things the Lord detested, as their ancestors had done.

20:31 They were defiling themselves by practicing child sacrifice. For this reason the Lord would not give them the answers to the questions that they brought to him (cf. vv. 1, 3).

20:32-35 The Lord would not allow them to become like the idolaters all around them who served wood and stone. He would be their king, He swore, and bring judgment on them. But He would re-gather them to their land from the distant countries where He had scattered them (cf. 36:14-38; 37:21-23; Deut. 30:1-10; Isa. 11:11-16; 49:17-23; 60; 61:4-9; Jer. 23:1-8; Amos 9:11-15; Zech. 10:8-12; et al.). The descriptions of God doing this with a mighty hand and an outstretched arm recall the terms used of His liberation of the Israelites from Egypt (Exod. 6:6; 32:11; cf. Deut. 4:34; 5:15; 7:19; 11:2; Ps. 136:12). A second exodus is in view. He would bring them into another type of wilderness, a wilderness full of people, and there He would personally judge them. This probably refers to the present worldwide dispersion of the Jews that began in A.D. 70 when the Jews had to leave the Promised Land again.³¹⁶

³¹⁵Ibid., p. 172.

³¹⁶See Louis A. Barbieri Jr., "The Future for Israel in God's Plan," in *Essays in Honor of J. Dwight Pentecost*, pp. 163-79, for a concise survey of this large subject.

20:36-38 As the Lord had judged the fathers in the wilderness long ago, so He would judge the children of His people. He would discipline them to sanctify them (cf. Jer. 33:13). It was customary for shepherds to count their sheep as they passed under their staff that they held over the doorway of the sheepfold.

"Reference to those who 'pass under my rod' was first an allusion to the tithe (Lev 27:32). Every tenth animal that passed under a 'rod' held over the sheep was separated and declared to be holy. The purification of the exile, likewise, would separate the righteous and the wicked. The 'rod' also was an instrument of discipline, correction, and punishment. This was another way of communicating the purpose of the exile, which was to 'purge' and purify those who rebelled against God (v. 38)."³¹⁷

The Lord would also bring His people under obligation to keep the terms of a covenant. This is evidently a reference to the New Covenant (cf. 36:25-38; Jer. 31:31-34). He would weed out the rebels and transgressors from among them and bring them out of the countries where they lived but would not bring them into the Promised Land (cf. Num. 16; Deut. 11:6). This probably refers to the Jews who will die during the Tribulation period (cf. Zech. 13:8; Rev. 12:15-17) and or when the Lord returns to the earth (cf. Matt. 25:31-46). Of course, many other Jews will enter the Millennium, as the verses cited make clear.

"The passage is a prophecy of future judgment upon Israel, regathered from all nations . . . The issue of this judgment determines who of Israel in that day will enter kingdom blessing (Ps. 50:1-7; Ezek. 20:33-44; Mal. 3:2-5; 4:1-2)."³¹⁸

Then His people would know that the One who did this was Yahweh.

An application of this history lesson 20:39-44

20:39 For now the Israelites to whom Ezekiel spoke could continue to practice idolatry, not with the Lord's blessing of course, but in the future they would listen to and obey the Lord. Then they would make His name common no longer with their unacceptable worship, gifts, and idolatry.

"Those who consistently reject God and his Word favor self-willed idolatry and immorality and are finally given over by him to reprobation (20:30-39), a process described in detail in Rom 1:24-28."³¹⁹

³¹⁷Cooper, pp. 206-7.

³¹⁸*The New Scofield . . .*, p. 859.

³¹⁹Cooper, p. 207. Cf. Feinberg, p. 115; and Chisholm, *Handbook on . . .*, p. 258.

- 20:40 At that future time, all Israel would serve the Lord, specifically on the holy mountain where the temple stood (cf. Isa. 27:13; 56:7; 66:20; Joel 2:1; 3:17; Zeph. 3:11; Zech. 8:3). Then the Lord would accept their offerings of worship, their special gifts to Him, and all the things that they devoted to Him because they had repented (cf. chs. 40—48).
- 20:41-42 The people would be as a soothing aroma to God when He regathered them to the Promised Land from where He had scattered them, and He would accept them. He would then prove that He is holy among the nations, namely, uniquely different from all the so-called gods. The Israelites would also recognize Him when He fulfilled His promise to the patriarchs to give them the Promised Land.
- 20:43-44 Back in the land then the Israelites would remember their past sins and loathe themselves. They would also come to know the Lord for the kind of God He is because they would recognize how graciously He had dealt with them as a people.

The prospect of future grace, restoration, and blessing has always been the strongest motivation for present holiness (Rom. 2:4). This is why this message ends as it does.

"The prophet Ezekiel straddled two eras, the grim era of the past and present which culminated in double exile and—in prospect at least—a glorious era to be inaugurated by a new work of God. In this chapter both these aspects are set side by side so that it presents an epitome of his total message."³²⁰

2. Judgment of Judah's contemporary leaders 20:45—21:32

A new chapter in the Hebrew Bible begins with 20:45. The section of the book that it begins contains four messages of judgment on Judah and Jerusalem with special emphasis on the judgment coming on the leaders of the people. The Lord explained the basis for His judgment of Judah (20:1-44) and then proceeded to describe and to affirm the certainty of that judgment (20:45—21:32).

The parable of the forest fire 20:45—21:7

The prophet first presented another parable, and then he interpreted it.

The parable itself 20:45-49

- 20:45-46 The Lord commanded Ezekiel to address Teman with a prophecy. Teman (Heb. *temanah*, right) refers to the south. Perhaps the translators of the NASB left this word transliterated because Teman was also the name of an important town in Edom to Jerusalem's southeast, and they felt the Lord

³²⁰Allen, *Ezekiel 20—48*, p 15.

might have intended this prophecy for that town. The Septuagint translators understood this word this way, and they also interpreted the other two words that describe Judah as place names. The Lord further described the object of this prophecy as the south (Heb. *darom*) and as the forest in the Negev (Heb. *negeb*). The Negev was the southern part of Judah that was a buffer geographically between the marginally fruitful southern part of Judah and the wilderness farther to the south. Evidently the whole kingdom of Judah was quite wooded in Ezekiel's day, and the woods extended south into the upper Negev. By using the three most common Hebrew terms for "south," the Lord referred to Judah. Later He clarified that the south included Jerusalem, its sanctuaries, and all the land of Israel, which was then Judah (cf. 21:2). Judah was, of course, the "Southern Kingdom."

20:47-48 Here it becomes clear that God was using the trees in the south to represent Judah's people. The Lord announced that He was going to judge the Judahites as when a fire sweeps through a forest. All types of people would suffer, the outwardly righteous (green tree) and the outwardly unrighteous (dry tree), and the judgment would affect the whole land. The fact that the Babylonians would capture and kill the righteous and the wicked does not contradict chapter 18, which teaches that every person is responsible for his or her own actions. There the point was that God does not punish people for the sins of others but for their own sins. Here the point is that the coming invasion would affect everyone. Everyone would eventually realize that Yahweh had brought this terrible judgment on the Judahites.

"The most devastating consequences [*sic*] by far of Judah's covenant failure was her depopulation by exile."³²¹

20:49 Ezekiel replied to the Lord that the people were not taking what he said seriously; they were explaining away his announcement of judgment as *only* a parable or fictional story, not as a symbolic message of real judgment to come.

The interpretation of the parable 21:1-7

21:1-2 Again the Lord told His prophet to speak a message of judgment against Jerusalem, the pagan sanctuaries, and the whole land of Israel (i.e., Judah). This would be a clarification of the figures used in the previous parable.

21:3-5 Ezekiel was to announce that Yahweh stood opposed to His people (cf. Luke 9:5, 41; 19:41; 21:20-24). Instead of being their divine defender (cf. Deut. 32:41; Josh. 5:13-15; Isa. 31:8; 34:5-8; 66:16; Jer. 25:31; 50:35-37; Zeph. 2:12), He was going to turn against them. He would put them to

³²¹Merrill, p. 373.

death with a sword (cf. fire, 20:47-48), both the righteous (the green tree) and the wicked (the dry tree) throughout the whole land. The Book of Habakkuk deals with the problem of how and why God would use the wicked Babylonians as His instrument of chastening, a problem that the Israelites could not solve on their own. Everyone would know that He had been responsible for the judgment, and He would not sheath His sword (quench the fire, 20:48). This chapter has more references to the sword of the Lord as a figure of God's judgment than any other chapter in the Bible.

"Unfortunately, some of the righteous would suffer along with the wicked, but this is often the case in times of war."³²²

21:6-7 The Lord told Ezekiel to let the Jewish exiles among whom he lived witness his groaning, grief, and heartbreak as he delivered this message. When the people asked the prophet why he was so sad, he was to tell them that it was because of the coming judgment.

"The need for the action described in these verses suggests that Ezekiel's oral presentation so far had failed to impress his audience. Since they would not be shocked, even by the reference to the righteous perishing with the wicked, a new rhetorical strategy is adopted. Yahweh orders the prophet to perform another sign-act before his hearers. The performance involved paralinguistic nonverbal groaning, normally expressive of the deepest pain and grief."³²³

"God would have Ezekiel experience something of what was in His own heart toward the rebellious nation."³²⁴

Ezekiel's grief would mark the people to whom he spoke this prophecy when they heard the news that the sword was coming. And the Lord guaranteed that the judgment would indeed come.

The song of the sword 21:8-17

21:8-10 Another of Ezekiel's messages was to be poetic. He was to announce that a sword had been sharpened and polished and was now ready to go to work slaughtering people quickly.

"A sword, a veritable Excalibur with a life of its own, is made ready for its grim destiny."³²⁵

³²²Wiersbe, p. 202.

³²³Block, *The Book . . .*, p. 670.

³²⁴Feinberg, p. 119.

³²⁵Allen, *Ezekiel 20—48*, p. 26.

How could the people rejoice since the rod (scepter, symbol of authority) of God's representative (son) would have no respect for anyone (despise every tree, cf. 20:47) in this judgment? They could not. God's son here refers to Nebuchadnezzar who would accomplish God's will by executing His punishment.

The figures of the rod and the son of God both describe Messiah elsewhere (cf. Gen. 49:9-10; 2 Sam. 7:14), so Ezekiel's hearers were accustomed to thinking of these figures as representing their deliverer. But here they learned that God had another son with a scepter who would destroy them (cf. Isa. 10:5, where the rod is the Assyrians).

21:11 It was as though God had polished the sword with which He would judge His people and had placed it in the hand of their slayer, Nebuchadnezzar.

21:12-13 Ezekiel was therefore to cry out and slap his thigh in great despair because this judgment was coming on the people and officials of Judah (cf. Jer. 31:19). The leaders would die with the rest of the people. This cutting off of Israel's leadership was a cause for even greater sorrow than the destruction of the ordinary Israelites. This would really test the nation. The Judahites should not despise the rod that the Lord would use to judge them; they should not think that Nebuchadnezzar lacked the power to destroy Judah. Nevertheless even Nebuchadnezzar would not prevail over Israel ultimately because the rod Messiah would be the final victor.

21:14-15 Ezekiel was to clap his hands together as he continued to prophesy symbolizing his approval of God's will (cf. 6:11; 22:13; 25:6; Num. 24:10; 2 Kings 11:12; Job 27:23; Ps. 47:1; Isa. 55:12). But he was also to announce the awfulness of the coming sword-like judgment.

Some translators interpreted the description of the invasion as coming three times and doing double damage the third time (e.g. NKJV). This may be a reference to Nebuchadnezzar's three invasions of Jerusalem in 605, 597, and 586 B.C., the last invasion being twice as bad as the other two.³²⁶ Another preferable translation is that the sword would strike twice or even three times (e.g. NIV). This suggests that the invasion would come fast from several different angles, that the sword would double or triple itself in its influence.³²⁷ The invasion would be unusually devastating. Living in an age of special visual effects in which images transform themselves, it is not difficult for us to visualize this sword multiplying and swashbuckling its way through Jerusalem. Even the great among the people would not escape. This may refer to the great one, King Zedekiah, or to the great ones, the leading men of Judah. The invaders would surround everyone.

³²⁶Cooper, p. 213; and Fisch, p. 136.

³²⁷Feinberg, p. 120; Dyer, "Ezekiel," p. 1268; Block, *The Book . . .*, p. 680; and Keil, 1:294.

- 21:15 The sword would cause the people to lose heart and die in the gates of the city, the place where the leaders did business. The Lord had an instrument of judgment (sword) that He had prepared and kept ready that would slaughter His people suddenly (like lightning), namely, Nebuchadnezzar.
- 21:16-17 The Lord spoke to His instrument of judgment urging it to show itself sharp by slaying His people on every side, as the Lord directed. Yahweh would also give His approval by clapping His hands and appeasing His wrath against His sinful people.

"At least some of the problem that Ezekiel's audience had in accepting such a gloomy picture of the future can be traced to the natural religious tendency to think of God as kindly and thus not really capable of punishing people decisively. Why would God destroy His own beloved people in whom He had invested such time and effort since He brought them out of Egypt centuries before? Some of the problem lay also in people's natural, routine optimism. It is hard to imagine the country in which one grew up and enjoyed life in the past actually coming to an end, never again to be an independent nation, never again to have its own government and laws and economy and stable traditions."³²⁸

The model of the map 21:18-27

- 21:18-20 The Lord also commanded Ezekiel to make a representation of two roads coming out of Babylon by which judgment from Yahweh would come. Perhaps he did this by drawing in the dirt or on a tablet. Really there was to be one road leaving Babylon that diverged as it approached Jerusalem, and there was to be a signpost at the fork in the road. One of this road's branches would go to Rabbah, the capital city of the Ammonites to the east of Judah. The other branch would lead to Jerusalem. Geographically this fork was at Damascus.
- 21:21-22 When the king of Babylon reached the fork in the road, he used pagan methods to determine which road he should take (cf. Isa. 47:8-15). Belomancy involved writing various names on several arrows, mixing them in a quiver, and then drawing or throwing them out. The arrow chosen indicated the god's selection. Teraphim were household idols that the pagans believed had connections with the spirits of departed ancestors who could communicate with them (necromancy). Hepatoscopy involved inspecting the liver or entrails of a sacrificed animal and making a decision based on their shape, color, and markings.

Both Judah and Ammon had proved to be disloyal vassals; they had both rebelled against Babylon in 593 B.C. The lot fell to go against Jerusalem and to besiege it rather than Rabbah. Obviously the Lord controlled the pagan means that Nebuchadnezzar used to determine what He should do (Prov. 16:33; 21:1; Jer. 27:6).

³²⁸Stuart, pp. 199-200.

- 21:23 Nebuchadnezzar's decision to come against Jerusalem would look like a mistake to the leaders of Israel. It would seem to them that God should have guided him to besiege the Ammonites since they were more wicked. Furthermore Israel's leaders had sworn oaths of allegiance to Yahweh in response to His sworn promises to them. They thought surely He would defend them, but they were wrong. He would allow Nebuchadnezzar to capture them.
- 21:24-27 The Lord would remember the sins of His people and allow them to suffer conquest (Deut. 28—29). He would allow their destruction because their many sins were open before Him. Even wicked King Zedekiah, the "prince" of Israel, would be as good as dead when his day of judgment came with the taking of Jerusalem. The Lord would remove the high priest's turban and the king's crown by terminating their offices. Then there would be a reversal of fortunes: the powerful would be humbled and the poor of the land would be the only people allowed to remain in it. Yahweh would make Jerusalem the ultimate ruin. The triple repetition of a word in Hebrew, here "ruin," is the strongest way to express a superlative in the Hebrew language (cf. Isa. 6:3; 24:1-3). Jerusalem would no longer enjoy its former glories until One would come who had a divine right to replace both high priest and king (cf. Ps. 110:2, 4; 72; Isa. 9:6; Jer. 23:5; 33:17; Zech. 6:12-13). God would then give the city into His control (Gen. 49:10; Isa. 2:1-4). This is, I believe, a messianic prediction of Jesus Christ's future earthly reign from Jerusalem (cf. Heb. 5—7). Another view is that it refers to Nebuchadnezzar.³²⁹

The message concerning Ammon's fate 21:28-32

- 21:28-30 As for Ammon, the Lord said, it too would fall under His judgment (cf. 25:1-7). This oracle against a foreign nation is not with the others in Ezekiel (chs. 25—32) evidently because of the catchword "sword" that also marks the preceding prophecies in this chapter and because the previous message raised the question of Ammon's fate. The Ammonites were saying that the Judahites deserved destruction because of their wickedness. They attacked and plundered the land of Judah after the siege of Jerusalem. However, Yahweh would put His sword of judgment on Judah away to rest; Israel's enemies would attack her no more. Then He would judge the Ammonites in their ancient homeland.
- 21:31-32 The Lord promised to judge the Ammonites in the fierceness of His wrath and to deliver them into the hands of their enemies. He would burn up their cities and cause their blood to flow in their fields, Viking-style. There would be no future for the Ammonites, but there would be for the Israelites.

³²⁹Chisholm, *Handbook on . . .*, p. 260.

"To the Semitic mind nothing could be more terrible: no prospect of restoration, no continuance in succeeding generations, no memorial, not even a memory. Oblivion."³³⁰

3. The idolatrous rulers of Judah ch. 22

The Lord now clarified one of the primary reasons for the sword that was fast approaching Jerusalem and Judah. This reason was the sins of the present generation of Judahites, especially its leaders. In chapter 20 the prophet reviewed the guilt of the Israelites throughout their history, but in chapter 22 he exposed the guilt of the present generation of Judahites.

Three messages of judgment in this chapter indict the Judahites. In all three Ezekiel acted as a prosecutor presenting the evidence of Judah's guilt, like a bill of indictments. Judah's covenant violations were of two broad types: sins against God (spiritual apostasies) and sins against people (social injustices). The people had broken both parts of the Decalog as well as other more specific covenant commands.

Covenant unfaithfulness 22:1-16

22:1-2 Another message came from the Lord instructing Ezekiel to remind the residents of the bloody city of Jerusalem about all their abominations (cf. 20:4). A list of specific sins was necessary for him to pronounce judgment on them. Jerusalem was bloody because of all the blood its residents had shed, the blood of innocent people (cf. Nah. 3:1).

Shedding blood was Jerusalem's primary offense, according to this prophecy (cf. vv. 3, 4, 6, 9, 12, 13), and it had its roots in idolatry. The pagan religious practices that God's people had adopted did not curb their abuse of other people, much less encourage altruistic living. Idolatry even promoted the taking of other people's lives through human sacrifice. Whenever people disregard the revealed will of God, crimes of violence and bloodshed follow.

"Seven times in this prophecy the word 'blood' or 'bloodshed' (Hebrew, *dam* and *damim*) occur as characterizing the crimes against God's covenant that had been occurring routinely in Jerusalem. These words have a special idiomatic meaning in Hebrew that their usual translation does not entirely convey in English. They connote 'harm' or 'hurt,' and that is what much of verses 1-16 is about: the harm or hurt done by people in power in Jerusalem (and by implication elsewhere in Judah) to those who have no power, such as the poor, the sick, the

³³⁰Taylor, p. 165.

uneducated, etc. By extension, 'blood' and bloodshed' also come to mean in Hebrew anything 'violent' or just simply 'vile,' even if it does not actually involve causing physical harm to another person."³³¹

22:3-5 Yahweh regarded Jerusalem as a city that shed blood in its midst and crafted defiling idols contrary to her own interests. For these sins her time of judgment would come. She had brought judgment on herself. Yahweh would also make her a reproach and a source of mockery among nations near and far because of her bad reputation for turmoil (cf. Rom. 2:24). Here the general population of Jerusalem is in view.

"When a righteous people follow the world's ways, as Judah had done, the world ends up laughing at her."³³²

22:6 In verses 6-12 Judah's rulers are the main focus of indictment. The rulers of Israel had been guilty of shedding blood, each in his own sphere of authority, through the misuse of power (cf. Exod. 20:13). Evidently judicial murders were common (cf. 2 Kings 21:16; 24:4) as were child sacrifice (16:21; 20:26, 31; 23:37) and acts of personal violence.

22:7-9 Judah's leaders had undermined parental authority (cf. Exod. 20:12; Lev. 19:3). When children stop respecting their parents, it is not long before citizens stop respecting their rulers. They had taken advantage of the helpless—aliens, orphans, and widows—people particularly in need of protection by those in positions of power (cf. Exod. 22:21-24; 23:9; Lev. 19:33; Deut. 24:17).

"The real test of any society is . . . how it treats the people with no voice and no power."³³³

The rulers had also despised what God considered holy and had failed to observe the Sabbath Days (cf. Exod. 20:8; Lev. 19:3). Some of them had resorted to slander to get their way and to premeditated murder (cf. Lev. 19:16). Jerusalem's leaders had also worshipped idols at mountain shrines (cf. Deut. 12:1-2; 16:21-22) and practiced sexual sins in connection with their idolatry (cf. Lev. 18:6-23; 20:10-21).

"Ritual sex was another great attraction of idolatry. Most of the ancient Near Easterners believed that all things that came into being were *born* into being. This was a major tenet of their belief system. They believed that not only animals were born, but also plants. (This is the reason that

³³¹Stuart, p. 209.

³³²Alexander, "Ezekiel," p. 847.

³³³D. Lane, *The Cloud and the Silver Lining*, p. 88.

they 'sowed their field with two kind of seed,' i.e., male and female seed as they thought of it; see Lev. 19:19.) What was born into being started, they believed, with sex on the part of the gods—specifically Baal and Asherah, the god and goddess of fertility according to the Canaanites. They also thought that if a person bringing an offering to Baal and/or Asherah would have ritual sex with a prostitute at the shrine as part of worship (!) this would help stimulate the divine powers of nature to have sex, and thus more animals and crops would be born, and the agriculture would flourish. Outlandish as this sounds to us, it was the pinnacle of theology among the Canaanites—and was what the Israelites readily accepted at Baal-Peor."³³⁴

22:10-11 Sexual impurity, adultery outside and inside the family, and incest all occurred in Jerusalem (cf. Lev. 18:7-8, 19; 20:11, 18; Deut. 22:30; 27:20). Moral purity had broken down completely.

22:12 Taking bribes to kill people, taking interest and making a profit at the expense of a fellow Israelite, and oppressing a neighbor for personal gain also took place there (cf. Exod. 23:8; Deut. 23:19-20; 24:6, 10-12; 27:25). At the heart of all this, the Jerusalemites had forgotten about Yahweh. This was the root problem, and the Lord presented it as the last nail in Jerusalem's coffin.

"Since God is at the center of all moral relations, all social and moral rights and proprieties are secure only when God is recognized in His sovereign rule."³³⁵

22:13-14 The financial corruption and physical violence that marked Jerusalem disturbed God so greatly that He pictured Himself as striking His palm with His fist (an anthropomorphism). The hearts of the people would not be able to bear up under His coming judgment of these sins nor would they be able to maintain their physical strength.

22:15-16 The Lord promised (1) to scatter the people of Jerusalem among the other nations and to disperse them in other lands. He would (2) refine their sinful practices away. Some commentators claimed that after the exile idolatry was no longer a temptation for the Israelites.³³⁶ They would (3) not be able to maintain their holiness in exile, and the nations would regard them as unclean. Then they would know that Yahweh was the only true God. This was His primary purpose in judging them.

³³⁴Stuart, pp. 181-82.

³³⁵Feinberg, p. 127.

³³⁶E.g., Cooper, p. 231; and Fisch, p. 155.

Coming refining 22:17-22

Accusation marks the preceding oracle, and judgment marks this one.

22:17-20 The Lord also compared the present Judahites to the base metals (lead, sulfur, and other minerals) that separate from silver in the refining process. He planned to gather them in Jerusalem, His crucible, and subject them to a trial by fire, as refiners do to extract any remaining silver from the dross (cf. Isa. 1:22-25; 48:10; Jer. 6:27-30; 9:7; Zech. 13:9; Mal. 3:2-4).³³⁷ Punishment for sin involves three major things: retribution, correction, and purification.³³⁸ Here purification is in view.

22:21-22 God's wrath would be the fire that He would blow on them, and they would melt, as when a silversmith refines silver (cf. 2 Pet. 3:9-14; Rev. 20:15). They would then know that Yahweh had judged them.

The Babylonians really did burn the city, so this turned out to be a literal fire as well as a metaphorical one.

Corrupt leaders 22:23-31

"Often the prophets are inspired to compose attacks on the leadership of Israelite society. The reason for this phenomenon is clear enough: the nation could never have become sufficiently corrupt to merit the outpouring of God's destructive wrath unless the societal leadership had helped the process along."³³⁹

22:23-24 Using another figure, Ezekiel was to announce that Judah was a land that had not been cleansed with rain. God had withheld rain as punishment for covenant disobedience (cf. Deut. 28:24). Judah's moral uncleanness had accumulated because it had not benefited from God's periodic cleansing of the land through its leadership. It would receive no "rain" of blessing in the day when God poured out His indignation on the city (in 586 B.C.).

22:25 The Lord proceeded to indict three categories of leaders in Judah (cf. Zeph. 3:3-4). False prophets had conspired to take advantage of the people like a wild lion tears its prey. Some translations have "princes" instead of "prophets," following the Septuagint, but the Hebrew word is *nebi'eyha*, "her prophets." Evidently the change was made to distinguish four groups of leaders rather than repeating reference to the prophets (v. 28) and because princes were in position to practice the sins mentioned. These leaders had eaten up people's lives and had stolen their possessions. They had even been responsible for the deaths of many men and for many

³³⁷See Allen, *Ezekiel 20—48*, p. 38, for a description of the smelting process.

³³⁸Stuart, p. 212.

³³⁹Ibid., p. 216.

women becoming widows. They probably slew the men by assuring them that if they went into battle against the Babylonians they would succeed, and following this advice the men died in battle leaving many widows in the land. Jeremiah, on the other hand, had counseled submission to the Babylonians.

22:26 The priests had also abused the Mosaic Law and had made common what should have been set apart to the Lord. They had treated holy and profane things the same, and they had failed to teach the people the difference between clean and unclean things that the law distinguished. They had made the holy city and the holy land anything but holy. Furthermore they did not observe the Sabbath. In short, they did not hallow the name of the Lord (cf. Hos. 4:6; Mal. 2:6-8).

22:27-28 Judah's princes (officials, nobles, Heb. *sarim*) also abused the people to get what the people had. They behaved like wild wolves. The false prophets evidently assisted the nobles in their wickedness by saying in the name of the Lord that what the officials were doing was right.

"By a terrible Jekyll and Hyde transformation the civil authorities who should have been shepherds with the welfare of their flock at heart changed into wild beasts preying on the sheep (cf. 34:8)."³⁴⁰

22:29 The people (ordinary citizens) also oppressed one another and stole from each other. They took advantage of the poor, the needy, and travelers illegally.

"One hardly could read such a list of crimes that so thoroughly pervaded society of Ezekiel's day without seeing the parallel to the Western world at the close of the twentieth century. The latter years of this century have been marked by decadence, moral and spiritual decay, loss of integrity, violence, and injustices that mirror what Ezekiel must have witnessed. Such a crisis calls for renewed spiritual and moral leadership that is the by-product of genuine spiritual renewal."³⁴¹

22:30 Yahweh had looked for one of the Judahites who would lead a reformation that would defend the people from God's judgment, but He could not find anyone.³⁴² Building up the wall and standing in the gap formed by a breach in the wall were appropriate figures for fortifying the people in their hour of need.

³⁴⁰Allen, *Ezekiel 20—48*, p. 39.

³⁴¹Cooper, p. 223. For further development of this theme, see Ted W. Engstrom, *Integrity*, pp. 26-27; Charles Colson, *Against the Night*, pp. 35-69; and Stuart Briscoe, *All Things Weird and Wonderful*, p. 112.

³⁴²See D. Edmond Hiebert, *Working with God: Scriptural Studies in Intercession*, pp. 99-108.

In chapter 14 the Lord said that no righteous person could deliver the nation from judgment by his own righteousness, not even Noah, Daniel, or Job. Here He said that He could find no one who could lead the people back to God.

"Such a statement is hyperbole, purposeful exaggeration for effect. It hardly means that no one at all in Jerusalem in the early 580s was righteous. . . . It means rather that there were so few among the people who were righteous that the net effect was as if no one at all cared about God's Will."³⁴³

Obviously there were prophets who were faithful to the Lord in Judah during its last days, like Jeremiah, Habakkuk, and Zephaniah. Evidently the Lord did not mean that He was without any faithful representatives but that even these men were ineffective in stemming the tide of ungodliness. They did not fail because they were deficient but because the people were so thoroughly defiant. No one could return them to following the Mosaic Covenant faithfully as, for example, Hezekiah had done earlier and as Josiah had tried to do. Furthermore, Jeremiah and his fellow prophets lacked the political authority to lead Judah back from the brink of disaster.

Moses had been a "gap man" in his day (Exod. 32:11; cf. Gen. 20:7). He had turned aside the Lord's wrath from the Israelites with His intercessory prayers. God responded to Moses' pleas for mercy because the people were still malleable enough to repent. He did not respond to Jeremiah's prayers for mercy because the Judahites were now hardened in opposition to His will (Jer. 7:16-17; 14:11-12).

22:31 Therefore the Lord would send judgment like a flood and like a fire. He would bring the evil that they had done back on the heads of His violent and idolatrous people. The prophetic perfect tense in Hebrew describes the future action as already past to stress its certainty.

4. The parable of the two sisters ch. 23

This chapter is the final climactic one in Ezekiel's collection of messages that condemn Israel's defective leadership (chs. 20—23).

Both chapters 16 and 23 personify Israel as a prostitute, but there are significant differences in these chapters. In chapter 16 *Canaan* is the mother of Israel who corrupted her daughter by teaching her *spiritual* adultery, namely, idolatry or trust in other *gods*. In chapter 23 *Israel* herself is responsible for pursuing mainly *political* adultery, trust in other *nations*, through alliances with foreign powers. In chapter 16 the *beginnings* of Israel's unfaithful career receive most attention whereas in chapter 23 the *whole* of Israel's unfaithful career is in view. Chapter 16 deals with *Judah* alone, but chapter 23 focuses on

³⁴³Stuart, p. 218.

both *Israel and Judah* with emphasis on Judah. Many students of this chapter have noted its similarities to Jeremiah 3:6-11, and some consider it an exposition of that text.

"There the emphasis was on idolatries as breaking the marriage relation and the sacred covenant with God, here it is on the nation's worldly spirit and worldly alliances for safety and national security."³⁴⁴

"Despite the distasteful theme and the indelicate language, the reader of these verses must appreciate that this is the language of unspeakable disgust and must try to recognize Ezekiel's passion for God's honour and his fury at the adulterous conduct of His covenant people. The feeling of nausea which a chapter like this arouses must be blamed not on the writer of the chapter nor even on its contents, but on the conduct which had to be described in such revolting terms."³⁴⁵

"This chapter contains the most graphic language in the Bible in reference to sexual imagery. For that reason it requires extreme care in teaching and preaching."³⁴⁶

Israel's lustful youth 23:1-4

23:1-3 The Lord gave Ezekiel a story about two sisters who had one mother (cf. Jer. 3:7). These young girls became prostitutes in Egypt and allowed men to fondle their breasts. That is, they allowed the Egyptians to become intimate with them even though they were to be faithful to the Lord alone (cf. 16:26; 20:7-8; Num. 25:3-9; Josh. 24:14; 2 Kings 21:15; Hos. 1:2). One evidence of the idolatry that the Israelites had adopted from the Egyptians came to the surface in the Golden Calf incident in the wilderness (Exod. 32). Joshua later warned the Israelites about the dangers of idolatry, which had persisted since they had departed from Egypt (Josh. 24:14).

Israel and Judah became separate entities after the division of the kingdom following Solomon's reign, though relations between the northern and southern tribes had become increasingly unfriendly long before that (cf. Judg. 8:1; 12:1; 2 Sam. 19:43). However, God projected their identities back to the time when they were still within their mother, ancient Israel, in Egypt. The common origin of these sisters accounts in part for their similar behavior. Their father, unstated, was Yahweh.

23:4 Oholah was the name of the older sister (lit. "her tent," probably a reference to her pagan tent shrines), and she represents Samaria, the capital of the kingdom of Israel. Oholibah was the younger sister (lit. "my tent is in her," probably a reference to the temple), and she represents

³⁴⁴Feinberg, p. 131.

³⁴⁵Taylor, pp. 170-71.

³⁴⁶Stuart, p. 220.

Jerusalem, the capital of the kingdom of Judah. One of Esau's wives was Oholibamah, meaning "tent of the high place" (Gen. 36:2). Oholah and Oholibah became the wife of the Lord and bore Him sons and daughters (i.e., inhabitants and surrounding villages). Evidently the Lord regarded Samaria as the older sister because the Northern Kingdom was the first to apostatize and to establish political alliances with foreign nations, particularly the Assyrians (Hos. 8:9).

While this allegory suggests that Yahweh committed bigamy and incest, He obviously did nothing in relation to Israel that was in any way improper. This is an excellent example of why we should not apply what the parable excludes; there is no reference to the sisters' father in the parable. The story makes certain comparisons, but if we try to apply all the implications of the story we end up with some incongruities.

"Though the law prohibited a man from marrying sisters (Lev. 18:18), such marriages are not unknown in the Bible (cf. Jacob). The Lord here uses a contextually conditioned metaphor for illustrative purposes. The use of such an illustration does not mean that the Lord condoned bigamy."³⁴⁷

Samaria's prostitution 23:5-10

23:5-8 Oholah proved unfaithful to the Lord by lusting after her attractive neighbors, the Assyrians.

"The appeal, then as now, was to youth, strength, position, wealth and self-gratification; that is, the world in all its dazzle and attractiveness."³⁴⁸

Oholah committed political adultery by making alliances with the Assyrians, which involved worshipping their idols (cf. 2 Kings 15:19-20; 17:3-4; Hos. 5:13; 7:11; 8:9; 12:1-2; Amos 5:26). The Black Obelisk of Shalmaneser, an important archaeological find dating to about 840 B.C., shows King Jehu of Israel bowing in submission before King Shalmaneser III of Assyria and giving him tribute money.³⁴⁹ This was a continuation of Oholah's behavior from her youth in Egypt where she had done the same things.

23:9-10 The Lord had turned her over to the Assyrians whom she had proved unfaithful with in 722 B.C. They abused her and even murdered her so that she had become infamous for her sins (cf. Prov. 1:31; Rom. 1:24-32). The name "Jezebel" evokes similar disgust even today.

³⁴⁷Chisholm, *Handbook on . . .*, p. 263. See also Allen, *Ezekiel 20—48*, p. 48.

³⁴⁸Feinberg, p. 132.

³⁴⁹See D. W. Thomas, ed., *Documents from Old Testament Times*, pp. 48-49, plate 3, and pp. 50-52.

"Infidelity in marriage was taken very seriously in ancient Israel. Adultery and prostitution were both odious to God and punishable by death, as several passages in Leviticus (19:29; 20:10; 21:9) and Deuteronomy (22:21-22; 23:17) indicate."³⁵⁰

Jerusalem's prostitution 23:11-21

- 23:11-13 Oholibah observed her sister's behavior and fate, but she did not learn from them. As many historians have observed, the one thing we learn from history is that most people do not learn from history. Oholibah became even more unfaithful than her sister. She too lusted after the Assyrians whom she viewed as attractive political allies (2 Kings 16:8; cf. Isa. 7:7-9), and she added the Babylonians to her list of lovers. Both sisters followed the same pattern of behavior.
- 23:14-16 Oholibah saw pictures of the Babylonians that aroused her desire for alliance, and she lusted after them and wrote to them (2 Kings 23:32, 37; cf. Jer. 22:21). Much visual art in biblical times was painted and or carved on walls. The splendor that was Babylon deeply impressed the Israelites.
- 23:17-21 The Babylonians responded to her invitations and came to Judea where they polluted her by entering into treaties with her. After she became a vassal of Babylon, she became disgusted with the Babylonians and turned away to seek help from Egypt (cf. Jer. 2:18; 6:8; 37:5-7; Lam. 4:17). The Lord also became disgusted with her, as He had with her sister. Nevertheless she persisted in her immoral conduct that she had learned in Egypt. She lusted after the Egyptians that pursued her like donkeys and horses in heat (cf. Jer. 2:24; 5:8; 13:27). Donkeys and horses were proverbial for their strong sexual drive (cf. Jer. 2:24; 5:8; 13:27), and the Lord used these animals as a figure for the Egyptians' potency that attracted the Israelites.³⁵¹ Jerusalem returned to her old lover, namely, Egypt.

Jerusalem's judgment for prostitution 23:22-35

Four messages announce God's judgment on Jerusalem for her unfaithfulness (vv. 22-27, 28-31, 32-34, 35).

- 23:22-24 Because of her behavior the Lord promised to turn Oholibah's soldier-lovers against her, even the Babylonians, Chaldeans, Assyrians, and the tribal groups of the empire. The Chaldeans were the original residents of southern Babylonia who became a ruling class within Babylonia. The Assyrians had suffered defeat by the Babylonians and now lived within

³⁵⁰Stuart, p. 222.

³⁵¹Keil, 1:327-28.

Babylonia, mainly in the north. Pekod, Shoa, and Koa were tribes that lived in eastern Babylonia and were part of the empire (cf. Isa. 22:5; Jer. 50:21). They would all come against Oholibah from every direction, attack her from all sides, and try to destroy her using their own customary methods. Ezekiel painted a picture of the whole world coming against Israel. The Lord would allow this to happen to her.

23:25-27 The Lord would express His jealousy over Jerusalem and deal with her in His wrath. Her enemies would cut off her nose and her ears. This was an ancient Near Eastern punishment for adulteresses, which was understandable since these women typically adorned themselves with nose-rings and earrings.³⁵² This appears to have been a method of mutilating enemies and prisoners of war as well.³⁵³ This punishment would make Jerusalem grotesque, unappealing, and repulsive to other nations.

These enemies would also kill many Israelites, deport others (2 Kings 24:10-16; 25:11; Dan. 1:1), and burn still others (2 Kings 25:18-21). They would strip the nation of her clothes and jewelry, perhaps a reference to her wealth, possessions, and temple treasures (cf. 2 Kings 25:13-17; 2 Chron. 36:18). The Lord would allow this to teach Oholibah to abhor the Egyptians as political partners.

23:28-29 The Lord also announced that He would turn Jerusalem over to those whom she had come to hate, namely, the Babylonians. They would hate her, rob her of her property, and leave her naked and ashamed (in 586 B.C.).

23:30-31 This punishment would come on her because she committed political adultery with the nations and had defiled herself with their idolatry (cf. Exod. 20:1-7; Deut. 17:14-20). She had behaved as her older sister, so the Lord would give the cup of His wrath to her to drink (cf. Isa. 51:17, 22; Jer. 25:15-17, 28; Hab. 2:16; Zech. 12:2; Matt. 20:22; 26:39; Rev. 14:10), the same cup Oholah had to drink.

"In using this imagery Ezekiel belongs to a long prophetic chain that was to culminate in Jesus, who absorbed in his own person the horror of God's judgment, accepting it from his hand not without a shudder (Mark 14:36)."³⁵⁴

23:32-34 The Lord also promised that Oholibah would indeed drink from the large cup of God's judgment from which Oholah had drunk. Some commentators referred to this pericope as the "cup song" (cf. the "sword

³⁵²See Pritchard, ed., *Ancient Near . . .*, p. 181.

³⁵³See Cooper, p. 231.

³⁵⁴Allen, *Ezekiel 20—48*, p. 52.

song" in 21:8-17). Drinking this cup would make her an object of scorn as well as drunk and sad. The cup would contain punishment in the form of horror and desolation, just like Samaria had experienced. Oholibah would drain the cup; she would endure all the punishment God had for her. She would even madly gnaw the fragments of the earthenware cup or shatter it to pieces. The same Hebrew verb means "to gnaw" (NASB, NRSV) and "to break" (AV, NIV, NKJV). She would also tear at her breasts, probably in remorse over how she had used them to seduce her lovers. Another interpretation understands the cup as breaking and lacerating Oholibah's breasts. In other words, she would despise herself for her former behavior.

23:35 Jerusalem would bear the Lord's punishment for her lewd and immoral behavior because she had abandoned Him. This short message identifies the root problem in Israel's apostasy: she had forsaken Yahweh.

"When a nation (or an individual) discards God, there is no other road to follow but that which leads to perversion and utter degradation."³⁵⁵

A summary judgment for Israel's unfaithfulness 23:36-49

This final message brings Oholah and Oholibah back together and passes judgment on all Israel. It is a summary oracle for the section that indicts Israel's leaders (chs. 20—23).

23:36-37 The Lord called Ezekiel to pass judgment on Oholah and Oholibah (cf. 20:4; 22:2). He should then announce their fate because they had committed adultery (cf. Exod. 22:20; 23:13; Deut. 4:15-24; 12:24-32) and had shed innocent blood in their unfaithfulness (cf. Exod. 20:13; Lev. 18:21; 20:1-5). Their spiritual adultery consisted of idolatry, and their bloodshed was the practice of child sacrifice in connection with idolatry. They had killed the Lord's own children.

23:38-39 They also made the temple unclean (cf. Exod. 20:24-26) and treated the Sabbath as any other day of the week (cf. Exod. 20:8-11; Lev. 19:3, 30). On the same days that they practiced child sacrifice they entered the temple to worship Yahweh. This amounted to treating Molech and Yahweh as though they were equal.

23:40-42 These daughters had sent to other nations and invited ambassadors to come to them to make treaties (cf. Deut. 17:14-20). They had made themselves as attractive as possible, like a prostitute does for her lover. They even used the things that they should have used only for the worship of Yahweh to entice desert lovers (e.g. the Arabians, Moabites, and Edomites). The whole atmosphere of the reception was like that of a drunken orgy. The same Hebrew word, *saba'im*, can mean "Sabeans" and

³⁵⁵Alexander, "Ezekiel," p. 855.

"drunkards" (v. 42), and both meanings could have been intended (double entendre). These foreign lovers gave the Israelites the wages of a prostitute including bracelets and crowns.

23:43-45 The Lord marveled that the nations would find Samaria and Jerusalem attractive partners since they had proved to be such unsatisfying lovers for so long. Yet they did. There is hardly anyone more pathetic and disgusting than an old whore. However, righteous people would pass judgment on the sisters as adulteresses who had blood on their hands. The enemies of Israel were righteous in judging her, not that they were right with God spiritually. They may have even been more righteous in their conduct than the Israelites.³⁵⁶ Other interpreters believe that the righteous in view may be the spiritual leaders of the remnant of faithful believers in Israel (cf. Deut. 22:13-21).³⁵⁷

23:46-49 The Lord commanded a group of soldiers to attack these cities and to terrorize and plunder them. These invaders would stone the guilty (the punishment for adulterers and murderers in the Mosaic Law), slay them and their children with their swords, and burn their houses. Thus the Lord would cause such shameful unfaithfulness to cease from His land (cf. 22:15), and He would teach other nations not to do as these two "women" had done. Samaria and Jerusalem would bear their punishment for practicing idolatry, and they would learn that Yahweh is God.

"While most parables and messages concerning sin in the Old Testament seek to produce repentance, that is not so here. The message closed with a note of finality."³⁵⁸

E. THE EXECUTION OF JERUSALEM'S JUDGMENT CH. 24

Until now Ezekiel had predicted that judgment would fall on Jerusalem and Judah in the future. The day of that judgment finally arrived, and he proceeded to announce it with a parable and two acted signs or "action sermons."

"With these verses we come to the climax of all that Ezekiel has been trying to say in the previous twelve chapters."³⁵⁹

1. The parable of the cooking pot 24:1-14

This parable represented the siege of Jerusalem, which began on the day that Ezekiel told this story.

³⁵⁶Cooper, p. 233; and Fisch, p. 159.

³⁵⁷Feinberg, p. 136; and Dyer, "Ezekiel," p. 1273.

³⁵⁸Cooper, p. 233.

³⁵⁹Taylor, p. 176.

The background to the parable 24:1-3a

The Lord instructed Ezekiel to note permanently the day this revelation came to him because it was the very day that Nebuchadnezzar began his siege of Jerusalem. This day fell in January (cf. 2 Kings 25:1; Jer. 39:1; 52:4). Block dated it as January 5, 587 B.C.,³⁶⁰ but most scholars follow Parker and Duberstein and date it as January 15, 586 B.C.³⁶¹ Ezekiel's ability to announce the beginning of the siege from Babylon validated his ministry as a prophet. The Jews later memorialized this special day with an annual fast (Zech. 8:19). The prophet was also to deliver a parable to the Jewish exiles the same day. They were part of the "rebellious house" of Israel, one of God's favorite titles for His people Israel in this book.

The parable itself 24:3b-5

In this parable, the people were to put a bronze (v. 11) cooking pot (caldron, Heb. *sir*) on the fire and pour water into it. This large pot had two handles, a round base, and a large mouth. Then the people were to put various pieces of choice meat into the pot and were to build a strong fire under it so the water would boil and the meaty bones would cook. We might call verses 3b-13 "the cooking pot song" since it is a poem similar to "the sword song" (21:8-17) and "the cup song" (23:32-34).

There is no indication that this was another of Ezekiel's acted parables. Rather it seems to have been a message that the prophet spoke without dramatizing it by really boiling meat in a caldron.

The reasons for Jerusalem's present judgment 24:6-8

- 24:6 Ezekiel was then to announce woe on the bloody city (no longer the holy city) of Jerusalem (cf. Nah. 3:1), which the pot represented (cf. 11:3, 7, 11; Jer. 1:13-14). The pot had rust (Heb. *hel'ah*) in it that evidently stood for the blood of the people slain there (cf. 22:1-16). Another view is that the pot was bronze (which does not rust), and the red in it was the blood of the meat.³⁶² Ezekiel was then to draw several pieces of meat out of the pot at random, perhaps signifying God rescuing a remnant from judgment.
- 24:7 Blood was in Jerusalem's midst like the blood of a sacrifice that had not been drained out on the ground and covered up (atoned for) as the Law prescribed (Lev. 17:13). Israel's sins were open for all to see, like blood on a bare rock (cf. Isa. 3:9). Not only was Jerusalem a city that had shed much innocent blood, but it was an unacceptable sacrifice to God because of the blood that was in it.
- 24:8 Therefore Yahweh was draining the blood out of Jerusalem by allowing the Babylonians to slay the Jews in it. The innocent blood that the Jerusalemites had shed had cried out to God for Him to take vengeance

³⁶⁰Block, *The Book . . .*, p. 774.

³⁶¹Parker and Dubberstein, p. 28; Cooper, p. 235; Taylor, p. 177; Zimmerli, p. 498; et al.

³⁶²Block, *The Book . . .*, pp. 777-78.

and to execute wrath on the murderers, as Abel's blood had done (Gen. 4:10; cf. Isa. 26:21). As the people of Jerusalem had shed blood openly, so the Lord would shed their blood openly, on the bare rock of Jerusalem.

"The severe judgment sent by God upon Judah should be ample warning to those today who share the same callous disregard for the value of human life, both the born and the unborn."³⁶³

The results of Jerusalem's present judgment 24:9-13

This second oracle stresses not the boiling of meat in the pot but the cleansing of the pot by superheating, a second stage in God's judgment process.

- 24:9-10 The Lord pronounced woe on the bloody city of Jerusalem and promised to make the pile of bones of the slain inhabitants great (cf. Isa. 30:33). Therefore Ezekiel was to kindle a strong fire, to boil the meat well, to mix in the spices normally used when meat was cooked this way, and to let the bones burn. All this symbolized the fierceness of the attack on Jerusalem and the many people that would die there.
- 24:11 Then Ezekiel was to keep the empty caldron on the coals with the fire burning hotly under it so it would glow and all the impurities in it would burn up. This represented the continuing purification of Jerusalem after all the Jews had left it. It would remain empty, and that condition would free it from all sinful pollution for many years to come.
- 24:12 Jerusalem had wearied Yahweh as He toiled to scour its sin away in the past. The city would remain under judgment because its rust-like sin needed purging away (cf. 36:22-32).
- 24:13 Adultery in its many forms was part of Jerusalem's filthiness. It clung to the city even though the Lord had sent many prophets to clean it up and had already deported many of the people (in 605 and 597 B.C.). Now it was time for a thorough purging of the pot by the fire of God's wrath since cleansing with water had not been effective. Water and fire are two of God's favorite instruments of judgment, according to Scripture (cf. 2 Pet. 3:5-7).

The guarantee of Jerusalem's present judgment 24:14

In conclusion, the Lord promised that this judgment would come as He had predicted. He would not change His mind or mitigate the punishment. He would thoroughly judge the people because of their conduct and actions. They would be the meat and He would provide the heat. This is the most emphatic affirmation of divine resolve in the book.³⁶⁴

³⁶³Cooper, p. 237.

³⁶⁴Block, *The Book . . .*, p. 781.

"God's mercy prompts Him to withhold judgment as long as possible to enable people to repent (cf. 2 Peter 3:8-10), but He does not wait indefinitely. A time comes when God punishes wickedness."³⁶⁵

2. Signs to the exiles 24:15-27

The preceding parable pictured the siege of Jerusalem itself. The symbolic acts that Ezekiel performed next, perhaps on the same day, represented how the exiles were to respond to the news of Jerusalem's siege.

The sign of the death of Ezekiel's wife 24:15-24

24:15-16 The Lord told Ezekiel that He was about to take the life of his beloved wife. The English word "blow" (v. 16) implies a sudden, unexpected death. The Hebrew word, *magephoh*, does not demand a sudden death, but it sometimes describes such a death (cf. 1 Sam. 4:17; 2 Sam. 17:9; 18:7). It could also mean death by plague or disease or anything that strikes a person down (cf. Exod. 9:14; Num. 14:37; 16:44-50; 25:8-9). In any case, the prophet was not to mourn, weep, or shed any tears over this personal tragedy (cf. Jer. 16:5-13).

Such an announcement raises the question of whether God commits unprovoked acts of cruelty just to illustrate a point. In view of revelations of God's character here and elsewhere, we should probably interpret this statement as meaning that God allowed Ezekiel's wife to die at this precise time. He used her death, which He predicted to the prophet, to communicate a message to His people (cf. the unfaithfulness of Hosea's wife). The text does not say that God put her to death as an object lesson. She could have been ill for some time before she died. Another similar situation involved God allowing the death of His innocent Son to occur at precisely the time God intended as another expression of His love and judgment.

24:17 Ezekiel would have to sorrow inwardly; he was not to do so outwardly. It was customary for relatives of a dead loved one to wail long and loud with family, friends, and even paid mourners (cf. 2 Sam. 1:17; 11:26; Mic. 1:8). But Ezekiel was to observe none of the customary acts of mourning over the death of his loved one, which included throwing dust on his head, going barefoot, covering his mustache, and eating a modest meal after a day of fasting (cf. 2 Sam. 1:12; 3:35; Jer. 16:7; Hos. 9:4).³⁶⁶ Mourning was not appropriate in cases of capital punishment.

24:18-19 In the morning of the next day, or perhaps a few days later, Ezekiel addressed the people, and that evening his wife died. The prophet

³⁶⁵Dyer, "Ezekiel," p. 1274.

³⁶⁶See Roland de Vaux, *Ancient Israel: Its Life and Institutions*, pp. 59-61.

faithfully did as the Lord had commanded him. His actions bewildered the exiles who asked him to explain why he was behaving so abnormally.

"Ezekiel's entire life was a testimony to the exiles. Likewise, this should be the case with all who are the children of God by faith in Christ Jesus."³⁶⁷

24:20-21 The prophet replied that the Lord had said that He was about to destroy the temple and to slay the relatives of the exiles who remained in Jerusalem. The Jews loved the temple almost as much as Ezekiel loved his wife.

24:22-24 Ezekiel instructed the people to respond to their tragic loss as he had to his. The reason they were not to mourn publicly but only privately, though unstated, was that the judgment that God executed on Jerusalem was deserved.

"Ezekiel had a right to mourn his undeserved personal loss but did not. The Israelites had no right to mourn for their well-deserved national loss and could not . . ."³⁶⁸

"God is not the author of personal tragedy, but he does often use such experiences as unique opportunities and special windows through which people will come to 'know' that he is the Lord."³⁶⁹

The sign of Ezekiel's silence 24:25-27

24:25-26 Evidently Ezekiel was not to deliver any more prophetic messages to his fellow exiles after he made the explanation in verses 20-24 until he received word of the destruction of the temple and the capture of the remaining Judahites. This message reached him five months later (33:21). His enforced dumbness must have been limited to prophecies concerning Israel, however, because 25:1—33:20 contains oracles against foreign nations some of which are dated during the siege of Jerusalem.

24:27 When that news arrived, Ezekiel could resume speaking about Israel because the Lord would give him additional prophecies about Israel (cf. 33:21—48:35). His silence concerning Israel's affairs during the siege of Jerusalem would have been further testimony to his sorrow.

"In 24:24 he is a sign of God's *judgment* and its consequences; in 24:27 he is a sign of God's *grace* and its consequences."³⁷⁰

³⁶⁷Alexander, "Ezekiel," p. 862.

³⁶⁸Stuart, p. 243.

³⁶⁹Cooper, p. 240. Cf. Dyer, in *The Old . . .*, p. 682.

³⁷⁰R. W. Klein, *Ezekiel*, pp. 39-40.

Ezekiel was to be a model for the exiles of how they should respond to the siege of Jerusalem. They should treat it as an unspeakable tragedy. Ezekiel's example would teach the exilic community that Yahweh really was God.

"This is a pivotal chapter in the development of the book. Till now Ezekiel has variously proclaimed the Lord's coming judgment on Jerusalem and Judah. He has systematically answered each argument against the impending judgment. Nothing remained except for the enactment of that discipline recorded in this chapter. The beginning of Babylonia's siege of Jerusalem was described. Then Ezekiel prophesied against the foreign nations who had abused Judah and mocked her during her judgments (25:1—33:20). These foreign nations would be judged for their wicked attitude and actions toward Judah. However, the hope of future restoration and blessing would be promised to Judah."³⁷¹

III. ORACLES AGAINST FOREIGN NATIONS CHS. 25—32

It is appropriate that this section appears at this point in Ezekiel, between the messages announcing judgment on Judah and Jerusalem for sin (chs. 4—24) and the messages announcing future blessings for Israel (chs. 33—48). It heightens dramatic tension as the reader wonders what will be the fate of Israel now in view of God's promises.

This is the third major section of this book. Chapter 24 records prophecies that Ezekiel delivered on the day the siege of Jerusalem began (on January 15, 588 B.C.; 24:2). When Ezekiel heard that Jerusalem had fallen (in 33:21, on January 8, 585 B.C.), he left the past behind and turned to the future with messages of Israel's restoration (in chs. 33—48). So the oracles against foreign nations in this book have been placed between these two important events: the announcement of the beginning of the siege of Jerusalem, and the announcement that Jerusalem had fallen to the Babylonians. This is a reasonable place for these oracles against foreign nations, because now the opportunity for repentance had passed, foreign nations were in control of Jerusalem's fate, and at present there did not seem to be much hope for the exiles.

Ezekiel had anticipated and announced the judgment of Judah. The destruction of Jerusalem caused Judah's hateful neighbors to rejoice at her downfall. However, God announced through Ezekiel that they should not gloat because He would judge them for their attitude toward and treatment of His chosen people. All nations will answer for their sins, not just Israel. This whole section is a testimony to the faithfulness of God to His promise to curse nations that cursed Israel (Gen. 12:3). Other reasons that God would judge these nations also receive attention in some of these oracles, such as pride and oppression of other people, but all of them contain references to these nations' hostile treatment of Israel.

³⁷¹Alexander, "Ezekiel," p. 859.

"Oracles against foreign nations are an aspect of God's covenantal restoration promises to Israel (centrally located in Lev. 26:40-45 and Deut. 30:1-10). The reason for them is fairly simple: Israel's foes must decrease if Israel is to increase. The promise of power over enemies is a reversal of the curses of subjugation by enemies, as Deut. 30:7 says: 'The Lord your God will put all these curses on your enemies.' Such oracles, then, gave great reassurance to righteous Israelites that no matter how severe their own circumstances might be at the moment, the time was coming when the nation—in whatever future generation it might occur—would experience deliverance from exile and oppression and exaltation to God's favor and blessing. From the point of view of orthodox Israelites, the oracles against foreign nations were oracles of hope."³⁷²

MAJOR ORACLES AGAINST FOREIGN NATIONS						
	Isaiah	Jeremiah	Ezekiel	Amos	Obadiah	Zephaniah
Ammon		49:1-6	25:1-7	1:13-15		2:8-11
Moab	15—16	48	25:8-11	2:1-3		2:8-11
Edom	21:11-12; 34:5-17	49:7-22	25:12-14; 35	1:11-12	1-21	
Philistia	14:29-32	47	25:15-17	1:6-8		2:4-7
Tyre and Sidon	23		26:1—28:19 28:20-24	1:9-10		
Egypt	19	46:1-26	29—32			
Damascus	17	49:23-27		1:3-5		
Babylon	13:1— 14:23	50—51				
Ethiopia						2:12
Assyria						2:13-15

In addition to the major oracles against foreign nations in these prophetic books, Jonah and Nahum spoke to the situation in Assyria, and Daniel foretold the fate of Babylon and other nations. All the prophetic books in the Old Testament, except Hosea, contain some references to the future of the nations.

It is probably significant that Ezekiel mentioned seven nations, as did Jeremiah and Amos. Amos, who ministered in the Northern Kingdom of Israel, dealt with the Southern Kingdom of Judah as a foreign nation (Amos 2:4-5). The Jews regarded seven of anything as a divine work and or a complete number, dating back to God's creation of the cosmos in seven days. Thus these seven nations and city-states would have signified to the Jews that God would judge all such hostile pagan nations, not just these seven.³⁷³

³⁷²Stuart, p. 205.

³⁷³See the maps at the end of these notes for the locations of places referred to in these oracles.

Ezekiel did not record an oracle against Babylon. The commentators offer various explanations, but the one that appeals to me most is that God did not give him one, perhaps because for him to denounce Babylon in Babylon would have been very dangerous for the Jews. Daniel denounced Babylon in Babylon because God led him to do so and protected him and his people from danger. Another possible explanation follows.

"This absence may undoubtedly be attributed to the prophet's pro-Babylonian stance in political matters."³⁷⁴

A. ORACLES AGAINST JUDAH'S CLOSEST NEIGHBORS CH. 25

This chapter ties in very closely with the preceding one. Evidently all the messages in these two chapters date from the beginning of the Babylonian siege of Jerusalem (24:1-2). Even though this chapter begins a series of messages that all deal with God's judgment on the nations, the messages in this chapter followed on the heels of the announcement of the siege. It is as though God was warning Israel's closest neighbors not to gloat over her fate or to hope to profit from it since they too would undergo divine wrath in the form of Babylonian invasion. They would not triumph over Israel. Ezekiel had referred to their judgment earlier (21:20, 28-32) as had Jeremiah (Jer. 9:25-26; 25:1-26; 27:1-11; 48:1—49:22). Their captivity would also last 70 years (Jer. 25:11), but their larger judgment would continue, as Israel's would, from the time of their defeat by Nebuchadnezzar until the second coming of Christ (i.e., the times of the Gentiles, Luke 21:24; cf. Isa. 11:14; Dan. 11:41; Joel 3:1-4). The description of the first four nations proceeds in an essentially clockwise direction from east to west whereas the remaining three judgments deal with Tyre, Sidon, and Egypt north to south.

"The amount of space dedicated to each nation does not necessarily correspond to its importance in the ancient Near East of the sixth century B.C. Rather, by concentrating at length on two nations, mentioning at more-average length several others, and touching only briefly on yet others, this section of prophecies gives a realistic *over-all* impression of both thoroughness and variety."³⁷⁵

The four messages in this chapter each have four parts: an introduction, an indictment, a punishment, and an outcome.

1. Judgment on Ammon 25:1-7

The first oracle against Ammon consists of two messages and consequently contains a double indictment and punishment. Ezekiel previously recorded an oracle against Ammon (21:28-32). Its placement there was evidently due to the presence of "sword of the Lord" terminology in that oracle, which the other prophecies in that chapter also contain, and the sequence of prophecies there.

³⁷⁴Daniel I. Block, *The Book of Ezekiel: Chapters 25—48*, p. 4.

³⁷⁵Stuart, p. 248.

- 25:1-3a The Lord directed His servant Ezekiel to set his face toward the nation of Ammon and to deliver a message of judgment from Him.
- 25:3b The Ammonites had rejoiced (cf. 26:2; 36:2) over the destruction of the temple in Jerusalem (cf. 24:21), the desolation of the land of Israel, and the exile of the Judahites (cf. 2 Kings 24:2; Jer. 49:1; Zeph. 2:8-10).
- 25:4-5 Therefore the sovereign Lord would turn them over to the eastern invaders, the Babylonians, who would take over their country and settle in their land. The capital city, Rabbah (modern Amman), as well as the rest of the land, would become a desolation inhabited mainly by camels and flocks of sheep and goats. Nebuchadnezzar brought Ammon and Moab into subjection in the fifth year after Jerusalem fell (about 581 B.C.).³⁷⁶
- 25:6-7 Because the Ammonites had rejoiced over Israel's misfortune the Lord would punish them and give them as the spoils of war to other nations. He would end their existence as a separate nation and destroy them as a people. Ammon no longer existed as a nation after Nebuchadnezzar destroyed it and Bedouins from the east plundered it.³⁷⁷ This judgment would teach them that Yahweh is God.

"Oracles against foreign nations are always implicitly oracles of encouragement for God's people."³⁷⁸

The primary purpose of these oracles was that everyone would come to know that Israel's God is the LORD (v. 7). The phrase, "Thus you will know that I am the LORD " appears in almost every oracle or group of oracles, not only in this section of the book, but throughout Ezekiel. This clause means that people will come to acknowledge God for who He is and respond to Him accordingly. It is not just a statement that they will become convinced of His existence, even of His sovereignty, but that they will humble themselves and submit to His will.

Jeremiah predicted that Yahweh would restore the fortunes of the Ammonites (Jer. 49:6). This occurred briefly after the Exile. Tobiah was a Persian governor of Ammon during the postexilic period (cf. Neh. 2:10, 19; 4:7). But restoration of this region will also take place in the Millennium (cf. Jer. 46:26-28; 48:47).

Jeremiah also predicted the restoration of other foreign nations, but Ezekiel did not predict their restoration.

³⁷⁶Josephus, *Antiquities of . . .*, 10:9:7.

³⁷⁷Davidson, p. 180.

³⁷⁸Stuart, p. 250.

2. Judgment on Moab 25:8-11

- 25:8 The residents of Moab and Seir (Edom) had regarded Judah as just one of the other nations even though the Judahites were blood relatives of theirs (cf. Jer. 48:27; Zeph. 2:8-9). This attitude reflected disrespect for Yahweh. They viewed Israel's God as no better than other pagan deities since Judah had fallen to the Babylonians.
- 25:9-10 Consequently the Lord promised to destroy the frontier cities in which the Moabites took much pride. Beth-jeshimoth lay in the Jordan Valley and guarded the eastern ascent to the Medeba Plateau. Baal-meon stood farther to the east and south in northern Moab, and Kiriathaim was another northern town on the Medeba Plateau. Its name means "the glory of the land," a play on words with the same phrase that appears earlier in verse 9. Yahweh would give the whole country over to the control of the eastern invaders along with Ammon, and Moab would cease to exist as a nation (cf. v. 7; Jer. 48:7-9).
- 25:11 Yahweh would judge Moab, and the Moabites would come to realize that He is God. This nation also passed out of existence during the Exile.³⁷⁹ Yet Yahweh promised to restore the fortunes of Moab in the distant future (Jer. 48:47; cf. Jer. 46:26; 49:6, 39). This happened in a limited way after the Exile, but it will happen in the eschaton when modern residents of Moab's territory will stream to Jerusalem to worship Messiah in the Millennium.

3. Judgment on Edom 25:12-14

- 25:12 The Edomites had taken vengeance on the Judahites rather than helping them (cf. 36:1-7; Gen. 25:30; 27:41-46; 32:4; Lam. 4:21-22; Amos 1:11-12).
- 25:13 For this reason the Lord promised to send judgment on them. He would cause both man and beast to perish from their land, a picture of complete devastation (cf. 35:1—36:15). He would make the land a desolate waste from Teman to Dedan, throughout the country, as a result of an army invasion (cf. Joel 3:19; Obad.). Teman was a town in central Edom not far from Sela (Petra), and Dedan was a region southeast of Edom where Edomites evidently lived. Jeremiah revealed that this punishment would come through Nebuchadnezzar (Jer. 9:26; 25:21; 27:1-11). Edomites occupied southern Judah after the Exile.³⁸⁰
- 25:14 The Israelites would play a part in Edom's judgment acting as the Lord's agents of His anger (cf. 35:1—36:15; Isa. 11:14; Dan. 11:41; Amos 9:12; Obad. 18). The Edomites too would come to acknowledge Yahweh as the true God.

³⁷⁹Wevers, p. 197.

³⁸⁰Taylor, p. 188. Cf. 1 Esdras 4:50.

Today the residents of the territory formerly occupied by Ammon, Moab, and Edom all go by the name "Arab."

4. Judgment on Philistia 25:15-17

- 25:15-16 The Philistines to Judah's west had also scorned the Israelites and had sought to destroy them (cf. Judg. 13—16; 1 Sam. 4; 13; 31; 2 Sam. 5:17-25; 2 Kings 18:8; 2 Chron. 21:16-17; 28:18). Therefore the Lord would stretch out His strong hand in judgment against them and cut off the Cherethites, a group of Philistines who originated in Crete (ancient Caphtor; cf. 1 Sam. 30:14; Zeph. 2:5), and the rest of the Philistines who lived by the Mediterranean seacoast. This is a play on words in Hebrew. The Lord said He would cut off the cutters off (i.e., the Cherethites).
- 25:17 He would take vengeance on them for their treatment of His chosen people. He would do so by these rebukes executed in His wrath (cf. Isa. 11:14; Jer. 25:20; 47:1-7; Joel 3:1-4; Obad. 19; Zeph. 2:4-7). There is no record of the Philistines' existence after the second century B.C., though the name of their cities remained. They would know that Yahweh was God when they experienced His judgment.

These judgments should be a warning to any nation that spitefully treats the Chosen People of God (i.e., Israel, the physical descendants of Jacob) and that sins against the sovereign God in other ways. He will punish sin and those who abuse His people.

B. JUDGMENT ON TYRE 26:1—28:19

"When Jerusalem finally fell in 586, the only states that were still resisting the Babylonians were Egypt and Tyre. It is not coincidental, therefore, that of the foreign nations addressed by Ezekiel, these two are singled out for the brunt of his oracular volleys."³⁸¹

The length of this oracle reflects the great significance of Tyre at this time in Israel's history. Tyre (lit. "rock") was the principle city of Phoenicia and consisted of two towns: a fortified stronghold on a rocky outcropping one-half mile offshore, and a smaller community on the Mediterranean shoreline opposite this island town. King Hiram I had connected the two population centers with a causeway in the tenth century B.C.³⁸² Tyre was important because it was a major port, and therefore a commercial center, and a military center. It stood on the Mediterranean coast 35 miles from the Sea of Chinnereth (Galilee) and 100 miles from Jerusalem. Chapter 25 contains prophecies against nations to the east and west of Israel, but now the Lord looked north.

Ezekiel's prophecies of Tyre's destruction are the longest ones against this city-state in the Old Testament (cf. Isa. 23; Jer. 47:4; Amos 1:9-10; Zech. 9:3-4). He saw that God would use Nebuchadnezzar to punish all the enemies of Israel, among which Tyre and Egypt (chs. 29—32) were particularly formidable.

³⁸¹Block, *The Book . . .* 48, p. 32.

³⁸²Taylor, p. 189.

"The biblical record first mentions the city as a strong, fortified town that formed part of the boundary of the inheritance of the tribe of Asher (Josh 19:29). Tyre was prominent in the days of David and Solomon and throughout the remainder of OT history. Hiram, Solomon's contemporary, enlarged and beautified the city. Tyre became an important maritime city of the ancient Near East, being involved in great commercial and colonial enterprises throughout the Mediterranean area, the Red Sea, and the Indian Ocean. With the rise of Assyria to power, Tyre periodically submitted to Assyria's lordship, paying tribute out of the abundance of her wealth (as in the cases of Esarhaddon and Ashurbanipal). Whenever possible, however, Tyre rebelled against the Assyrian power and withstood the Assyrian retribution in the security of its island fortress (as in the case of Sennacherib). As Assyria began to decline in strength, Tyre exerted her complete independence. Tyre was in this latter condition when these oracles were delivered."³⁸³

The four major parts that make up this section alternate prophetic speeches (26; 28:1-10) and laments (27; 28:11-19).

1. Judgment by Babylonia and other enemies ch. 26

This chapter consists of four related prophecies, the first four of seven dealing with God's judgment of Tyre.

A general prophecy of Tyre's destruction 26:1-6

- 26:1 An oracle concerning Tyre came to Ezekiel on the first of an unspecified month in the eleventh year of the captivity, namely, 587-586 B.C. According to Cooper, this year began on April 23, 587 B.C.³⁸⁴ Some scholars speculate that the month was the eleventh month of this eleventh year and that in the process of textual transmission scribes accidentally omitted the number of the month because it was the same number as the year. Block reconstructed the date as February 3, 585 B.C., the date of the beginning of Nebuchadnezzar's 13-year siege of Tyre, which was also within a month after the news of the fall of Jerusalem reached Ezekiel.³⁸⁵
- 26:2 Divine judgment would come on this city-state because its people rejoiced at Jerusalem's destruction (cf. 25:3; Gen. 12:3; Prov. 15:5b). According to other prophets the Tyrians had also sold Jews as slaves to the Greeks and Edomites (Joel 3:4-8; Amos 1:9-10). The Tyrians viewed Jerusalem's destruction as advancing their commercial interests. The Tyrians controlled the sea routes, but Judah had controlled the land routes.

³⁸³Alexander, "Ezekiel," pp. 869-70. See also Zimmerli, *Ezekiel 2*, pp. 22-23, and Feinberg, p. 147, for short histories of Tyre.

³⁸⁴Cooper, p. 252.

³⁸⁵Block, *The Book . . .* 48, p. 35.

Controlling trade routes enabled a nation to impose tolls and so obtain revenue. Now Jerusalem would cease to compete with Tyre for this income. The Babylonians thus opened Jerusalem's gates to Tyre.

"When Judah was strong and subjugated Edom, she controlled the caravan routes to the Red Sea, thus hindering the Phoenician traders from gaining all the profit they hoped for."³⁸⁶

The prophetic perfect tense in Hebrew describes a future event as though it were past, as well as describing past events. Jerusalem fell on the tenth day of the fifth month of the nineteenth year of Nebuchadnezzar's reign (2 Kings 25:8; Jer. 52:12), which was the eleventh year of Jehoiachin's captivity. Dyer dated the fall of Jerusalem on July 18, 586 B.C.³⁸⁷ Because of the absence of reference to the month of this prophecy, it is impossible to date it definitely before or after the fall of Jerusalem. Ezekiel, however, gave it before news of Jerusalem's fall reached him and the other exiles (cf. 33:21).

26:3-4

The Lord would set Himself against Tyre and would bring up many nations against her, like waves against her shore. This was an apt description since both parts of ancient Tyre stood on the shore of the Mediterranean Sea. These nations would destroy Tyre's defensive fortifications and would even scrape the site as clean as a rock (Heb. *sela'*), a play on the name of the city (Heb. *sor*).

"The siege of Tyre by Nebuchadnezzar lasted for thirteen years (ca. 586-573 B.C.). Under King Ba'ali II, Tyre accepted Babylonian suzerainty and was ruled by 'judges.' However, when Babylonia declined in power, Tyre regained her independence once again. This brief freedom lasted till the second 'wave' of destruction brought her into submission to the Persians around 525 B.C. Tyre's remaining history demonstrated the continuing 'waves' of conquerors: the resistance to Alexander the Great, eventuating in her collapse; her initial resistance to the Seleucid kingdom of Antiochus III, terminating in her becoming part of that kingdom; her submission to Rome; and her fall to the Saracens in the fourteenth century A.D., after which she never again regained any importance. God was faithful to bring the 'many nations' against Tyre in successive 'waves' of conquest."³⁸⁸

Alexander the Great led the third "wave" of God's judgment that destroyed the walls of fortified Tyre in 332 B.C. He was the first to conquer both parts of the city in battle. He did so by enlarging the causeway from the

³⁸⁶Feinberg, p. 148.

³⁸⁷Dyer, "Ezekiel," p. 1278.

³⁸⁸Alexander, "Ezekiel," p. 870.

mainland to the island and then attacking the island fortress by land and by sea.³⁸⁹

26:5-6 Fishermen would someday use the site as a place to spread their nets to dry. The picture Ezekiel presented was that of the debris of the mainland city being pushed out into the sea where it would become a flat surface. Tyre would become spoil for the nations. Formerly she had spoiled the nations by taking their money in exchange for the commodities that she had traded. Furthermore, Tyre's daughters (her dependent villages on the mainland) would also fall in battle. The fulfillment of this prophecy would convince many of the Tyrians that Yahweh was the true God.

"Babylon is a byword for godless government, and Tyre is a byword for pride and self-sufficiency . . ." ³⁹⁰

The Lord Jesus ministered in Tyre (Matt. 15:21; Mark 7:24-31; Luke 6:17), and the residents responded positively to Him (cf. Matt. 11:21-22; Luke 10:13-14).

The first "wave" of judgment 26:7-14

26:7-9 In an explanatory prophecy about Tyre's destruction, the Lord promised to send Nebuchadnezzar as an invader from the north (cf. 2 Kings 25:21; Jer. 52:9). This is the first time Ezekiel identified the agent of God's coming judgment on Tyre by name. He was a "king of kings" in that many rulers were subject to him (cf. Dan. 2:37). This would be the first "wave" of conquest, and the Lord described it more fully than the later ones. Nebuchadnezzar would come against Tyre with a great army, besiege the city, break down its walls, and slay many of the Tyrians. After defeating Jerusalem in 586 B.C., Nebuchadnezzar proceeded north and attacked Tyre and its neighboring towns for thirteen years, beginning that same year.

26:10-11 Nebuchadnezzar's many horses would raise much dust and cause a loud commotion as they breached the walls, entered the city, and trampled the streets of the mainland town. Many people would die, and Tyre's strong pillars would fall. The pillars may refer to the leading inhabitants of the town and or to the prominent pillars in the temple of Melkart there (cf. 1 Kings 7:15).³⁹¹

"Nebuchadnezzar destroyed mainland Tyre . . ., but not the island stronghold. However, other evidence indicates that the island surrendered to Nebuchadnezzar in 573-572 B.C." ³⁹²

³⁸⁹Cooper, pp. 251-52; Zimmerli, *Ezekiel 2*, p. 24.

³⁹⁰Cooper, p. 253.

³⁹¹Wevers, p. 202. See Herodotus, *Histories*, 2:44.

³⁹²Dyer, "Ezekiel," p. 1279.

- 26:12 Tyre's enemies ("they") would take much spoil from the city and would push its physical remains into the sea (cf. Zech. 9:3-4). God accomplished this by the hand of Alexander the Great who used the rubble from the mainland town to widen the causeway (mole) to the fortress on the peninsula.
- 26:13-14 The Lord would silence the singing and music in Tyre (cf. Isa. 23:16; Rev. 18:22). He would turn its site into a bare rock suitable for the drying of fishnets (cf. 25:5-6). Moreover the city would not rebuild on that site again, a very unusual phenomenon in ancient times. This is the fate that Yahweh decreed for Tyre.

"*Shall never be rebuilt*" might be better translated 'will not be built-up again,' that is, 'will not go back to its former state,' and does not imply that the island of Tyre would never again have any buildings or inhabitants at all."³⁹³

The effect on Tyre's allies 26:15-18

- 26:15-16 The Lord also revealed that other towns would tremble when they heard of Tyre's overthrow. These were Tyre's vassals along the coast and among the islands that depended on Tyre for their prosperity and protection. Tyre had colonies in many Mediterranean coastal regions: Cyprus, Rhodes, Malta, Spain, Sicily, Sardinia, the Balearic Islands, and Africa.³⁹⁴ The rulers of these communities would go into mourning and would fear because of what had overtaken their mother city (cf. Job 2:11-13; Jon. 3:6; Rev. 18:9). They would abdicate their thrones and submit to the enemy invaders.
- 26:17-18 They would lament Tyre's fate and bemoan the destruction of such a mighty sea power, and they would acknowledge their own fear at the fall of Tyre. This brief lament is in the characteristic *qinah* or funeral dirge rhythm described previously. The Tyrians had rejoiced over Jerusalem's fall (v. 2), but these vassals demonstrated more wisdom by recognizing that the fall of Tyre meant judgment for them.

The demise of Tyre illustrated 26:19-21

- 26:19-20 The Lord further promised that after He destroyed the city by deluging it with great waves of invaders (cf. v. 3), it would die like a person placed in a grave (cf. 31:16; 32:18, 23-25, 29-30). It would go down into Sheol, as it were, and so lose its glory. He pictured the island fortress as submerged beneath a sea of invaders that would bury it (cf. 31:14-18; 32:13-32; Isa. 14:4-21).

"The most fearful prospect facing ancient mariners was to be caught in a storm and be 'lost at sea.'"³⁹⁵

³⁹³Stuart, p. 260.

³⁹⁴Feinberg, p. 150.

³⁹⁵Dyer, "Ezekiel," p. 1279.

Ezekiel mixed two metaphors for destruction in these verses: waves overwhelming a rocky seaside town, and a person going into the grave (pit, Sheol).

- 26:21 Terrors would overtake the people, and the city would exist no longer even though others tried to find it (cf. 27:26-35). They would search for the city on its former site but would discover that it was not there. In other words, it would enjoy no continuing importance in history. Today only a small fishing village exists on the site, and sailors use the rocks to dry their nets (cf. v. 14).

"The God who has chosen what is weak in the world also shames the strong by evidence of his power, so that no human being may boast in his presence (1 Cor 1:27-29)."³⁹⁶

2. A funeral dirge over Tyre ch. 27

This chapter consists of prose (vv. 1-3a, 10-25a) and poetic sections (vv. 3b-9, 25b-36). Ezekiel composed the poetic parts in the traditional *qinah* or funeral dirge rhythm.

"Many feel that the vividness of detail of this chapter places it practically without parallel in the history of literature. . . . To understand the chapter ethnologically one must study it in the light of Genesis 10; to do it justice from the viewpoint of prophecy, Isaiah 13—14 and Revelation 18 must be carefully weighed."³⁹⁷

The great ship Tyre 27:1-11

- 27:1-3 The Lord instructed Ezekiel to write a lamentation over Tyre, though presently it was renowned for its seafaring and commercial leadership in the world. Tyre's neighboring kings sang the first dirge over Tyre's demise (26:15-18), but Ezekiel was to utter the one in this chapter. The destruction of sinners always moves the heart of God, and it should also move the hearts of His spokespeople.

Tyre had taken great pride and conceit in itself, and this was another cause of its judgment by God (cf. 26:2; Ps. 10:4; Prov. 6:17; 8:13; 16:18). Like Jerusalem, it considered itself perfect in beauty (Lam. 2:15; cf. Ezek. 28:1-17; Rev. 3:17).

- 27:4 Ezekiel described Tyre as a large, beautiful merchant ship.³⁹⁸ He used this figure to portray Tyre's pride and her prominence and dominance as a maritime power.

³⁹⁶Allen, *Ezekiel 20—48*, p. 77.

³⁹⁷Feinberg, p. 152.

³⁹⁸See Edwin M. Good, "Ezekiel's Ship: Some Extended Metaphors in the Old Testament," *Semitics* 1 (1970):79-103.

"The earliest Phoenician ships each had 50 oarsmen and were quite fast. The later commercial ships were much longer and had a crew of up to 200 with two or three banks of oars on each side."³⁹⁹

The limits of this "ship of state" were those of the sea itself, and its builders had made it into a magnificent enterprise. The materials that had gone into its construction had been of the finest quality.

27:5-7 The wood was fir (probably pine or cypress) from the Mount Hermon region, and the mast was a strong cedar from Lebanon. Likewise her oars were of the best strong oak from Bashan, and her decks of boxwood (or cypress) from Cyprus contained beautifully inlaid ivory. Her linen sail had come from Egypt, which was famous for its linen products (Gen. 41:42; Prov. 7:16), and it had become Tyre's distinguishing flag or banner. The awning over the deck, or possibly the deck itself, was an attractive combination of violet and purple colors, and it came from Elishah (Italy, Sicily, Carthage, Cyprus, and Syria all being possibilities). In other words, Tyre's development as a city-state came through obtaining the finest materials of her day by trading with the producers of those materials.

27:8-9 Strong men from Sidon and Arvad, other neighboring Phoenician towns, were this ship's rowers, and its pilots were wise men. The Phoenicians were peerless in their seamanship in antiquity. The repairmen on board were also wise men from the famous elders of Gebal (Byblos in Lebanon). All other trading peoples cooperated with Tyre because it was the leading merchant marine power of its day.

"The description of every lavish detail of the trading vessel that represents the city of Tyre is expressed as an elaboration of Tyre's opinion of her own matchlessness: '*I am perfect in beauty*' (3)."⁴⁰⁰

27:10-11 Famous mercenaries from distant lands were on board; Tyre was able to attract warriors to fight for her because she was strong. But the outstanding men of Tyre itself were traders, not soldiers. These foreign soldiers came from as far away as Persia, Lud (Lydia in Anatolia, modern eastern Turkey), and Put (on the African coast of the southern Red Sea). Some authorities equate Put with Libya, but 30:5 treats them as two separate places. These soldiers contributed to the glory of Tyre's reputation as a mighty city-state. Likewise the men of Arvad and the Gammadim (men of Gammad, places unknown) were part of her fighting force. They hung their shields on Tyre's walls identifying themselves with her and pledging to defend her. The NIV translators believed Helech was the name of a place, namely, a region in southeast Anatolia (the later Roman province of Cilicia where the Apostle Paul grew up). The NASB editors preferred to translate this word as "your army."

³⁹⁹Dyer, "Ezekiel," p. 1280.

⁴⁰⁰Taylor, p. 192.

The extent of Tyre's commercial empire 27:12-24

This section is a valuable resource for understanding the geography, natural resources, and trade relations of the ancient Near East as well as explaining the extensiveness of Tyre's commercial empire. Notice the large numbers of places and products named.⁴⁰¹

- 27:12-13 Tyre's trading partners included Tarshish (at the western end of the Mediterranean, probably southern Spain or Sardinia), which gave silver, iron, tin, and lead for her wares. There was a Tartessus in both southern Spain and in Sardinia.⁴⁰² Javan (Greece), Tubal, and Meshech (both in eastern Anatolia) paid for their purchases from Tyre with human slaves and vessels of bronze.
- 27:14-15 The people of Beth-togarmah (Armenia) gave mules and horses, including war horses, for Tyre's wares. The Dedanites, who lived in Arabia along the Persian Gulf or the Gulf of Aqabah, also traded with Tyre and paid for their merchandise with ivory tusks and ebony. Some translators followed the Septuagint here and replaced Dedan with Rhodes, a Greek Aegean port, because the change only involves repointing the Hebrew word and because Dedan appears again in verse 20.
- 27:16-17 Syria was one of Tyre's customers and provided her with emeralds, purple, embroidered goods, fine linen, coral, and rubies in exchange for its purchases. Judah also traded with Tyre and exchanged wheat from Minnith (in western Ammon), cakes or confections, honey, oil, and balm for her goods.
- 27:18-19 Damascus also found Tyre an attractive trading partner because of her extensive inventory of various products and paid for her purchases with wine from Helbon (Aleppo, northwest of Damascus) and white wool (or wool from Zahar, also northwest of Damascus). Veda (or Danites) and Javan (or Greeks from Uzal, an old capital of Yemen in eastern Arabia) paid for their wares with yarn, wrought iron, cassia, and sweet cane.
- 27:20-21 Dedan also provided saddlecloths, and other Arabians and the Arab tribes of Kedar, a nomadic people, paid lambs, rams, and goats for their goods.
- 27:22-24 Traders from Sheba and Raamah, other areas of Arabia, paid for their wares with spices, precious gems, and gold. Haran (in Aramea), Canneh (or Calneh, in Mesopotamia), Eden (south of Haran), Sheba (in eastern Arabia), Asshur (Assyria), and Chilmad (probably in Mesopotamia or Arabia) exchanged garments, carpets, and finely crafted clothing materials.

⁴⁰¹See the maps at the end of these notes for probable locations of these places. *The Bible Knowledge Commentary: Old Testament* also has a chart of "Tyre's Trading Partners" listed in verses 12-25 on page 1281.

⁴⁰²Feinberg, p. 223.

The sinking of the great ship 27:25-36

This great ship (commercial empire) was headed for shipwreck.

27:25 Ships from Tarshish, probably Spain, carried Tyre's merchandise. Tyre became very rich because of all this sea trade.

27:26-27 Tyre's merchants had brought her "ship" into great waters, but there it encountered a strong east wind that broke it, namely, Babylon. All who contributed to the success of Tyre's enterprise would fall into the chaotic sea when God overthrew this ship of state.

"Any ship can be sunk by the Master of the seas."⁴⁰³

27:28-31 The cry of the Tyrians when destruction came would cause all her merchants, trading partners, and onlookers to bewail and mourn (cf. Rev. 18:17-19).

27:32-34 They would lament the demise of this great commercial empire regarding it as the mightiest power of its kind on the earth. Thus we have a lamentation within a lamentation (cf. v. 2). Tyre had satisfied the materialistic desires of many nations and kings. These onlookers would wail because Tyre's "ship" had sunk.

27:35-36 Tyre's trading partners would stand appalled at her, and their kings would fear for the prosperity of their own kingdoms. Other merchants would whistle in amazement at her unbelievable collapse (cf. 1 Kings 9:8; Rev. 18:15-19). Tyre herself would quake with terror and would pass into oblivion.

"The record of Tyre has a peculiar relevance for our day, for those areas in which she excelled and was the envy of the entire ancient world are precisely the fields in which every modern nation seeks superiority. But Tyre has a message for our age, and it is that riches without God are unable to satisfy the heart of man and often keep many from dependence upon God. Has not this spirit invaded the church, and does it not pervade the lives of too many Christians?"⁴⁰⁴

3. A judgment speech against the ruler of Tyre 28:1-10

28:1-2 Ezekiel was to speak an oracle to the contemporary leader (Heb. *nagid*, prince, ruler, king) of Tyre in the Lord's name, probably King Ethbaal II (also known as Ittobaal II and Ithobalus II, ca. 590-573 B.C.). As usual in political affairs, the king often represents the kingdom he served and even other kings that preceded him who possessed the same characteristics that he did. In this case, a spirit of pride marked the king as well as his nation.

⁴⁰³Stuart, p. 267.

⁴⁰⁴Feinberg, p. 157.

". . . the attack is not so much a personal criticism of the ruler as a verbal onslaught on the state."⁴⁰⁵

While one particular king is in view, we should view him as the representative head of his city-state. Similarly, the President of the United States personifies the policies of this country. We often speak of him when we are referring to the country as a whole. He is uniquely responsible, but he is also a representative figure. The king of Tyre had become very proud because of the prosperity of his seafaring kingdom (cf. 29:3; 2 Kings 18:33-35; Dan. 3:15; 4:30; Acts 12:21-23). He had even thought he was in God's place of control over his own and Tyre's affairs. Ancient Near Easterners often viewed their kings as the embodiment of their gods, and this king appears to have concluded that he was a god.⁴⁰⁶ Nevertheless he was only a man.

"As probably nowhere else in Scripture, pride is set forth in this chapter as the destroying sin."⁴⁰⁷

- 28:3-5 Indeed, the king was a very wise man, wiser even than Daniel, who had revealed divine secrets to Nebuchadnezzar. Daniel had been in Babylon since 605 B.C., almost 20 years, so he was by this time well-known. Another possible interpretation is that the king thought he was wiser than Daniel, not that he knew of Daniel necessarily, but Ezekiel used Daniel as a standard of great wisdom. The king of Tyre had understanding of matters that were obscure to other people, or he believed that he did. His wisdom had enabled him to become rich personally and to make Tyre wealthy. His wise trading had enabled him to increase those riches. He had become very proud because of the success he had enjoyed. Note that the character of Daniel was the opposite of this ruler, though they were both very intelligent. It is not uncommon for people today, even Christians, to deify themselves in their own minds when they experience great success.
- 28:6-7 Almighty God announced that because the king had exalted himself in pride the Lord would bring ruthless strangers against him from among other nations. They would fight against his commercial empire, resist his wisdom, and mar the beauty of Tyre's splendor. Nebuchadnezzar was one of the first of these strangers (cf. 26:7).
- 28:8-9 The enemy would slay the king and his city-state. Tyre would cease to exist as other empires had also died (cf. 27:26-34). She would no longer be a great sea power. This ruler and his city would then not be able to continue to believe that they were superior and all-powerful like a god.
- 28:10 The king would die a shameful death (cf. 32:30; 1 Sam. 17:26, 36). The Phoenicians practiced circumcision, so to die the death of the

⁴⁰⁵Taylor, p. 195.

⁴⁰⁶See John Gray, "Canaanite Kingship in Theory and Practice," *Vetus Testamentum* 2 (1952):193-200.

⁴⁰⁷Feinberg, p. 165.

uncircumcised meant to die like a barbarian. Strangers would slay him. This is the fate that Yahweh decreed for him and his empire.

4. A funeral dirge for the king of Tyre 28:11-19

"This is one of the more difficult passages in the Book of Ezekiel—if not in the whole Bible! The reason for the difficulty lies mainly in the lack of sufficient data to reach precise conclusions. There are many terms and phrases that are only used in these verses in the OT. . . .

"Ancient mythology should be kept in mind, for it shows the Phoenicians' religious thinking and provides cultural aid in interpreting the passage. However, to interpret the passage as a myth is unwarranted."⁴⁰⁸

- 28:11-12 Ezekiel received instruction from the Lord to lament the king (Heb. *melek*) of Tyre. Evidently the same person addressed in the previous speech (vv. 1-10) is in view in this lament. The writer's use of a different title from the one in verse 1 has led some scholars to conclude that a different person is in view, possibly the patron god of the city, Melkart. Others believe the Antichrist is in view in verses 1-10 and Satan in verses 11-19.⁴⁰⁹ But "king" elsewhere in Ezekiel describes a human ruler. He had been the model of perfection in the sense that he was full of wisdom and beauty (cf. vv. 2-5; 27:3). "The seal of perfection" is literally "the one sealing a plan." He had been the leader responsible for affixing his seal to the plans that resulted in Tyre's maritime glory.
- 28:13 This king had been in Eden, the garden of God, or Ezekiel was comparing him to someone who had been there. Some authorities believe Ezekiel had Adam in view, but the comparison with Adam quickly breaks down in the passage. Much less likely are the views that the tower of Babel or the Flood is in view or that the prophet was thinking of an ideal man. "Eden, the garden of God," is probably a figurative way of describing the blessing that this ruler had enjoyed at God's hand. References to "Eden" and "the garden of God" appear later in Ezekiel (cf. 31:8-9, 16) as the environment of the Egyptian Pharaoh. These, then, appear to be metaphors for a paradisiacal, park-like habitation suitable for a proud king, not the "Garden of Eden" of Genesis 1 (cf. Gen. 13:10). If we take the statement literally, this must refer to someone who was in the Garden of Eden, probably Satan. The description of this ruler covered with precious gems and gold indicates the extent of his wealth. If taken literally, this would have to refer to a human king. The suggestion that Israel's high priest is in view here because he bore such precious stones on his shoulders and breastpiece is farfetched. There are no other connections with the high priest in this passage. God had prepared this king for this privileged destiny from the time that He had created him (cf. Exod. 9:16; Rom. 9:17).

⁴⁰⁸Alexander, "Ezekiel," p. 882.

⁴⁰⁹See L. S. Chafer, *Systematic Theology*, 2:40; and *The New Scofield* . . . , p. 869.

"The concept of the Garden of Eden presents one of the major difficulties in interpreting this section as Tyre's literal human king. A possible solution may be found in understanding ancient Near Eastern temples. These ancient temples normally encompassed a large enclosure with a garden, not just a building (cf. van Dijk, p. 117). If the term for 'God' in this phrase is understood as 'god,' then perhaps 'Eden, a garden of a god,' was an expression used metaphorically to describe the splendor of the temple complex of Melkart, the 'king of the city' (which was the meaning of the god's name), with whom Tyre's human king was seeking identity. Though this interpretation is a hypothesis (as are all others), normal cultural hermeneutics may aid in the explanation of the text and should not be ignored. It is readily admitted that this phrase 'you were in Eden, the garden of God' is the most difficult obstacle to the interpretation of the king of Tyre as the literal king of the city. The above, however, is certainly a plausible understanding of the phrase."⁴¹⁰

28:14 God had given the king a position as an anointed cherub who covers or guards. This description has suggested to many readers that the king in view may be more than a man. Perhaps the Lord was looking beyond the human king of Tyre to the spiritual ruler behind him, namely, Satan (cf. Dan. 10:13; Matt. 16:21-23).⁴¹¹ It is more probable that the human king was cherub-like in that God had allowed him to reign, and he exercised a guarding function over his city-state. Ancient Near Easterners viewed their kings as the chief guardians of their gods.

"It seems as if Tyre's king was identifying himself with the patron deity of Tyre, Melkart, directly or symbolically, as the god's guardian sphinx. The Phoenician male-sphinx (or cherub) was normally bejeweled and sometimes had the head of the priest-king (cf. Barnett, p. 13). The sphinx was considered to be all-wise. Such a description fits well the verses under discussion, for the king is called a guardian cherub (sphinx) and the many jewels listed in v. 13 as his covering befit the many jewels that adorned the Phoenician sphinx (cherub). The passage would then be declaring that the king of Tyre had become as the guardian cherub for the god Melkart and was bejeweled with his riches as cherub-sphinx normally was."⁴¹²

⁴¹⁰Alexander, "Ezekiel," p. 883. His reference is to H. J. van Dijk, *Ezekiel's Prophecy on Tyre*.

⁴¹¹Cooper, p. 268; Feinberg, p. 161; Freeman, p. 306; Wiersbe, p. 216.

⁴¹²Alexander, "Ezekiel," p. 883. Here his reference is to R. D. Barnett, "Ezekiel and Tyre," in *Eretz-Israel*, vol. 9.

This ruler had also been on the holy mountain of God, a title that appears exactly this way nowhere else in the Old Testament. This description suggests Jerusalem (cf. Ps. 99:9; Isa. 11:9; 56:7; 65:25), but a mountain in Scripture is also a figure for a kingdom (e.g. Ps. 30:7; et al.). What other literal mountain might be in view is hard to imagine since there are no literal mountains that God had uniquely appointed close to Tyre. Perhaps Ezekiel meant that the king of Tyre had been walking in Jerusalem among fiery stones gathering spoils (cf. 26:1-6) shortly after Jerusalem's destruction. Or perhaps he meant that the king of Tyre was in the domain of the pagan deities ("the mount of god" meaning "the seat of the gods") since he claimed to be a god and was perhaps a guardian cherub of Melkart.

"The lament God inspires Ezekiel to sing over the king of Tyre contains a series of metaphorical references to the story of the Garden of Eden and to the Mountain of God. The king is compared to a guardian angel at the mountain and, in a way, to Adam himself in the garden. The comparisons are not exact, but imagistic—overtones and general allusions rather than straight one-for-one correspondences to the garden story. The allusions to the mountain of God (e.g., vv. 14, 16) reflect a poetic theme in the Old Testament in which the mountain represents God's abode."⁴¹³

Allen believed the mountain in view was Mt. Zaphon, in northern Syria, which, in Ugaritic mythology, was the abode of the gods.⁴¹⁴

". . . it seems . . . likely that Ezekiel's imagination wandered freely and drew on a wide variety of symbolical background all interwoven with his message of the fall of Tyre."⁴¹⁵

Probably the kingdom of God is in view here. Evidently the meaning is that this ruler participated in God's universal kingdom by ruling as king over Tyre, since all rulers occupy their thrones with the sovereign Lord's permission (Rom. 13:1). This ruler also walked among the stones of fire, or the brightly shining stones, just mentioned (v. 13). That is, he lived in an environment that was glorious and blessed by God.

"The ritual of burning a god has been discovered on a bowl from Sidon and is recorded in the cult of Melkart at Tyre (cf. Barnett, pp. 9-10). Melkart's resurrection was celebrated by a 'burning in effigy,' from which he would then be revitalized through the fire and the smelling of the

⁴¹³Stuart, p. 273.

⁴¹⁴Allen, *Ezekiel 20—48*, p. 95.

⁴¹⁵Taylor, p. 197.

burnt offering. Again, in keeping with the Phoenician religious-cultural background with which the passage is so closely tied by the king's claim of deity, perhaps the explanation of walking among the fiery stones is a reference to the king's self-exaltation of himself even as the god Melkart—even to the extent of his claiming resurrection after burning by fire."⁴¹⁶

28:15 The king had conducted himself blamelessly from his earliest days until he lifted himself up in pride.

Some interpreters believed that the Old Testament speaks of the fall of Satan in Isaiah 14:12-17 as well as in this passage.⁴¹⁷ Cooper charted the similarities between these two passages.⁴¹⁸ I think that neither Ezekiel 28:11-19 nor Isaiah 14 contains information about Satan before the Fall. The main reason for this conclusion, among others, is that in both cases a king (of Tyre or Babylon) is the object of the prophecy. A literal interpretation of these "kings" is possible and, therefore, preferable.

"Some persons grumble that Scripture does not in numerous passages set forth systematically and clearly that fall of the devils, its cause, manner, time, and character. But because this has nothing to do with us, it was better not to say anything, or at least to touch upon it lightly, because it did not befit the Holy Spirit to feed our curiosity with empty histories to no effect."⁴¹⁹

28:16 Abundant trade had made this king increasingly violent to the point that he sinned against God. The reference to trade supports the view that the earthly king is in view. This could hardly describe Satan.

Because of this sin, the Lord had cast the king from His mountain as profane or common. The king could no longer rule under God's permissive authority. The Lord had destroyed His servant in that He had removed him from his privileged place of service and allowed his enemies to defeat him.

28:17 The Lord repeated the fact of His judgment and the reason for it, namely, the pride of the king. Yahweh had brought him down from his exalted position to the level of other ordinary people; he would no longer be god-like. He had also demonstrated His humiliation before the king's peers, other kings, that they might observe and learn.

⁴¹⁶Alexander, "Ezekiel," p. 884.

⁴¹⁷E.g., Paul P. Enns, *Ezekiel*, p. 131, and W. A. Criswell, *Expository Sermons on the Book of Ezekiel*, p. 149.

⁴¹⁸Cooper, pp. 269-70.

⁴¹⁹Calvin, 1:14:15.

- 28:18 The king had also multiplied iniquities through the abundant trade he had pursued unjustly thus making what should have been clean common (cf. v. 16). Therefore, God would consume the king with His judgment that would arise from within his own sinful self. He would allow everyone on earth to witness his destruction.
- 28:19 Those who knew him would feel appalled at his end. He would be a source of terror to observers, a horrible warning of the consequences of pride, and he would be no more.

"What Adam and Eve were tempted to try to get was equality with God (Gen. 3:4 [*sic* 5]). That is exactly what Tyre's king wanted, too. Whatever he personally may have thought of himself, the passage makes it clear that his actions were those of a person seeking such wealth and power as to be his own god."⁴²⁰

Conservative interpreters of this passage divide into three basic groups. Some believe that only the human king of Tyre is in view throughout the passage.⁴²¹ Others believe only Satan is in view.⁴²² The third view is that both the human king and Satan are in view. Some who hold this opinion believe that the king is the primary referent and that Satan is seen as the power behind his throne.⁴²³ Others hold that the primary referent is Satan and that the king comes into view only secondarily.⁴²⁴

As far as I have been able to determine, the view that this passage reveals something about Satan before the Fall (Gen. 3) originated with the church fathers, including Origen, in the third and fourth centuries A.D. They applied the teaching of the passage to Satan and even interpreted it as specifically teaching things about Satan.

C. JUDGMENT ON SIDON 28:20-24

- 28:20-21 Another oracle concerning Sidon, Tyre's neighbor about 20 miles to the north, came to the prophet from the Lord. God may have condemned Sidon because of its close association with Tyre, though it was responsible for its own actions.
- 28:22 The Lord announced His antagonism against Sidon and His plan to receive glory through the way He would deal with this town. The people would know that Yahweh was the only true God when He judged Sidon and thus manifested His holiness. Klein believed this verse states the theological

⁴²⁰Stuart, p. 274.

⁴²¹E.g., Alexander, "Ezekiel," pp. 882-85; Taylor, pp. 196-97; Keil, 1:409-25; Ellison, pp. 108-9; Allen, *Ezekiel 20—48*, p. 95; Block, *The Book . . . 48*, pp. 118-19; *The Nelson Study Bible*, notes on Ezek. 28:12, 13, 14, 15, and 16-19; Stuart, pp. 273-74; and myself.

⁴²²E.g., Chafer, 2:39-44; Merrill F. Unger, *Biblical Demonology: A Study of the Spiritual Forces Behind the Present World Unrest*, p. 15; and J. Dwight Pentecost, *Your Adversary the Devil*, pp. 11-19.

⁴²³E.g., Cooper, pp. 265-68; and Feinberg, pp. 159-64.

⁴²⁴E.g., Dyer, "Ezekiel," pp. 1283-84; idem, in *The Old . . .*, p. 685.

key to the oracles against foreign nations, namely, Yahweh would vindicate His holiness and glorify His name when He judged the nations.⁴²⁵

- 28:23 God would send disease, bloodshed, and soldiers against Sidon, and many of her people would die in her streets (cf. 6:11-12; 14:21). This would teach the Sidonians that God is the Lord.
- 28:24 The reason for this judgment was that Sidon had been a thorn in the side of God's people by scorning them (cf. Gen. 12:3). Again the Lord promised that onlookers would learn that He is God.

All the oracles against foreign nations are evidence of the truth of God's promise in Genesis 12:3. In that verse, God promised to curse Israel's enemies. So, in a sense, the prophecies of hope for Israel (chs. 33—48) really begin with the oracles against foreign nations in chapters 25—32.

D. ISRAEL'S RESTORATION FROM THE NATIONS 28:25-26

As in numerous other prophetic Scriptures, promises of Israel's restoration accompanied predictions of judgment on the nations (e.g. 34:27; 38:8; 39:26; Isa. 65:21; Jer. 23:6; Amos 9:14-15).

"The words of hope inserted in 28:24-26 function as a fulcrum, dividing Ezekiel's oracles against foreign nations into two sensitively balanced halves, virtually identical in length . . ." ⁴²⁶

- 28:25 The Lord also promised to re-gather His people to their land and to manifest His holiness in them so that all the nations would see it (cf. v. 22; 20:41; chs. 33—39). They would then live in the land that God had promised to His servant Jacob (Gen. 35:12; cf. Gen. 12:7; 26:3).
- 28:26 The Israelites would live there securely, building houses and planting vineyards, when the Lord punished all the nations that had scorned His people. This would teach them that He is God. This is a rare prediction of Israel's restoration in the oracles against foreign nations, though in another sense, all these prophecies of judgment on Israel's enemies are promises of Israel's exaltation. For Israel to rise, these other nations must fall.

After the Babylonian Captivity some Israelites returned to live in the Promised Land, but they did not live there in safety. In fact, the Jews have never yet lived safely in their own land. Fulfillment awaits the return of Jesus Christ and His millennial kingdom.

⁴²⁵Klein, pp. 130, 141.

⁴²⁶Block, *The Book . . .* 48, p. 4.

E. JUDGMENT ON EGYPT CHS. 29—32

Ezekiel concluded his oracles against foreign nations with seven messages the Lord gave him concerning the fate of Egypt, one of Israel's most ancient and powerful enemies (cf. Isa. 31:1; Jer. 9:25-26; 25:17, 19; 46:1-26). The seven oracles against Egypt are equal in length to the preceding six oracles against Ammon, Moab, Edom, Philistia, Tyre, and Sidon. Like Jeremiah, Ezekiel showed great interest in Egypt, because of Egypt's significant role in Judean affairs at this time. God controls everything, even the fate of Israel's most notorious antagonist. One of these messages is out of chronological order (29:17—21) and another one appears to be (30:1-19). Since the Lord gave these oracles to Ezekiel over several years, it may be helpful to chart them in relation to other important events in Egypt's history.

EZEKIEL'S ORACLES AGAINST EGYPT IN THE CONTEXT OF EGYPT'S CHRONOLOGICAL HISTORY		
Event	Date	Reference
Egypt's domination of Israel	605-609	
Babylonia's defeat of Egypt at Carchemish	605	
Egypt's offers of assistance to Israel against Babylonia	605-586	
The beginning of Nebuchadnezzar's second siege of Jerusalem	588	2 Kings 25:1; Ezek. 24:1-2
Pharaoh Hophra's interruption of the siege of Jerusalem	588	Jer. 37:5-11
EZEKIEL'S FIRST INTRODUCTORY PROPHECY AGAINST EGYPT	587	Ezek. 29:1-16
EZEKIEL'S SECOND PROPHECY DESCRIBING PHARAOH HOPHRA'S INITIAL DEFEAT AND EGYPT'S ULTIMATE DESOLATION	587	Ezek. 30:20-26
EZEKIEL'S THIRD PROPHECY COMPARING EGYPT'S FALL TO ASSYRIA'S COLLAPSE	587	Ezek. 31
The continuing siege of Jerusalem	587	Jer. 32:1-5
The fall of Jerusalem and King Zedekiah's capture	586	2 Kings 25:5-7
The exiles' reception of the news of Jerusalem's fall	585	Ezek. 33:21
EZEKIEL'S FOURTH PROPHECY IN THE FORM OF A FUNERAL DIRGE	585	Ezek. 32:1-16
EZEKIEL'S FIFTH PROPHECY—A SUMMARY LAMENT	585	Ezek. 32:17-32
EZEKIEL'S SIXTH PROPHECY DESCRIBING EGYPT AS NEBUCHADNEZZAR'S SPOIL FOR DEFEATING TYRE	571	Ezek. 29:17-21
EZEKIEL'S SEVENTH PROPHECY ABOUT THE DESTRUCTION OF EGYPT AND HER ALLIES	571	Ezek. 30:1-19

"The fact of so many prophecies on the same subject should be a reminder to the modern communicator that the truth of a message is conveyed only when the audience actually pays attention to it. Since audiences often change gradually and/or constantly, and people don't always pay attention the first time—or the next time—the communicator may have to repeat the message many times before some people really hear it."⁴²⁷

1. An introductory prophecy of judgment on Egypt 29:1-16

- 29:1 This is another dated prophecy. It came to Ezekiel in the year before his first oracle against Tyre (26:1), namely, in 587 B.C. The specific date is January 7, 587 B.C.⁴²⁸
- 29:2 The Lord directed His prophet to turn his attention to the south, to Pharaoh, king of Egypt, and to all of Egypt, and to announce a message of judgment. As often in such prophecies, the king is a metonym (figure of speech) for his nation.
- 29:3 Like the king of Tyre and his people, Pharaoh and Egypt had also been guilty of pride. He had become like a great river monster (Heb. *tannim*, probably a crocodile of which there were many in the Nile) because he had taken credit for the Nile River, the lifeblood of the nation. *Tannin*, a variant spelling of *tannim*, is translated "serpent," "leviathan," and "sea-monster" (Gen. 1:21; Exod. 7:9-10; Job 9:13; 26:11-13; Ps. 89:10; Isa. 27:1; 51:9; Amos 9:3). It describes real animals as well as mythological monsters in the Old Testament. In ancient Near Eastern mythology this word referred to the monster of chaos destroyed in Creation. Egyptians believed Pharaoh conquered this chaos-monster, but here God called Pharaoh this monster. Rather than giving God thanks for the Nile as a resource, the king had proudly claimed responsibility for it.
- "This was [Pharaoh] Hophra's ([Gr.] Apries') arrogant self-image. Herodotus implied that Pharaoh Apries was so strong in his position that he felt no god could dislodge him.⁴²⁹ In his reign he sent an expedition against Cyprus, besieged and took Gaza (cf. Jer 47:1) and the city of Sidon, was victorious against Tyre by sea, and considered himself master over Palestine and Phoenicia. . . . This arrogance had also shown itself in an attempt to interrupt Babylon's siege of Jerusalem—an attempt thwarted by God."⁴³⁰
- 29:4 The Lord promised to remove Pharaoh and his people from their land, as a fisherman pulls a crocodile out of the water with hooks. He would remove

⁴²⁷Stuart, pp. 298-99.

⁴²⁸Parker and Dubberstein, p. 28.

⁴²⁹Herodotus, 2:169.

⁴³⁰Alexander, "Ezekiel," p. 891.

the river-dragon along with the lesser fish that would cling to it. These fish probably refer to the neighbor nations and allies of Egypt that relied on her. Normally people caught crocodiles by placing hooks in their jaws and then dragging them onto land where they killed them.⁴³¹ In the delta region of Egypt, the Egyptians worshipped the crocodile as a god, Sebek, which they believed protected their nation (cf. 32:2; Ps. 74:13; Isa. 27:1; 51:9). Thus God promised to destroy Pharaoh, Egypt, and the god supposedly responsible for their protection.

- 29:5 The Lord would carry the dragon into a wilderness along with its dependent fish where they could not return to water. There the beasts and birds would devour Egypt. Hophra (588-569 B.C.) would not receive a royal burial, which was extremely important to the Pharaohs and all the Egyptians. History records that Ahmose II (Gr. Amasis), another Egyptian leader, strangled Hophra and took his place.⁴³²
- 29:6-7 When God did this the Egyptians would know that Yahweh is the only true God. He would also do this because Egypt had been unfaithful to follow through on its promises to help the Israelites. They had proved to be as weak a support as one of the reeds that grew along the banks of the Nile (cf. Exod. 2:3). People used a staff as a cane or walking stick for support when they walked on rough terrain (cf. Zech. 8:4; Mark 6:8; Heb. 11:21). But when the Judahites had relied on the Egyptians this ally had broken and had even injured God's people (cf. 2 Kings 18:21; Isa. 36:6; Jer. 37:7). As a crutch, Egypt was worse than useless. The Israelites, of course, should not have trusted in Egypt, but this did not excuse the Egyptians for breaking their covenants with Israel.
- 29:8-9a As punishment, Yahweh would bring war into Egypt that would slay man and beast. Egypt would become desolate and waste, and people would learn that the Lord is God.
- 29:9b-10 The Lord repeated that He would devastate Egypt for her pride and self-sufficiency. The whole land would suffer destruction, from Migdol, in the northeast delta, to Syene, in the south near modern Aswan, and to the very border of Ethiopia, at the extreme southern end of the land.⁴³³ Ancient Ethiopia (Cush, Nubia) corresponds to modern southern Egypt, Sudan, Eritrea, and northern Ethiopia.
- 29:11-12 Egypt would not be inhabited for 40 years, and other desolated lands would surround her. Her cities would lie waste, and her people would disperse among other nations and live in other countries. Egypt's fate was like a repetition of Israel's in the wilderness (cf. 4:6). Egypt did indeed fall to the Babylonians in 568-567 B.C.

⁴³¹Herodotus, 2:70.

⁴³²Feinberg, p. 169.

⁴³³See the maps at the end of these notes.

- 29:13-14 At the end of 40 years, the Lord promised to gather the Egyptians back to their original land, the land of Pathros, Upper (southern) Egypt, from the countries where they had fled (cf. Isa. 11:11). There the Egyptians would become a lowly kingdom in contrast to the great kingdom that they had been in former centuries (cf. Dan. 11:36-45). Forty years after Egypt fell to the Babylonians, the Persians, who had by that time defeated the Babylonians, allowed the Egyptians to return to their homeland. This was the foreign policy of the Persians under which the Israelites were also able to return to their land. No extrabiblical evidence has yet come to light to substantiate this forty-year captivity of Egypt, but that is not unusual since it was rare for ancient Near Eastern rulers to admit defeats much less document them for future generations. Chisholm suggested that the prophecy may not have been fulfilled as prophesied here because the Egyptians repented.⁴³⁴ We have no evidence of such repentance, but it could have happened.
- 29:15-16 Egypt would be the lowest of the kingdoms and would never again be a superpower in the world. The Egyptians would not even rule over other nations. Egypt would then be no temptation for Israel to rely on. Her lowly state would remind the Israelites of their folly in trusting in Egypt earlier. Then all would know that the Lord is God.

2. The consummation of Egypt's judgment 29:17-21

- 29:17 Ezekiel received another message from the Lord about Egypt's judgment on April 26, 571 B.C. (on his New Year's day).⁴³⁵ This was probably the second to the last recorded prophecy of Ezekiel, and the prophet would have been about 50 years old at this time (cf. 1:1-2). The writer evidently inserted this oracle in the text here to group it with the other prophecies against Egypt. Its placement here informs the reader that the destruction of Egypt foretold in the first message would come through Nebuchadnezzar. This enables us to understand better the remaining oracles against Egypt.
- 29:18 The Lord revealed to Ezekiel that Nebuchadnezzar, as Yahweh's instrument of judgment, had worked hard at defeating Tyre. "Every head was made bald, and every shoulder was rubbed bare" describes the chafing of helmets and the carrying of burdens for the siege-works. The siege of Tyre took 13 years (ca. 586-573 B.C.). However, Nebuchadnezzar received little compensation for his labor; the spoil he took was hardly worth all the time and effort he expended.

"In ancient times armies were not paid as they are today. Soldiers might receive a small allowance along with their rations, but it would have been foolish to join an army just for the pittance paid as wage. Instead, a special incentive

⁴³⁴Chisholm, *Handbook on . . .*, pp. 272-73.

⁴³⁵Parker and Dubberstein, p. 28.

system made army life attractive and often exciting. Soldiers successful in battle were allowed to take and keep anything they could lay hands on and carry away. Many battles took place at or near large cities or in prosperous lands where wealth was concentrated. Indeed, ancient wars of conquest were launched precisely so that the conquerors could acquire the wealth of other nations. After defeating an enemy, an army would dig into the spoils. Those fortunate enough to find gems, precious metals, or other great valuables among the possessions of their defeated foes might become instantly rich. Almost all could at least supplement their income handsomely."⁴³⁶

29:19-20 Yahweh announced that He would give Egypt to Nebuchadnezzar as payment for executing His judgment against Tyre. Nebuchadnezzar would carry off the wealth of Egypt as spoil and plunder because he had labored for the Lord by defeating Tyre.

"The scant historical data indicates that Egypt and Tyre became allies under Pharaoh Hophra (Apries). The extended siege of Tyre was perhaps due to the aid Tyre received from the Egyptians. In such an act Hophra was going contrary to God's purposes. Not only was the siege prolonged by Egyptian support, but some also surmise that Egypt's maritime aid enabled Tyre to send away her wealth for security during the siege. When Tyre surrendered about 573 B.C. . . ., Babylonia gained almost no spoils from the long siege (v. 18)."⁴³⁷

The absolutely consistent justice of God shines through in this prediction. He would even pay back an evil pagan king for serving Him, unconscious as Nebuchadnezzar was of his role. How much more can we count on God being fair with His own (cf. Gen. 18:25; Mark 9:41; Gal. 6:7).

29:21 When Nebuchadnezzar defeated Egypt, the defeat would provide hope for Israel because Egypt was Israel's ancient enemy. Evidently Nebuchadnezzar invaded and defeated Egypt about 568-567 B.C.⁴³⁸ It would be as though a horn began to grow on Israel, the sign of new strength to come (cf. 1 Sam. 2:1; 1 Kings 22:11; Ps. 92:10; Jer. 48:25). A horn is also a symbol of Messiah in some passages, and a branch is a symbol in others (cf. Ps. 132:17; Isa. 4:2; Jer. 23:5; Zech. 3:8; Luke 1:69), but the context argues against a messianic interpretation here. Furthermore, no Messiah or any other notable ruler appeared in Israel at

⁴³⁶Stuart, pp. 283-84.

⁴³⁷Alexander, "Ezekiel," p. 893.

⁴³⁸See Josephus, *Antiquities* . . . ,10:9:7.

this time. Some commentators, nevertheless, see a messianic reference here.⁴³⁹

The Lord also promised to open Ezekiel's mouth then in the midst of the exiles. Formerly the Lord had restrained the prophet from speaking (3:26), but he long since (since 585 B.C.) had resumed speaking (cf. 33:21-22). The Israelites would be more open to messages from the Lord and more able to assert themselves because their old nemesis had suffered humiliation.

All these events would teach people Yahweh's unique deity. This is one of the main lessons of the book. The promise occurs in the two oracles in this chapter three times (vv. 6, 9, 16) and in the book more than 40 times.

3. The destruction of Egypt and her allies 30:1-19

Of the seven oracles against Egypt, this is the only one that is undated. Most of the commentators assumed that Ezekiel gave it in 587 B.C., the same year as the first, second, and third oracles. But he could have given it in 571 B.C. after his sixth oracle (29:17-21). I think he gave it in 571 B.C. and that the writer placed it here in the text, after the other late oracle, because both of them contain specific references to Nebuchadnezzar. Knowledge that Nebuchadnezzar would be God's instrument in judging Egypt is helpful in interpreting the remaining oracles against Egypt. If this chronology is correct, this would have been the last prophecy that Ezekiel gave that this book records.

This oracle appears to be a mosaic of four separate messages. Note the recurrence of the introductory clause "thus says the Lord God" in verses 2, 6, 10, and 13.

30:1-3 Ezekiel was to wail and bemoan the fact that the day of the Lord was near. It would be a dark day for several nations since it would involve judgment for them. "The day of the Lord" is any day in which God acts in a dramatic way in history. The phrase "the day of the Lord" usually describes an eschatological day, but that is not its meaning here as is clear from what follows (v. 9; cf. 7:7, 10; Lam. 2:21-22). This judgment would come on Egypt soon.

30:4-5 An enemy would invade Egypt, slay many of her people, take away her wealth, and tear down her national foundations.⁴⁴⁰ Her neighbor Ethiopia (Cush, Nubia) would despair when this happened because Ethiopia had strong ties to Egypt. Egypt's other allies would also fall: Put (on the African coast of the southern Red Sea), Lud (Lydia in Anatolia), Arabia, and Libya (farther west on the Mediterranean coast of Africa). "Arabia" (Heb. *ha'arab*) translates one pointing of the Hebrew text while "mixed people" (Heb. *ha'ereb*) renders another. Men from Put, Lud, Arabia, and other countries served Egypt as mercenary soldiers (cf. 27:10; Jer. 25:19-20a, 24; 46:9, 21), and they may be the "mixed people" in view, if that is

⁴³⁹E.g., Cooper, pp. 275-76.

⁴⁴⁰See Josephus, 10:9:7.

the correct reading. The Judeans who had fled to Egypt from the Babylonians would have suffered too, and they would have been part of this "mixed people."

- 30:6 The Lord announced again (vv. 6-9) that the nations that supported Egypt would fall with her. Egypt would suffer humiliation from north to south (cf. 29:10) as the enemy slew many Egyptians.
- 30:7-8 The people and the cities of Egypt would become desolate. Then the Egyptians would know that the Lord is God when He destroyed the land as with a fire and rendered Egypt's allies ineffective when they tried to help her.
- 30:9 On this day of the Lord (v. 3), the day of Egypt's judgment, God would send soldiers against Egypt in ships, and they would frighten even the distant Ethiopians (cf. v. 4).
- "The terror and consternation of Egypt in that hour can only be likened to the time of Egypt's judgment when Israel was delivered from Egyptian servitude in the exodus (see Exodus 15:12-16)."⁴⁴¹
- 30:10-11 In a third message (vv. 10-13), the Lord said He would make the vast wealth of Egypt cease when He sent Nebuchadnezzar against her. Nebuchadnezzar would come with his allies and fight against the Egyptians and slay large numbers of them.
- 30:12 Yahweh would cause the canals of the Nile River to dry up as a result of the warfare. The irrigation canals in Egypt required constant attention and maintenance, but during war the Egyptians would not have time for that. Consequently Egypt would stop producing food. The Babylonians, strangers to Egypt, would take over Egypt and desolate it.
- 30:13 Finally (vv. 13-19), the Lord also promised to destroy the idols of Egypt, even from Noph (Gr. Memphis), the capital of Lower Egypt near modern Cairo. Some studies indicate that there were more than 1,200 gods in Egypt at one time.⁴⁴² There would no longer be a king over Egypt either; foreigners would rule over the land. Consequently the Egyptians would be very fearful. The Egyptians regarded their Pharaoh as the incarnation of a god.
- 30:14 Specifically, God would desolate Pathros (Upper Egypt, between modern Cairo and Aswan, cf. 29:14), He would burn up Zoan (Gr. Tanis), a chief city in the northeastern delta, and He would judge No (Gr. Thebes,

⁴⁴¹Feinberg, p. 174.

⁴⁴²E. A. W. Budge, *The Gods of the Egyptians*, pp. ix-x; and B. E. Shafer, ed., *Religion in Ancient Egypt: Gods, Myths, and Personal Practice*, pp. 7-87.

modern Karnak and Luxor), Egypt's southern capital. All the towns mentioned in these verses were important religious centers as well as large cities.

30:15-16 God would also judge the people living in Sin (Gr. Pelusium), one of the northernmost strongholds of Egypt, and He would allow the walls of No (Thebes) to be breached and its people slain. Noph (Memphis) would also experience daily distress during the war.

30:17-19 On or Aven (Gr. Heliopolis), a major religious center in Lower Egypt, and Pi-beseth (Gr. Bubastis), another capital city 40 miles northeast of modern Cairo, would also fall in the war, and the Egyptian women would go into captivity. It would also be a dark day for Tehaphnehes (Hanes, Gr. Daphne), a fortress town and residence of the Pharaohs (Isa. 30:4; Jer. 2:16; 43:7,9; 44:1), when Yahweh would break Egypt's power. Egypt's pride would cease, doom would overwhelm her, and her people would go into captivity. This is how the Lord would judge Egypt, and the people would know that He is the true God.

"Various forms of misery characteristic of the Day of the Lord are mentioned here as what the cities of Egypt may expect. All of them are intended to apply to all of Egypt, although the style of the passage is to pair miseries with cities randomly, in a kind of literary collage."⁴⁴³

4. Pharaoh's broken arm 30:20-26

30:20 Ezekiel received this oracle against Egypt on April, 29, 587 B.C., less than four months after the Lord gave him the first oracle (29:1-16).⁴⁴⁴

30:21 Yahweh announced that He had broken Pharaoh's arm. Ironically, "the strong-armed king had suffered a broken arm."⁴⁴⁵ It had not been set in a splint and supported, so he could not wield a sword effectively. This may refer to Egypt's defeat at Carchemish in 605 B.C. when Egypt lost its share of control over the ancient Near East (cf. 2 Kings 24:7; Jer. 46:2). Another possibility is that the defeat in view was Hophra's unsuccessful attack against the Babylonians near Judea a few months earlier (cf. 2 Kings 24:7; Jer. 37:5, 9; 44:30).

"Possibly the days between the first and fourth prophecies were approximately the length of time the siege on Jerusalem was lifted as Babylon repositioned its army to meet the Egyptian attack."⁴⁴⁶

⁴⁴³Stuart, p. 288.

⁴⁴⁴See Parker and Dubberstein, p. 28.

⁴⁴⁵K. S. Freedy and D. B. Redford, "The Dates of Ezekiel in Relation to Biblical, Babylonian and Egyptian Sources," *Journal of the American Oriental Society* 90 (1970):482-83.

⁴⁴⁶Dyer, "Ezekiel," p. 1289.

- 30:22-23 The Lord was about to break Pharaoh's other arm and to break his previously broken arm again, personifications of Egypt's fate. Egypt would suffer another defeat at the hands of the Babylonians and would never again regain its former strength. Yahweh would scatter the Egyptians from their homeland, and they would go to live in other countries.
- 30:24-26 The Lord described the conflict between Babylon and Egypt as a conflict between two warriors. Nebuchadnezzar would break Hophra's arms as they battled. Egypt would groan like a wounded soldier. The people would know that Yahweh was God when He put His sword of power into Nebuchadnezzar's arms and strengthened him to defeat Hophra and when the Egyptians dispersed from their land (cf. v. 17-18, 23; 29:12).

"The flexed arm was a common Egyptian symbol for the Pharaoh's strength. Often statues or images of the Pharaoh have this arm flexed, wielding a sword in battle. A king with great biceps was especially a popular concept under the Saites Dynasty of Ezekiel's day. In addition Hophra took a second formal title that meant 'possessed of a muscular arm' or 'strong-armed' . . ." ⁴⁴⁷

This oracle does not specify Nebuchadnezzar as the king of Babylon who would defeat Pharaoh. Evidently his identity was a later revelation that came in the oracles of 571 B.C. (29:17-21; 30:1-19). The point of this one is Yahweh's certain and complete destruction of Egypt's power.

5. Egypt's fall compared to Assyria's fall ch. 31

This chapter is a whole oracle composed of three sections.

"The argument the prophet presented was simple. Egypt boasted in its greatness, yet Egypt wasn't as great as Assyria, and Assyria was conquered by Babylon. Conclusion: if Babylon can conquer Assyria, Babylon can conquer Egypt." ⁴⁴⁸

A poem extolling Assyria's glory 31:1-9

- 31:1 The Lord gave Ezekiel a third oracle against Egypt on June 21, 587 B.C., less than two months after the previous one (30:20-26). ⁴⁴⁹
- 31:2 The prophet was to speak this one to Pharaoh Hophra and to the Egyptians. Obviously Ezekiel was in Babylon and they were in Egypt, but

⁴⁴⁷Alexander, "Ezekiel," p. 897. His quotation is from Freedy and Redford, pp. 482-83.

⁴⁴⁸Wiersbe, p. 220.

⁴⁴⁹Parker and Dubberstein, p. 28.

he was to speak publicly as though he were addressing them in person. He asked rhetorically who the Egyptians were like in their greatness.

31:3 They were similar to the Assyrians who had towered among the nations as a beautiful cedar of Lebanon (cf. 17:1-10, 22-24; 19:10-14; 26:19-21; 28:11-19; Isa. 14:3-21). Some of the Lebanese cedars grew 80 feet high, were beautifully symmetrical, and contained thickly interwoven branches.⁴⁵⁰

Assyria had been one of the greatest nations in history before its fall in 612 B.C., perhaps the greatest nation. It was of particular interest to the Egyptians for two reasons. It had been the only Mesopotamian nation to invade Egypt successfully. The Assyrians destroyed Thebes in 633 B.C. (cf. Nah. 3:8-10) and eventually incorporated Egypt into its empire. Second, Assyria had fallen to the Babylonians, the same enemy that now threatened Egypt. The city of Nineveh fell to Nabopolassar, Nebuchadnezzar's father, in 612 B.C., and Nebuchadnezzar crushed the rest of the Assyrian army at Haran in 609 B.C.

31:4-5 Like Egypt, Assyria received much of its strength and power from the waters that surrounded it, the Nile in Egypt's case and the Tigris in Assyria's. The waters that nourished these nations enabled them to grow strong and to tower above many others. The network of supporting nations that surrounded both Assyria and Egypt contributed to their strength and growth in another way.

31:6 Many peoples and nations benefited from the mighty kingdom of Assyria symbolized by the birds and beasts that took refuge under this tree (cf. vv. 12, 13; 17:23; Dan. 4:12; Matt. 13:32).

31:7-9 Assyria was beautiful and graceful because of the waters that sustained it, waters that were solely a gift of God's grace. No tree in God's garden of nations could compare with it. The other kingdoms were jealous of Assyria, which was preeminent in God's Eden-like collection of nations.

The felling of Assyria 31:10-14

31:10-11 However, because Assyria was a proud nation, the Lord had determined to turn it over to a strong individual who would cut it down, namely, Nebuchadnezzar. God had driven it out of His Eden as He had driven Adam and Eve out for their pride.

31:12-13 Alien tyrants from other nations had cut off parts of Assyria and left it laying like a tree with its limbs chopped off in a valley. Assyria had a reputation for being an extremely cruel nation, and the other nations had dealt with it ruthlessly. The people of the earth who had taken refuge in

⁴⁵⁰Feinberg, p. 178. Allen, *Ezekiel 20—48*, p. 125, wrote an interesting paragraph on the motif of the cosmic tree in ancient mythology, which Ezekiel may have had in mind.

Assyria like birds and beasts under a tree had fled from under it but continued to use its remains to their own advantage.

- 31:14 This fate had befallen Assyria in part so other greatly blessed, proud nations would learn not to exalt themselves. All nations, like trees, eventually fall down and return to oblivion like human corpses do to the dust.

The end of Assyria and the application to Egypt 31:15-18

- 31:15 On the day that God humbled Assyria, He caused many people and nations to mourn her demise. He made it impossible for that nation to revive; He did the same thing as burying it in the sea, and He kept its life-giving waters from revitalizing it. The people in the area from which Assyria had come, Mesopotamia, mourned for it, and other nations (trees) wilted because of its fall.
- 31:16 The fall of Assyria created the same reaction among the nations as the felling of a mighty tree does in the forest; all the other nations (trees) quaked. The other nations also were able to grow better themselves since they no longer had to live in the shadow of mighty Assyria.
- 31:17 Some other nations fell when Assyria did; this great tree fell on other trees and took them down with it. Some of them had even sustained Assyria and profited from Assyria's greatness, but she fell on them.
- 31:18 For the Lord Ezekiel asked Pharaoh and the Egyptians which of the trees (nations) in God's garden they resembled. Egypt was obviously like Assyria in its greatness and pride and may have thought of itself as Assyria's equal. Nevertheless God would cut down Egypt as He had felled Assyria. The people would die among the uncircumcised, like barbarians (cf. 28:10; 29:5; 32:19, 21; Jer. 9:25-26). This was a terrible fate for people who regarded a proper burial as preparation for life beyond the grave, as the Egyptians did. The Egyptians practiced circumcision, but the Babylonians did not. They also despised foreigners. They would die by the sword in war. This would be the fate of Pharaoh and the Egyptians that Almighty God promised. If Assyria could not escape Yahweh's judgment, how could Egypt?

"The story of the cedar revisits several familiar themes that occurred in the prophecies against foreign nations. First, God hates pride because it leads people and nations to ruin (Ezek 27:3; 28:2; Prov 16:18). Second, the mighty fall as do the weak (cf. 27:27-36). When the mighty fall, it is also a loss for the weak and dependant [*sic* dependent]. Third, the fall of the tree was a reminder of the mortality of human beings and individual accountability to God (cf. 3:16-21; 18:1-21)."⁴⁵¹

⁴⁵¹Cooper, p. 284.

If the Jewish exiles still entertained any hope that Egypt would save them from captivity, this prophecy would have encouraged them to abandon such a dream.

6. A funeral dirge for Egypt 32:1-16

32:1 This is the first of two messages that Ezekiel received from the Lord concerning Egypt on March 3, 585 B.C.⁴⁵² Less than two months had passed since the exiles had learned of Jerusalem's fall, which had occurred several months earlier (33:21). The Egyptians had also doubtless heard of Jerusalem's destruction. This oracle assured both the Jewish exiles in Babylon and the Egyptians, including the Jewish exiles there, that God would bring Egypt down. Jerusalem's destruction was to be no source of comfort for the Egyptians.

32:2 Ezekiel was to utter a lamentation over Pharaoh. In the other oracles of judgment against foreign nations recorded in this book, lament typically follows announcement (cf. ch. 19; 26:17-8; 27; 28:12-19). The same is true with the oracles against Egypt. The writer's desire to preserve this pattern is probably another reason he recorded the oracles of judgment in 29:17-21 and 30:1-19 out of chronological order.

Hophra had compared himself to a young lion, but he was more like the mythical sea-monster. The Egyptian sphinx has the body of a lion and the head of a Pharaoh. Again, the monster in view seems to be a crocodile (cf. 29:3). He had burst forth from the Nile and its estuaries muddying and fouling their waters. This symbolizes Pharaoh's disturbing influence on the international scene as he complicated God's dealings with other nations, especially Judah and Babylon.

32:3 The Lord announced that He would cast His net over Pharaoh using a large group of people as His instruments. In the Babylonian account of Creation, the *Enuma elish* (4:95), the god Marduk captured the chaos-monster Tiamat in a net and slew him.⁴⁵³ God may have wanted the Jewish exiles in Babylon to see a parallel between what Ezekiel predicted and what the Babylonians believed. Fulfillment would demonstrate Yahweh's sovereignty. The Babylonians would take Pharaoh captive, and the Egyptians would go into captivity. Since the Egyptians regarded the Pharaoh, the crocodile, and the Nile as manifestations of their gods, this announcement meant that Yahweh would humble Egypt's gods as well as bring her defeat.

32:4-6 Yahweh would set Pharaoh down in an open field and leave him on dry land, out of his element. Birds and beasts would then devour him (cf. 29:5; Matt. 24:28; Rev. 19:17-18). These animals of prey would carry his flesh

⁴⁵²Parker and Dubberstein, p. 28.

⁴⁵³See Thomas, ed., p. 9.

and blood to distant mountains (cf. Exod. 7:19; Rev. 8:8) and fill the valleys and ravines with pieces of his carcass. This is a picture of the dispersion of the Egyptians from their land.

32:7-8 At the time God did this, He would darken the skies over Egypt so the light of the sun, moon, and stars would not shine on the land (cf. Joel 2:10, 31; Rev. 8:12-13). This announcement recalls the plague of darkness that the Lord sent before the Exodus (Exod. 10:21-23). He would again humiliate the gods that the Egyptians credited with bringing light and providing life.

"The overthrow of Egypt was a prelude [or foreview], as it were, to the destruction of world rule in the last days."⁴⁵⁴

32:9-10 Many on-looking peoples would be upset when they observed the destruction and dispersion of the Egyptians (cf. 26:16; 27:35). The kings of other nations would tremble for their own safety when they saw what God would do to Egypt.

32:11-12 The Lord promised to send the military power of Babylon against Egypt. The swords of these rapacious invaders would destroy the multitude of Egyptians and devastate their land.

32:13-14 The enemy would also slay the Egyptians' cattle. The Egyptians regarded many forms of cattle as manifestations of their gods. Finally the waters of Egypt would be undisturbed (cf. v. 2); there would be no people or animals left in the land to muddy them. The waters would settle and would flow as smoothly as oil. Some interpreters have taken this as a reference to the messianic age, but it probably does not look that far into the future.

"In biblical and Jewish tradition the motif of streams running with oil usually speaks of paradisiacal peace and prosperity."⁴⁵⁵

32:15-16 When the Lord brought this devastation on the land and the people, they would know that He is God. He would again humble the gods of Egypt and demonstrate His sovereignty as He had done in the Exodus. Furthermore people of other nations would chant this lamentation when God punished Egypt, as hired wailing women did at funerals (cf. Jer. 9:17-20).

This oracle looks back and recalls aspects of the Exodus, God's former judgment of Egypt, and reveals that God would judge her again similarly.

⁴⁵⁴Feinberg, p. 183.

⁴⁵⁵Block, *The Book . . .* 48, p. 209. Cf. Gen. 27:28; Job 29:6; 2 Enoch 8:5.

"If Egypt is a mighty dragon, one might say, Yahweh is cast in the role of St. George!"⁴⁵⁶

This oracle also looks forward and anticipates a still future day of the Lord when God will humble all proud enemies of His people (cf. Joel 2:30-31; 3:15; Amos 8:9).

7. A summary lament over Egypt 32:17-32

The last of the seven oracles against Egypt fittingly pictures the nation in its final resting place, the grave or Sheol, surrounded by other dead nations that had preceded it in judgment.

"The language is highly poetical and the details must not be taken too literally. This is not the chapter to turn to if one wishes to understand the Bible's teaching about the after-life. It does, however, illustrate something of the concept of death which was common to Near Eastern thought and from which the Old Testament was constantly striving to break free."⁴⁵⁷

- 32:17 Apparently Ezekiel delivered this oracle two weeks after the previous one, on March 18, 585 B.C.⁴⁵⁸ The meter of this mourning song is two plus two rather than the three plus two meter of the more common funeral dirge (the *qinah* meter). Thus while this lament is similar to the one in the preceding oracle (32:1-16), it is not exactly the same. Wevers called this the only example of a mourning song in the Old Testament.⁴⁵⁹ The distinction between the two types of lament is not great, however.
- 32:18-19 Ezekiel was to wail for Egypt and the other peoples that would fall with her as people mourned when someone died. We can visualize these words being cried as people stood around an open grave. Even though Egypt had been unsurpassed in her beauty as a nation, she would lie in the grave with the most ordinary and barbarian dead nations. God would not favor Egypt over the uncircumcised peoples that she proudly disdained.
- 32:20-21 Egypt would die as a victim of war, and her people would be scattered from their land. Nations already dead would speak of the demise of Egypt as the death of an uncircumcised (barbarian) people, namely, as a nation like their own.
- 32:22-23 Assyria and her allies were already in the grave having perished in war. Even though the Assyrians had struck terror into the hearts of other peoples in their day, they now lay in the grave while others viewed them and marveled.

⁴⁵⁶Allen, *Ezekiel 20—48*, p. 132.

⁴⁵⁷Taylor, p. 210.

⁴⁵⁸Parker and Dubberstein, p. 28.

⁴⁵⁹Wevers, p. 244.

- 32:24-25 The Elamites, another formerly mighty people who lived east of Babylonia, were also in the grave having died in warfare (cf. Jer. 49:34-38). The people from this region later became a significant part of the Persian Empire, but the Elamite kingdom of former years is in view here. Ashurbanipal the Assyrian had destroyed Elam about 645 B.C. Both the Assyrians and the Elamites did not practice circumcision, and now the Egyptians, a circumcised people, would join them in the same grave. The end of Egypt would be no different or better even though they considered themselves superior to the uncircumcised nations of the world (cf. Gal. 5:6).
- 32:26-28 The nations of Meshech and Tubal in eastern Anatolia (modern western Turkey, cf. 27:13) along with their neighbors, other uncircumcised peoples, had also perished in war and were now dead powers. They had produced terrifying warriors, like the Nephilim, the ancient legendary warriors of Genesis 6:4, but they were not able to escape their fate, and Egypt would join them. It was customary in some countries to bury honored warriors with their swords and other weapons of war (v. 27; cf. 1 Macc. 13:29).
- 32:29-30 Edom is another example of a strong nation that had perished and joined the mass of humanity in the grave. Likewise the rulers of the North and the Sidonians, once terror-inspiring, were now dead. They too now shared their grave with the uncircumcised and their disgrace with other defeated and defunct peoples. The rulers of the North may be an allusion to the Phoenician coastal towns including Tyre.⁴⁶⁰ Or they may have been invaders who lived farther north, between the Black and Caspian seas.⁴⁶¹
- 32:31-32 When Pharaoh died, he would see that his was not the only nation to suffer the fate that the Lord announced, and this would be of some comfort to him. Even though the Lord terrified him with the Babylonians while he was alive, he and his people would find some rest in death because they would lie with other peoples who had experienced a similar end.

The Egyptians took pride in their preparations for death and their burial customs thinking that these assured them safe passage to the nether world and rest there. But Ezekiel said they would die just like other proud, oppressive peoples, and their rest would be the common rest that all the dead enjoy, circumcised and uncircumcised alike.

"Ezekiel refused to be mesmerized by the spectacle of Egypt's military power or captivated by Judean dreams of the political renewal that might be served thereby. History's theatrical wardrobe was cluttered with the national

⁴⁶⁰Taylor, p. 212; Enns, p. 145; Dyer, "Ezekiel," p. 1292.

⁴⁶¹See Herodotus, 1:106; 3:94.

costumes of those who had strutted across its stage for a while, until the curtain fell on their particular scene. They lived on only in popular infamy—or, in terms of contemporary beliefs about the underworld, in the deeper regions of Sheol. Such would be Egypt's fate, instead of a Valhalla of chivalrous warriors who rested in peace and honor."⁴⁶²

"In contemplating the relevance of Ezekiel's vision of the netherworld for Christian doctrine, the reader must keep in mind that the primary aim of this oracle is not doctrinal but rhetorical—to inspire hope in the hearts of his fellow exiles by announcing the eventual demise of their prideful foreign enemies. The caricatured and contrary-to-fact features of this prophecy suggest that one should interpret the passage as a literary cartoon rather than a literary photograph."⁴⁶³

"The oracles against the nations in Ezek 25—32 were originally delivered to the people of Judah. Although the words written seem to be solely for those particular nations, they are foremost for the people of Judah in Jerusalem and Babylon and serve at least three purposes. First, the oracles in Ezek 25—32 reveal God's judgment against the nations that either mocked or aided in Jerusalem's fall [cf. Gen. 12:3]. Second, as with both the king of Tyre and the Pharaoh of Egypt, God would throw them down from their self-elevated positions of power—there is no room for such arrogance and pride in God's creation. Third, the oracles are essentially a dismantling of the gods of the nations, which is in turn a dismantling of the gods Judah had begun to rely wrongly upon, and the proclamation that Yahweh is the one and only true God for all nations. . . . the phrase 'know I am the LORD' occurs nineteen times. The primary purpose of these oracles is that everyone should come to 'know the LORD.'"⁴⁶⁴

IV. FUTURE BLESSINGS FOR ISRAEL CHS. 33—48

"This last major division of the book focuses on the restoration of Israel's blessing. Israel would be judged for her sin (chaps. 1—24), as would the surrounding nations (chaps. 25—32). But Israel will not remain under judgment forever. God had set her apart as His special people, and He will fulfill His promises to her."⁴⁶⁵

"Chapters 33—39 comprise words of restoration and hope, and chaps. 40—48 present details of the restored community."⁴⁶⁶

⁴⁶²Allen, *Ezekiel 20—48*, p. 138.

⁴⁶³Block, *The Book . . . 48*, p. 234.

⁴⁶⁴Cooper, p. 289.

⁴⁶⁵Dyer, "Ezekiel," p. 1293.

⁴⁶⁶Cooper, p. 292.

This whole section emphasizes return to the Promised Land.

"Some students prefer to interpret Ezekiel 33—48 idealistically or symbolically, applying these descriptions 'spiritually' to the church today rather than literally to Israel in the future. But if we've been interpreting Ezekiel's prophetic word literally up to this point, what right do we have to change our approach and start interpreting his words symbolically? . . . We must face the fact that both approaches—the symbolical and the literal—present problems to the interpreter, but taking Ezekiel's prophecies at face value seems to present fewer problems. Furthermore, seeing literal fulfillment of these prophecies accomplishes the purpose for which God gave them, the encouragement of the people of Israel."⁴⁶⁷

A. A WARNING TO THE EXILES 33:1-20

Since this message is undated, it may have come to Ezekiel about the same time as the previous two in chapter 32, namely, in the last month of 585 B.C. If so, Ezekiel received it about two months after God gave him the six messages recorded in 33:21—39:29 (cf. 33:21). Perhaps the writer inserted the present message in the text here because its strong encouragement to repent was more typical of Ezekiel's emphasis before news of Jerusalem's fall reached the exiles (v. 21) than it was of his emphasis after they received that news. When the exiles learned that Jerusalem had fallen, Ezekiel's messages changed. Before then he announced judgment on Judah and Jerusalem (chs. 4—24) and proclaimed several messages of judgment on the nations that opposed Israel (chs. 25—32). After that event his messages were more encouragements that God would restore Israel to her land (chs. 33—48).

There are only two dated prophecies after the fall of Jerusalem: 33:21 and 40:1. These texts introduce all the messages from 33:21—48:35, the end of the book. The message in 33:23-33 is an exception; it is a strong call to the Israelites to repent and to recommit to obeying the Mosaic Law. Alexander considered the message in 33:1-20 as the conclusion to the section of oracles against the nations (chs. 25—32).⁴⁶⁸ Most commentators viewed this message as an introduction to the messages promising future blessings for Israel (chs. 33—48). Obviously it serves a transitional (janus) function in the book and looks both ways, backward and forward.

1. An exhortation to heed the watchman 33:1-9

This part of Ezekiel's message of warning to the exiles is similar to 3:16-21. Yahweh re-commissioned Ezekiel to his prophetic task (cf. chs. 2—3).

"Now that Ezekiel's original ministry of judgment was completed, God appointed him as a 'watchman' for a second time. His message still stressed individual accountability and responsibility, but the focus was now on the Lord's restoration of Israel."⁴⁶⁹

⁴⁶⁷Wiersbe, p. 222.

⁴⁶⁸Alexander, "Ezekiel," p. 904.

⁴⁶⁹Dyer, in *The Old . . .*, p. 688.

33:1-4 The Lord told Ezekiel to speak to the Jewish exiles in Babylon. He had not spoken messages concerning them for about three years (588-585 B.C.), since the Lord had shut his mouth (24:25-27), though he had uttered five oracles against the nations during that time (29:1-16; 30:20—32:32). He was now to tell them that if the Lord brought war on a land and the people of that land appointed a watchman for them, they would be responsible if they did not heed his warning.

Watchmen stood on the towers of walls in ancient cities and scanned the horizon for approaching enemies. If they saw one coming, they would blow their trumpet, usually a shophar (ram's horn), to warn the people who were farming the lands to take refuge in the city. The figure of blood being on one's head comes from sacrificial practice. The offerer placed his hands on the head of the victim symbolizing the transfer of guilt from the offerer to his substitute.

33:5-6 The citizen would be responsible for his own death if he failed to heed the warning of the watchman. If he responded to the warning, he could save his life. But if the watchman failed to warn the people, he would be responsible for their deaths.

33:7-9 God reminded Ezekiel that He had appointed him a watchman for the Israelites (cf. 3:17-21; Isa. 21:6-9; Jer. 6:17). He was responsible to deliver the Lord's messages to His people. If Ezekiel failed to warn the people that they would die for their sins, God would hold him responsible for their deaths (cf. Gen. 4:9; 9:5). But if Ezekiel warned the sinners of the consequences of their iniquity and they disregarded his warning, they would die, but God would hold them, not Ezekiel, responsible (cf. Acts 20:26). Ezekiel had carried out his commission faithfully. Chapters 4—24 of this book contain the warnings that he delivered concerning the judgment that God intended to send on Judah and Jerusalem for the people's sins.

"Warning others of the consequences of judgment inherent in sin is never a popular assignment. Believers have a duty to be 'watchmen' who warn those who are in the world and are without God of the destructive nature of sin and its final irrevocable result—death and hell (33:1-33). Our responsibility is to warn and proclaim as persuasively as possible, but how the message is received is beyond our control."⁴⁷⁰

2. An exhortation to turn from evil 33:10-20

This part of Ezekiel's warning to the exiles is similar to 18:21-32.

⁴⁷⁰Cooper, p. 294. Cf. 2 Cor. 5:20; 1 Tim. 5:22; 1 Pet. 4:17—5:2.

- 33:10-11 The Israelites seem to have taken on more personal responsibility for their sufferings than they had earlier (cf. ch. 18). They wondered how they could survive God's judgments. This is the first indication in the book that they were conscious of their own sins. The Lord affirmed again that He took no pleasure in putting people to death for their sins (cf. 18:23, 32). He much preferred for them to turn from their sin and live (cf. 2 Pet. 3:9). He also appealed again to the people to do just that: to repent of their wicked ways and live (cf. 18:30-31).⁴⁷¹
- "We must correctly distinguish regret, remorse, and true repentance. Regret is an activity of the mind; whenever we remember what we've done, we ask ourselves, 'Why did I do that?' Remorse includes both the heart and the mind, and we feel disgust and pain, but we don't change our ways. But true repentance includes the mind, the heart, and the will. We change our mind about our sins and agree with what God says about them; we abhor ourselves because of what we have done; and we deliberately turn from our sin and turn to the Lord for His mercy.
- "When Peter remembered his sin of denying Christ, he repented and sought pardon; when Judas remembered his sin of betraying Christ, he experienced only remorse, and he went out and hanged himself."⁴⁷²
- 33:12-13 The right conduct of a usually righteous person would not exempt him from judgment if he sinned. Neither would the sinful conduct of a usually sinful person exempt him from forgiveness if he repented. The usually righteous person should not take God's promise of life for righteous living as a guarantee that he was exempt from punishment if he sinned. As in chapter 18, the issue here is not earning eternal salvation or losing it by the way one lives. It is rather the consequences of individual behavior in this life, which the Mosaic Law promised.
- 33:14-16 God's warnings that the wicked would die because of their sinfulness also needed to be understood properly. They would die only if they failed to repent. If the wicked turned from his sins and obeyed the Mosaic Law, he would not die (prematurely). God would not hold his former sins against him. He would receive his life as a reward for his righteous conduct.
- 33:17 The Jews were saying that the Lord was not dealing with them justly, but it was really their conduct and their thinking that were not right.
- 33:18-19 If a normally righteous person abandoned his righteous lifestyle and pursued sin, he would die for it. But if a normally sinful person abandoned his sinful lifestyle and did what was right, he would live for it.

⁴⁷¹For Calvin's explanation of this verse, see 3:24:15.

⁴⁷²Wiersbe, p. 223.

33:20 The people persisted in claiming that the Lord's ways of dealing with them were not just. Yet Yahweh assured them that He would deal with each of them fairly, according to their own individual behavior. God does not blame one person for another person's sins.

In our day many people refuse to take personal responsibility for their lives and chose rather to blame someone else for the way they live (e.g. a parent, employer, teacher, abuser, the devil, God). We may not be responsible for the actions of others that have resulted in our present condition, but we are responsible for how we conduct ourselves in our present condition.

This message repeats God's appointment of Ezekiel as a watchman over Israel (ch. 3) and His assurance of personal responsibility (chs. 3 and 18). Evidently the exiles had difficulty accepting this revelation. They tended to view Ezekiel as an entertainer (vv. 30-32) and God as unfair.

B. RESTORATION TO THE PROMISED LAND 33:21—39:29

"The concept of the land is particularly significant to the six messages [33:21—39:29] delivered in that one night before the news of Jerusalem's fall reached the exiles in Babylonia [cf. 33:21-22]. Since Jerusalem had fallen, would the land be lost to Israel (33:21-33)? It was the false 'shepherds' of Israel who had lost the land for Israel by leading the people astray from the truth. But the true 'shepherd,' the Messiah, would ultimately restore the land to Israel (ch. 34). Those foreigners who had possessed the land of Israel and had oppressed her people would be judged and removed so that Israel might again possess her own land (35:1—36:15). Then God would restore Israel to her promised land (36:16—37:14) and reunite the nation in fulfillment of God's covenants with her (37:15-28). Never again would a foreign power have dominion over Israel in her land (chs. 38—39)."⁴⁷³

1. Israel and the Promised Land 33:21-33

Ezekiel next recorded six messages about Israel's restoration to the Promised Land.

The date and setting of these messages 33:21-22

Ezekiel's last prophecy about the judgment coming on Judah and Jerusalem ended with an announcement that a fugitive would escape Jerusalem's destruction and come and report the city's fall to the exiles (24:25-26). At that time God would open Ezekiel's mouth and he would be dumb no longer (24:27). Now the messenger arrived and God opened the prophet's mouth.

⁴⁷³Alexander, "Ezekiel," p. 909.

- 33:21 On the fifth day of the tenth month of the twelfth year of the Jews' exile, namely, on January 19, 585 B.C., word reached the exiles from refugees who had come from Jerusalem.⁴⁷⁴ They announced that Jerusalem had fallen to Nebuchadnezzar. The siege of Jerusalem began on the tenth month, the tenth day, and the ninth year of King Zedekiah's reign (2 Kings 25:1; 588 B.C.). The city fell on the fourth month, the ninth day, and the eleventh year of Zedekiah's reign (2 Kings 25:2-7; 586 B.C.). Thus the siege lasted 18 months. The news of Jerusalem's fall reached the exiles in Babylon about five months after the city fell in 586 B.C. According to one method of reckoning, it took 18 months for news of Jerusalem's fall to reach the exiles, but it seems more probable that it took about five months, which was apparently the normal time it took to make this trip (cf. Ezra 7:6-9).⁴⁷⁵
- 33:22 The Lord had spoken to Ezekiel the evening before the refugees arrived and gave him permission to speak to the people when they heard the announcement of Jerusalem's fall. This broke the silence that God had imposed on him (cf. 3:26-27; 24:27).

"He was now able to converse with people and have a 'pastoral' ministry among them apart from his prophetic preaching. For about seven and a half years, Ezekiel had been under this constraint, but now he was free to speak."⁴⁷⁶

The first message of hope 33:23-33

This first message dealt with a serious defect in the Israelites. The Jews still in Judea were not listening to the whole counsel of God but were picking and choosing what they would obey (vv. 23-29). The Jews in exile were listening to Ezekiel, but they were not responding (vv. 30-33). If they were to profit from the messages of hope that Ezekiel proceeded to give them, all the Jews needed to respond to those he had already delivered by repenting. Thus this first message in this series prepared them for those that followed. The first step on the road to hope was a change in their attitude toward God's word.

The attitude of the Jews in Judea 33:23-29

- 33:23-24 The Lord informed the prophet about the attitude of the Jews still in the land. The few Jews who still lived in the waste places of the Promised Land were claiming that since God had promised that land to Abraham they were right in staying in it (cf. 11:15; Matt. 3:9; Luke 3:8; John 8:33, 39). But Jeremiah had told the Jews in the land to submit to the Babylonians (Jer. 40—44).

⁴⁷⁴Parker and Dubberstein, p. 28.

⁴⁷⁵See the commentators for a more detailed study of the problem.

⁴⁷⁶Wiersbe, p. 224.

"The lack of spiritual sensitivity and the smug self-interest evident in the quotation contrast with Abraham's total dependence on God."⁴⁷⁷

- 33:25-26 Ezekiel was to address the refugees who had brought the message of Jerusalem's fall and the other Israelites in the name of their sovereign Lord. Since the Jews did not keep the Mosaic Law (cf. Exod. 20:4-5, 13-14; Lev. 17:10-14; 19:26), did they have a right to possess the land? God had promised the land to Abraham's descendants, but He had also told them that they could only occupy their land if they obeyed the Law that He had given them (cf. Deut. 27—28; 29:25-29).
- 33:27 The Lord assured the people that the Jews who remained in the land would die there by various means including the sword, beasts, and disease (cf. Lev. 26:22, 25).
- 33:28-29 God promised to desolate the land completely and to humble the pride of His people (cf. Lev. 26:19, 33). Even the mountains would be desolate, and travelers would not even pass through the land. Then they would know that He is God, when He desolated their land.

The attitude of the Jews in Babylon 33:30-33

- 33:30-31 God also told Ezekiel that the exiles were speaking to one another about him privately and publicly. They were saying, Let's go and hear what Yahweh has to say to us through Ezekiel. So they came and sat before the prophet and listened to what he said, but their heart remained bent on pursuing their lustful desires and personal gain.
- 33:32-33 They listened to Ezekiel as they listened to entertainers, singers or instrumentalists. Entertainers expect no response to their performances beyond applause, but preachers expect people to change. The exiles admired Ezekiel for his content and delivery, but they did not put into practice what he told them to do (cf. James 1:22-25). They did not apply it to their own lives and change. Consequently, when what Ezekiel promised came, namely, judgment for personal responsibility (vv. 12-20), they would know that a prophet, a spokesman for God, had been in their midst, not just an entertainer.

This is one of the most pointed indictments of God's people in the Bible. When we are fairly comfortable it is easy to listen to preaching and to critique the preacher but do nothing in response to what he has said. It is essential that we ask ourselves, What does God want me to *do* in view of what I have just heard? And then do it!

⁴⁷⁷Block, *The Book . . .* 48, p. 260.

2. False and true shepherds ch. 34

Previously the Lord had said that the Israelites would not occupy the Promised Land because they had disobeyed the Mosaic Covenant. This disobedience was clear from the behavior of the people still in the land (33:25-26) and the Jews in exile (33:31-32). In this message He laid the burden of responsibility for the Israelites' failure at the feet of their leaders (cf. 13:1—14:11; 22).

The accusation against Israel's unfaithful rulers 34:1-6

34:1-2 The Lord gave Ezekiel a message for the shepherds (leaders, rulers, cf. Ps. 23) of Israel. Ancient Near Easterners often referred to kings and leaders as "shepherds" (e.g. Num. 27:17; 2 Sam. 5:2; 1 Kings 22:17; Isa. 44:28; Jer. 3:15; 10:21; 23:1-6; 25:34-38; Mic. 5:4-5; Zech. 11:4-17). Prophets and priests were also called "shepherds," but here kings are also in view. God pronounced judgment on them for three reasons. First, they fed themselves rather than the people; they were selfish. They were more interested in providing for themselves than for the people whom God had placed in their care (cf. John 10:11-13; 21:15-17). They exploited their followers.

A review of the history of the Northern Kingdom of Israel's rulers reveals a consistent string of corrupt leaders, and Ezekiel pointed out earlier that Judah was worse than her sister Israel (ch. 23).

34:3-4 Specifically, these unfaithful shepherds ate the best parts of the sacrifices rather than offering them to God (cf. 1 Sam. 2:12-17). They used the wool of sheep to make clothing for themselves rather than offering these animals as sacrifices to God.

Second, rather than feeding God's sheep they slaughtered them; they were oppressive. They had not restored those that needed restoring nor sought those that had wandered away and needed finding. They had dominated God's flock rather than providing loving, self-sacrificial leadership. The primary responsibility of a leader is to care for the needs of those he leads, even if this requires sacrificing his own desires.

34:5-6 Third, the rulers allowed the people to scatter over the earth instead of keeping them safely together; they were negligent. The Israelites scattered because they lacked leadership and became prey for the enemies of God's flock. They wandered everywhere, but there was no one to seek them out (cf. Matt. 9:36; John 10:12-13).

The verdict concerning the leadership of Israel 34:7-10

The Lord repeated His accusation against Israel's leaders (vv. 7-8) and then announced what He planned to do about the situation (vv. 9-31).

- 34:7-8 These false shepherds needed to listen to God's word to them because they had let the Israelites become prey for their enemies, and rather than seeking the lost they had fed themselves.
- 34:9-10 The Lord swore to oppose these shepherds, to hold them accountable for His sheep, to stop them from leading them further, and to rescue His sheep from their influence (cf. Matt. 20:25-28).

The Lord's intervention for Israel 34:11-24

"If any passage was at the heart of Ezekiel's contribution to the ongoing promise [to Israel], it was Ezekiel 34:11-31 . . ." ⁴⁷⁸

- 34:11-12 The Lord further promised to search for His wandering sheep Himself, to care for them, and to deliver them from the places where they had scattered in the gloomy days of their national distress (cf. Jer. 30:17-22; Luke 15:4-7). There are several references to God as Israel's Shepherd in the Old Testament (e.g. v. 6; Gen. 49:24; Ps. 23:1; 80:1; Isa. 40:11; Jer. 31:10; cf. John 10:2-3, 14-16).

- 34:13-14 He would lead them out from among the peoples where they had gone and bring them back to their own land (cf. vv. 4-6). He would nourish them on the mountains, beside the streams, and in the best (inhabited) places of the land (cf. Ps. 23:1; John 4; 6:31-35). They would enjoy good pasture and would experience rest in good grazing ground, the richest pasture in the land.

"If the scattering were literal, and no one is foolhardy as to deny this, then the regathering must be equally so." ⁴⁷⁹

- 34:15-16 God Himself would feed His flock and lead the sheep to rest (cf. v. 3). He would seek the lost, return the scattered, heal the broken, and strengthen the sick (cf. vv. 4, 6; Isa. 61:1-2; Mic. 2:12; 4:6-8; Luke 4:16-21). He would also destroy the fat, strong shepherds who had failed Him by feeding these leaders judgment.
- 34:17-19 The Lord announced too that He would distinguish among the members of His flock, judging them individually (cf. Matt. 25:31-46). Here the Lord viewed the exilic leaders as sheep among His sheep rather than as shepherds. They were, after all, also His sheep. Some of these leaders had not only eaten good pasture and drunk clear water but had made it impossible for the other sheep to eat good food and drink good water. The ordinary sheep had to get by with trampled grass and muddy water.

⁴⁷⁸Walter C. Kaiser Jr., *Toward an Old Testament Theology*, p. 240.

⁴⁷⁹Feinberg, p. 197.

- 34:20 God would judge between the fat and the lean sheep, between those who fed themselves and kept others from eating and those who had to exist on poor food and drink.
- 34:21-22 Because some of God's sheep suffered at the hands of their fellow sheep who pushed and shoved them around, the Lord would deliver even the weak, but He would distinguish the two types of His sheep. He would deliver His people from poor leaders as well as predatory nations.
- 34:23-24 The Lord promised to set over His sheep one shepherd, His servant David, who would personally feed them (cf. John 10:9; 14:6; Acts 4:12). Yahweh would be their God, and His servant David would be prince (Heb. *nasi'*, namely, king) among them. This the Lord assuredly promised (cf. 37:22-26). As mentioned before, Ezekiel customarily used *nasi'* in place of *melek*, the normal Hebrew word for "king," to stress the fact that someone had put the *nasi'* on his throne.

"The term 'prince' is probably used here to facilitate a contrast with the 'princes' (i.e., kings) of the Davidic dynasty who are denounced in earlier oracles (see 7:27; 12:10; 19:1; 21:25; 22:6, 25)."⁴⁸⁰

In view of the promises that God Himself would shepherd His sheep and the promises that His servant David would shepherd them, it seems clear that a god-man is in view (cf. 37:24-25; Isa. 11:1; Jer. 23:5-6; 30:9; Hos. 3:5; Mic. 5:2; John 10:30; 1 Tim. 2:5). Twenty out of Ezekiel's 38 usages of *nasi'* refer to the coming Messiah.⁴⁸¹ Did God mean that He would raise David from the dead to lead the Israelites again? No, He probably meant that someone from David's descendants would lead them (cf. 2 Sam. 7:12-16; Isa. 55:3-4; Jer. 30:9; Hos. 3:5). However a few interpreters have concluded that resurrected King David is in view here.⁴⁸² David was the model shepherd of sheep and the model king of Israel (cf. 1 Sam. 13:14).

". . . David was the man whom God chose and in whom He delighted; the king who triumphed against all his foes and who extended his kingdom in all directions; the man of Judah under whose genius the whole nation was for a time united."⁴⁸³

Though the identity of this "David" may have been obscure to Ezekiel's audience, history demonstrated that it was one of David's descendants who proved to be the Good Shepherd, even Jesus Christ (John 10:11, 14).

⁴⁸⁰Chisholm, *Handbook on . . .*, p. 278.

⁴⁸¹Kaiser, p. 241,

⁴⁸²E.g., Dyer, "Ezekiel," p. 1295.

⁴⁸³Taylor, p. 223.

"In a sense Jesus, the Good Shepherd and the Son of David, is in view here, but the eschatological orientation of the whole passage removes the setting from the period of His earthly ministry in the first century to that of His second advent when He will come to sit on the throne of David."⁴⁸⁴

The covenant of peace 34:25-31

"The themes of regathering as sheep and of covenant merge in Ezekiel 34:25-31."⁴⁸⁵

34:25 The Lord also promised to make a covenant of peace (i.e., resulting in peace) with Israel (cf. 16:60; 37:26-28; 38:11-13; 39:25-29; Isa. 54:10). This is probably a reference to the New Covenant that God promised to make with Israel in the future (Jer. 31:31-34).

Some commentators believed that this covenant is not the same as the New Covenant.⁴⁸⁶ Alexander believed that the Jews would enter into the covenant of peace when Israel accepts the New Covenant.⁴⁸⁷ My view, and that of others, is that the New Covenant was inaugurated at the Cross and now governs all believers. When Israel repents as a nation, she will enter into the benefits of this covenant that God has specified for Israel, including dwelling in peace in her land.⁴⁸⁸

"The word *peace* [Heb. *shalom*] is used to describe the harmony that exists when covenant obligations are being fulfilled and the relationship is sound. It is not a negative concept, implying absence of conflict or worry or noise, as we use it, but a thoroughly positive state in which all is functioning well."⁴⁸⁹

The provisions of this covenant that Ezekiel mentioned here included, first, removing threats to the Israelites' safety from the land so they could even live at peace in its formerly dangerous parts, for example, the wilderness and woods (cf. John 10:27-29).

34:26-27a Second, God would make His people and the places around His hill (Mount Zion, Jerusalem) a blessing to others (Gen. 12:3). God's seasonal blessings on Israel, both people and land, would be like the rain, and He would send His blessings down in showers (cf. Acts 3:19-20). The gospel

⁴⁸⁴Merrill, p. 382. Cf. Wiersbe, p. 225.

⁴⁸⁵Merrill, p. 377.

⁴⁸⁶E.g., Block, *The Book . . .* 48, p. 301; and Alexander, "Ezekiel," p. 914.

⁴⁸⁷Ibid.

⁴⁸⁸Cf. Dyer, in *The Old . . .*, p. 688.

⁴⁸⁹Taylor, p. 224.

song "There Shall Be Showers of Blessing" comes from this expression. Fruit trees would bear abundantly, and fruits and vegetables and flowers would proliferate in the land (cf. Hos. 2:22; Joel 3:18; Amos 9:13-14; Zech. 8:12). Even the plants would be secure.

34:27b-29 Third, when God broke the yoke that held His people in captivity and freed them from their oppressors they would know that He is Yahweh (v. 27b).

Fourth, the Israelites would live in complete security. They would no longer be a prey to the nations or to the beasts of the earth that previously devoured them (cf. Isa. 11:6-9). The beasts may be a figure for the Gentile nations that sought to devour Israel. The Israelites would live without fear of molestation. God would provide for them a place where they could put down roots, a place that would become famous. Famines and the insults of the other nations would cease forever. There are 17 "I wills" in verses 11-29 indicating Yahweh's commitment to be involved in the lives and destinies of His people personally.

34:30 Fifth, Yahweh would be their God and they would be His special people in the fullest sense that the nation had ever experienced (cf. Jer. 31:33; Rom. 11:25-27). Everyone would know that He was with them and that they were His Chosen People.

"This covenant anticipates events and promises never realized in the first return of Israel from captivity. When the people came back to the land after 535 B.C., they were under the control of every world-dominating power including Medo-Persia, Greece, and finally Rome until A.D. 70 when the nation was destroyed by Rome."⁴⁹⁰

Millennial conditions are in view.

34:31 The sheep in view, God clarified, were people, not real sheep. He was describing His relationship to them as people in the figure of a shepherd and sheep.

There are basically three views concerning the meaning of literal interpretation that may be helpful to clarify as we proceed in the eschatological portions of Ezekiel (chs. 34—48). First, some who claim to interpret the text literally do so but deny the existence of many figures of speech. In Ezekiel 34, for example, they might not recognize "shepherd" as a figure of speech but might conclude that God was speaking of the literal shepherds of literal sheep in Israel. Obviously there are few who deny all figures of speech, but interpreters of this persuasion do not recognize as figures of speech many that other interpreters do. This is "wooden literalism," "letterism," or "literalistic" interpretation that

⁴⁹⁰Cooper, p. 304.

seeks "a straightforward reading of the text." Most interpreters of this type are premillennial in their understanding of the future.

A second group of interpreters who consider themselves literal try to recognize figures of speech where they occur in the text, the understanding of the original readers, historical perspective, contextual clues, the progress of revelation, the analogy of faith, etc. They seek to discover what the original readers understood when they read the text as a basis for understanding how we should understand it. The interpretations that I have advocated above in my comments on Ezekiel 34 and elsewhere in these notes illustrate this approach. Many interpreters in this group like to use the term "normal" to describe their hermeneutics (principles of interpretation). Most of these interpreters are also premillennial.

A third group interprets most portions of the text literally but believes prophetic material is mainly symbolic and figurative, not to be interpreted in a normal, straightforward manner. They depend heavily on the New Testament to understand the meaning of the Old Testament and read New Testament revelation back into the Old Testament as the Old Testament meaning. They understand, for example, some of the references to God blessing Israel in the future in Ezekiel 34 as fulfilled in His blessing the church. They do not look for an eschatological fulfillment of these promises in the Jews. For example, the promises of God regathering Israel to her land are not taken to mean that God will eventually re-gather the Jews to the Promised Land. Rather He will gather His people (i.e., all the redeemed) to heaven, the land that He has prepared for us. Thus they "spiritualize" the Old Testament prophecies while taking the rest of the Old Testament more or less literally. Most interpreters of this type end up with an amillennial or postmillennial understanding of the future.

Most interpreters who hold the first and third hermeneutical positions also claim to hold the second one and sometimes argue that those who hold the other positions do not.

"Various facets of chapters 33—48 may be used as analogies, illustrations, and object lessons in the NT; but such does not demand that the NT is necessarily giving a 'fulfillment' of these chapters."⁴⁹¹

3. Preparation of the Promised Land 35:1—36:15

"Each of the next four speeches elaborates an aspect of the peace covenant. Ezekiel 35:1—36:15 describes how the foreign plundering nations would be removed and judged in preparation for Israel's return to her own land. The message in 36:16—37:14 provides a beautiful and descriptive account of God's restoration of Israel to her land. Ezekiel 37:15-28 stresses the full reunion of the nation and the fulfillment of her covenants when this peace covenant is established. Finally, Ezekiel 38—39 develops the concept of Israel's permanent and complete security in the

⁴⁹¹Alexander, "Ezekiel," p. 906. His entire explanation of this subject, on pages 905-8, is well worth reading.

Lord, for he would thwart the final attempt by a foreign power (Gog) to possess Israel's land and to plunder God's people."⁴⁹²

The elimination of claimants to the land ch. 35

What follows in this chapter is another oracle against a foreign nation (cf. chs. 25—32). What is it doing here? Evidently the writer included this oracle here because it promises to desolate an enemy of Israel that wanted to occupy Israel's land, which God promised to return to His people (ch. 34). An additional reason for the inclusion of chapter 35 here follows.

"It may appear at first as though the present prophecy belongs to the oracles against foreign nations, but it is probably here as a point of contrast to chapter 36, that is, wrath for Mount Seir contrasted with blessing for the mountains of Israel."⁴⁹³

A common explanation for the apparent misplacing of this oracle, as well as for other apparently misplaced sections of Bible books, is that later editors of the book made an error in translation or added the section here mistakenly. This view manifests a low view of God's ability to preserve His Word through history. It also fails to appreciate the similarities between chapters 35 and 36, and chapter 36 clearly is not out of place in this section of the book.

But why did the Lord target Edom here? Probably Edom was representative of all the enemies of Israel who wanted to take over her land and was selected because of her long history of land squabbles with Israel (cf. Gen. 25:22-34; 27; 36:6-8, 31-43; Num. 20:14-21; 24:15-19; 1 Sam. 14:47; 1 Kings 11:14-22; 2 Kings 8:21; 2 Chron. 20:1-23; 28:17; Ps. 137:7; Isa. 11:14; 34:5-6; Lam. 4:21-22; Dan. 11:41; Amos 2:1; Obad. 10-14; Mal. 1:2-5). Edom was the nation that had longest and most consistently resisted Israel's occupation of the Promised Land. Therefore, if God is going to give Israel her land in the future, as He promised in chapter 34, He will have to deal with Edom and all other nations that oppose Israel's possession of it. This section assures the readers, both ancient and modern, that He will deal with opponents to Israel occupying her land by prophesying the destruction of Israel's greatest antagonist viewed as a representative of all such powers (cf. Matt. 25:31-46). Edomite invasions of Israel following the Babylonian decimation of Judah also made Edom a major topic of interest.⁴⁹⁴

"Edom was the prototype of all Israel's later foes. The destruction of Edom would signal the beginning of God's judgment on the whole earth based on that nation's treatment of Israel (cf. Gen. 12:3)."⁴⁹⁵

35:1-2 The Lord directed Ezekiel to prophesy about Mount Seir (Edom, Gen. 32:3; 36:8), to "set your face against" it. The first use of the expression "set your face against" in this book occurs in a prophecy against the

⁴⁹²Ibid., p. 914.

⁴⁹³Feinberg, p. 201.

⁴⁹⁴Stuart, p. 327.

⁴⁹⁵Dyer, "Ezekiel," p. 1295.

mountains of Israel (6:2). Why did God refer to Edom as "Mount Seir" when in the oracle against Edom in 25:12-14 He simply called it "Edom?" Apparently He did so to highlight the contrasts between the mountains of Edom and the mountains of Israel, which He contrasted in chapter 35 and 36:1-15 (cf. 36:1).⁴⁹⁶ Two oracles against Edom in one book also double the certainty of fulfillment (cf. Gen. 41:32).

- 35:3-4 Yahweh announced that He was opposed to Mount Seir (cf. 36:9), would stretch out His hand in judgment against it (cf. 6:14), and would turn it into a desolate waste. He would destroy its cities (cf. 36:10), and the Edomites would learn that He is God.
- 35:5 He would do this because the Edomites had been enemies of the Israelites throughout their history (cf. 25:12; Gen. 12:3). Furthermore, they had not helped their brethren Israelites in the time of their calamity, the time when God was punishing Israel, but had turned them over to their enemy, the Babylonians (cf. 2 Chron. 20:10; Ps. 137:7; Lam. 4:21-22).
- 35:6-7 For this reason, the sovereign Lord swore, He would turn the Edomites over to others who would shed their blood. Since they had not tried to prevent bloodshed in Israel, they would experience bloodshed in Edom. "Bloodshed" (Heb. *dam*, lit. blood) may be a play on Edom's name (Heb. *edom*, from *'adom*, "to be red"). God would make Mount Seir a desolate waste, such a desolation that few people would visit it.
- 35:8-9 The Edomites would fall slain in all parts of their land (cf. 6:3, 7). They would never recover from this judgment, and their cities would remain uninhabited. This was a harsher fate than even what God inflicted on Egypt (29:14) or Ammon (Jer. 49:6). Then the Edomites would know that Yahweh is the only true God.
- 35:10 The Lord gave three more reasons for Edom's judgment (cf. v. 5). The Edomites had wanted to take over the lands of both Israel and Judah even though they were the lands of Yahweh (cf. 36:12). Ancient Near Easterners viewed the lands of nations as the domain of the gods of those nations. To take a nation was to overcome its god. Thus in trying to take over Israel's land Edom tried to discredit Yahweh since "the Lord was there," it was His land (cf. v. 12; 48:35). This in turn involved failing to recognize Yahweh as the only true God (v. 13).
- 35:11-13 Therefore, the sovereign Lord swore again (cf. v. 6), He would deal with them with the same anger, envy, and hatred that they had demonstrated toward the Israelites (cf. 36:5-6). People would know that He had done this when He judged them. This would teach them that the Lord had heard the hateful words that the Edomites had spoken against "the mountains of

⁴⁹⁶Zimmerli, *Ezekiel 2*, pp. 232-34; Block, *The Book . . . 48*, p. 310. See Allen, *Ezekiel 20—48*, pp. 170-71, for many other connecting links between these two contrasting parts of this prophecy. See also Cooper, pp. 306-8.

Israel" (cf. vv. 2, 3, 7, 15; 36:1, 4, 8). By speaking against the Israelites the Edomites had spoken against Yahweh since He was their God, and the Lord had heard them (cf. 36:5; Mal. 1:1-5).

35:14-15 The Lord would cause all the earth to rejoice when He made Edom a laughingstock in the world, just as it had rejoiced when Israel became desolate (cf. 36:5). Mount Seir and all of Edom would become absolutely desolate (cf. 36:10). It would not exist when the Lord restored His people to their land. Then the Edomites would learn that Yahweh is God.

"The prediction has been literally fulfilled. Edom was first subjugated by Babylon, then Medo-Persia, and then in 126 B.C. by John Hyrcanus the Hasmonean, who compelled them to become Jews. There is no trace of the Edomites now, although their desolate cities can still be identified, as predicted by Obadiah (v. 18) and Jeremiah (49:13)."⁴⁹⁷

The establishment of Israel in the land 36:1-15

This part of the prophecy of the preparation of the Promised Land sets forth what God would do for Israel. It contains the opposite of the curses against Israel warned of in chapter 6, and it contrasts Israel's glorious destiny with the terrible fate of Edom in chapter 35.

"The chapter contains the most comprehensive enunciation of the plan of redemption to be found in this book, setting forth all the factors that comprise God's plan of salvation."⁴⁹⁸

"Ezekiel 36 parallels the New Covenant God promised to Israel and Judah in Jeremiah 31. This covenant includes at least three specific elements: (a) restoration to the land (Ezek. 36:24; Jer. 31:27-29), (b) forgiveness of sin (Ezek. 36:25; Jer. 31:34), and (c) the indwelling presence of God's Holy Spirit (Ezek. 36:26-27; Jer. 31:33)."⁴⁹⁹

"The future of Israel [in chapters 36 and 37] can be summarized in four words: restoration, regeneration, resurrection, and reunion."⁵⁰⁰

36:1-3 Yahweh commanded Ezekiel to prophesy to the mountains of Israel (in contrast to Mount Seir, cf. 6:1-14). The reason was threefold. First, Israel's enemy had spoken against her (cursed her, cf. Gen. 12:3) by rejoicing that the everlasting heights (mountains) of the land had come into their possession (cf. 6:3; 20:29). The Hebrew word *bamoth*, usually translated "high places," the places where pagan altars stood in Israel, more generally, and here, refers to the mountains themselves. Second, the enemy of Israel had destroyed her for good reason, namely, her sinfulness.

⁴⁹⁷Feinberg, pp. 201-2.

⁴⁹⁸Ibid., p. 205.

⁴⁹⁹Dyer, in *The Old . . .*, p. 690.

⁵⁰⁰Wiersbe, p. 227.

Third, now she was the possession of the nations of the world and the subject of their scorn (cf. Deut. 28:37; Jer. 24:9). They talked publicly and privately about her fate. This prophecy concerns the land of Israel primarily, not the people of Israel.

- 36:4-5 Therefore the sovereign Lord had something to say to the whole land that had fallen prey to Israel's neighbor nations. Because Edom and the other nations had taken over the Lord's land joyfully and had scorned the Israelites, He would pronounce judgment on them in his hot jealousy. The Promised Land was the Lord's land in the same sense that the Sabbath was His day and the tithe was His possession. These parts were not just segments of their wholes over which God claimed ownership, but they represented and illustrated His ownership of all lands, all days, and all possessions. Israel's enemies had dealt with her in their anger and envy (35:11), but now Yahweh would deal with them in His fierce jealousy over Israel's welfare.
- 36:6-7 Ezekiel was to announce to the whole Promised Land that Yahweh had spoken in His jealousy and wrath because Israel had suffered the insults of the nations (cf. Gen. 12:3). The nations round about Israel would surely have to endure the consequences of their insults against Israel.
- 36:8-9 Verses 8-15 contain four promises concerning the land. First, the land would become productive because the Israelites would soon come back into the land. Yahweh assured the land that He was for it, He would bless it, and it would become cultivated again instead of desolate and uninhabited. Formerly the Lord had said that He was against Mount Seir (35:3).
- 36:10-11 Second, the Lord promised to fill all the land with Israelites, to enable them to live in their cities and rebuild the places that had become ruins (cf. 6:3, 5-7). Earlier the Lord promised to desolate all the land of Edom (35:15) and to lay waste her cities (35:4). The mountains of Israel would again become populated with people and animals that would become fruitful and multiply. The Lord would bless them more greatly than ever before. Then His people would know that He is God.
- 36:12 Third, the Lord would cause the people of Israel to take possession of these mountains as their inheritance and never leave them again (cf. Gen. 12:7). The Edomites had formerly determined to possess these mountains (35:10).
- 36:13-15 The nations had accused the Promised Land of devouring its inhabitants (cf. Num. 13:32), but Yahweh would see that it no longer did that. Fourth, He would not allow the Israelites to hear insults from their neighbors any longer, to bear disgrace any longer, or to stumble in their affairs any longer. He would restore them to their prestigious position as His Chosen People (cf. Deut. 28:13; Zech. 8:13, 20-23).

All the connections between how God would deal with Israel relative to the nations illustrate the retributive justice of God. He would deal with the enemies of His people as they had dealt with Israel, and He would bless Israel in the very ways the nations sought to humiliate Israel.

A typical covenant theology interpretation follows.

"From the perspective of the New Testament, these promises all apply to the church as the new Israel. How could such seemingly materialistic images have relevance for God's people who are not a single earthly nation farming in a single part of the world? The answer is that they apply literally but not literalistically. The church may take great comfort in the fulfillment of the sort of greatness, confidence, certainty of success, and ultimate victory over all its foes that such a compound oracle (i.e., 35:1—36:15) guarantees. . . . We may instead rejoice that God has had in mind for us things that the eye had not seen nor the ear heard (1 Cor. 2:9)—things that the present description of the abundance of the mountains of Israel is intended only to symbolize."⁵⁰¹

4. Restoration to the Promised Land 36:16—37:14

Having prepared the land for the Israelites (35:1—36:15), the Lord would bring them back into it. This prophecy consists of four parts (36:16-21, 22-32, 33-38, and 37:1-14).

The reason for Israel's scattering 36:16-21

- 36:16-17 The Lord told Ezekiel that when the Israelites had lived in the Promised Land they had defiled it by the way they lived. They resembled a woman during her menstrual period who defiled everything she touched (cf. Lev. 15:19-23; Isa. 64:6).
- 36:18-19 Yahweh had poured out His wrath on them because of their bloodshed and idolatry. He had judged them for their deeds by scattering them among the nations (cf. Deut. 29:1—30:10).
- 36:20-21 Their dispersion made Yahweh look impotent since the nations concluded that He could not keep them safe in His land. The Lord had risked His reputation by driving Israel out of the land, but He cared about His reputation, which the Israelites had made common. We need to remember that how Christians represent God by our words and deeds likewise concerns Him (cf. Matt. 6:9; Luke 11:2).

"Israel was guilty of two great sins, the first of which was *polluting God's land* (vv. 16-19).

⁵⁰¹Stuart, p. 333.

"Their second sin was that of *profaning God's name before the Gentiles* (Ezek. 36:20-23)."⁵⁰²

The method of Israel's restoration 36:22-32

"The next verses in the chapter are among the most glorious in the entire range of revealed truth on the subject of Israel's restoration to the Lord and national conversion."⁵⁰³

36:22-23 Ezekiel was to tell the Israelites that it was in spite of them that He would act for them; He would deliver them for the sake of His own reputation that they had profaned (cf. 20:39). He would vindicate His reputation as being a holy (unique) God when He proved Himself such in the sight of the nations (cf. Exod. 5:2; 9:16; 32:11-18; Lev. 18:21; 20:3; 22:31-33; Num. 14:13-19; Deut. 29:1—30:10).

36:24-25 The Lord promised, first, to take the Israelites from all the nations, to re-gather them, and to bring them back into their land (cf. 11:16-17; 20:34; 34:13; 37:21). He would then, second, purify His people and cleanse them from all their former uncleanness (cf. v. 17; 11:18; Exod. 12:22; Lev. 14:4-7; Ps. 51:7; Jer. 31:31-34; 1 Cor. 6:11). Justification, not sanctification, is in view.⁵⁰⁴

"The new exodus motif occurs ten times in Ezekiel, but it gains increasing prominence in the restoration oracles."⁵⁰⁵

36:26 He would, third, give them a new heart and spirit and would remove their hardness of heart and give them soft hearts (i.e., regenerate them; cf. 11:19; 18:31; 2 Cor. 3:3-6). Perhaps this passage was in the Lord Jesus' mind when He spoke to Nicodemus about the new birth.⁵⁰⁶ The heart stands for the whole person—mind, will, and emotions (cf. 2:4; 3:7)—and the spirit describes the motivation that drives thought and conduct.

"The temptation to find the fulfillment of the 'new heart' and 'new spirit' of 36:25-27 exclusively in Christian conversion in this age should be resisted. New Testament conversion is only a preview of the massive spiritual revival God has in store for all of true Israel and Gentiles who believe."⁵⁰⁷

⁵⁰²Wiersbe, p. 228.

⁵⁰³Feinberg, p. 209.

⁵⁰⁴Ibid.

⁵⁰⁵Block, *The Book . . . 48*, p. 353. Cf. 11:17; 20:34-35; 20:41-42; 28:25; 29:13; 34:13; 36:24; 37:12, 21; 39:27.

⁵⁰⁶Cf. Kaiser, p. 242.

⁵⁰⁷Cooper, p. 317.

- 36:27 God would, fourth, also put His Spirit within the Israelites and cause them to obey His commands carefully (cf. 11:19-20; 18:31; 37:14; 39:29; Jer. 31:31; Joel 2:28-29; Acts 2:17-18; Rom. 7:7—8:4; 2 Cor. 3:6-18; Heb. 8:6—10:39). This is a coming of the Holy Spirit on Israel in the future, not His coming on the church at Pentecost.
- 36:28-30 They would, fifth, live in the Promised Land and enjoy a permanent, intimate relationship with God (cf. Jer. 31:33). He would also deliver them from their uncleanness (v. 25) and, sixth, give them abundant harvests constantly so they would never experience famine (cf. 34:29). In other words, He would bless them with consistent fertility and fruitfulness (cf. 34:29).
- 36:31-32 Then the Israelites would, seventh, remember their former sins and loathe themselves (cf. 6:9; 20:43). Again, the Lord would not accomplish this regathering for the sake of His people, but for the sake of His reputation among the rest of the world's population (cf. v. 22). This present announcement of God's gracious dealings with His people should shame them and bring them to their knees in repentance.

"This context and that of similar accounts of God's restoration of Israel to her land, along with the historical perspective, make it clear that the return mentioned in this passage does not refer to the return to Canaan under Zerubbabel but to a final and complete restoration under the Messiah in the end times. The details of Israel's reestablishment on her land set forth above simply did not occur in the returns under Zerubbabel, Ezra, and Nehemiah."⁵⁰⁸

This new covenant passage in Ezekiel 36:22-32 has much in common with the new covenant passage in Jeremiah 31:31-34. A significant difference is that Jeremiah put more emphasis on the role of God's Word in Israel's transformation whereas Ezekiel put more emphasis on the role of God's Spirit. Both His Word and His Spirit will be crucial in Israel's future restoration.

The results of Israel's return 36:33-38

- 36:33-34 Future cleansing from sin and restoration of the Jews to the land and restoration of the land to fruitfulness would all occur at the same time. This shows that the Jews' present occupation of the Promised Land does not fulfill these promises; they have not yet experienced God's cleansing for their sins, which comes with regeneration (cf. Rom. 11:26-27).
- 36:35-36 People would marvel at the lushness of the formerly desolate land and at the strength of the formerly ruined cities of Israel (cf. Isa. 11:6-9; 51:3;

⁵⁰⁸Alexander, "Ezekiel," p. 922.

Joel 3:18; Amos 9:13-15; Rom. 8:19-22; 2 Pet. 3:13; Rev. 21:1-4, 23-27). The other nations of the world would recognize that Israel's God was responsible for this transformation.

36:37-38 The Lord also promised to respond to the prayers of the Israelites to increase their population.

"For the first time in the book he permits himself to be entreated by the house of Israel."⁵⁰⁹

The Jews would fill the cities like the sheep used to fill Jerusalem during the feasts when the people offered large numbers of them as sacrifices to the Lord. These would not be sheep for slaughter but living sacrifices in God's service. This increase in the population in the Promised Land would also convince people of Yahweh's unique deity.

"In analyzing Ezekiel's doctrine of the salvation of Israel, the salient factors are as follows: (1) The preeminent motive in their redemption is the glory of God (vv. 22, 32). (2) Israel will know ultimately that their God is the Lord (v. 38). (3) There will be an abhorrence of their sins (vv. 31-32). (4) Forgiveness of their sins will be realized (v. 25). (5) Regeneration will be effected (11:19; 18:31; 36:26-27). (6) The gift of the Holy Spirit will be granted (v. 27; 37:14). No prophet before him assigns the ministry of the Holy Spirit in regeneration such a precise place as Ezekiel does. (7) Included is obedience to God's laws (v. 27; 11:20)."⁵¹⁰

By faith in Jesus Christ, Gentiles as well as Jews presently experience many of the same blessings that God promised here to bring to the entire nation of Israel in the future. But this should not lead us to conclude that these promises have no future fulfillment with Israel but are only fulfilled spiritually in the church. One writer pointed out that God added blessings to this covenant as He revealed it progressively through history before its ratification at the Cross.⁵¹¹ Ezekiel added some revelation that Jeremiah did not give, for example.

"It should be clear that the realization of these promises did not come to fruition in the postexilic period, nor have they been fulfilled today. Israel as a nation is not regathered and has not experienced spiritual regeneration, and the land of Palestine is not characterized by the supernatural fecundity described in Ezekiel 36:22-38."⁵¹²

⁵⁰⁹Block, *The Book . . .* 48, p. 364.

⁵¹⁰Feinberg, p. 205.

⁵¹¹Rodney J. Decker, "The Church's Relationship to the New Covenant," *Bibliotheca Sacra* 152:6-7 (July-September 1995):290-305.

⁵¹²Mark F. Rooker, "Evidence from Ezekiel," in *A Case for Premillennialism: A New Consensus*, p. 127.

An illustration of Israel's restoration 37:1-14

This well-known apocalyptic vision of the valley of dry bones pictures the manner in which Yahweh would restore His people.⁵¹³ This may be the best-known section of the Book of Ezekiel.

"Few other passages have suffered more from the extremes of interpreters who see either too much or too little in both meaning and application of the figures, symbols, and types."⁵¹⁴

"The New Covenant involves a new heart and a new spirit, to be sure, but it is deeply rooted in history and land. The promise to Abraham was unconditional and included in its benefits a geographical inheritance—indeed, not just any territory but specifically the land of Canaan (Gen. 12:1, 7; 13:15-17; 15:18-19; 17:8). It is that land that is in view throughout Ezekiel's historical and eschatological purview, for unless that land is the focus of God's covenant fulfillment the ancient promises lose their intended significance.

"The coalescence of the New Covenant and the renewed land is nowhere in the Old Testament better explicated than in Ezekiel 37."⁵¹⁵

"On the surface, New Testament references to the realization of the new covenant in the present era are problematic, for Jeremiah and Ezekiel spoke of this covenant being made with Israel, not the Gentiles. Some argue that the church is the new 'Israel' through which the Old Testament promise is fulfilled. Others, insisting on a sharp distinction between Israel and the church, propose that the new covenant mentioned in the New Testament is distinct from the one promised in the Old Testament. A better solution is to propose an 'already/not yet' model, which sees a present realization of the promises in the church and a future fulfillment for ethnic Israel. Only this mediating view does justice to the language of both the Hebrew prophets and the New Testament. Just because the Hebrew prophets mention only Israel as the recipient of the covenant does not mean that others could not be recipients as well; just because the New Testament focuses on a present realization through the church does not preclude a future fulfillment for Israel."⁵¹⁶

37:1-2 The Lord lifted Ezekiel up by His Holy Spirit and transported him in a vision to the middle of a valley full of dry bones (cf. 1:3; 8:1; Deut. 28:25-26). This may have been the same valley (or plain, Heb. *biq'a*) in which

⁵¹³For a review of apocalyptic as a literary genre, of which this passage is an example, see the Introduction section of these notes, or Alexander, "Ezekiel," p. 924.

⁵¹⁴Cooper, p. 319.

⁵¹⁵Merrill, p. 379.

⁵¹⁶Chisholm, *Handbook on . . .*, pp. 280-81.

Ezekiel saw his vision of God's glory (cf. 3:22). In this vision, the prophet walked around among the many very dry bones that littered this valley. They represent the Israelites slain during the conquest of the land and now in exile for a very long time.⁵¹⁷

- 37:3-4 The Lord asked Ezekiel if the bones could live again. The prophet replied that only the Lord knew (cf. Rev. 7:14); He could make them live, Ezekiel believed, but he did not know if that is what God would do. The Lord also instructed Ezekiel to prophesy over the dry bones and to tell them to hear His word.
- 37:5-6 The Lord told the bones that He would cause breath (Heb. *ruah*, wind, spirit, Spirit) to enter them and they would come back to life (cf. Hos. 6:2). The various occurrences of the Hebrew word *ruah* in this pericope sometimes mean breath (vv. 5, 6, 8, 9, 10) or wind (v. 9) or spirit or Spirit (vv. 1, 14). Context determines meaning.⁵¹⁸ He would also put sinews on the bones, make flesh grow back on them, cover them with skin, and put breath in them. They would come back to life and know that He is Yahweh.
- 37:7-8 Ezekiel spoke to the bones as the Lord had commanded him, and as he did he heard a rattling noise as the bones began to come together. The prophet saw sinew, flesh, and skin come back on them, but there was no breath in them; they were not yet alive.
- 37:9-10 The Lord then told Ezekiel to prophesy to the breath and to command it in the name of the Lord to come from the four winds (i.e., every direction) and give life to the bones (cf. Isa. 43:5-6; Jer. 31:8). Ezekiel followed the Lord's instructions, and breath came into the corpses (cf. Gen. 2:7; Rom. 8:1-17). They came to life, stood up, and formed a very large group of people, as large as an army.

"What is the significance of the two stages [vv. 4-8 and 9-10]? The difference between them is surely to be found in the *direction* of Ezekiel's prophesying; first to the bones, telling them to hear, and secondly to the spirit, invoking its inspiration. The first must have seemed to Ezekiel very much like his professional occupation, exhorting lifeless people to listen to God's word. The effect was limited: true, something remarkable happened, but the hearers were still dead men. The second action was tantamount to praying, as Ezekiel besought the Spirit of God to effect the miracle of re-creation, to breathe into man's nostrils the breath of life (cf. Gn. 2:7). This time the effect was devastating. What

⁵¹⁷Davidson, p. 267; Taylor, p. 234. Stuart, pp. 342-43, wrote a helpful description of ancient burial customs that illuminates this passage.

⁵¹⁸For a similar use of the equivalent Greek word *pneuma* (wind or Spirit), see John 3:8.

preaching by itself failed to achieve, prayer made a reality."⁵¹⁹

37:11-13 The Lord explained to Ezekiel that the bones represented the whole house of Israel (cf. 36:10). The Israelites were saying that they were like dry bones: they had been dead for a very long time spiritually as well as physically. They had no hope of life in the future; they had lost all hope of becoming a nation again or of seeing God's promises to them fulfilled literally. The Lord had cut them off completely; the bones were separated from each other, and the Israelites were scattered over the earth. Consequently, Ezekiel was to prophesy to them that the sovereign Lord would open their graves, cause them to come up out of their graves, and bring them back into the Promised Land. Then they would know that He is God.

"This chapter then does not deal with the doctrine of the personal bodily resurrection but with national resurrection."⁵²⁰

37:14 He promised again to put His Spirit within them, bring them back to life, and place them in their land (cf. vv. 9-10, 15-28; 36:22-32). This would teach them that He is God.

Notice that what God promised was both a spiritual and a physical restoration of the Israelites, and the end time is in view (cf. Matt. 24:30-31). So this is not a vision of the physical resurrection of all Israelites sometime in the future, nor is it a vision of the spiritual salvation of Jews and Gentiles in the future.⁵²¹ Old Testament passages teaching the resurrection of human beings include 1 Kings 17; 2 Kings 4:13-37; 13:21; Isaiah 25:8; 26:19; Daniel 12:2; and Hosea 13:14.

"This could genuinely be termed a 'rebirth' of the nation [cf. Rom. 11:26-27]. Just as the necessary elements of a nation were essential to the initial formation of Israel in Genesis through Joshua—a people, a government, and a land—so God would provide all three essentials once again in this rebirth of Israel in the future. The people of that day are brought together through restoration in 36:16—37:28. The land is provided in the prophecy of 35:1—36:15. The government of renewed Israel would be given in Ezekiel's apocalyptic vision revealed in chapters 40—48."⁵²²

"There is no finer *illustration* of the life-changing power of the preached word than what the prophet saw in his vision. It has the power to transform those who are dead in trespasses and sins (Eph 2:1-22) and make them new, living creatures in Christ (2 Cor 5:17)."⁵²³

⁵¹⁹Taylor, p. 235.

⁵²⁰Kaiser, p. 243.

⁵²¹See Cooper, pp. 319-22; Feinberg, p. 214; and Daniel I. Block, "Beyond the Grave: Ezekiel's Vision of Death and the Afterlife," *Bulletin of Biblical Research* 2 (1992):112-41.

⁵²²Alexander, "Ezekiel," p. 926.

⁵²³Cooper, p. 325. Italics mine.

5. Reunification in the Promised Land 37:15-28

37:15-17 The Lord also commanded Ezekiel to take two sticks (or tablets; cf. Zech. 11:7-14). He was to write on one of them "For Judah and for the sons of Israel, Judah's companions." He was to write on the other stick "For Joseph and for the sons of Ephraim, Joseph's companions." One stick represented the Jews of the Southern Kingdom of Judah and the other the Jews of the Northern Kingdom of Israel. Ezekiel was then to join the two sticks together in his hand end to end so they appeared to be one stick. Mormonism teaches that the two sticks represent the Bible (the stick of Judah) and the Book of Mormon (the stick of Joseph), but the rest of the passage refutes this interpretation.

37:18-19 When Ezekiel's audience asked him what his symbolic act represented (cf. 4:1; 5:1; 12:9; 17:12; 20:49; 24:19), he was to tell them that the Lord said He would combine the two parts of Israel into one whole nation (cf. Isa. 11:12-13; Jer. 3:18; Hos. 1:11). This promise refutes the teaching of British Israelism and other groups who hold that the 10 northern tribes were lost and later became some other national entity (cf. Isa. 43:5-7; 49:5-6; Jer. 3:12-15).

"We know comparatively little about the history of the exiled northerners, but there is no evidence of any return. There was Jewish awareness of northern tribes in Assyria: the apocryphal book of Tobit has such a setting."⁵²⁴

37:20-22 The prophet was to hold these sticks, on which he had written what the Lord told him, in the sight of the exiles. He was to explain that Yahweh promised to bring exiles from both kingdoms back into the land. He would make one united kingdom of them again and set up one king over all of them (cf. Gen. 12:1-3, 7; 16:10; 17:7-9; 22:17-18; 28:4, 13-15). They would no longer be two nations, a divided kingdom.

37:23 These Jews would no longer defile themselves with idols, other detestable things, or transgressions of the Lord's (Mosaic) covenant. The Lord promised to deliver them from the many places where they had gone and sinned and to cleanse them (cf. Jer. 31:31-34). Then they would enter into a proper relationship with Him. In the present State of Israel only about 5 percent of the population is actively "religious," and Jesus Christ is more firmly rejected there than almost anywhere else.⁵²⁵

"This verse addresses the fourth dimension of ancient perceptions of national identity—a healthy relationship between Israel and her patron deity."⁵²⁶

⁵²⁴Allen, *Ezekiel 20—48*, p. 195.

⁵²⁵Stuart, p. 347.

⁵²⁶Block, *The Book . . . 48*, p. 414.

Block called these four dimensions ethnic integrity (v. 21a), territorial integrity (v. 21b), political integrity (v. 22), and spiritual integrity (v. 23).⁵²⁷

- 37:24-25 God's servant David would rule over the Jews and be their king (34:24; 2 Sam. 7:13, 16; Jer. 30:9; Hos. 3:5). They would have only one king who would shepherd them so that they would follow the Lord faithfully (cf. Exod. 19:5-6; Lev. 26:12; Deut. 7:6; 14:2, 21; 26:18-19; 27:9; Jer. 30:22; 31:33; 32:38). They would live in the Promised Land forever, and the Lord's servant David would be their appointed ruler forever. In view of God's promise to David in 2 Samuel 7:12-13, this must refer to the Son of David, Messiah. In sum, Israel will enjoy three new realities: a new commitment to Yahweh's will (v. 24b), occupation of her hereditary homeland forever (v. 25a), and the rule of David forever (v. 25b).
- 37:26-28 The Lord also promised to make a covenant of peace with His people (cf. 16:62; 20:37; 34:25). He would plant them securely in the land and multiply their numbers (cf. Gen. 22:17-18). He would also set His sanctuary in their midst forever (cf. 20:40; 40:5—43:9; Zech. 6:12-13), not temporarily as He had done with the tabernacle and temple. His dwelling place would be with them forever, and He would also establish an intimate relationship with them. The people of the world would know that He is Yahweh who sets aside Israel as sacred for His glory and special purpose in the earth when He would set up His sanctuary in Israel's midst forever (cf. Exod. 19:5-6).

The words "forever" and "everlasting" occur five times in verses 25-28. The reestablished Israelites would live in the land forever and would have an everlasting king, an everlasting covenant, and an everlasting sanctuary. There are also 13 promises in verses 15-28 and 10 "I will" commitments.

6. Future invasion of the Promised Land chs. 38—39

This is the sixth and last message (a proof oracle⁵²⁸) that Ezekiel received from the Lord the night before the refugees reached the exiles with the message that Jerusalem had fallen (cf. 33:21-22). It too deals with God's plans for Israel in the distant future, when He would restore her to her land. It answers the question, What about future enemies of Israel? This message guarantees Yahweh's protection of Israel. This section of the book consists of seven messages each marked by the introductory phrase, "Thus says the Lord God" (38:3, 10, 14, 17; 39:1, 17, 25). This is another apocalyptic passage.

"In Ezekiel 38—39 the prophet used parallels from Israel's first Exodus to describe God's 'new' exodus preceding the kingdom era. All that God intended for Israel during the first Exodus will be accomplished in the 'new' one.

⁵²⁷Ibid., pp. 410-14.

⁵²⁸Ibid., p. 431.

- Destruction of Gentile oppressors (Exod. 5—12; Ezek. 38—39)
- Plans for building God's house (Exod. 20—40; Ezek. 40—43)
- Climax: God's glory enters His house (Exod. 40:35; Ezek. 43:5)
- Instructions for worship (Leviticus; Ezek. 43-46)
- Land boundaries for Israel (Num. 34; Ezek. 47)
- Division of land among the tribes (Josh. 14—21; Ezek. 48)⁵²⁹

The enemy of restored Israel 38:1-9

38:1-2 The Lord commanded Ezekiel to utter an oracle of judgment against Gog (cf. 1 Chron. 5:4; Rev. 20:8), who was the prince (king) over Rosh, Meshech, and Tubal. His land was Magog (cf. Gen. 10:2; Rev. 20:8).

The identity of this ruler has been the subject of much study and speculation. The possibilities include a Reubenite prince (1 Chron. 5:4), a former king of Lydia named Gugu (or Gyges), an unknown "dark" figure (from the Sumerian word *gug*, meaning "darkness"), a man named Gagu who ruled over Sakhi (an area north of Assyria), an unspecified official ruler (taking "Gog" as a title) of a particular land (Magog), a general personal name for an otherwise unidentified enemy of Israel, or a code name for Babylon.⁵³⁰ It is probably safe to say at least that "Gog" refers to the name or title of a ruler who will be active in history while Israel is dwelling safely in her land (cf. v. 8). Perhaps Ezekiel referred to this unnamed future enemy of Israel as a dark figure (unknown and evil) calling him "Dark" much as we might refer to such a person as a new Hitler.⁵³¹ This may be the future "king of the North" (cf. Dan. 11:40-45). I think it is here, but Gog also represents another important eschatological figure.

The land of Magog probably refers to the former domain of the Scythians, who lived in the mountains between the Black and Caspian seas.⁵³² Gog will also have authority over Rosh, Meshech, and Tubal. Rosh (lit. "head" or "chief") has not been identified either by biblical or extrabiblical references. The idea that it refers to Russia rests on etymological similarities, but the name Russia only came into existence in the late eleventh century A.D.⁵³³ Thus a linguistic connection between Rosh and Russia is very tenuous.⁵³⁴ Rosh may be an adjective describing the ruler of Meshech and Tubal. Meshech and Tubal occur together in Scripture (27:13; 32:26; Gen. 10:2; 1 Chron. 1:5) and apparently refer to regions of

⁵²⁹Dyer, in *The Old . . .*, p. 691.

⁵³⁰See Alexander, "Ezekiel," p. 929; and Cooper, pp. 331-33.

⁵³¹Allen, *Ezekiel 20—48*, pp. 204-5.

⁵³²Josephus, *Antiquities of . . .*, 1:6:1. Cf. Carl Armerding, "Russia and the King of the North," *Bibliotheca Sacra* 120:477 (January-March 1963):50-55.

⁵³³Alexander, "Ezekiel," p. 930.

⁵³⁴Jon Ruthven, "Ezekiel's Rosh And Russia: A Connection?" *Bibliotheca Sacra* 125:500 (October 1968):324-33, sought to support this connection.

Anatolia (modern western Turkey), the areas that became known as Phrygia and Cappadocia. Some writers have connected Mesheck and Tubal with the Russian cities of Moscow and Tobolsk.⁵³⁵ Another writer concluded that Gomer referred to Germany.⁵³⁶ But again the connection is only etymological similarity. There is no literary or historical support for these identifications. The whole region would be what is now parts of southwestern Russia, Georgia, eastern Turkey, Armenia, and Azerbaijan.

38:3-4 Ezekiel was to announce that Yahweh was opposed to Gog. The Lord would reverse the fortunes of this ruler, take him captive, and bring him and his vast, impressive army out of his homeland. Putting hooks in his jaws pictures control that he would not be able to resist. The Lord would be the first cause of this action, but doubtless there would be secondary causes as well, such as Satan's influence and human decisions (cf. 2 Sam. 24:1; 1 Chron. 21:1; Isa. 10:5-19; Hab. 1:5-11).

38:5-6 Along with Gog, the Lord would take Persia, Ethiopia, Put, Gomer, and Beth-togarmah captive. This would involve vast numbers of soldiers. Persia lay to Israel's northeast, Ethiopia to her southwest, Put to her southeast (on the African coast of the southern Red Sea), Gomer to her northwest (in the Taurus mountains of Anatolia and possibly farther northwest in modern western Europe), and Beth-togarmah to her northwest (southeast of the Black Sea). Thus peoples all around Israel would unite against her under Gog's leadership. As Babylonia sought to destroy Israel in the past, so this latter-day Babylon will seek to destroy her in the future (cf. Rev. 16:13-14; 17:5). Ezekiel pictured a large alliance of nations against Israel.

38:7-9 The Lord told Gog to be ready with his allies. He would summon Gog to attack the Promised Land when the Israelites were back in it having been re-gathered in the end times (cf. Jer. 32:14; Dan. 8:26). The Israelites would be living securely in their land at this time enjoying peaceful conditions (cf. 37:26). Gog and his allies would descend on the land like a storm cloud.

The enemy's intention 38:10-13

38:10-12 At that time Gog would devise an evil plan against the Israelites. He would plan to invade the Israelites while they are at rest and plunder them. Israel would seem to be completely defenseless relying on her God to protect her and not fortifying herself. Israel has never in her past or present history enjoyed such an ideally peaceful situation. She would be living then at the center of the world as far as God's purposes for the world are concerned (cf. 5:5; Deut. 32:8), namely, the Promised Land.

⁵³⁵E.g., *The Scofield Reference Bible*, p. 881.

⁵³⁶A. C. Gaebelain, *The Prophet Ezekiel: An Analytical Exposition*, p. 259.

38:13 Other nations would also inquire about Gog's intentions and clarify his purpose to take much spoil from the Israelites. Sheba was in eastern Arabia, Dedan in Arabia, and Tarshish was in southern Spain or Sardinia.

The invasion of the enemy from the north 38:14-16

38:14 The Lord wanted Ezekiel to tell Gog that on the day the Lord would call him up for service (v. 4) he would know that Israel dwelt securely in her own land.

38:15-16 He and his allies would descend on Israel from the north and cover her like a storm cloud (cf. v. 6; 39:2; Dan. 11:40-45). Coming from the north recalls the earlier invasions of the Assyrians and Babylonians, but this will be a future invasion. God would bring Gog against His people "in the last days" (cf. vv. 8, 14, 18; 39:8, 11) to teach the nations to acknowledge Yahweh. They would do this when God used Gog to demonstrate His holiness (unique deity) in their eyes. Yahweh would raise up Gog as He had raised up the Pharaoh of the Exodus to demonstrate His power when He overthrew him.

Yahweh's judgment of the enemy 38:17-23

38:17 The Lord asked rhetorically if it was Gog about whom He had spoken through His other servants the prophets many years earlier. "Are you he of whom the prophets spoke?" Yes, he was. This was not the first revelation of a powerful enemy whom God would bring against the Israelites (cf. Deut. 31:17; Ps. 2:1-3; Isa. 14:24-25; 26:20-21; 29:1-8; Jer. 4:5; 6:26; 30:18-24; Joel 2:20; 3:9-21; Zeph. 1:14-18; 3:8, 15-20; Zech. 12:2-3; 14:2).

38:18-19 God would become very angry with Gog when he attacked Israel (cf. Gen. 12:3). He would send a great earthquake in the land that would express His anger (cf. Rev. 16:18).

"Yahweh's emotional reaction to Gog's invasion is obvious as he explodes, heaping up expressions for anger unparalleled in the book, if not in the entire OT."⁵³⁷

38:20-21 Every living thing on earth would feel this earthquake, the sign of God's presence. Mountains would fall down, as well as cliffs with their steep pathways, as would the walls that people had erected. Gog's allied forces would even turn on each other and fight one another (cf. Judg. 7:22; 1 Sam. 14:20; Hag. 2:22; Zech. 14:13; Rev. 19:19-20). Apparently the sword that God would call for to defeat Gog would be that of his own allies rather than that of Israel (cf. Rev. 20:9).

⁵³⁷Block, *The Book . . .* 48, p. 457.

38:22-23 The Lord would shower hailstones, lightning, and burning sulfur, probably from erupting volcanoes, on Gog and his allies (cf. Gen. 19:24; Rev. 19:21). He would also attack his armies causing bloodshed and disease (cf. Rev. 19:15). This would result in great glory for God among the nations (cf. Rev. 19:6). They would recognize Him as the only true God when He revealed Himself this way. The Lord had used Nebuchadnezzar as His sword against Israel, but He would wield this sword against Gog Himself.

Events following the defeat of the enemy 39:1-16

"Chapter 39 retells the story of Gog's attack and defeat but with a slightly different emphasis from that of the prior chapter. Not much attention is given to the attack itself (merely vv. 1-2), whereas a great deal of space is devoted to describing the massive slaughter of Gog's forces. In a sense, then, Chapter 38 concentrates on the threat from the powers opposed to God and His people, while Chapter 39 concentrates more on the deliverance of God's people from that threat. The end of the chapter dwells at length on Israel's restoration (vv. 21-29), especially on the immediate (pre-Gog) era of that restoration. Thus the chapter starts with the distant future but ends in the nearer future with the promise of return from captivity to the land of Canaan and the greater truths which that return points toward."⁵³⁸

39:1-2 The Lord again announced His antagonism toward Gog (cf. 38:2-3). He repeated that He would turn him around and bring him from the remotest parts of the North against the mountains of Israel (cf. 38:4-9, 15).

39:3-4 The Lord promised to defeat Gog there; it would be as though He knocked his weapons out of his hands. Yahweh did not reveal whom He would use to do this or how He would do it, but 38:21 suggests that at least part of the defeat would be a result of Gog's soldiers killing each another (cf. Judg. 7:22). Gog and his army and allies would fall in the Promised Land, and birds and beasts would eat their corpses (cf. vv. 17-20; Rev. 19:17-21). Such a fate was the ultimate indignity in the minds of the ancients (cf. 2 Kings 9:35).

39:5-6 Gog would fall in the open fields because the Lord had decreed His judgment. Yahweh would also destroy Gog's homeland, Magog, and the remote homelands of his allies (the coastlands, cf. 26:15, 18; 27:3, 6-7, 15, 35), and those who safely inhabited these regions. This would teach them that He is God.

39:7-8 Yahweh would also proclaim His holy reputation among the Israelites and the other nations. They would no longer regard Him as just another local deity but would recognize Him as the Holy One of Israel, the only true God who was Israel's God. This day of judgment of which the Lord had

⁵³⁸Stuart, pp. 360-61.

formerly spoken would surely come and what He had predicted would indeed happen (cf. 38:17).

39:9-10 After the Lord destroyed the forces of Gog, the Israelites would use the enemy's numerous implements of warfare for fuel for seven years. The Israelites would not need to burn traditional fuel because there would be so many old weapons and implements left to burn. They would also take as spoil what the invaders had brought into the land when they came to despoil the Israelites. God would turn the tables on the invaders.

As in much apocalyptic prophecy (cf. the Book of Revelation), the Lord revealed to His prophet what would take place in pictures that were familiar to him (i.e., contextualized revelation). This language does not preclude the use of modern implements of warfare in the fulfillment. Here the meaning seems to be that there would be so much combustible material utilized in the invasion that the Israelites would burn it for seven years.

39:11 The Israelites would also bury Gog and his soldiers in a valley east of the Mediterranean Sea. This probably means that multitudes of the enemy would be buried there, not necessarily Gog personally (cf. Rev. 19:20-21; 20:10). The slaughter would be so great that it would take a large valley to accommodate all the corpses. This valley would become known as "The Valley of the Multitude of Gog." This cemetery would be so large that travelers would not be able to pass through that part of the land. Probably the Esdraelon Valley is in view since it is east of the Mediterranean Sea and since many travelers normally passed and still pass through it. Furthermore it is the only major east west valley in Israel. Some commentators argued for the valley being east of the Dead Sea, but that location seems unlikely. In biblical times a major highway connecting Egypt and Mesopotamia ran through the Esdraelon (Jezreel) valley. The Apostle John identified this valley as the location of the battle of Armageddon (Rev. 16:13-16).

39:12-13 It would take seven months to bury all the corpses and so clean up this valley (cf. Lev. 5:2; 21:1; Deut. 21:1-9). Taylor assumed that the recurrence of the number seven is a sure sign that we are not to interpret this prediction literally.⁵³⁹ But because seven has symbolic significance some places in Scripture does not rule out its literal meaning in others. All the Israelites would get involved in burying the corpses, and this would receive worldwide attention and result in glory for God.

39:14-16 Special men would be responsible to search the land after seven months. When they discovered an exposed bone they would mark it so others could bury it. The name of the nearby city would then be called "The Multitude" as a tribute to Yahweh's victory.

⁵³⁹Taylor, pp. 247-48.

The ignominious end of the enemy 39:17-24

This message expands on one event that will take place at the end of the invasion (cf. v. 4).

- 39:17-18 The Lord also instructed Ezekiel to prophesy to the birds and beasts to come and feast on the flesh of the invaders who had died (cf. v. 4; Isa. 34:6; Jer. 46:10; Zeph. 1:7-8; Rev. 19:17-21). It would be like eating a great sacrifice for them, but those offered as sacrifices to the Lord would be great people of the earth rather than fat rams, lambs, goats, and bulls. Bashan, to the east of the Jordan River, consistently produced fat cattle because there was so much good pasture there.
- 39:19-20 These animals would be able to gorge themselves on the sacrifice that God would prepare for them. They would be able to eat the flesh of horses, chariot drivers, commanders, and soldiers. Normally people offered animals as sacrifices, but God would turn the tables and sacrifice people for the animals showing how little He regarded these enemies of Israel.
- 39:21-22 God's judgment of Gog would glorify Him greatly in the eyes of the rest of the world. Israel too would learn in a fresh way that He was their God (cf. the Exodus).
- 39:23-24 Then the nations would understand that it was not out of weakness that Yahweh permitted the Israelites to go into exile and die but because He was punishing them for their sins. That is why they had suffered as they had and the Lord had not responded to their cries for deliverance.

A summary of God's blessing on Israel 39:25-29

This message forms a fitting conclusion to the whole section of prophecies about Israel's restoration to the Promised Land (chs. 33—39) as well as to those about future invasion (chs. 38—39).

- 39:25-26 The Lord promised to restore the fortunes of Jacob, namely, the descendants of the devious patriarch who anticipated the corporate character of the Israelites. Obviously not all Jewish people are devious, but Scripture indicates that many of Jacob's descendants behaved as he did. The Lord promised to have mercy on all of them. He would do this because He wanted to maintain His reputation for holiness (uniqueness as the only true God). When He restored them to security in the land following this invasion they would forget their former disgrace and treachery against Him. Similarly it was when Jacob returned to the Promised Land from Paddan-aram that he experienced a life-transforming experience (Gen. 32).
- 39:27-28 When God would bring the Israelites back into the land the other nations of the world would recognize that He was different from all other gods. Also Israel would acknowledge Yahweh as her God. She would see what God had done in sending her out of the land for her sin and bringing her back permanently by His grace.

39:29 The Lord would no longer prove inaccessible to His people because He would bestow His Spirit on all the Israelites.⁵⁴⁰

There are at least eight views as to the time of this future invasion.

1. The invasion is only symbolic of the attempts of evil forces to overcome God's people.⁵⁴¹ It does not describe a real battle but in the language of warfare pictures the triumph of good over evil, the forces of God over those of Satan. The amount of detail and specific references to places and times in this prophecy argue against this view.⁵⁴²
2. It will occur before the Tribulation, either before the Rapture or at the time of the Rapture or just after the Rapture.⁵⁴³ But the prophecy sets the time of this invasion after God has restored Israel to her land (cf. 38:8, 16). Ezekiel 36:26-28 and 39:26-29 indicate that Israel's restoration will involve spiritual regeneration as well as physical return, so the present return of Jews to the State of Israel cannot be the fulfillment.
3. It will happen during the Tribulation (cf. Dan. 11:40-41; Rev. 14:14-20). For three and a half years Antichrist will encourage the Jews to return to Palestine, but then he will break his covenant with them and begin to attack them (Matt. 24:15-22; Dan. 9:27; 11:40-41). Thus Israel will enjoy a period of peace in the Tribulation. It is during the first half of the Tribulation, toward its end, that advocates of this view place the fulfillment of this prophecy.⁵⁴⁴ Ezekiel 39:7 says that following this battle the Lord's name will be profaned no longer, but during the second half of the Tribulation it will be profaned (cf. Rev. 13; 16:9, 11, 21). It also seems unlikely that the Jews could bury corpses for seven months and burn weapons as fuel for seven years following an invasion in the middle of the seven-year Tribulation. The last half of the Tribulation will involve unparalleled persecution for the Jews (Dan. 9:27).
4. It will take place at the end of the seven-year Tribulation (the battle of Armageddon; cf. Zech. 12; 14:1-4; Rev. 19:11-21).⁵⁴⁵ Some advocates equate Gog with the king of the North (Dan. 11:40). Some of Ezekiel's descriptions of Gog's invasion recur in Revelation 19:17-21, which describes the end of the

⁵⁴⁰See Cooper, p. 349, for a helpful chart contrasting nine ideals present in Eden, lost in the Fall, and restored to Israel in the future, drawn from chapters 33—39.

⁵⁴¹E.g., Allen, *Ezekiel 20—48*, p. 210; and Stuart, p. 352.

⁵⁴²For further arguments against this view, see Feinberg, p. 219.

⁵⁴³E.g., David L. Cooper, *When Gog's Armies Meet the Almighty: An Exposition of Ezekiel Thirty-eight and Thirty-nine*, pp. 80-81.

⁵⁴⁴E.g., J. Dwight Pentecost, *Things to Come*, pp. 350-52; Dyer, "Ezekiel," p. 1300; idem, in *The Old . . .*, p. 691; and Wiersbe, pp. 232-36.

⁵⁴⁵Feinberg, pp. 218-19, 230-31; H. A. Ironside, *Ezekiel*, p. 265; W. Kelly, *Notes on Ezekiel*, pp. 200-201; Louis S. Bauman, *Russian Events in the Light of Bible Prophecy*, pp. 174-77. Harold W. Hoehner, "The Progression of Events in Ezekiel 38—39," in *Integrity of Heart, Skillfulness of Hands: Biblical and Leadership Studies in Honor of Donald K. Campbell*, pp. 82-92, argued that Ezekiel 38 refers to events in the middle of the Tribulation and chapter 39 to events at the end of the Tribulation.

- Tribulation. However other aspects appear in Revelation 20:7-10, which describes the end of the Millennium. Israel is dwelling securely in the land that Gog will invade, but at the end of the Tribulation Israel will have been under intense attack for three and a half years (Dan. 9:27).
5. It will happen between the end of the Tribulation and the beginning of the Millennium.⁵⁴⁶ Since Jesus Christ's return to the earth will end the Tribulation and begin the Millennium, it does not seem that there will be enough time for the invasion of Gog and its consequences then (cf. 39:1-16; Matt. 13:41). Furthermore some of the allusions to this invasion in Revelation suggest a time at the end of the Millennium (Rev. 20:7-10). John F. Walvoord believed that the rebellion of Gog will occur before the Millennium, but did not say exactly when.⁵⁴⁷
 6. It will happen at the beginning of the Millennium. This seems highly unlikely since all who enter the Millennium will be believers who have assisted the Jews (Matt. 25:31-46). Moreover all weapons of war will be destroyed at the beginning of the Millennium (Mic. 4:1-4).
 7. It will occur at the end of the Millennium.⁵⁴⁸ Revelation 20:8 refers specifically to Gog and Magog in a context describing the end of the Millennium. Israel dwelling in safety in her land, the situation described repeatedly in Ezekiel 33—39, fits conditions at the end of the Millennium. Rabbinic writers identified Gog and Magog as the final enemy that will attack Israel in the messianic age.⁵⁴⁹ Critics of this view say, Why bury the dead for seven months following the battle when the resurrection of the unsaved will follow immediately (cf. Rev. 20:11-13)? This objection assumes that these events will follow one another immediately, but the text does not say so explicitly. Why would the Israelites burn the weapons for seven years since it appears that God will create a new earth immediately after He quells the rebellion described in Revelation 20:7-10 (cf. Rev. 21:1-4)? Again, there may be time between these events that the Bible does not reveal anywhere but here. Another problem with this view is the description of the Lord calling the birds to a great feast in Revelation 19:17-21, which occurs at the end of the Tribulation.
 8. The best solution seems to me to be a combination of views 4 and 7. Apparently the fulfillment will take place in two phases, first at the end of the Tribulation and then at the end of the Millennium, when Israel is dwelling securely (cf. Rev. 19:17-21; 20:7-8).⁵⁵⁰ Ezekiel evidently described the invasion of Israel's enemies into the Promised Land as a single event, but later revelation clarifies that it will happen on two separate occasions. Part of Ezekiel's prophecy describes one of

⁵⁴⁶E.g., McClain, p. 187; and Gaebelien, p. 251.

⁵⁴⁷John F. Walvoord, *The Millennial Kingdom*, p. 331; and idem, "Revelation," in *The Bible Knowledge Commentary: New Testament*, p. 981.

⁵⁴⁸E.g., Ellison, p. 133; Davidson, p. 301; Merrill, p. 380; and Chisholm, *Handbook on . . .*, p. 282.

⁵⁴⁹See Fisch, p. 253.

⁵⁵⁰E.g., L. Cooper, pp. 336-37; Alexander, "Ezekiel," p. 940; and Robert L. Thomas, *Revelation 8—22*, p. 394.

these invasions, part the other, and some of it describes both incidents. Gog then does not describe a single individual but two people both of whom share similar plans. In the first fulfillment Gog is the king of the North. In the second he is the human leader who will lead the rebellion at the end of the Millennium.

It seems unnatural for God to describe as one battle one that will have two parts separated by 1,000 years, and there is certainly no indication in Ezekiel that Gog's invasion will have two phases. However, in view of later clarification in the Book of Revelation, we apparently have another instance of two events widely separated in time viewed by a prophet as one. The prophets' descriptions of the near and far destructions of Babylon (Isa. 21; Jer. 51), the two advents of Messiah (Isa. 61:1-2), and the coming of two persecutors of the Jews (Antiochus Epiphanes and Antichrist; Dan. 11:21-35, 36-44) are other examples of this "foreshortened" view of the future.

SUMMARY OF NEW LIFE FOR ISRAEL IN EZEKIEL 33—39⁵⁵¹				
New Responsibility (ch. 33)	New Leadership (ch. 34)	New Blessing (chs. 35—36)	New Nation (ch. 37)	New Victory (chs. 38—39)
Repent	King	Blessing	Nation	
The prophet's responsibility: warn (vv. 1-9, 21-33)	Contrast the false shepherds and the true shepherd.	The enemy (Edom) destroyed (35:12)	The nation of Israel restored	The nation of Israel protected
The people's responsibility: repent (vv. 10-20)	God will: <ul style="list-style-type: none"> •remove selfish shepherds (vv. 1-10) •bring His sheep into the land (vv. 11-13a) •feed them (vv. 13b-16) •judge them (vv. 17-22) •set up David (vv. 23-24) •bless them (vv. 25-30) 	The people prospering, re-gathered, and cleansed (36:10)	Bones brought to life, symbolizing Israel's national restoration	Bones of Gog's soldiers buried, expressing Israel's national protection

C. EZEKIEL'S VISION OF THE RETURN OF GOD'S GLORY CHS. 40—48

The Book of Ezekiel begins with a vision of God's glory (ch. 1), records the departure of God's glory (chs. 8—11), and ends with another vision of God's glory (chs. 40—48). This last one is the longest vision outside the Book of Revelation. This part of the book follows logically and chronologically from what has preceded. After receiving his divine commission as a prophet (chs. 1—3), Ezekiel pronounced oracles of judgment on Judah

⁵⁵¹Adapted from a handout prepared by Roy B. Zuck.

and Jerusalem for her sins (chs. 4—24). Before Jerusalem fell he also announced oracles of judgment against the foreign nations that had opposed Israel (chs. 25—32). Upon hearing of Jerusalem's fall, the prophet then relayed messages of hope for Israel explaining how God would fulfill His promises to bless the nation (chs. 33—48). The first group of these messages concerned Israel's restoration to the Promised Land (chs. 33—39). The second section in this part of the book concerns the Lord's return to His people and the changes associated with it that Israel will experience in the future (chs. 40—48). Ezekiel had announced that God would set His sanctuary in the midst of His people in the future (37:26-28). Now he revealed what it would look like and how it would function (chs. 40—46).

"Hope is the focus of these last nine chapters—hope in spite of the depressing realities of captivity in Ezekiel's day, hope based upon the revealed plan of God to move His people into a new age of blessing and close relationship to Himself."⁵⁵²

". . . Ezekiel's paradigm for the restored community put the rebuilt temple at the center of the new community."⁵⁵³

There are five parts to this revelation, all of which is bound together by the account of Ezekiel's guided tour around the temple complex. The first part is a brief introduction of the vision that Ezekiel received (40:1-4). Then he described a temple complex (40:5—42:20), the return of God to His temple (43:1-9), worship that would follow in that temple (43:10—46:24), and accompanying changes that would take place in the Promised Land (chs. 47—48).⁵⁵⁴

There have been several different conclusions about the interpretation of this section of the book that interpreters have reached as they have studied it. Four major views follow. Most of the commentators wrote extensive discussions of the interpretive options.⁵⁵⁵

1. Some have felt that what Ezekiel predicted was fulfilled when the exiles returned and reestablished life in the land. However nothing that took place after the return from Babylon matches the details of these predictions. Neither the temple built under Zerubbabel's supervision nor the temple as expanded by Herod the Great looked like what Ezekiel described here. In fact, there has been no fulfillment of these predictions in any literal sense so far in history.
2. Others have interpreted this section spiritually; they have explained these predictions as fulfilled in a spiritual sense by the church.⁵⁵⁶ This approach also fails to explain the multitude of details, such as the dimensions of various rooms

⁵⁵²Stuart, p. 367.

⁵⁵³C. Hassell Bullock, "The Priestly Era in the Light of Prophetic Thought," in *Israel's Apostasy and Restoration: Essays in Honor of Roland K. Harrison*, p. 74.

⁵⁵⁴Block, *The Book . . . 48*, charted the similarities between these chapters and Exodus 3—Numbers 35 (p. 499), the contrasts between Moses' Torah and Ezekiel's Torah in these chapters (p. 501), and Ezekiel's New Jerusalem and John's New Jerusalem (p. 503).

⁵⁵⁵See especially Alexander, "Ezekiel," pp. 942-52; L. Cooper, pp. 351-54; Feinberg, pp. 233-39, and Rooker, pp. 128-34.

⁵⁵⁶E.g., Waltke, pp. 843-44.

- in the temple complex. Ezekiel's guide was careful to make sure that the prophet recorded these details exactly (40:4). Also most interpreters who hold this view erroneously presuppose that the church replaces Israel in God's program and that all God's promises concerning a future for Israel find fulfillment in the church in a spiritual sense.
3. Still others believe these chapters describe a yet future, eschatological kingdom, but they do so only symbolically. These interpreters believe the measurements, for example, represent spiritual truth concerning the coming kingdom, but they do not look for a literal temple complex and worship.⁵⁵⁷ This view also trivializes the amount of detail, so much detail that one could almost use these chapters as general blueprints to build the structures in view (cf. the biblical descriptions of what the tabernacle and Solomon's temple were to look like). This view also tends to blur the distinction between Israel and the church. One advocate of this view, for example, took these chapters as teaching only that Israel will experience cleansing and restoration in the future by the use of detailed rhetorical cartoons.⁵⁵⁸
 4. Many take this passage as a prophecy, set in the apocalyptic literary genre, that anticipates a literal fulfillment in the future. Some of the descriptions have symbolic significance as well as literal reality, and some teach spiritual lessons. Nevertheless the revelation concerns a future temple, worship, and physical changes in the Promised Land when Israel, not the church, dwells there securely (i.e., during the Millennium).⁵⁵⁹ This is the reading of the text that seems most consistent with the rest of the book and the rest of Scripture.

The Apostle John referred to some of the things described in these chapters in connection with his description of the eternal state (life in the new earth after the destruction of the present earth; Rev. 21—22). Evidently some features of the millennial system of worship described here will carry over into the eternal state.

"Why did Ezekiel take so much space to describe the millennial temple? Here are two reasons: (1) The sanctuary was the visible symbol of God's presence among His people. The prelude to Israel's judgment began when God's glory departed from Solomon's temple in Jerusalem (Ezek. 8—11). The climax to her restoration as a nation will come when God's glory reenters the new temple in Jerusalem (43:1-5). (2) The new temple will become the visible reminder of Israel's relationship to God through His New Covenant. Since God gave detailed instructions for building the tabernacle to accompany His inauguration of the Mosaic Covenant (cf. Ex. 25—40), it is not unusual that He would also supply detailed plans for His new center of worship to accompany the implementation of the New Covenant. This temple will be the focal point for the visible manifestation of *Israel's* new relationship with her God."⁵⁶⁰

⁵⁵⁷E.g., Longman and Dillard, p. 366.

⁵⁵⁸Block, *The Book . . .* 48.

⁵⁵⁹Cf. Kaiser, p. 244.

⁵⁶⁰Dyer, "Ezekiel," p. 1304. Italics mine.

1. The setting of the vision of the return of God's glory 40:1-4

40:1 Ezekiel dated the vision that comprises the final portion of the book as coming to him on April 19, 573 B.C., more than 12 years after his immediately preceding messages (cf. 33:21-22).⁵⁶¹ This is the final dated prophecy in the book but not the last one that Ezekiel received chronologically (cf. 29:17—30:19). Ezekiel located this prophecy in time using two points of reference, in relation to the beginning of the Exile and in relation to the fall of Jerusalem. Perhaps he dated it so precisely since what this vision describes has been hard for many readers to accept at face value. Nevertheless the prophet affirmed that the Lord did indeed give it to him at this specific time.

If this vision came to Ezekiel on the tenth day of the first month of Israel's religious calendar, their month Nisan, as seems likely, it arrived just before the Jews began preparing for Passover. The Jews had a religious calendar that began with Nisan (March-April; Exod. 12:2) and a civil calendar, introduced later in Israel's history, that began six months later with Tishri (September-October). We do not know if the exiles observed the Passover, but they certainly would have been thinking about it. If the vision came to Ezekiel in the first month of their civil calendar, on October 22, it would have come on the day of Atonement and the day the year of jubilee was proclaimed.⁵⁶² That day too would have been a fitting time for the reception of this vision. The subject of this vision would have encouraged the exiles that Yahweh would fulfill His purposes for their nation as they contemplated its history and His promises.

40:2 The Lord took Ezekiel in his vision to the land of Israel and set him on a high mountain there (cf. 1:1; 8:3). Today Mount Scopus, on the north end of the Mt. Olivet ridge, rises slightly higher than the temple mount, as was true also in biblical times. Looking south Ezekiel saw a structure that resembled a city. As the vision unfolds, what he saw proved to be a temple complex with walls, courtyards, and various structures, probably on the site of Solomon's temple.

Ezekiel's transportation in a vision back to Israel amounted to a kind of homecoming for him. He had previously been in Babylon in his visions (3:14-15; 8:3; 11:24), but now the Lord took him, as He would later take all the Israelites, back to the Promised Land.⁵⁶³

40:3 Ezekiel also saw a man who appeared to be made out of bronze standing in the main gateway to this temple structure. Bronze in Scripture often represents what is strong (cf. 1 Kings 4:13; Job 40:18). The man had in his hand a length of flax (linen cord) and a rod (reed) used to measure things. He would use the rod to measure shorter distances and the cord to measure longer ones.

⁵⁶¹Parker and Dubberstein, p. 28.

⁵⁶²Allen, *Ezekiel 20—48*, pp. 229, 235.

⁵⁶³Parunak, pp. 61-62.

40:4 The man told Ezekiel to pay close attention to what he would see and hear because he needed to declare the content of his vision to the Israelites. Its details were important.

"If all God wanted to do was impress Ezekiel with 'spiritual worship,' the angel would have told him so."⁵⁶⁴

2. The millennial temple 40:5—42:20

Earlier Ezekiel hinted that there would be a future temple in the restored Promised Land (20:40; 37:24-28). Now he described it in considerable detail.⁵⁶⁵ Some of the detail is here to help the reader understand what the writer recorded later about what would happen in this complex (chs. 43—46): stage setting. This is also true of the descriptions of the tabernacle and Solomon's temple described earlier in the Old Testament. Some of the detail is here to help the reader realize that the temple being described is not one that has stood in the past; it is a future temple. This section has a basic chiasmic structure centering on the description of the inner court and the things associated with it. Ezekiel's guide led him from outside the temple enclosure, into its inner court, and then back out of the complex.

The ancient Israelites always worshipped God outdoors, in the courtyards that surrounded the temple itself. Only the priests entered the temple building. In this temple too the people had access to the outer courtyard only; the priests alone used the inner courtyard.

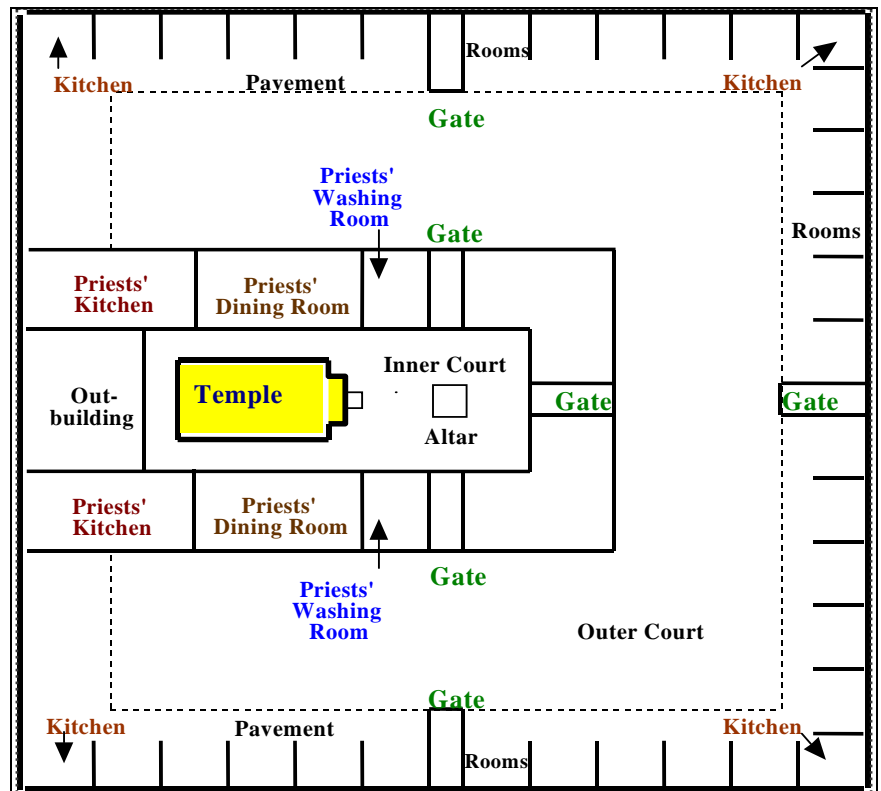

"The restored temple represents God's desire to be in the midst of his people and suggests his accessibility to them and desire to bless them (see, e.g., 48:35; Rev 21:3-4; 22:1-4)."⁵⁶⁶

⁵⁶⁴Wiersbe, p. 239.

⁵⁶⁵See also the drawings in Allen, *Ezekiel 20—48*, pp. 231, 233, 234, 258, 282, and 283; and in Block, *The Book . . .* 48, pp. 508, 509, 520, 541, 550, 565, 572, 573, 598, 603, 711, and 733.

⁵⁶⁶L. Cooper, p. 357.

The wall 40:5

The man first measured the thickness and the height of the wall around the temple complex. Measuring not only provides data but implies ownership (cf. Zech. 2:1; Rev. 11:1; 21:15); the man measured as God's representative. He used the six-cubit reed that was in his hand. The wall was six cubits (one rod) thick and six cubits high. Walls, of course, provided a barrier and guarded the holiness of God in Israel's earlier tabernacle and temple complexes.

A normal cubit was the distance between the tip of a person's middle finger and the end of his elbow, about 18 inches (Deut. 3:11). A handbreadth was about three inches. A long cubit was about 21 inches long, the length of a normal cubit plus a handbreadth. Since each of the cubits of the man's measuring rod was a cubit and a handbreadth, it seems that the cubits in view in these dimensions were long cubits (cf. 43:13). Six long cubits (one rod) equals about 10 feet.

The outer east gate complex 40:6-16

The amount of detail devoted to the descriptions of the gate complexes, both outer and inner, suggests that access into the temple will be strictly controlled.

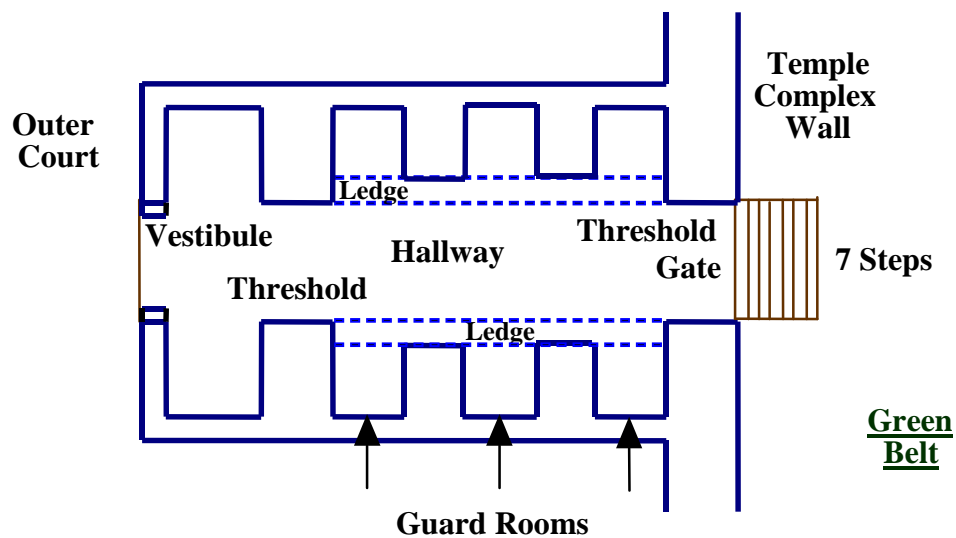

40:6 Ezekiel's guide next measured the gate of the city that faced east, that is, the gate complex. He probably measured the east gate first because it was in a direct line with the entrance to the temple building proper. Temple gates provided access but restricted that access in relation to God's presence. The threshold, the area of the gate at the top of the stairs within the wall (vv. 22, 26), was one rod (six cubits) deep (10 feet), the thickness of the wall around the whole temple compound.

40:7 Each guardroom in the gate complex was a square one rod long and one rod wide (or six cubits by six cubits, 10 feet by 10 feet, v. 12). There were six guardrooms, three on each side of the hallway through the gate

complex (v. 10). A wall five cubits thick separated the guardrooms on the same sides of the hallway from each other. Beyond these guardrooms there was another threshold that led to a large vestibule room. This threshold was the same size as the one at the other end of the passage, six cubits (10 feet) deep and 10 cubits (about 16 feet 8 inches) wide.

- 40:8-9 The vestibule stood at the far end of the gate complex and faced the courtyard. It was eight cubits (13 feet 4 inches) deep and 25 cubits (41 feet 8 inches) wide. Evidently the opening from this vestibule into the courtyard was 10 cubits (16 feet 8 inches) wide, but the "side pillars" supporting the doorframes around the opening were one cubit (1 foot 8 inches) wide on each side leaving an opening of eight cubits (13 feet 4 inches).
- 40:10 There was a total of six guardrooms in the gate complex, three on each side of the main hallway, and they were all the same size.
- 40:11 The gateway into the gate complex from the east, the main entrance, was 10 cubits (16 feet 8 inches) wide. The main hallway ("gate") was 13 cubits (21 feet 8 inches) wide.
- 40:12 Each guardroom was six cubits (10 feet) square. Evidently each one had a one-cubit-thick (1 foot 8 inch) low wall that defined each of these rooms as separate from the hallway. This low wall or ledge ran on each side of the hallway in front of the guardrooms. These rooms sometimes also served as meeting places for the city elders.
- 40:13 The interior width of the gate complex, measuring the ceiling above one guardroom, the hallway, and another guardroom, was 25 cubits (41 feet 8 inches; cf. v. 21). Evidently there were doors in the walls of the guardrooms that covered windows or niches in those walls (cf. v. 16; 41:16).
- 40:14-15 The height of the doorframes surrounding the main gate was 60 cubits (100 feet). This may seem extraordinarily tall to modern readers, but imposing gates were common in the great cities of antiquity. The gate system's walls wrapped around from the main wall of the temple enclosure to the doorjambes that framed the doorway into the courtyard (v. 9). The total length of the passageway from the front gate to the doorway into the courtyard was 50 cubits (83 feet 4 inches).
- 40:16 There were shuttered windows or alcoves in the exterior walls of the guardrooms and vestibule, perhaps creating cupboards for storing the utensils.⁵⁶⁷ Representations of palm trees decorated the doorframes, one on each side of each door (v. 26). Palm trees were symbols of beauty,

⁵⁶⁷Block, *The Book . . .* 48, p. 523.

fruitfulness, salvation, glory, and the millennial age (cf. Lev. 23:40; 1 Kings 6:29, 32, 35; 7:36; 2 Chron. 3:5; Song of Sol. 7:7; Ps. 92:12-14; Neh. 8:15; Zech. 14:16-21).

"The entire gate system resembled the multiple entry gates archaeologists discovered from the Solomonic period. There were several guard rooms (cf. 1 Kings 24 [*sic* 14]:28; 2 Chron. 12:11), or alcoves, on either side of the inner part of the Solomonic gate."⁵⁶⁸

The outer court 40:17-27

- 40:17-19 The passageway in the eastern gate complex led into a courtyard. This was the outer court that contained an inner court within it. Around the perimeter of this outer court were 30 rooms. It is not clear if they were on three sides of the courtyard or four, and it is not clear what function they served. Perhaps they were meeting or storage rooms. A pavement, probably mosaic (cf. 2 Chron. 7:3; Esth. 1:6), known as the lower pavement, formed a 50-cubit-wide (83 feet 4 inch) border around the outer edge of the outer courtyard (cf. v. 15). Ezekiel's guide measured the outer courtyard between the outer and inner gates, and this space was 100 cubits wide (about 166 feet 8 inches) on the east and north sides (and evidently on the south side too).
- 40:20-23 There was a gate complex on the north side of the wall that was identical to the one on the east (vv. 6-16). It too was 50 cubits (83 feet 4 inches) long and 25 cubits (41 feet 8 inches) wide, excluding its stairway. Seven steps led into the gate complex from the outside up to its threshold (v. 6). Looking straight through the north gate or through the east gate one could see, 100 cubits (166 feet 8 inches) beyond (cf. v. 19), another inner gate complex. Ezekiel saw two of these inner gate complexes, one on the north side of the inner courtyard and one on the east side.
- 40:24-27 The measuring man took Ezekiel to the south side of the wall where he discovered the same arrangement that he had seen on the east and north sides.

The inner court 40:28-47

This section includes descriptions of the three inner gate complexes, the rooms and implements used for preparing sacrifices, the rooms for the singers and priests, and the inner court itself.

The inner gate complexes 40:28-37

- 40:28-31 Ezekiel discovered that the south inner gate complex was the same as the outer gate complexes. All the vestibules of the three gate complexes totaled 25 cubits (41 feet 8 inches) across and each of them was five cubits

⁵⁶⁸Alexander, "Ezekiel," p. 956.

deep (rather than eight, 8 feet 4 inches rather than 13 feet 4 inches, v. 9). Also there were windows or niches on all four sides and eight steps leading up to it from the outer court (cf. v. 22). However the vestibule of this gate complex, as well as the other inner gate complexes, was facing the outer court.

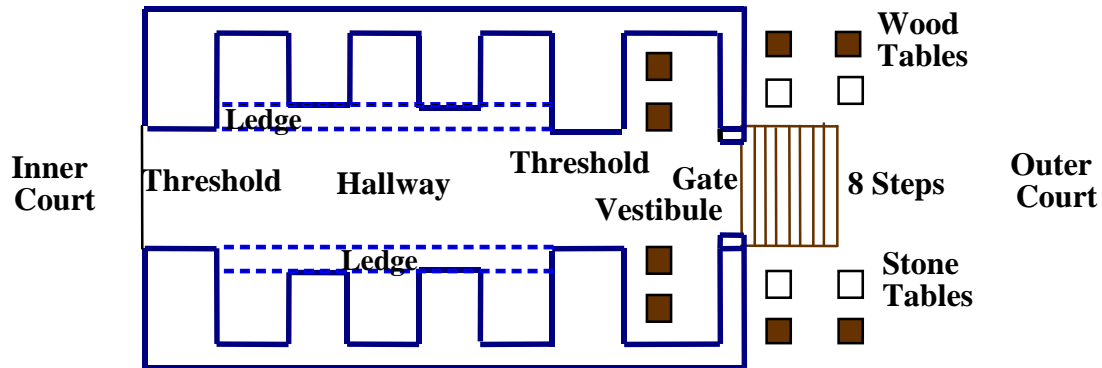

40:32-34 The eastern inner gate complex was exactly like the southern inner gate complex. Palm tree representations adorned its doorframes too.

40:35-37 There was also an identical inner gate complex on the north side.

The rooms and implements used for preparing sacrifices 40:38-43

40:38-41 Ezekiel also saw a room outside each of the three inner gate complexes close to its doorway. There priests would rinse animals brought as burnt offerings. Discussion of these offerings will follow in the section dealing with worship (43:13—46:24). Within each inner gate complex, in the vestibules, there were four tables where priests slaughtered animals brought as burnt, sin, and guilt offerings. Two tables stood on one side of each vestibule and two on the other side. There were also four tables on the outside of the northern inner gate complex, two on each side of the entrance. The north gate then had eight tables, four in the vestibule and four just outside the gate. Since Ezekiel was describing what he saw at the northern inner gate complex (vv. 35-37), it may be safe to assume that the east and south gates also had the same number of tables.

The presence of animal sacrifices in the millennial system of worship has troubled many readers. The Book of Hebrews teaches that Jesus Christ was the superior sacrifice who replaced the sacrifices of the Old Covenant (Heb. 7—10). The best explanation seems to be that in the Millennium there will be animal sacrifices, but they will look back to Christ's sacrifice even as the sacrifices of the Old Covenant looked forward to His sacrifice. They will be like the Lord's Supper is for Christians, a memorial of Christ's death. The Lord's Supper, of course, will cease to be observed when the Lord comes for His church at the Rapture (1 Cor. 11:24, 26). The millennial system of worship will follow the restoration of Israel to

her land and the resumption of her prominence in God's plan (Rom. 11:25-27). These sacrifices will appropriately reflect Israelite worship (cf. 45:18-25), though there will not be a reinstatement of the Old Covenant (cf. Rom. 10:4).

Alexander believed that in the Millennium the Mosaic Covenant and the New Covenant will be operating side by side.⁵⁶⁹ The Book of Hebrews, however, argues for the replacement of the Mosaic Covenant by the New Covenant. Apparently Alexander concluded that the replacement in view applies to the present dispensation only and that in the Millennium God will reinstate the Mosaic Covenant for the Jews.

Sacrifices under the Old Covenant never took away sin permanently; they only covered sin temporarily and anticipated the ultimate sacrifice to come (Heb. 10:1-4, 10). The purpose of sacrifices under the Old Covenant was to restore the Israelites to fellowship with God, not to provide salvation. Salvation was always by faith. Even after the church began, Jewish believers did not hesitate to participate in the sacrifices of Israel (cf. Acts 2:46; 3:1; 21:26). They viewed these sacrifices as memorials of Christ's sacrifice. There could be other reasons for animal sacrifices in the Millennium besides serving as memorials, namely, cleansing from the defilement of sin and demonstrating obedience to Christ.⁵⁷⁰ Another reason will probably be to bring people together for fellowship and feasting to the glory of God.⁵⁷¹ There are several other passages that refer to sacrifices in the Millennium (cf. Isa. 56:7; 66:20-23; Jer. 33:18; Zech. 14:16-21; Mal. 3:3-4).⁵⁷²

40:42-43 In addition to these four tables outside the inner gate complex, Ezekiel saw four tables of dressed stone, each one and a half cubits (2 feet 6 inches) long, one and a half cubits (2 feet 6 inches) wide, and one cubit (1 foot 8 inches) high. Archaeologists discovered two dressed stone slaughter tables of almost the same size and design at Ebla.⁵⁷³ The ones Ezekiel saw were evidently near the other tables outside the entrance to the northern gate complex and held the utensils used for slaughtering the sacrificial animals. He also saw double hooks about three inches long hanging on the walls of the vestibule. Animal flesh was on the tables, animals that were being offered in sacrifice. Probably the hooks would hold the sacrificial meat.

The rooms for the singers and priests 40:44-46

There were two rooms for singers in the inner court. One of them stood beside the north inner gate, and its door faced south. It also accommodated the needs of the priests who

⁵⁶⁹Ibid., p. 986.

⁵⁷⁰Charles C. Ryrie, "Why Sacrifices in the Millennium?" *The Emmaus Journal* 11 (Winter 2002):309.

⁵⁷¹Wiersbe, p. 241.

⁵⁷²Cf. Charles Lee Feinberg, *Habakkuk, Zephaniah, Haggai, and Malachi*, p. 123.

⁵⁷³See P. Matthiae, *Ebla: An Empire Rediscovered*, photos between pp. 160 and 161.

were responsible for the care of the temple. The other room stood beside the south inner gate, and its door faced north. The Septuagint translators assumed that this room stood beside the south inner gate because this gives a more symmetrical arrangement. This is probably correct even though the Hebrew text locates it beside the east inner gate (cf. 42:10). This room was for the use of singers and the priests in charge of the altar (cf. 43:13-17). These priests were descendants of Zadok, the faithful high priest who served during David and Solomon's reigns (cf. 44:15; 1 Sam. 2:31-33; 2 Sam. 15:24-29; 1 Kings 1:5-26, 32-35; 2:26-27, 35; 1 Chron. 6:3-8; 24:3).

The inner court itself 40:47

The inner court, bounded by the three inner gates and the temple itself, was a square 100 cubits (166 feet 8 inches) on each side. An altar stood in this square in front of the entrance to the temple proper.

The temple and its outbuilding 40:48—41:26

It is interesting to compare this temple with the one that Solomon built (1 Kings 6—7). There are similarities but also significant differences.

The temple entrance 40:48-49

The walls that supported the doorframes leading into the vestibule of the temple were five cubits (8 feet 4 inches) deep on each side of the opening. Some medieval cathedrals in Europe also have massive, ornate entryways. These walls protruded three cubits (5 feet) from the side walls of the temple on each side. The vestibule itself was 20 cubits (33 feet 4 inches) wide and 11 cubits (18 feet 4 inches) deep. The Hebrew text always calls the longer measurement the length, regardless of its orientation. Two columns (pillars) stood at the top of the stairs on either side of the entrance to the vestibule (cf. 1 Kings 7:16-20).

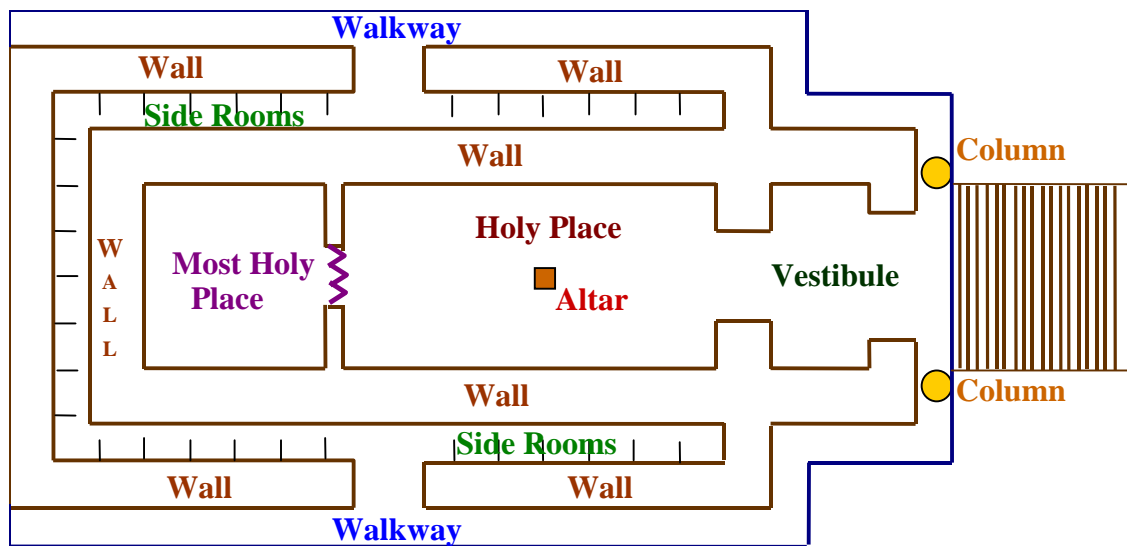

The holy place and the most holy place 41:1-4

41:1-2 Beyond the vestibule was the nave, the holy place. It had a doorway 6 cubits (10 feet) deep and 10 cubits (16 feet 8 inches) wide. The projecting wall on either side of this entrance, which also formed part of the wall of the vestibule and the holy place, projected inward 5 cubits (8 feet 4 inches) from the side walls of the main temple structure. The holy place was 40 cubits (66 feet 8 inches) deep and 20 cubits (33 feet 4 inches) wide.

41:3-4 In his vision Ezekiel's guide then went into the most holy place and measured the doorway leading into it from the holy place. This doorway was two cubits (3 feet 4 inches) deep and six cubits (10 feet) wide. The projecting wall on either side of this entrance, which also formed part of the wall of the holy place and the most holy place, projected inward seven cubits (11 feet 8 inches) from the side walls of the main temple structure. The most holy place was 20 cubits (33 feet 4 inches) square.

The effect of the progressively narrower doorways, from 14 cubits (23 feet 4 inches, 40:48) to 10 cubits (16 feet 8 inches, v. 2) to six cubits (10 feet, v. 3), focused the worshipper's eyes on the most holy place, the center of worship, and communicated increasing restriction, controlled access.

Ezekiel's guide seldom spoke to him, but when he did he always said something important. Here he identified the most holy place (v. 4; cf. v. 22; 40:4, 45; 42:13; 43:18; 46:20, 24; 47:8). Evidently Ezekiel, who was a priest, did not enter the most holy place in this vision.

The side rooms of the temple 41:5-11

41:5-6 The wall enclosing the vestibule, holy place, and most holy place was six cubits (10 feet) thick. Rooms five cubits (8 feet 4 inches) deep surrounded this wall on all sides except the east. There were three stories of these rooms, 30 rooms on each level, for a total of 90 rooms. There was another wall on the outside of these rooms that bore their weight so the inner wall of the temple did not carry it. The purpose of these rooms was not revealed, but they may be for worship, fellowship, or storage.

41:7 The rooms on the upper floor were the largest, presumably because not as much space was required for a hallway and stairs. The rooms on the second floor were not as large because more space was needed for the hallway and stairs, and the rooms on the first floor were the smallest for the same reason.

41:8 The side rooms stood on the same foundation as the rest of the temple, which was six cubits (10 feet) above the level of the surrounding courtyard.

- 41:9-10 The exterior wall of the side rooms was five cubits (8 feet 4 inches) thick, and there was 20 cubits (33 feet 4 inches) of open space between these walls and any other structures surrounding the temple proper. Other structures could not intrude on the holy space surrounding the temple.
- 41:11 Ezekiel saw a doorway in this exterior wall on the north and south sides that allowed access into the side rooms. There was a five-cubit-wide (8 feet 4 inches) walkway all around the exterior wall of the temple except on the west side (cf. v. 13). This walkway was on the same level as the top of the foundation of the temple.

The temple outbuilding 41:12

Another large building stood to the west of the temple proper 20 cubits (33 feet 4 inches) from its west wall. It was 70 cubits (116 feet 8 inches) deep and 90 cubits (150 feet) wide with walls five cubits (8 feet 4 inches) thick. Its function is unknown.

The measurements of the buildings and open spaces 41:13-15

- 41:13-14 Ezekiel's guide next measured the outside walls of the main temple structure. Each was 100 cubits (166 feet 8 inches) from front to back. The distance from the back of the main temple structure to the back of the building behind the temple, including an open space of 20 cubits (33 feet 4 inches) that separated the two structures, was also 100 cubits (166 feet 8 inches). The inner court in front of the temple proper was also 100 cubits (166 feet 8 inches) square.
- 41:15 The outside width of the building behind the temple proper measured 100 cubits (166 feet 8 inches), including a colonnade on each of its sides. The man also measured the temple's holy place and the vestibule and porch that faced the inner courtyard.

The interior furnishings of the temple 41:16-26

- 41:16-20 The whole interior of the temple structure, including the side rooms, was paneled with wood. Solomon's temple was also paneled with wood but then overlaid with gold. The wood was carved with alternating cherubs and palm trees. Each cherub had two faces, the face of a man and the face of a lion, one looking left and the other right (cf. 1:5-25; 10:9-17). Cherubim (the Hebrew plural of "cherub") elsewhere in Scripture guarded the holiness of God (cf. Gen. 3:22-24; Exod. 25:18-22; 26:31).

"In these figures aspirations of life and prosperity (palm) and security (cherubim) coalesce. In Israelite thought, the divine resident of this house was the source of both."⁵⁷⁴

⁵⁷⁴Block, *The Book . . .* 48, p. 558.

41:21-22 The doorposts between the vestibule and the holy place were square and identical. The altar in the holy place was completely wooden and was three cubits (5 feet) high and two cubits (3 feet 4 inches) square. It stood before the Lord's presence there. Its function is also obscure, but it may correspond to the altar of incense or the table of showbread in Israel's earlier tabernacle and temples. If so, it has some connection with prayer and or remembrance.

41:23-26 The doors leading into the holy place and the most holy place were double doors, hinged with two leaves for each door. These doors were also carved with cherubs and palm trees. The floor of the vestibule of the temple was also covered with wood. The vestibule also had latticed windows and representations of palm trees on its side walls. This temple will be very beautiful.

"This building was decorated in a manner befitting its role as the symbolic earthly house of the one who is 'altogether lovely.'"⁵⁷⁵

The priests' eating and dressing rooms 42:1-14

This is a very difficult section to interpret because the description of these structures is obscure in the Hebrew text.

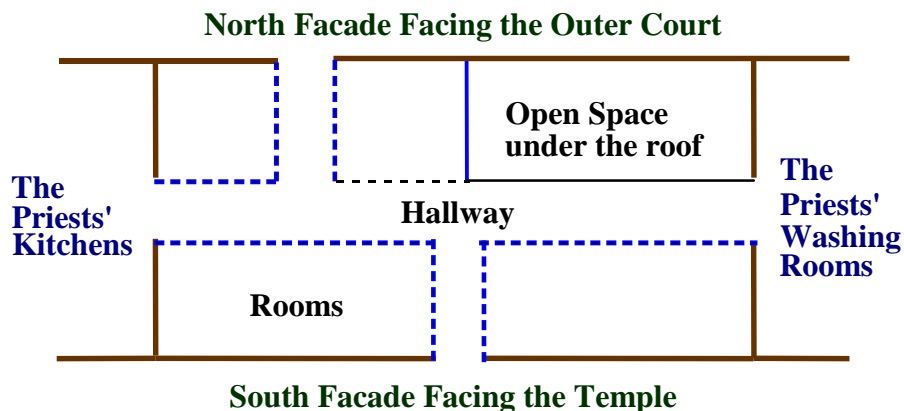

THE PRIEST'S EATING AND DRESSING ROOMS

42:1-2 Ezekiel's guide next took him out the north inner gate into the outer court and showed him another building. It stood between the "separate area," the 20-cubit (33 feet 4 inches) space that bordered the temple proper, and "the building toward the north," evidently the complex of rooms in the outer court that stood against the north wall of the temple complex. The length

⁵⁷⁵Stuart, p. 380.

of this building, east to west, was 100 cubits (166 feet 8 inches), and its width, north to south, was 50 cubits (83 feet 4 inches). This structure had a door on its north side.

- 42:3-4 There were colonnades (galleries, covered porches) outside this building facing the inner and outer courts (north and south). These matching colonnades were three stories high, as was the building itself. A 10-cubit-wide (16 feet 8 inches) interior hallway ran the length of this building east to west and provided access to the rooms.
- 42:5-6 The rooms on the third story were smaller than the ones on the first and second stories because the colonnade on the third story took more room than the colonnades on the first and second stories. The third story colonnade did not rest on the exterior walls that reached down to the ground but on top of second-story rooms. Thus the third story colonnade was set back from the exterior walls rather than flush with the ones below it.
- 42:7-9 The north facade of this building, facing the outer court, was only 50 cubits (83 feet 4 inches) wide. Perhaps the roofline was 100 cubits (166 feet 8 inches) long, and there was an open space 50 cubits (83 feet 4 inches) wide under the roof to the east of this facade. The south facade was 100 cubits (166 feet 8 inches) long, the west facade was 50 cubits (83 feet 4 inches) long, and the north facade was 50 cubits (83 feet 4 inches) long.
- 42:10-12 There was a corresponding structure on the south side of the temple proper, the mirror image of the one on the north. The Hebrew text describes this building as on the east, but it must have been on the south, as the Septuagint translators concluded, in view of the complete symmetry of the whole temple complex. It too stood between the outer court and the "separate area" and faced the temple building.
- 42:13-14 Ezekiel's guide informed him that the rooms to the north and south of the "separate area" were for the priests to use when they ate the sacrifices that people brought to the temple. Under the Mosaic Law, the priests obtained parts of the burnt, grain, peace, sin, and trespass (guilt) offerings (Lev. 6-7). In the future, priests will receive parts of the grain, sin, and trespass offerings at least. The priests would deposit the offerings in these rooms. They were also dressing rooms for the priests since they could not go from the "separate area" or the inner court into the outer court without changing their clothes. In view of this statement, there must be access into each of these two buildings from the "separate area" as well as from the outer court.

"The burden of the present account is to show that the holiness of sacred space extends beyond the concentric design of the temple complex to the

form of the auxiliary structures and the conduct of humans within those structures. Again the proportions of sacred space are more important than the appearance of the buildings."⁵⁷⁶

The dimensions of the temple enclosure 42:15-20

When the man had finished measuring the temple and the structures immediately associated with it, he led Ezekiel out the east outer gate. He measured the exterior of the temple wall, and it was 500 cubits (about 833 feet 4 inches) on each of its four sides (cf. Rev. 21:13). The Hebrew text has "rods" rather than "reeds." This would result in the walls being 3,000 cubits (5,000 feet) on each side and the temple enclosure being almost one mile square. This seems much larger than what the dimensions of courts and structures inside the wall picture (cf. 45:2). This enclosed area is about 18 acres, larger than 13 American football fields.⁵⁷⁷ The man measured the wall with his measuring reed. The wall around the temple area separated what was holy inside from what was common outside.

"The entire area was much too large for Mount Moriah where Solomon's and Zerubbabel's temples stood. The scheme requires a great change in the topography of the land which will occur as indicated in Zechariah 14:9-11, the very time which Ezekiel had in view."⁵⁷⁸

How do less literal interpreters understand chapters 40—42? One answer follows.

"He [Ezekiel] views it [this temple] as a metaphor for God's new work of liberation and restoration for his people."⁵⁷⁹

3. The return of God's glory to the temple 43:1-12

Having described the temple, God next revealed that He approved of it.

The vision itself 43:1-5

43:1-2 Ezekiel's guide next led him to the east gate in the outer wall. This was the wall of the millennial temple that he had been seeing and continued to see, not the wall of the Solomonic temple. There the prophet saw the glory of God approaching the temple from the east (cf. Deut. 33:2; Isa. 60:1-3). Ezekiel had seen God's glory departing from Solomon's temple to the east when the Babylonians destroyed it (ch. 8; 10:4, 18-19; 11:22-25). It did not return when Zerubbabel rebuilt it or when Herod the Great remodeled it (cf. Hag. 2:7). But now the Lord was about to take up residence in His millennial temple. God's voice was as the sound of a mighty waterfall

⁵⁷⁶Block, *The Book . . .* 48, p. 568.

⁵⁷⁷Stuart, p. 384; Dyer, "Ezekiel," p. 1308.

⁵⁷⁸Feinberg, *The Prophecy . . .*, p. 249.

⁵⁷⁹Allen, *Ezekiel 20—48*, p. 235.

(powerful and majestic; cf. 1:24; Rev. 1:15; 14:2), and His glory illuminated the land as it passed over it (cf. Exod. 34:29-30, 35; Mark 9:3; 2 Cor. 4:6; Rev. 1:16; 18:1).

An interesting foreview of the departure and return of God's glory occurred when God's glory departed with the ark of the covenant into the Philistine camp (1 Sam. 4:19-22) and then returned when David brought the ark into Jerusalem (2 Sam. 6:17-19). Another parallel is Jesus' departure from Jerusalem in His ascension and His return to it at His second advent, both events happening on the Mount of Olives east of Jerusalem.

43:3 This vision reminded Ezekiel of the vision of God that he had seen by the river Chebar (1:3), when he saw God coming to judge Jerusalem (cf. 1:4-28; 9:1, 5; 32:18). He responded by prostrating himself before the Lord again (cf. 1:28; 3:23).⁵⁸⁰

43:4-5 Yahweh's glory entered the temple through the east gate, the same gate through which Ezekiel had formerly seen it leave the city. The Holy Spirit transported Ezekiel in his vision to the inner court, and there he saw that God's glory had filled the temple (cf. Exod. 24:9-17; 34:29-30; Luke 2:8-10). Similarly the glory of God had come upon and filled the tabernacle at its dedication (Exod. 40:34-35) and Solomon's temple at its dedication (1 Kings 8:10-11; 2 Chron. 5:13-14; 7:1-3).

The significance of the vision 43:6-12

43:6 The prophet heard someone speaking to him from the temple, and there was a man, probably Ezekiel's guide, standing beside him (cf. 1:16).

43:7-8 The one speaking from the temple, undoubtedly the Lord, told Ezekiel that the temple was His throne, the place where He would rest His feet (take up residence) and live among the Israelites forever (cf. 1 Kings 8:12, 13, 27; 1 Chron. 28:2; Ps. 99:5; 132:7; Isa. 66:1; Jer. 3:17; 17:12). He announced that the Israelites and their leaders would no longer defile His holy reputation (cf. 39:7). They had done this by their religious prostitution and spiritual unfaithfulness to Him and by burying some of their kings too close to the temple precincts (cf. 1 Kings 21:19, 24-26). They had built their defiling graves too close to the temple, with only a wall between, not allowing some distance between them (sacred space) to honor God's holiness. The Israelites had formerly defiled His name by their sinful acts that were abominable to God (cf. 8:1-18). That was the reason He had burned them in judgment. He had been angry with them.

⁵⁸⁰See Michael Fishbane, "Through the Looking Glass: Reflections on Ezek 43:3, Num 12:8 and 1 Cor 13:8," *Hebrew Annual Review* 10 (1986):63-75.

43:9 If the Israelites would put away their harlotry (physical and spiritual) and would refrain from burying their dead too close to holy ground, the Lord promised to dwell among them forever. While the place of burial may seem insignificant to modern Westerners, it was important to ancient Near Easterners since it expressed respect or disrespect.

This is one of many places in which a prophet conditioned the coming of God's kingdom on Israel's repentance (cf. Hag. 2:4-7; Zech. 12:10—14:9; et al.). The prophets presented the coming of the kingdom as contingent on the sovereignty of God and the enablement of the Holy Spirit as well.⁵⁸¹

43:10-11 The Lord instructed Ezekiel to describe the temple that he had seen in his vision to the Israelites. It would so impress them with the glorious future that God intended to give them that they would feel ashamed of their iniquities. They should examine the plans of the future temple carefully because they would inspire obedience in the people. If the exiles responded positively to Ezekiel's revelation, they should study the vision carefully and conform to the instructions that accompanied it. Ezekiel was about to receive information about what the Israelites should do. So far the vision dealt with what they would see.

43:12 The overriding lesson of the vision was that holiness was to permeate everything connected with the future of the mountain-top temple.

4. The temple ordinances 43:13—46:24

Instructions (statutes) designed to maintain holiness in the new temple follow. The Lord specified how His people were to construct the new altar to accommodate sacrifices (43:13-17) and how they were to dedicate it (43:18-27). He revealed how they were to use the temple (44:1-9), how the priests were to function (44:10-31), and how the sacred land district was to be used (45:1-8). An exhortation to Israel's leaders forms the center of this section (45:9-12). The rest of it contains instructions for the worship leader (45:13—46:18) and directions for the use of the priests' kitchens (46:19-24).

"The existence of the millennial temple and the reinstatement of the sacrificial system [though not necessarily the reinstatement of the Mosaic Covenant] is not only understandable but predictable. Ezekiel's vision of a restored sacrificial system was really not so amazing after all. The millennium will afford Israel the opportunity for the first time in its history to use the symbols of their covenant with Jesus as Messiah in view. It will be their first time to be a kingdom of priests and a holy nation showing forth to the world the redemptive work of Yahweh in the person of Jesus Christ the Messiah (Isa 53:7; 61:1-3; Zech 4:1 [*sic* 3:10]; John 1:29; Acts 8:32-35; 1 Pet 1:19; Rev 7:13-14; 5:9; 13:8; 15:3)."⁵⁸²

⁵⁸¹See Stanley D. Toussaint and Jay A. Quine, "No, Not Yet: The Contingency of God's Promised Kingdom," *Bibliotheca Sacra* 164:654 (April-June 2007):131-47.

⁵⁸²L. Cooper, p. 381.

The altar of sacrifice 43:13-17

Some scholars view this section as the central one in chapters 40—48.⁵⁸³ The altar was at the very center of the whole temple complex, and it was the centerpiece of the system of worship represented in the new temple complex.

43:14 The square altar rose above its foundation in three tiers, the largest one below, the next largest one above it, and the smallest one on top. The first, largest stage was two cubits (3 feet 4 inches) high and one cubit (20 inches) smaller than the foundation on each of its four sides. The second tier was four cubits (6 feet 8 inches) high and one cubit (20 inches) smaller than the first tier on each of its four sides.

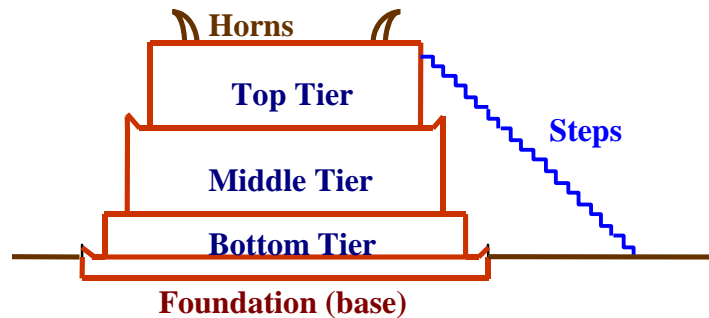

43:15-16 The third tier, which formed the altar hearth, the very top of the altar, was also four cubits (6 feet 8 inches) high. Four horns stood on the top of the altar, one at each corner undoubtedly, symbolizing strength. This tier, the hearth, was 12 cubits (20 feet) wide on each side.

43:17 The second tier was 14 cubits (23 feet 4 inches) square. It too had a curb around its upper edge that formed a gutter, and that curb was half a cubit high (10 inches, cf. v. 13). There were to be steps up to the altar from the east. Formerly the Lord had forbidden the use of steps leading up to His altars (Exod. 20:24, 26). The total size of this altar was about 18 cubits (30 feet) square at the bottom, 20 feet square at the top, and 16 feet 8 inches high. Solomon's brazen altar had been smaller (cf. 2 Chron. 4:1). This design made this altar resemble a small ziggurat.

The cleansing of the altar 43:18-27

43:18 The Lord told Ezekiel what to do when the construction of the altar was complete. The purpose of this altar was to receive the burnt offerings that people would bring to the Lord and to receive the blood of those animal sacrifices.

"The offerings presented thereon were meant to be memorials, much as the Lord's Supper is no efficacious sacrifice but a memorial of a blessedly adequate and all-

⁵⁸³E.g., J. G. McConville, "Priests and Levites in Ezekiel: A Crux in the Interpretation of Israel's History," *Tyndale Bulletin* 34 (1983):20-23.

sufficient sacrifice for all time. Thus, whereas the sacrifices of the Old Testament economy were prospective, these are retrospective."⁵⁸⁴

Since Old Testament saints will experience resurrection at Christ's second coming (Isa. 26:19; Dan. 12:2-3, 13), perhaps Ezekiel himself will lead this purification ceremony at the beginning of the Millennium. Alternatively the Lord may have dealt with him in the vision as He will deal with the person in charge of the real purification ceremony when it occurs.

43:19-21 Ezekiel was to give to one of the priests that would serve in this sanctuary, a priest from the honored line of Zadok (cf. 40:46; 44:15; 1 Kings 2:35), a young bull for a sin offering. He was to smear some of the bull's blood on the four horns of the altar and on the four corners of its second tier (cf. Exod. 29:12). This would cleanse the altar and make atonement for it (i.e., purify it).⁵⁸⁵ Similar ceremonies had taken place to cleanse the tabernacle and Solomonic temple altars (cf. Exod. 29:36-37; Lev. 8:14-17; 2 Chron. 7:9). Ezekiel was to burn the remainder of this bull outside the inner court (cf. Lev. 8:17).

"Cleansing was needed because everything associated with man partook of sin and therefore needed to be cleansed, especially if it was to be used in the worship of the Lord."⁵⁸⁶

43:22-24 The next day Ezekiel was to offer a ram that was free of blemishes as a sin offering. This also was part of the seven-day ritual necessary to cleanse the altar. Then he should present another bull and another ram, equally blemish free, in the inner court. The priest was to throw salt on them, slay them, and offer them as burnt offerings. Salt was an agent of purification and preservation that was often used symbolically (cf. Lev. 2:13; Num. 18:19; 2 Chron. 13:5; Mark 9:49).

43:25-26 On each of the seven days Ezekiel was to prepare a goat for a sin offering and a young bull and a ram as burnt offerings. These sacrifices also had to be without blemish, and they would make atonement and purify the altar. This seven-day ceremony would consecrate the altar for service (cf. Exod. 29:36-37).

43:27 After the completion of this consecration ceremony, from the eighth day onward, the priests were to offer burnt and peace offerings on this altar. The Lord promised to accept the worship of His people if they followed this procedure.

⁵⁸⁴Feinberg, *The Prophecy . . .*, p. 254.

⁵⁸⁵See J. Milgrom, "Sin-Offering or Purification-Offering?" *Vetus Testamentum* 21 (1971):237-39.

⁵⁸⁶Alexander, "Ezekiel," p. 971.

"Although all the offerings of Leviticus are not detailed here, it is considered by some that they are implied, and they may well be. Prospectively they all pointed to Christ, so this would be in keeping with that truth in the retrospective sense."⁵⁸⁷

Most premillennialists believe that the millennial sacrifices will be memorials of Christ's sacrifice and will have nothing to do with removing sin.⁵⁸⁸ However, some premillennialists argue that since Christ will be personally present on earth during the Millennium, these sacrifices may really purge sins, the sins of believers.⁵⁸⁹ The argument rests on the meaning of "atone." Now Christians confess our sins and receive forgiveness (1 John 1:9), but now Christ is not present on earth. When He is personally present and in closer contact with His people, it may take more than just confession to secure adequate cleansing. This may be a correct explanation for the presence of sacrifices in the Millennium, but it seems impossible to be dogmatic about that now. A third view is that the sacrifices are not literal, but that Ezekiel was describing worship in the future in terms and forms that he and his original hearers knew.⁵⁹⁰

The east gate 44:1-3

44:1-2 Ezekiel's guide next took him back to the east outer gate (cf. 40:6-16). The gate itself, on the east side of the gate complex, was shut and was to remain shut. The Lord told the prophet that this gate was shut because He had entered the temple complex through it (43:1-3). Its sealed condition guaranteed God's promise that He would never depart from the temple again (37:24-28).

"As a mark of honor to an Eastern king, no person could enter the gate by which he entered . . ." ⁵⁹¹

This is not the eastern gate of Zerubbabel's or Herod's temple (Israel's second temple); there is no evidence that either of those gates was closed. Nor is it the gate on the east side of the temple enclosure in modern Jerusalem that has been sealed for centuries. The dimensions are different. It is the east gate of the millennial temple.

⁵⁸⁷Feinberg, *The Prophecy* . . . , p. 256. See also McClain, pp. 249-51.

⁵⁸⁸E.g., Ibid., p. 254; Walvoord, *The Millennial* . . . , pp. 312-14; and Clive A. Thomson, "The Necessity of Blood Sacrifices in Ezekiel's Temple," *Bibliotheca Sacra* 123:491 (July 1966):237-48.

⁵⁸⁹E.g., Charles C. Ryrie, *Dispensationalism Today*, p. 127; Jerry M. Hullinger, "The Problem of Animal Sacrifices in Ezekiel 40—48," *Bibliotheca Sacra* 152:607 (July-September 1995):279-89; idem, "The Divine Presence, Uncleaness, and Ezekiel's Millennial Sacrifices," *Bibliotheca Sacra* 163:652 (October-December 2006): 405-22; idem, "The Function of the Millennial Sacrifices in Ezekiel's Temple, Part 1," *Bibliotheca Sacra* 167:665 (January-March 2010):40-57; idem, "The Function of the Millennial Sacrifices in Ezekiel's Temple, Part 2," *Bibliotheca Sacra* 167:666 (April-June 2010):166-79; idem, "The Compatibility of the New Covenant and Future Animal Sacrifices," *Journal of Dispensational Theology* 17:50 (Spring 2013):47-64; and O. T. Allis, *Prophecy and the Church*, pp. 247-48.

⁵⁹⁰E.g., Ironside, p. 305; and Keil, 2:417.

⁵⁹¹Feinberg, *The Prophecy* . . . , p. 257.

"The eastern gate that overlooks the Kidron Valley today is closed as it has been since the Crusades, nearly a thousand years ago. Crusaders walled up the gate because they believed that Jesus entered the temple mount by this gate on Palm Sunday and that it should be closed until he returns to reenter the temple mount. Zechariah 14:4-5 presents the Messiah coming to the valley on the eastern side of the temple in preparation for his entry into the temple area. This has been regarded as biblical evidence that the gate should remain closed until Jesus returns.

"Today the eastern gate, also called the Golden Gate, is a significant holy site for three major world religions, Judaism, Christianity, and Islam. Jews believe that when the Messiah comes he will open the east gate and enter the temple mount first and then enter the city of Jerusalem. Moslems believe that the gate is the site of final judgment and call it the gate of heaven and hell. They believe the final judgment of humanity will take place before the eastern gate and the redeemed are those who will be allowed to enter the temple mount; all others will be outcasts."⁵⁹²

The Romans destroyed the wall around Jerusalem in A.D. 70. The present Golden Gate dates back to the seventh century A.D. The Crusaders walled it up in the eleventh century. The Ottoman Turks partially destroyed it and then repaired it in the early sixteenth century. The Turkish governor then walled it up again in A.D. 1530, and it has remained closed ever since.⁵⁹³

44:3 A prince (king) who would rule over the Israelites would sit in this gate complex and eat sacrifices to the Lord there (cf. 34:24; 37:25; 46:2, 8-10). Jesus Christ will be the King of Kings. He will rule over many kings including this king (prince). The city gate was a place of civil and judicial business in the ancient world (cf. Ruth 4:1-11). It was where the elders of the city assembled to discuss and transact important matters. Therefore sitting in this gate pictures the prince as an administrator of the temple area. He would go in and out of the gate complex by way of the vestibule at its west end, but no one would be able to enter or exit the outer court through the gate at the east end of this structure.

This prince (Heb. *nasi*) is not Messiah. This becomes clear later when the writer described him as presenting a sin offering for himself, something that it is impossible to imagine Jesus Christ doing (45:22; cf. Heb. 4:15; 9:22-28). Furthermore, this leader will produce natural children, another

⁵⁹²L. Cooper, p, 388.

⁵⁹³Ibid., p. 389.

extremely unlikely action for Messiah (46:16). Third, he is not a priest and exercises no priestly rights, whereas Jesus Christ is now and ever will be our great high priest. Ezekiel mentioned no high priest in his revelation of the millennial priests. Jesus Christ will fill that role (Heb. 5:6, 10; 6:20; 7:3, 17; 8:1). Rather, this prince will function in an intermediate status between the priests and the people (cf. 45:13-22; 46:2, 10, 18; 48:21-22). The exact identity of this leader is presently unknown, but he will apparently function as Messiah's administrative representative in charge of certain affairs in the Millennium.⁵⁹⁴ Some believe he will be King David resurrected.⁵⁹⁵ This person appears in every chapter in Ezekiel that follows except chapter 47.

The ordinary priests and their service 44:4-14

The emphasis on the holiness of God that has marked this vision continues strong in this pericope and the next. God's holiness will determine who serves as priests and how they serve.

44:4 The guide proceeded to take Ezekiel through the north inner gate into the inner court of the temple. There he saw again the glory of the Lord that filled the temple proper, and he prostrated himself before it out of fear and reverence (cf. 1:28; 43:1-5).

"The new reference to the glory of God simply makes clear that it is the return of God to the temple that serves as a basis for the regulations to follow."⁵⁹⁶

44:5 The Lord spoke to Ezekiel and instructed him to pay close attention to all the instructions that he would receive concerning worship in the temple (cf. 40:4). He needed to give special attention to the entrances leading to the temple proper because it was there that the common life of the people interfaced with the holiness of the inner sanctum.

44:6-9 Ezekiel was to tell the rebellious Israelites that the Lord had had enough of all their abominations, particularly profaning His Jerusalem temple. They had brought unbelievers into the temple, and they had misused the food brought as sacrifices to Him. They had even appointed foreigners to take care of the temple instead of taking care of it themselves.

"The religions of the ancient Near East frequently used foreign captives as temple servants to aid the priests."⁵⁹⁷

⁵⁹⁴See E. A. Speiser, "Background and Function of the Biblical *Nasi*," *Catholic Biblical Quarterly* 25 (1963):111-17; and J. D. Levenson, *Theology of the Program of Restoration of Ezekiel 40—48*, pp. 61, 67.

⁵⁹⁵E.g., Dyer, in *The Old . . .*, p. 696. See my comments on 34:24 and 37:24-25.

⁵⁹⁶McConville, p. 18.

⁵⁹⁷Alexander, "Ezekiel," p. 975.

The Israelites had done this, too. One of the early instances of it took place when they made the conquered Gibeonites temple servants (Josh. 9:23, 27; cf. Ezra 8:20), though there is no evidence that the Gibeonites served as priests. The Mosaic Law forbade any unauthorized person from serving in the tabernacle or temple as a priest (Num. 3:10). Believing foreigners could offer sacrifices there and assist the priests, but they could not serve as priests (cf. Num. 15:14; Isa. 56:3, 6-7; Zech. 14:21). In the millennial temple, foreigners (uncircumcised in heart and flesh, i.e., unbelieving Gentiles) would not be allowed to enter the temple proper and probably not even the temple precincts (v. 9; cf. Ezra 4:1-3; Neh. 13:1-9; Acts 21:27-31).

44:10-12 Most of the Levitical priests, who had been responsible for profaning the temple in the past, would have to bear the punishment for their iniquity. They would be able to minister in the temple by overseeing the gates and serving in the temple precincts in other ways, perhaps as foreigners had done previously. They could also slaughter the sacrificial animals at the inner gate complexes (cf. 40:38-43). Under the Mosaic system of worship, the offerer, rather than the priest, killed the sacrificial victim. However, since the Levitical priests had led in the ritual worship of idols and so caused the other Israelites to stumble in their walk with God, the Lord would judge them by limiting their service in the millennial temple.

44:13-14 They would not be able to approach the Lord and serve Him; they could only serve the people. They would not be able to handle what was most holy, most closely associated with the Lord, in the temple. This would be a source of shame for them because of their former sins. Yet within this limitation the Lord promised to allow them to be in charge of the temple structure, its maintenance, and certain things that transpired there. The Levites in Solomon's day had more responsibility (cf. 1 Chron. 15:16; 16:4; 23:28-31).

"They have their counterparts today in all aspects of church life and doubtless then, as now, many reckoned it a privilege to be attending on the people of God in the more mundane details of their religion. After all, they were doing their duties by divine appointment (14)."⁵⁹⁸

The Zadokite priests 44:15-31

44:15-16 The Levites from Zadok's branch of the priestly family, however, would have special privileges since Zadok and his sons had served the Lord faithfully in the past (cf. 40:46; 1 Sam. 2:35; 2 Sam. 8:17; 15:24-29; 1 Kings 2:26-35; 1 Chron. 6:7-8). They would be able to approach the Lord Himself and minister to Him by presenting the sacrifices of the people to Him. They had permission to enter the temple proper, to place sacrifices

⁵⁹⁸Taylor, p. 271.

on the "table" (the altar, 40:46, and or the table in the holy place, 41:22), and to fulfill what God commanded concerning His worship.

"In every age the sovereign and gracious God has a remnant of those who cleave to Him in spite of adverse circumstances and the mounting pressures of the majority to conform. The Zadokite priests kept themselves from the idolatry of the nation, even though the other priests complied to the idolatrous desires of the disobedient people. For this faithfulness the reward from the Lord will be access to His presence, the privilege of ministering in any and all phases of priestly duty."⁵⁹⁹

Allen believed God gave this revelation to settle disputes about the staffing of the post-exilic temple.⁶⁰⁰

- 44:17-18 The Zadokite priests would need to wear linen, not wool, garments when they served the Lord in the temple sanctuary and the inner gates and court (cf. Exod. 28:42; Lev. 16:4; Rev. 19:8). This included linen turbans and undergarments. No fabric that caused them to sweat would be acceptable because perspiration would make them wet, and dry skin stays cleaner than sweaty skin. Wool may have been an unacceptable material too because it is a product of animals, whereas linen comes from plants.⁶⁰¹
- 44:19-20 When the priests went into the outer court they would first have to change their clothes in the rooms designated for that purpose (42:1-14) so they would not transmit what was holy to what was common (cf. Lev. 6:11). Contact with holy things consecrated those things and brought them under the restrictions governing holy things (cf. Exod. 29:37; 30:29; Lev. 6:27; Hag. 2:12). They were also to keep their hair trimmed, not let it grow long or shave it all off. Long hair signified mourning, and pagan, idolatrous priests used to shave all their hair off as a sign of mourning (cf. Lev. 10:6; 21:5-6, 10).
- 44:21-22 Moreover the priests were not to drink wine before they came into the inner court (cf. Lev. 10:9), nor were they to marry a widow or a divorced woman. They could only marry virgin Israelite women or the widows of former priests. Under the Mosaic system these marrying restrictions bound only the high priest (cf. Lev. 21:7, 14), but under the millennial system they will apply to all Zadokite priests.
- 44:23 Part of the priests' job would be to teach the people the difference between the holy and the common, and between the unclean and the clean. The people would learn this difference as they observed the distinctions

⁵⁹⁹Feinberg, *The Prophecy* . . . , p. 260.

⁶⁰⁰Allen, *Ezekiel 20—48*, p. 262.

⁶⁰¹Wevers, p. 321.

prescribed here and as the priests explained them to them (cf. 22:26; Lev. 10:10-11; 11:47; Deut. 33:10).

"The priests were by their lives to be examples of separateness; their ritual holiness was intended to promote ethical holiness among the people they were called to serve.⁶⁰²

This is also the duty of believer priests today (1 Pet. 1:13-16).

44:24 The Zadokite priests were also to serve as judges for the people and to make decisions in harmony with the Lord's laws (cf. Deut. 17:9; 19:17; 21:5). Not only will the prince serve as an administrator under Messiah (v. 3), but the priests will also serve under His authority.⁶⁰³ They themselves would have to keep His laws and His rules concerning the appointed feasts, and they would have to observe the Sabbath Day. While observance of the Sabbath Day is not part of the New Covenant law of Christ, God will reinstitute it during the kingdom dispensation.

What God told people they could eat in various dispensations also differed. Before the Fall, God told Adam and Eve that they could eat any plants in the Garden of Eden except the fruit of the tree of the knowledge of good and evil (Gen. 1:29; 2:17-18). After the Fall, they and their descendants continued to be vegetarians. Then He told Noah that he and his descendants could eat animals as well as plants (Gen. 9:3). Under the Mosaic Law God proscribed certain foods as unclean. But later Christ declared all foods clean (Mark 7:19; cf. 1 Tim. 4:3). Even though the Sabbath Day was the sign of the Mosaic Covenant (Exod. 31:13, 17), reinstatement of Sabbath observance does not necessarily involve reinstatement of the whole Mosaic Covenant.

44:25-27 The Zadokite priests would not be able to have any contact with a dead corpse except in the case of their own immediate families (cf. Lev. 21:1-3). People will die during the Millennium (cf. Isa. 65:20), but no one will die in the eternal state (Rev. 21:4). After his initial cleansing from the defilement caused by contact with a corpse, the priest would have to wait seven days before resuming his priestly duties (cf. Num. 19:11-19). On his first day of service after his cleansing, he would have to go into the inner court and offer a sin offering for himself.

44:28-29 These priests would receive no other inheritance in the land but the privilege of serving the Lord in the special ways that He permitted. The Lord would designate a portion of the land in which they would live (45:4;

⁶⁰²Taylor, p. 272.

⁶⁰³See Douglas K. Stuart, "The Prophetic Ideal of Government in the Restoration Era," in *Israel's Apostasy and Restoration: Essays in Honor of Roland K. Harrison*, pp. 283-305.

48:10-11), but this was not their inheritance. The perquisites of this inheritance would include the privilege of eating parts of the best grains and animals that the people brought to the Lord as sacrifices (cf. Deut. 25:4; 1 Cor. 9:9-12; 1 Tim. 5:18). Everything that the people would bring as offerings to the Lord would go to them. These were "devoted" (Heb. *herem*) things, things given that the offerer could not redeem (buy back; cf. Lev. 27:21, 28; Num. 18:14).

44:30-31 They would also receive the best parts of the firstfruits of every kind that the people brought to the Lord. The Lord would bless the people who were careful to provide the priests with their firstfruits (cf. Mal. 3:8-12; 2 Cor. 9:10-11). Priests were not to eat any animals that died a natural death or had been slain in a way other than as a sacrifice to the Lord (cf. Lev. 17:5; 22:8; Deut. 14:21). These animals might be inferior and might carry communicable diseases.

The sacred district in the Promised Land 45:1-8

The Lord next gave Ezekiel directions for the division of some of the Promised Land in the future. Revelation about apportioning the rest of the land follows later (47:13—48:35). These descriptions do not coincide with any division of the land in the past, and the amount of detail argues for a literal fulfillment in the future.

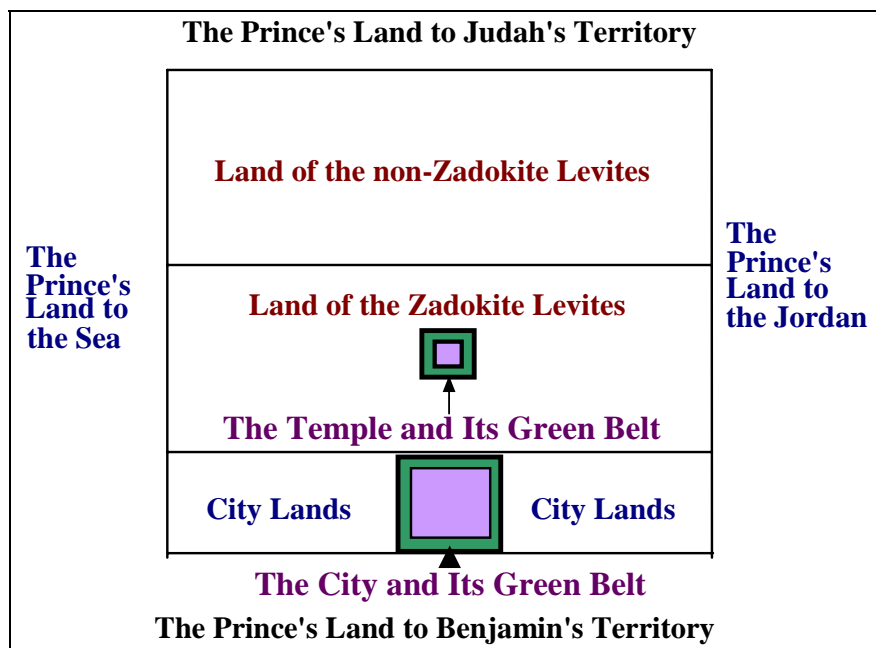

45:1 In the future the Israelites were to divide the land by lot, but the Lord, of course, would control the outcome (Prov. 16:33). This land belonged to the Lord—He was the Israelites' inheritance—but He would allow them to occupy it as He specified. They were to set aside one part of the land for the Lord's use for especially holy purposes. It was to be 25,000 cubits long

and 10,000 cubits wide (about 8.3 miles by 3.3 miles). The Hebrew text has "rods" rather than "cubits," but long cubits must be the measurement in view to harmonize with the other measurements in these chapters. This land was to be considered holy within all its boundaries.

- 45:2-4 Within this area there was to be a space 500 cubits by 500 cubits (about 833 feet by 833 feet). This was the size of the temple complex (cf. 42:20). Surrounding this complex there would be an open space of an additional 50 cubits (83 feet), a kind of green belt. This sacred space would facilitate and illustrate the holiness of the sanctuary area. The temple sanctuary would stand within this 25,000 by 10,000 cubits (8.3 miles by 3.3 miles) area and constitute the most holy part of the land. The Zadokite priests would live in the land outside the open space around the temple complex within this larger area (cf. 48:10-12).
- 45:5 The other Levites would occupy another 25,000 by 10,000 cubits (8.3 miles by 3.3 miles) area beside the one just described (cf. 48:13). It would evidently be immediately to the north. Under the Mosaic system the priests and Levites lived scattered throughout Israel, not all in very close proximity to the temple, as here.
- 45:6 Another parcel of land 25,000 by 5,000 cubits (about 8.3 miles by 1.7 miles), apparently immediately to the south, would contain the city of Jerusalem, and all the Israelites would have access to it. Later Ezekiel clarified that the city itself would occupy the center of this portion of land, and suburbs, or city lands, would flank it on the east and west (cf. 48:15, 17-19).
- 45:7 The prince (cf. 44:3) would also receive a special land allotment to the west and to the east of the city portions and the holy areas occupied by the Zadokites and the Levites (cf. 48:21-22). There was no specially designated area in which the kings of Israel lived in former times except the royal palaces, which were much smaller.
- 45:8 The rest of the Promised Land would be the portion of the other Israelites (cf. ch. 48). The whole arrangement would contribute to the equitable governing of the Israelites and would discourage rulers from oppressing the people (cf. 11:1-13; 14:1-11; 20:1—23:49; 34:1-10).

Regulations for offerings and feast days 45:9—46:24

This section contains seven subsections all of which deal with the same basic subject.

An exhortation to Israel's leaders 45:9-12

Mention of the proper leadership of the Israelites in the Millennium led to an exhortation to Israel's leaders to practice justice and righteousness in the present and in the future.

- 45:9 The Lord next commanded the leaders of the Israelites to stop destroying the people, treating them violently, and appropriating their possessions for themselves. This is a common cry in the Bible (cf. Lev. 19; 25; Num. 35; Deut. 25:13-16; Prov. 11:1; Amos 8:5; Mic. 6:10-12; Matt. 5:23-24). Rather they should treat them fairly and do what was right.
- 45:10-12 They should also be fair in their commercial dealings. Their basic dry and liquid measures, an ephah (about one-half bushel) and a bath (about six gallons), were to be standard and equal. An ephah should always be a tenth of an homer (five to six bushels), and a bath should always be a tenth of an homer (five to six bushels). Likewise weights should be the same. One shekel (about two-fifths of an ounce) should equal 20 gerahs (about one-fiftieth of an ounce). Twenty shekels plus 25 shekels plus 15 shekels (60 shekels) should equal one mina (about one and one-quarter pounds). Different commentators and Bible dictionaries vary somewhat in explaining the modern equivalents of these amounts.

". . . linear measurements of the ancient Near East were not as accurate as those of today. This is also true of volume measurements. Ezekiel delineated the proper standard of volume measure in the terms of his day."⁶⁰⁴

Offerings for the prince 45:13-17

Unlike the unfair leaders in Israel's past, the prince of the future would be faithful to the Lord and upright in his dealings with the Israelites. Messiah will be the chief ruler during the Millennium, but this prince will serve under Him and will oversee temple offerings (and probably other things).

- 45:13-15 The Israelites in the future would bring offerings to the temple periodically, but how often is not clear. The amounts that follow probably represent what they would bring for the service of the temple (cf. Exod. 30:11-16). As the following verses show, the prince would take the lead in presenting these offerings to the Lord with the assistance of the Zadokite and other Levitical priests at various times during the year.

The Lord specified that the people should bring a sixth of an ephah (one-twelfth of a bushel) of wheat or barley taken out of each homer (five to six bushels) they possessed. If their offering was oil, it should be a tenth of a bath (about 6 gallons) taken from each of their cors (about 60 gallons). Ten baths (about 60 gallons liquid measure) were about the same quantity as an homer (about 6 bushels dry measure). They were also to offer one sheep fed on Israel's well-watered pastures out of every 200 they owned. These were the quantities they were to offer in their grain, burnt, and peace offerings to make atonement for themselves on the occasions that

⁶⁰⁴Alexander, "Ezekiel," p. 982.

follow (cf. Lev. 9:7; 10:17). Making atonement signifies maintaining proper relationship with God or getting oneself back into proper relationship with God.

"The required offering for grain will be one-sixth of all produce (v. 13). One percent of the oil will be given for use in the temple (v. 14) and one of every two hundred animals (v. 15)."⁶⁰⁵

- 45:16-17 The people should bring these offerings to the prince for him to offer on their behalf on special occasions: feasts, new month celebrations, and Sabbaths. He would make these offerings for the people as a whole to secure their corporate atonement. As mentioned previously, these sacrifices would be memorials of Christ's death and or the means whereby the uncleanness of their sins as believers would be removed so they could continue to enjoy intimate fellowship with God. These sacrifices will not result in the peoples' salvation any more than the sacrifices of the Mosaic system provided salvation (cf. Heb. 10:10).

Regulations for the feasts 45:18-25

- 45:18-20 On the first new year's day of each year the people should offer a young bull without blemish to cleanse the accumulated sinful defilement of the sanctuary. The priest in charge was to apply some of the blood of a sin offering to the door frames of the temple proper, the four corners of the altar of sacrifice, and the door frames of the inner court of the temple. Another offering was to occur on the seventh day of the new year, and it would cover the guilt of sins committed ignorantly. It too would result in the cleansing of the temple for another year.
- 45:21-24 On the fourteenth day of the first month of the year the Israelites were to celebrate the Passover and then a seven-day feast using unleavened bread (cf. Exod. 12:1-14; Lev. 23:5-8; Num. 28:16-25). The same relationship between the Passover and the feast of Unleavened Bread that existed under the Old Covenant appears to exist here. The Jews celebrated the Passover after sundown on the fourteenth of Nisan. For the next seven days they celebrated the feast of Unleavened Bread. The Jews counted the beginning and ending of their days at sundown. So the whole combined festival really lasted seven days, and they often referred to it simply as Passover.

On the day of the Passover the prince would offer a bull as a sin offering for himself and the people. During the seven days of this Passover festival the prince would also offer each day seven bulls and seven rams without blemish as a burnt offering of worship and one ram for a sin offering. He would offer with each bull and each ram one ephah (about one-half

⁶⁰⁵L. Cooper, p. 400.

bushel) of grain as a grain offering plus a hin (about one gallon) of oil with the grain. This celebration will doubtless commemorate Jesus Christ's sacrificial death as the Lamb of God who takes away the sins of the world and the importance of living sin-free in view of that sacrifice.

45:25 On the fifteenth day of the seventh month, at the feast on that day, the prince would repeat the cycle of offerings he made during the Passover. This feast corresponds to the seven-day feast of Tabernacles under the Mosaic system (cf. Lev. 23:39-43; Num. 29:12-38). In the Millennium it will undoubtedly be a celebration of God's faithfulness in bringing the Israelites securely and permanently into the Promised Land, which the feast of Tabernacles anticipated.

Other feasts of Israel in the past receive no mention in Ezekiel's revelation concerning future worship: Firstfruits, Pentecost (Harvest, Weeks), Trumpets, and day of Atonement. Probably they will be absent in the future millennial system of worship. Some scholars believe that by describing only two of the feasts (Passover/Unleavened Bread and Tabernacles) Ezekiel was using a figure of speech (merism) and meant the reader to understand all the others. It is, of course, a dangerous interpretive practice to assume that the writer intended something that he did not state, especially when so much detail characterizes this portion of Ezekiel. However, this interpretation is possible.

Worship on the Sabbath and new moon days 46:1-8

46:1 The Lord specified that the gate in the inner east gate complex should be open only on Sabbath days and on the new moon days (i.e., the first of each month). All other days it was to remain closed. An exception to this rule follows in verse 12. Observance of the Sabbath day in the future, as was true in Israel's past, will remind the Israelites of God's creation of the cosmos, His creation of their nation, and His provision of rest (in the Messiah). The new moon (new month) celebrations may be periodic reminders of God's providential control of nature and His faithful provision of His people's needs, as they were in the past.

46:2 On these special days, the prince would lead the people in worship. He would enter the inner east gate complex and stand in its vestibule. Evidently he will not be able to enter the inner court because he will not be a priest (cf. Num. 28:3-8), but he will be able to view the inner court and the altar from the doorway at the western end of the gate complex. The vestibule would be the site of his worship as he presented his burnt and peace offerings (symbolizing his personal dedication and his gratitude for God's fellowship respectively). After he finished worshipping, he would depart from that gate into the outer court, but the gate would remain open until the evening.

46:3 The other worshippers would also worship at the same gate during those special days, but they too would not enter the inner court. Only priests could enter that court.

- 46:4-5 On the Sabbath days, the prince's burnt offering would consist of six lambs and a ram without blemish. Grain offerings were to accompany them: an ephah with the ram, and as much as he was able to provide with the lambs. He was also to offer a hin of oil with each ephah of grain. This is a variation of what the Mosaic Law prescribed (cf. Num. 28:9-10). These grain and oil offerings evidently symbolize the Lord's rich provisions for His people.
- 46:6-7 On the new moon days, the prince was to offer the same offerings as he did on the Sabbath days plus a young bull and an ephah of flour and a hin of oil with it. This too is somewhat different from the Mosaic requirement (cf. Num. 28:11-15).
- 46:8 The prince would enter the inner gate complex and leave it using the vestibule, which faced the outer court (cf. 40:31). Undoubtedly the priests will use the tables in the vestibule of this gate complex and the tables in the outer court near it to prepare these offerings (cf. 40:39-43).

Worship during the annual feasts 46:9-15

- 46:9 When the people living in the Promised Land came to worship on the appointed feasts (Passover and Tabernacles, cf. 45:21-25), they were to enter the outer court by either the north or south outer gate complexes. There was no gate on the west side, and the outer east gate would be sealed (cf. 44:1-2). When they finished worshipping, they should depart from the opposite gate from which they entered, not the same one. This would result in an orderly traffic pattern during these crowded times (cf. 1 Cor. 14:33).
- 46:10 The prince should accompany the people on those occasions entering and exiting the court with them. He would worship God as one of the people then, not as someone special.
- 46:11 The offerings on these special occasions were to be the same as on the Sabbath days and the new moon days (cf. vv. 4-7).
- 46:12 When the prince brought a voluntary offering to the temple on other days, either a burnt or peace offering, the priests should open the east inner gate for him to use and close it after he departed from this gate complex.
- 46:13-15 The priests were also to offer a daily sacrifice to the Lord every morning, namely, one lamb a year old without blemish as a burnt offering. One-sixth of an ephah of grain with one-third of a hin of oil mixed into it should accompany this continual daily burnt offering. Its purpose is probably to demonstrate the daily rededication of the people to the Lord, the meaning of the daily burnt offering under the Mosaic system. Under the Mosaic Law, there was a daily morning and evening sacrifice (cf. Num. 28:3-4).

The prince's gifts 46:16-18

- 46:16-17 The prince could give a gift to any of his sons out of his own inheritance from the Lord. This gift was theirs forever. However, if he gave such a gift to one of his servants, it would revert back to the prince on the year of liberty. This year would evidently be similar to the year of jubilee (every fiftieth year) under the Mosaic Covenant (cf. Lev. 25:10; 27:24). Its purpose, in the past and in the future, is to remind God's people that He owns everything and that they only occupy and manage what He has entrusted to them.
- 46:18 The prince was not to give gifts from the inheritances of the other people of the land but only from his own inheritance. Israel's leaders and people in the past had appropriated other people's property as their own (cf. 45:8-9; 2 Sam. 24:24; 1 Kings 21:19; Mic. 2:1-2). This ordinance would also result in the prince's sons remaining in his allotment of land rather than being scattered among the other tribal allotments. Since this prince would have sons it seems clear that he will not be the Messiah.

The priests' kitchens 46:19-24

- 46:19-20 The Lord, or Ezekiel's guide, then took the prophet into the structure that housed the priests' rooms that were beside the south inner gate complex that faced north (cf. 40:44, 46). This was evidently one of the two three-story structures in which the priests will eat the sacrifices and change their clothes (cf. 42:1-14). At the west side of this building there were kitchen facilities where the priests could boil the guilt and sin offerings and bake the grain offerings. They were to prepare these offerings there so they would not have to enter the outer court and thus transmit holiness to the people.
- 46:21-24 The same person then took Ezekiel out to the outer court and showed him the four corners of that court. In each of the four corners there was a courtyard 40 cubits (66 feet 8 inches) by 30 cubits (50 feet). Within each of these enclosures there were ledges with fireplaces underneath that created cooking areas where the priests were to boil the sacrifices that the people brought to the temple. Since the people would eat some of the sacrifices they brought, the outer court would be a place of both spiritual worship and social interaction. There they would enjoy fellowship with other worshippers as well as fellowship with God.

COMPARISON OF THE LEVITICAL AND MILLENNIAL SACRIFICES⁶⁰⁶	
<i>Similarities (both include:)</i>	<i>Differences (Millennial excludes:)</i>
Altar	Feast of Pentecost
Sprinkling of blood	Day of Atonement
Burnt, meal, peace, sin, and drink offerings	High priest
Priests	Ark of the covenant
Ritual cleansing	Veil
Sabbath and new moon offerings	Candlestick (menorah)
Morning sacrifices	Table of Showbread
Laws of inheritance	Evening sacrifices
Feast of Passover	
Feast of Tabernacles	
Year of Jubilee	
Temple as a place of glory	

Merrill Unger listed four purposes of Ezekiel's temple: to demonstrate God's holiness (42:1-20), to provide a dwelling place for the divine glory (43:1-17), to provide a center for the divine government (43:7), and to perpetuate the memorial of sacrifice (43:18-27).⁶⁰⁷

5. Topographical aspects of the Millennium chs. 47—48

God promised Abraham that He would give a particular piece of real estate to his descendants (Gen. 12:7). Later He reiterated this promise and became more specific about its boundaries (Gen. 15:7, 18-21; 17:8; Num. 34:1-12). He also told the Israelites that they would only be able to occupy the land to the extent that they followed Him faithfully (Deut. 7:12; 8:2). If they proved unfaithful, He would not only limit their possession of the land but even drive them out of it (Deut. 28). Ezekiel prophesied that God would bring the Israelites back into the land (36:24-30). He would give them a different attitude, and they would follow Him faithfully. Then they would finally, as never before, enjoy the full extent of the land He had promised their forefathers (cf. Deut. 30). He also promised that they would never lose possession of the land, because they would remain faithful to Him (ch. 39). The assurance of the fulfillment of these ancient promises, which date all the way back to Abraham, concludes Ezekiel. It is a fitting climax to this section assuring future blessings for Israel (chs. 33—48) following the return of God's glory to the land (chs. 40—48).

This section has two main parts: the description of a river that would flow through and heal the land (47:1-12) and the description of Israel's boundaries and tribal allotments during the Millennium (47:13—48:35).

⁶⁰⁶Adapted from a handout prepared by Roy B. Zuck.

⁶⁰⁷Merrill F. Unger, *Unger's Bible Handbook*, p. 380.

The temple river 47:1-12

47:1 Ezekiel's guide, who appears to have been his original guide in this vision (v. 3), brought him back to the main entrance to the temple proper. Ezekiel saw water flowing to the east from under the temple threshold. It apparently flowed to the south of the stairs on the right side of the temple as one faces east.

The Letter of Aristias, dated about 100 B.C., contains reference to a spring on the temple mount inside the enclosure of the temple area.⁶⁰⁸ There may already be a natural water source at this site.

47:2 The man then brought Ezekiel through the north gate to the outside of the outer wall of the temple enclosure. Just south of the east gate he saw water trickling to the east, a continuation of the stream that he had observed inside the temple enclosure.

47:3-5 The "man" took his measuring line (cf. 40:3) and measured 1,000 cubits (about one-third of a mile) east from the wall along the watercourse. He led Ezekiel across the river (Heb. *nahal*), and it was ankle deep. Another 1,000 cubits farther east they crossed again, and this time the water was knee-deep. Another 1,000 cubits, and it was up to his waist. Another 1,000 cubits, and it was so deep that they could not cross it standing up. It was so deep they would have had to swim across.

This description suggests that some major topographical changes will have occurred east of present-day Jerusalem by this time. Other revelation supports this conclusion (cf. 34:26-30; 36:8-12, 30-36; 37:25-28; 45:1-8; 48:8-14; Joel 3:18; Zech. 13:1; 14:4-8). The water will follow the contours of the altered terrain, not the past or present landscape. Zechariah recorded that the water flowing from Jerusalem will divide with half of it going west to the Mediterranean Sea and half east to the Dead Sea (Zech. 14:8). Ezekiel described only the branch that flowed east.

47:6-7 The guide made sure Ezekiel saw this. Then he brought him back to the edge of the river. Many trees were growing on both sides of the riverbank. Rivers, by their nature, give life.

47:8-9 The man explained that the river continued east and emptied into the Arabah, the Jordan valley, and eventually into the Dead Sea. Presently this involves a drop in elevation of over 3,700 feet (from the temple mount at 2,430 feet above sea level to the Dead Sea at 1,290 feet below sea level). These waters purified the waters of the Dead Sea and made it a live sea. The Dead Sea presently contains 24-26 percent minerals compared with normal seawater that contains 4-6 percent.⁶⁰⁹ This is the reason no fish or other aquatic life live in it. The water of this river would give life to all the

⁶⁰⁸Cooke, pp. 517-18.

⁶⁰⁹Ibid., p. 520.

creatures that would gather in swarms along its banks and to the fish that would swim in it.

"The Dead Sea today is a symbol of barren desolation. This future change is a visible reminder that God can turn death to life. Our God specializes in changing the unchangeable!"⁶¹⁰

- 47:10-11 The Dead Sea would become so full of many varieties of fish that fishermen would fish for them from Engedi, on the west side of the sea about midway north to south, to Eneglaim, possibly on the northwest shore near Qumran or on the eastern side. The entire Dead Sea region would not become fresh, however; the swamps and marshes would remain saline, perhaps to provide salt and or other minerals for the people.
- 47:12 Fruit trees would grow all around the Dead Sea. They do not do so now. They would remain continually healthy and productive. These trees would be so fruitful that they would bear fruit every month of the year. People would eat their fruit and use their leaves for medicinal purposes. This formerly desert region would blossom like a rose (cf. 36:35; Isa. 35:1-2, 6-7; Joel 3:18; Rom. 8:19-22).

This river is similar to two other rivers in the Bible: the river that flowed out of the Garden of Eden (Gen. 2:10) and the river that will flow in the New Jerusalem during the eternal state (Rev. 22:1-2; cf. Ps. 46:4; 65:9; Joel 3:18; Zech. 14:8). Like the river in Revelation the one in Ezekiel will flow from the throne of God; He is the source of both rivers. However, there will be a temple in the millennial earth, but there will not be one in the eternal state (Rev. 21:22). The river in Revelation also flowed down the street of the city, but Ezekiel mentioned no city to the east of the temple, just one to its south (45:6). It seems that Ezekiel and John saw two different rivers, but the purpose of both rivers was the same. God will be the source of fertility, blessing, and health in the Millennium and throughout eternity.

The river that Ezekiel saw was a real river with life-giving and healing properties. But like the rivers in Genesis 2 and Revelation 22 it also has symbolic significance. Many interpreters spiritualize the entire passage and see no literal fulfillment in the future.⁶¹¹ It represents the spiritual life and healing that flow to humanity from the throne of God (cf. John 4:14; 7:37-38).⁶¹²

"The river is like the blood of the Messiah from the cross of Calvary that began as a trickle (John 19:34). Finally, the blood, like the river, became a flood of redemption for all people (Rev. 1:5). So the flow from Calvary became a fountain of redemption for all people including Israel (see Zech 13:1-6; Rev 1:5-6). Just so, the water of life that the prophet saw coming

⁶¹⁰Dyer, in *The Old . . .*, p. 697.

⁶¹¹E.g., Taylor, p. 278.

⁶¹²See Davidson, pp. 349-50.

from the threshold came forth gently, then began to flow, and finally became a mighty river of life healing all in its wake."⁶¹³

"All blessings, material and spiritual, will emanate from the presence of the Lord with His people."⁶¹⁴

"Praise God from whom all blessings flow!"⁶¹⁵

The boundaries and principles of allotment of the land 47:13—48:35

"There are two special areas of attention in this passage: (1) the concern that God's people occupy their full boundaries, and (2) the concern that Gentiles will have an inheritance."⁶¹⁶

The boundaries of Israel's Promised Land inheritance 47:13-23

Note the similarities between Ezekiel and Moses in this section that describes the division of the Promised Land. This is another part of the new constitution for the reconstituted nation of Israel that Ezekiel revealed.

47:13-14 The Lord instructed the future Israelites (cf. v. 21) to divide the Promised Land for their inheritance. He first described the boundary around the entire land. The tribes of Joseph, namely, Ephraim and Manasseh, were to have two portions (cf. Gen. 48:5-6, 22). This was important to clarify at the outset because the tribe of Levi would receive another portion of the land (45:1-8; 48:8-14). Thus the number of tribal allotments would be 12 plus the Levitical portions. Each tribe was to have as much land as all the others; the portions were to be equal in size. This was not the case when Joshua divided the land among the tribes; some tribes received

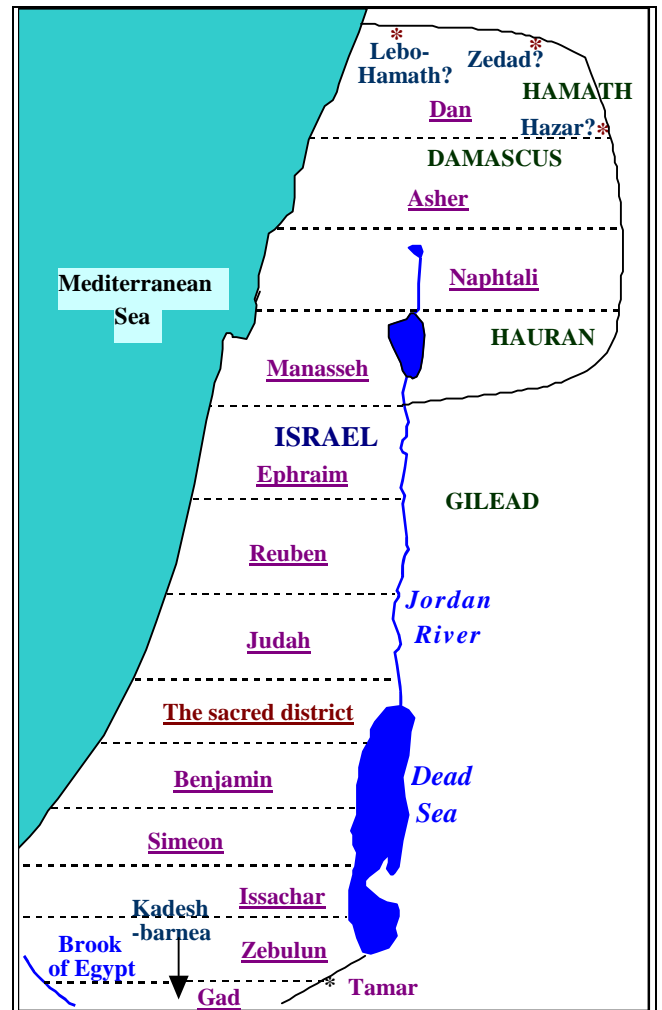

⁶¹³L. Cooper, p. 411.

⁶¹⁴Feinberg, *The Prophecy . . .*, p. 272.

⁶¹⁵The Doxology.

⁶¹⁶Stuart, p. 414.

more land than others. Thus the Lord would fulfill His promise to give the Israelites the land as an inheritance. The overall boundaries described here are almost identical to the ones in Numbers 34:3-12 (cf. 1 Kings 8:65).

47:15-17 The Lord specified the boundaries by listing place names that the Israelites of Ezekiel's day would have known. Not all of them are identifiable today.

The northern boundary would run from the Great (Mediterranean) Sea east, following the road to Hethlon, to the entrance of the town of Zedad, and through the region of Hamath (cf. 1 Kings 8:65) near Berothah to Sibram. It then ran through Hazar-hatticon (lit. the middle Hazar) on the border of the territory of Hauran. Hazar-enan (perhaps the same as Hazar-hatticon) seems to have been the easternmost town in this string. It apparently stood between the borders of the territories controlled by Damascus and Hamath. Some of these sites apparently stood within or adjacent to the region described, not just along its border.

47:18 The eastern border would run between the territories of Hauran and Damascus and then along the Jordan River between the land of Israel on the west and Gilead to the east. This boundary would continue south through the eastern (Dead) sea to the town of Tamar.

47:19 The south border would run west from Tamar to the waters of Meribath-kadesh (Kadesh-barnea), to the Brook of Egypt (Wadi el-Arish), and along this stream to the Mediterranean Sea.

47:20 The west border would be the Mediterranean Sea from the south border, the Brook of Egypt, to a point west of Lebo-hamath in the north.

47:21-23 The Israelites were to divide the land in this way for the tribes of Israel by lot (cf. 45:1). It was not to be for Israelites alone, however. Aliens who permanently lived among them could dwell in this region too. Under the Mosaic economy, resident aliens were non-Israelites who had adopted the religion and laws of the Hebrews; they had become converts to Yahweh worship. The Israelites were to regard these alien peoples as equals with themselves concerning their rights within the land. The reference to these aliens bearing children marks them as having mortal bodies in contrast to believers with immortal (resurrected) bodies who will also have access to the millennial earth (cf. Matt. 22:30; Rev. 20:4). These aliens were to inherit portions of land in the tribal allotments just like the Israelites who lived there (cf. 14:7; 22:7; Lev. 19:34; 24:22; Num. 15:29; Isa. 56:3-8).

Tribal allotments in the north 48:1-7

The tribe of Dan was to receive the northernmost section of the Promised Land. The order of tribes from north to south, north of the sacred district, was Dan, Asher, Naphtali, Manasseh, Ephraim, Reuben and Judah—seven tribal allotments of equal size (47:14). Since they will be of equal size, and since the east-west width of the Promised Land

would vary depending on the latitude of each allotment, it seems that the north-south distance would also vary somewhat.

The order of these tribes does not conform to any other in Scripture. These tribal allotments are not like those that Joshua assigned nor are they as large (cf. Josh. 14—22). There is a general progression from the most unfaithful tribe, Dan, to the most faithful, Judah. Judah, from which Messiah came, receives the blessing of being adjacent to the holy allotment. The tribes that descended from Jacob's concubines (Dan, Asher, Naphtali, and Gad) receive land to the far north and far south. Those that descended from Jacob's wives receive land toward the center of the land (cf. Gen. 35:23-26).

The holy allotment 48:8-22

- 48:8a South of Judah's portion would be a special territory, which would be the same size as the other tribal allotments.
- 48:8b-12 It would include a section 25,000 cubits (about 8.3 miles) wide, and the temple sanctuary would stand in its center. This portion would be 25,000 cubits long, from east to west, and 10,000 cubits (about 3.3 miles) wide, from north to south. It would be for the descendants of the Zadokite priests who remained faithful to the Lord. This would be a most holy place next to the territory for the other Levitical priests.⁶¹⁷
- 48:13-14 The other Levitical priests would have an allotment the same size next to the allotment of the Zadokite priests. They were not to sell or exchange any of this land for other land because it was holy to the Lord.
- 48:15-19 The remaining portion of this allotment, a section 25,000 cubits (about 8.3 miles) wide by 5,000 cubits (about 1.7 miles) north to south, would be for the holy city and the open spaces beside it. The city itself would occupy the central portion of this section. It would be for the common use of the Israelites, as would be its open spaces and home sites. The city itself would be 4,500 cubits (about 1.5 miles) square with a 250 cubit (416 feet 8 inches) open space border on each of its four sides, another green belt like the one around the temple complex (cf. 45:2). The 10,000 cubit-wide (3.3 miles) areas on the east and west sides of the city would also be for the production of food for those who lived in the city. Those who lived in the city, from all the tribes of Israel, would cultivate those fields.

"Whereas cities have always been known as places of moral corruption and rebellion, this city will be a place of eternal [millennial] rest, refuge, and personal fellowship with others and God (48:8-20, 30-35)."⁶¹⁸

⁶¹⁷See a diagram of this holy allotment within the sacred district above (near my comments on 45:2-4).

⁶¹⁸L. Cooper, p. 421.

- 48:20 The total holy allotment would be 25,000 cubits (8.3 miles) square including the city and its adjacent lands as well as the territories for the Levites and Zadokites. This is an area of almost 70 square miles.
- 48:21-22 The prince would receive the rest of this allotment, on the east and west sides of this square and between the boundaries of the tribes of Judah on the north and Benjamin on the south.

Tribal allotments in the south 48:23-29

The tribal allotments south of this special territory would fall to Benjamin, Simeon, Issachar, Zebulun, and Gad. This was the total land to be divided by lot and the tribes' individual portions.

The tribe of Benjamin received land next to the holy allotment, possibly because Benjamin was one of Rachel's sons or because the Benjamites supported David (cf. 2 Sam. 19:16-17) and allied with Judah to form the Southern Kingdom.

The city, its gates, and its name 48:30-35

- 48:30-34 The Lord next specified the gates of the holy city. Though Ezekiel did not name the city, Zechariah did. It is Jerusalem (Zech. 14:8). On each of its 4,500 cubit-long (1.5 miles) sides there would be three gates. The ones facing north would be named in honor of the tribes of Reuben (Jacob's firstborn), Judah (the kingly tribe), and Levi (the priestly tribe). All three of these patriarchs were Leah's sons. The gates on the east would bear the names of Joseph and Benjamin (Rachel's sons), and Dan (a son of Bilhah). The south gates would honor Simeon, Issachar, and Zebulun (Leah's other three sons). The west gates would bear the names of Gad, Asher, and Naphtali (all sons of the two handmaids, Zilpah and Bilhah). The many gates demonstrate the accessibility of the city.

The New Jerusalem in the eternal state will also have three gates on each of its four sides each named for one of the 12 sons of Jacob (Rev. 21:12-13). That city will also be square, but it will be a cube or pyramid (Rev. 21:16). Also it will be very much larger (1,500 miles on each side, Rev. 21:16-17). Thus it seems that the eternal city will be similar to but not identical with the millennial city.

- 48:35 The circumference of the city proper would be 18,000 cubits, less than six miles. And its name from the day of its establishment would be "The LORD is there" (Heb. *Yahweh shammah*). The new name would indicate a new character, as always in Scripture, namely, that the Lord would forever reside among His people (cf. 11:20; 37:23, 27; Gen. 17:8; Isa. 7:14; Jer. 24:7; 32:38; Zech. 8:8). He would never again depart from them or send them out of His land. He would forever dwell among them, and they would forever enjoy the unbroken fellowship with God that He intended

since the creation of the world. The Book of Ezekiel ends with a description of a New Jerusalem like Isaiah 65—66 and the Book of Revelation, though the New Jerusalem of Ezekiel is millennial and the New Jerusalem at the end of Revelation is eternal.

Twenty-two years and 48 chapters earlier Ezekiel began his book with a vision of a storm picturing the destruction of Old Jerusalem and, later (chs. 10—11), God's departure from it. He ended it with another vision of the establishment of New Jerusalem and God's permanent residence in it. The glory of the Lord is the unifying feature that ties the book together and runs through it from beginning to end.

"Ezekiel begins and ends with God. Between the great vision of God in ch. 1 and these closing words, 'The LORD is there,' is the unsparing record of man's failure and sin, judged by God. But His judgment works to His glory, and the book ends with the one thing that makes heaven what it is, the Presence of the LORD."⁶¹⁹

⁶¹⁹*The New Scofield . . .*, p.895.

End Maps

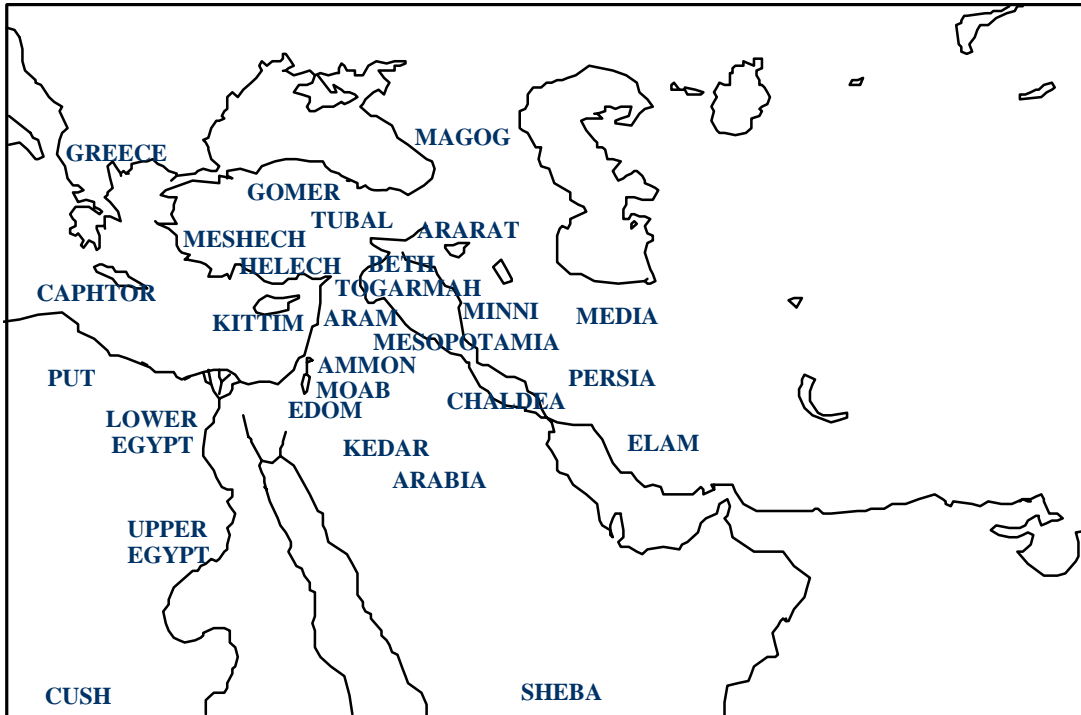

Ancient Near Eastern Nations in Ezekiel's Times

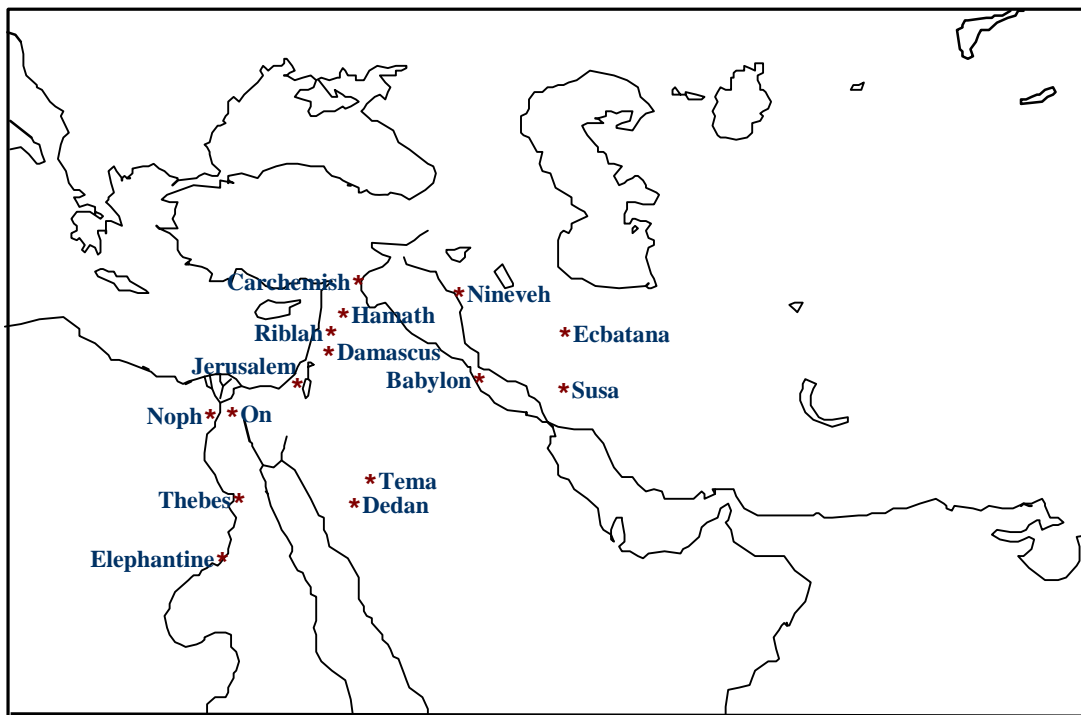

Ancient Near Eastern Towns in Ezekiel's Times

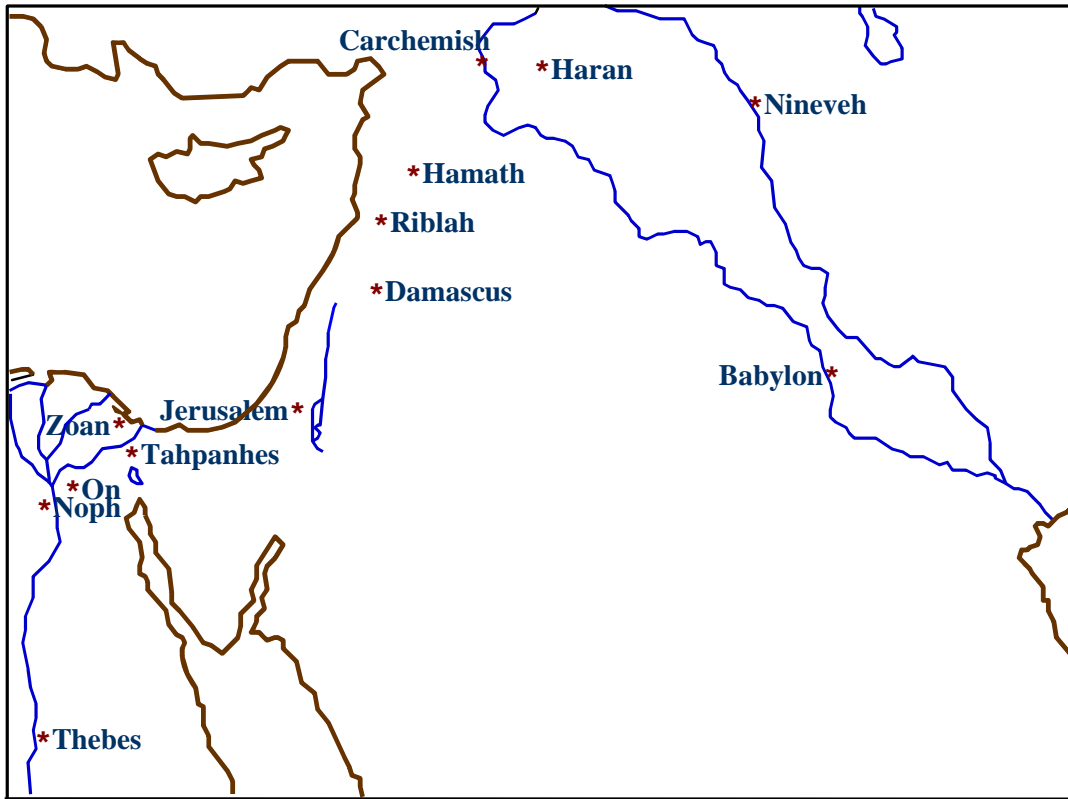

Close-up of Ancient Near Eastern Towns in Ezekiel's Times

Bibliography

- Ackroyd, Peter R. *Exile and Restoration*. Philadelphia: Westminster Press, 1968.
- Alexander, Ralph H. *Ezekiel*. Everyman's Bible Commentary series. Chicago: Moody Press, 1976.
- _____. "Ezekiel." In *Isaiah-Ezekiel*. Vol. 6 of *The Expositor's Bible Commentary*. 12 vols. Edited by Frank E. Gaebelein and Richard P. Polcyn. Grand Rapids: Zondervan Publishing House, 1986.
- _____. "Hermeneutics of Old Testament Apocalyptic Literature." Th.D. dissertation, Dallas Theological Seminary, 1968.
- Allen, Leslie C. *Ezekiel 1—19*. Word Biblical Commentary series. Dallas: Word Books, 1994.
- _____. *Ezekiel 20—48*. Word Biblical Commentary series. Dallas: Word Books, 1990.
- Allis, Oswald T. *Prophecy and the Church*. Philadelphia: Presbyterian and Reformed Publishing Co., 1945.
- Andrews, Samuel J. *God's Revelations of Himself to Men*. New York: Scribner's Sons, 1886.
- The Ante-Nicene Fathers*. Edited by Alexander Roberts and James Donaldson. 10 vols. Grand Rapids: Wm. B. Eerdmans Publishing Co., 1974.
- Archer, Gleason L., Jr. *A Survey of Old Testament Introduction*. Revised ed. Chicago: Moody Press, 1974.
- Armerding, Carl. "Russia and the King of the North." *Bibliotheca Sacra* 120:477 (January-March 1963):50-55.
- Barbieri, Louis A., Jr. "The Future for Israel in God's Plan." In *Essays in Honor of J. Dwight Pentecost*, pp. 163-79. Edited by Stanley D. Toussaint and Charles H. Dyer. Chicago: Moody Press, 1986.
- Barnett, R. D. "Ezekiel and Tyre." In *Eretz-Israel*, 9:6-13. Edited by A. Malamat. Jerusalem: Israel Exploration Society, 1969.
- Bauman, Louis S. *Russian Events in the Light of Bible Prophecy*. New York: Fleming H. Revell, 1942.
- Block, Daniel I. "Beyond the Grave: Ezekiel's Vision of Death and the Afterlife." *Bulletin of Biblical Research* 2 (1992):112-41.
- _____. *The Book of Ezekiel: Chapters 1—24*. New International Commentary on the Old Testament series. Grand Rapids: Wm. B. Eerdmans Publishing Co., 1997.

- _____. *The Book of Ezekiel: Chapters 25—48*. New International Commentary on the Old Testament series. Grand Rapids: Wm. B. Eerdmans Publishing Co., 1998.
- _____. "The Prophet of the Spirit: The Use of *rwh* in Ezekiel." *Journal of the Evangelical Theological Society* 32 (1989):27-49.
- Bright, John. *A History of Israel*. Philadelphia: Westminster Press, 1959.
- Briscoe, Stuart. *All Things Weird and Wonderful*. Wheaton: Scripture Press Publications, Victor Books, 1977.
- Brownlee, W. H. "Exorcising the Souls from Ezekiel xiii, 17-23." *Journal of Biblical Literature* 69 (1950):367-73.
- Bruce, F. F. "The Background to the Son of Man Sayings." In *Christ the Lord: Studies in Christology Presented to Donald Guthrie*, pp. 50-70. Edited by Harold H. Rowden. Downers Grove, Ill.: Inter-Varsity Press, 1982.
- Budge, E. A. W. *The Gods of the Egyptians*. New York: Dover Press, 1969.
- Bullinger, E. W. *Figures of Speech Used in the Bible*. Grand Rapids: Baker Book House, 1968.
- Bullock, C. Hassell. *An Introduction to the Old Testament Poetic Books*. Chicago: Moody Press, 1979.
- _____. "The Priestly Era in the Light of Prophetic Thought." In *Israel's Apostasy and Restoration: Essays in Honor of Roland K. Harrison*, pp. 71-78. Edited by Avraham Gileadi. Grand Rapids: Baker Book House, 1988.
- Calvin, John. *Institutes of the Christian Religion*. The Library of Christian Classics series, volumes 20 and 21. Edited by John T. McNeill. Translated by Ford Lewis Battles. Philadelphia: Westminster Press, 1960.
- Chafer, Lewis Sperry. *Systematic Theology*. 8 vols. Dallas: Dallas Seminary Press, 1947-1948.
- Chisholm, Robert B., Jr. "Does God Deceive?" *Bibliotheca Sacra* 155:617 (January-March 1998):11-28.
- _____. *Handbook on the Prophets*. Grand Rapids: Baker Book House, 2002.
- _____. "How a Hermeneutical Virus Can Corrupt Theological Systems." *Bibliotheca Sacra* 166:663 (July-September 2009):259-70.
- Colson, Charles. *Against the Night*. Ann Arbor: Servant Publications, 1989.
- Cooke, G. A. *A Critical and Exegetical Commentary on the Book of Ezekiel*. International Critical Commentary series. Edinburgh: T. & T. Clark, 1936.

- Cooper, David L. *When Gog's Armies Meet the Almighty: An Exposition of Ezekiel Thirty-eight and Thirty-nine*. Los Angeles: The Biblical Research Society, 1940.
- Cooper, Lamar Eugene, Sr. *Ezekiel*. The New American Commentary series. N.c.: Broadman & Holman Publishers, 1994.
- Craigie, Peter C. *Ezekiel*. Daily Study Bible series. Philadelphia: Westminster Press, 1983.
- Criswell, W. A. *Expository Sermons on the Book of Ezekiel*. Grand Rapids: Zondervan Publishing House, 1987.
- Davidson, A. B. *The Book of the Prophet Ezekiel*. Cambridge Bible Commentary series. Cambridge, Eng.: Cambridge University Press, 1893.
- Davidson, Jo Ann. "'Even if Noah, Daniel, and Job' (Ezekiel 14:14, 20)—Why These Three?" *Journal of the Adventist Theological Society* 12:2 (Autumn 2001):132-44.
- Day, John N. "Ezekiel and the Heart of Idolatry," *Bibliotheca Sacra* 164:653 (January-March 2007):21-33.
- _____. *Yahweh and the Gods and Goddesses of Canaan*. Sheffield, Eng.: Sheffield Academic Press, 2000.
- Decker, Rodney J. "The Church's Relationship to the New Covenant." *Bibliotheca Sacra* 152:6-7 (July-September 1995):290-305.
- de Vaux, Roland. *Ancient Israel: Its Life and Institutions*. New York: McGraw-Hill, 1961.
- Dillow, Joseph C. *The Reign of the Servant Kings: A Study of Eternal Security and the Final Significance of Man*. Miami Springs, Fla.: Schoettle Publishing Co., 1992.
- Dyer, Charles H. "Ezekiel." In *The Bible Knowledge Commentary: Old Testament*, pp. 1225-1317. Edited by John F. Walvoord and Roy B. Zuck. Wheaton: Scripture Press Publications, Victor Books, 1985.
- Dyer, Charles H., and Eugene H. Merrill. *The Old Testament Explorer*. Nashville: Word Publishing, 2001. Reissued as *Nelson's Old Testament Survey*. Nashville: Thomas Nelson Publishers, 2001.
- Ellison, H. L. *Ezekiel: The Man and His Message*. Grand Rapids: Wm. B. Eerdmans Publishing Co., 1956.
- Engstrom, Ted W. *Integrity*. Waco: Word Books, 1987.
- Enns, Paul P. *Ezekiel*. Grand Rapids: Zondervan Publishing House, 1986.

- Feinberg, Charles Lee. *Habakkuk, Zephaniah, Haggai, Malachi*. The Major Messages of the Minor Prophets series. New York: American Board of Missions to the Jews, 1951.
- _____. *The Prophecy of Ezekiel: The Glory of the Lord*. Chicago: Moody Press, 1969.
- Fisch, S. *Ezekiel*. London: Soncino Press, 1950.
- Fishbane, Michael. *Biblical Interpretation in Ancient Israel*. Oxford: Clarendon Press, 1985.
- _____. "Through the Looking Glass: Reflections on Ezek 43:3, Num 12:8 and 1 Cor 13:8." *Hebrew Annual Review* 10 (1986):63-75.
- Fowler, J. D. *The Theophoric Divine Names in Hebrew*. Journal for the Study of the Old Testament Supplement series, 49. Sheffield, Eng.: JSOT, 1988.
- Fredericks, Daniel C. "Diglossia, Revelation, and Ezekiel's Inaugural Rite." *Journal of the Evangelical Theological Society* 41:2 (June 1998):189-99.
- Freed, K. S., and D. B. Redford. "The Dates of Ezekiel in Relation to Biblical, Babylonian and Egyptian Sources." *Journal of the American Oriental Society* 90 (1970):462-85.
- Freeman, Hobart E. *An Introduction to the Old Testament Prophets*. Chicago: Moody Press, 1974.
- Gaebelein, Arno C. *The Prophet Ezekiel: An Analytical Exposition*. New York: Our Hope, 1918.
- Good, Edwin M. "Ezekiel's Ship: Some Extended Metaphors in the Old Testament." *Semitics* 1 (1970):79-103.
- Gordis, Robert. "The Branch in the Nose." *Journal of Theological Studies* 37 (1936):284-85.
- Gray, John. "Canaanite Kingship in Theory and Practice." *Vetus Testamentum* 2 (1952):193-200.
- Greenberg, Moshe. *Ezekiel 1—20*. Anchor Bible series. Garden City, N.Y.: Doubleday, 1983.
- Habel, N. "The Form and Significance of the Call Narrative." *Zeitschrift für die Alttestamentliche Wissenschaft* 77 (1965):297-323.
- Harrison, R. K. *Introduction to the Old Testament*. Grand Rapids: Wm. B. Eerdmans Publishing Co., 1969.
- Herodotus*. 4 vols. With an English translation by A. D. Godley. The Loeb Classical Library. London: William Heinemann Ltd., 1963.

- Hiebert, D. Edmond *Working with God: Scriptural Studies in Intercession*. New York: Carlton Press, 1987.
- Hoehner, Harold W. "The Progression of Events in Ezekiel 38—39." In *Integrity of Heart, Skillfulness of Hands: Biblical and Leadership Studies in Honor of Donald K. Campbell*, pp. 82-92. Edited by Charles H. Dyer and Roy B. Zuck. Grand Rapids: Baker Book House, 1994.
- Hullinger, Jerry M. "The Compatibility of the New Covenant and Future Animal Sacrifices." *Journal of Dispensational Theology* 17:50 (Spring 2013):47-64.
- _____. "The Divine Presence, Uncleaness, and Ezekiel's Millennial Sacrifices." *Bibliotheca Sacra* 163:652 (October-December 2006): 405-22.
- _____. "The Function of the Millennial Sacrifices in Ezekiel's Temple, Part 1." *Bibliotheca Sacra* 167:665 (January-March 2010):40-57.
- _____. "The Function of the Millennial Sacrifices in Ezekiel's Temple, Part 2," *Bibliotheca Sacra* 167:666 (April-June 2010):166-79.
- _____. "The Problem of Animal Sacrifices in Ezekiel 40—48." *Bibliotheca Sacra* 152:607 (July-September 1995):279-89.
- Ironside, Harry A. *Ezekiel*. Neptune, N.J.: Loizeaux Brothers Publishers, 1949.
- Jacobsen, T. *The Treasures of Darkness*. New Haven, Conn.: Yale University Press, 1976.
- Johnson, Elliott E. "Apoclyptic Genre in Literary Interpretation." In *Essays in Honor of J. Dwight Pentecost*, pp. 197-210. Edited by Stanley D. Toussaint and Charles H. Dyer. Chicago: Moody Press, 1986.
- Josephus, Flavius. *The Works of Flavius Josephus*. Translated by William Whiston. London: T. Nelson and Sons, 1866; reprint ed. Peabody, Mass.: Hendrickson Publishers, 1988.
- Kaiser, Walter C., Jr. *Toward an Old Testament Theology*. Grand Rapids: Zondervan Publishing House, 1978.
- Keil, Carl Friedrich. *Biblical Commentary on the Prophecies of Ezekiel*. Translated by James Martin. Reprint ed. 2 vols. Grand Rapids: Wm. B. Eerdmans Publishing Co., n.d.
- Kelly, William. *Notes on Ezekiel*. London: G. Morrish, n.d.
- Klein, R. W. *Ezekiel. The Prophet and His Message*. Columbia, S.C.: University of South Carolina, 1988.
- Kruger, P. A. "The Hem of the Garment in Marriage: The Meaning of the Symbolic Gesture in Ruth 3:9 and Ezek 16:8." *Journal of Northwest Semitic Languages* 12 (1984):79-86.

- Kutsko, John F. *Between Heaven and Earth: Divine Presence and Absence in the Book of Ezekiel*. Biblical and Judaic Studies from the University of California, San Diego. Winona Lake, Ind.: Eisenbrauns, 2000.
- Lane, D. *The Cloud and the Silver Lining*. Welwyn: Evangelical Press, 1985.
- Levenson, J. D. *Theology of the Program of Restoration of Ezekiel 40—48*. Atlanta: Scholars Press, 1986.
- Longman, Tremper, III and Raymond B. Dillard. *An Introduction to the Old Testament*. 2nd ed. Grand Rapids: Zondervan, 2006.
- MacRae, Allen A. "The Key to Ezekiel's First Thirty Chapters." *Bibliotheca Sacra* 122:487 (July 1965):227-33.
- Matthiae, P. *Ebla: An Empire Rediscovered*. New York: Doubleday, 1981.
- May, H. G. "Some Aspects of Solar Worship at Jerusalem." *Zeitschrift für die Alttestamentliche Wissenschaft* 55 (1937):269-81.
- McClain, Alva J. *The Greatness of the Kingdom: An Inductive Study of the Kingdom of God*. 1959. Reprint ed. Chicago: Moody Press, 1968.
- McConville, J. Gordon. "Priests and Levites in Ezekiel: A Crux in the Interpretation of Israel's History." *Tyndale Bulletin* 34 (1983):3-31.
- McNicol, Allan J. "The Heavenly Sanctuary in Judaism: A Model for Tracing the Origin of an Apocalypse." *Journal of Religious Studies* 13:2 (1987):66-94.
- Merrill, Eugene H. "A Theology of Ezekiel and Daniel." In *A Biblical Theology of the Old Testament*, pp. 365-95. Edited by Roy B. Zuck. Chicago: Moody Press, 1991.
- Milgrom, Jacob. "Sin-Offering or Purification-Offering?" *Vetus Testamentum* 21 (1971):237-39.
- Morgan, G. Campbell. *Living Messages of the Books of the Bible*. 2 vols. New York: Fleming H. Revell Co., 1912.
- The Nelson Study Bible*. Edited by Earl D. Radmacher. Nashville: Thomas Nelson Publishers, 1997.
- The New Bible Dictionary*, 1962 ed. S.v. "Cherubim," by R. K. Harrison.
- _____. S.v. "Ezekiel, Book of," by H. L. Ellison.
- The New Scofield Reference Bible*. Edited by Frank E. Gaebelin, et al. New York: Oxford University Press, 1967.
- O'Connor, Jerome Murphy. "The Weight of God's Name: Ezekiel in Context and Canon." *The Bible Today* 18 (1980):28-34.

- Oppenheim, A. Leo. *The Interpretation of Dreams in the Ancient Near East with a Translation of an Assyrian Dream-Book*. Philadelphia: American Philosophical Society, 1956.
- Parker, Richard A., and Waldo H. Dubberstein. *Babylonian Chronology 626 B.C. – A.D. 75*. Brown University Studies 19. Providence: Brown University Press, 1956.
- Parunak, Henry van Dyke. "The Literary Architecture of Ezekiel's *mar'ot 'elohim*." *Journal of Biblical Literature* 99 (1980):61-74.
- Pentecost, J. Dwight. *Things to Come*. Findlay, Ohio: Dunham Publishing Co., 1958.
- _____. *Your Adversary the Devil*. Grand Rapids: Zondervan Publishing House, 1969.
- Polk, Timothy. "Paradigms, Parables, and *Meshalim*: On Reading the *Mashal* in Scripture." *Catholic Biblical Quarterly* 45:4 (1983):564-83.
- Pritchard, James B., ed. *The Ancient Near East in Pictures*. Princeton: Princeton University Press, 1954.
- _____, ed. *Ancient Near Eastern Texts*. 2nd. ed. Princeton: Princeton University Press, 1955.
- Ringgren, Helmer. *Religions of the Ancient Near East*. Philadelphia: Westminster Press, 1973.
- Rooker, Mark F. "Evidence from Ezekiel." In *A Case for Premillennialism: A New Consensus*. Edited by Donald K. Campbell and Jeffrey L. Townsend. Chicago: Moody Press, 1992.
- Russell, D. S. *The Method and Message of Jewish Apocalyptic*. Philadelphia: Westminster Press, 1964.
- Ruthven, Jon. "Ezekiel's Rosh And Russia: A Connection?" *Bibliotheca Sacra* 125:500 (October 1968):324-33.
- Ryrie, Charles C. *Dispensationalism Today*. Chicago: Moody Press, 1973.
- _____. "Why Sacrifices in the Millennium?" *The Emmaus Journal* 11 (Winter 2002):299-310.
- Saggs, H. W. F. "External Souls in the Old Testament [Ezk 13:17-21]." *Journal of Semitic Studies* (1974):1-12.
- _____. "Notes and Studies: The Branch to the Nose." *Journal of Theological Studies* NS11 (October 1960):318-29.
- The Scofield Reference Bible*. Edited by C. I. Scofield, et al. New York: Oxford University Press, 1909

- Shafer, B. E., ed. *Religion in Ancient Egypt: Gods, Myths, and Personal Practice*. Ithica, N.Y.: Cornell University Press, 1991.
- Speiser, Ephraim A. "Background and Function of the Biblical Nasi." *Catholic Biblical Quarterly* 25 (1963):111-17.
- Stalker, D. M. G. *Ezekiel*. London: SCM, 1968.
- Stuart, Douglas K. *Ezekiel*. The Communicator's Commentary series. Dallas: Word Books, 1989.
- _____. "The Prophetic Ideal of Government in the Restoration Era." In *Israel's Apostasy and Restoration: Essays in Honor of Roland K. Harrison*, pp. 283-305. Edited by Avraham Gileadi. Grand Rapids: Baker Book House, 1988.
- Taylor, John B. *Ezekiel: An Introduction and Commentary*. Tyndale Old Testament Commentaries series. Leicester, Eng., and Downers Grove, Ill.: Inter-Varsity Press, 1969.
- Thomas, D. W., ed. *Documents from Old Testament Times*. New York: Harper & Row, 1958.
- Thomas, Robert L. *Revelation 8—22: An Exegetical Commentary*. Chicago: Moody Press, 1995.
- Thomson, Clive A. "The Necessity of Blood Sacrifices in Ezekiel's Temple." *Bibliotheca Sacra* 123:491 (July 1966):237-48.
- Torczyner, Harry. "The Riddle in the Bible." *Hebrew Union College Annual* 1 (1924):125-49.
- Torrey, C. C. *Pseudo-Ezekiel and the Original Prophecy*. Yale Oriental series 18. 1930; reprint ed., New York: KTAV, 1970.
- Toussaint, Stanley D., and Jay A. Quine. "No, Not Yet: The Contingency of God's Promised Kingdom." *Bibliotheca Sacra* 164:654 (April-June 2007):131-47.
- Toy, Crawford H. *The Book of the Prophet Ezekiel*. New York: Dodd, Mead, 1899.
- Tsevat, M. "Studies in the Book of Samuel I." *Hebrew Union College Annual* 32 (1961):191-216.
- Unger, Merrill F. *Biblical Demonology: A Study of the Spiritual Forces Behind the Present World Unrest*. Wheaton: Scripture Press, 1952.
- _____. *Unger's Bible Handbook: An Essential Guide to Understanding the Bible*. Chicago: Moody Press, 1966.
- Van Dijk, H. J. *Ezekiel's Prophecy on Tyre*. Rome: Pontifical Biblical Institute, 1968.
- Wall, Joe L. *Going for the Gold*. Chicago: Moody Press, 1991.

- Waltke, Bruce K., with Charles Yu. *An Old Testament Theology: an exegetical, canonical, and thematic approach*. Grand Rapids: Zondervan, 2007.
- Walvoord, John F. *The Millennial Kingdom*. 1959. Revised ed. Findlay, Ohio: Dunham Publishing Co., 1963.
- _____. "Revelation." In *The Bible Knowledge Commentary: New Testament*, pp. 925-91. Edited by John F. Walvoord and Roy B. Zuck. Wheaton: Scripture Press Publications, Victor Books, 1983.
- Westermann, Claus. *Basic Forms of Prophetic Speech*. Philadelphia: Westminster Press, 1967.
- Wevers, John W. *Ezekiel*. New Century Bible Commentary series. Grand Rapids: Wm. B. Eerdmans Publishing Co., 1969.
- Wiersbe, Warren W. "Ezekiel." In *The Bible Exposition Commentary/Prophets*, pp. 163-250. Colorado Springs, Colo.: Cook Communications Ministries; and Eastbourne, England: Kingsway Communications Ltd., 2002.
- Wood, Leon J. *The Holy Spirit in the Old Testament*. Grand Rapids: Zondervan Publishing House, 1976.
- _____. *The Prophets of Israel*. Grand Rapids: Baker Book House, 1979.
- Woudstra, Martin H. "The Everlasting Covenant in Ezekiel 16:59-63." *Calvin Theological Journal* 6 (1971):22-48.
- Yamauchi, Edwin. "Tammuz and the Bible." *Journal of Biblical Literature* 84 (1965):283-90.
- York, Anthony D. "Ezekiel I: Inaugural and Restoration Visions?" *Vetus Testamentum* 27 (1977):82-98.
- Young, Edward J. *My Servants, the Prophets*. Grand Rapids: Wm. B. Eerdmans Publishing Co., 1952.
- Zimmerli, W. *Ezekiel 1*. Hermeneia series. Philadelphia: Fortress Press, 1983.
- _____. *Ezekiel 2*. Hermeneia series. Philadelphia: Fortress Press, 1983.