

ECON FP PUMP SERIES

PERISTALTIC METERING PUMP

INSTALLATION AND MAINTENANCE MANUAL

 **WARNING**

TO BE INSTALLED AND MAINTAINED BY PROPERLY TRAINED PROFESSIONAL INSTALLER ONLY. READ MANUAL & LABELS FOR ALL SAFETY INFORMATION & INSTRUCTIONS.

TABLE OF CONTENTS

Warranty and Service Policy	3
Safety Instructions cover, 4-6, 9, 15, 17, 20-21, 23, 25-29, 31-34, 36	
Materials of Construction	7
Accessories	8
Flow Rate Outputs	9
Modes of Operation Description	10
Control Panel Guide	11-12
Pre-Programming Requirements	13-14
Program Pump Settings	15-19
Installation.....	20-29
Troubleshooting	30-32
Tube Replacement	33-35
Cleaning The Point of Injection.....	36-38
Exploded View	39
Parts	40
Mounting Template	41

IMEFP 052220

WARRANTY AND CUSTOMER SERVICE

LIMITED WARRANTY

Stenner Pump Company will for a period of one (1) year from the date of purchase (proof of purchase required) repair or replace at our option all defective parts. Stenner is not responsible for any removal or installation costs. Pump tube assemblies and rubber components are considered perishable and are not covered in this warranty. Pump tube will be replaced each time a pump is in for service, unless otherwise specified. The cost of the pump tube replacement will be the responsibility of the customer. Stenner will incur shipping costs for warranty products shipped from our factory in Jacksonville, Florida. Any tampering with major components, chemical damage, faulty wiring, weather conditions, water damage, power surges, or products not used with reasonable care and maintained in accordance with the instructions will void the warranty. Stenner limits its liability solely to the cost of the original product. We make no other warranty expressed or implied.

RETURNS

Stenner offers a 30-day return policy on factory direct purchases. Except as otherwise provided, no merchandise will be accepted for return after 30 days from purchase. To return merchandise at any time, call Stenner at 800.683.2378 for a Return Merchandise Authorization (RMA) number. A 15% re-stocking fee will be applied. Include a copy of your invoice or packing slip with your return.

DAMAGED OR LOST SHIPMENTS

Check your order immediately upon arrival. All damage must be noted on the delivery receipt. Call Stenner Customer Service at 800.683.2378 for all shortages and damages within seven (7) days of receipt.

SERVICE & REPAIRS

Before returning a pump for warranty or repair, remove chemical from pump tube by running water through the tube, and then run the pump dry. Following expiration of the warranty period, Stenner Pump Company will clean and overhaul any Stenner metering pump for a minimum labor charge plus necessary replacement parts and shipping. All metering pumps received for overhaul will be restored to their original condition. The customer will be charged for missing parts unless specific instructions are given. To return merchandise for repair, call Stenner at 800.683.2378 or 904.641.1666 for a Return Merchandise Authorization (RMA) number.

DISCLAIMER

The information contained in this manual is not intended for specific application purposes. Stenner Pump Company reserves the right to make changes to prices, products, and specifications at any time without prior notice.

TRADEMARKS

Santoprene® is a registered trademark of Exxon Mobil Corporation.
AquaShield™ is a trademark of Houghton International.

IMPORTANT SAFETY INSTRUCTIONS

When installing and using this electrical equipment, basic safety precautions should always be followed, including the following:

1. READ AND FOLLOW ALL INSTRUCTIONS.

2. WARNING - To reduce the risk of injury, do not permit children to use this product unless they are closely supervised at all times.

3. WARNING - Risk of Electric Shock. Connect only to a branch circuit protected by a ground-fault circuit interrupter (GFCI). Contact a qualified electrician if you cannot verify that the receptacle is protected by a GFCI.

4. WARNING - To reduce the risk of electric shock, replace damaged cord immediately.

5. SAVE THESE INSTRUCTIONS.

SAFETY INFORMATION



⚠ WARNING Warns about hazards that **CAN** cause death, serious personal injury, or property damage if ignored.



ELECTRIC SHOCK HAZARD



⚠ WARNING ELECTRIC SHOCK HAZARD:

The pump must only be used with the Class II power supply that is supplied with the pump.



⚠ AVERTISSEMENT RISQUE DE CHOC ELECTRIQUE:

La pompe ne peut être utilisée qu'avec le bloc d'alimentation de type Classe II originalement fourni avec celle-ci.



⚠ WARNING RISK OF ELECTRIC SHOCK:

This pump has not been investigated for use in swimming pool or marine areas.



⚠ AVERTISSEMENT RISQUE DE CHOC ELECTRIQUE:

La pompe n'a pas été vérifiée et approuvée pour utilisation sur des applications de piscine ou autre installation marine.



DO NOT alter the power cord or power supply.



DO NOT use receptacle adapters.



DO NOT use pump with a damaged or altered power cord or power supply. Contact the factory or an authorized service facility for repair.



⚠ WARNING HAZARDOUS VOLTAGE:

DISCONNECT power cord before removing motor cover for service. **Electrical service by trained personnel only.**



⚠ WARNING EXPLOSION HAZARD:

This pump is not explosion proof. **DO NOT** install or operate in an explosive environment.



⚠ WARNING RISK OF EXPOSURE:

Potential for burns, fire, explosion, personal injury, or property damage. To reduce risk of exposure, the use of proper personal protective equipment is mandatory.



⚠ WARNING RISK OF FIRE HAZARD:

DO NOT install or operate on any flammable surface.



⚠ WARNING RISK OF CHEMICAL OVERDOSE:

To reduce risk, follow proper installation methods and recommendations. Check your local codes for additional guidelines.



⚠ WARNING To reduce the risk of injury, do not permit children to use this product. This appliance is not to be used by persons with reduced physical, sensory or mental capabilities, or lack of experience and knowledge, unless they have been given supervision or instruction.



SAFETY INFORMATION continued

 **CAUTION** Warns about hazards that **WILL** or **CAN** cause minor personal injury or property damage if ignored.







 **CAUTION PLUMBING:**
Metering pump installation must always adhere to your local plumbing codes and requirements. Be sure installation does not constitute a cross connection. Check local plumbing codes for guidelines.

 **CAUTION** This pump has been evaluated for use with water only.

 **NOTICE: Indicates special instructions or general mandatory action.**

-  This metering pump is portable and designed to be removable from the plumbing system without damage to the connections.
-  Before installing or servicing the pump, read the pump manual for all safety information and complete instructions. The pump is designed for installation and service by properly trained personnel.
-  Installation and product must adhere to all regulatory and compliance codes applicable to the area.

 **This is the safety alert symbol. When displayed in this manual or on the equipment, look for one of the following signal words alerting you to the potential for personal injury or property damage.**

-  Acceptable for indoor use; or, outdoor use when mounted as shown in the Installation Section.
-  Destiné à une utilisation intérieure ou extérieure lorsqu'il le schéma de la section installation est respecté.
-  Electrical installation should adhere to all national and local codes. Consult a licensed professional for assistance with proper electrical installation.
-  Removing power from recirculation pump must also remove power from pump.
-  The use of an auxiliary safety device (not supplied), such as a flow switch or sensor, is recommended to prevent feed pump operation in the event of a recirculation pump failure or if flow is not sensed.
-  Point of injection should be beyond all pumps, filters, and heaters.
-  Maximum temperature = 40°C

MATERIALS OF CONSTRUCTION

All Housings

Polycarbonate

Pump Tube & Check Valve Duckbill

Santoprene® (FDA approved)

Suction/Discharge Tubing & Ferrules

Polyethylene (FDA approved)

Suction Line Strainer and Cap

PVC or Polypropylene (both NSF listed); ceramic weight

Tube & Injection Fittings

PVC or Polypropylene (both NSF listed)

Connecting Nuts

PVC or Polypropylene (both NSF listed)

All Fasteners

Stainless steel

ACCESSORIES

Contents

3 Connecting Nuts 1/4"

3 Ferrules 1/4" or 6 mm *Europe*

1 Duckbill Check Valve

1 Weighted Suction Line Strainer 1/4" or 6 mm *Europe*

1 20' Roll of Suction/Discharge Tubing

1/4" White or UV Black OR 6 mm White *Europe*

1 Additional Pump Tube

1 Manual

FLOW RATE OUTPUTS

Item Number Prefix	Pump Tube	Roller Assembly	Turndown Ratio	Gallons per Day	Gallons per Hour	Ounces per Hour	Ounces per Minute	Pressure Max. psi
E10PLM	M	White	10:1	0.49	0.02	2.6	0.04	80
E10PHM	M	White	10:1	0.83	0.03	4.4	0.07	80
E20PHM	M	White	10:1	1.41	0.06	7.5	0.13	80
E20PHF	F	White	10:1	4.5	0.19	24.0	0.40	80
E20PHG	G	Black	10:1	16.0	0.67	85.3	1.42	80
E20PHH	H	Black	10:1	30.0	1.25	160.0	2.67	80
Approximate Maximum Outputs @ 50/60Hz								

Item Number Prefix	Pump Tube	Roller Assembly	Turndown Ratio	Liters per Day	Liters per Hour	Milliliters per Hour	Milliliters per Minute	Pressure Max. bar
E10PLM	M	White	10:1	1.84	0.08	76.7	1.3	5.5
E10PHM	M	White	10:1	3.14	0.13	130.8	2.2	5.5
E20PHM	M	White	10:1	5.36	0.22	223.2	3.7	5.5
E20PHF	F	White	10:1	17.01	0.71	708.8	11.8	5.5
E20PHG	G	Black	10:1	60.48	2.52	2520.0	42.0	5.5
E20PHH	H	Black	10:1	113.40	4.73	4725.0	78.8	5.5
Approximate Maximum Outputs @ 50/60Hz								

NOTE: Duckbill check valve included with pumps rated 80 psi (5.5 bar) maximum.



NOTICE: The information within this chart is solely intended for use as a guide. The output data is an approximation based on pumping water under a controlled testing environment. Many variables can affect the output of the pump. Stenner Pump Company recommends that all metering pumps undergo field calibration by means of analytical testing to confirm their outputs.

MODES OF OPERATION DESCRIPTION

The Econ FP is a flow activated pump and will accept a dry contact signal or a 12-24VAC/VDC signal from any control equipment that responds to flow. The pump runs at a set time or a set speed according to the mode of operation selected. The run time or the pump speed is adjustable from 10% to 100% in 1% increments. The control panel displays the modes of operation as **SECONDS**, **AUXILIARY** and **FLOW SWITCH**.

Before programming, review the pre-programming requirements pages 13 to 14, steps A-D.

SECONDS (dry contact signal)

In the Seconds mode, the pump can receive a dry (non-voltage) contact signal and will run for a set time in response to receiving the signal. The pump can receive the signal from, for example, a water meter or control valve that sends a dry contact signal. There is a choice of five pump operating time ranges and the maximum time is displayed in the control panel; the run time is adjustable from 10% to 100% in 1% increments.

1 SECOND = 0.1 to 1.0

5 SECONDS = 0.5 to 5.0

10 SECONDS = 1.0 to 10.0

20 SECONDS = 2.0 to 20.0

60 SECONDS = 6.0 to 60.0

AUXILIARY (12-24VAC/VDC signal)

In the Auxiliary mode, the pump can accept a 12-24VAC/VDC signal and will run at a set speed for as long as it receives the signal. The pump speed is adjustable from 10% to 100% in 1% increments. If polarity is reversed when connecting a DC signal to the AUX input, the pump will not respond to the signal. The pump can receive the signal from a control valve or another type of control equipment that responds to flow.

FLOW SWITCH (dry contact signal)

In the Flow Switch mode, the pump will accept a dry (non-voltage) contact signal from a 2 wire flow switch and will run at the set speed for as long as it receives the dry contact. The pump speed is adjustable from 10% to 100% in 1% increments. The connection is not polarity sensitive (polarity is not an issue when connecting the flow switch wires).

CONTROL PANEL GUIDE – BUTTONS

The control panel has a backlit LCD display; when operating it will display the operating modes and the % setting. The pump is factory pre-set at the lowest settings. The keypad is locked and in standby mode.



To unlock the keypad, simultaneously press and hold **MODE** and **%** for 5 seconds. The keypad will automatically lock if there is no operation for 60 seconds.

Following are the buttons for programming the modes of operation.



To prime the pump or run the pump at full speed, first press & continue to hold **MODE**, then press **PRIME**.



To place the pump in or out of standby, first press & continue to hold **MODE**, then press **STBY**. The pump will not respond to incoming signals when in STBY mode.



To select a mode of operation, first press & continue to hold **MODE**, then press **↑** or **↓** to scroll through the selections. The display will show FLOW SWITCH, AUXILIARY (for 12-24VAC/VDC), or SECONDS.

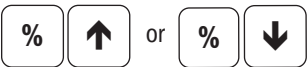

After the operational mode is selected, select the percentage setting. First press & continue to hold **%**, then press **↑** or **↓** until the desired percentage is reached.

CONTROL PANEL GUIDE – INDICATORS

The display has flashing indicators beneath the operating mode and setting. The indicators are “PRIME”, “STANDBY”, “SIGNAL”, “PAUSE” and “KEYPAD LOCKED” and represent the following functions:

PRIME = Prime button is pressed, pump will run full speed

STANDBY = Standby button was pressed, pump is in standby

SIGNAL = Pump received a signal

PAUSE = Pump received a dry contact to the pause input

KEYPAD LOCKED = After 60 seconds of no keypad operation, the keypad will lock and the display will show “KEYPAD LOCKED”

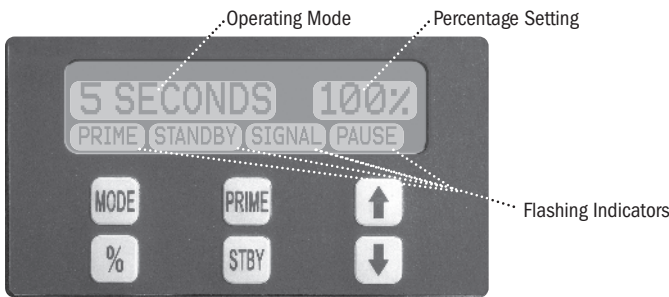

Control Panel

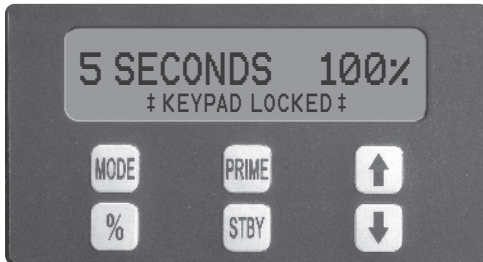

PRE-PROGRAMMING REQUIREMENTS

Before programming the pump, collect or calculate the data in steps A through D then continue with the instructions for the Seconds, Auxiliary or Flow Switch mode.

A. Determine the Maximum System Flow Rate or Well Pump Flow Rate in Gallons per Minute.

If well pump output is unknown, refer to example below:

Calculate well pump output rate in gallons per minute (gpm).

Determine the output rate by opening a faucet until the well pump turns on. Immediately turn off the faucet and time how long the well pump runs. Next, measure the volume of water drawn from the faucet until the well pump turns on again.

$$\frac{\text{volume of water until the pump turns on (gal.)}}{\text{how long the pump runs (min.)}} = \text{Well Pump Output Rate (gpm)}$$

Example: After drawing 10 gallons of water, the well pump took 2 minutes to fill the pressure tank and stop.

$$\frac{10 \text{ gallons}}{2 \text{ minutes}} = 5 \text{ gpm}$$

B. Determine Solution Strength Percentage and the Dosage Requirement in Parts per Million.

If dosage is unknown, refer to example below:

Calculate required dosage in parts per million (ppm).

Refer to Oxidation Rates below. Estimate dosage and include the ppm of required residual.

Common Chemical Solution Strengths in ppm

Name	%	ppm
Sodium Hypochlorite	5.25	52,500
	6.125	61,250
	12.5	125,000
Potassium Permanganate Dissolved at 1/4 lb per gallon	3	30,000
Hydrogen Peroxide	7	70,000
Polyphosphate Dissolved at 1 lb per 10 gallons	1.2	12,000

Oxidation Rates

For each ppm of	Iron	Manganese	Hydrogen Sulfide
Required ppm of Chlorine	1	2	3
Required ppm of Hydrogen Peroxide	0.5	1	1.5

Example: To treat a water supply containing 2 ppm iron and 4 ppm hydrogen sulfide with a chlorine residual of 1 ppm, a dosage of 15 ppm of chlorine is required.

$$2 \text{ ppm iron} \times 1 \text{ ppm chlorine} = 2$$

$$4 \text{ ppm hydrogen sulfide} \times 3 \text{ ppm chlorine} = 12$$

$$1 \text{ ppm chlorine residual} = 1$$

$$\text{Total } 2 + 12 + 1 = 15 \text{ ppm}$$

PRE-PROGRAMMING REQUIREMENTS continued

C. Calculate Metering Pump Output Requirement in Gallons per Day .

$$\frac{\text{Maximum System Flow Rate (gpm)} \times \text{Dosage (ppm)} \times 1440}{\text{Solution Strength ppm}^*} = \text{Metering Pump Output Requirement (gpd)}$$

* Solution Strength % x 10,000 = Solution Strength ppm

D. Reference the chart below to confirm the selected pump's maximum output slightly exceeds the pump output requirement calculated in C.

FP Pump (up to 80 psi/5.5 bar)

Item Number Prefix	Pump Tube	Roller Assembly	Maximum Output (gpd)
E10PLM	M	White	0.49
E10PHM	M	White	0.83
E20PHM	M	White	1.41
E20PHF	F	White	4.5
E20PHG	G	Black	16.0
E20PHH	H	Black	30.0

SECONDS MODE (dry contact signal)

PROGRAM PUMP SETTINGS

1. Calculate the **Available Dose Time in Seconds.**

The available dose time is the minimum time interval between the water meter contact closures.

$$a. \frac{60 \text{ Seconds}}{\text{Maximum System Flow Rate (gpm)}} = \text{Maximum System Flow Rate (spg)}$$

$$b. \frac{\text{Maximum System Flow Rate (spg)}}{\text{Water Meter's contacts per gallon (cpg)}} = \text{Available Dose Time (sec.)}$$

* Refer to the water meter model to confirm the contact rate (cpg).

2. Calculate the **Pump Operating Time in Seconds.**

$$\frac{\text{Pump Output Requirement (gpd)} \times \text{Available Dose Time (sec.)}}{\text{Pump's Maximum Output (gpd)}} = \text{Pump Operating Time (sec.)}$$

 **WARNING** **PUMP OPERATING TIME EXCEEDING AVAILABLE DOSE TIME MAY LEAD TO DOSING ERRORS.** To reduce operating time, select a pump with a higher output or use a stronger solution strength.

3. Calculate the **Pump Operating Time Percentage.**

Reference the chart to find the pump's maximum operating time for the formula below.

Seconds Mode	MAXIMUM Pump Operating Time in Seconds
1 SECOND	1.0
5 SECONDS	5.0
10 SECONDS	10.0
20 SECONDS	20.0
60 SECONDS	60.0

$$\frac{\text{Pump Operating Time (sec.)}}{\text{Maximum Pump Operating Time (sec.)}^{**}} \times 100 = \text{Pump Operating Time Percentage}$$

** Value can only be 1, 5, 10, 20, or 60.

SECONDS MODE (dry contact signal) continued

PROGRAM PUMP SETTINGS

4. Program the **Pump Operating Mode** and the **Pump Operating Time Percentage**.

Unlock the Keypad

Press **MODE** and **%** simultaneously and hold for 5 seconds to unlock the keypad.

Pump Operating Mode

First, press and continue to hold **MODE**, then press **↑** or **↓**; when the display shows 1, 5, 10, 20 or 60 SECONDS, release both buttons to select based on the pump operating time determined in #2. The operating mode is now set.

Pump Operating Time Percentage

The pump operating time can be set from 10% to 100% in 1% increments. First, press and continue to hold **%**, then press **↑** or **↓** to adjust the pump operating time percentage determined in #3. When the display shows the desired percent, release both buttons to select. The percentage is now set.

For example, if the pump is set in the 60 seconds mode and the setting is 50%, the pump will run for 30 seconds when it receives a signal from the water meter.

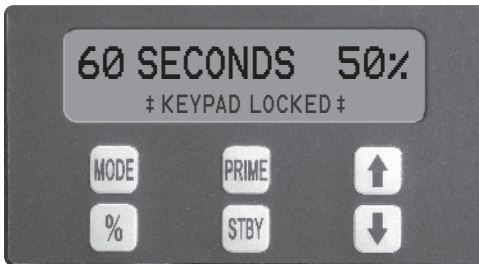

Example of control panel with keypad locked.

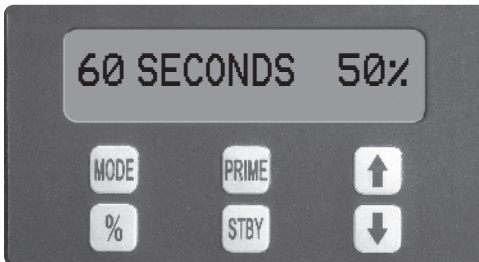

Example of control panel set for 50% of 60 seconds.

AUXILIARY (12-24VAC/VDC signal) PROGRAM PUMP SETTINGS

General Guidelines

The host device must have the ability to interface with the pump via a 12-24VAC/VDC signal. For typical water softener installation, the controller provides the ability to program the amount of water that passes through the water softener in gallons per signal (referred to as Water Volume per Signal in 2a below) and the duration of the signal in seconds (referred to as Water Softener Chemical Feed Duration in 2b below).

Refer to the specific water softener manual for instructions on how to program the settings and make the signal connections to the metering pump.

1. Determine the desired water volume (in gallons) that will pass through the water softener to require the (water softener) controller to send a signal to the metering pump (e.g. at every gallon).

NOTE: Smaller water volume between signals generally allows for more even chemical dispersion.

2. Calculate the **Water Softener Chemical Feed Duration in Seconds.**

The water softener chemical feed duration (in seconds) is the programmed amount of time that the (water softener) controller is continually activating the metering pump (to dispense chemical).

- a.
$$\frac{\text{Max System Flow Rate (gpm)}}{\text{Water Volume per Signal (gallons per signal)}} = \text{Signals Per Minute}$$
- b.
$$\frac{60 \text{ Seconds}}{\text{Signals Per Minute}} = \text{Water Softener Chemical Feed Duration (sec.)}$$



WARNING IF THE ACTUAL SYSTEM FLOW RATE EXCEEDS THE MAXIMUM SYSTEM FLOW RATE VALUE USED IN THE CALCULATION IN 2a; THE AVAILABLE WATER SOFTENER CHEMICAL FEED DURATION WILL BE REDUCED AND CAN LEAD TO DOSING ERRORS.

AUXILIARY (12-24VAC/VDC signal) continued

PROGRAM PUMP SETTINGS

3. Calculate the **Pump Speed Percentage**.

$$\frac{\text{Metering Pump Output Requirement (gpd)} \times 100}{\text{Metering Pump Maximum Output (gpd)}} = \text{Pump Speed Percentage}$$

4. Program the **Pump Operating Mode** and the **Pump Speed Percentage**.

Unlock the Keypad

Press **MODE** and **%** simultaneously and hold for 5 seconds to unlock the keypad.

Pump Operating Mode

First, press and continue to hold **MODE**, then press **↑** or **↓** to scroll through the modes of operation. When the display shows AUXILIARY, release both buttons to select. The operating mode is now set.

Pump Speed Percentage

The pump speed can be programmed from 10% to 100% in 1% increments. First, press and continue to hold **%**, then press **↑** or **↓** to adjust the speed percentage determined in #3. When the display shows the desired percent, release both buttons to select. The percentage is now set.

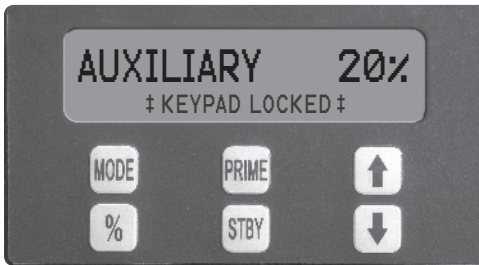

Example of control panel with keypad locked.

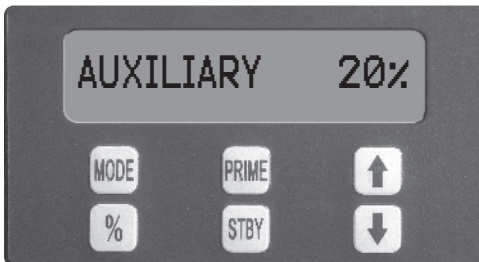

Example of control panel with the pump speed set for 20%.

FLOW SWITCH (dry contact signal) PROGRAM PUMP SETTINGS

1. Calculate the **Pump Speed Percentage Setting**.

$$\frac{\text{Metering Pump Output Requirement (gpd)} \times 100}{\text{Metering Pump Maximum Output (gpd)}} = \text{Pump Speed Percentage Setting}$$

2. Program the **Pump Operating Mode** and the **Pump Speed Percentage**.

Unlock the Keypad

Press **MODE** and **%** simultaneously and hold for 5 seconds to unlock the keypad.

Pump Operating Mode

First, press and continue to hold **MODE**, then press **↑** or **↓** to scroll through the modes of operation. When the display shows FLOW SWITCH, release both buttons to select. The operating mode is now set.

Pump Speed Percentage

The pump speed can be programmed from 10% to 100% in 1% increments. First, press and continue to hold **%**, then press **↑** or **↓** to adjust the speed percentage determined in #1. When the display shows the desired percent, release both buttons to select. The percentage is now set.

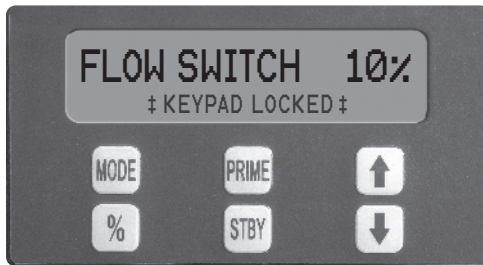

Example of control panel with keypad locked.

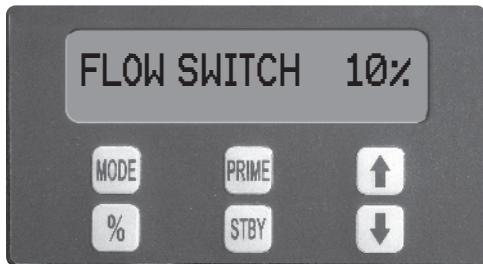

Example of control panel set for 10% in Flow switch mode.

INSTALLATION

ADDITIONAL SAFETY INSTRUCTIONS

! **NOTICE:** Indicates special instructions or general mandatory action.

- !** Read all safety hazards before installing or servicing the pump. The pump is designed for installation and service by properly trained personnel.
- !** Use all required personal protective equipment when working on or near a metering pump.
- !** Install the pump so that it is in compliance with all national and local plumbing and electrical codes.
- !** Use the proper product to treat potable water systems, use only additives listed or approved for use.
- !** Inspect tube frequently for leakage, deterioration, or wear. Schedule a regular pump tube maintenance change to prevent damage to pump and/or spillage.
- !** Pump is not recommended for installation in areas where leakage can cause personal injury or property damage.

INSTALLATION

MOUNT PUMP

- ❗ Select a dry location (to avoid water intrusion and pump damage) above the solution tank.

NOTE: A mounting template is provided on page 41.

- ❗ To prevent pump damage in the event of a pump tube leak, never mount the pump vertically with the pump head up.
- ❗ DO NOT mount pump directly over an open solution tank. Keep tank covered.
- ❗ Avoid flooded suction or pump mounted lower than the solution container. Draw solution from the top of the tank. Pump can run dry without damage. If pump is installed with a flooded suction, a shut-off valve or other device must be provided to stop flow to pump during service.
- ❗ To prevent damage to the pump, verify with a volt meter that the receptacle voltage corresponds with the pump voltage.
- ❗ For outdoor installation, the pump must be mounted vertically to comply with the outdoor rating.

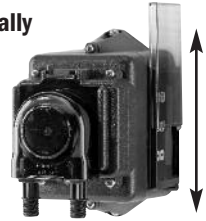

INSTALLATION

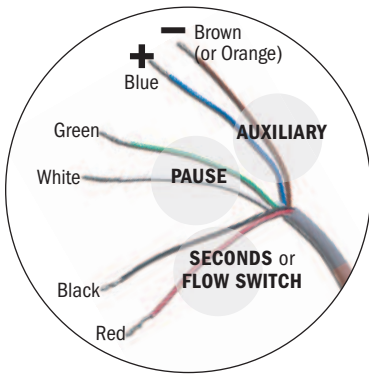

1. Connect signal wires as required by the installation:

SECONDS Black & Red

FLOW SWITCH Black & Red

PAUSE Green & White

AUXILIARY Brown (or Orange) & Blue

- For AC signal, there is no polarity.

- For DC signal, blue wire is connected to signal positive (+) and brown (or orange) is connected to signal negative (-).

NOTE: If polarity is reversed when connecting a DC signal to the AUX input, the pump will not respond to the signal.

2. Cap all non-terminated wires.

NOTE: All non-terminated wires must be capped to prevent operational errors or damage to the pump.

3. Plug power supply into receptacle. The cover must be removed to program the pump. Remove the self-tapping Phillips head screw and slide the cover off. To unlock the keypad, simultaneously press and hold **MODE** and **%** for 5 seconds.

4. Put the pump in standby. First, press and continue to hold **MODE**, then press **STBY**.

5. Program the pump for the desired operating mode and % setting, refer to Program Pump Settings in the manual. After programming, slide the cover on and reinstall the screw.

NOTE: Leave the unit in standby until the signal wires are connected and the pump is ready for priming.

INSTALLATION continued

ADDITIONAL INSTRUCTIONS FOR CE PUMPS

ADDITIONAL INSTALLATION INSTRUCTIONS

1. All Class II Pumps located in Zone 1 of swimming pool areas require locating where flooding cannot occur.
 2. This pump is intended to be installed as "fixed" as opposed to portable.
 3. The pump must be installed in a vertical position as shown in the installation diagram.
 4. After installation, the power supply plug must be accessible during use.
 5. This unit must be scrapped if the supply cord is damaged.
 6. Observe and comply with all National Wiring Standards.
-

ZUSTÄZLICHE INSTALLIERUNGSANWEISUNG

1. Pumpen die sich in Zone 1 vom Schwimmbecken befinden sollen sind so einzurichten daß Ueberschwemmungen nicht vorkommen werde.
 2. Diese Pumpe ist als fest montierte Ausrüstung bedacht und soll nicht umstellbar gebraucht werden.
 3. Die Pumpe muss vertikal installiert werden, siehe Zeichnung.
 4. Die Stromversorgung muss nach der Installierung noch zugänglich sein.
 5. Bei beschadigter Verkabelung ist dieses Gerat nicht mehr zu gebrauchen.
 6. Staatliche Vernetzungsvorchriften müssen eingehalten werden.
-

INSTRUCTIONS SUPPLÉMENTAIRES D'INSTALLTION

1. Toutes les pompes installées dans la Zone 1 du périmètre de la piscine doivent être situées de manière à ne pas pouvoir être inondées.
 2. Cette pompe est prévue pour installation fixe et non pas portative.
 3. La pompe doit être installée en position verticale selon le dessin.
 4. Après l'installation, la prise électrique doit rester accessible pendant l'utilisation.
 5. Cette unité doit être mise au rebut si le cordon électrique est endommagé.
 6. Observez et adhérez à toutes les Normes Nationales pour Installations Electriques.
-

INSTRUCCIONES ADICIONALES PARA INSTALACION

1. Todas las bombas Clase II situadas en la Zona 1 de las áreas de la piscina requieren colocarse donde no puedan ser inundadas.
 2. Esta bomba es para ser instalada "fija" en vez de portátil.
 3. La bomba debe ser instalada en posición vertical como se muestra en el diagrama de instalación.
 4. Depués de la instalación el enchufe suministrador de energía debe estar accesible durante el uso.
 5. Se deberá deshechar la unidad si el cordón de abastecimiento se deteriora.
 6. Observe y cumpla con todas las Reglas Nacionales para Instalaciones Eléctricas.
-

ISTRUZIONI SUPPLEMENTARI PER L' INSTALLAZIONE

1. Tutte le pompe Classe II localizzate nella Zona 1 della superficie circostante la piscina devono essere collocate dove gli allagamenti no possono accadere.
2. Questa pompa, é inteso, deve essere installata come 'fissa' e non come portatile.
3. La pompa deve essere installata in posizione verticale come mostrato sul disegno.
4. Dopo l'installazione, la spina deve essere accessibile durante l'uso.
5. Questa unità deve essere gettata via se il filo elettrico é danneggiato.
6. Osservare e aderire a tutte le Norme Nazionali Sugli Impianti Elettrici.

INSTALLATION DIAGRAM featuring a Water Meter

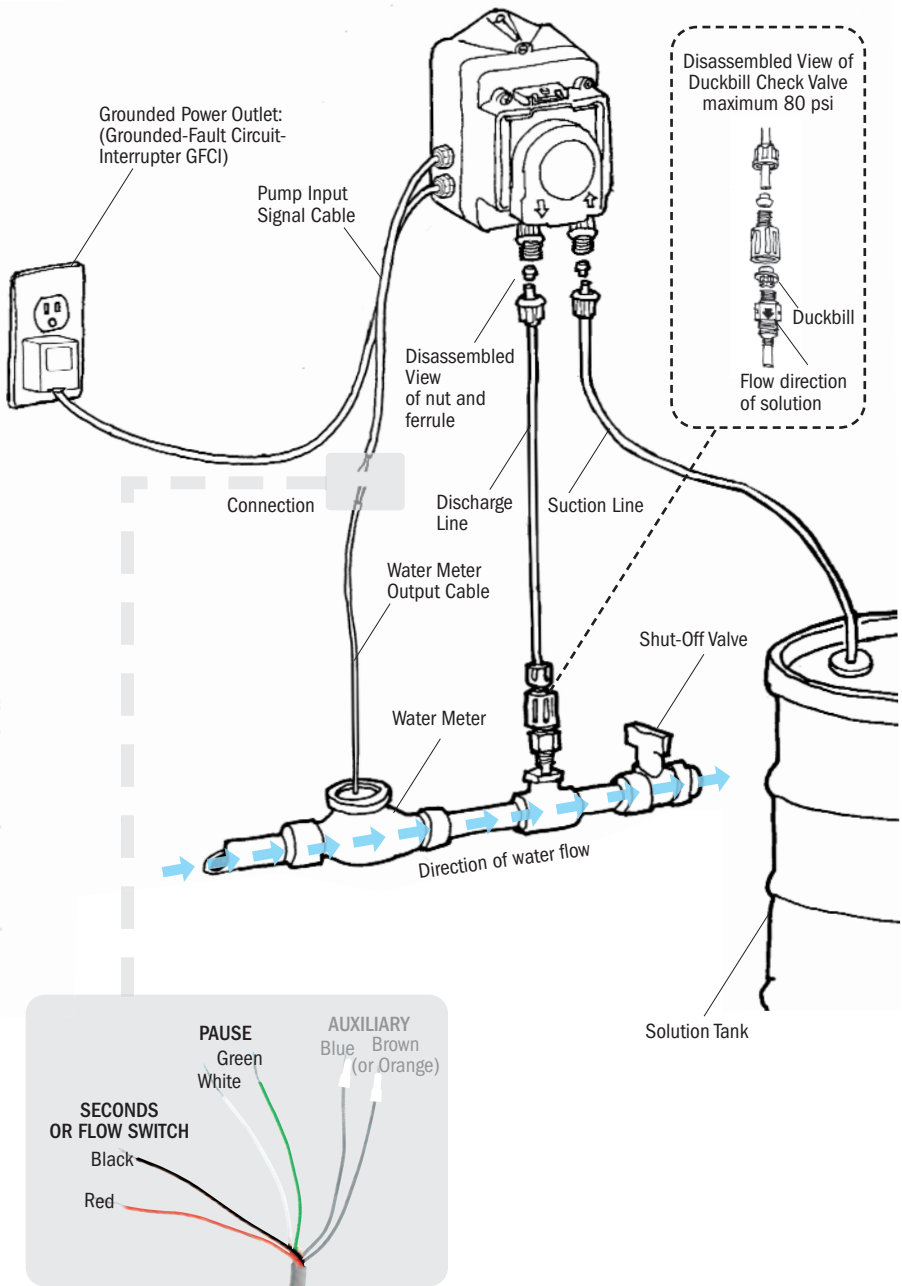

INSTALLATION continued

INSTALL SUCTION LINE TO PUMP HEAD

1. Uncoil the suction/discharge line. Use outside of solution tank as a guide to cut proper length of suction line ensuring it will be 2-3" above the bottom of solution tank.
- ❗ **Allow sufficient slack to avoid kinks and stress cracks. Always make a clean square cut to assure that the suction line is burr free. Normal maintenance requires trimming.**
 - ❗ **Suction lines that extend to the bottom of the tank can result in debris pickup leading to clogged injectors and possible tube failure.**
2. Make connections by sliding the line(s) through connecting nut and ferrule and finger tighten to the corresponding tube fittings.
 3. Finger tighten nut to the threaded tube fitting while holding the tube fitting.
- ❗ **Over tightening the nut with a wrench may result in damaged fittings, crushed ferrules, and air pick up.**
 - ❗ **DO NOT use thread sealant tape on pump tube connections or tools to tighten connections.**

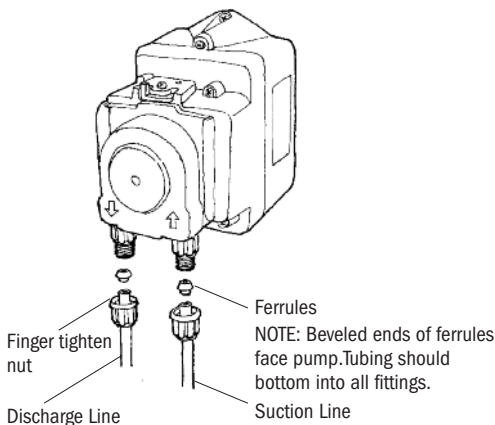

DO NOT use Teflon tape on pump tube threads.

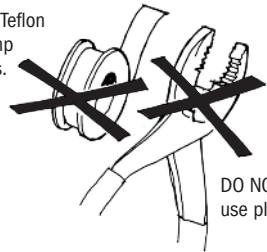

DO NOT use pliers.

INSTALLATION continued

INSTALL SUCTION WEIGHT TO SUCTION LINE

1. Drill a hole into the bung cap or solution tank lid. Slide the tubing through and secure the weighted strainer to the line.
2. To attach the strainer, push approximately 3.5" of suction line through the cap on the strainer body. Pull tubing to make sure it is secure.
3. Suspend slightly above tank bottom to reduce the chance of sediment pickup.



DO NOT mix additives in the solution container. Follow recommended mixing procedures according to the manufacturer.



DO NOT operate pump unless additive is completely in solution. Turn pump off when replenishing solution.



DO NOT slide tubing all the way to the bottom of the weighted strainer. Tubing could become flush with the nose of the strainer and the pump may not prime due to blockage.

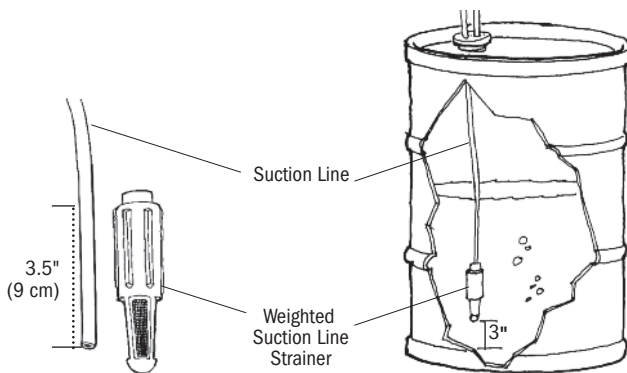

INSTALLATION continued

INSTALL DISCHARGE LINE TO PUMP HEAD AND INJECTION POINT

1. Make a secure finger tight connection on the discharge fitting of the pump head as instructed in Install Suction Line instructions.
- ❗ **DO NOT use thread sealant tape on pump tube connections or tools to tighten connections.**
- ⚠ **WARNING** **HAZARDOUS PRESSURE: Shut off water or circulation system and bleed off any system pressure.**
- ❗ **Locate a point of injection beyond all pumps and filters or as determined by the application.**
2. A 1/4" or 1/2" Female NPT (FNPT) connection is required for installing the injection fitting. If there is no FNPT fitting available, provide one by either tapping the pipe or installing FNPT pipe tee fitting.
3. Wrap the Male NPT (MNPT) end of injection fitting with 2 or 3 turns of threading tape. If necessary, trim the injection fitting quill as required to inject product directly into flow of water.
4. Hand tighten the injection fitting into the FNPT fitting.
 - a. Install connecting nut and ferrule to the pump discharge tubing. Insert discharge tubing into injection fitting until it reaches base of fitting.
 - b. Finger tighten connecting nut to fitting.

DO NOT use Teflon tape on pump tube threads.

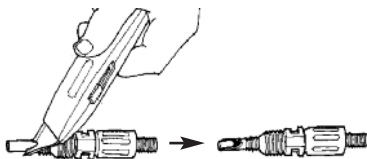
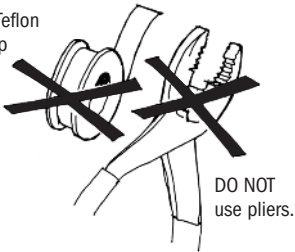

Trim injection fitting end

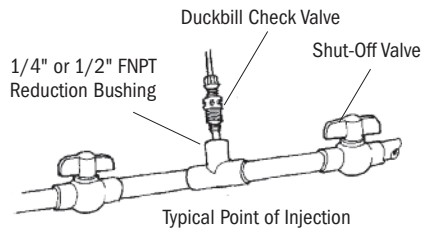

INSTALLATION continued

START PUMP

1. Take the pump out of standby. First, press and continue to hold **MODE**, then press **STBY**. Prime the pump. First, press and continue to hold **MODE**, then press **PRIME**. Once the pump is primed, release both buttons. Observe flow as actuated by the system and check all connections for leaks.
2. After suitable amount of dosing time, perform tests for desired readings (e.g., pH or ppm). If necessary, fine tune dosing levels by adjusting the percentage or by adjusting the solution strength.

NOTE: If the signal indicator flashes during the run cycle in the 1, 5, 10, 20, or 60 seconds modes, the meter contacting rate is too high for the setting programmed. Revisit the dry contact water meter programming section and correct the setting to avoid incorrect dosing.

! **NOTICE: The injection point and fitting require periodic maintenance to clean any deposits or buildup. To allow quick access to the point of injection, Stenner recommends the installation of shut-off valves.**

! **NOTICE: Be sure to replace cover and self-tapping screw.**

TROUBLESHOOTING – DRIVE ASSEMBLY



WARNING

HAZARDOUS VOLTAGE:

DISCONNECT power before service. **Electrical service should be performed by trained personnel only.**

PROBLEM	POSSIBLE CAUSE	SOLUTION
Noise is excessively loud	Lubrication is insufficient Gears or gear posts are worn	Grease gears and gear posts Inspect/replace gears and gear posts
Drive assembly does not work	Electrical supply is faulty DC motor is damaged Power cord or power supply is damaged	Check supply voltage circuit Replace drive assembly Replace drive assembly
Drive assembly runs; output shaft does not	Worn or damaged gears	Replace gears as needed
Phenolic gear is stripping	Gear posts worn Rusted helical gear Insufficient lubrication	Replace gear posts and phenolic gear Buff off helical gear and replace phenolic gear Replace phenolic gear and lubricate with AquaShield™
Output shaft does not turn	Worn or damaged roller assembly Worn or damaged gears Damaged circuit board	Replace roller assembly and cycle power to reset Replace gears as needed and cycle power to reset Replace drive assembly

TROUBLESHOOTING – PUMP HEAD

PROBLEM	POSSIBLE CAUSE	SOLUTION
Components are cracking	Chemical attack	Check chemical compatibility
Visible fluid in pump head	Pump tube rupture/leak	Replace pump tube according to instructions
No pump output; pump head rotates	Depleted solution tank Pump suction line weight is above solution Suction line leak Ferrules installed incorrectly or damaged Injection point is clogged Clogged suction/discharge tubing Life of pump tube is exhausted Suction tubing is flush with the nose of the weighted strainer Incorrect programming Incorrect wiring Pump cover not secured properly	Replenish solution Maintain suction line 2-3" off bottom of tank Inspect or replace suction line Replace ferrules Inspect and clean injection point Clean and/or replace as necessary Replace pump tube according to instructions Pull suction tubing approximately 1" from bottom of strainer; cut bottom of suction tubing at an angle Review sizing and programming Check to ensure wiring is correct Ensure that pump cover is properly latched
Low pump output; pump head rotates	Pump tube is worn Rollers worn or broken Injection point is restricted Incorrect tube size High system back pressure Incorrect programming Incorrect wiring Pump cover not secured properly	Replace pump tube according to instructions Replace roller assembly Inspect and clean injection point Replace tube with correct size Confirm system pressure does not exceed 80 psi (5.5 bar) maximum Review sizing and programming Check to ensure wiring is correct Ensure that pump cover is properly latched
No pump output; pump head doesn't rotate	Roller assembly is stripped Faulty board Drive assembly problem Incorrect programming Incorrect wiring	Replace roller assembly Replace drive assembly Refer to Troubleshooting – Drive Assembly Review sizing and programming Check to ensure wiring is correct
Pump output is high	Incorrect tube size Roller assembly is broken Incorrect programming Incorrect wiring	Replace tube with correct size Replace roller assembly Review sizing and programming Check to ensure wiring is correct







TROUBLESHOOTING – PUMP TUBE

! **NOTICE:** A leaking pump tube damages the metering pump. Inspect pump frequently for leakage and wear. Refer to Tube Replacement section for additional safety precautions and instructions.

PROBLEM	POSSIBLE CAUSE	SOLUTION
Tube leaking	Pump tube ruptured Calcium or mineral deposits Excessive back pressure 80 psi (5.5 bar) maximum Tube is twisted Tube not centered	Replace pump tube according to instructions Clean injection fitting, replace pump tube according to instructions Ensure system pressure does not exceed Replace pump tube according to instructions Replace pump tube according to instructions
Tube life is shortened	Chemical attack Mineral deposits at injection point Sediment blockage at injection fitting Seized rollers caused abrasion on tube Exposure to heat or sun	Check chemical compatibility Remove deposits, replace pump tube and ferrules Maintain suction line 2-3" above bottom of tank Clean roller assembly or replace Do not store tubes in high temperatures or in direct sunlight
Tube connection is leaking	Missing ferrule on suction or discharge line Crushed ferrule Ferrule in wrong orientation	Replace ferrule Replace ferrule Reverse orientation of ferrule

TUBE REPLACEMENT



WARNING RISK OF EXPOSURE

-  To reduce risk of exposure, check the pump tube regularly for leakage. At the first sign of leakage, replace the pump tube.
-  To reduce risk of exposure, the use of proper personal protective equipment is mandatory when working on or near metering pumps.
-  To reduce risk of exposure, and also prior to service, shipping, or storage, pump generous amounts of water or a compatible buffer solution to rinse pump.
-  Consult SDS sheet for additional information and precautions for the additive in use.
-  Personnel should be skilled and trained in the proper safety and handling of the additive in use.
-  Inspect tube frequently for leakage, deterioration, or wear. Schedule a regular pump tube maintenance change to prevent damage to pump and/or spillage.





CAUTION PINCH POINT HAZARD:

-  Use extreme caution when replacing pump tube. Be careful of your fingers and **DO NOT** place fingers near rollers.

WARNING HAZARDOUS PRESSURE EXPOSURE:

-  Use caution and bleed off all resident system pressure prior to attempting service or installation.
-  Use caution when disconnecting discharge tubing from pump. Discharge may be under pressure. Tubing may contain fluid being metered.

NOTICE: Indicates special instructions or general mandatory action.

-  **DO NOT** apply grease, oil, or lubricants to the pump tube or housing.
-  Prior to pump tube replacement, inspect the entire pump head for cracks or damaged components. Ensure rollers turn freely.
-  Rinse off fluid residual and clean all fluid and debris from pump head components prior to tube replacement.
-  **DO NOT** pull excessively on pump tube. Avoid kinks or damage during tube installation.
-  Inspect the suction/discharge tubing, injection point (into pipe), and injection fitting for blockages after any tube rupture. Clear or replace as required.

TUBE REPLACEMENT

PREPARATION

1. Follow all safety precautions prior to tube replacement.
2. Prior to service, pump water or a compatible buffer solution through the pump and suction and discharge lines to remove fluid and avoid contact.
3. Unplug the pump.
4. Disconnect the suction and discharge connections from pump head.

TUBE REPLACEMENT continued

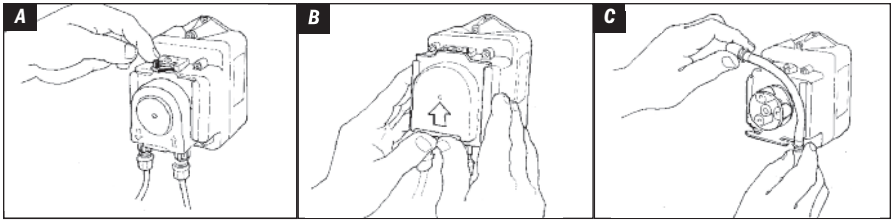

REMOVE TUBE

! Always unplug pump before doing maintenance work.

1. The cover must be removed to program the pump. Remove the self-tapping Phillips head screw and slide the cover off. To unlock the keypad, simultaneously press and hold **MODE** and **%** for 5 seconds. Place pump in **STBY**. First, press and continue to hold **MODE**, then press **STBY**.
2. Unplug the pump.
3. Remove the Phillips head locking screw on the latch (CE models only). Slide the vertical tab 180 degrees from left to right to unlock the cover latch. *Illustration A*
4. To slide cover off, push up on the raised edge. *Illustration B*
5. Release the fittings from the slots to remove the tube. *Illustration C*
6. Remove roller assembly.
7. Use non-citrus all-purpose cleaner to clean residue from pump head housing, roller, and cover.
8. Check cover for cracks. Replace if cracked.
9. Ensure rollers spin freely.
10. Replace roller assembly if: seized, excessive side play from bore wear, or if rollers are visibly worn.
11. Re-install roller assembly.

TUBE REPLACEMENT continued

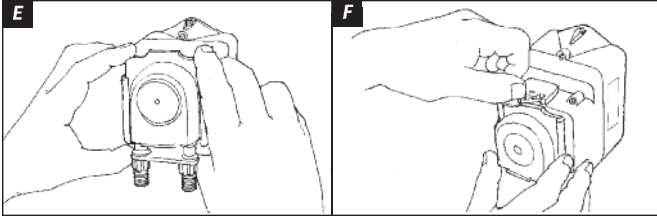
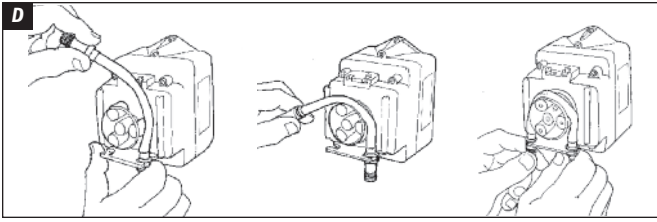

INSTALL NEW TUBE

1. To install new tube, insert one fitting into slot, pull tube around the center of the roller assembly and insert second fitting into the other slot. *Illustration D*
2. Align tube housing cover with track and slide over tube until fully closed. *Illustration E*
3. Plug the pump in.
4. Run the pump to relax the tube. First, press and continue to hold **MODE**, then press **PRIME**, hold both buttons for one minute.
5. To lock cover in place, press down on the cover while turning the vertical tab 180 degrees from right to left. Install the Phillips head locking screw (CE models only). *Illustration F*
6. Take the pump out of standby. First, press and continue to hold **MODE**, then press **STBY**. Run the pump for one minute to verify operation. First, press and continue to hold **MODE**, then press **PRIME**, hold both buttons for one minute.
7. Put pump in standby. First, press and continue to hold **MODE**, then press **STBY**. Reconnect the suction and discharge lines.
8. Prime pump. First, press and continue to hold **MODE**, then press **PRIME**.
9. Place pump in desired operating mode. First, press and continue to hold **MODE**, then press **↑** or **↓**, release both buttons to select operating mode. After programming, slide the cover on and reinstall the screw.

CLEANING THE POINT OF INJECTION – SAFETY INFORMATION

NOTICE: Indicates special instructions or general mandatory action.

The duckbill check valve allows the extension tip to be installed in the center of the pipe directly in the flow of water to help reduce deposit accumulation.

WARNING Warns about hazards that CAN cause death, serious personal injury, or property damage if ignored.

This is the safety alert symbol. When displayed in this manual or on the equipment, look for one of the following signal words alerting you to the potential for personal injury or property damage.

WARNING HAZARDOUS PRESSURE/CHEMICAL EXPOSURE

Use caution and bleed off all resident system pressure prior to attempting service or installation.

Use caution when disconnecting discharge line from pump. Discharge line may be under pressure. Discharge line may contain chemical.

To reduce risk of exposure, the use of proper personal protective equipment is mandatory when working on or near chemical metering pumps.

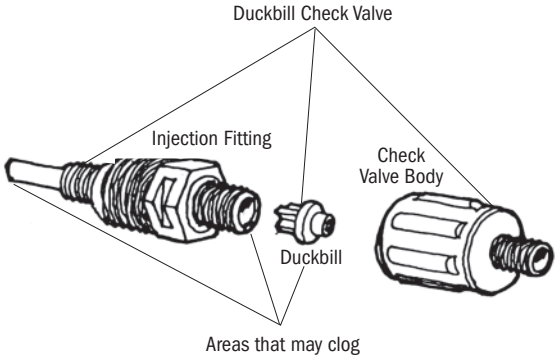

CLEANING THE POINT OF INJECTION continued

1. Turn metering pump off and unplug cord. Disable water pump or auxiliary equipment electrical supply.
2. Depressurize system and bleed pressure from pump discharge line.
3. Loosen and remove connecting nut and ferrule from the duckbill check valve to disconnect discharge tubing:
 - Unscrew the top fitting (check valve body) to disassemble. The bottom fitting (injection fitting with arrow) should remain attached to the pipe.
 - Remove duckbill from check valve body and replace if deteriorated or swollen (replace duckbill with every tube change). If clogged, clean or replace (yearly replacement recommended).
 - Examine O-ring in the injection fitting and replace if deteriorated or damaged.
4. Insert a #2 Phillips head screwdriver through injection fitting into the pipe to locate or break up accumulated deposits. If screwdriver cannot be inserted, drill the deposit out of the injection fitting (DO NOT drill through the opposite pipe wall).

More on next page

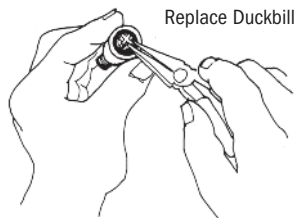

Periodic inspection and cleaning of the point of injection will maintain proper pump operation and provide maximum tube life.

CLEANING THE POINT OF INJECTION continued

5. Replace discharge line if cracked or deteriorated. If the end is clogged, cut off the calcified or blocked section of discharge line:
 - Reassemble the duckbill check valve in reverse order.
 - Replace ferrule and reinstall the discharge line to the duckbill check valve approximately 3/4" until it stops.
6. Tighten the connection nut finger tight.
7. Enable the water pump electrical supply and pressurize the water system.
8. Put the metering pump back in service and inspect all connections for leaks.

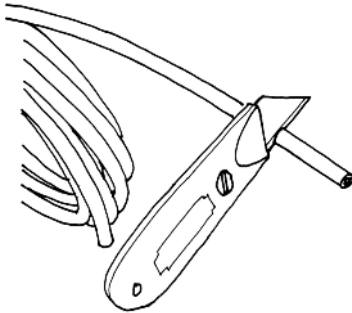

Cut off the calcified or blocked section.

EXPLODED VIEW

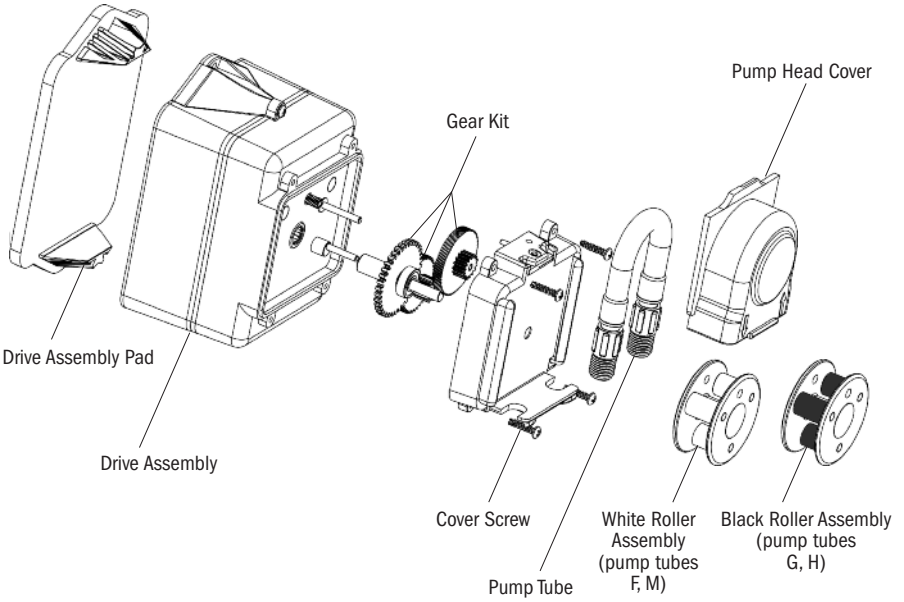

PARTS

DESCRIPTION	EA	2-PK
Gear Kit E10 prefix pumps	EC310 KIT	—————
Gear Kit E20 prefix pumps	EC320 KIT	—————
Drive Assembly Pad	EC302	—————
White Roller Assembly (works with tube F, M)	EC350	—————
Black Roller Assembly (works with tubes G, H)	EC351	—————
F Santoprene® Pump Tube, ferrules 1/4" (works with white roller assembly)	—————	EC30F-2
M Santoprene® Pump Tube, ferrules 1/4" (works with white roller assembly)	—————	EC30M-2
G Santoprene® Pump Tube, ferrules 1/4" (works with black roller assembly)	—————	EC30G-2
H Santoprene® Pump Tube, ferrules 1/4" (works with black roller assembly)	—————	EC30H-2
F Santoprene® Pump Tube, ferrules 6 mm <i>Europe</i> (works with white roller assembly)	—————	EC30FCE-2
M Santoprene® Pump Tube, ferrules 6 mm <i>Europe</i> (works with white roller assembly)	—————	EC30MCE-2
G Santoprene® Pump Tube, ferrules 6 mm <i>Europe</i> (works with black roller assembly)	—————	EC30GCE-2
H Santoprene® Pump Tube, ferrules 6 mm <i>Europe</i> (works with black roller assembly)	—————	EC30HCE-2
Pump Head Cover	EC355	—————
Mounting Kit For wall mount or Stenner tank	EC303 KIT	—————
Stand For horizontal display or wall mount	EC304	—————

MOUNTING TEMPLATE

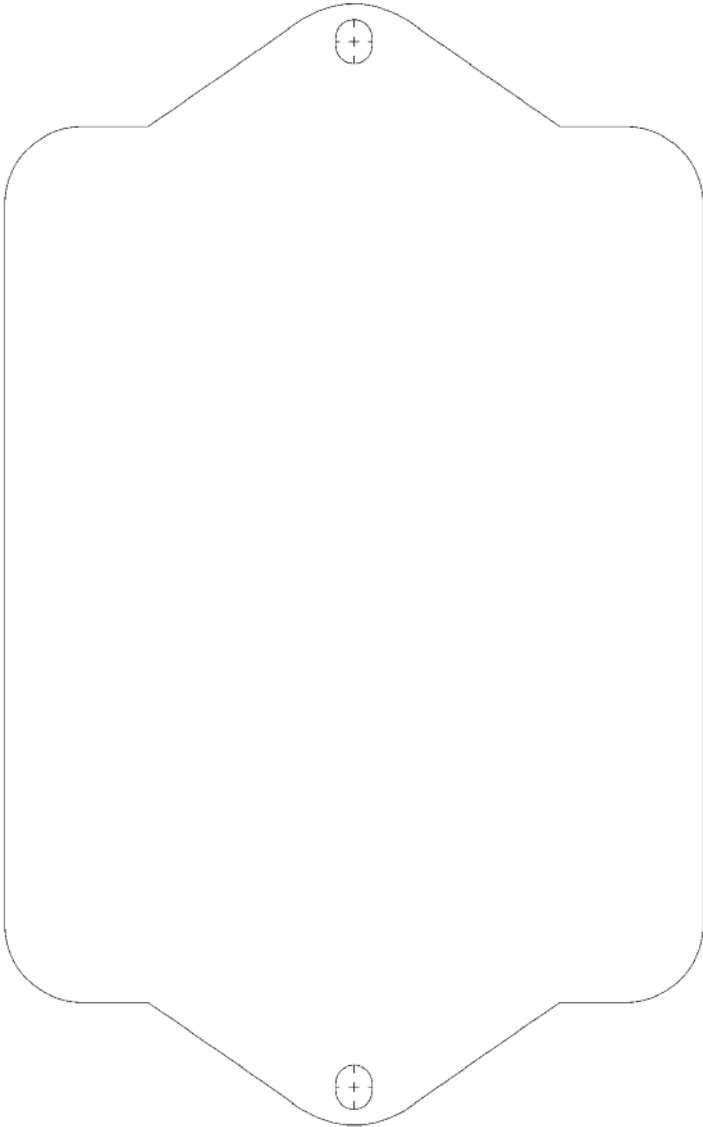

STENNER PUMPS[®]

STENNER PUMP COMPANY

3174 DeSalvo Road
Jacksonville, Florida 32246 USA

Phone: 904.641.1666

US Toll Free: 800.683.2378

Fax: 904.642.1012

sales@stenner.com

www.stenner.com

Hours of Operation (EST):

Mon.-Thu. 7:30 am-5:30 pm

Fri. 7:00 am-5:30 pm

 Assembled in the USA

© Stenner Pump Company
All Rights Reserved