

63
Friendship Way
Wheatley ON

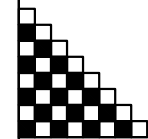

LIOVAS HOMES

63 Friendship Way, Wheatley

drawings

**FINAL
DRAWINGS**

JANUARY 26, 2022

CONTACT: MICAELA LYPPS
CELL: 519-999-6885
EMAIL: micalalypss@yahoo.com

DRAWINGS

design REHAB



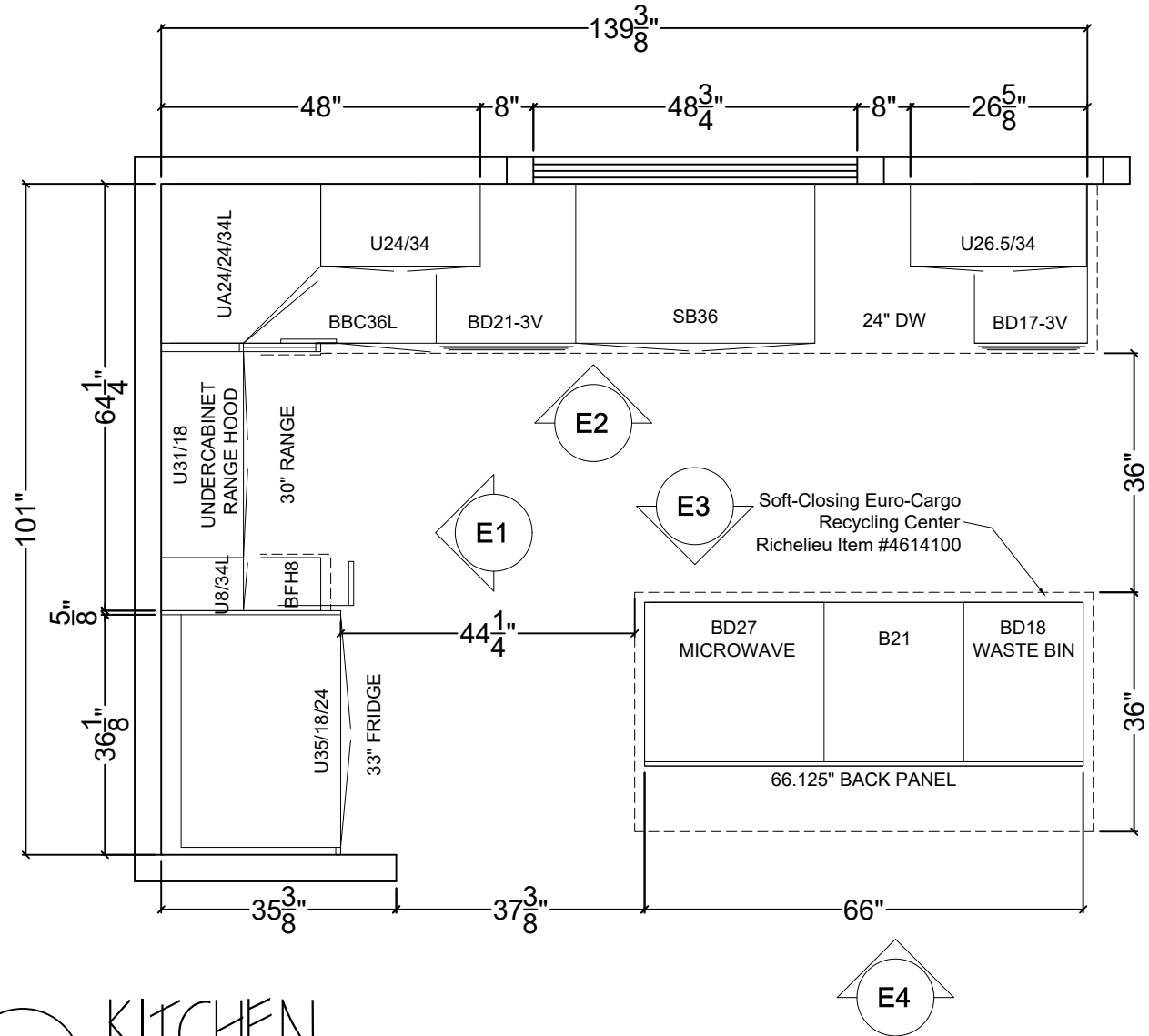

F1 KITCHEN
FLOORPLAN

63
Friendship Way
Wheatley ON

**FINAL
DRAWINGS**

JANUARY 26, 2022

CONTACT: MICAELA LYPPS
CELL: 519-999-6885
EMAIL: micalalypss@yahoo.com

DRAWINGS

design REHAB



approved by: _____

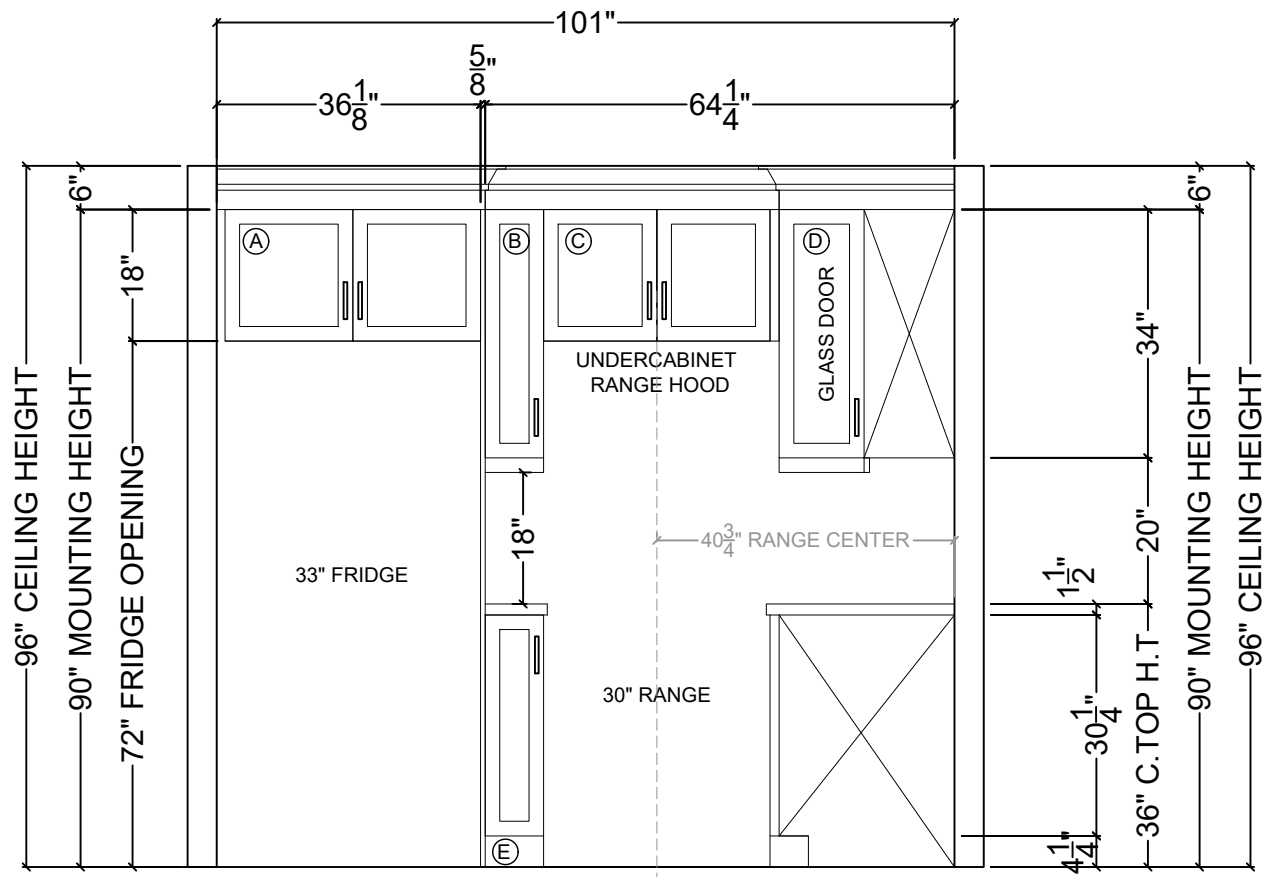

E1 KITCHEN
ELEVATION

63
Friendship Way
Wheatley ON

**FINAL
DRAWINGS**

JANUARY 26, 2022

CONTACT: MICAELA LYPPS
CELL: 519-999-6885
EMAIL: micaelalypss@yahoo.com

DRAWINGS

design REHAB



approved by: _____

CABINET "A"

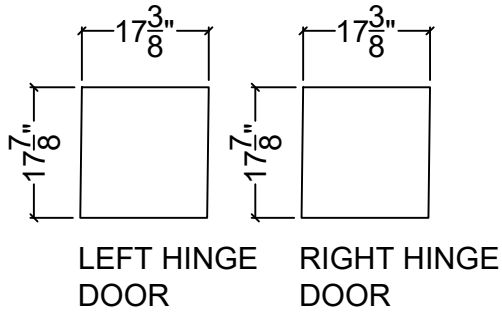

CABINET "B"

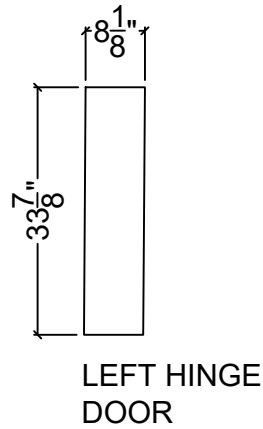

CABINET "C"

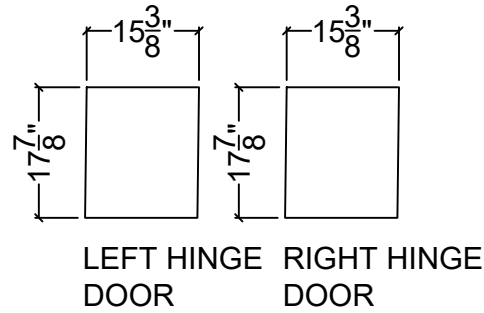

CABINET "D"

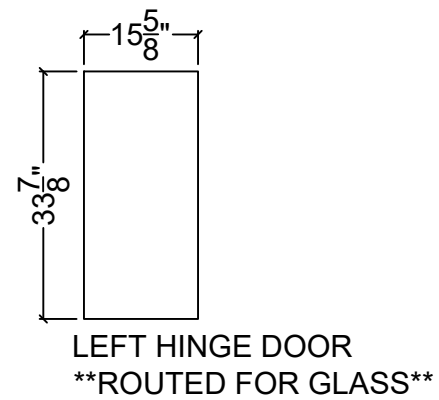

CABINET "E"

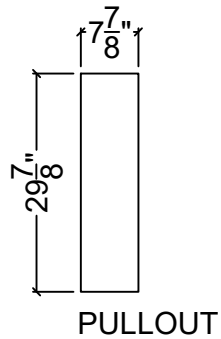

63

Friendship Way
Wheatley ON

FINAL DRAWINGS

JANUARY 26, 2022

CONTACT: MICAELA LYPPS
CELL: 519-999-6885
EMAIL: micalalypss@yahoo.com

DRAWINGS

design REHAB



approved by: _____

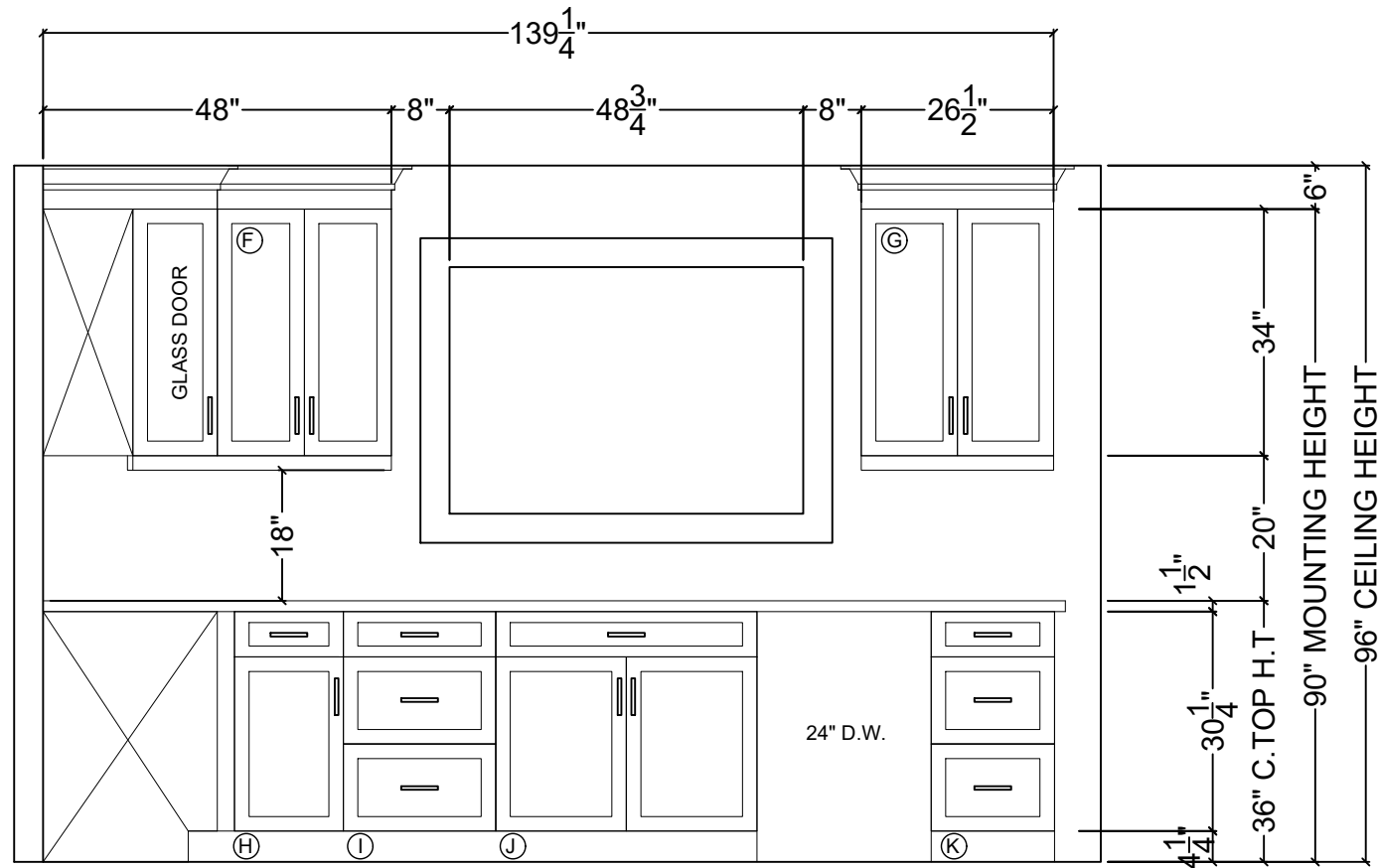

E2 KITCHEN
ELEVATION

63
Friendship Way
Wheatley ON

**FINAL
DRAWINGS**

JANUARY 26, 2022

CONTACT: MICAELA LYPPS
CELL: 519-999-6885
EMAIL: micaelalypss@yahoo.com

DRAWINGS

design REHAB



approved by: _____

CABINET "F"

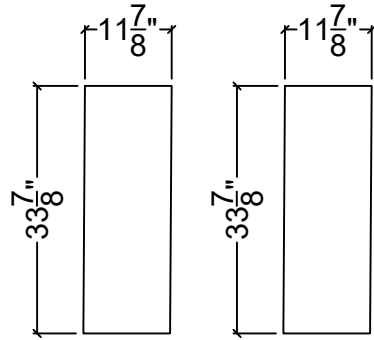

LEFT HINGE DOOR RIGHT HINGE DOOR

CABINET "G"

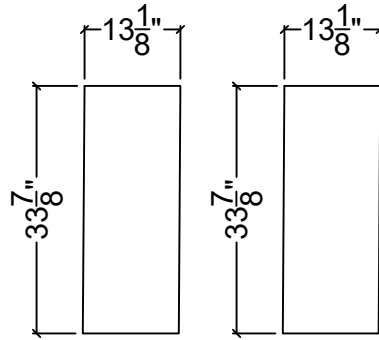

LEFT HINGE DOOR RIGHT HINGE DOOR

CABINET "H"

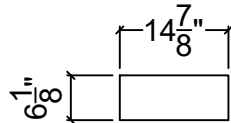

DRAWER FRONT

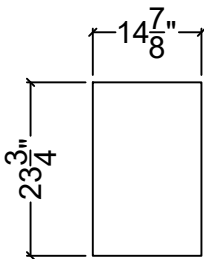

LEFT HINGE DOOR

CABINET "I"

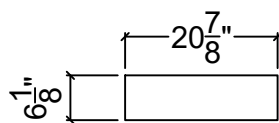

DRAWER FRONT

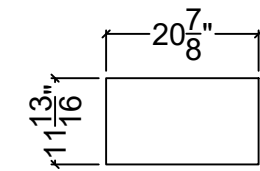

DRAWER FRONT

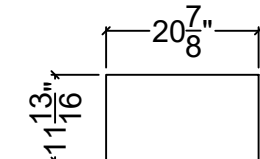

DRAWER FRONT

CABINET "J"

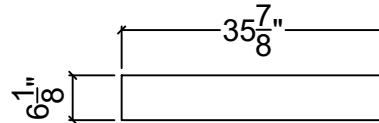

FALSE DRAWER FRONT

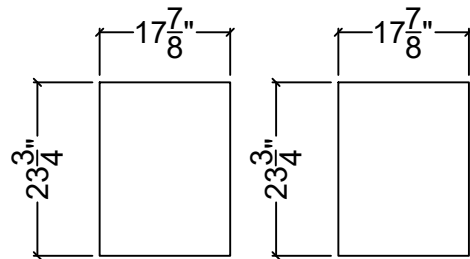

LEFT HINGE DOOR RIGHT HINGE DOOR

CABINET "K"

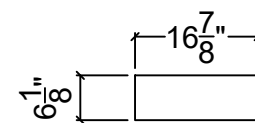

DRAWER FRONT

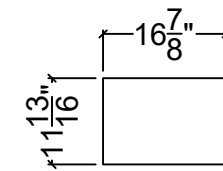

DRAWER FRONT

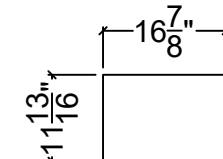

DRAWER FRONT

63

Friendship Way
Wheatley ON

FINAL DRAWINGS

JANUARY 26, 2022

CONTACT: MICAELA LYPPS
CELL: 519-999-6885
EMAIL: micaelalypss@yahoo.com

DRAWINGS

design REHAB



approved by: _____

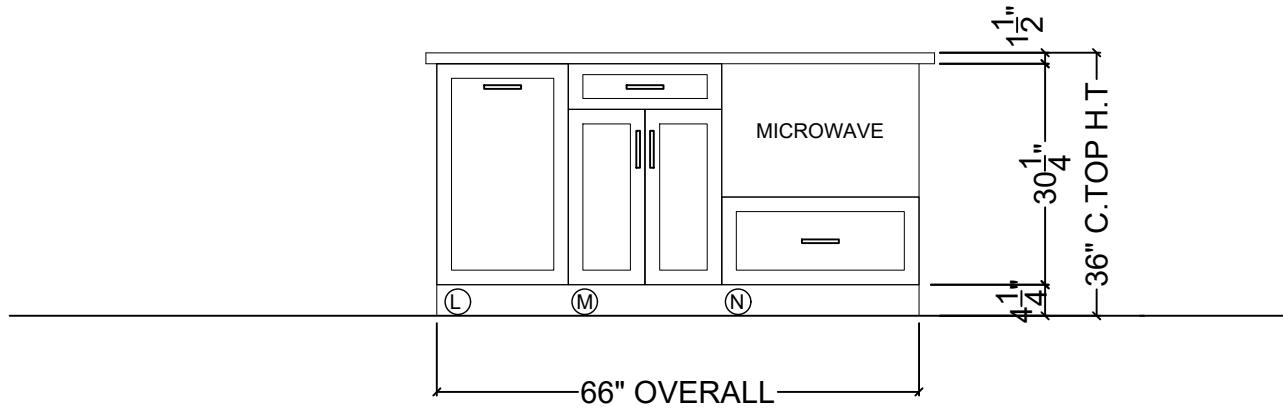

CABINET "L"

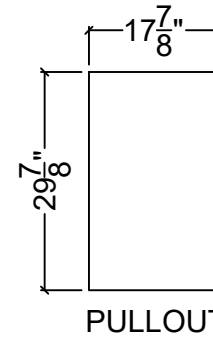

E3 KITCHEN
ELEVATION

CABINET "M"

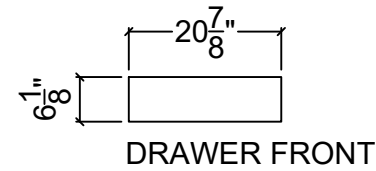

CABINET "N"

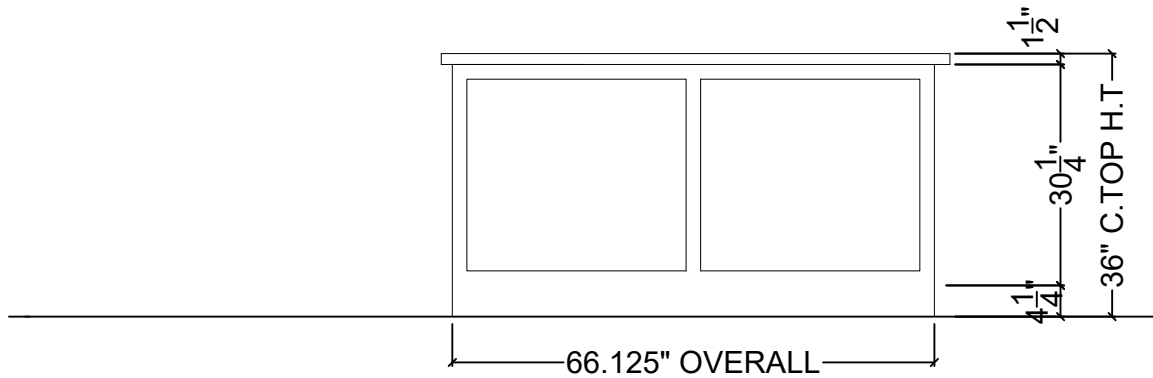
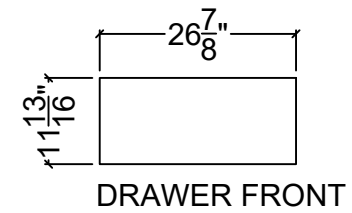

E4 KITCHEN
ELEVATION

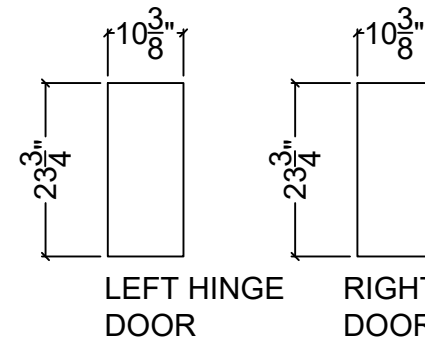

63
Friendship Way
Wheatley ON

FINAL DRAWINGS

JANUARY 26, 2022

CONTACT: MICAELA LYPPS
CELL: 519-999-6885
EMAIL: micaelalypss@yahoo.com

DRAWINGS

design REHAB



approved by: _____

CABINET "O"

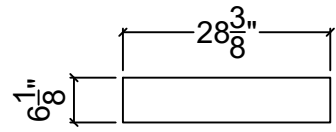

FALSE DRAWER FRONT

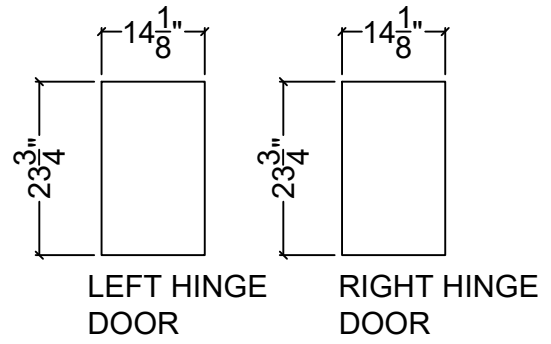

LEFT HINGE DOOR

RIGHT HINGE DOOR

E5 MAIN BATH
ELEVATION

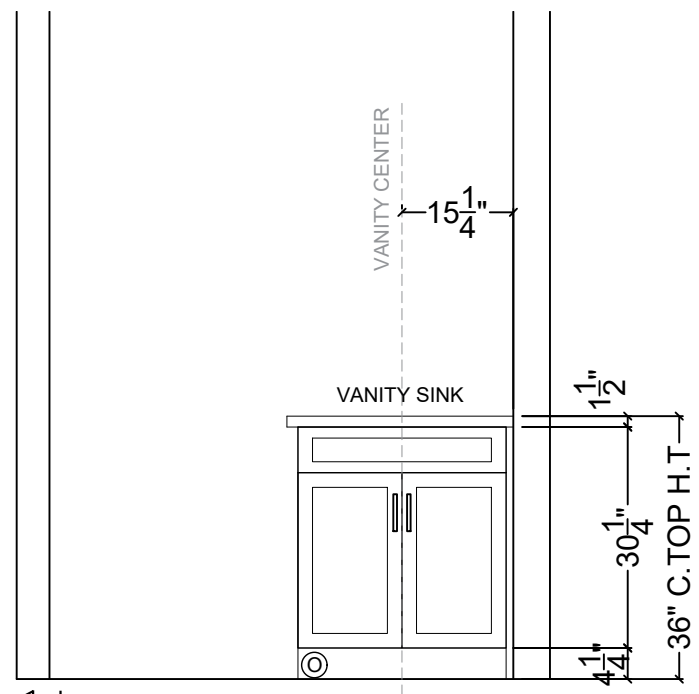

F2 MAIN BATH
FLOORPLAN

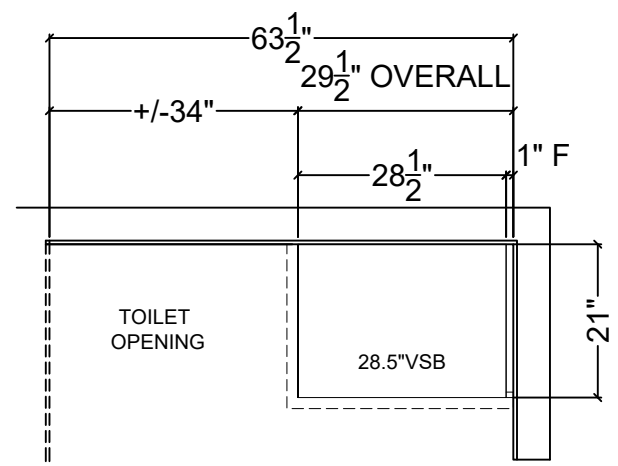

approved by: _____

63
Friendship Way
Wheatley ON

FINAL DRAWINGS

JANUARY 26, 2022

CONTACT: MICAELA LYPPS
CELL: 519-999-6885
EMAIL: micaelalypss@yahoo.com

DRAWINGS

design REHAB



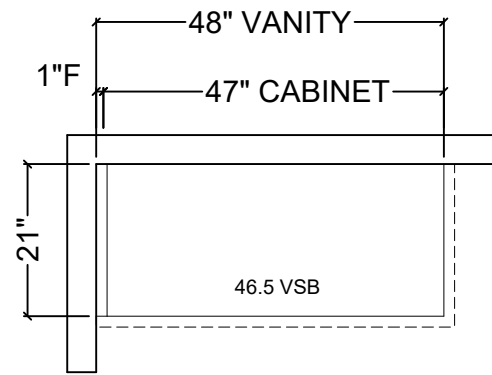
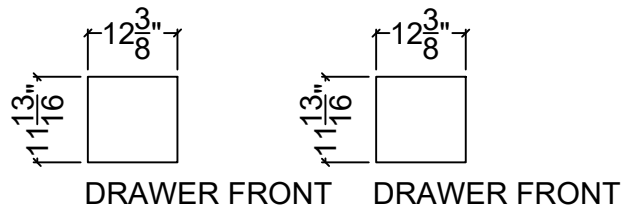
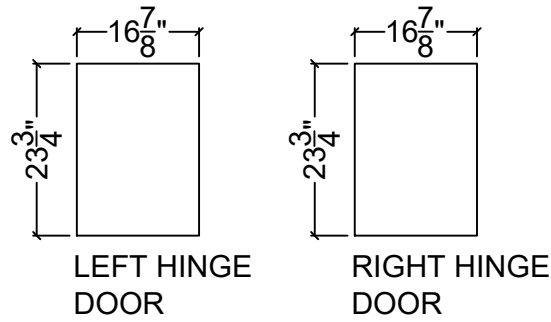
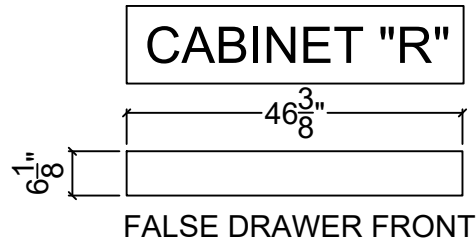

F3 MAIN BATH
 FLOORPLAN

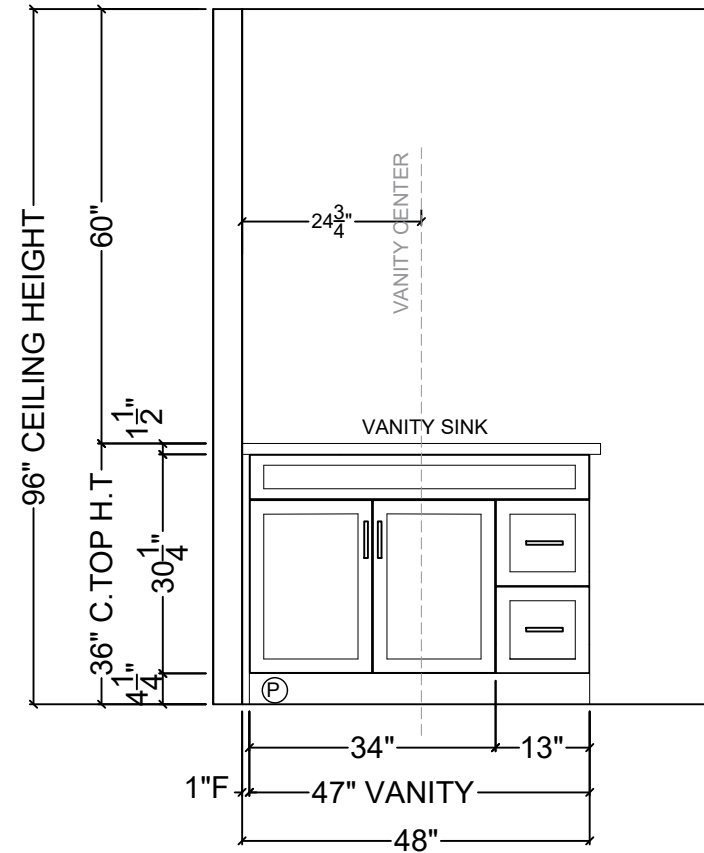

E6 MAIN BATH
 ELEVATION

63
 Friendship Way
 Wheatley ON

FINAL DRAWINGS

JANUARY 26, 2022

CONTACT: MICAELA LYPPS
 CELL: 519-999-6885
 EMAIL: micaelalypss@yahoo.com

DRAWINGS

design REHAB



approved by: _____