

# UV COATED POLYMER



**D-STONA<sup>®</sup>**  
SIGNATURE WALLS





SMOKED DARK OAK



SMOKED MAPLE

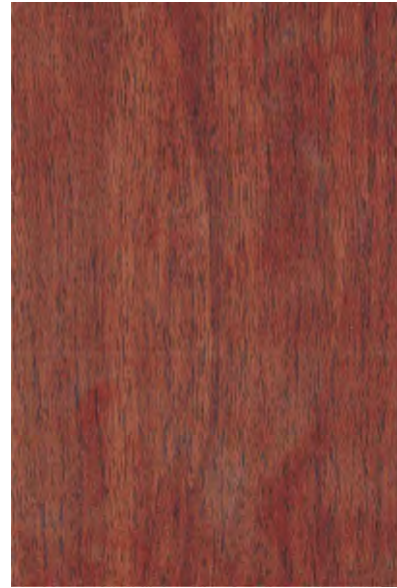

QUEENSLAND WALNUT

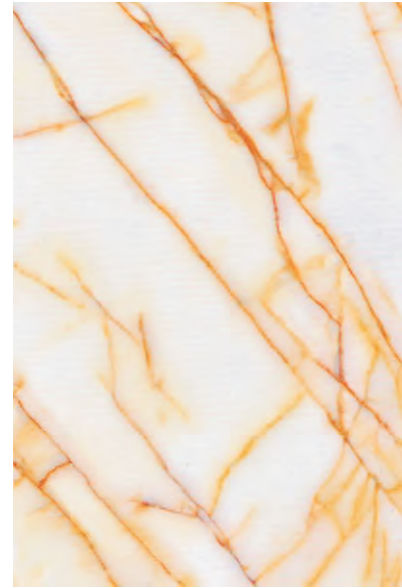

GOLD VEIN

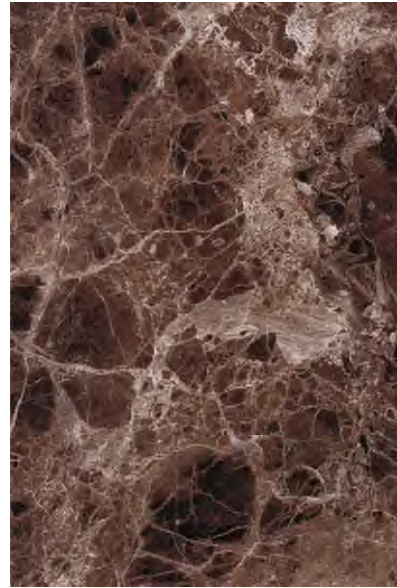

BLACK EMPRADOR



AZALEA BLACK



BEIGE TRAVERTINE



LAVANTE



SILVER TRAVERTINE

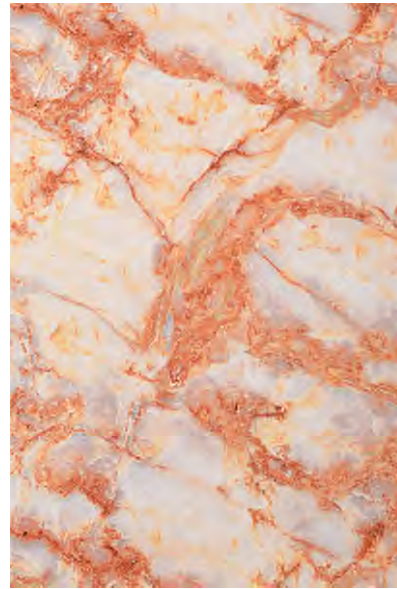

ONYX TROPICAL

NOTE: AVAILABLE IN MATT AND GLOSS SURFACE FINISH

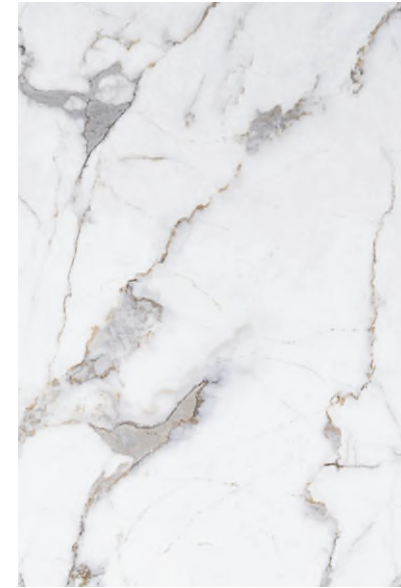

STATUARIO

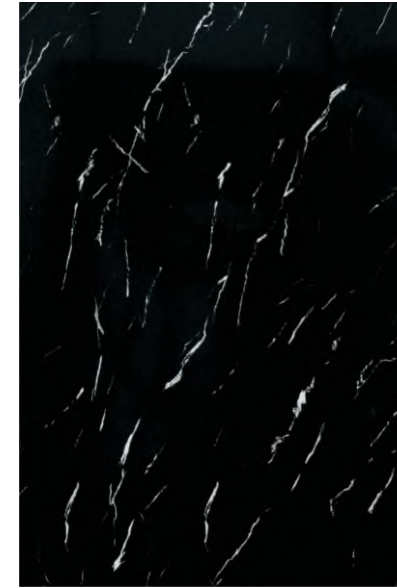

BLACK MARQUINA

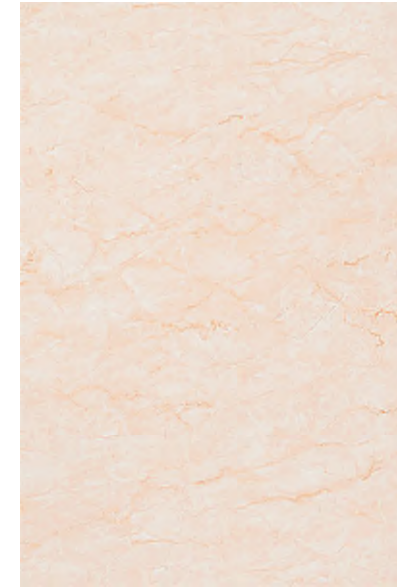

BOTTOCHINO

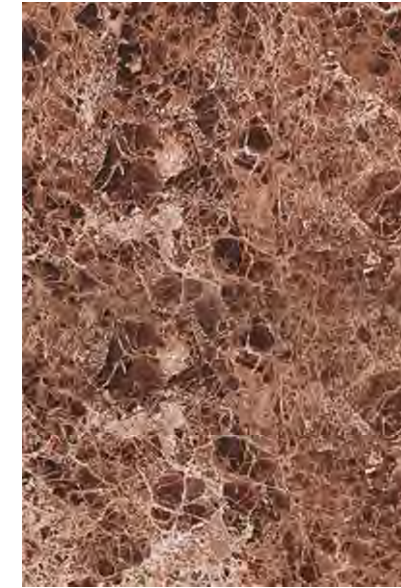

BROWN EMPRADOR

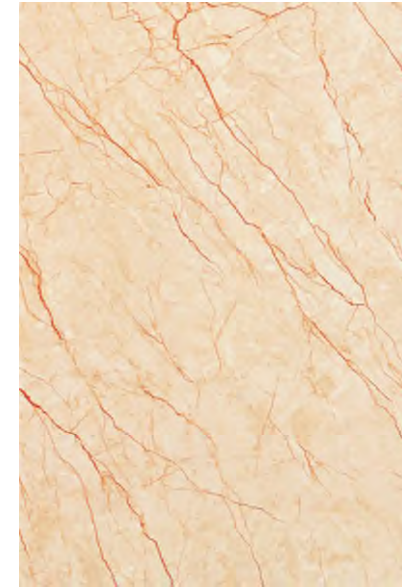

CREMA ZAFRA

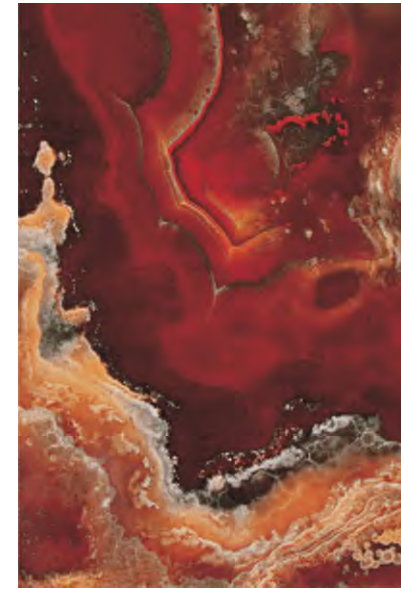

RED ONYX

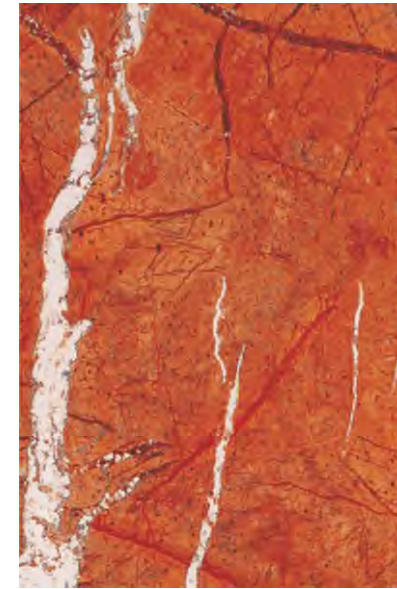

JAISALMER RED

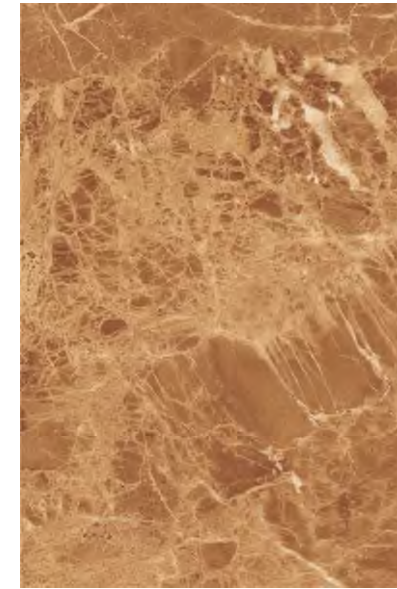

GOLDEN EMPRADOR



SILVER PORTORO

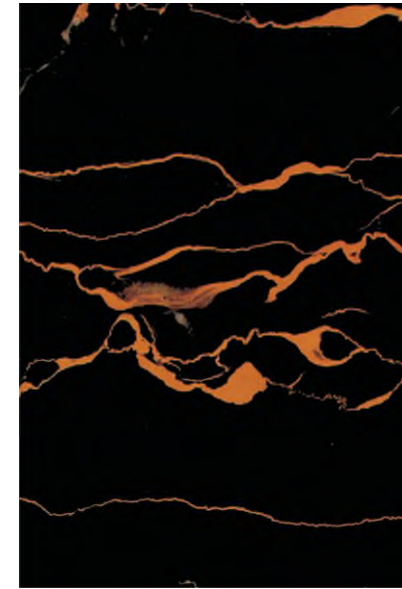

GOLDEN PORTORO

NOTE: AVAILABLE IN MATT AND GLOSS SURFACE FINISH



**D-STONA MOLDINGS**

**FR3025**

Applications : Frames, Jambs, Coves etc.

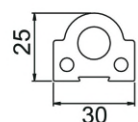

30mm x 25mm x 2900mm

With wide range of applications, D-stona is sure to add elegance to your interiors by giving it a touch of class, its beautiful mouldings and metal sections give the perfect look for walls and a wide range of furniture.

**FR6021**

Applications : Frames, Jambs, Coves etc.

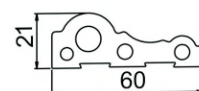

60mm x 21mm x 2900mm

**FR15039**

Applications : Frames, Jambs, Coves etc.

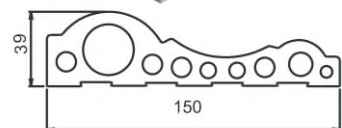
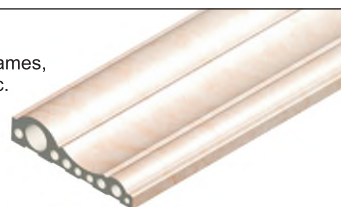

150mm x 39mm x 2900mm

**ED5032**

Applications : Frames, Jambs, Coves etc.

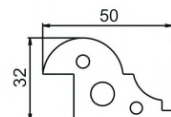
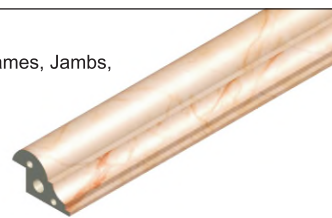

50mm x 32mm x 2900mm

**FR5030**

Applications : Frames, Jambs, Coves etc.

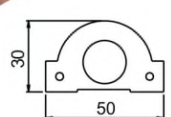

50mm x 30mm x 2900mm

**FI15020**

Applications : Pillar claddings, wall claddings etc.

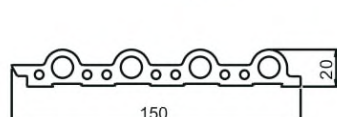

150mm x 20mm x 2900mm

**IC2323**

Applications : Corner Covering etc.

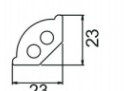
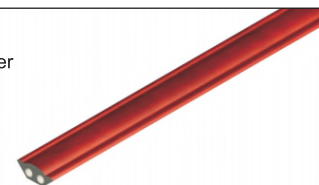

23mm x 23mm x 2900mm

**FR10030**

Applications : Frames, Jambs, Coves etc.

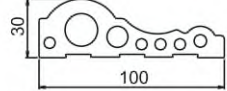
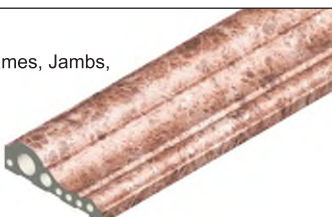

100mm x 30mm x 2900mm

**SK12012**

Applications : Skirtings, Frames etc.

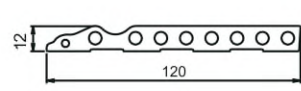

120mm x 12mm x 2900mm

**IC11427**

Applications : Cornices, Skirtings, Corner coverings etc.

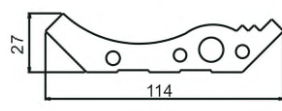
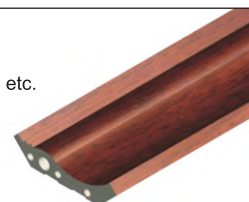

50mm x 30mm x 2900mm

**D-STONA SHEET & ACCESSORIES**

**SHEET**

**ST84**

Applications : Wall Claddings, False ceilings etc.



2440

1220

2440mm x 1220mm x 3.3mm

**PVC WALL BASE BOARD**

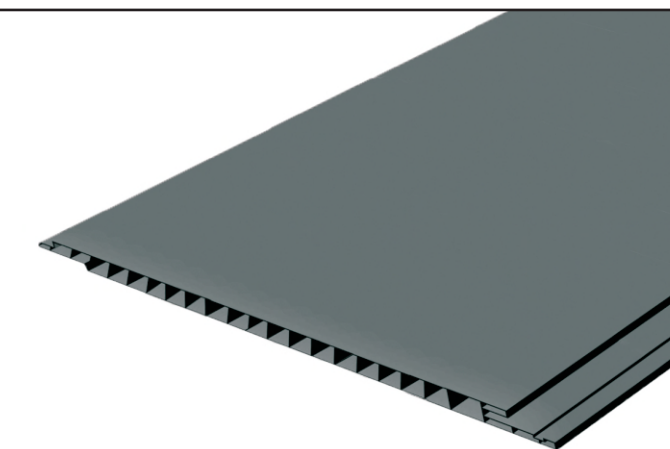

300 mm x 8 mm x 10 feet

Application: Covering undulations in plastered walls to paste D-stona.

**ACCESSORIES**

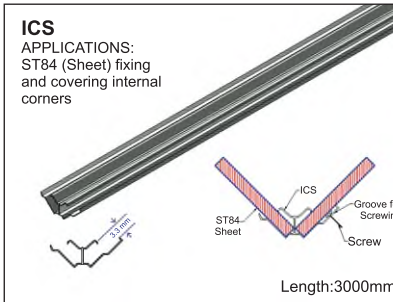
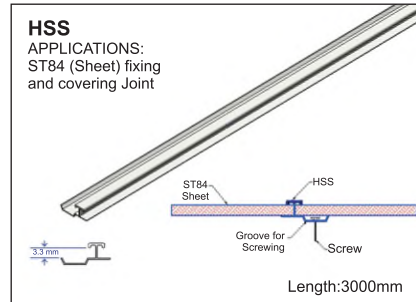
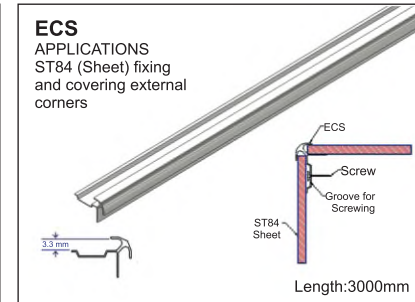
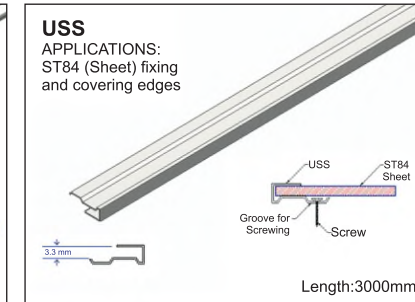
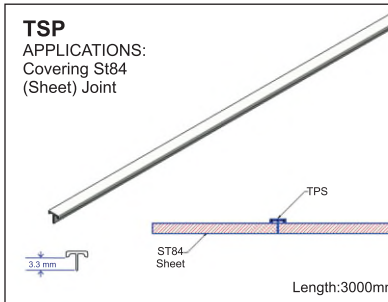



**D-STONA INSTALLATION PROCESS**

Dstona fabrication requires almost the same tools that are used for wood fabrication. It can be cut into required sizes using a mitre saw or a hand cutter and for final adjustments a planer knife can be used over the edges, Compared to many traditional products, Dstona is hassle free to install and requires no polishing or maintenance. Generally pasted on our 'PVC wall base boards' using structural silicone adhesives, It can also be pasted over cement and wood surfaces. And with our metal section accessories, Dstona sheets can be quickly fixed using just screws, saving cost on both labour and adhesive.



Molding cutting using a miter saw.



Molding joint surface planing using a planar knife.



Molding pasting using adhesive.



Joint in moldings.



Sheet cutting using a hand cutter.



Sheet pasting using adhesive.

**D-STONA ROUND PILLARS**



ORIENTAL BLACK



CARMEN WHITE



GOLDEN EMPRADOR



CREMA ZAFRA

INNER DIAMETER :9"  
OUTER DIAMETER :10"

10 Feet





  
**D-STONA T.V. BACK WALL**

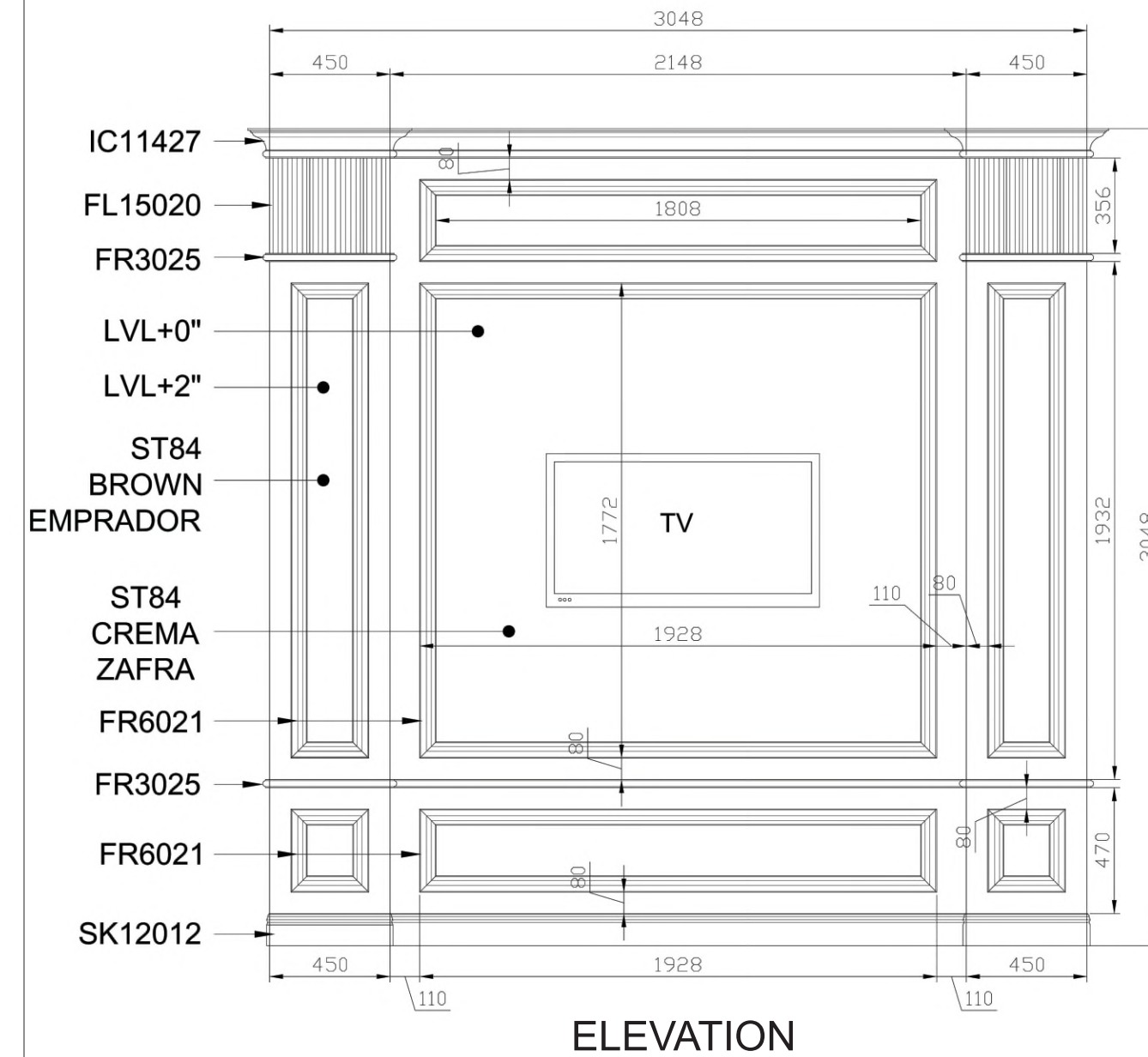

ALL DIMENSIONS IN 'mm'  
(1ft = 12 inch = 304.8mm)

**ESTIMATED BILL OF MATERIALS**  
(T.V. WALL ONLY)

PROFILE	COLOUR	QUANTITY
ST84	CREMA ZAFRA	68 sq.ft.
ST84	BLACK EMPRADOR	14 sq.ft.
IC11427	CREMA ZAFRA	11'8" r.ft.
FR3025	CREMA ZAFRA	26'0" r.ft.
FL15020	CREMA ZAFRA	9'4" r.ft.
FR6021	CREMA ZAFRA	88'10" r.ft.
SK12012	CREMA ZAFRA	11'0" r.ft.

**RECOMMENDED OTHER COLOUR COMBINATION**

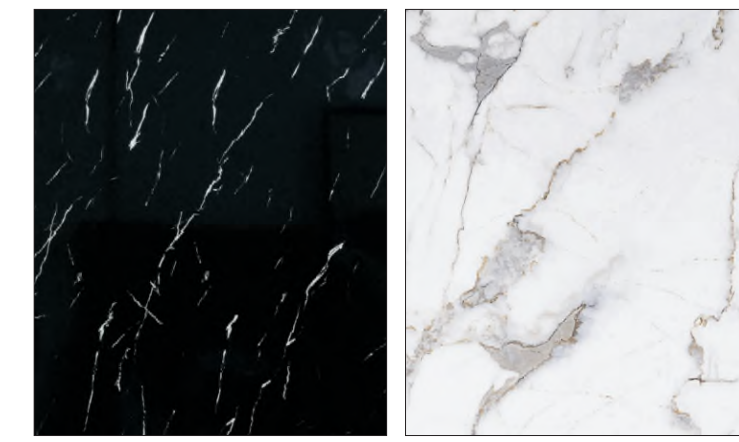

BLACK MARQUINA
STATUARIO





  
**D-STONA DOOR JAMB**

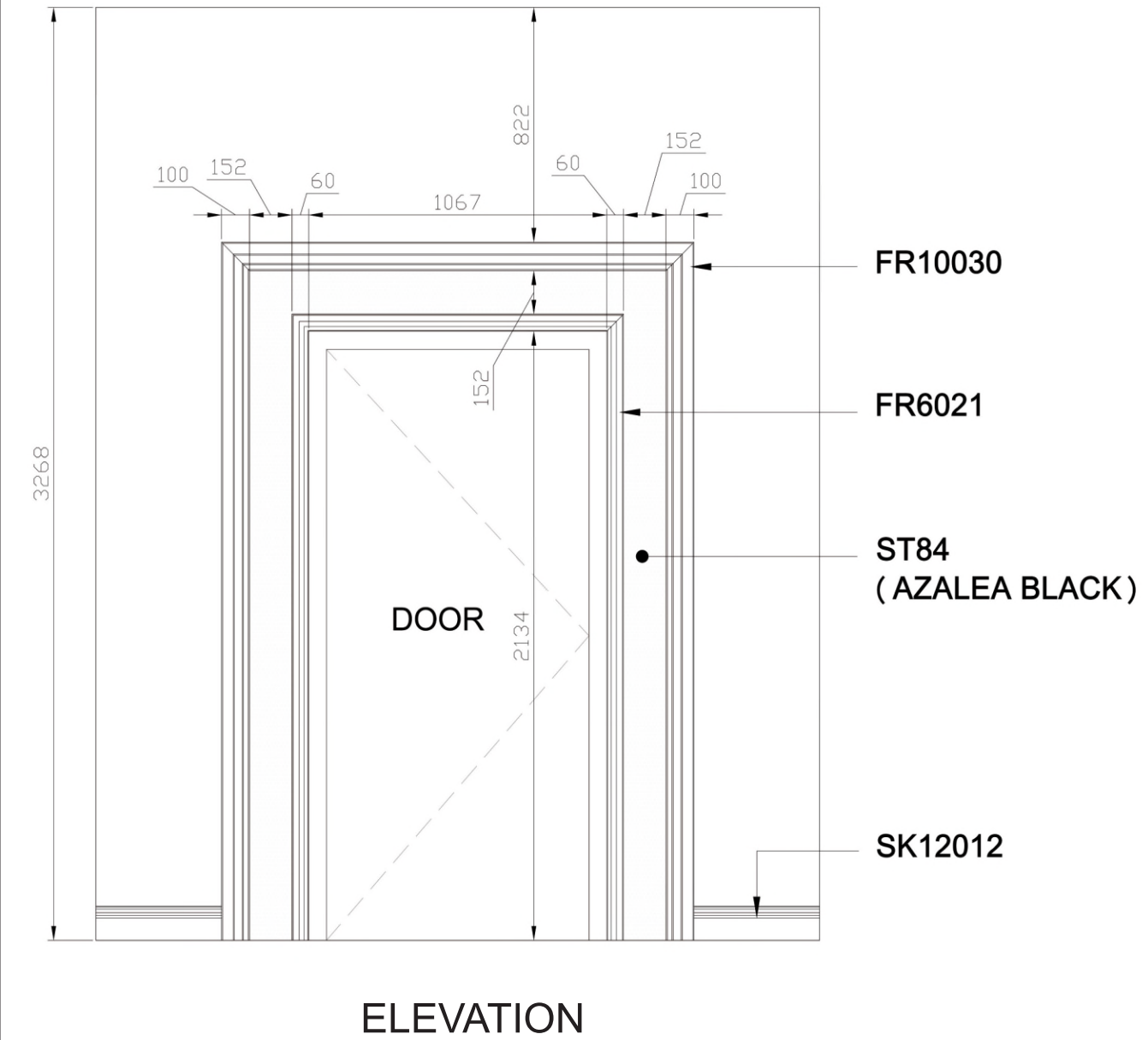

ALL DIMENSIONS IN 'mm'  
(1ft = 12 inch = 304.8mm)

**ESTIMATED BILL OF MATERIALS  
(DOOR JAMB ONLY)**

PROFILE	COLOUR	QUANTITY
ST84	AZALEA BLACK	10 sq.ft.
FR10030	BEIGE TRAVERTINE	21'7" r.ft.
FR6021	BEIGE TRAVERTINE	18'4" r.ft.

**RECOMMENDED OTHER COLOUR COMBINATION**



CREMA ZAFRA

SILVER TRAVERTINE





  
**D-STONA STAIRCASE WALL**

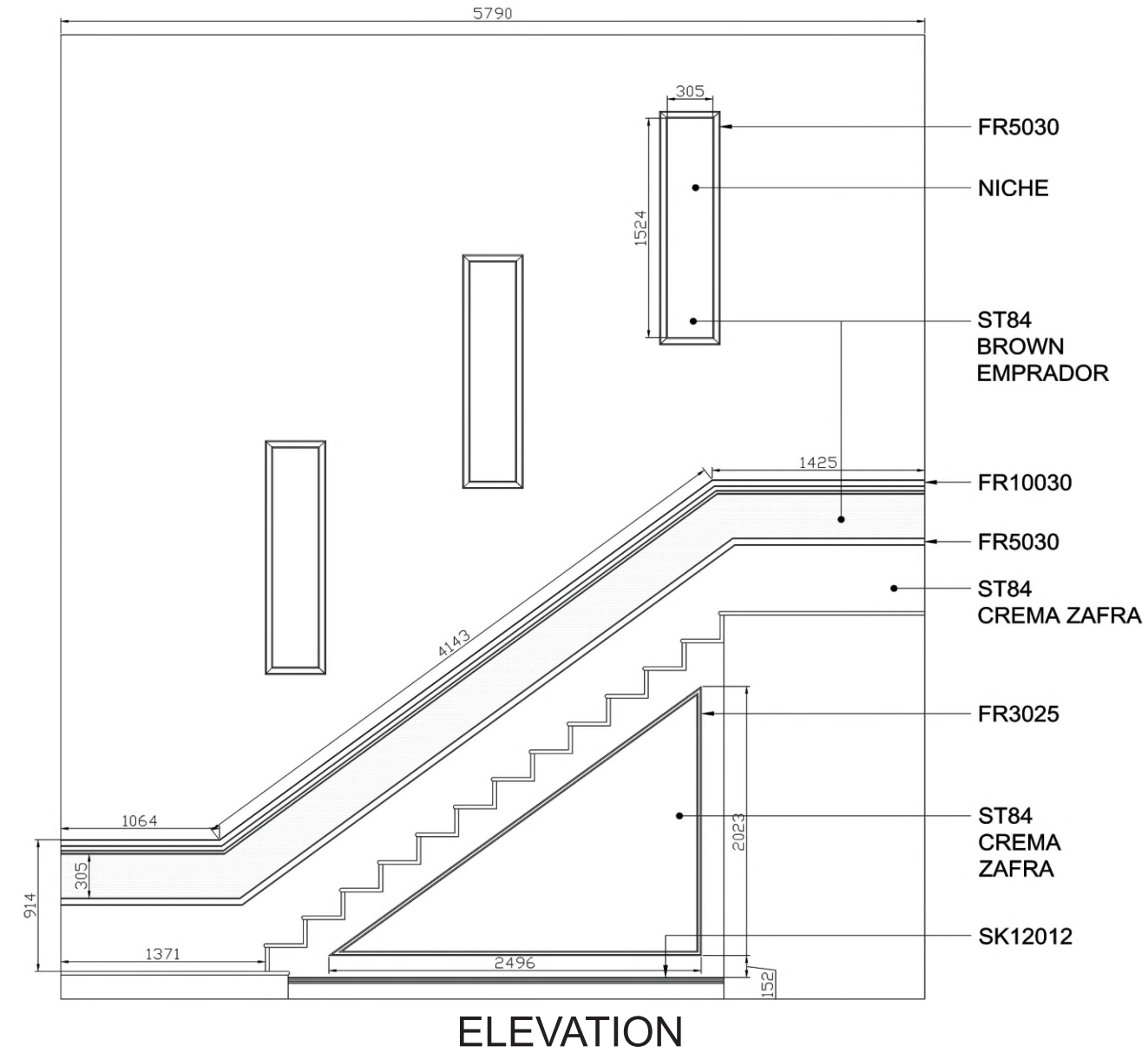

ALL DIMENSIONS IN 'mm'  
(1ft = 12 inch = 304.8mm)

**ESTIMATED BILL OF MATERIALS**  
(ONLY THE WALL OPPOSITE TO RAILING)

PROFILE	COLOUR	QUANTITY
ST84	BROWN EMPRADOR	22 sq.ft.
ST84	CREMA ZAFRA	33 sq.ft.
FR10030	CREMA ZAFRA	22' r.ft.
FR6021	CREMA ZAFRA	22' r.ft.

**RECOMMENDED OTHER COLOUR COMBINATION**

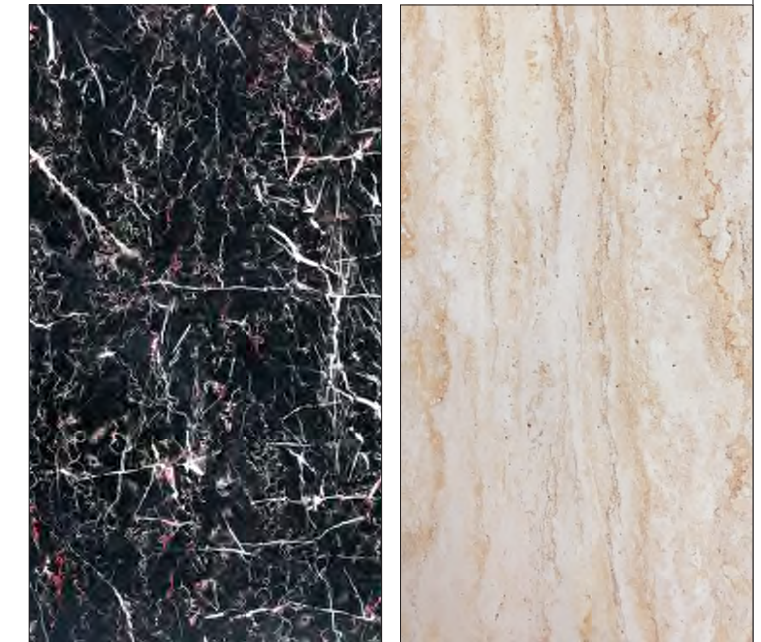

AZALEA BLACK

BEIGE TRAVERTINE





  
**D-STONA BED BACK WALL**

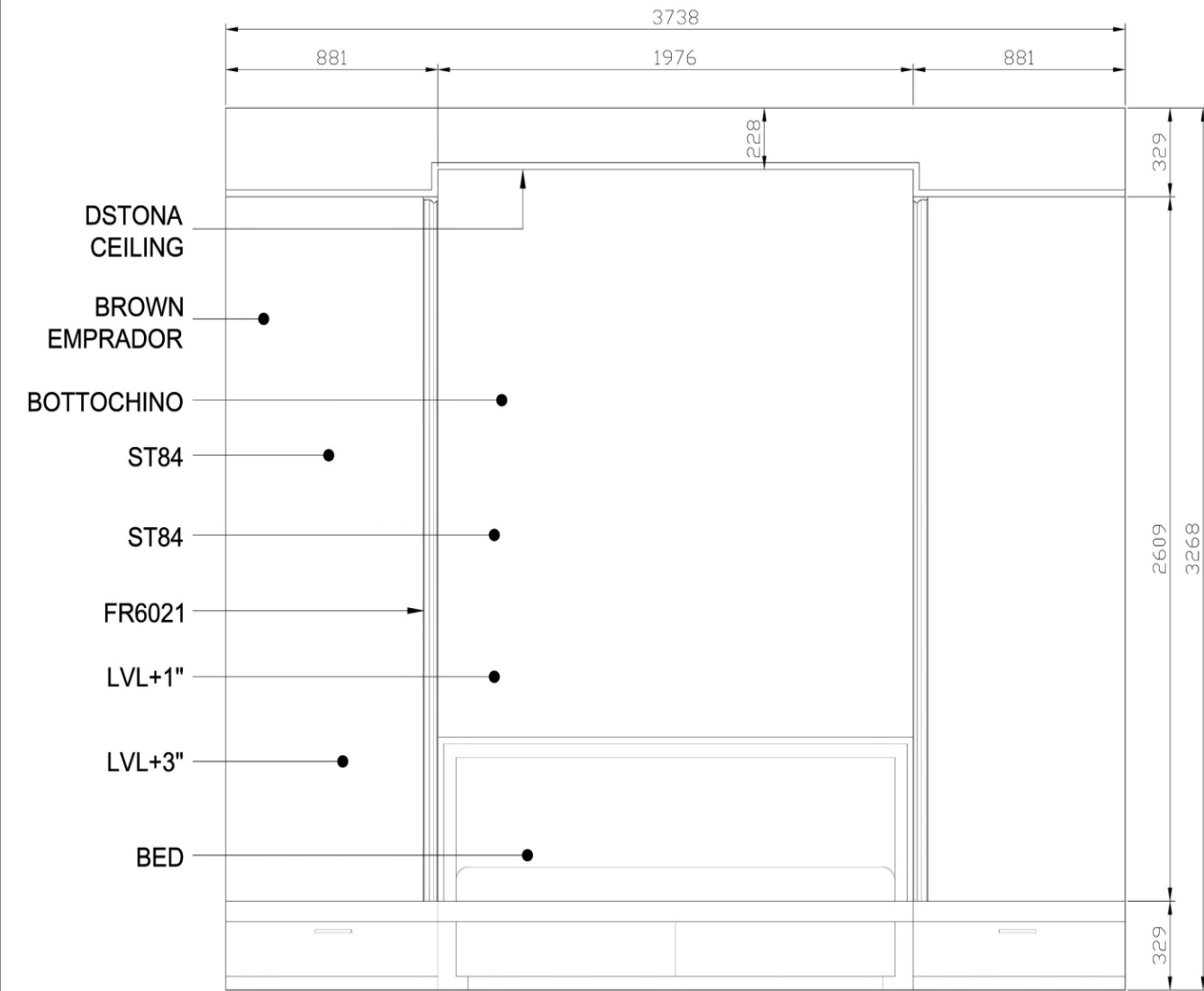

**ELEVATION**

ALL DIMENSIONS IN 'mm'  
(1ft = 12 inch = 304.8mm)

**ESTIMATED BILL OF MATERIALS  
(BACK WALL ONLY)**

PROFILE	COLOUR	QUANTITY
ST84	BOTTOCHINO	70 sq.ft.
ST84	BROWN EMPRADOR	52 sq.ft.
FR6021	EMPRADOR	19'3" r.ft.

**RECOMMENDED OTHER COLOUR COMBINATION**

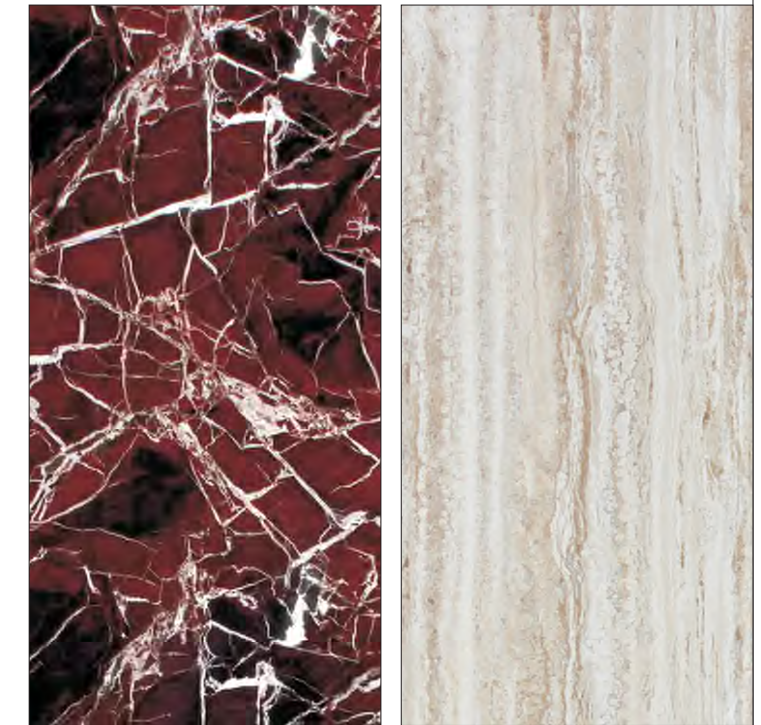

LAVANTE

SILVER TRAVERTINE





  
**D-STONA FALSE CEILING**

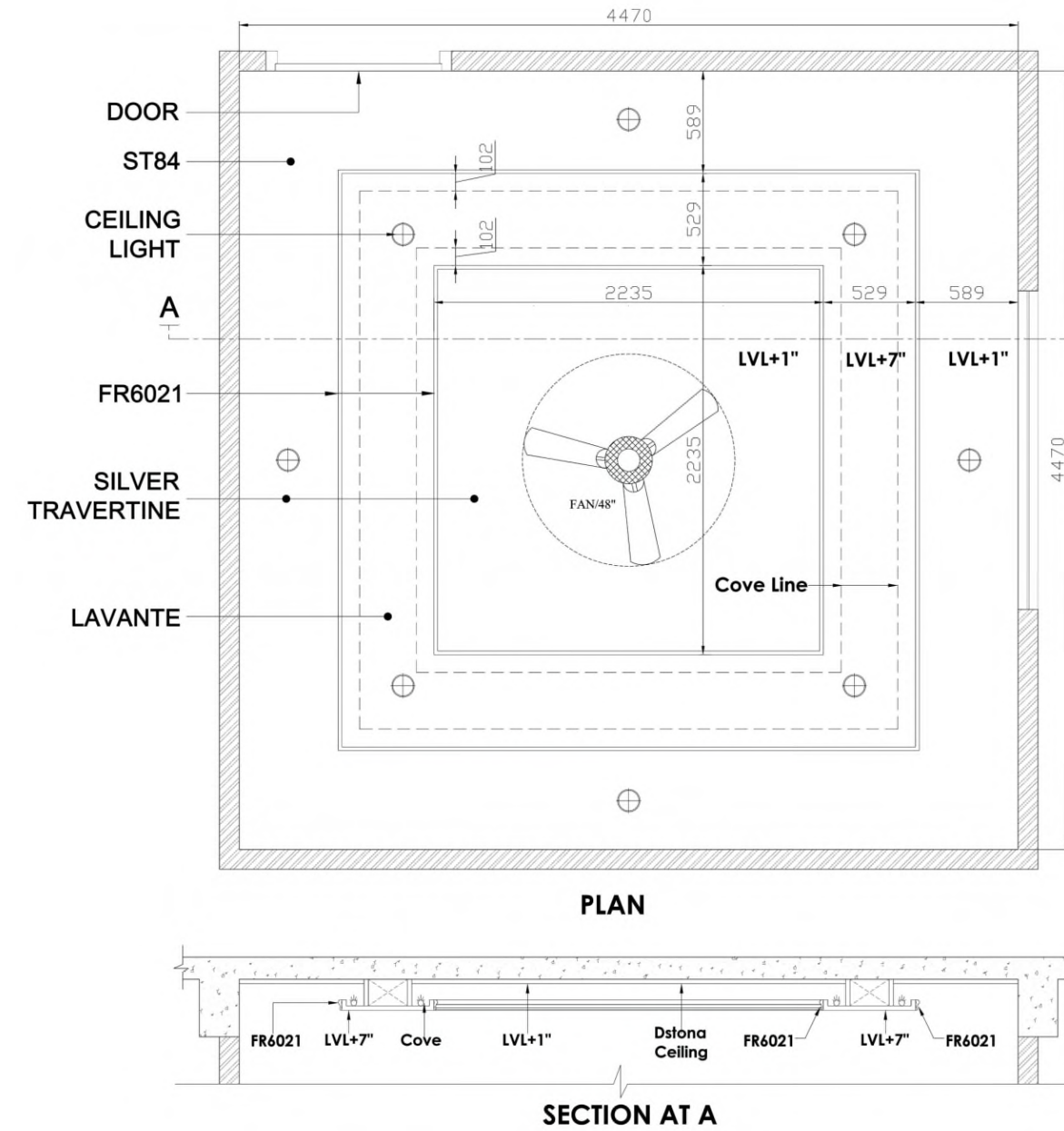

ALL DIMENSIONS IN 'mm'  
(1ft = 12 inch = 304.8mm)

**ESTIMATED BILL OF MATERIALS  
(CEILING ONLY)**

PROFILE	COLOUR	QUANTITY
ST48	SILVER TRAVERTINE	190 sq.ft.
ST48	LAVANTE	63 sq.ft.
FR6021	SILVER TRAVERTINE	73'1"r.ft.

**RECOMMENDED OTHER COLOUR COMBINATION**

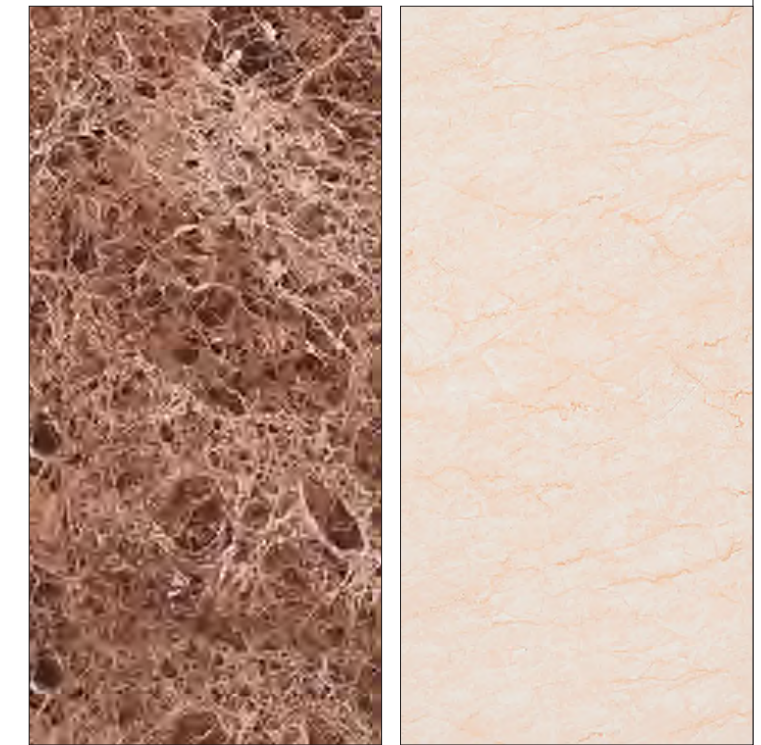

BROWN EMPRADOR

BOTTOCHINO





  
**D-STONA WINDOW JAMB**

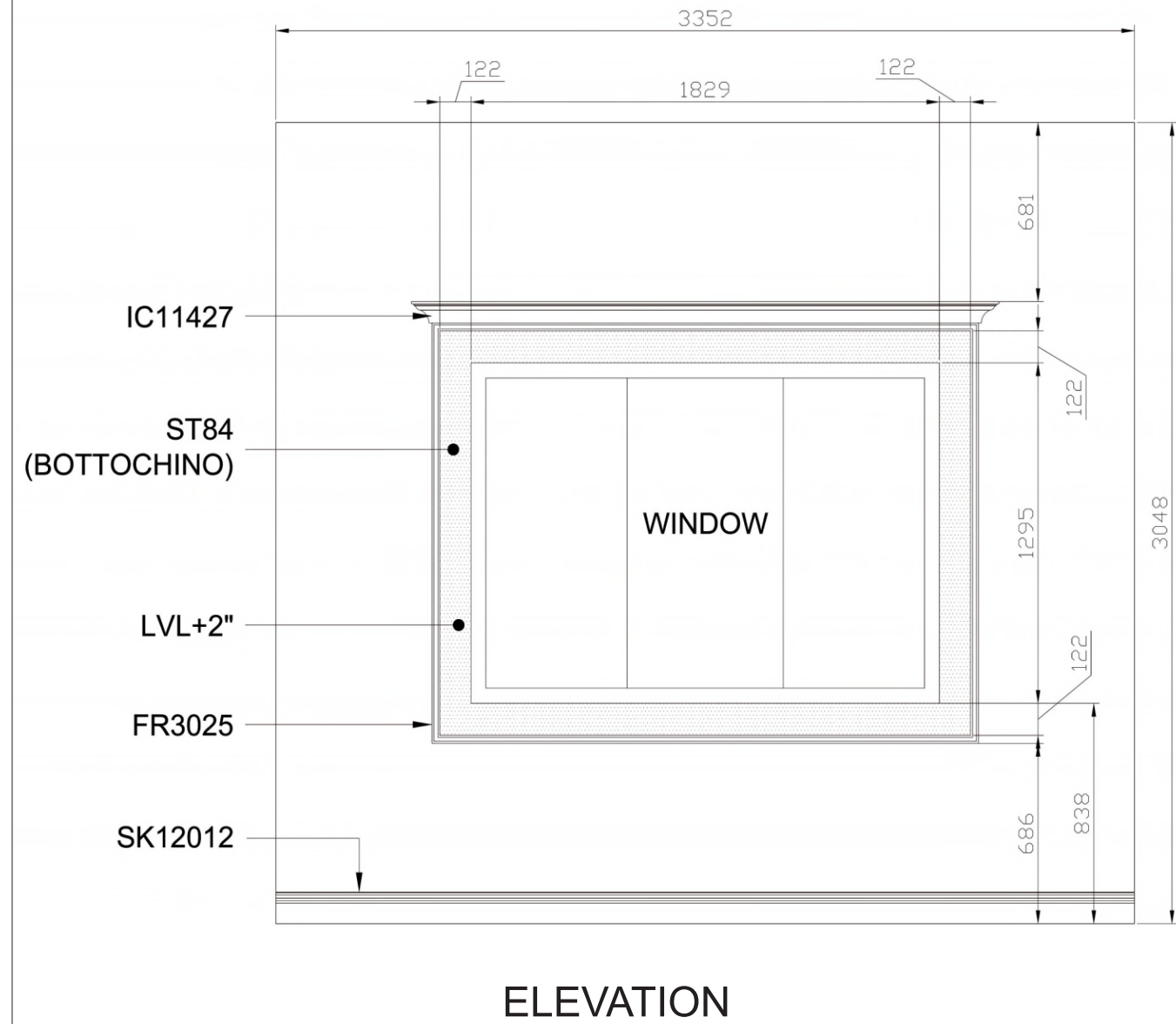

ALL DIMENSIONS IN 'mm'  
(1ft = 12 inch = 304.8mm)

**ESTIMATED BILL OF MATERIALS  
(WINDOW JAMB ONLY)**

PROFILE	COLOUR	QUANTITY
ST84	BOTTOCHINO	18 sq.ft.
IC11427	BLACK EMPRADOR	8'3\" r.ft.
FR3025	BLACK EMPRADOR	25'0\" r.ft.

**RECOMMENDED OTHER COLOUR COMBINATION**

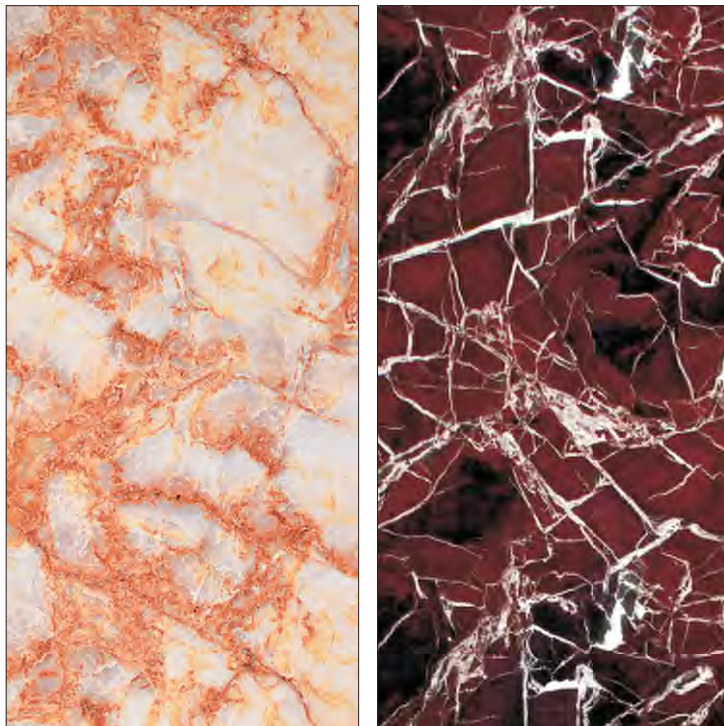

ONYX TROPICAL

LAVANTE





  
**D-STONA BED BACK WALL**

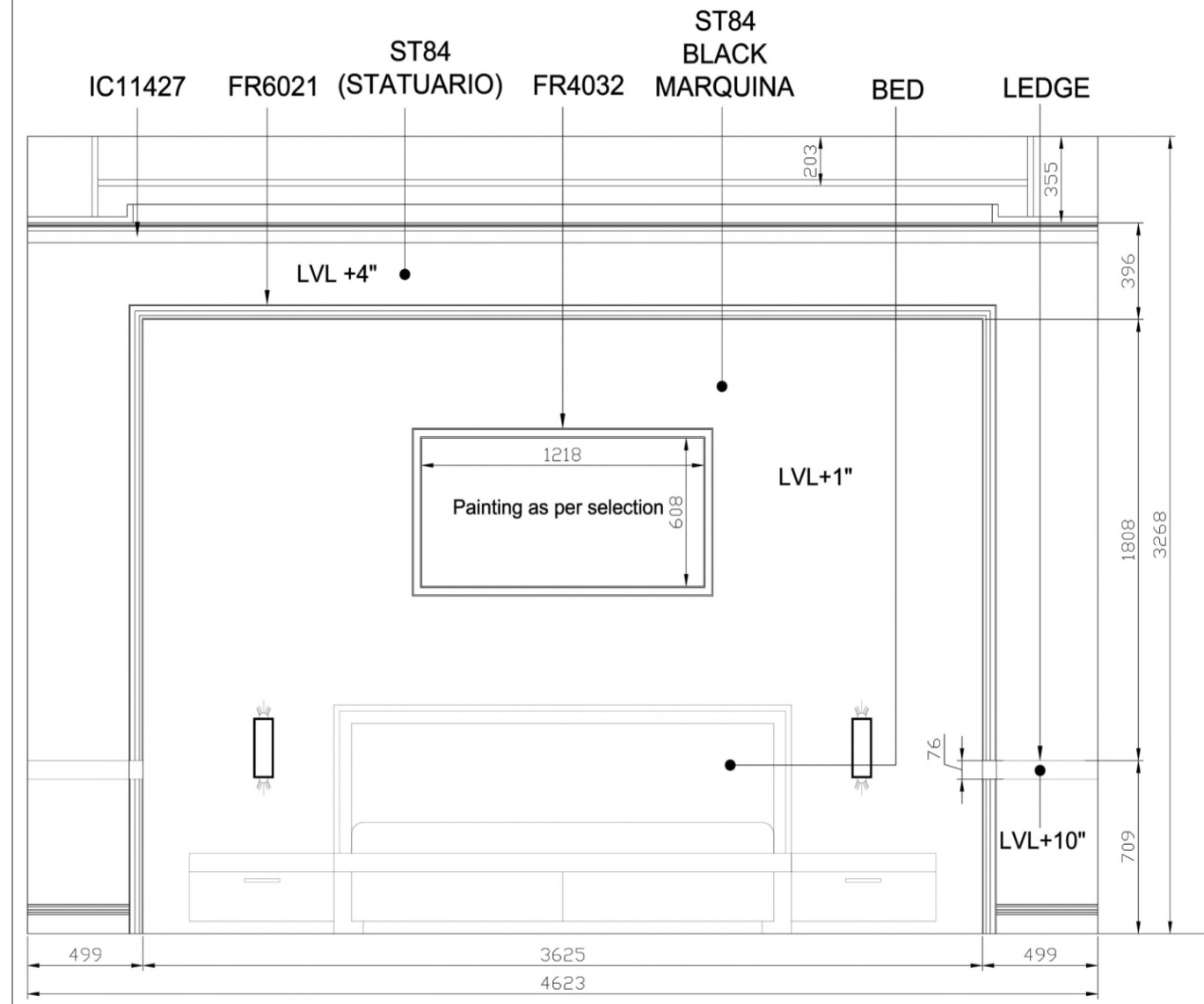

**ELEVATION**

ALL DIMENSIONS IN 'mm'  
(1ft = 12 inch = 304.8mm)

**ESTIMATED BILL OF MATERIALS  
(BACK WALL ONLY)**

PROFILE	COLOUR	QUANTITY
ST84	BLACK MARQUINA	116 sq.ft.
ST84	SATUARIO	43 sq.ft.
FR6021	BLACK MARQUINA	29'3" r.ft.
FR4032	SATUARIO	13'1" r.ft.
IC11427	BLACK MARQUINA	15'2" r.ft.
SK12012	BLACK MARQUINA	3'3" r.ft.

**RECOMMENDED OTHER COLOUR COMBINATION**

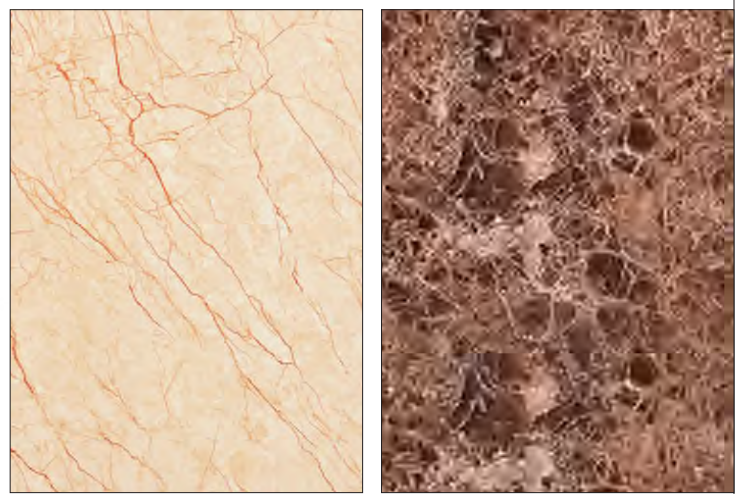

CREMA ZAFRA      BROWN EMPRADOR





  
**D-STONA BAR COUNTER**

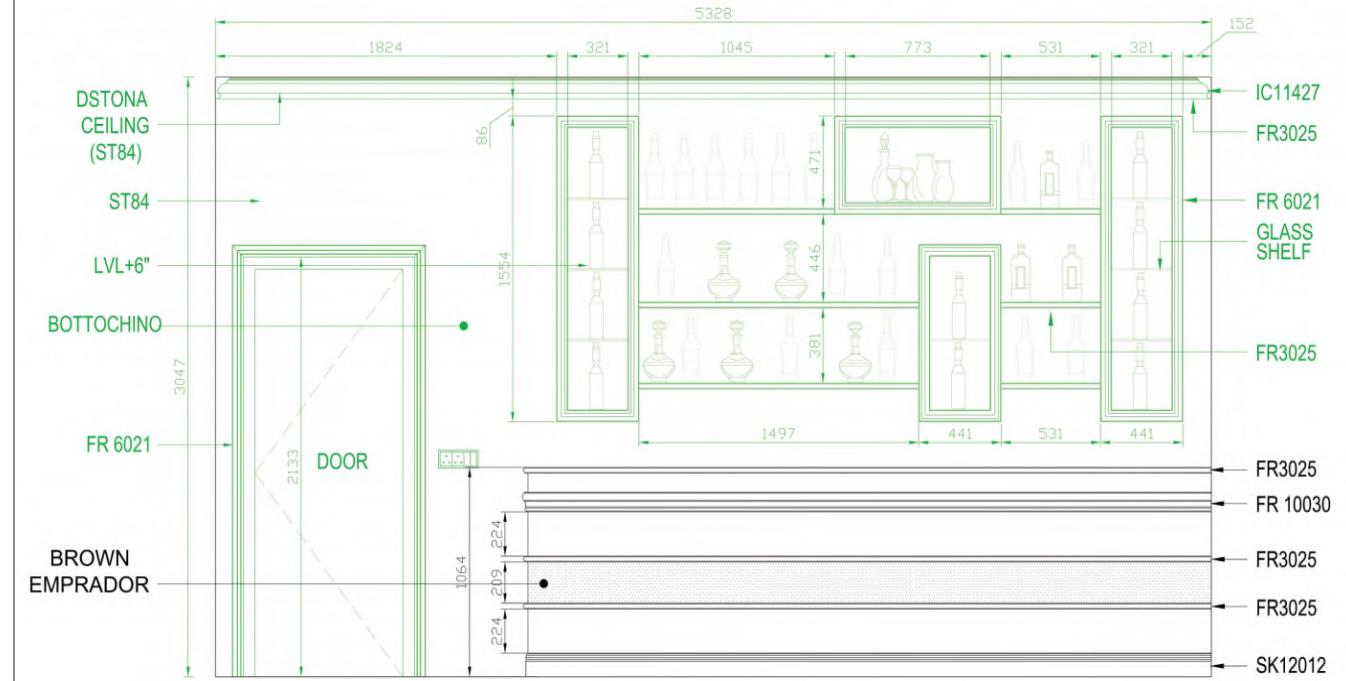

**ELEVATION**

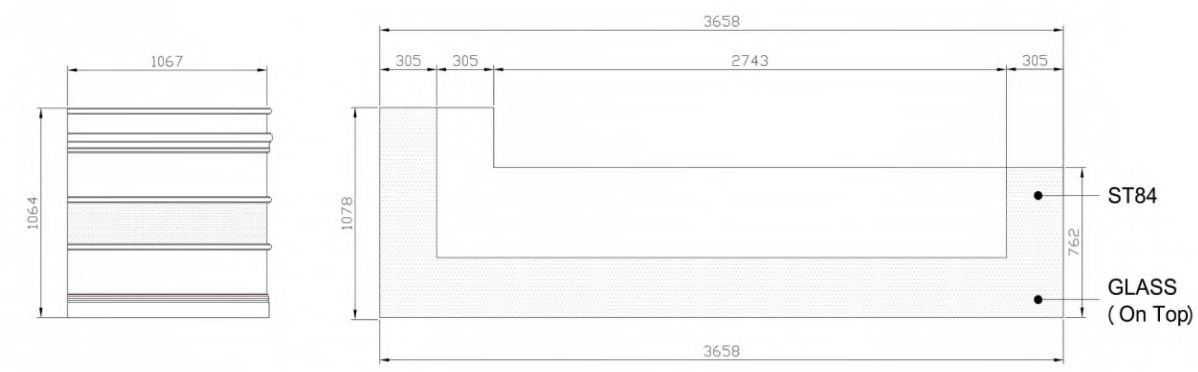

**SIDE ELEVATION**

**PLAN**

ALL DIMENSIONS IN 'mm'  
(1ft = 12 inch = 304.8mm)

**ESTIMATED BILL OF MATERIALS  
(BAR COUNTER ONLY)**

PROFILE	COLOUR	QUANTITY
ST84	BLACK EMPRADOR	27 sq.ft.
ST84	BOTTOCHINO	28 sq.ft.
FR3025	BLACK EMPRADOR	46'5\" r.ft.
FR10030	BLACK EMPRADOR	15'6\" r.ft.
SK12012	BLACK EMPRADOR	15'6\" r.ft.

**RECOMMENDED OTHER COLOUR COMBINATION**



BLACK MARQUINA

SILVER TRAVERTINE





  
**D-STONA LIFT WALL**

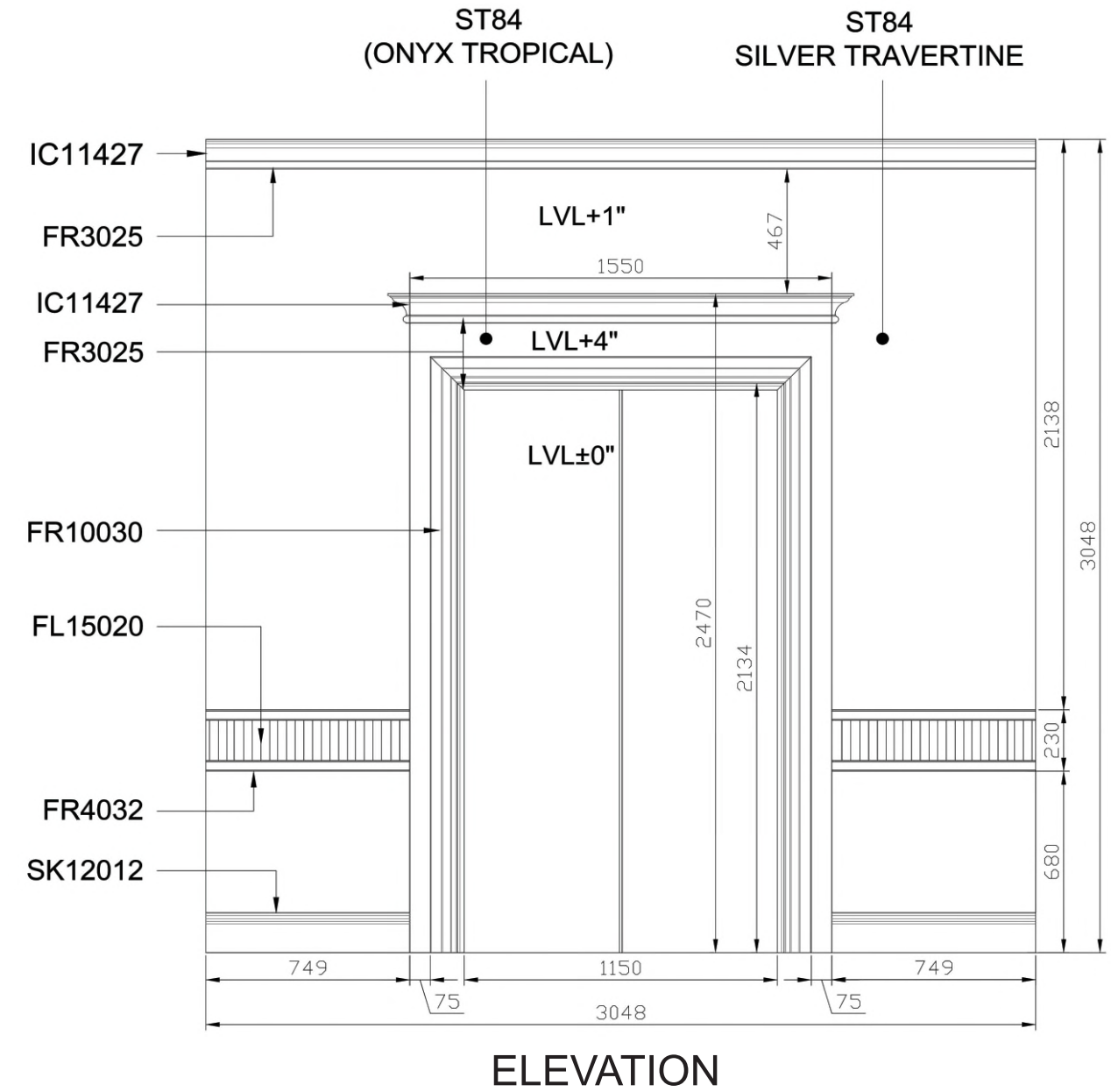

ALL DIMENSIONS IN 'mm'  
(1ft = 12 inch = 304.8mm)

**ESTIMATED BILL OF MATERIALS  
(WALL ONLY)**

PROFILE	COLOUR	QUANTITY
ST84	SILVER TRAVERTINE	51 sq.ft.
ST84	ONYX TROPICAL	20 sq.ft.
FL15020	ONYX TROPICAL	5'0" r.ft.
FR4032	ONYX TROPICAL	10' r.ft.
FR3025	ONYX TROPICAL	29' r.ft.
IC11427	ONYX TROPICAL	16'7" r.ft.
FR10030	ONYX TROPICAL	19'3" r.ft.
SK12012	ONYX TROPICAL	5'0" r.ft.
ECS	CHROME	15'6" r.ft.

**RECOMMENDED OTHER COLOUR COMBINATION**

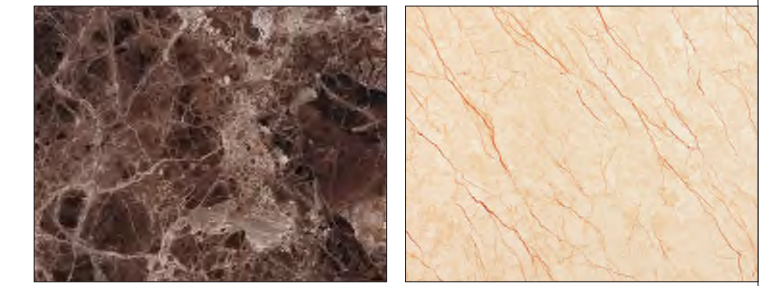

BLACK EMPRADOR
CREMA ZAFRA





  
**D-STONA RECEPTION COUNTER**

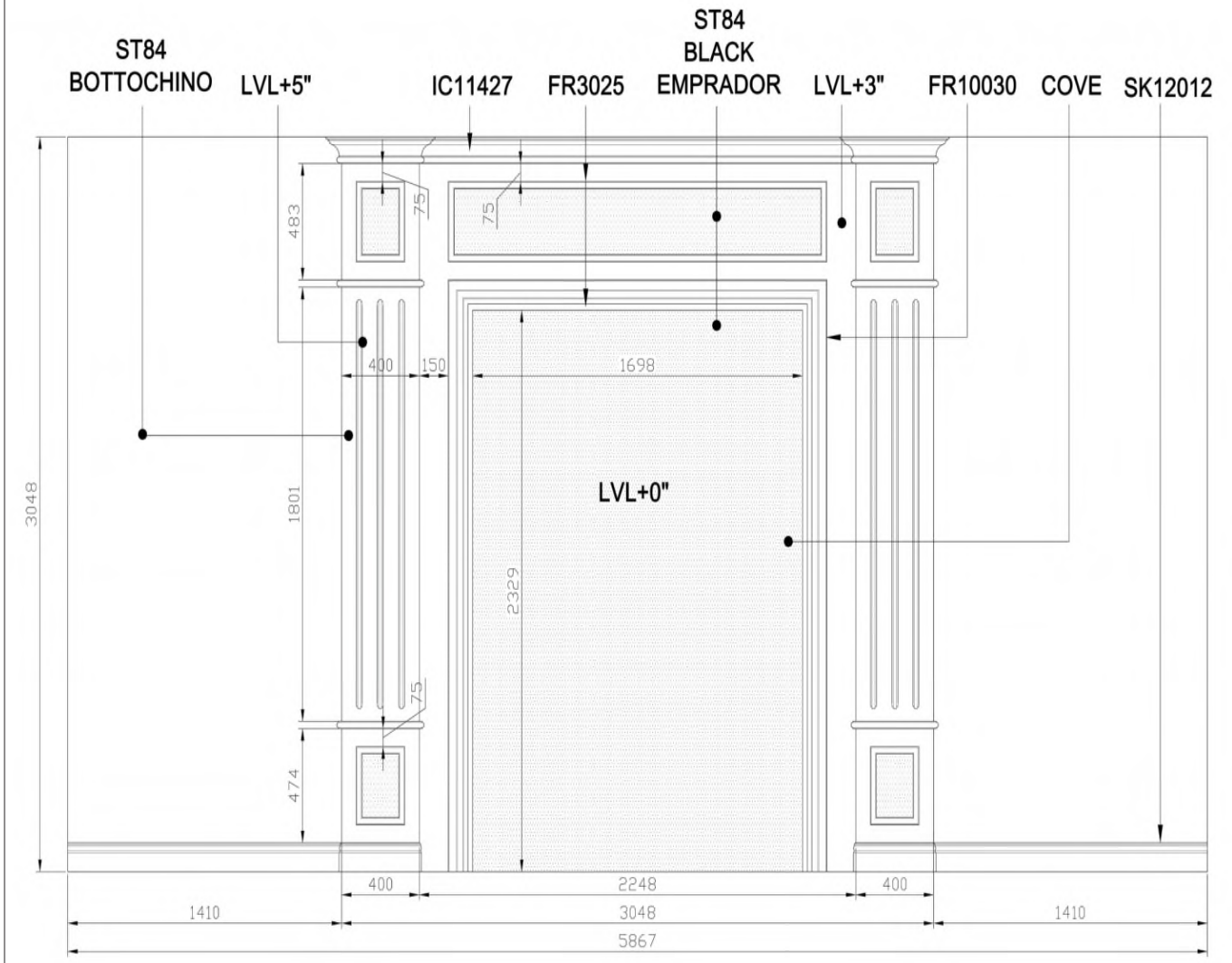

**ELEVATION**

ALL DIMENSIONS IN 'mm'  
(1ft = 12 inch = 304.8mm)

**ESTIMATED BILL OF MATERIALS  
(COUNTER ONLY)**

PROFILE	COLOUR	QUANTITY
ST84	BLACK EMPRADOR	60 sq.ft.
ST84	CREMA ZAFRA	141 sq.ft.
IC11427	CREMA ZAFRA	12'3" r.ft.
FR3025	CREMA ZAFRA	72'4" r.ft.
FR10030	CREMA ZAFRA	22'6" r.ft.
FR3025	BLACK EMPRADOR	33'6" r.ft.
SK12012	CREMA ZAFRA	13'6" r.ft.

**RECOMMENDED OTHER COLOUR COMBINATION**

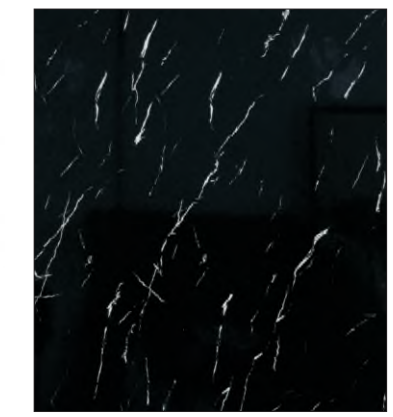

BLACK MARQUINA



STATUARIO





# D-STONA LIFT JAMB



**FR15039**  
APPLICATIONS:  
Frames, Jambs,  
Coves etc.



**ST84**  
APPLICATIONS:  
Wall claddings, False  
ceilings etc.



**SK12012**  
APPLICATIONS:  
Skirtings, Frames etc.

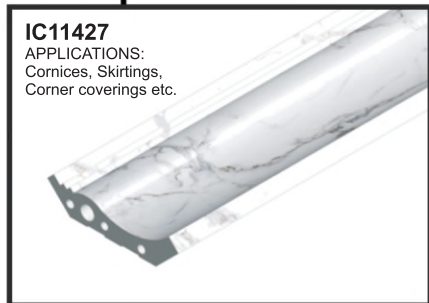

**IC11427**  
APPLICATIONS:  
Cornices, Skirtings,  
Corner coverings etc.



**FR5030**  
APPLICATIONS:  
Frames, Jambs,  
Covers etc.



**IC2323**  
APPLICATIONS:  
Corner coverings etc.



# D-STONA PILLAR

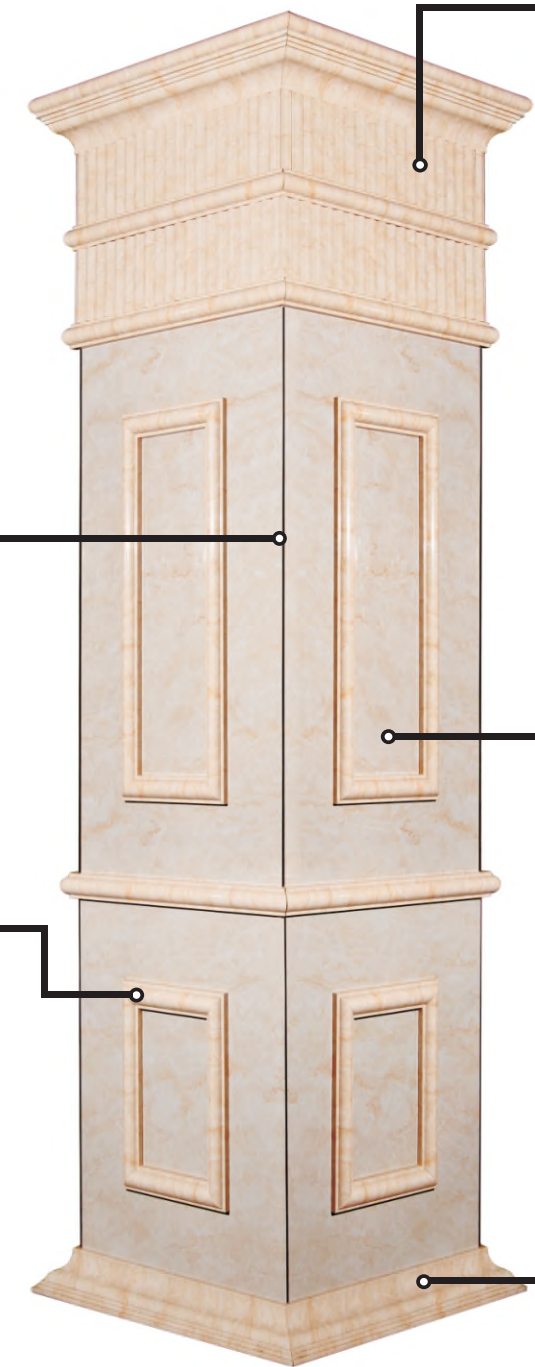

**ECS**  
APPLICATIONS:  
ST84 (Sheet) Fixing  
and covering external  
corners.

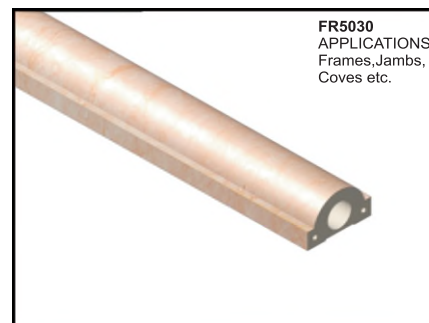

**FR5030**  
APPLICATIONS:  
Frames, Jambs,  
Coves etc.

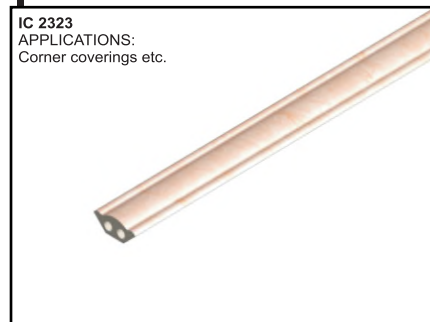

**IC 2323**  
APPLICATIONS:  
Corner coverings etc.

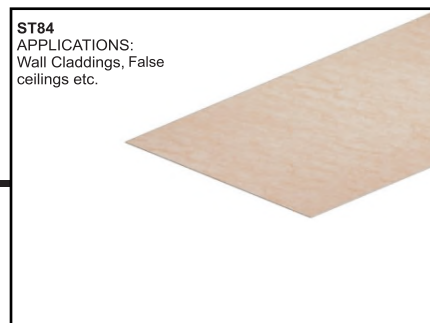

**ST84**  
APPLICATIONS:  
Wall Claddings, False  
ceilings etc.

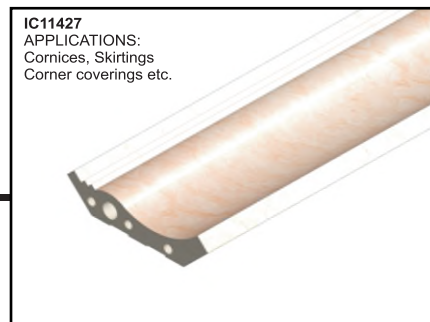

**IC11427**  
APPLICATIONS:  
Cornices, Skirtings  
Corner coverings etc.



**DESIGNIA THE INTERIOR LOUNGE**

No. 160 1st Main Road,  
Seshadripuram Bangalore - 560 020  
Karnataka, India

PH: +91 9620-966-660 / +91 9620-953-953

MAIL: [info@designia.in](mailto:info@designia.in)

WEB: [www.designia.in](http://www.designia.in)

