

SPECIAL OFFICES CO.
شركة المكاتب المميزة التجارية

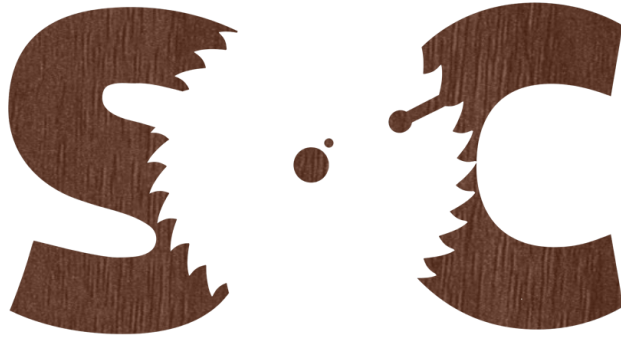



SPECIAL OFFICES CO.
شركة المكاتب المميزة التجارية



SPECIAL OFFICE CO
Saudi Arabia kingdom
CR :1010357006

+966 11 4764749
P.O. Box 1862 CODE 1141
info@special-offices.com

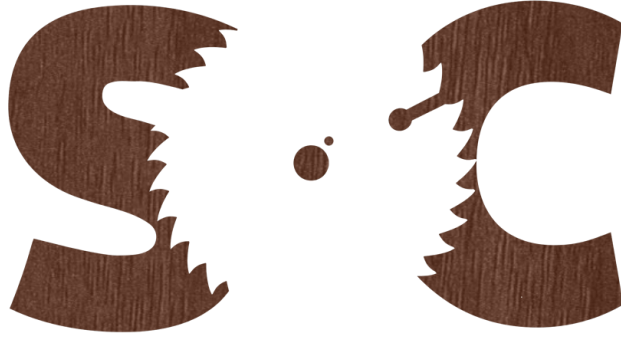

SPECIAL OFFICES CO.
شركة المكاتب المميزة التجارية



+966 11 4764749



info@special-offices.com



Kingdom of Saudi Arabia
Riyadh
P.O. Box 1862 CODE 1141

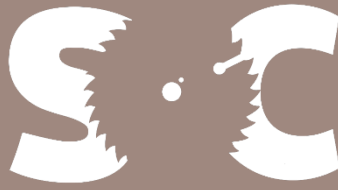

SPECIAL OFFICES CO.
شركة المكاتب المميزة التجارية

- 01 - About us
- 02 - Our Vision
- 03 - Our Mission
- 04 - Success Partners
- 07 - Business Partners
- 05 - Meet the Factory
- 06 - Factory Machines
- 08 - Our Products
- 09 - Our Projects

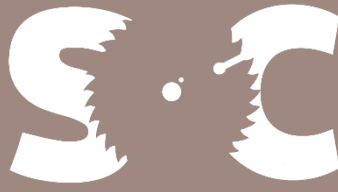

SPECIAL OFFICES CO.
شركة المكاتب المميزة التجارية

About Us

Special Offices CO is a Saudi company headquartered in Riyadh.

It specializes in manufacturing and supplying products that are characterized by adapting to changing work environments, residential and health spaces, allowing the creation of serious and comfortable spaces at the same time in smart and flexible ways.

Based on our conviction that the space surrounding individuals is an important asset that affects them psychologically and physically, and thus the way they interact, whether as a family or as employees, so we help them interact, learn, work and heal.

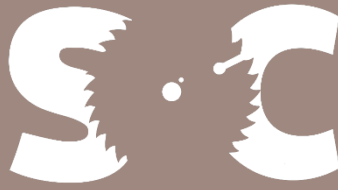

SPECIAL OFFICES CO.
شركة المكاتب المميزة التجارية

Our Vision

We look forward to real leadership in the field of manufacturing and supplying integrated products and solutions to create human spaces characterized by intelligence and comfort, which stimulates positive interaction between individuals.

Commitment to excellence, creativity and innovation, and adherence to values that are consistent with the objectives of the Kingdom's Vision 2030.

Seeking to build human environments based on main axes, which are **Cooperation**, **Focus**, and **Effective social communication** to create spaces that meet the needs of the educational and residential sectors, as well as governmental and private work environments

Achieving valuable success for our company by meeting the requirements of our customers and achieving their satisfaction with the products and solutions we offer

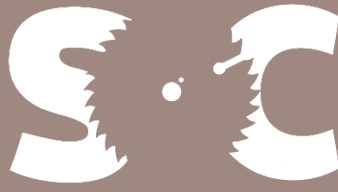

SPECIAL OFFICES CO.
شركة المكاتب المميزة التجارية

Our Mission

We seek to develop tools and solutions that support daily work practices for all interactive environments, whether office, educational or medical, and work to ensure that these products are of high quality and are flexible.

Meeting customer requirements with high quality and professional performance and exceeding their expectations.

Building close relationships with all sectors and government and private companies based on cooperation and participation to contribute to achieving the goals of the Kingdom's Vision 2030 and to be an effective element in its development and prosperity.

Access to all regions of the Kingdom in a manner that facilitates meeting the needs of all segments with unlimited possibilities.



SPECIAL OFFICES CO.
شركة المكاتب المميزة التجارية



Our National Commitment

The Unified Business Factory Company continues its commitment to enable Vision 2030 put forward by the wise leadership in the Kingdom of Saudi Arabia in all its administrative, marketing and production strategies to support the economic and social prosperity of the Kingdom in various ways, as one of its basic and firm commitments.

It also works to attract Saudi cadres and ensures the development of their capabilities and enrich their skills in all the company's related facilities with the support and guidance of the experienced people in the company.

It seeks to achieve the values called for by the vision, whether at the level of strengthening the national identity of our products or providing high quality products that do not harm the environment or individuals.

SPECIAL OFFICES COMPANY.

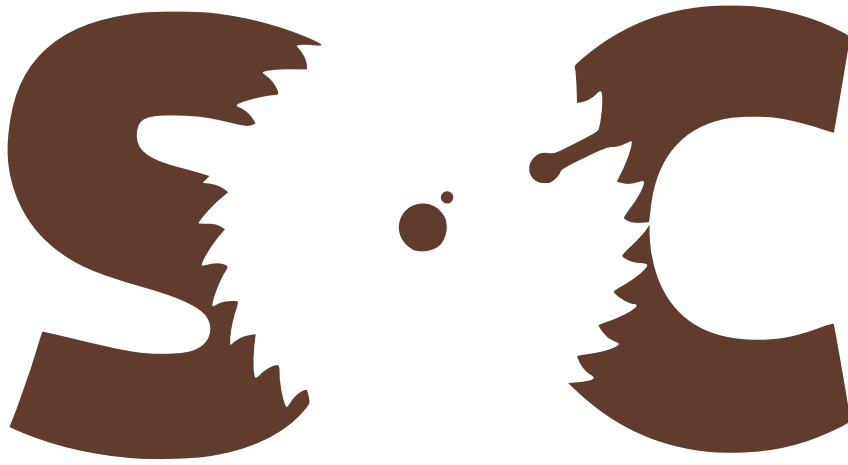

SPECIAL OFFICES CO.
شركة المكاتب المميزة التجارية

رقم العقد: 425741
رقم نسخة العقد: 1
تاريخ تقديم العقد: 17/ 02/ 1442
المركز الرئيسي: الرياض
رأس المال: 100000

عقد تأسيس شركة [شركة المكاتب المميزة التجارية (شركة شخص واحد)] ذات مسؤولية محدودة

تؤسس طبقاً لنظام الشركات الصادر بالمرسوم الملكي رقم (م/3) وتاريخ 28/ 1/ 1437 هـ شركة شركة المكاتب المميزة التجارية (شركة شخص واحد) (ذات مسؤولية محدودة) مملوكة لـ فهد بن سليمان بن عبدالله العيدي سعودي الجنسية بموجب السجل المدني رقم 1006239295 ومهنته متسبب وتاريخ الميلاد 07/ 10/ 1401 هـ ويقيم في مدينة الرياض

حيث أن السيد فهد بن سليمان بن عبدالله العيدي يمتلك مؤسسة مقيدة باسم مؤسسة عنوان الاعمال للمقاولات والمسجلة بالسجل التجاري رقم 1010299287 وتاريخ 15/ 01/ 1433 بمدينة الرياض ولها فروع الفرع الاول مقيد باسم مؤسسة المكاتب المميزة التجارية والمسجلة بالسجل التجاري رقم 1010357006 وتاريخ 21/ 01/ 1434 بمدينة الرياض

الفرع الثاني مقيد باسم مؤسسة شبكة شمول لتقنية المعلومات والمسجلة بالسجل التجاري رقم 1010470901 وتاريخ 09/ 08/ 1437 بمدينة الرياض

الفرع الثالث مقيد باسم مؤسسة التاج المميزة التجارية والمسجلة بالسجل التجاري رقم 1010478584 وتاريخ 13/ 03/ 1440 بمدينة الرياض

الفرع الرابع مقيد باسم ورشة الاعمال الموحدة للحدادة والالمنيوم والمسجلة بالسجل التجاري رقم 1010944751 وتاريخ 20/ 06/ 1439 بمدينة الرياض

يرغب في تحويل المؤسسة وفروعها المذكورة بما لها من حقوق وما عليها من التزامات وعماله وتصنيف وتراخيص وجميع عناصرها المانية والفنية والادارية الى شركة ذات مسؤولية محدودة بمشاركة الاطراف المذكورين اعلاه مع الاحتفاظ باسم ورقم وتاريخ السجل التجاري للمؤسسة مع الاحتفاظ باسم ورقم وتاريخ السجل التجاري للفرع الاول كمرکز رئيسي مع الاحتفاظ باسم ورقم وتاريخ السجل التجاري للفرع الثاني مع الاحتفاظ باسم ورقم وتاريخ السجل التجاري للفرع الثالث مع الاحتفاظ باسم ورقم وتاريخ السجل التجاري للفرع الرابع وقد تم تقييم اصول المؤسسة وفروعها بمبلغ (100000) ر.س وقد استوفى الاطراف حقوقهم من بعضهم البعض ويعتبر توقيعهم على هذا العقد بمثابة مخالصة نهائية فيما بينهم

وتم تأسيس الشركة وفقاً للشروط والأحكام التالية:

"المادة الأولى: اسم الشركة"

اسم الشركة هو: [شركة المكاتب المميزة التجارية (شركة شخص واحد)] [ذات مسؤولية محدودة]

"المادة الثانية: أغراض الشركة"

تحدد اغراض الشركة بالتالي:

الباب	الفئة
الأنشطة العقارية	الأنشطة العقارية في الممتلكات المملوكة أو المؤجرة
التشييد	الأنشطة العقارية على أساس رسوم أو عقود تشبيهُ المياني اكمال المياني وتشطيبها إنشاء الطرق وخطوط السكك الحديدية تشبيد المشاريع الخاصة بالمنافع أعمال التشبيد المتعلقة بمشاريع الهندسة المدنية الأخرى
	الهدم
	تحضير الموقع
	التركيبات الكهربائية
	أعمال السباكة والتدفئة وتكييف الهواء
	تركيبات إنشائية أخرى
	أنشطة التشبيد المتخصصة الأخرى
الخدمات الإدارية وخدمات الدعم	تأجير المركبات ذات المحركات أنشطة وكالات التشغيل أنشطة خدمات نظم الأمن



شهادة اشتراك
Membership Certificate

جوفة الرياض
Riyadh Chamber

Membership No. :	9374	9374	رقم العضوية الموحد :
Date of Issue:	26/01/2013	2013/01/26	تاريخ الاصدار:
Membership Class :	Second	الثانية	درجة العضوية :
Riyadh Chamber Certifies			تشهد الغرفة التجارية الصناعية بالرياض بأن شركة المكاتب المميزة التجارية (شركة شخص واحد)
Commercial Registration No.	1010357006	1010357006	مقيدة بالسجل التجاري / الترخيص رقم :
Certificate Expires on	27/05/2025	2025/05/27	يتهي سريان هذه الشهادة في



الخدمات الإلكترونية لغرفة الرياض - بوابة أعمال | E-Services Riyadh Chamber ©

920004565

- يلزم التحقق من الوثيقة عبر الرابط <https://mybusiness.chamber.sa> ، أو تطبيق (سند) للأجهزة المحمولة أو الرقم الموحد دون ادنى مسؤولية على الغرفة عن محتوى الوثيقة.
- تعد هذه الورقة من الوثائق الإلكترونية لغرفة الرياض، ويمنع تعديلها اول محاولة العبث بها وتصبح لاغية حال محاولة تعديلها وتعرض صاحبها للملاحقة القانونية.





رقم الشهادة : ١٠٢٠٢٤٩٣٩٧
التاريخ : ١٤٤٣/١١/٢٠ هـ
الرقم المميز : ٣١٠٨٩٦٦٧١٢



الهيئة العامة للزكاة والدخل
General Authority of Zakat & Tax

المملكة العربية السعودية
الهيئة العامة للزكاة والدخل
General Authority of Zakat & Tax

شهادة CERTIFICATE

تشهد الهيئة العامة للزكاة والدخل بأن المكلف / شركة المكاتب المميزة التجارية شركة شخص
واحد

شركة رقم ٧٠٠٣١٣٨٩١٩ وسجل تجاري رقم ١٠١٣٥٧٠٠٦
قدم إقراره عن الفترة المنتهية في ٢٠٢١/١٢/٣١

وقد منح هذه الشهادة لتمكينه من إنهاء جميع معاملاته بما في ذلك صرف مستحقاته
النهائية عن العقود.

يسري مفعول هذه الشهادة حتى تاريخ ١٤٤٤/١٠/١٠ هـ الموافق ٢٠٢٣/٠٤/٣٠ م.
(العاشر من شوال ألف و أربعمئة و أربعة و أربعون هجري)

الفروع (٤) في النموذج المرفق



الختم الرسمي

هذه الوثيقة مستخرجة من النظام الآلي ولا تحتاج إلى توقيع
لا يعتد بهذه الشهادة إلا بعد التحقق من موقع الهيئة www.gazt.gov.sa

تاريخ الإصدار: 2021/03/28
الرقم المميز: 3108966712الهيئة العامة للزكاة والدخل
General Authority of Zakat & Taxشهادة تسجيل في ضريبة القيمة المضافة
VAT Registration Certificateتشهد الهيئة العامة للزكاة والدخل بأن المكلف أدناه مسجل في ضريبة القيمة المضافة
بتاريخ 2021/03/28Hereby, The General Authority of Zakat & Tax (GAZT) certifies that the taxpayer below is
VAT registered on 28/03/2021

اسم المكلف:	شركة المكاتب المميزة التجارية شركة شخص واحد
رقم التسجيل الضريبي:	310896671200003
تاريخ نفاذ التسجيل:	2021/04/01
عنوان المكلف:	الرياض، حي الملق، الهواري، 12831

كمكلف مسجل في ضريبة القيمة المضافة، لا يجوز لك تحصيل ضريبة القيمة المضافة من عملائك قبل تاريخ
نفاذ التسجيل بالضريبة، في حال تبين غير ذلك، ستقوم الهيئة العامة للزكاة والدخل بتنفيذ الغرامات المستحقةهذه الوثيقة مرسلة من النظام الآلي ولا تحتاج إلى توقيع
- الهيئة العامة للزكاة والدخل -



شهادة التزام بنظام حماية الأجور

رقم الشهادة : ٢٠١٢٢١١.١٩١٣
تاريخ الإصدار ١٤٤٤/ ٤/١٩ هـ الموافق ٢٠٢٢/١١/١٣ م

اسم المنشأة شركة المكاتب المميزة التجارية شركة شخص واحد

رقم المنشأة: ١-١٠.٢٢٢١

الرقم الموحد ١-١٠.٢٢٢١

تشهد وزارة الموارد البشرية والتنمية الاجتماعية بأن المنشأة ملتزمة بضوابط برنامج حماية الأجور وقد تم منح هذه الشهادة للمنشأة بعد تحقيق نسبة الالتزام المحددة نظاماً للحصول على هذه الشهادة

ولكم تحياتنا...

إدارة حماية الأجور

تنبيهات:

- * صلاحية الشهادة 60 يوماً من تاريخ صدورها.
- * أي تعديل أو كسب بالشهادة تعتبر ملغية.
- * هذه الشهادة معتمدة من صاحب الصلاحية ولا تحتاج الى ختم أو توقيع.
- * يمكن التحقق من صحة وصلاحية الشهادة عبر الرمز المعرف



Proof Number	1019782400	رقم الإثبات
Original Date	29/6/2022	تاريخ الإصدار
Expiration Date	12/26/2022	تاريخ الانتهاء



إثبات عنوان Address Proof

Address Holder Details

بيانات صاحب العنوان

Name	شركة المكاتب المميزة التجارية شركة شخص واحد	الاسم
Customer Acc.	6 6 3 3 3 5 5 0 6	رقم الحساب
Reg. Date	26/2/2014	تاريخ التسجيل

Address Details

تفاصيل العنوان

Short Address	R E M A 2 1 6 3	العنوان المختصر
Building No.	2 1 6 3	رقم المبنى
Street	Prince Mansour Bin Abdulaziz	الشارع
Secondary No.	7 5 4 5	الرقم الفرعي
District	Al Malaz Dist.	حي الملز
Postal Code	1 2 8 3 1	الرمز البريدي
City	RIYADH	المدينة
Kingdom of Saudi Arabia		المملكة العربية السعودية



للتحقق To Verify

<https://proof.address.gov.sa/VerifyProofNA.aspx>



COMPANY OUTLETS

Company Outlets & Fairs Get More

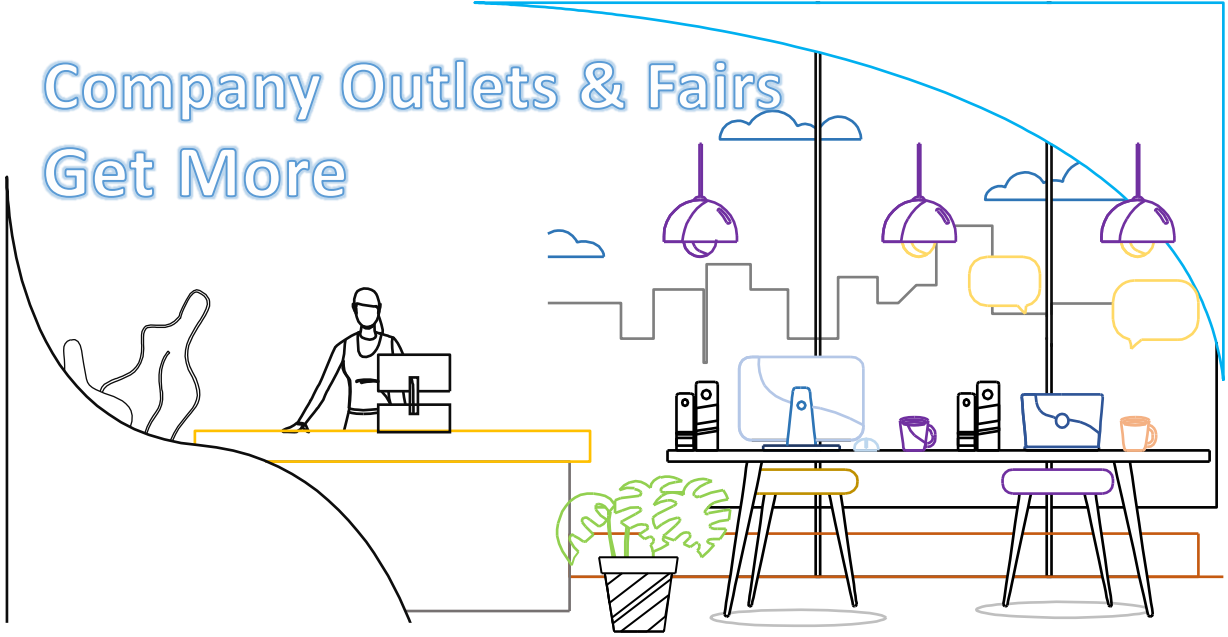

Special offices Company Sales Department.

Address: Salahuddin Al-Ayyubi Road,
Al-Malaz, Riyadh 12831



SPECIAL OFFICES CO.
شركة المكاتب المميزة التجارية

Product fairs 1500 Sqr m:

Address: Olaya Street, Al Murooj, Riyadh 12283

Address: Al Khobar

Address: ALDammam



SPECIAL OFFICES CO.
شركة المكاتب المميزة التجارية

Company Outlets & Fairs Get More

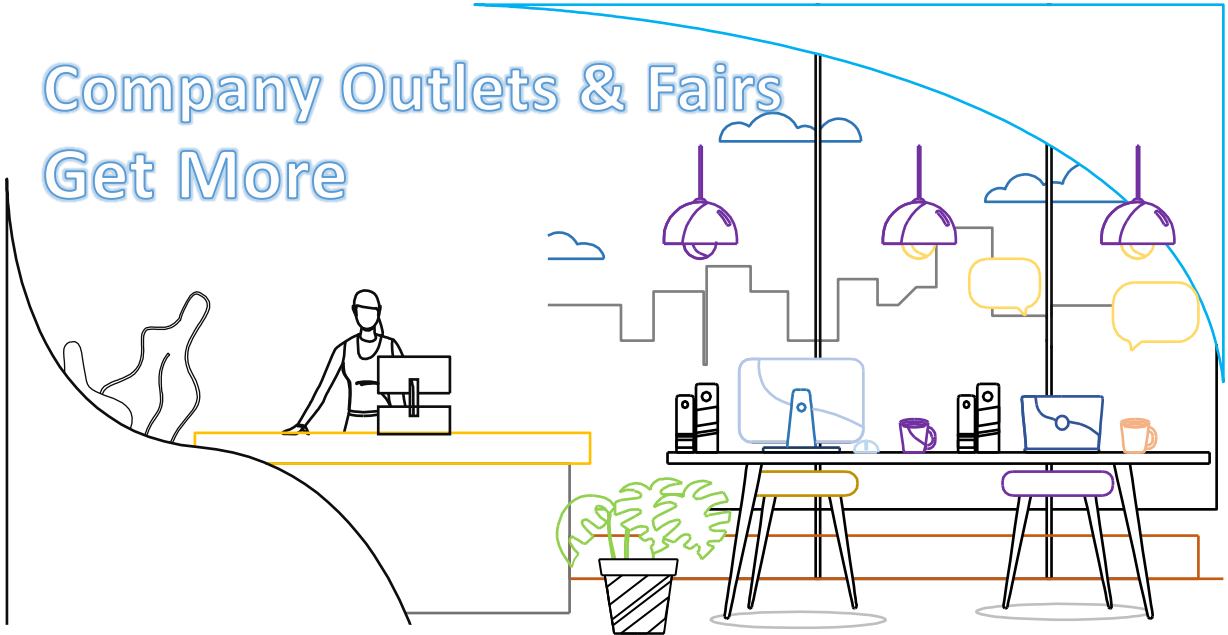

ALRIYADH SHOW ROOM

Address: Olaya Street, Al Murooj, Riyadh 12283

BUSINESS PARTNERS



Business Address Co.



Al Taj Company



Unified Business Factory

Unified Business Factory is proud that it cooperates with a group of companies working side by side as one group, where each company meets the needs of other companies, allowing quick solutions to the challenges they face and obtaining adequate support to overcome all obstacles

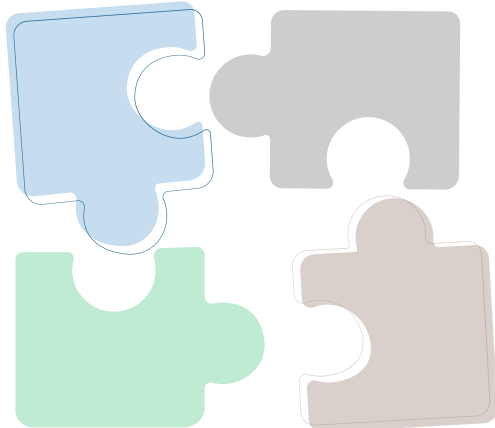

MACHINES

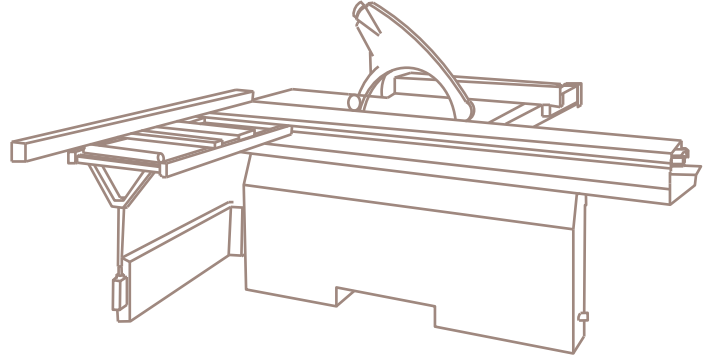
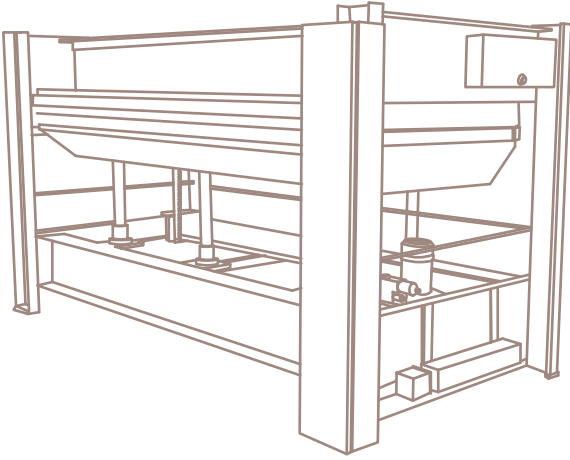

MACHINES

MACHINE	Manufacturing	Quantity	Description
Beam saw machine	Italy	1	The capacity is 700 panels per day
PVC Straight Edge Bander machine	China	2	The capacity is 3000 meters per day
PVC Not straight Edge Bander machine	China	1	The capacity is 1000 meters per day
CNC machine	China	1	
PVC Curved Edge Bander machine	China	2	The capacity is 800 meters per day
Heat press machine	Russia	1	Wood panels pressing
Boring machine	Italy	1	For wide holes
Boring machine	Italy	1	For narrow holes
Plasma Sheet Metal Cutting machine	Russia	1	Sheet Metal Cutting
Metal welding machine	Italy	3	Metal welding
Leather & fabric cutting machine	China	1	Cutting leather and fabric
Leather & fabric Sewing Machines	China	3	Sewing fabrics and leather
Caterpillar forklift	USA	1	3ton capacity
Traditional Machine	Italy		Treating natural wood



FACTORY MACHINES



FACTORY MACHINES



FACTORY MACHINES



FACTORY MACHINES

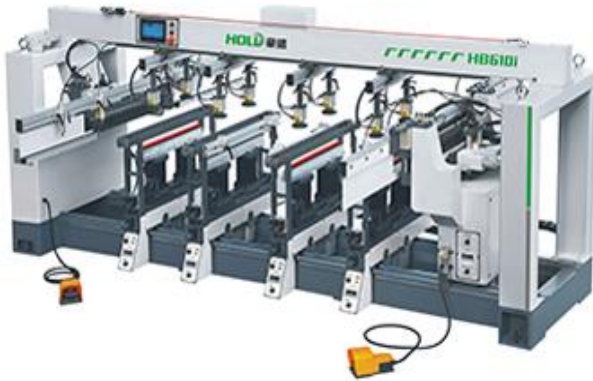

FACTORY MACHINES



FACTORY MACHINES





SUBMITTALS



VISION رؤية 2030 المملكة العربية السعودية KINGDOM OF SAUDI ARABIA		وزارة الشؤون الوطنية 2020		STC الاتصالات السعودية		stc											
اسم المشروع: عملية تأثيث فرع الشركة العربية لخدمات الانترنت والاتصالات- STC بجده رقم 11/2023																	
طلب اعتماد مواد Materials Submittal																	
طلب جديد <input type="checkbox"/>		رقم طلب الاعتماد: 71845 07/04/1444		رقم الطلب السابق:		طلب معاد تقديمه <input type="checkbox"/>											
سبب تقدم طلب الاعتماد		من أجل مغموات <input type="checkbox"/>		من أجل الملاحظات والتعليقات <input type="checkbox"/>		من أجل الاعتماد <input checked="" type="checkbox"/>											
الفرع: <input type="checkbox"/> مدني <input type="checkbox"/> معماري <input type="checkbox"/> إنشائي <input type="checkbox"/> تكييف HVAC <input type="checkbox"/> سباكة <input type="checkbox"/> كهرباء <input type="checkbox"/> أثاث <input checked="" type="checkbox"/>																	
المعرفات: <input type="checkbox"/> كتدرجات <input type="checkbox"/> مخططات <input type="checkbox"/> شهادات <input type="checkbox"/> عينات <input checked="" type="checkbox"/> مغموات تقنية <input type="checkbox"/> حسابات <input type="checkbox"/>																	
جدول المواد / المعدات: ملاحظة: يرجى إضافة مرفقات في حلة وجود بنود أكثر من الفراغ المتاح.																	
مستلس	الاسم / الرقم / الوصف	المصدر	المصنع / المورد	مرجع المواصفات	المراجع القياسية	حالة الاعتماد											
1	البنء رقم (1) : وحدة عمل مقاس 120*60*120سم ارتفاع مع كنبئة ورف علوى مع وحدة ادراج ثلاثية متحركة	وطني	شركة المكاتب المميءزة التجارية														
																	
ملاحظات المقاول: نشء ان طلب الاعتماد المقءم اءلاء مطبق تمامأ لمخططات ومواصفات العقد، ما لم يتم نءر خلاف ذلك، كما هو موضء اءناه.																	
استثناء: مدير المشروع (المقاول) شركة المكاتب المميءزة التجارية الاسم / مهندس / وائل سالم التوقيع: التاريخ:																	
توصيات الاستشاري: الموافقة على اعءاء المواد المقءمة اءلاء لا يعنى المقاول من مسؤولياته حسب العقد.																	
<table border="1"> <tr> <td>ممثل الاستشاري:</td> <td>ممثل المالك:</td> </tr> <tr> <td>الاسم:</td> <td>الاسم:</td> </tr> <tr> <td>الوظيفة:</td> <td>الوظيفة:</td> </tr> <tr> <td>التوقيع:</td> <td>التوقيع:</td> </tr> <tr> <td>التاريخ:</td> <td>التاريخ:</td> </tr> </table>								ممثل الاستشاري:	ممثل المالك:	الاسم:	الاسم:	الوظيفة:	الوظيفة:	التوقيع:	التوقيع:	التاريخ:	التاريخ:
ممثل الاستشاري:	ممثل المالك:																
الاسم:	الاسم:																
الوظيفة:	الوظيفة:																
التوقيع:	التوقيع:																
التاريخ:	التاريخ:																
نتيجة الطلب: <input type="checkbox"/> معتمد <input type="checkbox"/> معتمد مع ملاحظات <input type="checkbox"/> معتمد مع ملاحظات وإعادة التقديم غير ضرورية <input type="checkbox"/> غير معتمد (مرفوض) <input type="checkbox"/>																	
استلام الاستشاري للطلب: التوقيع: التاريخ:																	
استلام المقاول بالنتيجة: التوقيع: التاريخ:																	



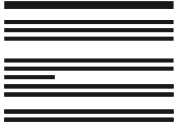

SUBMITTALS



2030		2020		مؤسسة خالد رشيد للتجارة KHALID RASHID AL SUWAIGH TRAD. EST. للأثاث المكتبي : Office Furniture		
اسم المشروع: عملية تأثيث فرع شركة ارمكو رقم 01/2023						
طلب اعتماد مواد Materials Submittal						
رقم طلب الاعتماد: 71845 2/06/1444		رقم الطلب السابق:		<input type="checkbox"/> طلب جديد		
تاريخ الطلب السابق:		تاريخ الطلب:		<input type="checkbox"/> طلب معاد تقديمه		
من أجل الاعتماد <input checked="" type="checkbox"/>		من أجل الملاحظات والتعليقات <input type="checkbox"/>		من أجل معلومات <input type="checkbox"/>		
سبب تقدم طلب الاعتماد						
الفرع:						
<input type="checkbox"/> مدني		<input type="checkbox"/> معماري		<input type="checkbox"/> إنشائي		
<input type="checkbox"/> مكيفات		<input type="checkbox"/> HVAC		<input type="checkbox"/> سباكة		
<input type="checkbox"/> كهرباء		<input type="checkbox"/> أثاث		<input type="checkbox"/> مرافق:		
<input type="checkbox"/> مخططات		<input type="checkbox"/> شهادات		<input checked="" type="checkbox"/> عينات		
<input type="checkbox"/> معلومات تقنية		<input type="checkbox"/> حسابات		<input type="checkbox"/>		
جدول المواد / المعدات: ملاحظة: يرجى إضافة مرفقات في حالة وجود بنود أكثر من الفراغ المتاح.						
مسلسل	الاسم / الرقم / الوصف	المصدر	المصنع / المورد	مرجع المواصفات	المراجع القياسية	حالة الاعتماد
1	البنود رقم (1): وحدة عمل مقاس 160*160*170سم ارتفاع مع كنبية ورف و وحدة ادراج ثلاثية متحركة	وطني	شركة المكاتب المميزه التجارية			
ملاحظات المقاول: نشهد ان طلب الاعتماد المقدم أعلاه مطابق تماماً لمخططات ومواصفات العقد، ما لم يتم ذكر خلاف ذلك، كما هو موضح أدناه.						
استثناء: مدير المشروع (المقاول) شركة المكاتب المميزه التجارية						
اسم: مهندس / وائل سالم						
التوقيع: التوقيع:						
توصيات الاستشاري: الموافقة على اعتماد المواد المقدمة أعلاه لا يعني المقاول من مسؤولياته حسب العقد.						
ممثل الاستشاري: الاسم: التوقيع: الوظيفة: التاريخ:						
ممثل المالك: الاسم: التوقيع: الوظيفة: التاريخ:						
نتيجة الطلب: <input type="checkbox"/> معتمد <input type="checkbox"/> معتمد مع ملاحظات <input type="checkbox"/> معتمد مع ملاحظات وإعادة التقديم غير ضروري <input type="checkbox"/> غير معتمد (مرفوض) <input type="checkbox"/> معتمد مع ملاحظات وإعادة التقديم <input type="checkbox"/> وبدء إجراء E						
استلام الاستشاري للطلب: التوقيع: التاريخ:						

مؤسسة خالد رشيد للتجارة
KHALID RASHID AL SUWAIGH TRAD. EST.
س.ت: ٢٠٥٠٠٢٩١٨٠ ٢٠٥٥٠٣٦١٨٠ C.R.:

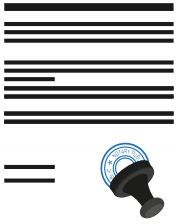

SUBMITTALS



Transmittal of Documents

Date: 19.06.2022

Transmittal no: S19091-COR-BAWI-PRQ-A-0028-00

Project no. & Title: S19091 - COR

Client:  وزارة الدفاع MINISTRY OF DEFENSE	Construction Supervision Consultant : 	Contractor:  شركة البعير AL BAWANI LTD. & SHIH AL JAZIRA JV
--	---	---

1. Document type

Material samples
 Manufacturer certificates
 Catalogues
 Schedules
 Tests
 Other
 Technical sheets

2. Submittal details

Item no	Description	Contract doc. Ref.
	PreQualification - Special Offices Company For Furniture.	

These are transmitted for:

Your information
 Approval
 Review & comment
 Other

Prepared by : DC Department
 Signature: 

Review by QA / QC Engr. Noel Deja Pena
 Signature:  6/19/2022

Submitted by : Engr. Talal Sultan
 Signature: 

3. Construction Supervisor's representative comments:

Approved
 Approved as noted
 Revise & resubmit
 Rejected
 Others

1- The submitted Pro-Qualification is limited to Transportation platoon and Documentation center buildings
 2- The contractor has to abide by the client's selections

Name: _____
 Signature:  Date: 26-06-22

4. Employer's representative comments:

Approved
 Approved as noted
 Revise & resubmit
 Rejected
 Others

Name: _____
 Signature: _____ Date: _____



Approval shall not relieve Contractor of his liabilities under the Contract or constitute authorization of any change to Contract Documents





SUBMITTALS



		مشروع : ديار الحسا المالك: وزارة الإسكان		Contractor: DREAM المقاول : حلم الأرياء	
From The Contractor:		رقم الأرياء:		نموذج رقم: 47A التاريخ: 25/02/2021 التوقيع:	
Material Approval Request طلب اعتماد مواد					
New submittal: طلب جديد		Re-submittal: إعادة تقديم			
MATERIAL DESCRIPTION (One item only this form) وصف العينة / المواد (هذا الطلب محصن لبد واحد فقط)		AS SPECIFICATION ALTERNATIVE مطابق للمواصفات [] بند بديل []			
Drawing ref. رقم لوحة العنق: Specification Ref. رقم مواصفة العنق: (attach all relevant technical literature marked to identify relevant descriptions, current test cert, sample etc)		BOQ Ref. No. رقم البند بالمقاييس: standards. BS, DIN أكواد / مواصفات:			
MANUFACTURER / SUPPLIER Name: اسم الشركة: Address: العنوان: Local Agent: الوكيل المحلي:		Company المورد / المصنع / الشركة: اسم الشركة: السعودية (الرياض)		FOR CONSULTANT USE ONLY استخدام الاستشاري فقط APPROVED <input type="checkbox"/> معتمدة	
DELIVERY Country of Origin: متى عوود Availability متى عوود		Locally Manufacture red [] منتج محلي Internationally Manufacture red [] منتج مستورد Production Period مدة التصنيع Delivery Ex- Works مدة الشحن Total delivery time المدة الكلية للتسليم Transport نقل		APPROVED AS NOTED <input checked="" type="checkbox"/> معتمدة ملاحظات ADDITIONAL INFORMATION REQUIRED <input checked="" type="checkbox"/> معلومات إضافية مطلوبة SAMPLE REQUIRED <input checked="" type="checkbox"/> عينة مطلوبة TEST REQUIRED <input type="checkbox"/> اختبار مطلوب إجراء	
PROGRAMME البرنامج Date material required on site التاريخ احتياج المواد Estimated date of arrival on site التاريخ المتوقع للتوريد بالموقع		TEST REQUIRED <input type="checkbox"/> اختبار مطلوب إجراء MANUFACTURERES GUARANTEE REQUIRED <input checked="" type="checkbox"/> مطلوب ضمان المصنع REVISE AND RESUBMIT <input type="checkbox"/> تراجع وإعادة تقديمها NOT APPROVED <input type="checkbox"/> مرفوضة			
EHAf COMMENTS: تعليقات إيهاف: لد مانع من اعتماد المصنع على أن تم تنفيذ عينات لياح كامل على الطبيعة طبقاً للمطامح الفرقين بالصور مع تعديهم مخطط تنفيذي ليوضح العنق والحشرة الداخلية مع صلت التأجيل الخاص بالمصنع					
Client Representative / Project Manager:		Date:			
					
Local Address: 5 Abd Elrahman Hussein Street, Monokhawan, Cairo, Egypt Tel: + (202) 7601919 - Fax: + (202) 760 66 64 Email: ehang@ehaf.com - www.ehaf.com CAIRO - ABU DHABI - DUBAI - DOHA - KHARTOUM					

SUCCESS PARTNERS



Our clients are our main partners who are proud of them and they are a driving force for us behind our relentless pursuit to gain their trust, which we are proud of.

We are working to meet all their needs and requirements in a way that contributes to their development at all levels that live up to their ambitions.

Therefore, we spare no effort to provide the finest services and products with high quality with unlimited possibilities that always fit their expectations



Our Projects





Emirate Of Riyadh Province





Saudi Data & AI Authority

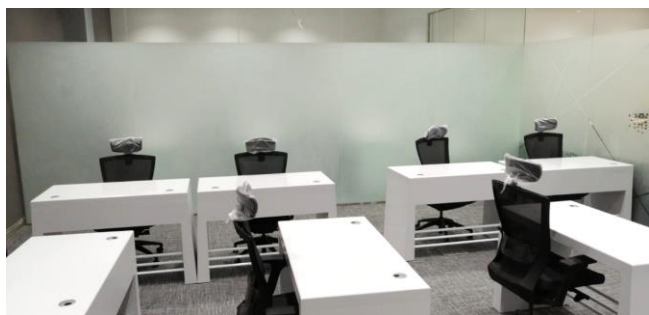
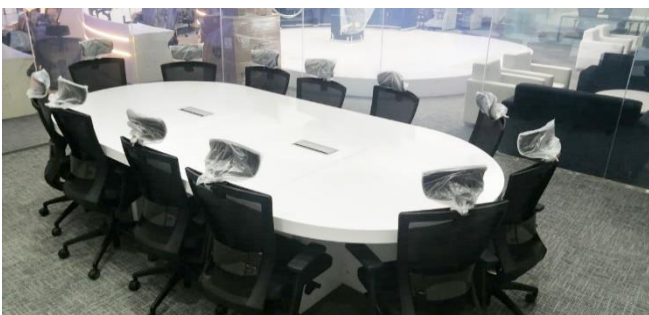
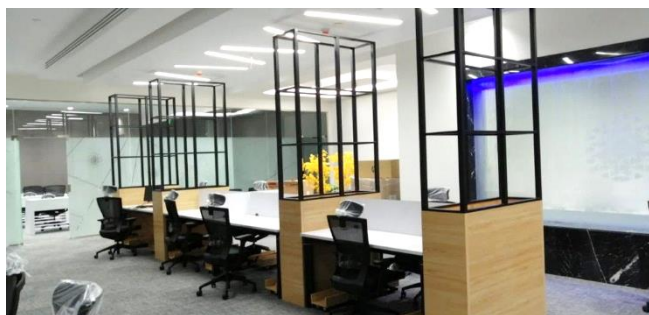



Saline Water Conversion Corporation (SWCC)





Saline Water Conversion Corporation (SWCC)





Saline Water Conversion Corporation (SWCC)





Saline Water Conversion Corporation (SWCC)





SAUDI RED CRESCENT AUTHORITY

رؤية
2030
المملكة العربية السعودية
KINGDOM OF SAUDI ARABIA

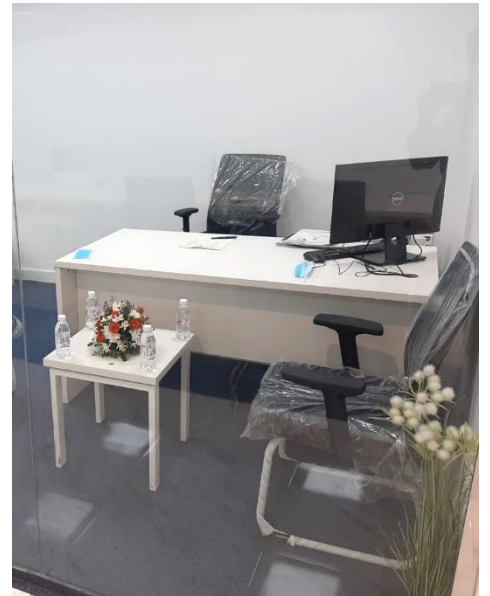

SPECIAL OFFICES CO.
شركة المكاتب المميزة التجارية



Saudi Technology and Security Comprehensive Control Company





OBEKAN

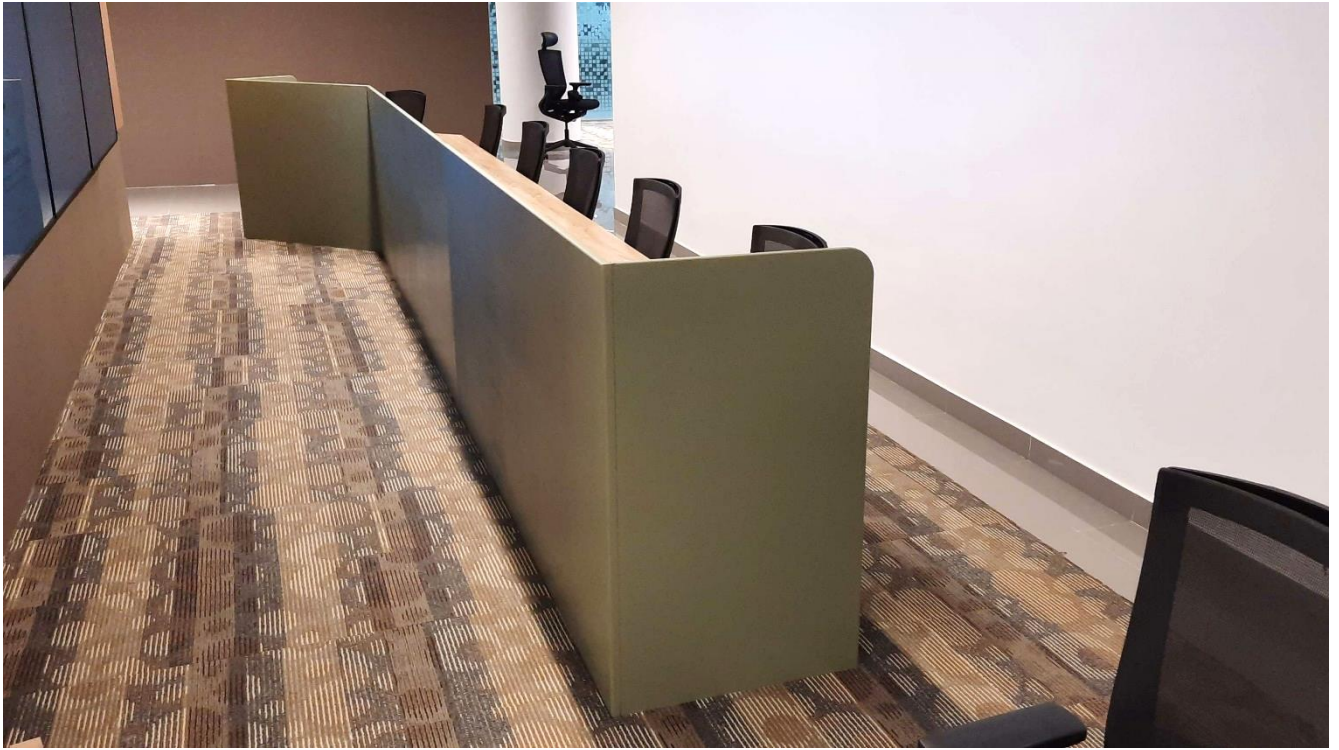



OBEKAN

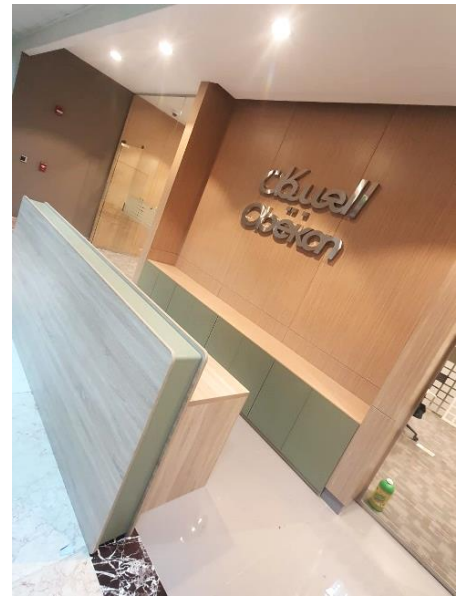
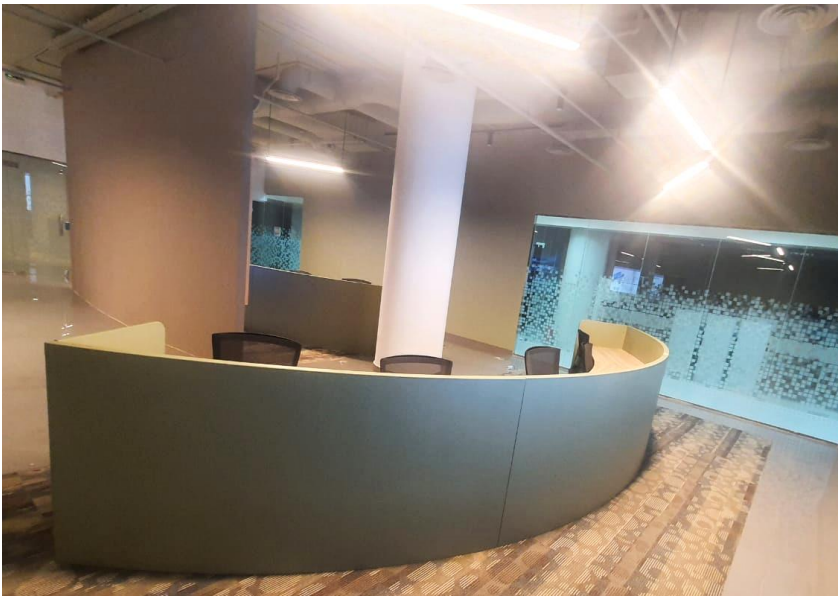
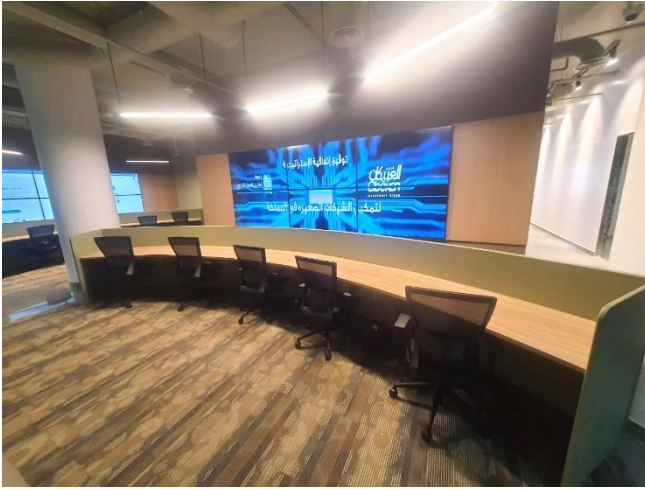



OBEKAN

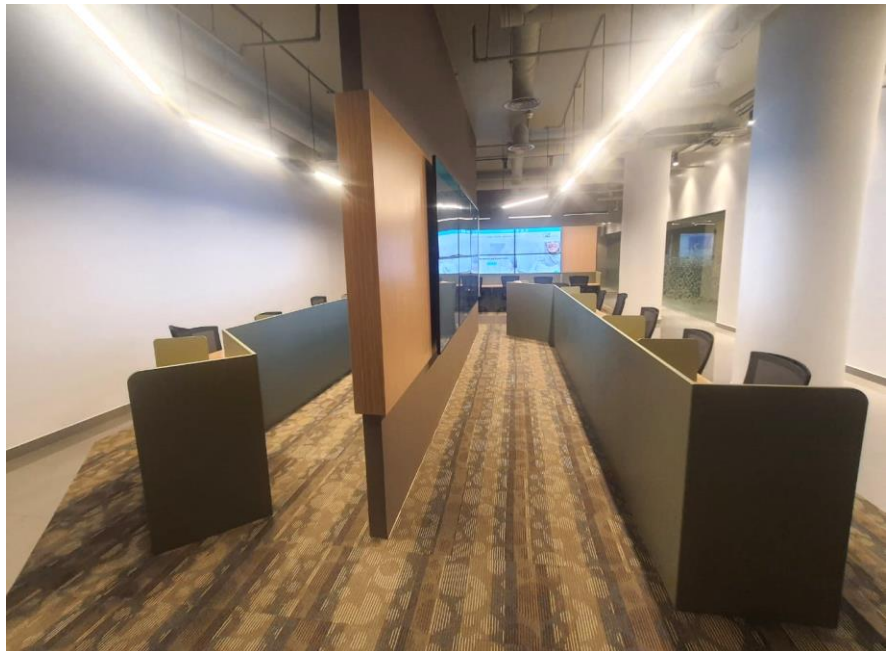
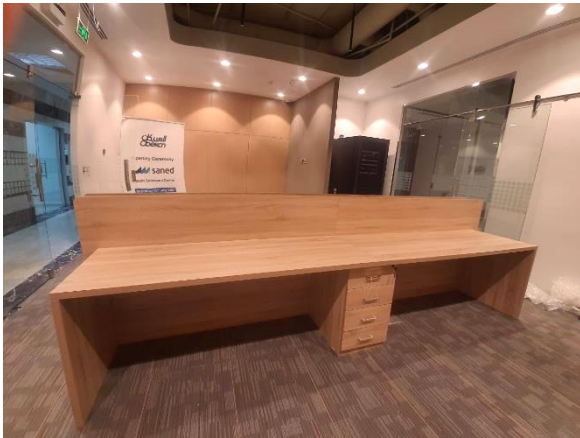



ALMUHIADIB





KING SAUD HOSPITAL

رؤية
2030
المملكة العربية السعودية
KINGDOM OF SAUDI ARABIA



SPECIAL OFFICES CO.
شركة المكاتب المميزة التجارية



General Authority of Civil Aviation





MINISTRY OF HEALTH

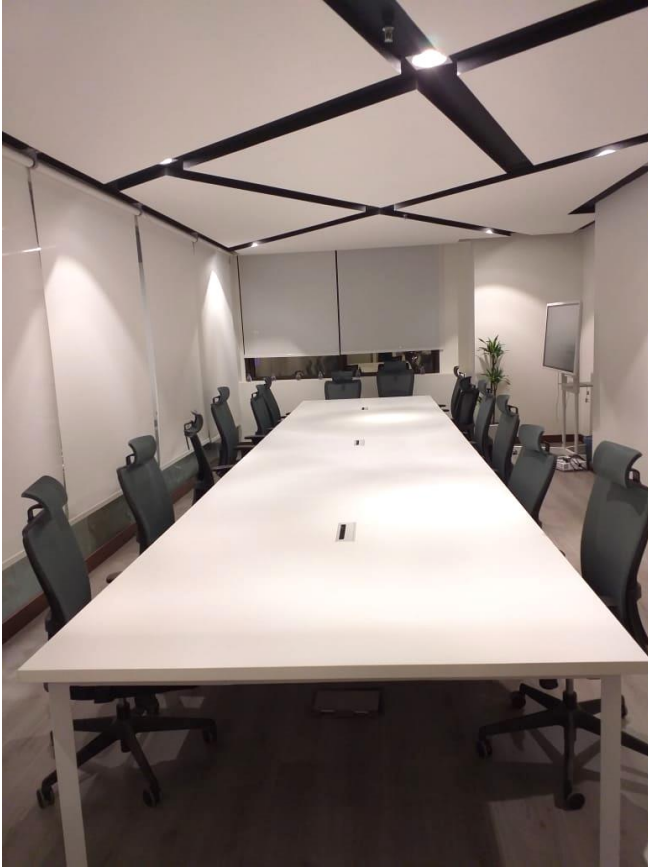



QASSIM UNIVERSITY

رؤية
VISION 2030
المملكة العربية السعودية
KINGDOM OF SAUDI ARABIA

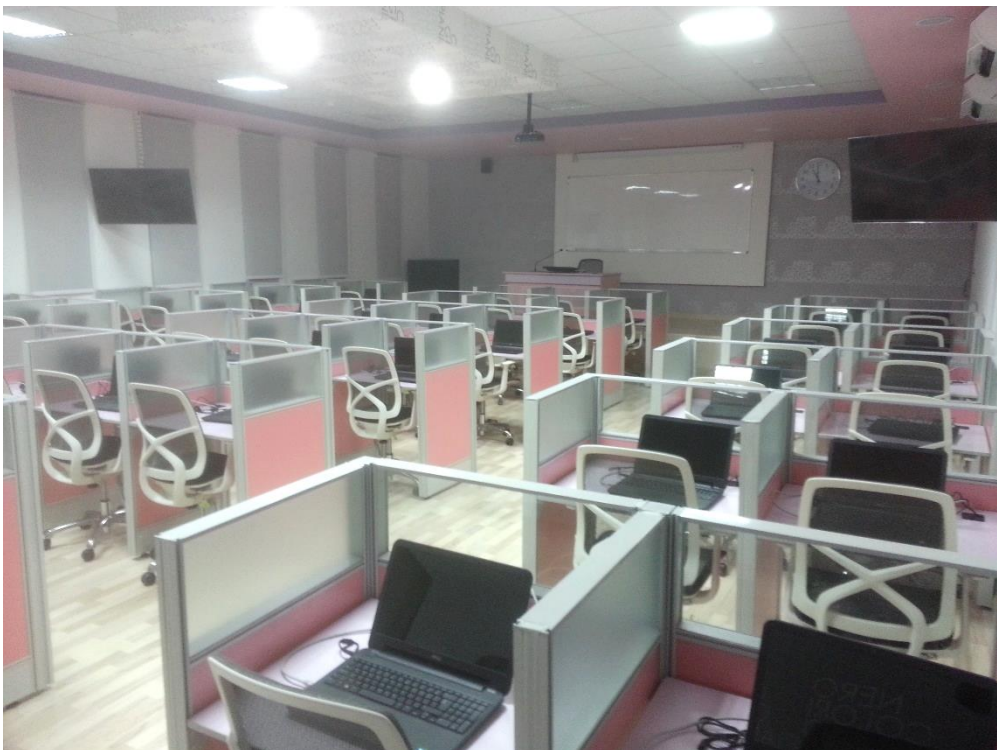
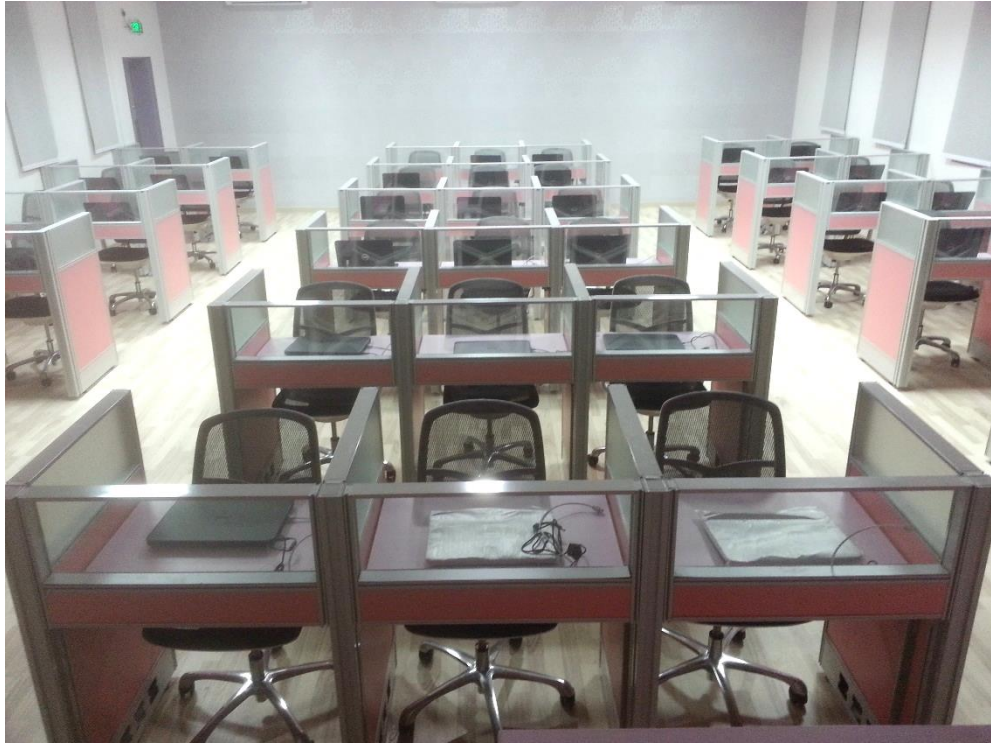

SPECIAL OFFICES CO.
شركة المكاتب المميزة التجارية



SAUDI MANPOWER SOLUTIONS COMPANY – SMASCO





ETISAL INTERNATIONAL COMPANY

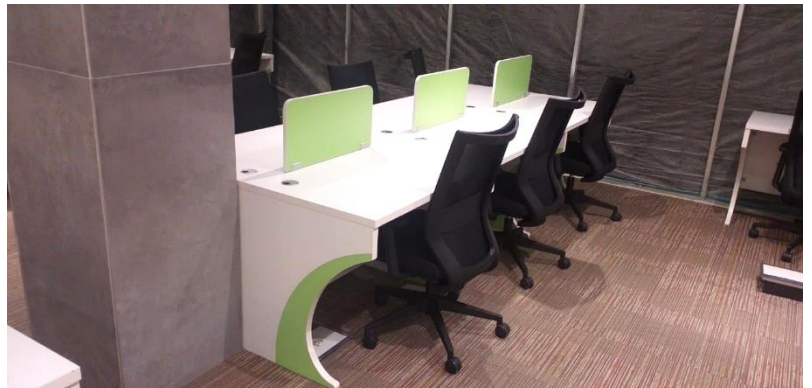
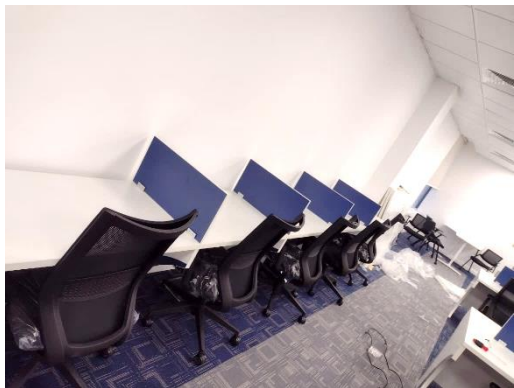
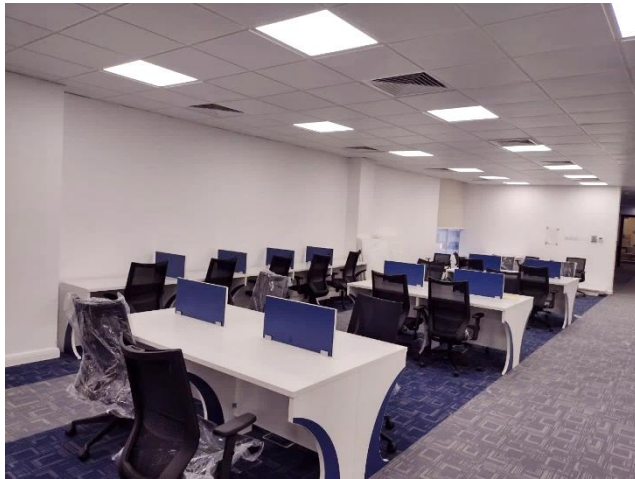



SAUDI XEROX





LEEN COMPANY

رؤية
2030
المملكة العربية السعودية
KINGDOM OF SAUDI ARABIA

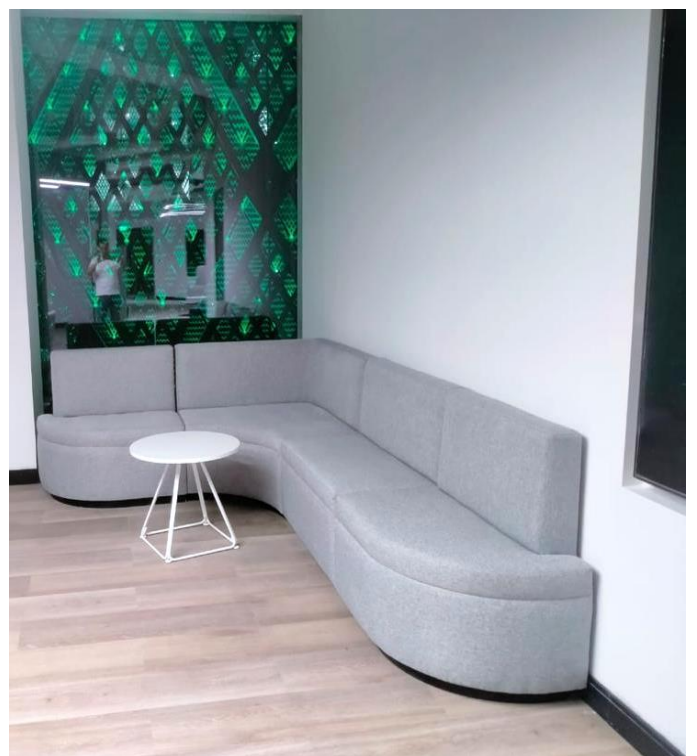

SPECIAL OFFICES CO.
شركة المكاتب المميزة التجارية



LEEN COMPANY





LEEN COMPANY

رؤية
2030
المملكة العربية السعودية
KINGDOM OF SAUDI ARABIA



SPECIAL OFFICES CO.
شركة المكاتب المميزة التجارية



LEEN COMPANY





LEEN COMPANY

رؤية 2030
VISION 2030
المملكة العربية السعودية
KINGDOM OF SAUDI ARABIA



SPECIAL OFFICES CO.
شركة المكاتب المميزة التجارية



LEEN COMPANY

رؤية
2030
المملكة العربية السعودية
KINGDOM OF SAUDI ARABIA

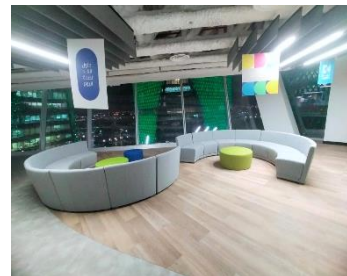
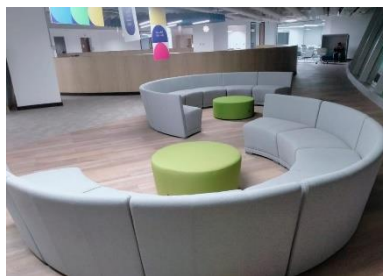

SPECIAL OFFICES CO.
شركة المكاتب المميزة التجارية



LEEN COMPANY

رؤية
2030
المملكة العربية السعودية
KINGDOM OF SAUDI ARABIA



SPECIAL OFFICES CO.
شركة المكاتب المميزة التجارية



SAUDI STANDARDS

رؤية
2030
المملكة العربية السعودية
KINGDOM OF SAUDI ARABIA



SPECIAL OFFICES CO.
شركة المكاتب المميزة التجارية



Dar Al-Naeem Hotel





Dar Al-Naeem Hotel





Dar Al-Naeem Hotel

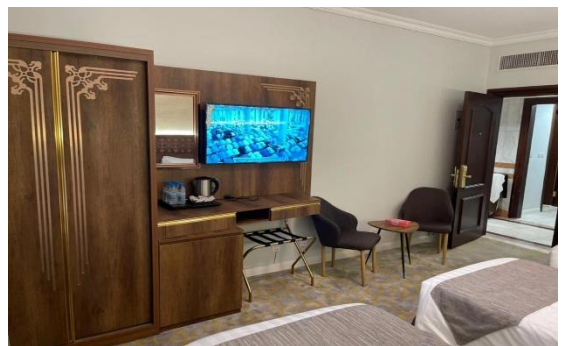
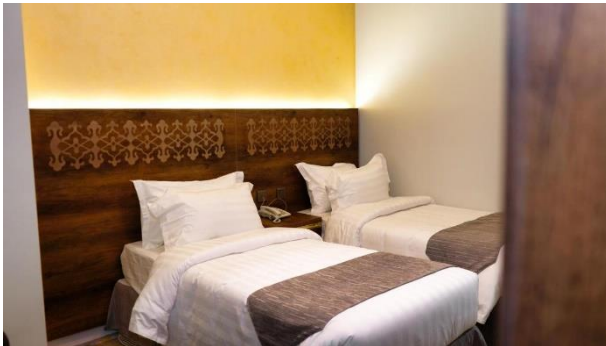
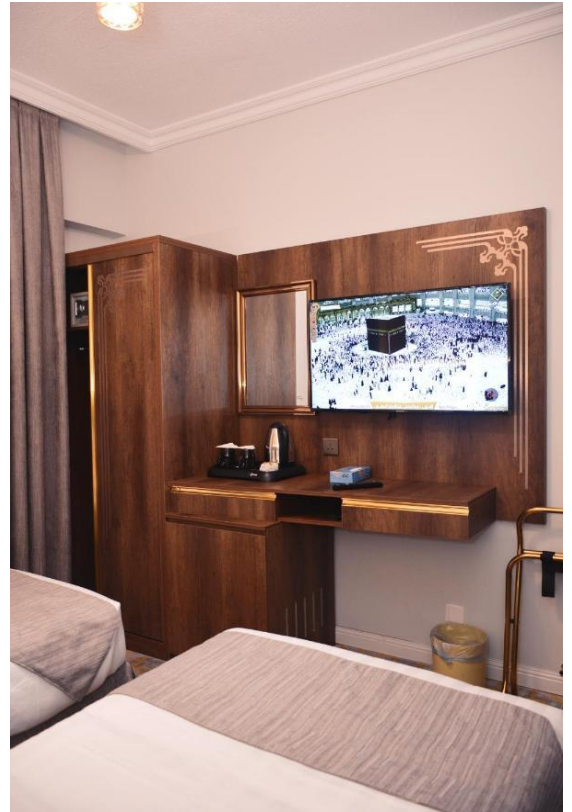



Al Rajhi Hotel





ENVIRONMENT COMPANY

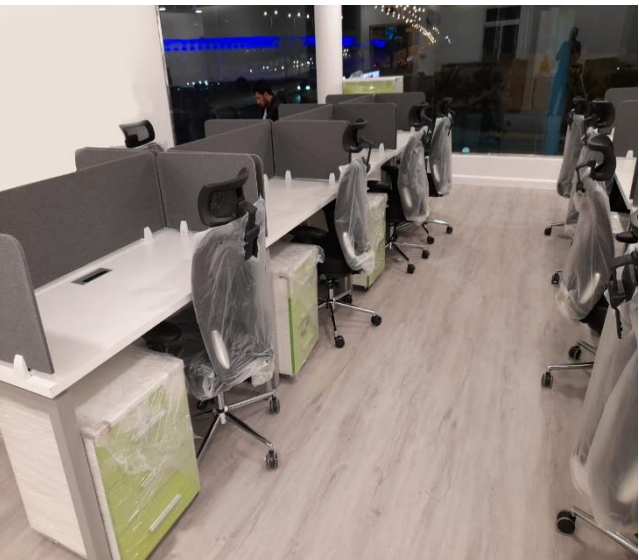
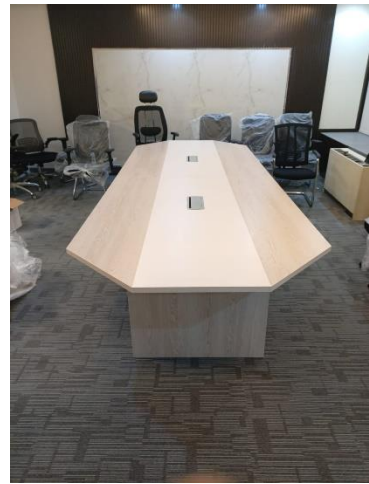



ABDULLAH AL-ANAWI

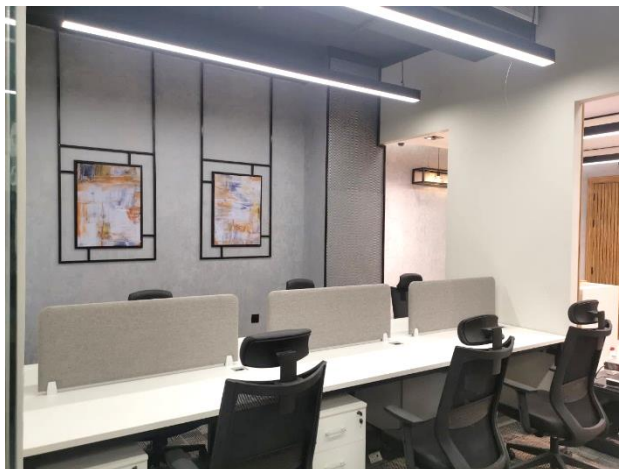
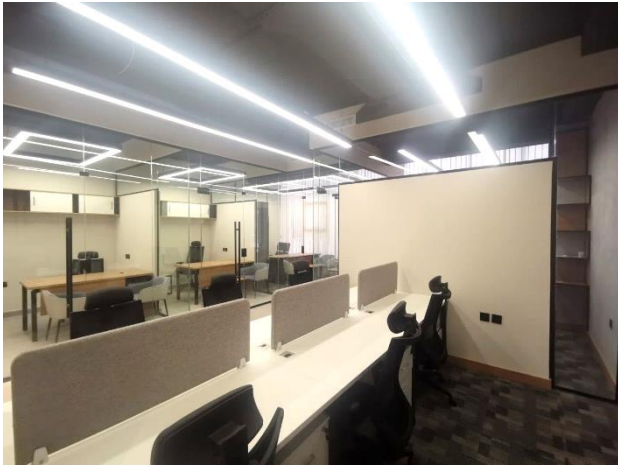

Our Products

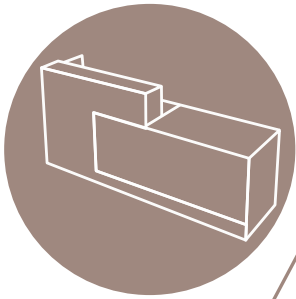
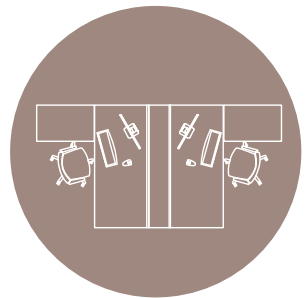
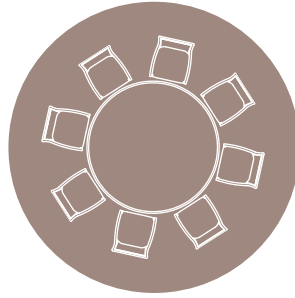
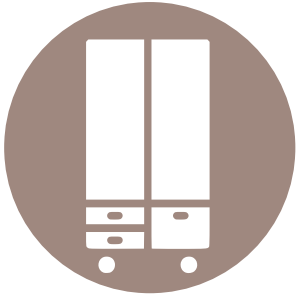
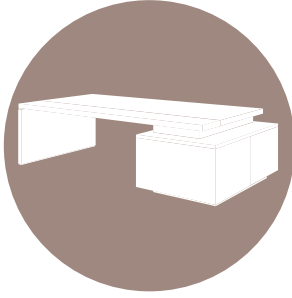
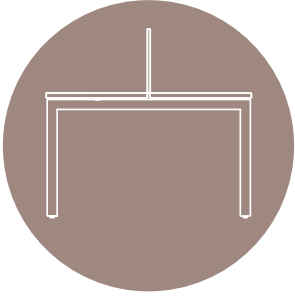

DESKS

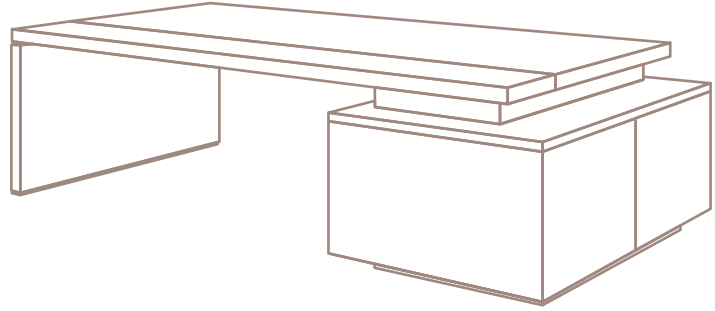
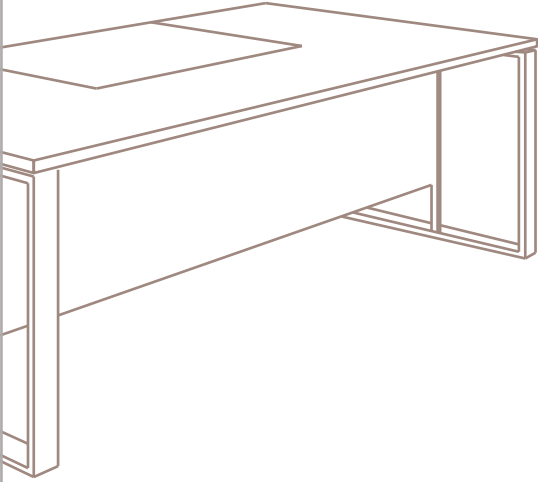

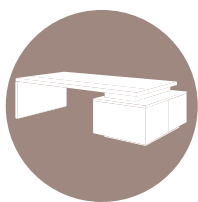

EXECUTIVE DESK



MITO

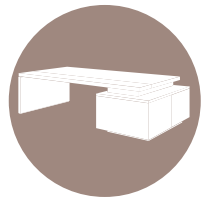

EXECUTIVE DESK



MITO

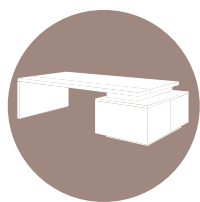

EXECUTIVE DESK



MITO

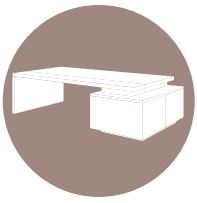

EXECUTIVE DESK



QUANDO

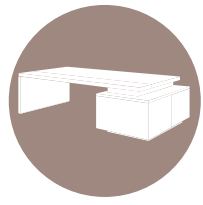

EXECUTIVE DESK



OGI SLIDE



DESK



OGI SLIDE





DESK



OGI T

BENCH

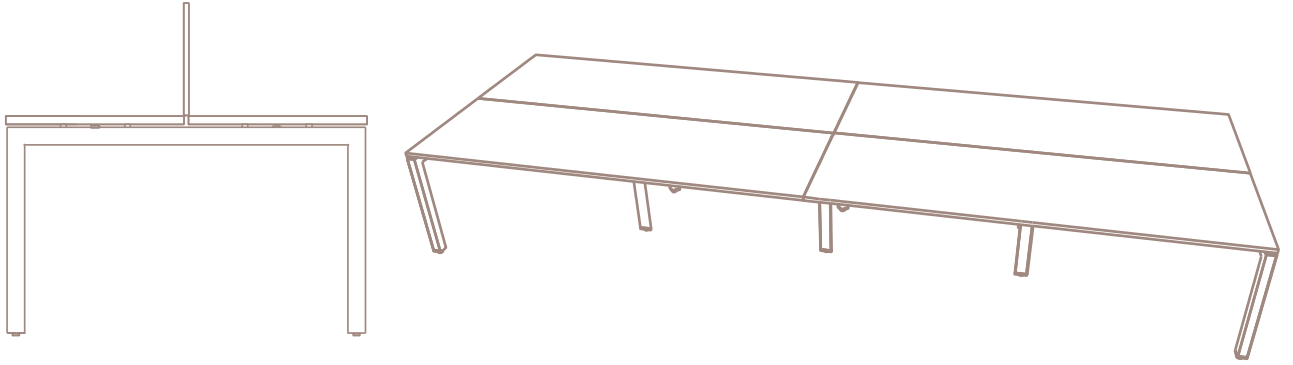

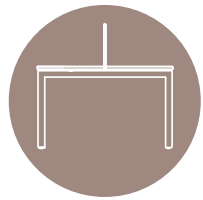

BENCH



OGI M BENCH

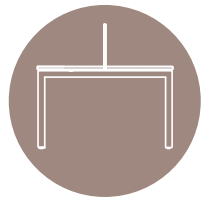

BENCH



OGI U BENCH

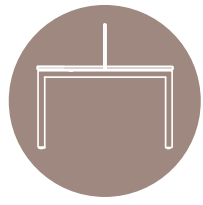

BENCH



HOOP

WORKSTATION

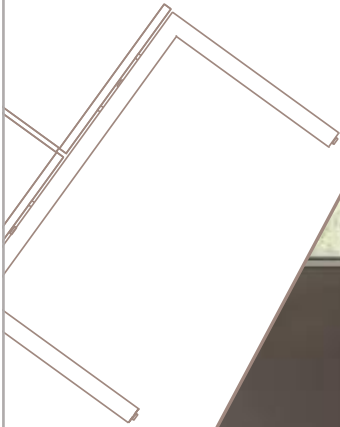
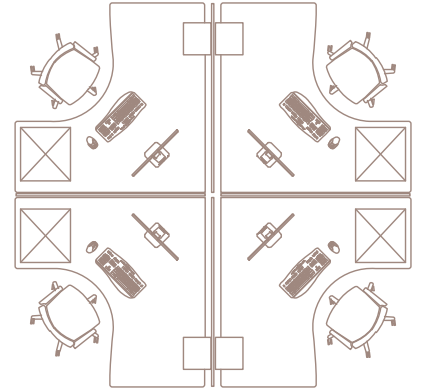
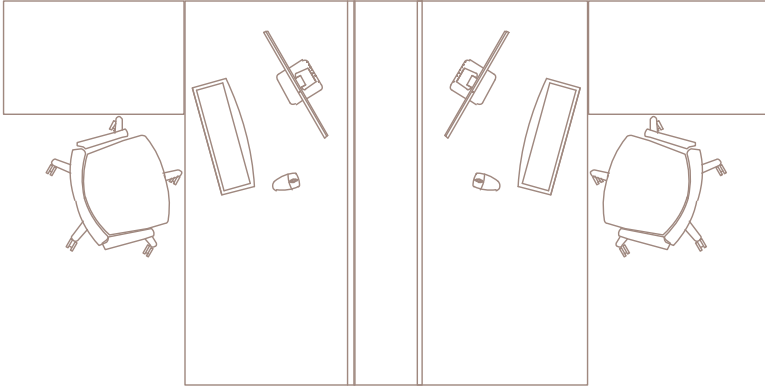

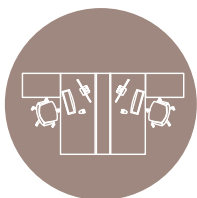

WORKSTATION



CUBICLE WORKSTATION

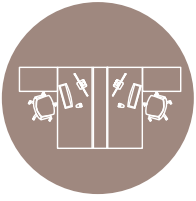

WORKSTATION



CUBICLE WORKSTATION

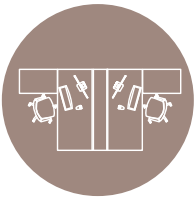

WORKSTATION



WORKSTATION

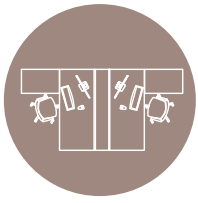

WORKSTATION



WORKSTATION

MEETING TABLES

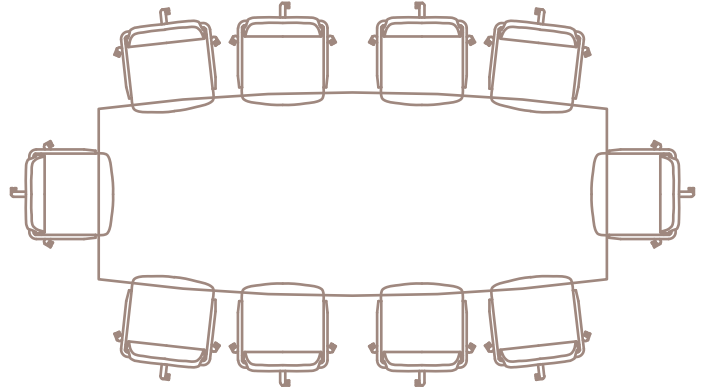
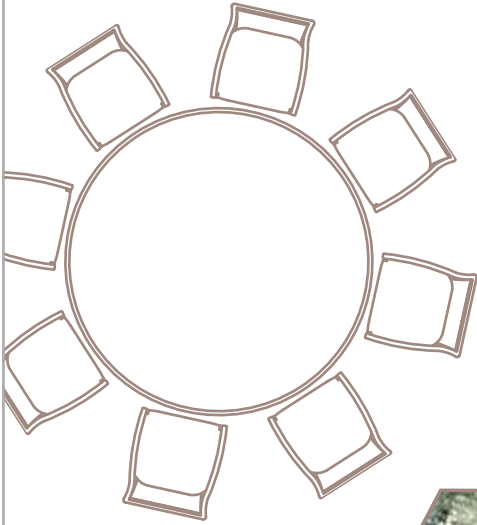

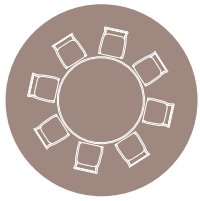

MEETING TABLES



STATUS

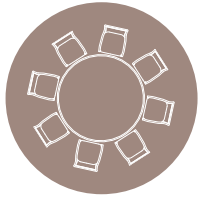

MEETING TABLES



MITO

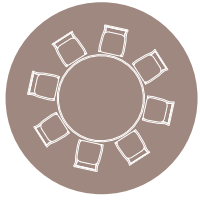

MEETING TABLES



FOLD

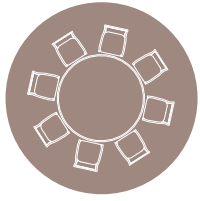

MEETING TABLES



MEETING TABLES

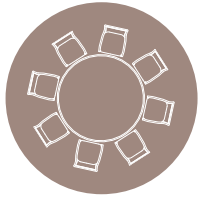

MEETING TABLES



GRAVITY

● chairs





Office chairs



EVO



SAVA



EVO



Office chairs



EVO



RENYA



OWT20



Office chairs



AC-103



CJ-103



DB-103



Office chairs



D7-101HL



D7-151L



D4 SERIES



Office chairs



D5-597



D7-201FHL



D7251FHL

Sofas

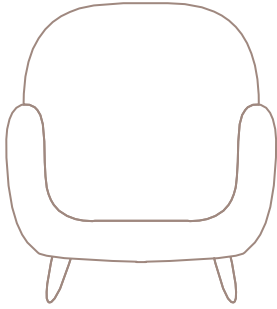



SOFA



ARTIKO



GRACE



SOFA



MESH



KAIVA



STILT





SOFA

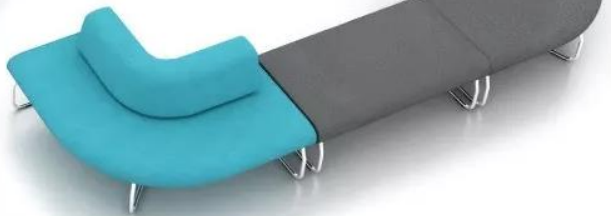
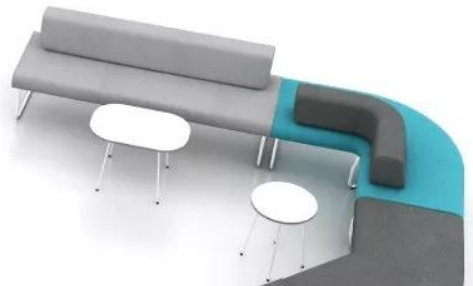
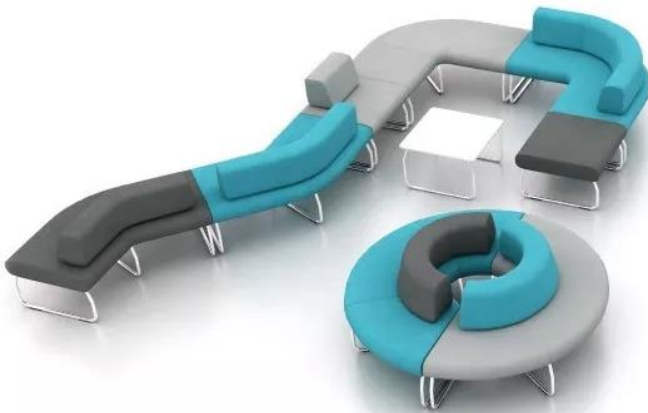

MODULAR SOFAS

Cabinets and bookcases

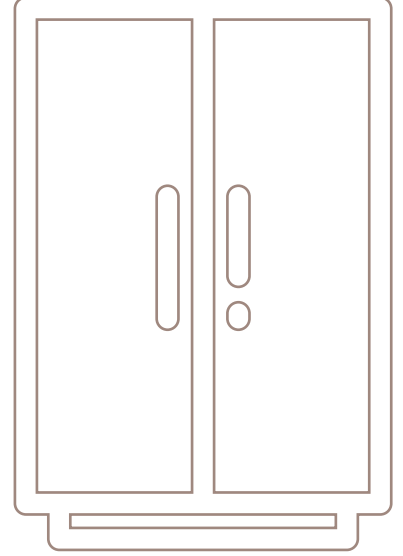
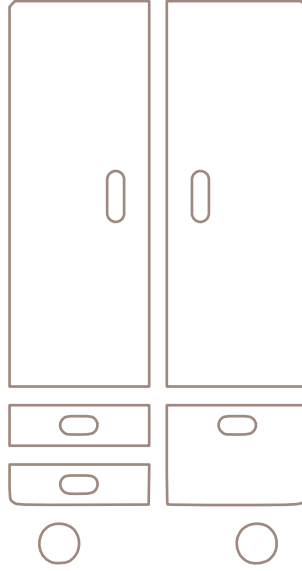
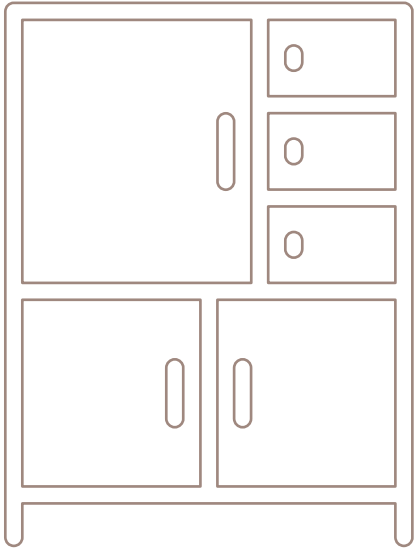

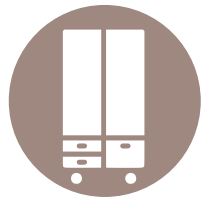

Executive Storage



VIGA

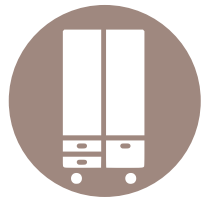

Executive Storage

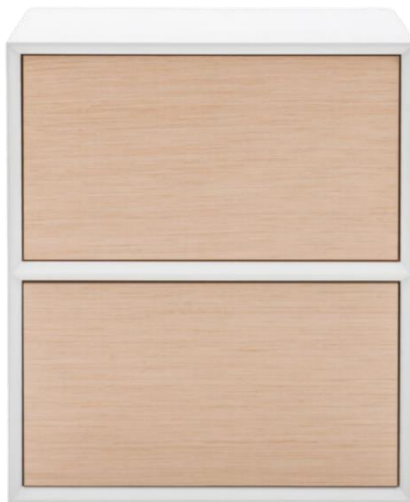

GRAVITY

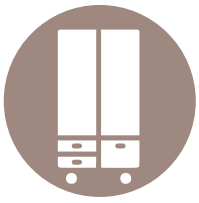

Executive Storage



VIGA



STANDARD



Executive Storage

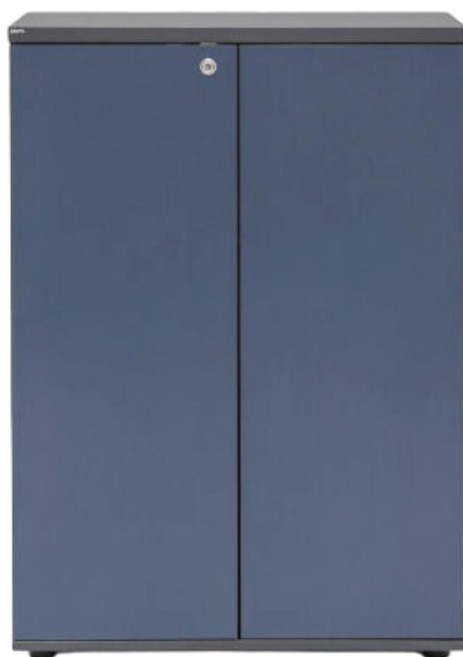

STANDARD



Executive Storage



LOCKER



Executive Storage



VIGA



BASIC

COUNTERS

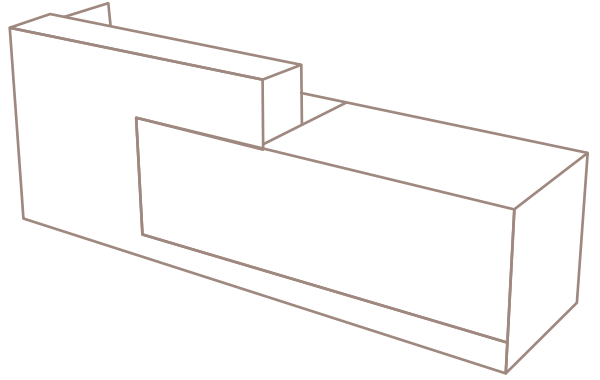
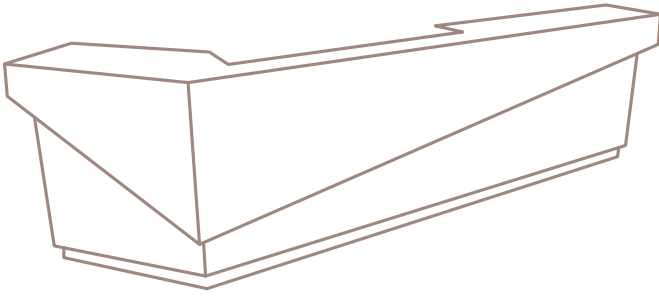

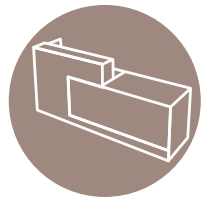

COUNTERS



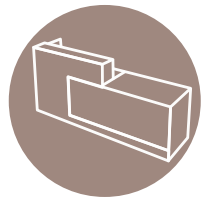

COUNTERS



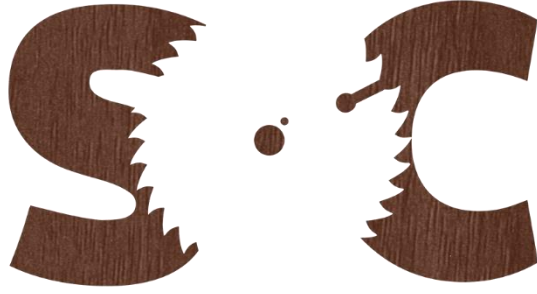

SPECIAL OFFICES CO.

شركة المكاتب المميزة التجارية

Contact Us:



+966 11 4764749



info@special-offices.com



Kingdom of Saudi Arabia
Riyadh
P.O. Box 1862 CODE 1141