

ASPECT WINDOWS



— ASPECT™ —
WINDOWS
ENERGY SAVINGS, SIMPLIFIED

THE PROFESSIONAL WAY

ProVia® has developed a competitive position by catering to a niche market that demands a high degree of customization coupled with superior quality. You will find attention to detail is what our customers have come to appreciate and expect from us. We're building your products and our company to last a lifetime...that's **The Professional Way**.

**MULTI
TIME**

Partner of the
Year Award



90%+

of Windows and Doors
are ENERGY STAR®
Certified

**remodeling
BRAND
LEADER**

#1 Quality
Rating
Vinyl
Windows

DOORS | WINDOWS | SIDING | STONE | ROOFING



6 Facilities in the United States

900+

Associates Nationwide

Our Mission:

— TO SERVE BY CARING FOR —
DETAILS
IN WAYS OTHERS WON'T

Doing Business Since

1977

19

Core Values

200+

Metric Tons of CO²
Saved Annually

1,900+

Tons of metals, paper, glass and vinyl
recycled annually at ProVia facilities

Visit provia.com to explore all of our products and options or
download the app.





INDUSTRY ASSOCIATION

ProVia is a proud member of the Window & Door Manufacturers Association, which promotes the standards of excellence in the residential window and door industry, and advances these standards among industry businesses with resources designed to provide greater value for their customers.



ACCREDITATION AND TESTING

ProVia's products are voluntarily third party tested and rated in several energy performance categories through the National Fenestration Rating Council and meet or exceed standards governed by the American Architectural Manufacturers Association.



ENERGY STAR®

ProVia manufactures energy efficient products and exercises environmental stewardship by recycling, reducing pollution emissions and much more. In fact, our company has received repeated awards from the Environmental Protection Agency such as Partner of the Year - Sustained Excellence for outstanding efforts in energy savings.

TABLE OF CONTENTS

- Why Choose Vinyl..... 2
- Standard Features 3
- INNERGY® Thermal Reinforcements 4
- Insulation & Weatherstripping..... 5
- Screen Options 6
- Window Types..... 10
- Color Options 15
- Hardware Finishes 16
- Glass Packages 20
- Privacy and Tint Glass Options..... 21
- Grid Options 23
- Internal Blinds 24
- MasterFit™ Trim 27
- ProVia App 28

WHY CHOOSE VINYL

YOUR VERSATILE WINDOW SOLUTION



Aspect™ windows are constructed of SunShield® vinyl, made with a compound proven to perform better than alternative building materials. Vinyl ensures long-lasting color retention and low maintenance, plus the added confidence of a warranty against rotting, cracking, pitting, corroding and peeling. The vinyl is resistant to rot, insect and microbial damage, never requires painting and is easy to clean.

Low Maintenance

Vinyl windows are the low-maintenance choice for residential use.

Superior Weatherability

SunShield vinyl is uniquely formulated to withstand the harsh effects of weather, UV light and southern exposure.

Color Retention

Pharmaceutical-grade compounding and blending systems provide consistency, so you can rely on superior color and weatherability.

Designed to Perform

Industry partnerships and ongoing research into new technologies ensure the vinyl compound exceeds industry standards, outperforms the competition and works together to offer best-in-class technology.

Uncompromising Quality and Performance Testing

SunShield vinyl meets or exceeds the standards for strength and color retention established by the American Architectural Manufacturer's Association (AAMA).

STANDARD FEATURES

WHAT TO EXPECT WITH YOUR ASPECT WINDOW

Aspect windows can be completely customized to fit your exact style. Everything from the window size, color, hardware finishes, glass packages and trim options can be chosen by you.

Design the windows for each room in your house differently, or if you prefer a simple, seamless look, your windows can all be the same. The design options available to you are virtually endless. The features below are standard on all Aspect window styles.

3¼" Frame Depth

SunShield® Vinyl

¾" ComforTech™ DLA for Dual Glaze

1" ComforTech TLA or
TLK for Triple Glaze (Upgrade)

Optimized Wall Placement for Exceptional
Thermal Performance

INNERGY® Thermal Reinforcement
(Double Hung, Slider & Casement)

Accessory Grooves for Interior and Exterior Trim

Welded Frame and Sash Construction

Barrier-Fin and Bulb Seal Weatherstripping

Roll Formed Aluminum Screen Frame with
BetterVue® Fiberglass Mesh



LIFETIME
— LIMITED WARRANTY —

UNDERSTANDING YOUR WINDOW FEATURES

REINFORCEMENT

INNERGY® Thermal Reinforcements

Innergy is the innovative, energy-efficient alternative to aluminum, with added insulating properties making it 700 times better.



As the next-generation of thermal reinforcement for the industry, Innergy is able to deliver a quantum leap above aluminum in how windows perform:

Better Thermal Performance

Up to 700 times better than aluminum in material comparisons.

Better Thermal Break

Impervious to cold or heat.

Better Protection Against Condensation

Helps prevent staining that can occur with metal reinforcements.

Better Impact Testing

Resistance to impact versus other reinforcement products.

Better Flexibility

Will not permanently set when impacted.



Innergy and Aluminum in a 32 degree ice bath

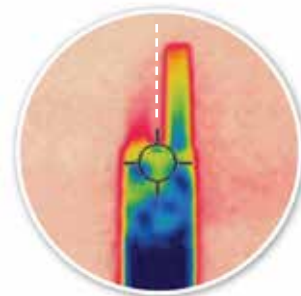

Infrared analysis shows substantial conductivity in aluminum (shown on the right), and virtually none with Innergy (shown on the left)*

* Photos taken after one hour ice bath

INSULATION

Neopor® (Optional)

Neopor is a graphite polystyrene rigid foam insulation that gives maximum efficiency and sustainability in building products. It is comprised of many small pockets of air within a polymer matrix containing graphite. The graphite reflects radiant heat energy like a mirror, increasing the material's resistance to the flow of heat, or R-value. Most polymer-based foams exhibit a greater ability to slow the movement of heat as the temperature decreases; however, Neopor is unique because it increases R-Value as the temperature outside drops.



The vinyl profiles used in an Aspect™ window are designed with premium wall cavities providing the highest levels of efficiency. This strong and rigid vinyl extrusion keeps you comfortable in your home without the need for insulation.

To provide further comfort, ProVia® uses Neopor insulation in certain cavities for even greater performance. Therefore, you can rest assured both the window frame and sash, along with the Neopor insulation are effectively regulating the temperature inside your home.

WEATHERSTRIPPING

Weatherstripping is a very important part of preventing air from coming into your home. ProVia's windows have weatherstripping on the frame and sash, ensuring you get a good seal at the important locations where air could pass through.

Bulb Seal



Bulb seals are seamless closed-cell compression seals that prevent water from penetrating the foam cell structure. Its extruded skin provides a unique UV resistant barrier with design features that enhance the weatherstrip's sealing performance.

Barrier-Fin



Seal woven and extruded pile weatherstripping with fin provides a very effective barrier against air, water, dust and noise, sealing against even and uneven surfaces with resistance to abrasion.

TEST SPECIFICATIONS

Aspect Double Hung 44" x 75"

| Test | Test Specification | Results |
|------------|---------------------------------------|-----------------------------------|
| Air | ASTM E 283 | 0.05 cfm/ft ² @ 25 mph |
| Water | ASTM E 547 | 7.52 psf |
| Structural | AAMA/WDMA/CSA 101/1.S.2/A440-8 and 11 | R-DP50 142 mph |

Test data is a result of sizes shown, configurations and lab conditions of a certified independent third party laboratory.

Please reference the Window & Patio Door Technical Specifications Brochure for testing data on other window types.

YOUR SCREEN MESH OPTIONS

STANDARD

BetterVue® Fiberglass

Aspect™ windows come standard with a roll formed screen frame with BetterVue fiberglass mesh, which can be easily removed for regular cleaning and maintenance.

BetterVue screen mesh is very durable and flame retardant, providing an enhanced view, increased insect protection and improved airflow.

Now featuring Phifer's® Water Shed Technology™, which preserves optical clarity by shedding water and resisting dirt and grime.

The Water Shed Technology features a hydrophobic coating that will not wash off, which allows the screen to shed water and debris from a rainstorm or garden hose. This means your screen virtually eliminates window panning, a process by which the water fills the open squares in the screen.



OTHER OPTIONS

FlexScreen®

Nearly indestructible. Barely visible.
Available with BetterVue or Heavy Duty Fiberglass Mesh.

SIMPLE DESIGN

PVC coated spring steel frame with no attachment hardware.

EFFORTLESS INSTALLATION

Simply hold the screen in your hands, bend the sides in, and fit FlexScreen into your screen pocket.

DAMAGE RESISTANT

No more bent aluminum frames, scratched paint and broken hardware.

BEAUTIFULLY INVISIBLE

FlexScreen easily hides in the window screen pocket, drastically improving sight lines.

Lifetime Limited Warranty



SeeVue® Stainless Steel Screen

Much stronger than the standard insect screen, this stainless steel screen is excellent for window applications. It is black coated for improved visibility and allows superior airflow.

If you're looking for a stronger alternative to the BetterVue screen, upgrade to a SeeVue. This screen mesh is available in an extruded aluminum frame.

Also available: Aluminum and Heavy Duty Fiberglass Screen Mesh

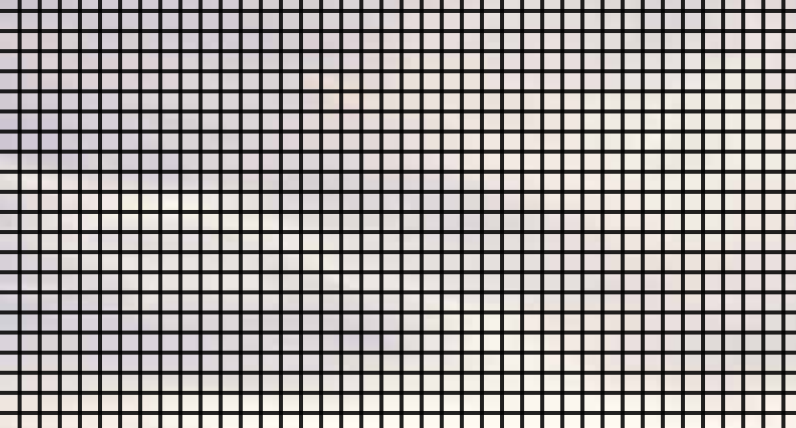

Industry Standard Insect Screen

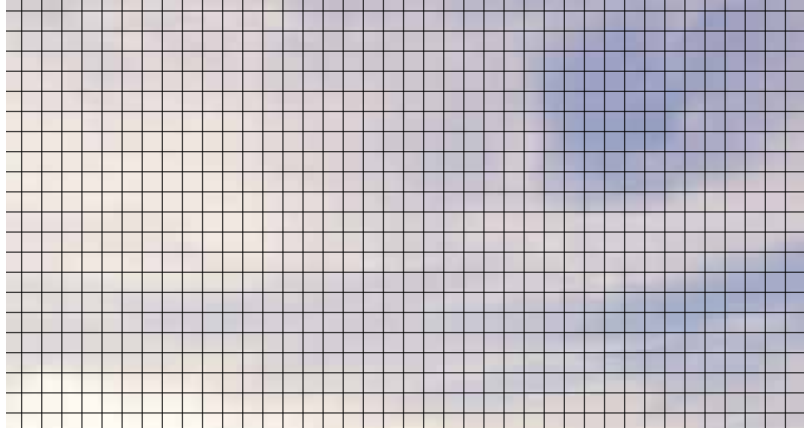

BetterVue® Screen







CHOOSE YOUR WINDOW TYPE

DOUBLE HUNG



Double hung windows are ideal in every room of the house since they are easy to open and clean. Both sash tilt inward, while the screen stays in place. Put two or more double hung windows in a row to create an aesthetically appealing look.

Features

- Roller-Tilt® Balance System
- Exterior Glazing
- Cove Sash Profile
- Triple Weatherstripping
- Two Surface Mounted Sculptured Sweep Locks and Tilt Latches
- Dual Vent Locks
- INNERGY® Thermal Sash Interlock Reinforcements

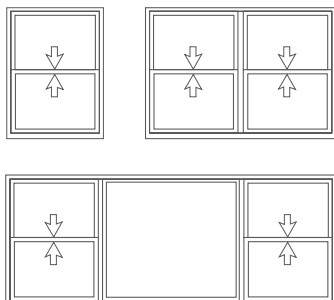

SLIDER



Slider windows are another classic found in many homes. These windows work well above the kitchen sink or in any room where ventilation is important. Slider windows work great by themselves or paired with picture windows.

Features

- Brass Rollers
- Exterior Glazing
- Cove Sash Profile
- Dual Weatherstripping
- Two Surface Mounted Sculptured Sweep Locks
- INNERGY® Thermal Sash Interlock Reinforcements
- Vent Lock
- Anchor Stops (standard on 3-Lite Sliders)

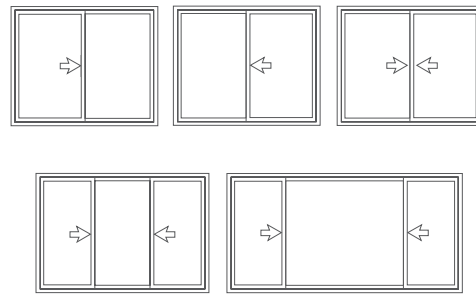

PICTURE



Picture windows are perfect for any room with a view. They help capture the beauty that surrounds your home, while complementing other windows. Pair several picture windows together to bring in the beauty of the outdoors.

Features

- Fully Welded Frame
- Direct Set Glass
- Interior Glazing
- Sloped Sill

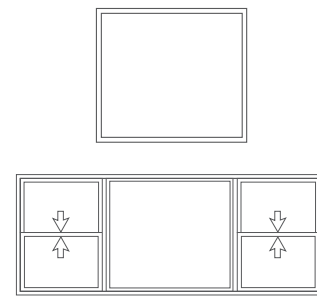

CASEMENT & AWNING



Casement and awning windows add style and flair to your home, allowing the perfect amount of ventilation desired. Group casement and awning styles together to create a beautiful wall of operational windows.

Features

- Exterior Glazing
- Square Sash Profile
- Casement Corner Drive System on Units 56¼" Tall and Taller (and 24" and wider)
- Multi-Point Locking Hardware
- Washability Hinge (Casement)
- Quick-Release Dual Arm Operator (Awning)
- INNERGY® Thermal Frame Reinforcements
- Optional Simulated Double Hung Meeting Rail (Casement)
- Fold-Away Handle

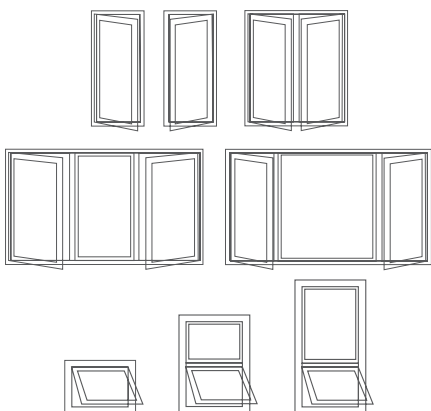

HOPPER



The hopper window is perfect for a basement, bathroom or laundry room, giving you adequate ventilation and natural light. These windows help add curb appeal to your home, providing light in a space that may otherwise be very dark.

Features

- Interior and Exterior Accessory Grooves
- Durable Top Mounting Lock and Hinge
- Insulated Panel Option Available to Mull to a Hopper Window
 - Dryer Vent Not Included. Must be Installed Separately
 - Hopper Window and Insulated Panel Available in White Only

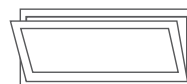

ARCHITECTURAL SHAPES

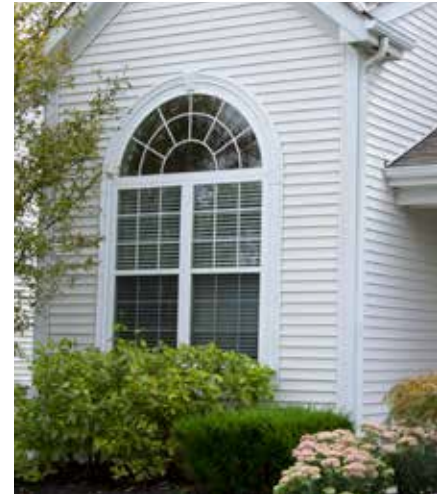

Architectural shapes will complement your home's unique style, while allowing more natural light to brighten up your space. Shaped windows look great above other styles of windows or they can easily accent a patio door.

Features

- Fully Welded Frame
- Direct Set Glass
- Wide Range of Shapes Available
- Optional Operating Octagon Shaped Window

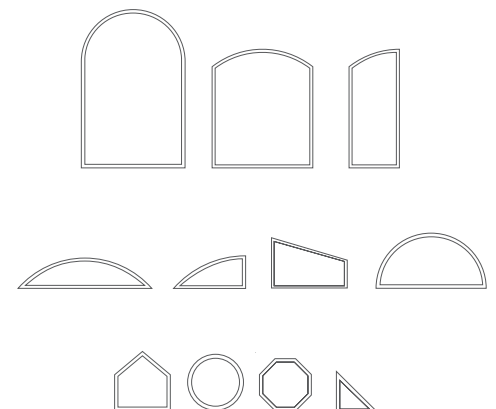

GARDEN



The garden window looks great in a kitchen, bathroom or den, providing a perfect place for decorative accents or foliage and herbs. This unique window style not only allows more light in, but also helps open up your room.

Features

- Top Sloped Tempered Insulated Glass
- Completely Assembled with Unfinished 1¼" Oak Veneer Head, Jamb & Seat Board
- White and Beige Laminate Head, Jamb and Seat Board Available as an Upgrade
- Snap-In Corner Slope Closure Profile Seals Tight
- Twin Sealing, Fully Screened Operating Casements with Exterior Glazing
- Easy Access Dual-Point Locking Operator
- Fold-Away Handle
- Fiberglass FlexScreen®

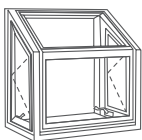

BAY & BOW



Bay and bow windows look amazing in a living room or master suite, giving you the versatility to choose a combination of picture, double hung or casement windows. The seat on a Bay or Bow window is a great place to sit and read or just enjoy the view.

Features

- Bay:** 3-Lite Unit with 2 Operable Windows with Screens
- Bow:** 3, 4, 5 or 6-Lite Units with 2 Operable Windows with Screens

Roof Kits Available in wood, painted aluminum and copper.



Bay Window - Hip Style Roof



Bow Window - Hip Style Roof









CHOOSE YOUR COLOR

Vinyl Window Colors

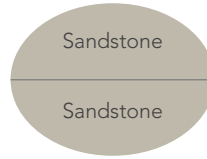
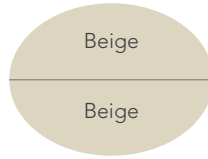

TUFTEX Smooth Cladding Colors

Aluminum trim coil with mar-resistant smooth finish

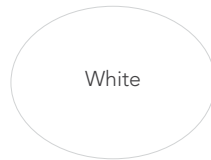

Garden windows available in White and Beige.
Hopper windows available in White.

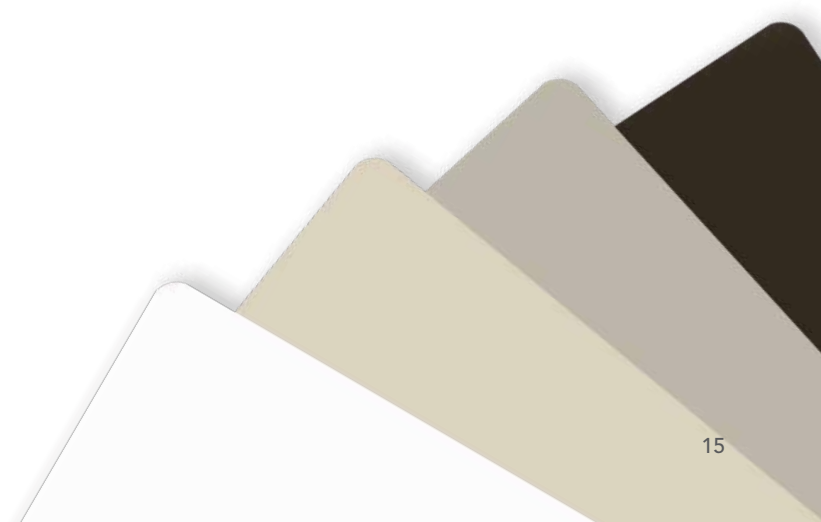

SELECT YOUR HARDWARE FINISH

Double Hung and Slider Windows

Standard Finishes



White

Beige

Sandstone

Optional Decorative Finishes with DualTech™ Integrated Tilt Latches



Antique Brass

Satin Nickel

Flat Bronze

Casement and Awning Windows

Standard Finishes



White

Beige

Sandstone

Optional Decorative Finishes



Antique Brass

Satin Nickel

Flat Bronze

Upgrade to Optional Lock-Out Crank Handle

The lock-out feature prevents the handle from closing prematurely while operating the window. The handle can be easily put in the closed position by engaging the lever on the back (as pictured below).

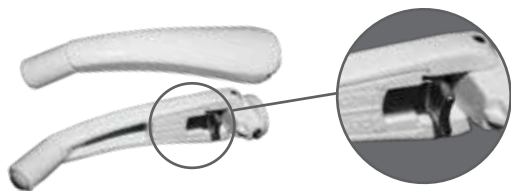

White, beige or sandstone interior windows come standard with matching hardware. Upgrade to one of the beautiful decorative finishes on any window, enhancing the overall beauty of your room.





Shown: White Double Hung Windows with Grids

ENERGY SAVINGS, SIMPLIFIED





WHICH GLASS PACKAGE IS RIGHT FOR YOU?

FEATURING COMFORTECH™ WARM EDGE GLAZING SYSTEM

Most of your new window is glass. That's why we use the ComforTech Warm Edge Glazing System featuring Super Spacer® on all Aspect™ windows. This gives you reduced heat loss, warmer glass temperature and reduced interior condensation. All ComforTech products have passed stringent testing and are IG Certified to ensure seals are durable and will not leak.



The No-Metal Advantage

Thermal efficiency through no presence of conductive metals is the Super Spacer hallmark.

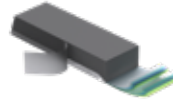

Mylar 10-Layer Vapor Barrier

The Super Spacer thermoset foam matrix is exceptional. Moisture is kept out, gas is kept in and conductivity is virtually nonexistent.



Lasting Appearance

Our Warm Edge Glazing System stands up to the natural bending and bowing from temperature changes, barometric pressure and wind load.



Enhanced Noise Reduction

The all-foam formula's excellent sound dampening properties reduce outside noise, even in industrial environments.

WHAT'S THE DIFFERENCE?

Krypton Gas

Inert to glass coatings, heat and spacers, krypton gas has the lowest conductivity of any gas used and raises the inner glazing temperature. This gas performs well in small chambers, making it the best choice for triple-glazed glass packages.

Argon Gas

Chemically inert to UV radiation, argon gas insulates better than air. It is sunlight stable, non-corrosive and non-toxic, making it the best choice for double-glazed glass packages.

ComforTech™ TLK

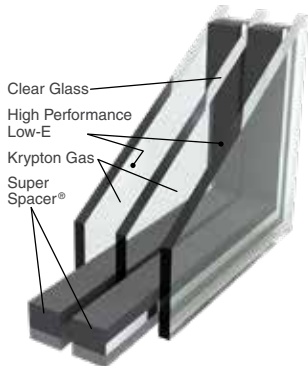

ComforTech™ TLA

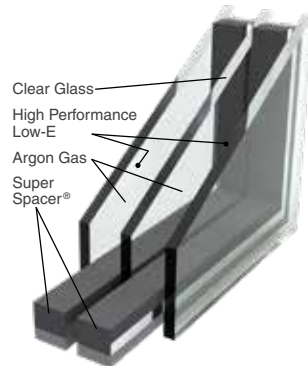

ComforTech™ DLA-HC



ComforTech™ DLA



ADD EXTRA PRIVACY AND TINT TO YOUR WINDOW

Privacy Options

Choose from five different types of glass if you need light to filter in, yet want to maintain privacy. These glass styles look great in rooms where privacy is important. Regardless of where it is used, privacy glass reduces the likelihood of needing extra window coverings.



CHINCHILLA



TAFFETA



WATERFALL



GLUECHIP



OBSCURE PEBBLE

Actual privacy levels will vary depending on your distance from the glass and also the amount of light in the room in comparison to the light outside your home. For extra privacy, choose two panes of privacy glass, rather than just one.

Tint Options

Our tinted glass can help reduce UV transmittance, solar heat gain and glare. Tinted glass options can give a room a whole new look, providing its own unique set of benefits. Be sure to choose the right one for your home.



Solargray® Gray Tint

Excellent glare control
 Exceptional protection against interior fabric and color fading
 Ultraviolet light protection



Solarbronze® Bronze Tint

High visible light transmittance
 Warm glow to interior décors
 Complements brick and stone
 Ultraviolet light protection



Solexia® Green Tint

Subdues interior brightness
 High visible light transmittance



Azuria® Blue Tint

Low shading coefficient
 High visible light transmittance
 Solar performance (reduces solar heat gain)



STYLE YOUR WINDOW WITH GRIDS

The style of grids you choose can make a big impact on your home's appearance. Grids look great on the front side of a house or in accent windows throughout the home. You can choose from internal or external grids and several grid patterns including Cottage, Colonial and Prairie styles.



External Grids

Simulated Divided Lites (SDL)

Grids are applied to the glass on both the interior and exterior of the window.

Internal Grids

If you want grids, but prefer not to clean around them, opt for internal grids so you get the same look and feel, without the hassle.



Contoured

Flat

Pencil
Available in Satin
Nickel, Brass and
Bronze

V-Groove
Available in 3/8"
or 1/4"

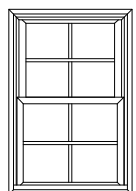

Cottage

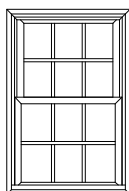

Colonial

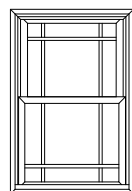

Prairie

Internal and external grids are available in many configurations of Cottage, Colonial and Prairie styles.



Triple Glazed Glass

Internal grids with triple glazed glass are placed between two glass panes with the added efficiency of a third pane.



Double Glazed Glass

Internal grids with double glazed glass are placed between two panes of glass.

ADD INTERNAL BLINDS

If cleaning dusty blinds makes you cringe, be sure to add internal blinds to your windows. These blinds are made with sturdy, white aluminum and are custom-fit to the exact dimensions of each window.

Perfect for every room in your house, internal blinds can be lifted up to allow maximum light in, or they can be tilted to keep some light out while maintaining privacy needed in bedrooms or bathrooms.



Interior View

Blind operator as
viewed from the
interior of the home

Blinds can be added to Double Hung (top, bottom, or both sash), Casement, Awning, Picture and Slider windows.

Blind slats are ½" wide.

*Internal Blinds come with a **10-year Limited Warranty**.*

Allow for additional lead time on your window order.

Blinds and grids not available together.







FINISH YOUR WINDOW WITH MASTERFIT™ TRIM

Add the finishing touch to the interior of your windows with the MasterFit trim system, complete with assembled frame extensions that interlock with mortise and tenon casing. Our MasterFit trim system guarantees a precise, custom-fit and long-lasting factory applied finish.



Profile Options



2½" Modern Profile 2½" Colonial Profile 3½" Colonial Profile 3½" Flat

Additional Trim Options



Traditional Interior Stop
1½" W x ½" H

Jamb Extension
2½", 4½", or 5½" W x ¾" H

Stool
3½" or 5½" W x 1" H

Shoemold Interior Stop
¾" W x ½" H

Rosette
3/8"

Stain Finishes

Oak



Cherry



Maple



Paint Finishes

Poplar



Please refer to our color selector for accurate color representation.



SHOW US YOUR STYLE AND CONNECT WITH US!

We love seeing how you apply our products to your home. Share photos with us.



CREATE YOUR DREAM HOME

WITH PROVIA'S EXTERIOR HOME DESIGN TOOLS

Find inspiration for the exterior of your home.
Download ProVia's free app for iPad or try the online Visualizer at provia.com/visualizer.



PROVIA VISUALIZER

Use ProVia's Visualizer to change the colors and styles of your home's doors, windows, siding, stone and roofing.

Let your imagination run free with this exterior home design tool. Select from a library of existing home styles, choosing one to match yours, or upload a photo of your own home.

In a few easy steps, update your siding color, add manufactured stone or a metal roof, give the windows a fresh look or personalize a new entry door.

Not sure where to start? Apply one of our pre-selected Designer Collections, then further customize the selections to reflect your own personal style.



PROVIA APP

Use the ProVia app to configure doors and windows or select from an extensive collection of vinyl siding and manufactured stone styles.

FEATURES

Door and Window Configurator

Vinyl Siding Profiles, Colors and Accessory Accents

Manufactured Stone Styles, Color Palettes and Grout Options

View Videos, Photo Galleries and Catalogs

Locate a ProVia Dealer





"To serve, by caring for details in ways others won't." It's not just our mission, but a way of letting our light shine every day at ProVia®. We continually strive to put these words into action by providing unmatched quality and service. The P-icon symbolizes each employee's commitment to devoting the utmost care, pride and quality into each building product we manufacture...it's The Professional Way.



At ProVia, we manufacture energy efficient products and exercise corporate environmental stewardship by recycling, reducing pollution emissions and much more. In fact, our company has received repeated awards from the Environmental Protection Agency such as Partner of the Year - Sustained Excellence for outstanding efforts in energy savings.

Distributed by:



DOORS | WINDOWS
SIDING | STONE | ROOFING

provia.com

© 2019 ProVia
P-MK-02700-19 | 9/19